



U.S. Department
of Transportation

Federal Aviation
Administration

Advisory Circular

Subject: HELIPORT DESIGN

Date: 09/30/04

AC No: 150/5390-2B

Initiated by: AAS-100

Change:

1. PURPOSE. This advisory circular (AC) provides recommendations for heliport design and describes acceptable requirements to develop a heliport. This AC applies to anyone who is proposing to construct, activate or deactivate a heliport.

2. APPLICABILITY. This AC is not mandatory and does not constitute a regulation except when Federal funds are specifically dedicated for heliport construction.

3. EFFECTIVE DATE. The effective date is September 30, 2004.

4. CANCELLATION. AC 150/5390-2A, *Heliport Design*, dated January 20, 1994, is canceled.

5. EXECUTIVE SUMMARY. The modern helicopter is one of the most versatile transportation vehicles known to man. Typically, a heliport is substantially smaller than an airport providing comparable services. The helicopter has the capability of providing a wide variety of important services to any community that integrates this aircraft into its local transportation system.

a. Service. In addition to their service in the transportation of people, helicopters have proven to be useful to their communities in the following ways:

(1). **Disaster Relief.** Natural disasters often result in the breakdown of ground transportation systems. Helicopters are able both to bring in response teams and supplies and to evacuate injured people during the critical period before ground transportation is restored.

(2). **Air Ambulance Services.** For an injured or critically ill person, time is life. Helicopters can provide high-speed, point-to-point transportation without being constrained by the limitations of the ground infrastructure.

(3). **Police Services.** Many municipalities consider their police services helicopters vital force multipliers in carrying out search and rescue, chase, and surveillance.

(4). **Moving High-Value Assets.** High-value or time-sensitive cargo, such as canceled checks, and people, including the President of the United States, frequently travel on helicopters because this mode of transportation is fast and flexible. Companies use helicopters as an invaluable part of an in-house transportation system to connect the office with various plants, job sites, and the local airport. Utility companies use helicopters to construct and inspect high-voltage electrical lines and to monitor underground gas transmission lines. The petroleum industry uses helicopters to support exploration and production operations. Newspapers and radio/TV stations use helicopters for onsite news gathering, taking photos, and airborne reporting of rush hour traffic conditions.

b. Facilities. The most effective way for a community to realize the benefits of helicopter services is by developing or permitting the development of places where helicopters can land and take off. While heliports can be large and elaborate, most are not. The basic elements of a heliport are clear approach/ departure paths, a clear area

for ground maneuvers, and a windsock. This minimal facility may be adequate as a private use heliport, and may even suffice as the initial phase in the development of a public use heliport capable of serving the general aviation segment of the helicopter community.

c. Planning. While the heliport itself may be simple, the planning and organization required to properly put one into place can be intimidating. To help make the process easier, the Federal Aviation Administration (FAA) has published this AC. This document describes physical, technical, and public interest matters that should be considered in the planning and establishment of a heliport. While this AC is a technical document intended to help engineers, architects, and city planners' design, locate, and build the most effective heliport, it can be used by anyone considering the construction of a heliport.

d. Location. The optimum location for a heliport is in close proximity to the desired origination and/or destination of the potential users. Industrial, commercial, and business operations in urban locations are demand generators for helicopter services, even though they often compete for the limited ground space available. A site permitting the shared aeronautical and commercial usage is a viable alternative to non-aeronautical use alone. Heliport sites may be adjacent to a river or a lake, a railroad, a freeway, or a highway, all of which offer the potential for multi-functional land usage. These locations also have the advantage of relatively unobstructed airspace, which can be further protected from unwanted encroachment by properly enacted zoning. As vertical flight transportation becomes more prevalent, requirements for scheduled "airline type" passenger services will necessitate the development of an instrument procedure to permit "all-weather" service.

e. AC Organization. This AC is structured to provide communities and persons intending to develop a heliport, or become involved in regulating helicopter facilities, with general guidance on heliport requirements. The AC is organized with separate chapters covering general aviation heliports, transport heliports, and hospital heliports based on the functional role of the heliport.

(1). A heliport proponent should be familiar with the terminology used in this specialized field. Chapter 1 defines pertinent terms used in the industry and identifies actions common to developing a heliport.

(2). General aviation heliports are normally privately owned although they can be publicly owned. Design standards relevant to developing a general aviation heliport are found in Chapter 2.

(3). Transport heliports are developed to provide the community with a full range of vertical flight services including scheduled service by air carriers (airlines) using helicopters. When the heliport serves any scheduled or unscheduled passenger operation of an air carrier that is conducted with an aircraft having a seating capacity of more than 30 passengers, the heliport is required to be certificated by the FAA in accordance with 14 Code of Federal Regulations (CFR) Part 139, Certification and Operations: Land Airports Serving Certain Air Carriers. In any event, a transport heliport would also accommodate corporate users and local air taxi operators. This broad spectrum of activities frequently requires a more extensive airside and landside infrastructure with the potential capability to operate in instrument meteorological conditions. Notwithstanding these requirements, a community's investment in a heliport may be substantially less than the investment required for an airport providing comparable services. Design standards relevant to developing a transport heliport are found in Chapter 3.

(4). Hospital heliports are treated as special cases of general aviation facilities providing a unique public service. They are normally located in close proximity to the hospital emergency room or a medical facility. Design recommendations relevant to developing a hospital heliport are found in Chapter 4.

(5). When there are a significant number of helicopter operations on an airport, it may be prudent to consider developing separate facilities specifically for helicopter use. Chapter 5 addresses helicopter facilities on airports.

(6). With the introduction of the global positioning system (GPS), it is now practical for heliports to have instrument approaches. Good planning suggests that heliport proponents should plan for the eventual development of instrument approaches to their heliports. Chapters 6 and 7 contain recommendations to be considered in contemplating future instrument operations at a heliport. It is wise to consider these issues during site selection and design.

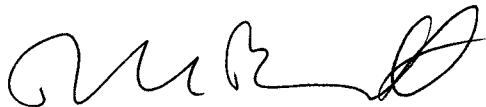
(7). Chapter 8 addresses heliport gradients and pavement design issues.

(8). The appendices provide helicopter dimensional data, addresses of aviation organizations, form and proportions of certain heliport markings, and acronyms.

6. APPLICATION. The recommendations and standards in this AC are for planning and designing civil heliports. To the extent that it is feasible and practical to do so, the standards in this AC should be used in planning and designing improvements to an existing facility when significant expansion or reconstruction is undertaken. Conformity with these standards is a prerequisite to Federal grant-in-aid assistance. Modification to a heliport design standard related to new construction, expansion, reconstruction, or upgrade on a heliport that received Federal aid requires FAA approval. The request for modification should show that the modification will provide an acceptable level of safety, economy, durability, and workmanship. The recommendations and standards in this AC are not intended to be sufficient to design an instrument approach procedure.

NOTE: *If tiltrotor operations are contemplated, criteria in AC 150/5390-3, Vertiport Design are applicable.*

7. METRIC UNITS. To promote an orderly transition to metric units, this AC includes both English and metric dimensions. The metric conversions may not be exact equivalents, and until there is an official changeover to the metric system, the English dimensions will govern.

A handwritten signature in black ink, appearing to read 'DLB', is positioned above the printed name and title of David L. Bennett.

DAVID L. BENNETT
Director of Airport Safety and Standards

Intentionally Left Blank

TABLE OF CONTENTS

Paragraph	Page
CHAPTER 1. INTRODUCTION	1
100. GENERAL	1
101. EXPLANATION OF TERMS	1
102. BASIS	3
103. SELECTION OF APPROACH/ DEPARTURE PATHS	3
104. PROPONENT RESPONSIBILITIES FOR FEDERAL AVIATION ADMINISTRATION (FAA) NOTIFICATION OF HELIPORT DEVELOPMENT OR CHANGES	4
105. ROOFTOP EMERGENCY FACILITIES	5
106. MEDICAL EMERGENCY SITES	5
107. HAZARDS TO AIR NAVIGATION	5
108. FAA STUDY OF EXISTING POTENTIAL HAZARDS TO AIR NAVIGATION	6
109. PROPONENT RESPONSIBILITIES TO NOTIFYING THE FAA OF PROPOSED CONSTRUCTION OF OBJECTS AFFECTING NAVIGABLE AIRSPACE	6
110. FEDERAL ASSISTANCE	7
111. ENVIRONMENTAL IMPACT ANALYSES	7
112. ACCESS TO HELIPORTS BY INDIVIDUALS WITH DISABILITIES	7
113. STATE ROLE	7
114. LOCAL ROLE	7
115. RELATED/REFERENCED READING MATERIAL	8
CHAPTER 2. GENERAL AVIATION HELIPORTS	15
200. GENERAL	15
201. TOUCHDOWN AND LIFT-OFF AREA (TLOF)	15
202. FINAL APPROACH AND TAKEOFF AREA (FATO)	17
203. SAFETY AREA	18
204. VFR APPROACH/ DEPARTURE PATHS	18
205. PROTECTION ZONE	19
206. WINDSOCK	19
207. TAXIWAYS AND TAXI ROUTES	20
208. HELICOPTER PARKING	21
209. HELIPORT MARKERS AND MARKINGS	23
210. HELIPORT LIGHTING	24
211. MARKING AND LIGHTING OF DIFFICULT-TO-SEE OBJECTS	26
212. SAFETY CONSIDERATIONS	27
213. VISUAL GLIDESLOPE INDICATORS	28
214. TERMINAL FACILITIES	28
215. ZONING AND COMPATIBLE LAND USE	28
CHAPTER 3. TRANSPORT HELIPORTS	59
300. GENERAL	59
301. TOUCHDOWN AND LIFT-OFF AREA (TLOF)	59
302. FINAL APPROACH AND TAKEOFF AREA	60
303. SAFETY AREA	61
304. VFR APPROACH/ DEPARTURE PATHS	61
305. PROTECTION ZONE	62
306. WINDSOCK	62
307. TAXIWAYS AND TAXI ROUTES	62
308. HELICOPTER PARKING	63
309. HELIPORT MARKERS AND MARKINGS	64
310. HELIPORT LIGHTING	66
311. MARKING AND LIGHTING OF OBSTRUCTIONS	67
312. SAFETY CONSIDERATIONS	68

313.	VISUAL GLIDESLOPE INDICATORS (VGI)	69
314.	TERMINAL FACILITIES	69
315.	ZONING AND COMPATIBLE LAND USE	69
CHAPTER 4. HOSPITAL HELIPORTS		95
400.	GENERAL	95
401.	TOUCHDOWN AND LIFT-OFF AREA (TLOF).....	95
402.	FINAL APPROACH AND TAKEOFF AREA (FATO).....	96
403.	SAFETY AREA	97
404.	VFR APPROACH/ DEPARTURE PATHS	97
405.	MAGNETIC RESONANCE IMAGERS (MRI)	98
406.	WINDSOCK	98
407.	TAXIWAYS AND TAXI ROUTES	99
408.	HELICOPTER PARKING.....	99
409.	HELIPORT MARKERS AND MARKINGS.....	99
410.	HELIPORT LIGHTING.....	101
411.	MARKING AND LIGHTING OF OBSTRUCTIONS	102
412.	SAFETY ENHANCEMENTS	102
413.	ZONING AND COMPATIBLE LAND USE	103
CHAPTER 5. HELICOPTER FACILITIES ON AIRPORTS		123
500.	GENERAL	123
501.	TOUCHDOWN AND LIFT-OFF AREA (TLOF).....	123
502.	FINAL APPROACH AND TAKEOFF AREA (FATO).....	123
503.	SAFETY AREA	123
504.	VFR APPROACH/ DEPARTURE PATHS	123
505.	PROTECTION ZONE	123
506.	WINDSOCK	123
507.	TAXIWAYS AND TAXI ROUTE	123
508.	HELICOPTER PARKING.....	124
509.	HELIPORT MARKERS AND MARKINGS.....	124
510.	HELIPORT LIGHTING.....	124
511.	MARKING AND LIGHTING OF OBSTRUCTIONS	124
512.	SAFETY ENHANCEMENTS	124
513.	VISUAL GLIDESLOPE INDICATORS	124
514.	PASSENGER SERVICES	125
CHAPTER 6. NONPRECISION INSTRUMENT OPERATIONS		127
600.	GENERAL	127
601.	IMPROVED LIGHTING SYSTEM	127
602.	OBSTACLE EVALUATION SURFACES	127
CHAPTER 7. PRECISION APPROACH OPERATIONS		133
700.	GENERAL	133
701.	FINAL APPROACH REFERENCE AREA (FARA)	133
702.	LIGHTING REQUIREMENTS	133
703.	OBSTACLE EVALUATION SURFACES	133
CHAPTER 8. HELIPORT GRADIENTS AND PAVEMENT DESIGN		137
800.	GENERAL	137
801.	TLOF GRADIENTS	137
802.	FATO GRADIENTS.....	137
803.	SAFETY AREA GRADIENTS	137
804.	PARKING AREA GRADIENTS.....	137
805.	TAXIWAY AND TAXI ROUTE GRADIENTS	137
806.	DESIGN LOADS	137

807. PAVEMENT DESIGN AND SOIL STABILIZATION138

APPENDIX 1. HELICOPTER DATA141

APPENDIX 2. AVIATION ORGANIZATIONS.....147

APPENDIX 3. DIMENSIONS FOR MARKING SIZE AND WEIGHT LIMITATIONS155

APPENDIX 4. ASSOCIATED PUBLICATIONS157

APPENDIX 5. ACRONYMS159

LIST OF FIGURES

Figure 1-1. Example of the Required Notice of Heliport Development or Change.....9

Figure 1-2. Example of a Heliport Layout Diagram.....10

Figure 1-3. Example of a Heliport Location Map.....11

Figure 1-4. Rooftop Emergency Landing Site.....12

Figure 1-5. Offsite Development Requiring Notice to the FAA.....13

Figure 2-1. Essential Features of a General Aviation Heliport: GENERAL AVIATION.....31

Figure 2-2. TLOF/FATO/Safety Area Relationships and Minimum Dimensions: GENERAL AVIATION.....32

Figure 2-3. An Elongated FATO with Two Takeoff Positions: GENERAL AVIATION.....33

Figure 2-4. Elevated Heliport: GENERAL AVIATION34

Figure 2-5. Additional FATO Length for Heliports at Higher Elevations: GENERAL AVIATION.....35

Figure 2-6. Non-load-bearing FATO and Safety Area: GENERAL AVIATION35

Figure 2-7. VFR Heliport Approach/ Departure and Transitional Surfaces: GENERAL AVIATION36

Figure 2-8. VFR PPR Heliport Lateral Extension of the 8:1 Approach/ Departure Surface: GENERAL AVIATION37

Figure 2-9. Protection Zone: GENERAL AVIATION.....38

Figure 2-10. Taxiway/Taxi Route Relationship - Paved Taxiway: GENERAL AVIATION.....39

Figure 2-11. Taxiway/Taxi Route Relationship - Unpaved Taxiway with Raised Edge Markers: GENERAL AVIATION.....40

Figure 2-12. Taxiway/Taxi Route Relationship - Unpaved Taxiway with Flush Edge Markers: GENERAL AVIATION.....41

Figure 2-13. Raised Taxiway Edge Marker: GENERAL AVIATION.....42

Figure 2-14. Parking Area Design - “Turn-around” Parking Positions: GENERAL AVIATION43

Figure 2-15. Parking Area Design - “Taxi-through” Parking Positions: GENERAL AVIATION44

Figure 2-16. Parking Area Design - “Back-out” Parking Positions: GENERAL AVIATION.....45

Figure 2-17. Parking Position Marking: GENERAL AVIATION46

Figure 2-18. Parking Position Identification, Size and Weight Limitations: GENERAL AVIATION47

Figure 2-19. Paved TLOF/Paved FATO - Marking: GENERAL AVIATION.....48

Figure 2-20. Paved TLOF/Unpaved FATO - Marking: GENERAL AVIATION49

Figure 2-21. Unpaved TLOF/Unpaved FATO - Markings: GENERAL AVIATION.....50

Figure 2-22. Standard Heliport Identification Symbol, TLOF Size and Weight Limitations:.....51

Figure 2-23. Marking a Closed Heliport: GENERAL AVIATION.....52

Figure 2-24. Elevated TLOF - Perimeter Lighting: GENERAL AVIATION52

Figure 2-25. FATO/TLOF Flush Perimeter Lighting: GENERAL AVIATION.....53

Figure 2-26. TLOF Flush and FATO Raised Perimeter Lighting: GENERAL AVIATION.....54

Figure 2-27. Landing Direction Lights: GENERAL AVIATION55

Figure 2-28. Airspace Where Marking and Lighting are Recommended: GENERAL AVIATION.....56

Figure 2-29. Caution Sign: GENERAL AVIATION.....57

Figure 2-30. Visual Glideslope Indicator Siting and Clearance Criteria: GENERAL AVIATION58

Figure 3-1. A Typical Transport Heliport: TRANSPORT71

Figure 3-2. TLOF/FATO/Safety Area Relationships and Minimum Dimensions: TRANSPORT.....72

Figure 3-3. An Elongated FATO/TLOF with Two Takeoff Positions: TRANSPORT73

Figure 3-4. Additional FATO Length for Heliports at Higher Elevations: TRANSPORT.....	74
Figure 3-5. Non-load-bearing Safety Area: TRANSPORT.....	74
Figure 3-6. VFR Heliport Approach/ Departure and Transitional Surfaces: TRANSPORT.....	75
Figure 3-7. Protection Zone: TRANSPORT.....	76
Figure 3-8. Taxiway/Taxi Route Relationship, Centerline and Edge Marking: TRANSPORT.....	77
Figure 3-9. Parking Area Design-“Turn-around” Parking Positions: TRANSPORT.....	78
Figure 3-10. Parking Position Marking: TRANSPORT.....	79
Figure 3-11. Parking Area Design-“Taxi-through” Parking Positions: TRANSPORT.....	80
Figure 3-12. Parking Position Identification, Size and Weight Limitations: TRANSPORT.....	81
Figure 3-13. Paved TLOF/Unpaved FATO – Markings: TRANSPORT.....	82
Figure 3-14. Paved TLOF/Paved FATO – Markings: TRANSPORT.....	83
Figure 3-15. Standard Heliport Identification Symbol, TLOF Size, and Weight Limitations: TRANSPORT.....	84
Figure 3-16. Marking a Closed Heliport: TRANSPORT.....	85
Figure 3-17. Optional TLOF Lights: TRANSPORT.....	86
Figure 3-18. FATO and TLOF Flush Perimeter Lighting: TRANSPORT.....	87
Figure 3-19. FATO Raised and TLOF Flush Perimeter Lighting: TRANSPORT.....	88
Figure 3-20. Elevated FATO – Perimeter Lighting: TRANSPORT.....	89
Figure 3-21. Landing Direction Lights: TRANSPORT.....	90
Figure 3-22. Airspace Where Marking and Lighting Are Recommended: TRANSPORT.....	91
Figure 3-23. Caution Sign: TRANSPORT.....	92
Figure 3-24. Visual Glideslope Indicator (VGI) Siting and Clearance Criteria: TRANSPORT.....	93
Figure 4-1 Essential Elements of a Ground-level Hospital Heliport: HOSPITAL.....	105
Figure 4-2. TLOF/FATO/Safety Area Relationships and Minimum Dimensions: HOSPITAL.....	106
Figure 4-3. An Elongated FATO/TLOF with Two Takeoff Positions: HOSPITAL.....	107
Figure 4-4. Elevated TLOF, Safety Net and Lighting: HOSPITAL.....	108
Figure 4-5. A Rooftop Hospital Heliport: HOSPITAL.....	109
Figure 4-6. VFR Heliport Approach/ Departure and Transitional Surfaces: HOSPITAL.....	110
Figure 4-7. VFR Heliport Lateral Extension of the 1:8 Approach/ Departure Surface: HOSPITAL.....	111
Figure 4-8. Paved TLOF/Unpaved FATO – Markings: HOSPITAL.....	112
Figure 4-9. Paved TLOF/Paved FATO – Markings: HOSPITAL.....	113
Figure 4-10a. Standard Hospital Heliport Identification Symbols: HOSPITAL.....	114
Figure 4-10b. Alternative Hospital Heliport Identification Symbols: HOSPITAL.....	115
Figure 4-11. Marking a Closed Heliport: HOSPITAL.....	116
Figure 4-12. TLOF Size and Weight Limitations: HOSPITAL.....	117
Figure 4-13. Flush FATO and TLOF Perimeter Lighting: HOSPITAL.....	118
Figure 4-14. Flush TLOF and Raised FATO Perimeter Lighting: HOSPITAL.....	119
Figure 4-15. Landing Direction Lights: HOSPITAL.....	120
Figure 4-16. Airspace Where Marking and Lighting Are Recommended: HOSPITAL.....	121
Figure 4-17. Caution Sign: HOSPITAL.....	122
Figure 5-1. A Heliport Located on an Airport: ON AIRPORT.....	126
Figure 6-1. Heliport Instrument Lighting System (HILS): NONPRECISION.....	129
Figure 6-2. Non-precision Approach/ Departure Surfaces – Final Approach Segment: NONPRECISION.....	130
Figure 6-3. Non-precision Approach/ Departure Surfaces – Visual Segment: NONPRECISION.....	131
Figure 7-1. FARA/FATO Relationship: PRECISION.....	135
Figure 7-2. HALS Lighting System: PRECISION.....	135
Figure 7-3. Precision Approach/ Departure Surfaces: PRECISION.....	136
Figure 8-1. Heliport Grades and Rapid Runoff Shoulder: GRADIENTS AND PAVEMENT.....	139
Figure 8-2. Helicopter Landing Gear Loading: GRADIENTS AND PAVEMENT.....	140
Figure A1- 1. Helicopter Dimensions.....	142
Figure A3- 1. Form and Proportions of 3 foot (0.9 m) Numbers for Marking Size and Weight Limitations.....	155
Figure A3- 2. Form and Proportions of 5 foot (1.5 m) Numbers for Marking Size and Weight Limitations.....	156

LIST OF TABLES

Table 2-1. Minimum VFR Safety Area Width as a Function of General Aviation and PPR Heliport Markings29
Table 2-2. Taxiway / Taxi Route Dimensions – General Aviation Heliports30
Table 3-1. Taxiway and Taxi Route Dimensions – Transport Heliports70
Table 4-1. Minimum VFR Safety Area Width as a Function Hospital Heliport Markings104
Table 5-1. Recommended Distance Between FATO Center to Runway Centerline for VFR Operations.....126
Table A1-1. Legend for Figure A1-1 and Table A1-2.....141

Intentionally Left Blank

CHAPTER 1. INTRODUCTION

100.GENERAL. This chapter provides an explanation of terms used in this AC, describes the notification responsibilities of heliport proponents to FAA, state and local officials, provides general siting guidance, and identifies sources of technical information relating to heliport planning and design of a civil heliport.

101.EXPLANATION OF TERMS. The Pilot/Controller Glossary of the Aeronautical Information Manual (AIM) defines terms used in the Air Traffic System. Copies of the AIM are available from the FAA web site:

<http://faa.gov/atpubs/AIM/index.htm>

and the Superintendent of Documents, U.S. Government Printing Office, Washington, DC 20402. Other terms used in this publication follow:

a. Approach/ Departure Path. The flight track helicopters follow when landing at or departing from a heliport.

b. Design Helicopter. A generic helicopter that reflects the maximum weight, maximum contact load/minimum contact area, overall length, rotor diameter, etc. of all helicopters expected to operate at the heliport.

c. Elevated Heliport. A heliport located on a rooftop or some other elevated structure where the touchdown and liftoff area (TLOF) is at least 30 inches (76 cm) above ground level.

d. Emergency Evacuation Facility. A clear area on a roof of a tall building, that is not intended to function as a heliport, yet is capable of accommodating helicopters engaged in fire fighting and/or emergency evacuation operations.

e. Final Approach and Takeoff Area (FATO). A defined area over which the final phase of the approach to a hover, or a landing is completed and from which the takeoff is initiated.

f. Final Approach Reference Area (FARA). An obstacle-free area with its center aligned on the final approach course. It is located at the end of a precision instrument FATO.

g. General Aviation (GA) Heliport. A GA heliport intended to accommodate individuals,

corporations, and helicopter air taxi operators. Scheduled passenger services may be available.

h. Ground Taxi. The surface movement of a wheeled helicopter under its own power with wheels touching the ground.

i. Hazard to Air Navigation. Any object having a substantial adverse effect upon the safe and efficient use of the navigable airspace by aircraft, upon the operation of air navigation facilities, or upon existing or planned airport/heliport capacity.

NOTE: *Obstructions to air navigation are presumed to be hazards to air navigation until an FAA study determines otherwise.*

j. Heliport. The aiming point for the final approach course. It is normally the center point of the touchdown and lift-off area (TLOF).

k. Heliport. The area of land, water or a structure used or intended to be used for the landing and takeoff of helicopters, together with appurtenant buildings and facilities.

l. Heliport Elevation. At a heliport with a precision approach, the heliport elevation is the highest point of the FARA expressed as the distance above mean sea level. At a heliport without a precision approach, the heliport elevation is the highest point of the FATO expressed as the distance above mean sea level.

m. Heliport Imaginary Surfaces. The imaginary planes, centered about the FATO and the approach/ departure paths, which identify the objects to be evaluated to determine whether the objects should be removed, lowered, and/or marked and lighted – or the approach/ departure paths realigned.

n. Heliport Layout Plan (HLP). The plan of a heliport showing the layout of existing and proposed heliport facilities.

o. Heliport Reference Point (HRP). The geographic position of the heliport expressed as the latitude and longitude at:

(1) The center of the FATO, or the centroid of multiple FATOs, for heliports having visual and non-precision instrument approach procedures; or

(2) The center of the FARA when the heliport has a precision instrument procedure.

p. Helistop. A minimally developed helicopter facility for boarding and discharging passengers or cargo. The heliport/ helistop relationship is comparable to a bus terminal–bus stop relationship with respect to the extent of services provided or expected.

NOTE: *The heliport design recommendations and standards in this AC are equally applicable to helistops.*

q. Hospital Heliport. A heliport limited to serving helicopters engaged in air ambulance, or other hospital related functions.

NOTE: *A designated helicopter landing area located at a hospital or medical facility is a heliport and not a medical emergency site.*

r. Hover Taxi. The movement of a wheeled or skid-equipped helicopter above the surface. Generally, this takes place at a wheel/skid height of 1 to 5 feet (0.3 to 1.5 m) and at a ground speed of less than 20 knots (37 km/h). For facility design purposes, a skid-equipped helicopter is assumed to hover-taxi.

s. Landing Position. A load-bearing, generally paved area, normally located in the center of an extended TLOF, on which the helicopter lands.

t. Medical Emergency Site. An unprepared site at or near the scene of an accident or similar medical emergency on which a helicopter may land to pick up a patient in order to provide emergency medical transport.

u. Missed Approach Point. A fly-over waypoint that marks the end of the final approach segment and the beginning of the missed approach segment of an instrument approach.

v. Obstruction to Air Navigation. Any fixed or mobile object, including a parked helicopter, of greater height than any of the heights or surfaces presented in Subpart C of the Code of Federal Regulations (14 CFR), Part 77 (see also paragraphs 108 and 211 below).

w. Overall Length (OL). The distance from the tip of the main or forward rotor to the tip of the tail rotor or fin. This measurement is made with the rotors at their maximum extension.

x. Parking Pad. The paved center portion of a parking position.

y. Prior Permission Required (PPR) Heliport. A heliport developed for exclusive use of the owner and persons authorized by the owner.

NOTE: *The heliport owner and operator should ensure that all pilots are thoroughly knowledgeable with the heliport (including such features as approach/ departure path characteristics, preferred heading, facility limitations, lighting, obstacles in the area, size of the facility, etc.).*

z. Protection Zone. An area off the end of the FATO and under the approach/ departure path intended to enhance the protection of people and property on the ground.

aa. Public Use Heliport. A heliport available for use by the general public without a requirement for prior approval of the owner or operator.

bb. Rotor Downwash. The volume of air moved downward by the action of the rotating main rotor blades. When this air strikes the ground or some other surface, it causes a turbulent outflow of air from beneath the helicopter.

cc. Safety Area. A defined area on a heliport surrounding the FATO intended to reduce the risk of damage to helicopters accidentally diverging from the FATO. This area should be free of objects, other than those frangible mounted objects required for air navigation purposes.

dd. Shielded Obstruction. A proposed or existing obstruction that does NOT need to be marked or lighted due to its close proximity to another obstruction whose highest point is at the same or higher elevation.

ee. Shoulder Line. A marking line perpendicular to a helicopter parking position centerline that is intended to provide the pilot with a visual cue to assist in parking.

ff. Takeoff Position. A load bearing, generally paved area, normally located on the centerline and at the ends of an extended Touchdown and Liftoff Area (TLOF), from which the helicopter takes off. Typically, there are two such positions on an extended TLOF, one at each end.

gg. Taxi Route. A taxi route is a defined and obstruction-free corridor established for the

movement of helicopters from one part of a heliport/airport to another. A taxi route includes the taxiway plus the appropriate clearances on both sides.

hh. Taxiways. A taxiway is the central portion of a taxi route. This AC defines two types of helicopter taxiways:

(1) Ground Taxiway. A ground taxiway is an obstruction-free corridor intended to permit the surface movement of a wheeled helicopter under its own power with wheels on the ground.

NOTE: *The minimum dimensions defined for a ground taxiway may NOT be adequate for use by skid-equipped helicopters or for hover taxi use by wheeled helicopters.*

(2) Hover Taxiway. A hover taxiway is an obstruction-free corridor intended to permit the hover taxiing of a helicopter. [In Annex 14 - Aerodromes, to the Convention on International Civil Aviation (ICAO) uses the term Air Taxiway to describe a very similar heliport component.]

ii. Touchdown and Lift-off Area (TLOF). A load bearing, generally paved area, normally centered in the FATO, on which the helicopter lands or takes off.

jj. Transport Heliport. A heliport intended to accommodate air carrier operators providing scheduled or unscheduled service with large helicopters.

kk. Unshielded Obstruction. A proposed or existing obstruction that may need to be marked or lighted since it is NOT in close proximity to another marked and lighted obstruction whose highest point is at the same or higher elevation.

ll. Visual Segment Reference Line. A line measured perpendicular to the final course at a distance of 75 feet (22.9 m) from the heliport. It extends 75 feet (22.9 m) on each side of the final course centerline.

102.BASIS. This AC implements the objectives set forth in Section 40101 of Title 49 United States Code (USC). The statute states, in part: Safety Considerations in Public Interest... the Administrator shall consider the following matters, among others, as being in the public interest:

a. assigning, maintaining, and enhancing safety and security as the highest priorities in air commerce.

b. regulating air commerce in a way that best promotes safety and fulfills national defense requirements.

c. encouraging and developing civil aeronautics, including new aviation technology.

d. controlling the use of the navigable airspace and regulating civil and military operations in that airspace in the interest of the safety and efficiency of both of those operations.

e. consolidating research and development for air navigation facilities and the installation and operation of those facilities.

f. developing and operating a common system of air traffic control and navigation for military and civil aircraft.

g. providing assistance to law enforcement agencies in the enforcement of laws related to regulation of controlled substances, the extent consistent with aviation safety.

103.SELECTION OF APPROACH/ DEPARTURE PATHS. Heliports should be designed so pilots can choose the safest approach/ departure path.

a. Consideration of wind. Approach/ departure paths should permit pilots to avoid downwind conditions and minimize crosswind operations. The preferred flight approach/ departure path should, to the extent feasible, be aligned with the predominate wind direction. Other approach/ departure paths should be based on the assessment of the prevailing winds or when this information is not available the separation between such flight paths and the preferred flight path should be at least 135 degrees.

b. Consideration of Obstructions. In determining approach/ departure paths it will also be necessary to take into account the obstructions in the vicinity of the heliport and in particular those likely to be a hazard to air navigation (see Paragraph 107).

c. Environmental Considerations. In environmentally sensitive areas, the final selection of the approach/ departure path(s) should minimize any environmental impact, providing it does not decrease flight safety. (See also Paragraph 111.)

104. PROPONENT RESPONSIBILITIES FOR FEDERAL AVIATION ADMINISTRATION (FAA) NOTIFICATION OF HELIPORT DEVELOPMENT OR CHANGES.

14 CFR Part 157; *Notice of Construction, Activation, and Deactivation of Airports*; requires persons proposing to construct, activate, or deactivate a heliport to give advance notice of their intent to the FAA. Notice is also required prior to changing the size or number of Final Approach and Takeoff Areas (FATOs); adding, deleting, or changing an approach or departure route; or changing heliport status. An example of a heliport status change would be a change from private to public use or vice versa.

a. Proponent Notice Responsibilities.

Part 157 requires heliport and airport proponents to notify the appropriate FAA Airport District/Field Office or Regional Office at least 90 days before construction, alteration, deactivation, or the date of the proposed change in use. In an emergency involving essential public service, health, or safety, or when delay would result in a unreasonable hardship, a proponent may notify the appropriate FAA Airport District/Field Office or Regional Office by telephone or other expeditious means and submit Form 7480-1, *Notice of Landing Area Proposal*, within 5 days. Appendix 2 lists of the FAA Regional Offices.

b. FAA Notification. Heliport proponents should complete FAA Form 7480-1 (Figure 1-1), a heliport layout diagram (Figure 1-2), and a heliport location map (Figure 1-3). FAA Form 7480-1 is from the FAA web site <http://faa.gov/arp/>. The FAA web site <http://faa.gov/arp/> lists office addresses for FAA Airport District/Field Office or Regional Offices.

(1) The heliport layout diagram should be drawn to scale showing key dimensions, such as the Touchdown and Liftoff Area (TLOF) size, FATO size, Safety Area size, distance from Safety Area perimeter to property edges, and approach/ departure paths in relation to buildings, trees, fences, power lines, and other significant features.

(2) The preferred type of location is the 7.5-minute U.S. Geological Survey Quadrangle Map. The map should show the location of the heliport site and the approach/ departure paths. On this map, an arrow should point out the heliport site.

NOTE: *The latitude and longitude of the proposed heliport should be stated in North American Datum of 1983 (NAD-83) coordinates. Surveying tolerances should be in accordance with FAA Standard 405, Standards for Aeronautical Surveys and Related*

Products. The National Geodetic Survey web site is <http://www.ngs.noaa.gov>.

c. The FAA Role. The FAA has diverse roles in the planning, design, and development of a heliport. These include: planning recommendations, publishing design criteria, reviewing aeronautical studies and environmental assessments, and financial assistance to eligible sponsors of public use facilities.

The FAA evaluates the proposed heliport for any:

(1) impact upon the safe and efficient use of navigable airspace,

(2) impact upon the operation of air navigation facilities,

(3) impact on existing or potential heliport capacity, and

(4) impact on the safety of persons and property on the ground.

The FAA notifies proponents of the results of the FAA evaluation.

d. Penalty for Failure to Provide Notice.

Persons who fail to give notice are subject to civil penalty under 49 CFR 46301.

e. Notice Exemptions. Paragraph 157.1, Applicability, of Part 157 exempts sites meeting one of the conditions under (1), (2), and (3) below from the requirement to submit notice. However, these exemptions do not negate a notice or formal approval requirement prescribed by state law or local ordinance.

(1) A heliport subject to conditions of a Federal agreement that requires an approved current heliport layout plan to be on file with the FAA.

(2) A heliport at which flight operations will be conducted under visual flight rules (VFR) and that is used or intended to be used for a period of less than 30 consecutive days with no more than 10 operations per day.

(3) The intermittent use of a site that is not an established airport, that is used or intended to be used for less than 1 year, and at which flight operations will be conducted only under VFR. For the purpose of this part, "intermittent use of a site" means:

(a) the site is used or is intended to be used for no more than 3 days in any one week and

(b) no more than 10 operations will be conducted in any one day at that site."

NOTE: *For the purposes of applying the Part 157 exemption criteria cited in (2) and (3) above, a landing and associated takeoff is considered to be one operation.*

105.ROOFTOP EMERGENCY FACILITIES. To facilitate fire fighting or emergency evacuation operations, local building codes may require structures over a specified height to provide a clear area on the roof capable of accommodating a helicopter. Since the cleared area is not intended to function as a heliport, there is no requirement to submit an FAA Form 7480-1. As in the case of medical emergency sites, proponents of emergency evacuation facilities should advise the local Air Traffic Control Tower (ATCT) of the facility.

The landing surface should be developed to the local fire department requirements based on the size and weight of the helicopter(s) expected to engage in fire or rescue operations (see Figure 1-4). Refer to Chapter 4, Hospital Heliports to additional guidance for planning and constructing rooftop emergency facilities.

The following markings are recommended to identify the limits of the landing area and to alert the pilot to any weight limitation. Arrow(s) may be used to indicate the preferred direction of approach. Markings should be in a color (red or orange is suggested) that provides the greatest possible contrast to the roof coloration.

(1) **Perimeter Marking.** A solid 12-inch wide (30 cm) wide red or orange line should define the limits of the touchdown pad as illustrated in Figure 1-4. For safe operation, clearance is required between the helicopter's main and tail rotor blades and any object that could be struck by these blades. This clearance should be one third of the rotor diameter (RD) of the largest helicopter expected but not less than 20 feet (6.1 m).

(2) **Weight Limitation.** Any limitation on allowable weight should be placed in the center of the circle as viewed from the preferred direction of approach. Weight limitations should be stated in units of 1,000 pounds as illustrated in Figure 1-4. (A 9 indicates a weight-carrying capability of up to 9,000 pounds. Metric equivalents should NOT be used for this purpose. Appendix 3 shows the form and proportions for the layout of these numbers.) To assure early recognition of a weight limit, the

numeral(s) should be a minimum of 5 feet (1.52 m) high.

106.MEDICAL EMERGENCY SITES. Medical emergency sites are clear and level areas at or near the scene of an accident or incident that have been selected or designated by the local emergency response team as the place where the helicopter air ambulance is directed to land in order to transport an injured person to a hospital.

a. FAA Notification is Not Required. Because of their transitory nature, medical emergency sites are not heliports, and submission of FAA Form 7480-1 is not required. Proponents of predesignated emergency landing sites should coordinate their emergency plan with the local ATCT. This coordination is especially important if a site(s) may be used under conditions of low visibility and/or use of the site(s) would require Air Traffic Control (ATC) clearance.

b. Marking/Lighting. Depending upon the level of training of the local accident or emergency response teams and agreements with the local air ambulance operators, medical emergency landing sites may be identified with flags, markers, lights, flares, etc. Lights should be provided for night operations.

c. Landing Discretion. All landings at a medical emergency site are made at the pilot's discretion after assessing the urgency for air transport against the performance capability of the helicopter, the pilot's ability and experience, and the limitations and/or constraints of the site.

d. Pre-designation of Medical Emergency Sites. When there are regular accidents or incidents in a given area, medical emergency sites should be predesignated. This provides the opportunity to inspect potential sites in advance and to select sites that have adequate clear approach/ departure airspace and adequate clear ground space.

107.HAZARDS TO AIR NAVIGATION. 14 CFR Part 77, *Objects Affecting Navigable Airspace*, establishes standards for determining obstructions to navigable airspace and provides for aeronautical studies of such obstructions to determine their effect on the safe and efficient use of airspace. These standards serve to provide some protection from obstacle encroachment for a heliport available for public use or a planned or proposed heliport that will be available for public use. Public agencies are encouraged to enact zoning ordinances to prevent

man-made features from becoming hazards to navigation.

108.FAA STUDY OF EXISTING POTENTIAL HAZARDS TO AIR NAVIGATION. Existing objects that are obstructions to air navigation are presumed to be hazards until an FAA study determines otherwise.

a. FAA Study. Aeronautical studies of existing objects are conducted when deemed necessary by the FAA to determine the physical and electromagnetic effect on the use of navigable airspace and air navigational facilities. Aeronautical studies of existing objects may be initiated as a result of information received or a situation observed.

b. Mitigating Adverse Effects. The adverse effect of an object presumed or determined to be a hazard to air navigation may be mitigated by:

- (1) Removing the object.
- (2) Altering the object, e.g. reducing its height.
- (3) Marking and/or lighting the object, provided an FAA aeronautical study has determined that the object would not be a hazard to air navigation if it were marked and lighted. Guidance on marking and lighting objects is contained in AC 70/7460-1, *Obstruction Marking and Lighting*.

109.PROPONENT RESPONSIBILITIES TO NOTIFYING THE FAA OF PROPOSED CONSTRUCTION OF OBJECTS AFFECTING NAVIGABLE AIRSPACE. 14 CFR Part 77, *Objects Affecting Navigable Airspace*, requires persons proposing any construction or alteration described in Section 77.13 (a) to give 30-day notice to the FAA of their intent. Part 77 also specifies standards for determining obstructions to air navigation and provides for FAA aeronautical studies of obstructions to determine their effect on the safe and efficient use of airspace. AC 70/7460-2 *Proposed Construction or Alteration of Objects That May Affect Navigable Airspace*.

a. FAA Notice is Required. Notification of the proposal should be made on FAA Form 7460-1, *Notice of Proposed Construction or Alteration*, available from the Airports web site <http://faa.gov/arp/forms/>. The proposed construction or alteration of structures or objects in the vicinity of a heliport requiring notice to the FAA includes:

(1) Any construction or alteration of more than 200 feet (61 m) above ground level (AGL) at its site.

(2) Any construction or alteration of greater height than an imaginary surface located within 5,000 feet (1,524 m) of a public-use or military heliport and penetrate a 25:1 sloping surface extending outward and upward originating at the heliport as illustrated in Figure 1-5.

(3) When the FAA requests notice.

b. Penalty for Failure to Provide Notice. Persons, who knowingly and willingly, violate the notice requirements of Part 77 are subject to a civil penalty pursuant to 49 USC Section 46301(a).

c. FAA Aeronautical Study. Information on the FAA's role in conducting an aeronautical study of off-heliport construction is found in AC 70/7460-2, *Proposed Construction or Alteration of Objects that May Affect the Navigable Airspace*. At its discretion, the FAA also may choose to study a proposed structure that the FAA believes may pose a hazard to navigation. In most cases, wires and their supporting structures fall into this discretionary category of structures less than 200 feet (61 m) AGL.

d. FAA Determination. The FAA summarizes the findings of an aeronautical study in a determination of HAZARD or NO HAZARD that is issued to the proponent. An FAA determination discusses the aeronautical impact of the proposed construction or alteration on the use of navigable airspace. The FAA does not have authority to approve or disapprove the construction of a proposed structure that would be a possible hazard to air navigation, but the FAA's recommendations on the subject are not easily dismissed by proponents because of potential liability.

(1) An FAA marking-and-lighting recommendation may be incorporated into a determination of NO HAZARD and, if included, is considered to be a condition to that determination.

(2) The FAA also provides copies of determinations to state and local aviation agencies and airport authorities.

(3) When the study involves a proposal for which a Federal Communications Commission (FCC) construction permit is required, then the FAA provides the FCC with a copy of the determination.

e. Heliport Development Plans. Future heliport development plans and feasibility studies on file with the FAA may influence the determinations resulting from 14 CFR Part 77 studies. To assure full consideration of future heliport development in Part 77 studies, heliport owners may wish to have their plans on file with the FAA. Heliport plan data should include planned FATO(s) coordinates and elevation(s), approach/ departure paths including their azimuths, and type(s) of approach(es) for any new FATO or modification of existing FATO. Plans may be filed with the FAA Regional Airport Division. (See App. 2 for addresses.)

110.FEDERAL ASSISTANCE. The FAA administers a grant program that provides financial assistance to eligible sponsors to develop a public use heliport. Information on Federal aid program eligibility requirements is available in FAA Regional and Airport District Offices. Addresses of Regional offices are listed in Appendix 2.

111.ENVIRONMENTAL IMPACT ANALYSES. The National Environmental Policy Act of 1969 requires consideration of potential environmental impacts prior to agency decision making, including, for example, the decision to fund or approve a project, plan, license, permit, certification, rulemaking, or operations specifications, unless these actions are within an existing categorical exclusion and no extraordinary circumstances exist. Actions that may require an environmental assessment are normally associated with Federal grants or heliport layout plan approvals leading to the construction of a new heliport or significant expansion of an existing heliport.

a. Assessment Items. An environmental assessment should address noise, historic and cultural resources, wildlife, energy conservation, land usage, air quality, water quality, pollution prevention, light emissions and other visual impacts, electromagnetic fields, other public health and safety issues, the no action alternative and a reasonable range of feasible alternatives, including mitigation not integrated into the alternative initially. It should also describe the action taken to ensure public involvement and citizen participation in the planning process. An opportunity for a public hearing may be required for the Federally funded development of, or significant improvement to, an existing heliport.

b. Guidance. The most current version of FAA Order 5050.4, *Airport Environmental Handbook*, and FAA Order 1050.1, *Polices and Procedures for Considering Environmental Impacts*,

and other supplemental guidance from FAA Air Traffic and Flight Standards provide guidance on environmental impact analysis is available at <http://faa.gov/arp/>. State and local governments, including metropolitan planning organizations and local transit agencies, should be contacted directly as they may also require an environmental report. The procedures in AC 150/5020-1, *Noise Control and Compatibility Planning for Airports*, describe a means of assessing the noise impact. AC 150/5020-1 is available at the Airports web site <http://faa.gov/arp/>. Contact the FAA Office of Environment and Energy for current information related to assessing noise impact of heliports. Proponents of non-Federally assisted heliports are encouraged to work closely with local governmental authorities concerning environmental issues.

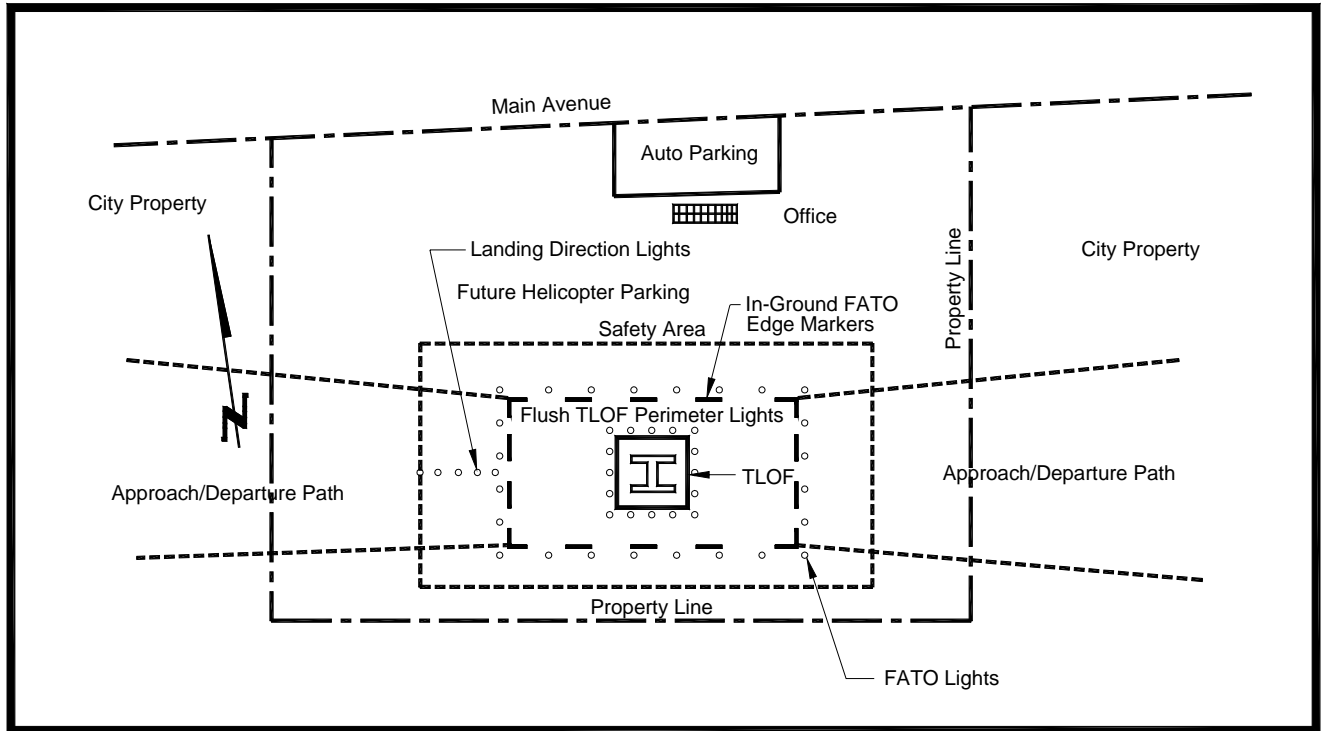
112.ACCESS TO HELIPORTS BY INDIVIDUALS WITH DISABILITIES. Congress has passed various laws concerning access to airports. Since heliports are a type of airport, these laws are similarly applicable. Guidance is contained in AC 150/5360-14, *Access to Airports by Individuals with Disabilities*, and is available at the Airports web site <http://faa.gov/arp/>. The AC applies to airports operated by public entities and those receiving Federal financial assistance. Paragraph 522 discusses the general applicability of transportation requirements to public entities, private entities, and employers providing transportation solely for their own employees.

113.STATE ROLE. Many state departments of transportation, aeronautical commissions, or similar authorities, require prior approval and, in some instances, a license for the establishment and operation of a heliport. Several states administer a financial assistance program similar to the Federal program and are staffed to provide technical advice. Heliport proponents are encouraged to contact their respective state aeronautics commissions or departments for particulars on licensing and assistance programs. Appendix 2 lists addresses for state aviation offices.

114.LOCAL ROLE. Some communities have enacted zoning laws, building codes, fire regulations, etc. that can impact heliport establishment and operation. Some have or are in the process of developing codes or ordinances regulating environmental issues such as noise and air pollution. A few localities have enacted specific rules governing the establishment of a heliport. Therefore, heliport proponents are encouraged to make early contact with officials or agencies representing the

local zoning board, the fire, police, or sheriff's department, and the elected person(s) who represent the area where the heliport is to be located.

115.RELATED/REFERENCED READING MATERIAL. The list of related/referenced publications is provided in Appendix 4.



Note: Layout diagrams should be drawn to scale with key dimensions shown such as TLOF size, FATO size, Safety Area size, distances from safety area perimeter to property edges, etc.

Figure 1-2. Example of a Heliport Layout Diagram

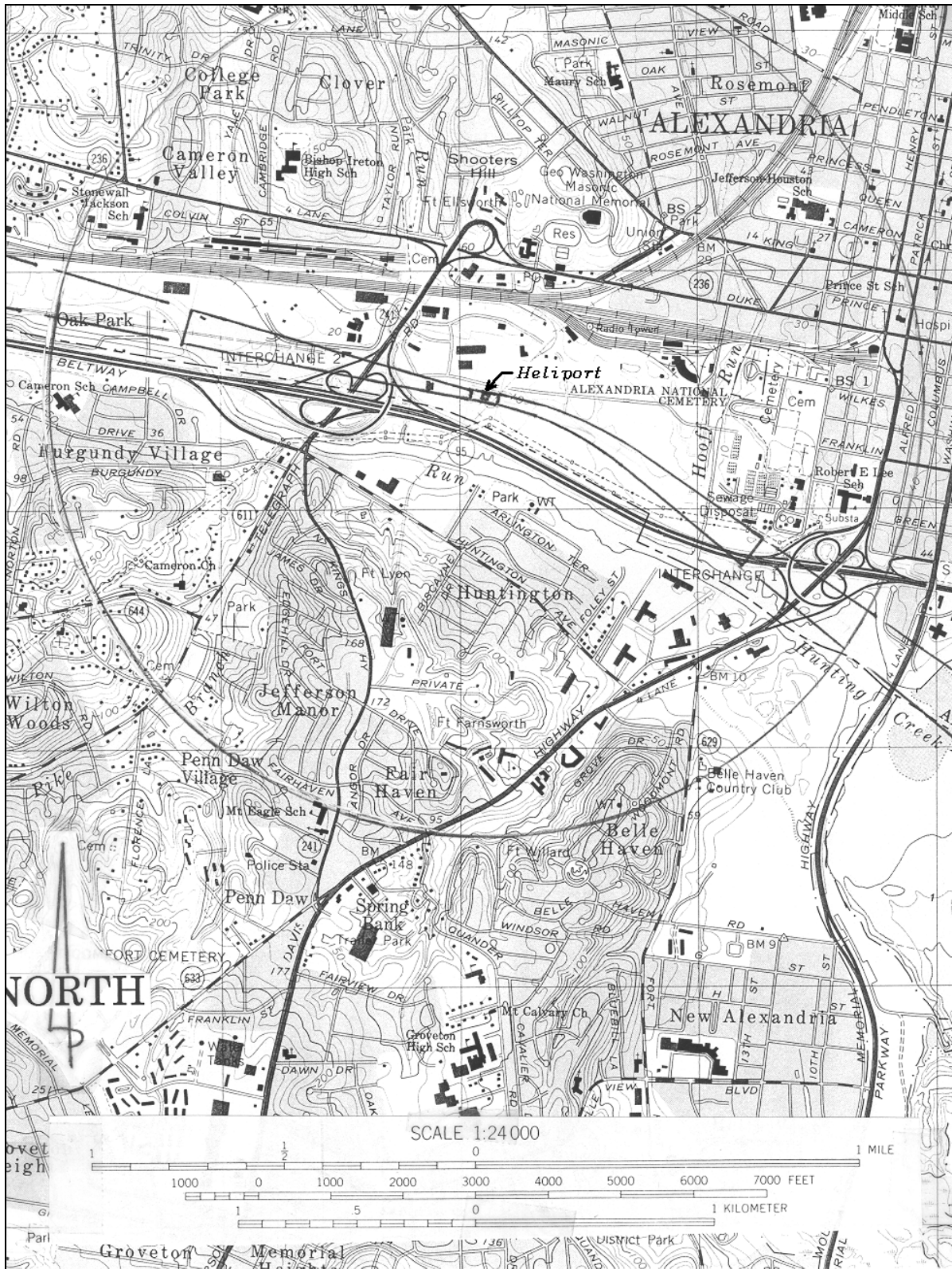


Figure 1-3. Example of a Heliport Location Map

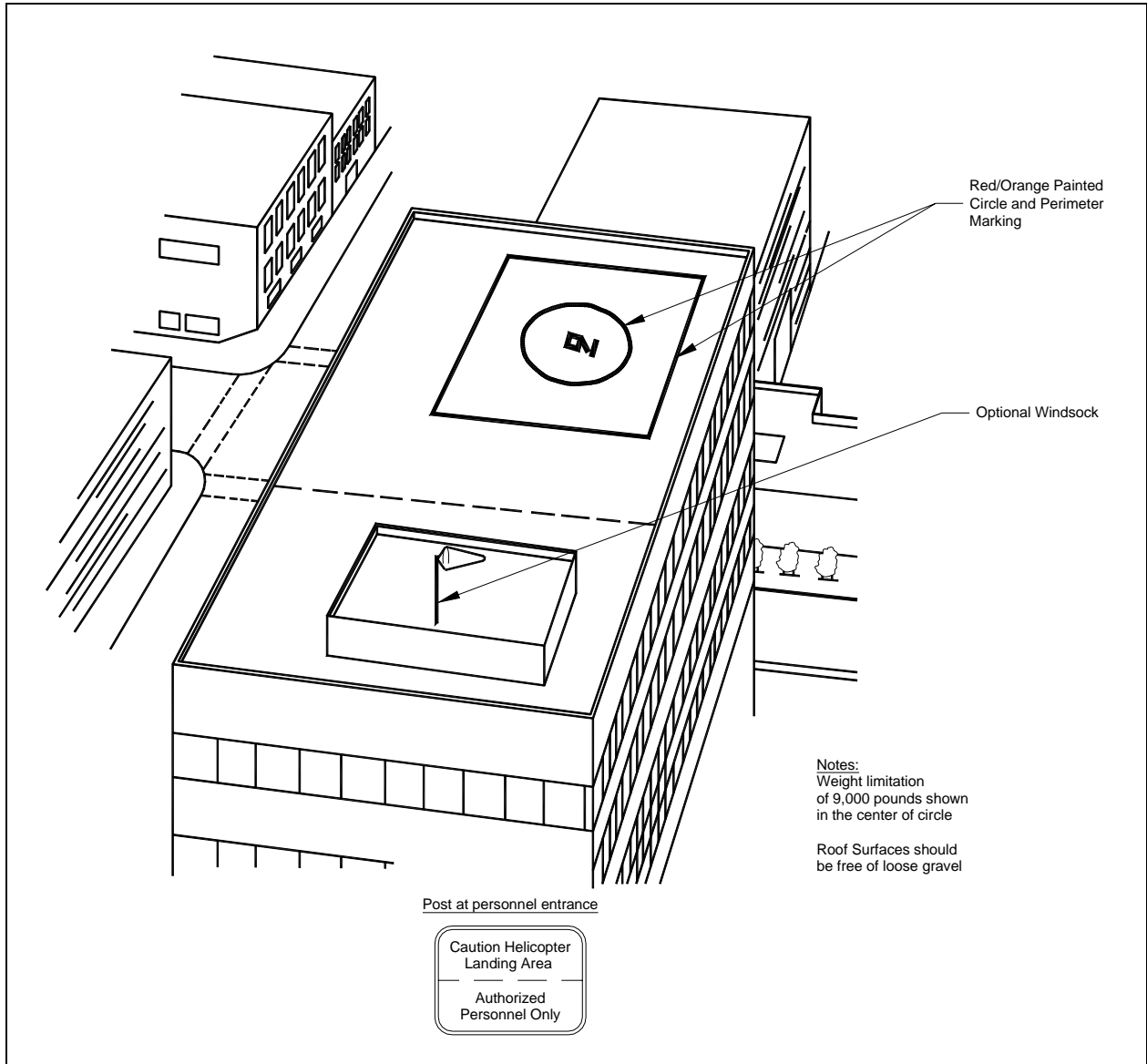
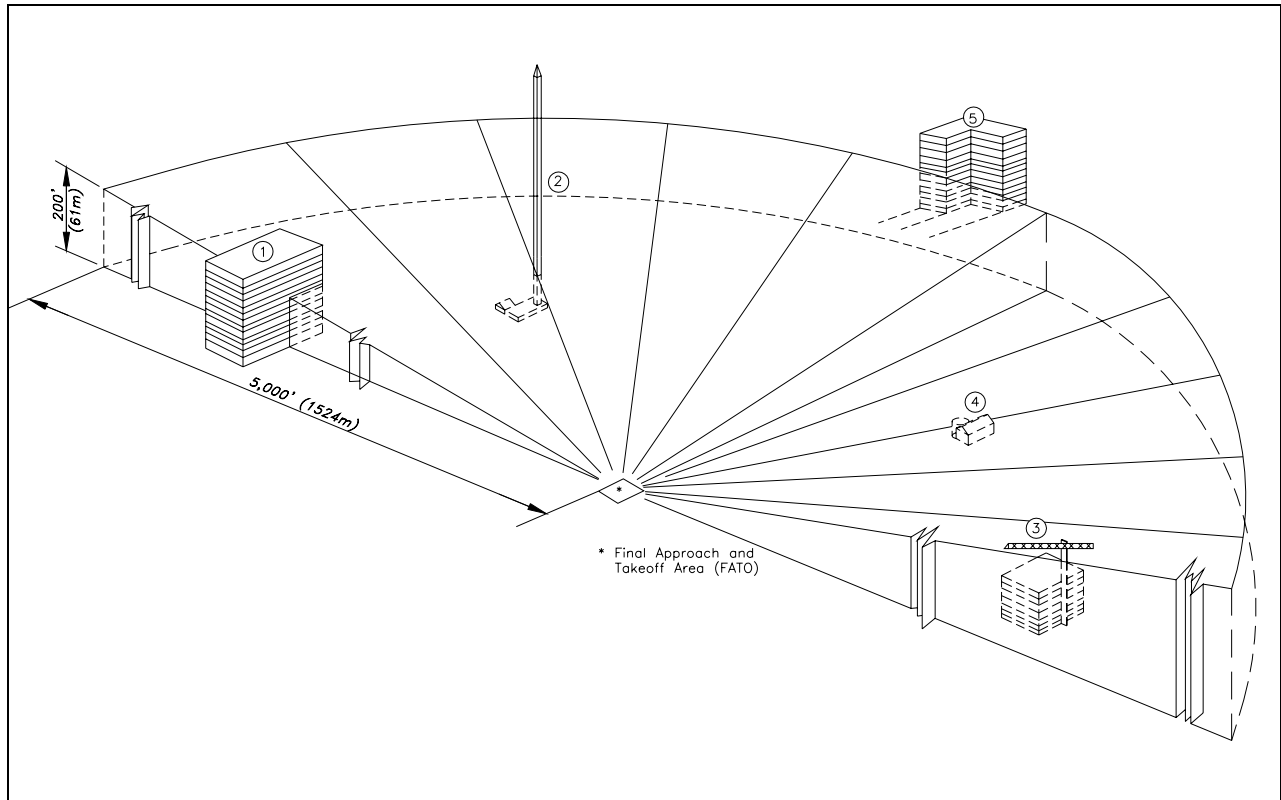


Figure 1-4. Rooftop Emergency Landing Site

**NOTES:**

1. Building is less than 200 feet (61m) in height, but top will penetrate the 25:1 surface. [Notice is required by 14 CFR PART 77 Subpart B 77.13 (a)(2)(iii).]
2. Antenna is over 200 feet (61m) in height. [Notice is required by 14 CFR PART 77.13(a)(1).] Antenna less than 200 feet (61m) in height, which penetrates the 25:1 surface. [Notice is required by 14 CFR PART 77.13(a)(2)(iii).]
3. Construction crane penetrates 25:1 surface. [Notice is required by 14 CFR PART 77.13 (a)(2)(iii).]
4. Building less than 200 feet (61m) in height and does not penetrate 25:1 surface. [Notice is not required.]
5. Building is more than 5,000 feet (1524 m) from heliport. [Notice is required if building will be 200 feet (61 m) or more in height.]

Figure 1-5. Offsite Development Requiring Notice to the FAA

Intentionally Left Blank

CHAPTER 2. GENERAL AVIATION HELIPORTS

200.GENERAL. A General Aviation (GA) heliport accommodates helicopters used by individuals, corporations, and helicopter air taxi services. This chapter contains standards and recommendations for designing such a facility. Figure 2-1 illustrates the essential features of a general aviation heliport.

The heliport consists of a touchdown and lift-off area (TLOF) surrounded by a final approach and takeoff area (FATO). A safety area is provided around the FATO. Table 2-1 shows how the minimum recommended Safety Area width varies as a function of heliport markings.

The relationship of the TLOF to the FATO and the Safety Area is shown in Figure 2-2. A FATO may NOT contain more than one TLOF.

Appropriate approach/ departure airspace to allow safe approaches to and departures from landing sites is required. See Paragraph 204. To the extent feasible, the preferred approach/ departure path should be aligned with the predominate winds.

NOTE: *The design recommendations given in this Chapter are based on the presumption that there will never be more than one helicopter within the FATO and the associated safety area. If there is a need for more than one TLOF at a heliport, each TLOF should be located within its own FATO and within its own Safety Area.*

a. Property Requirements. The property needed for a GA heliport depends upon the volume and types of users and the scope of amenities provided. Property requirements for helicopter operators and for passenger amenities frequently exceed that required for “airside” purposes.

b. Ownership. While GA heliports may be publicly owned, this is not required. Most GA heliports are privately owned.

c. Heliport Site Selection. Public agencies and others planning to develop a GA heliport are encouraged to select a site capable of supporting both instrument operations and future expansion.

d. Prior Permission Required (PPR) Facilities. In a number of places this chapter states that PPR heliports need not meet a particular GA

heliport design recommendation. The heliport owner or operator should ensure that all pilots using the facility are thoroughly knowledgeable of any such situations at the heliport and of the alternative means that are being used to ensure the safety and security of the facility.

NOTE: *To the extent that it is feasible and practical to do so, the standards and recommendations in this AC should be used in planning and designing improvements to an existing heliport when significant expansion or reconstruction is undertaken. Furthermore, existing PPR heliports may continue to follow the recommendations and standards applicable at the time of design.*

NOTE: *If tilt rotor operations are contemplated, criteria in AC 150/5390-3, Vertiport Design, are applicable.*

201.TOUCHDOWN AND LIFT-OFF AREA (TLOF).

a. TLOF Location. The TLOF of a GA heliport may be at ground level, on an elevated structure, or at rooftop level. The TLOF is normally centered within the final approach and takeoff area (FATO).

b. TLOF Size.

(1) Ground-level TLOF. For ground-level heliports, the minimum TLOF dimension (length, width, or diameter) should be 1.0 times the rotor diameter (RD) of the design helicopter. At PPR facilities, if only a portion of the TLOF is paved, the minimum length and width of this paved portion should be not less than two times the maximum dimension (length or width) of the undercarriage of the design helicopter. The center of this paved portion of the TLOF should be the center of the TLOF. To avoid the risk of catching a skid, and the potential for a dynamic rollover, there should be no difference in elevation between the paved and unpaved portions of the TLOF.

(2) Elevated General Aviation Heliport. For a rooftop or otherwise elevated heliport, the minimum TLOF dimension should be equivalent to 1.0 RD of the design helicopter. If the FATO outside the TLOF is non-load-bearing, the minimum width,

length or diameter should be increased to 1-times the overall length of the design helicopter. See paragraph 202c(1).

(3) Elevated PPR Heliports. At PPR rooftop or otherwise elevated facilities the TLOF can be a minimum of two times the maximum dimension (length or width) of the undercarriage of the design helicopter, if a solid surrounding area the size of the rotor diameter of the design helicopter is able to support 20 lbs/ft² live load (98 kg/m²), and the height of the TLOF surface above the surrounding area is no greater than 30 inches (76cm). The center of this load bearing portion of the TLOF should be the center of the FATO/TLOF. If there is a difference in elevation between the surrounding area and the TLOF, the perimeter of the TLOF should be marked in accordance with paragraph 209a.

(4) Elongated TLOF. An elongated TLOF can provide an increased safety margin and greater operational flexibility. An elongated TLOF may contain a landing position located in the center and two takeoff positions located at either end as illustrated in Figure 2-3. The landing position should have a minimum length equal to the rotor diameter of the design helicopter.

NOTE: *If an elongated TLOF is provided an elongated FATO will also be required. See Figure 2-3.*

c. Ground-level TLOF Surface Characteristics. The entire TLOF should be load bearing, either a paved surface or aggregate turf (see AC 150/5370-10. Item P-217). The TLOF and any supporting TLOF structure should be designed for the dynamic loads of the design helicopter described in paragraph 806b. Portland Cement Concrete (PCC) is recommended for ground-level facilities. An asphalt surface is “less desirable” for heliports as it may rut under the wheels or skids of a parked helicopter. This has been a factor in some rollover accidents. Pavements should have a broomed or other roughened finish that provides a skid-resistant surface for helicopters and non-slippery footing for people.

d. Rooftop and Other Elevated TLOFs. Elevated TLOFs and any TLOF supporting structure should be capable of supporting the dynamic loads of the design helicopter described in paragraph 806b. An elevated heliport is illustrated in Figure 2-4.

(1) Elevation. The TLOF should be elevated above the level of any obstacle in the FATO

and Safety Area that can not be removed. [Exception: This does not apply to frangibly mounted objects that, due to their function, must be located within the Safety Area (see paragraph 203d).]

(2) Obstructions. Elevator penthouses, cooling towers, exhaust vents, fresh-air vents, and other raised features can impact heliport operations. Helicopter exhaust can impact building air quality if the heliport is too close to fresh-air vents. These issues should be resolved during facility design. In addition, control mechanisms should be established to ensure that obstruction hazards are not installed after the heliport is operational.

(3) TLOF Surface Characteristics. Rooftop and other elevated heliport TLOFs should be constructed of metal or concrete (or other materials subject to local building codes). TLOF surfaces should have a broomed pavement or other roughened finish that provides a skid-resistant surface for helicopters and non-slippery footing for people.

(4) Safety Net. When the TLOF is on a platform elevated more than 30 inches (76 cm) above its surroundings, a safety net, not less than 5 feet (1.5 m) wide, should be provided. A railing or fence should not be used since it would be a safety hazard during helicopter operations. The safety net should have a load carrying capability of 25 lbs/ft² (122 kg/m²). The net, as illustrated in Figure 2-24, should not project above the level of the TLOF. Both the inside and outside edges of the safety net should be fastened to a solid structure.

NOTE: *Designers should consider state and local regulations when determining the width required for the safety net.*

(5) Access to Elevated TLOFs. The Occupational Safety and Health Administration (OSHA) requires two separate access points for an elevated structure such as an elevated TLOF. If stairs are used, they should be built in compliance with regulation 29 CFR 1910.24. When ramps are required, they should be built in compliance with Appendix A of 49 CFR Part 37, Section 4.8 and state and local requirements. The ramp surface should provide a slip-resistant surface. The slope of the ramp should be no steeper than 12:1 (12 units horizontal in 1 unit vertical). The width of the ramp should be not less than 4 feet (1.2 m) wide. Inside the FATO and safety area, any handrails should not extend above the elevation of the TLOF. Where a handrail complying with Appendix A of 49 CFR 37,

Section 4.8, is not provided, other means should be provide to protect personnel from fall hazards.

(6) Access by Individuals with Disabilities. Heliports operated by public entities and those receiving Federal financial assistance should provide reasonable accommodation for individuals with disabilities if they do not impose undue hardship (significant difficulty or expense) on the operation of the organization. Refer to paragraph 112 and AC 150/5360-14 for additional guidance.

e. TLOF Gradients. Recommended TLOF gradients are defined in Chapter 8.

202.FINAL APPROACH AND TAKEOFF AREA (FATO). A general aviation heliport should have at least one FATO. The FATO should contain a TLOF within its borders at which arriving helicopters terminate their approach and from which departing helicopters take off.

a. FATO Location. The FATO of a GA heliport may be at ground level, water level, on an elevated structure, or on a rooftop. The relationship of the FATO to the TLOF and the Safety Area is shown in Figure 2-2.

b. FATO Size.

(1) The minimum width, length or diameter of a FATO should be at least 1.5 times the overall length (OL) of the design helicopter. At elevations well above sea level a longer FATO can provide an increased safety margin and greater operational flexibility. The additional FATO length that should be used is depicted in Figure 2-5. For PPR facilities, the minimum length of the FATO need not be corrected for altitude.

(2) The minimum distance between the TLOF perimeter and the FATO perimeter should be not less than the distance $[0.5 \times (1.5 \text{ OL} - 1\text{RD})]$ where OL is the overall length and RD is the rotor diameter of the design helicopter. The relationship of the TLOF to the FATO and the Safety Area is shown in Figure 2-2.

c. FATO Surface Characteristics. If the TLOF is marked, the FATO outside the TLOF should be capable of supporting the static loads of the design helicopter (Paragraph 806 a). If the TLOF is not marked (see Paragraph 209a) and/or it is intended that the helicopter can land any where within the FATO, the FATO outside the TLOF and any FATO supporting structure should, like the TLOF, be

capable of supporting the dynamic loads of the design helicopter (Paragraph 806 b).

(1) Elevated Heliports. There are some helicopter performance benefits and increased operational flexibility if the FATO outside the TLOF is load bearing. The FATO outside of the TLOF need not be load bearing if the minimum width, length or diameter of TLOF is increased to 1.0 times the overall length (OL) of the design helicopter. The FATO outside the TLOF may extend into clear airspace.

(2) Ground Level PPR Heliports. For ground level PPR heliports, if the TLOF is marked, the FATO outside the TLOF need not be load bearing as defined in Paragraph 806 providing it is a solid area able to support a 20lbs/ft^2 (98 kg/m^2) live load. If the TLOF is not marked (see Paragraph 209a) and/or it is intended that the helicopter can land any where within the FATO, the FATO outside the TLOF should, like the TLOF, be capable of supporting the dynamic loads of the design helicopter (Paragraph 806 b).

(3) Elevated PPR Heliports. For elevated PPR heliports only the TLOF need to be load bearing. If the TLOF is marked, the FATO outside the TLOF, and the Safety Area, may extend into the clear airspace. (See Figures 2-4 and 2-6.). If the TLOF is not marked (see Paragraph 209a) and/or it is intended that the helicopter can land any where within the FATO, the FATO outside the TLOF should, like the TLOF, be capable of supporting the dynamic loads of the design helicopter (Paragraph 806 b).

(4) If the FATO is load bearing, the portion abutting the TLOF should be continuous with the TLOF and the adjoining edges should be at the same elevation. If it is unpaved, the FATO should be treated to prevent loose stones and any other flying debris caused by rotorwash.

(5) When the FATO is on a platform elevated more than 30 inches (76 cm) above its surroundings, a safety net, not less than 5 feet (1.5 m) wide, should be provided. A railing or fence should not be used since it would be a safety hazard during helicopter operations. The safety net should have a load carrying capability of 25 lbs/ft^2 (122 kg/m^2). The net, should not project above the level of the FATO. Both the inside and outside edges of the safety net should be fastened to a solid structure.

d. Mobile Objects Within the FATO and the Safety Area. The FATO and Safety Area design recommendations of this AC are based on the assumption that the TLOF/FATO is closed to other aircraft if a helicopter or other mobile object is within the FATO or the associated Safety Area.

e. FATO/FATO Separation. If a heliport has more than one FATO, the separation between the perimeters of the two FATO, should be such that the respective Safety Areas do not overlap. This separation is based on the assumption that simultaneous approach/ departure operations will not take place.

NOTE: *If simultaneous operations are planned, greater separation will be required.*

f. FATO Gradients. Recommended FATO gradients are defined in Chapter 8.

203. SAFETY AREA. A Safety Area surrounds a FATO and should be cleared of all obstacles except small frangible objects that, because of their function, must be located there.

a. Safety Area Width. The minimum recommended width of a Safety Area is dependent upon the heliport markings. The Safety Area width is dependent upon the use of the TLOF markings (paragraph 209a), the FATO markings (paragraph 209a), and the standard heliport identification marking (i.e., the H, paragraph 209b(1)). The recommended size of the Safety Area in Table 2-1 is increased if the TLOF perimeter is not marked. The minimum recommended width of the Safety Area is the same on all sides. The Safety Area may extend into clear airspace.

b. A Precision Approach Safety Area Width for operations under Instrument Flight Rules (IFR). RESERVED.

c. Mobile Objects within the Safety Area. See paragraph 202d.

d. Fixed Objects Within a Safety Area. No fixed object should be permitted within a Safety Area except for frangibly mounted objects that, due to their function, must be located there. Those objects whose functions require them to be located within the Safety Area should not exceed a height of 8 inches (20 cm) above the elevation of the FATO perimeter nor penetrate the approach/ departure surfaces or transitional surfaces.

e. Safety Area Surface. The Safety Area need not be load bearing. Figure 2-6 depicts a Safety Area extending over water. If the Safety Area is load bearing, the portion abutting the FATO should be continuous with the FATO and the adjoining edges should be at the same elevation. This is needed to avoid the risk of catching a helicopter skid or wheel. The Safety Area should be treated to prevent loose stones and any other flying debris caused by rotor wash.

f. Safety Area Gradients. Recommended Safety Area gradients are defined in Chapter 8.

204.VFR APPROACH/ DEPARTURE PATHS. The purpose of approach/ departure airspace, shown in Figure 2-7, is to provide sufficient airspace clear of hazards to allow safe approaches to and departures from the TLOF.

a. Number of Approach/ Departure Paths. Preferred approach/ departure paths should be aligned with the predominant wind direction so that downwind operations are avoided and crosswind operations are kept to a minimum. To accomplish this, a heliport should have more than one approach/ departure paths and the preferred flight approach/ departure path should, to the extent feasible, be aligned with the predominate wind. Other approach/ departure paths should be based on the assessment of the prevailing winds or when this information is not available, the separation between such flight paths and the preferred flight path should be at least 135 degrees. See Figure 2-7.

PPR facilities may have only one approach/ departure path although a second flight path provides additional safety margin and operational flexibility.

b. VFR Approach/ Departure Surfaces. An approach/ departure surface is centered on each approach/ departure path. Figure 2-7 illustrates the approach/ departure and transitional surfaces.

The approach / departure path starts at the edge of the FATO and slopes upward at 8:1 (8 units horizontal in 1 unit vertical) for a distance of 4000 ft (1219 m) where the width is 500 ft (152 m) at a height of 500 ft (152 m) above the elevation of TLOF surface.

The transitional surfaces start from the edges of the FATO parallel to the flight path center line, and from the outer edges of the 8:1 approach/ departure surface, and extend outwards at a slope of 2:1 (2 units horizontal in 1 unit vertical) for a distance of 250 ft (76 m) from the centerline. The transitional surfaces

start at the edge of the FATO opposite the 8:1 approach/ departure surfaces and extends to the end of the approach/ departure surface. See Figure 2-7.

NOTE: *The transitional surface is not applied on the FATO edge opposite the approach/ departure surface.*

The Approach/ departure Surfaces should be free of penetrations. Any penetration of the transitional surface should be considered a hazard unless an FAA aeronautical study determines that it will not have a substantial effect upon the safe and efficient use of this airspace. Paragraph 108 provides guidance on how to identify and mitigate such hazards.

For PPR facilities, transitional surfaces need not be considered if the size of the 8:1 approach/ departure surface is increased for a distance of 2000 ft. (610 m) as shown in Figure 2-8. The lateral extensions on each side of the 8:1 approach/ departure surface starts at the width of the FATO and is increased so that at a distance of 2000 ft (610 m) from the FATO it is 100 ft (30 m) wide. Penetrations of obstacles into area A or area B, but not both, may be allowed providing the penetrations are marked or lighted and not considered a hazard.

NOTE: *When the standard surface is incompatible with the airspace available at the heliport site, no operations should be conducted unless helicopter performance data supports a capability to safely operate using an alternate approach/ departure surface. The site should be limited to those helicopters meeting or exceeding the required performance and approved by the FAA.*

c. Marking and Lighting of Objects that Are Difficult to See. See paragraph 211.

d. Periodic Review of Obstructions. Heliport operators should reexamine obstacles in the vicinity of 8:1 approach/ departure paths on at least an annual basis. This reexamination should include an appraisal of the growth of trees in close proximity to approach and departure paths. Paragraph 108b provides guidance on how to identify and mitigate obstruction hazards.

e. Curved VFR Approach/ Departure Paths. VFR approach/ departure paths may curve to avoid objects or noise-sensitive areas. Heliport designers are encouraged to use the airspace above public lands, such as freeways or rivers.

NOTE: *In the next revision of this AC, the FAA intends to provide details on the minimum dimensions of curved approach/ departure airspace.*

205.PROTECTION ZONE. The protection zone is the area under the 8:1 approach/ departure surface starting at the FATO perimeter and extending out for a distance of 280 feet (85.3 m), as illustrated in Figure 2-9. The heliport proponent should own or control the property containing the protection zone. This control should include the ability to clear incompatible objects and to preclude the congregation of people. For PPR heliports, a protection zone is optional. For GA heliport, air easement rights may be one option to control use of the ground within the protection zone.

206.WINDSOCK.

a. Specification. A windsock conforming to AC 150/5345-27. Specification for Wind Cone Assemblies should be used to show the direction and magnitude of the wind. The windsock should provide the best possible color contrast to its background.

b. Windsock Location. The windsock should be located so it provides the pilot with valid wind direction and speed information in the vicinity of the heliport under all wind conditions.

(1) The windsock should be sited so it is clearly visible to the pilot on the approach path when the helicopter is at a distance of 500 feet (152 m) from the TLOF.

(2) Pilots should also be able to see a windsock from the TLOF.

(3) To avoid presenting an obstruction hazard, the windsock should be located outside the safety area, and it should not penetrate the approach/ departure or transitional surfaces.

(4) At many landing sites, there may be no single, ideal location for the windsock. At other sites, it may not be possible to site a windsock at the ideal location. Consequently, more than one windsock may be required in order to provide the pilot with all the wind information needed for safe operations.

c. Windsock Lighting. For night operations, the windsock should be internally lighted or externally illuminated to ensure that it is clearly visible.

207. TAXIWAYS AND TAXI ROUTES. Taxiways and taxi routes should be provided for the movement of helicopters from one part of a landing facility to another. They provide a connecting path between the FATO and a parking area. They also provide a maneuvering aisle within the parking area. A taxi route includes the taxiway plus the appropriate clearances needed on both sides. The relationship between a taxiway and a taxi route is illustrated in Figures 2-10, 2-11, and 2-12.

NOTE: *At PPR heliports with no parking or refueling area outside the TLOF(s), no taxi route or taxiway is required.*

a. Taxiway/Taxi Route Widths. The dimensions of taxiways and taxi routes are a function of helicopter size, taxiway/taxi route marking, and type of taxi operations (ground taxi versus hover taxi). These dimensions are defined in Table 2-2.

NOTE: *Normally, the requirement for hover taxi dictates the taxiway/taxi route widths. However, when the fleet comprises a combination of large ground taxiing helicopters and smaller air taxiing helicopters, the larger aircraft may dictate the taxiway/taxi route widths. If wheel-equipped helicopters taxi with wheels not touching the surface, the facility should be designed with hover taxiway widths rather than ground taxiway widths.*

b. Paved Taxiway Markings. The centerline of a taxiway should be marked with a continuous 6-inch (15 cm) yellow line. Both edges of the paved portion of the taxiway should be marked with two continuous 6-inch wide (15 cm) yellow lines spaced 6 inches (15 cm) apart. Figure 2-10 illustrates taxiway centerline and edge markings.

c. Unpaved Taxiway Markings. The centerline should be marked with in-ground flush markers. They should be longitudinally spaced at approximately 15-foot (5 m) intervals on straight segments and at approximately 10-foot (3 m) intervals on curved segments. Edge markers should also be used to provide strong visual cues to pilots. Edge markers may be either raised or in-ground flush markers. They should also be longitudinally spaced at approximately 15-foot (5 m) intervals on straight segments and at approximately 10-foot (3 m) intervals on curved segments. Figures 2-11 and 2-12 illustrate taxiway centerline and edge markings.

(1) In-ground, flush centerline markers should be yellow in color, 6 inches (15 cm) wide, and approximately 5 feet (1.5 m) long.

(2) Raised-edge markers should be yellow-blue-yellow in color, 4 inches (10 cm) in diameter, and 10 inches (25 cm) high, as illustrated in Figure 2-13.

(3) In-ground, flush edge markers should be yellow in color, 12 inches (30 cm) wide, and approximately 5 feet (1.5 m) long.

NOTE: *Where the visibility of the centerline marking can not be guaranteed at all times, such as locations where snow or dust commonly obscure the centerline marking and it is not practical to remove it, centerline marking is still recommended. However, under such circumstances, the minimum taxiway/taxi route dimensions should be determined as if there was no centerline marking (see Table 2-2).*

NOTE: *Elevated centerline markers are NOT recommended because they present an obstruction hazard.*

d. Raised Edge Markers in Grassy Areas. Raised edge markers are sometimes obscured by tall grass. The heliport operator should address this problem with a 12-inch diameter (30 cm) diameter concrete pad or a solid material disk around the pole supporting the raised marker, as illustrated in Figure 2-13.

e. Taxiway to Parking Position Transition Requirements. Taxiway centerline markings should continue into parking positions and become the parking position centerlines. However, if the parking position has centerline marking and the taxiway does not, the parking position centerline should be extended, in the direction of the taxiway, for a distance of at least one half of the rotor diameter of the largest helicopter for which the parking position is designed.

f. Surfaces. Ground taxiways should have a surface that is Portland Cement, asphalt or a surface, such as turf, stabilized in accordance with the recommendations of Item P-217 of AC 150/5370-10. Unpaved portions of taxiways and taxi routes should have a turf cover or be treated in some way to prevent dirt and debris from being raised by a taxiing helicopter's rotor wash.

g. Gradients. Recommended taxiway and taxi route gradients are defined in Chapter 8.

h. Lighting. See paragraph 210.

208. HELICOPTER PARKING. If more than one helicopter at a time is expected at a heliport, the facility should have an area designated for parking helicopters. The size of this area should depend on the number and size of helicopters to be accommodated. Parking positions should be designed to accommodate the full range of helicopter size and weights expected at the facility. Parking positions should support the static loads of the helicopter intended to use the parking area (Paragraph 806a). Parking areas may be designed as one large, paved apron or as individual, paved parking positions.

a. Location. Aircraft parking areas should not lie under an approach/ departure surface. However, aircraft parking areas may lie under the transitional surfaces.

(1) The parking position should be located to provide adequate clearance from any object or building. The clearance from the tail rotor arc for hover taxi operations should be 1/3 of the rotor diameter, but not less than 10 ft (3 m), and 10 ft (3 m) for ground taxi operations. See Figure 2-17.

(2) The nearest edge of a parking position should be located a minimum of 1/3 of the rotor diameter, from the edge of the taxi route for 'turn-around' and 'taxi-through' parking positions and a minimum of 1/2 rotor diameter from the edge of the taxi route for 'back-out' parking positions.

b. Size. Parking position sizes are dependent upon the helicopter size. The clearance between parking positions are dependent upon the type of taxi operations (ground taxi or hover taxi) and the intended paths for maneuvering in and out of the parking position.

(1) If all parking positions are the same size, they should be large enough to accommodate the largest helicopter that will park at the heliport.

(2) When there is more than one parking position, the facility may be designed with parking positions of various sizes with at least one position that will accommodate the largest helicopter that will park at the heliport. Other parking positions may be smaller, designed for the size of the individual or range of individual helicopters planned to be parked at that position.

(3) The parking position should be marked with rotor diameter of the largest helicopter that the parking position is designed to accommodate [see paragraph 208c(2)].

(4) "Turn-around" parking positions should be designed as illustrated in Figure 2-14 and 2-17. Figure 2-17 also provides guidance on issues other than the separation between parking positions.

(5) "Taxi-through" parking positions should be designed as illustrated in Figure 2-15. When this design is used for parking positions, the heliport owner and operator should take steps to ensure that all pilots are informed that "turn-around" or "back-up" departures from the parking position are not permitted.

(6) "Back-out" parking positions should be designed as illustrated in Figures 2-16 and 2-17. When this design is used for parking positions, the adjacent taxiway should be designed to accommodate hover taxi operations so that the width of the taxiway will be adequate to support "back-out" operations.

NOTE: *Heliport parking areas should be designed so that helicopters will be parked in an orientation that keeps the "avoid areas" around the tail rotors (see Figure 2-29) clear of passenger walkways.*

c. Helicopter Parking Position Marking. Helicopter parking positions should have the following markings:

(1) A 6-inch-wide (15 cm), solid yellow line defining a circle of 1 rotor diameter of the largest helicopter that will park at that position. In paved areas, this should be a painted line (see Figure 2-17). In unpaved areas, this line should be defined by a series of flush markers, 6 inches (15 cm) in width, a maximum of 5 feet (1.5 m) in length, and with end-to-end spacing of approximately 5 feet (1.5 m).

(2) Marking indicating the rotor diameter of the largest helicopter that the position is designed to accommodate (e.g., 49). This marking should be in yellow characters, clearly visible, and at least 3 feet (0.9 m) high. (See Figure 2-18 and Appendix Figure A3-1.)

(3) A 12-inch-wide (30 cm) solid yellow centerline marking. In paved areas, this should be a painted line (see Figure 2-17). In unpaved areas, this line should be a series of flush markers, each approximately 5 feet (1.5 m) in length with end-to-end spacing of not more than 6 inches (15 cm).

(4) A 12-inch-wide (30 cm) extended centerline that the pilot can see when positioned in the center of the parking position. For a “taxi-through” parking position, this should be a solid yellow line (see Figure 2-15). [In paved areas, this should be a painted line. In unpaved areas, this line should be defined by a series of flush markers, each approximately 5 feet (1.5 m) in length, 12 inches (30 cm) in width, with end-to-end spacing of not more than 6 inches (15 cm).]

If the parking position will NOT accommodate taxi-through operations, this extended centerline should be a dashed yellow line. (See Figure 2-14, 2-16 and 2-17.) The purpose of the extended centerline is to provide the pilot with better visual guidance during parking maneuvers.

(5) A 6-inch-wide (15 cm) solid yellow shoulder line, perpendicular to the centerline, should be located so it is under the pilot’s shoulder when the main rotor of the largest helicopter for which the position is designed will be entirely within the 1.0 rotor diameter parking circle (see Figure 2-18). This shoulder line should extend far enough from the parking position centerline so the pilot can see it on both sides of the helicopter. In paved areas, this should be a painted line. In unpaved areas, this line should be a series of flush markers.

(6) Parking position identifications (numbers or letters) should be marked if there is more than one parking position. These markings should be yellow characters that are clearly visible and 3 feet (0.9 m) high. (See Figures 2-18, and Appendix Figure A3-1)

(7) A passenger walkway, as illustrated in Figure 2-17, should be clearly marked.

(8) If a parking position has a weight limitation, it should be stated in units of 1,000 pounds as illustrated in Figure 2-18. (A 9 indicates a weight-carrying capability of up to 9,000 pounds. Metric equivalents should NOT be used for this purpose.) This marking should be yellow characters that are clearly visible and 3 feet (0.9 m) high. A bar may be placed under the number to minimize the possibility of being misread. (See Figures 2-18, and Appendix Figure A3-1)

d. Parking Pads. If the entire area of the parking position is not paved, the smallest dimension of a paved parking pad should be a minimum of two times the maximum dimension (length or width,

whichever is greater) of the undercarriage of the largest helicopter that will use this parking position. The parking pad should be placed in the center of the parking position circle.

e. Passenger Walkways. At parking positions, marked walkways should be provided where practicable. Figure 2-17 and 2-18 illustrates one marking scheme. The pavement should be designed so spilled fuel does not drain onto passenger walkways or toward parked helicopters. Two separated access points are required for elevated TLOFs. (Paragraph 201d(5))

f. Parking Area Size and Clearance Requirements for a Variety of Helicopters (Wheeled and Skid-equipped). The more demanding requirement will dictate what is required at a particular site. Usually, the parking area requirements for skid-equipped helicopters will be the most demanding. However, when the largest helicopter is a very large, wheeled aircraft (e.g., the S-61), and the skid-equipped helicopters are all much smaller, the parking requirements for wheeled helicopters may be the most demanding. If wheel-equipped helicopters taxi with wheels not touching the surface, parking areas should be designed based on hover taxi operations rather than ground taxi operations.

g. Fueling. Helicopter fueling is typically accomplished with the use of a fuel truck or the use of a specific fueling area with stationary fuel tanks.

(1) Systems for storing and dispensing fuel must conform to Federal, state, and local requirements for petroleum handling facilities. Guidance is found in AC 150/5230-4, *Aircraft Fuel Storage, Handling, and Dispensing on Airports*, and National Fire Protection Association (NFPA) 403, *Standard for Aircraft Rescue and Fire Fighting Services at Airports*, and NFPA 418, *Standards for Heliports*.

(2) Fueling locations should be designed and marked to minimize the potential for helicopters to collide with the dispensing equipment. Fueling areas should be designed so there is no object tall enough to be hit by the main or tail rotor blades within a distance of 1.0 rotor diameter from the center point of the position where the helicopter would be fueled (providing 0.5 rotor diameter tip clearance from the rotor tips). If this is not practical at an existing facility, long fuel hoses should be installed.

(3) Lighting. The fueling area should be lighted if night fueling operations are contemplated. Care should be taken to ensure that any light poles do not constitute an obstruction hazard.

h. Tie-Downs. Recessed tie-downs may be installed to accommodate extended or overnight parking of based or transient helicopters. If tie-downs are provided, they should be recessed so as not to be a hazard to helicopters. Caution should be exercised to ensure that any depression associated with the tie-downs should be of a diameter not be greater than 1/2 the width of the smallest helicopter landing wheel or landing skid anticipated to be operated on the heliport surface. In addition, tie-down chocks, chains, cables and ropes should be stored off the heliport surface to avoid fouling landing gear. Guidance on recessed tie-downs can be found in AC 20-35, *Tie-down Sense*.

i. Taxiway-to-Parking-Position Transition Requirements. See paragraph 207e.

209. HELIPORT MARKERS AND MARKINGS. Markers and/or surface markings should identify the facility as a heliport. Surface markings may be paint, reflective paint, reflective markers, or preformed material. Lines/markings may be outlined with a 6-inch-wide (15 cm) line of a contrasting color to enhance conspicuity. The following markers and markings should be used.

a. TLOF and FATO Perimeter Markings. The perimeter of the TLOF and/or the FATO should be marked. The perimeter of the FATO should be defined with markers and/or lines. It is suggested that the TLOF perimeter should also be defined with markers and/or lines since this provides a greater safety margin than marking only one perimeter. However, this greater safety margin may also be achieved by increasing the size of the Safety Area. Paragraph 203a and Table 2-1 recommend that the size of the Safety Area should be increased if the TLOF perimeter is not marked. [Exception: It is recognized that the FATO perimeter will not be marked if any portion of the FATO is NOT a load-bearing surface. In such cases, the TLOF perimeter should be marked.]

(1) TLOFs. The perimeter of a paved or hard surfaced TLOF should be defined with a continuous, 12-inch-wide (30 cm), white line (see Figures 2-19 and 2-20). The perimeter of an unpaved TLOF should be defined with a series of 12-inch-wide (30 cm), flush, in-ground markers, each approximately 5 feet (1.5 m) in length with end-to-

end spacing of not more than 6 inches (15 cm). (See Figure 2-20).

(2) Unpaved FATOs. The perimeter of an unpaved FATO should be defined with 12-inch-wide (30 cm), flush, in-ground markers. The corners of the FATO should be defined, and the perimeter markers should be 12 inches in width and approximately 5 feet (1.5 m) in length, and have end-to-end spacing of approximately 5 feet (1.5 m). (See Figures 2-20 and 2-21).

(3) Paved FATOs. The perimeter of a paved FATO should be defined with a 12-inch-wide (30 cm) dashed white line. The corners of the FATO should be defined, and the perimeter marking segments should be 12 inches in width, approximately 5 feet (1.5 m) in length, and with end-to-end spacing of approximately 5 feet (1.5 m). (See Figure 2-19).

b. Heliport Identification Marking. The identification marking is intended to identify the location as a heliport, to mark the TLOF, and to provide visual cues to the pilot.

(1) Standard Heliport Identification Symbol. A white H marking with a contrasting border if required (see paragraph 209) should mark the TLOF. The proportions and layout of the letter H are illustrated in Figure 2-22. The height of the H is limited to 60 feet (18.3m) for public use heliports. For PPR heliports the size of the H can be limited to 10 feet (3m). The H should be located in the center of the TLOF and oriented on the axis of the preferred approach/ departure path. A bar may be placed under the H when it is necessary to distinguish the preferred approach/ departure direction. Arrows and/or landing direction lights (see paragraph 210e) may also be used to indicate one or more preferred approach/ departure directions.

(2) Nonstandard Heliport Identification Marking. A distinctive marking, such as a company logo, may serve to identify the facility as a PPR heliport. However, nonstandard marking does not necessarily provide the pilot with the same degree of visual cueing as the standard heliport identification symbol. To compensate, paragraph 203 and Table 2-1 recommend that the size of the Safety Area should be increased when the standard heliport identification symbol "H" is not used.

c. Taxiway and Taxi Route Markings. See paragraph 207.

d. Apron Markings. In addition to the taxiway and parking position markings, the yellow (double) taxiway edge lines should continue around the apron to define its perimeter. Figure 2-14, 2-15, and 2-16 illustrates apron markings.

e. Parking Position Markings. See paragraph 208.

f. Closed Heliport. All markings of a permanently closed heliport, FATO, or TLOF should be obliterated. If it is impractical to obliterate markings, a yellow X should be placed over the H, as illustrated in Figure 2-23. The yellow X should be large enough to ensure early pilot recognition that the heliport is closed. The windsock(s) and other visual indications of an active heliport should also be removed.

g. TLOF Size Limitations. The TLOF should be marked to indicate the rotor diameter of the largest helicopter for which it is designed as indicated in Figure 2-22. (The rotor diameter should be given in feet. Metric equivalents should NOT be used for this purpose.) This marking should be centered in the lower section of a TLOF size/weight limitation 'box'. The numbers should be 3 ft (0.9 m) high (see Appendix Figure A3-1). The numbers should be black with a white background. When viewed from the preferred approach direction, this TLOF size/weight limitation 'box' should be located on the TLOF in the lower right-hand corner, or the on right-hand side of the H of a circular TLOF.

NOTE: *This marking is optional at a TLOF with a turf surface or PPR heliports.*

h. Elevated TLOF Weight Limitations. If a TLOF has limited weight-carrying capability, it should be marked with the maximum takeoff weight of the design helicopter, in units of thousands of pounds as indicated in Figure 2-22. (A numeral 12 indicates a weight-carrying capability of up to 12,000 pounds. Metric equivalents should NOT be used for this purpose.) This marking should be centered in the upper section of a TLOF size/weight limitation 'box'. The numbers should be 3 ft (0.9 m) high (see Appendix Figure A3-1). The numbers should be black with a white background. When viewed from the preferred approach direction, this TLOF size/weight limitation 'box' should be located on the TLOF in the lower right-hand corner or on the right-hand side of the H of a circular TLOF. If the TLOF does not have a weight limit, a diagonal line, extending from the lower left hand corner to the upper right hand corner, should be added to the upper

section of the TLOF size/weight limitation 'box' (see Figure 2-22).

NOTE: *This marking is optional for PPR heliports. However the PPR heliport operator should ensure that all pilots using the facility are thoroughly knowledgeable with this and any other facility limitations.*

i. Equipment/Object Marking. Heliport maintenance and servicing equipment, as well as other objects used in the airside operational areas, should be made conspicuous with paint, reflective paint, reflective tape, or other reflective markings. Particular attention should be given to marking objects that are hard to see in marginal visibility such as at night, heavy rain, or in fog.

j. Marking Obstructions Outside the Approach/ Departure Airspace. See paragraph 211.

k. Marking Proportions. See Appendix 3 for guidance on the proportions of painted numbers.

210.HELIPORT LIGHTING. For night operations, the TLOF, the FATO, taxiways, taxi routes, and the windsock need to be lighted, as described within this paragraph. AC 150/5340-28, *Low Visibility Taxiway Lighting Systems*; AC 150/5340-24, *Runway and Taxiway Edge Lighting System*; and AC 150/5345-46, *Specification for Runway and Taxiway Light Fixtures*; contain technical guidance on lighting equipment and installation details. Heliport lighting ACs are available at the Airports web site <http://faa.gov/arp>.

a. Ground-level TLOF-Perimeter Lights. Flush green lights should define the TLOF perimeter. A minimum of four flush light fixtures is recommended per side of a square or rectangular TLOF. (PPR facilities may have a minimum of three flush light fixtures on each side of a square or rectangular TLOF.) A light should be located at each corner with additional lights uniformly spaced between the corner lights, with a maximum interval of 25 feet (7.6 m) between lights. An even number of lights (at least eight lights should be used) uniformly spaced with a maximum interval of 25 feet (7.6 m) between lights, may be used to define a circular TLOF. Flush lights should be located within 1 foot (30 cm) (inside or outside) of the TLOF perimeter.

Flush lights are recommended for PPR facilities. But raised green omni-directional lights may be used if only the TLOF is load bearing. The raised lights should be located outside and within 10 foot (3m) of the edge of the TLOF and should not penetrate a horizontal plane at the TLOF elevation by more than 2 inches (5 cm).

b. Elevated TLOF - Perimeter Lights. The TLOF perimeter should be lit with green lights. If flush lights are used, they should be located within 1-foot of the TLOF perimeter. If raised, omni-directional lights are used, they should be located on the outside edge of the TLOF or the outer of the safety net, as shown in Figure 2-24. The raised lights should not penetrate a horizontal plane at the TLOF's elevation by more than 2 inches (5 cm). In areas where it snows in the winter, the outside edge is the preferred location. (Lights on the outside edge of the TLOF are prone to breakage during snow removal.) Lighting on the outside edge also provides better visual cues to pilots at a distance from the heliport since they outline a larger area.

c. Load-bearing FATO-Perimeter Lights. Green lights should define the perimeter of the load bearing FATO. A minimum of four flush or raised light fixtures is recommended per side of a square or rectangular FATO. (PPR facilities may have a minimum of three flush light fixtures on each side of a square or rectangular load-bearing FATO.) A light should be located at each corner, with additional lights uniformly spaced between the corner lights with a maximum interval of 25 feet (8 m) between lights. An even number of lights (at least eight lights should be used) uniformly spaced, with a maximum interval of 25 feet (8 m) between lights, may be used to define a circular FATO.

NOTE: *In the case of an elevated FATO with a safety net, the perimeter lights should be mounted in a similar manner as discussed in Paragraph 210b*

(1) At a distance during nighttime operations, a square or rectangular pattern of FATO perimeter lights provides the pilot with better visual cues than a circular pattern. Thus, a square or rectangular pattern of FATO perimeter lights is preferable even if the TLOF is circular.

(2) If flush FATO perimeter lights are used, they should be located within 1 foot (30 cm) inside or outside of the FATO perimeter. (See Figure 2-25.)

(3) If raised FATO perimeter lights are used, they should be no more than 8 inches (20 cm) high, and located 10 feet (3 m) from the FATO perimeter. (See Figure 2-26.)

d. Landing Direction Lights. Landing direction lights are an optional feature to be installed when it is necessary to provide directional guidance. Landing direction lights are a configuration of five yellow, omni-directional L-861 lights on the centerline of the preferred approach/ departure path. These lights are spaced at 15-foot (5 m) intervals beginning at a point not less than 20 feet (6 m) and not more than 60 feet (18 m) from the TLOF perimeter and extending outward in the direction of the preferred approach/ departure path, as illustrated in Figure 2-27.

e. Taxiway and Taxi Route Lighting. Flush green lights define taxiway centerlines. Blue omni-directional lights define the edges of the taxiway.

(1) **Taxiway Centerlines.** Taxiway centerlines are defined with flush L-852A bi-directional or L-852B uni-directional green lights. These lights should be spaced at 50-foot (15 m) longitudinal intervals on straight segments and at 25-foot (7.5 m) intervals on curved segments with a minimum of four lights needed to define the curve. Green retroreflective markers meeting requirements for Type II markers in AC 150/5345-39, *FAA Specification L-853, Runway and Taxiway Centerline Retroreflective Markers*, may be used in lieu of the L-852A or L-852B lighting fixtures.

(2) **Flush Edge Lights—Paved Taxiways.** Flush L-861T omni-directional blue lights should be used to mark the edges of a paved taxiway. These lights should be spaced at 50 feet (15.2 m) longitudinal intervals on straight segments and at 25 feet (7.5 m) intervals on curved segments with a minimum of four lights needed to define the curve. Blue retroreflective markers meeting requirements for Type II markers in AC 150/5345-39, *FAA Specification L-853* may be used to identify the edges of the taxiway.

(3) **Raised Edge Lights – Unpaved Taxiways.** A taxi route that does not contain a paved taxiway should be defined with L-861T omni-directional blue perimeter lights on raised light fixtures or blue retroreflective Type II markers. These lights or retroreflective markers should be no more than 8 inches (20 cm) tall. These lights or retroreflective markers should be placed at

longitudinal intervals of 50 feet (15 m) on straight segments and 25 feet (7.6 m) on curved segments. A minimum of four lights is recommended to define a curve. The recommended lateral spacing for the lights or reflectors is 1.0 rotor diameter but not more than 35 feet.

f. Heliport Identification Beacon. A heliport identification beacon is optional equipment. It should be installed when it is needed to aid the pilot in visually locating the heliport. When installed, the beacon, flashing white/green/yellow at the rate of 30 to 45 flashes per minute, should be located on or close to the heliport. Guidance on heliport beacons is found in AC 150/5345-12, *Specification for Airport and Heliport Beacon*. There may be merit in making operation of the beacon controllable from the approaching helicopter to ensure that it is “on” only when required.

g. Floodlights. Floodlights may be used to illuminate the TLOF, the FATO, and/or the parking area. To eliminate the need for tall poles, these floodlights may be mounted on adjacent buildings. Care should be taken, however, to place floodlights clear of the TLOF, the FATO, the Safety Area, and the approach/ departure surfaces, and any required transitional surfaces. Care should be taken to ensure that floodlights and their associated hardware do not constitute an obstruction hazard. Floodlights should be aimed down and provide a minimum of 3-foot candles (32 lux) of illumination on the apron surface. Floodlights that might interfere with pilot vision during takeoff and landings should be capable of being turned off.

h. Lighting of Obstructions. See paragraph 211.

i. Heliports at Airports. When a heliport on an airport is sited in close proximity to a taxiway, there may be a concern that the green taxiway centerline lights could be confused with the TLOF or FATO perimeter lights. In such cases, yellow lights may be used as an alternative color for marking the TLOF and the FATO.

211. MARKING AND LIGHTING OF DIFFICULT-TO-SEE OBJECTS. This paragraph discusses the marking and lighting of objects in close proximity, but outside and below of the approach/ departure surface. Guidance on marking and lighting objects is contained in AC 70/7460-1, *Obstruction Marking and Lighting*.

a. Background. Unmarked wires, antennas, poles, cell towers, and similar objects are often difficult to see, even in the best daylight weather, in time for a pilot to successfully take evasive action. While pilots can avoid such objects during en route operations by flying well above them, approaches and departures require operations near the ground where obstacles may be in close proximity.

b. Airspace. If difficult-to-see objects penetrate the object identification surfaces illustrated in Figure 2-28, these objects should be marked to make them more conspicuous. If operations are conducted at a heliport between dusk and dawn, these difficult-to-see objects should be lighted. The object identification surfaces in Figure 2-28 can be described as follows:

(1) In all directions from the Safety Area except under the approach/ departure path, the object identification surface starts at the Safety Area perimeter and extends out horizontally for a distance of 100 feet (30.5 m).

(2) Under the approach/ departure surface, the object identification surface starts from the outside edge of the FATO and extends horizontally out for a distance of 800 feet (244 m). From this point, the object identification surface extends out for an additional distance of 3,200 feet (975 m) while rising on a 8:1 slope (8 units horizontal in 1 unit vertical). From the point 800 feet (244 m) from the FATO perimeter, the object identification surface is 100 feet (30.5 m) beneath the approach/ departure surface.

(3) The width of this object identification surface under the approach/ departure surface increases as a function of distance from the Safety Area. From the Safety Area perimeter, the object identification surface extends laterally to a point 100 feet (30.5 m) outside the Safety Area perimeter. At the upper end of the surface, the object identification surface extends laterally 200 feet (61 m) on either side of the approach/ departure path.

c. Shielding of Objects. If there are a number of objects in close proximity, it may not be necessary to mark all of them if they are shielded. To meet the shielding guidelines a object would be shielded by existing structures of a permanent and substantial character or by natural terrain or topographic features of equal or greater height, and would be located in the congested area of a city, town, or settlement where it is evident beyond all reasonable doubt that the structure so shielded will not adversely affect

safety in air navigation. Additional guidance on this topic may be found in 14 CFR Part 77.15(a), Construction or alteration not requiring notice.

212.SAFETY CONSIDERATIONS. Some safety enhancements to be considered in the design of a heliport are discussed below. Other areas such as the effects of rotor downwash may need to be addressed based on site conditions and the design helicopter.

a. Security. The operational areas of a heliport should be kept clear of people, animals, and vehicles. The method used to control access depends upon the helicopter location and types of potential intruders.

(1) Safety Barrier. At ground-level general aviation heliports, one control method is to erect a safety barrier around the helicopter operational areas. This barrier may take the form of a fence, wall, or hedge. It should be no closer to the operating areas than the outer perimeter of the Safety Area. Barriers should not penetrate any approach /departure (primary or transitional) surface. Thus, in the vicinity of the approach/ departure paths, the barrier may need to be well outside the outer perimeter of the Safety Area.

(2) Any barrier should be high enough to present a positive deterrent to persons inadvertently entering an operational area and yet low enough to be non-hazardous to helicopter operations.

(3) Access to airside areas should be through controlled and/or locked gates and doors. Gates and doors should display a cautionary sign similar to that illustrated in Figure 2-29. Training of personnel should be considered as a part of any security program.

NOTE: *At PPR heliports, the heliport operator may choose to achieve the same security goals through some means other than controlled and/or locked gates and doors.*

b. Rescue and Fire Fighting Services. State and local rescue and fire fighting regulations vary. Heliports should meet the criteria of NFPA 418, Standards for Heliports, and NFPA 403, Aircraft Rescue Services and/or applicable state/local codes. A fire hose cabinet or extinguisher should be provided at each access gate/door and each fueling location. At elevated TLOFs, fire hose cabinets, fire extinguishers, and other fire fighting equipment should be located adjacent to, but below the level of, the TLOF. NFPA standards are available at National

Fire Protection Association web site <http://www.nfpa.org>.

c. Turbulence. Air flowing around and over buildings, stands of trees, terrain irregularities, etc. can create turbulence that may affect helicopter operations. (Reference 41 of Appendix 4.) The following actions may be taken in selecting a site to minimize the effects of turbulence:

(1) Ground-level Heliports. Helicopter operations from sites immediately adjacent to buildings and other large objects are subjected to air turbulence effects caused by such features. Therefore, it may be necessary to locate the TLOF away from such objects in order to minimize air turbulence in the vicinity of the FATO and the approach/ departure paths.

(2) Elevated Heliports. Elevating heliports 6 feet (1.8 m) or more above the level of the roof will generally minimize the turbulent effect of air flowing over the roof edge. While elevating the platform helps reduce or eliminate the air turbulence effects, a safety net may be required (see paragraph 201d (4)).

d. Communications. A UNICOM radio may be used to provide arriving helicopters with heliport and traffic advisory information but may not be used to control air traffic. The Federal Communications Commission (FCC) should be contacted for information on UNICOM licensing.

e. Weather Information. An automated weather observing systems (AWOS) measures and automatically broadcasts current weather conditions at the heliport site. When an AWOS is installed, it should be located at least 100 feet (30 m) and not more than 700 feet (213 m) from the TLOF. Locate the AWOS so its instruments perimeter will NOT be affected by rotor wash from helicopter operations. Guidance on AWOS systems is found in AC 150/5220-16. Automated Weather Observing Systems (AWOS) for Non-Federal Applications.

f. Winter Operations. Swirling snow raised by a helicopter's rotor wash can cause the pilot to lose sight of the intended landing point. Swirling snow on takeoff can hide objects that need to be avoided. At least the TLOF, the FATO, and as much of the Safety Area as practical should be kept free of snow. Heliport design should take into account the methods and equipment to be used for snow removal. The heliport design should allow the snow to be removed sufficiently so the snow will not present an

obstruction hazard to either the tail rotor or the main rotor. Guidance on winter operations is found in AC 150/5200-30, *Airport Winter Safety and Operations*. (Exception: In cases where the FATO is much larger than the minimum requirement, it may not be necessary to clear all of this additional area.)

213. VISUAL GLIDESLOPE INDICATORS. A visual glideslope indicator (VGI) provides pilots with visual course and descent cues. The lowest on-course visual signal must provide a minimum of 1 degree of clearance over any object that lies within 10 degrees of the approach course centerline.

a. The optimal location of a VGI is on the extended centerline of the approach path at a distance that brings the helicopter to a hover between 3 and 8 feet (0.9 to 2.5 m) above the TLOF. Figure 2-30 illustrates visual glideslope indicator clearance criteria.

b. Control of the VGI. There may be merit in making operation of the VGI controllable from the approaching helicopter to ensure that it is “on” only when required.

c. VGI Needed. At many heliports, a VGI is an optional feature. However, the provision of a VGI should be considered if one or more of the following conditions exist, especially at night:

(1) Obstacle clearance, noise abatement, or traffic control procedures require a particular slope to be flown.

(2) The environment of the heliport provides few visual surface cues.

d. Additional Guidance. AC 150/5345-52, *Generic Visual Glideslope Indicators (GVGI)*, and AC 150/5345-28, *Precision Approach Path Indicator (PAPI) Systems*, provide additional guidance.

214. TERMINAL FACILITIES. The heliport terminal requires curbside access for passengers

using private autos, taxicabs, and public transit vehicles. Public waiting areas need the usual amenities and a counter for rental car services may be desirable. Passenger auto parking areas should accommodate current requirements and have the capability of being expanded to meet future requirements. Readily available public transportation may reduce the requirement for employees and service personnel auto parking spaces. The heliport terminal building or sheltered waiting area should be attractive and functional. AC 150/5360-9, *Planning and Design of Airport Terminal Facilities at Non-Hub Locations*, contains guidance on designing terminal facilities. (At PPR heliports, the number of people using the facility may be so small that there is no need for a terminal building. In addition, the other facilities and amenities needed may be minimal.)

215. ZONING AND COMPATIBLE LAND USE. Where state and local statutes permit, the GA heliport sponsor is encouraged to promote the adoption of the following zoning measures to ensure that the heliport will continue to be available and to protect the investment in the facility.

a. Zoning to Limit Building/Object Heights. General guidance on drafting an ordinance that would limit building and object heights is contained in AC 150/5190-4, *A Model Zoning Ordinance to Limit Height of Objects Around Airports*. The ordinance should substitute the heliport surfaces for the airport surfaces in the model ordinance.

b. Zoning for Compatible Land Use. A zoning ordinance may be enacted, or an existing ordinance modified, to control the use of property within the heliport approach/ departure path environment. The ordinance should restrict activities to those that are compatible with helicopter operations.

Air Rights and Property Easements are options that may be used to prevent the encroachment of obstacles in the vicinity of a heliport.

Table 2-1. Minimum VFR Safety Area Width as a Function of General Aviation and PPR Heliport Markings

TLOF perimeter marked:	Yes	Yes	No	No
FATO perimeter marked:	Yes	Yes	Yes	Yes
Std. H marking:	Yes	No	Yes	No
GA heliports:	1/3 RD but not less than 20 ft (6 m)	1/3 RD but not less than 30 ft (9 m)	½ OL but not less than 20 ft (6 m)	½ OL but not less than 30 ft (9 m)
PPR heliports:	1/3 RD but not less than 10 ft (3 m) **	1/3 RD but not less than 20ft (6 m)**	½ OL but not less than 20 ft (6 m)	½ OL but not less than 30 ft (9 m)

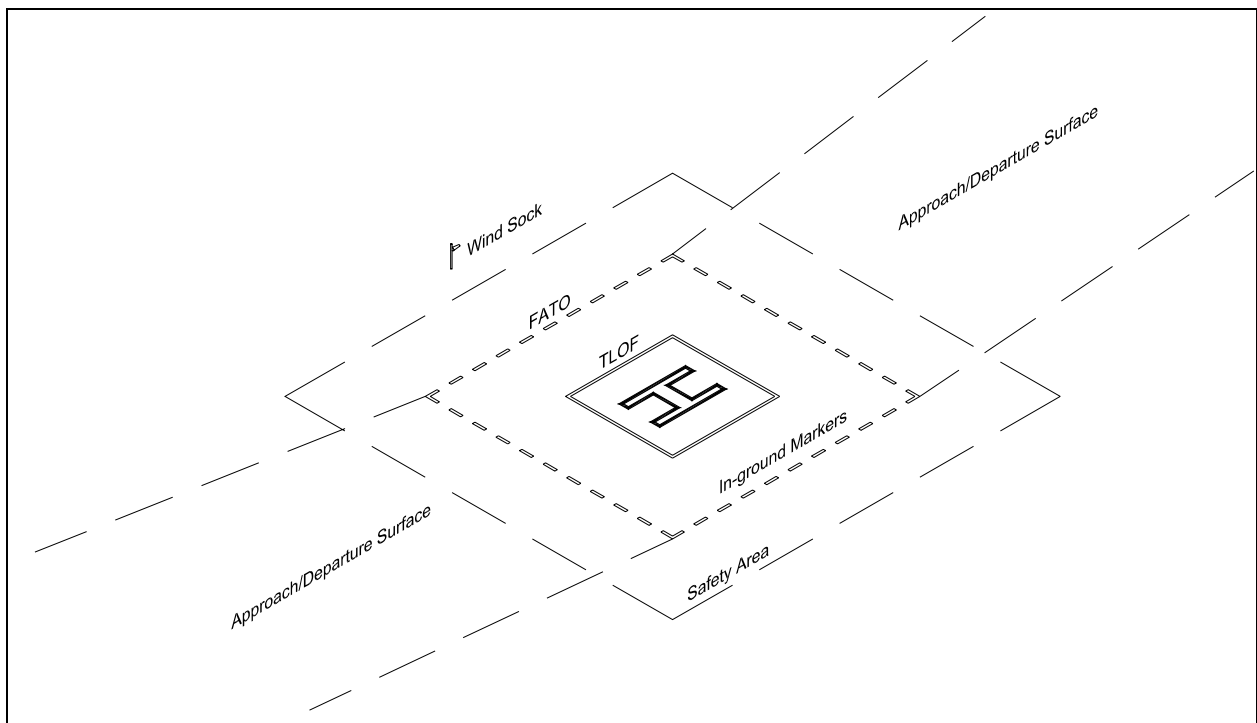
OL: Overall length of the design helicopter

RD: Rotor diameter of the design helicopter

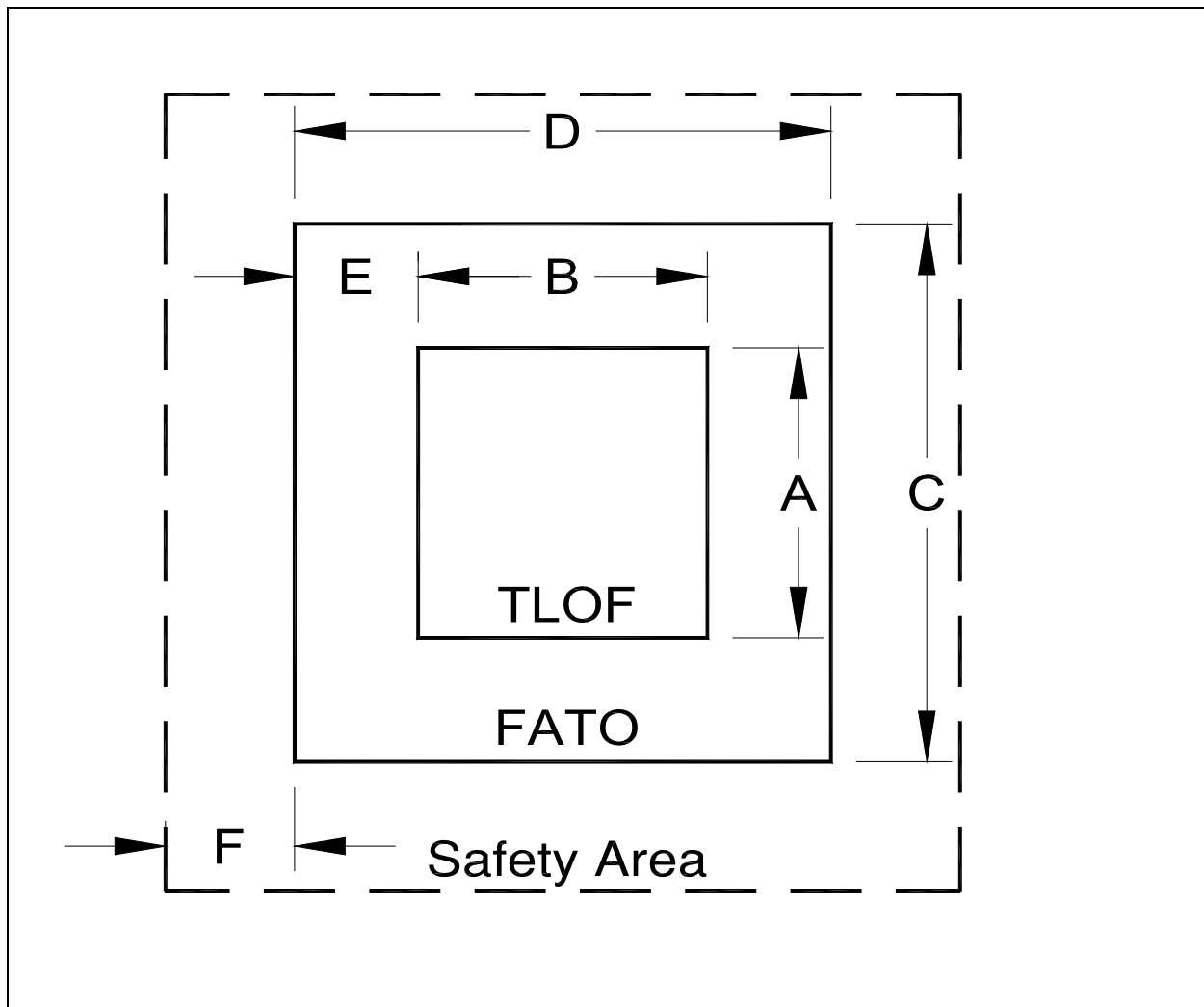
** Also applies to PPR heliports when the FATO is NOT marked. The FATO should not be marked if (a) the FATO (or part of the FATO) is a non-load bearing surface and (b) the TLOF is elevated above the level of a surrounding load bearing area.

Table 2-2. Taxiway / Taxi Route Dimensions – General Aviation Heliports

Taxiway (TW) Type	Centerline Marking Type	TW Edge Marking Type	Minimum Width Of Paved Area	Lateral Separation Between TW Edge Markings	Tip Clearance on each side	Total Taxi Route Width
Ground Taxiway	Painted	Painted	2x UC	2x UC	10 ft (3 m)	1 RD plus 20ft (6 m)
Ground Taxiway	Painted	Elevated	2x UC	1 RD but not greater than 35 ft (10.7 m)	15 ft (4.6 m)	1 RD plus 30ft (9 m)
Ground Taxiway	Flush	Flush	Unpaved but stabilized for ground taxi	2x UC	10 ft (3 m)	1 RD plus 20 ft (6 m)
Ground Taxiway	Flush	Elevated	Unpaved but stabilized for ground taxi	1 RD but not greater than 35 ft (10.7 m)	15 ft (4.6 m)	1 RD plus 30ft (9 m)
Ground Taxiway	None	Elevated	(2 x UC) Paved or Unpaved but stabilized for ground taxi	1 RD but not greater than 35 ft (10.7 m)	1/3 RD plus 10 ft (3 m)	RD < 35 ft (10.7 m); 5/3 RD + 20ft (6 m) RD = 35 ft (10.7 m); 78.3" (23.9 m) RD > 35 ft (10.7 m); 2/3 RD + 55 ft (17 m)
Hover Taxiway	Painted	Painted or flush	2x UC	2x UC	1/3 RD plus 10 ft (3 m)	RD < 35 ft (10.7 m); 5/3 RD plus 20 ft (6 m) RD = 35 ft (10.7 m); 78.4" (23.9 m) RD > 35 ft (10.7 m); 2/3 RD plus 55 ft (17 m)
Hover Taxiway	Flush	Elevated	Unpaved	1 RD but not greater than 35 ft (10.7 m)	1/3 RD plus 10 ft (3 m)	RD < 35 ft (10.7 m); 5/3 RD plus 20 ft (6 m) RD = 35 ft (10.7 m); 78.3 ft (23.9 m) RD > 35 ft (10.7 m); 2/3 RD plus 55 ft (17 m)
Hover Taxiway	None	Elevated	Unpaved	1 RD but not greater than 35 ft (10.7 m)	1/3 RD plus 20 ft (6 m)	RD < 35ft (10.7 m); 5/3 RD plus 40 ft (12 m) RD = 35ft (10.7 m); 98.4 ft (30 m) RD > 35 ft (10.7 m); 2/3 RD plus 75 ft (23 m)
RD: rotor diameter of the design helicopter TW: taxiway UC: undercarriage length or width (whichever is greater) of the design helicopter.						



**Figure 2-1. Essential Features of a General Aviation Heliport:
GENERAL AVIATION**



A – Minimum TLOF Width: 1.0 RD

B – Minimum TLOF Length: 1.0 RD

C – Minimum FATO Width: 1.5 OL

D – Minimum FATO Length: 1.5 OL. See paragraph 202b(2) for adjustments for elevation above 1000ft.

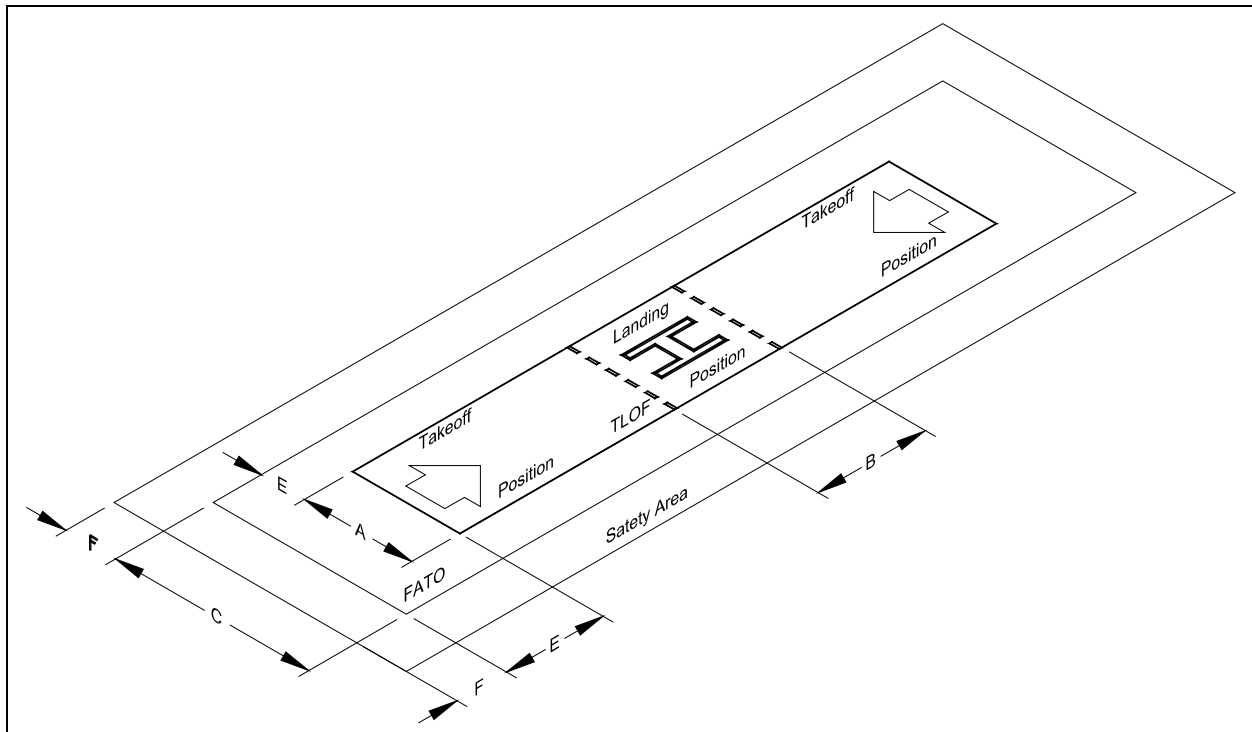
E – Minimum separation between the perimeters of the TLOF and the FATO: $[0.5 (1.5 OL - 1.0 RD)]$

F – Minimum Safety Area Width: See Table 2-1

RD: Rotor diameter of the design helicopter

OL: Overall length of the design helicopter

**Figure 2-2. TLOF/FATO/Safety Area Relationships and Minimum Dimensions:
GENERAL AVIATION**



A – Minimum TLOF Width: 1.0 RD

B – Minimum TLOF Length: 1.0 RD

C – Minimum FATO Width: 1.5 OL

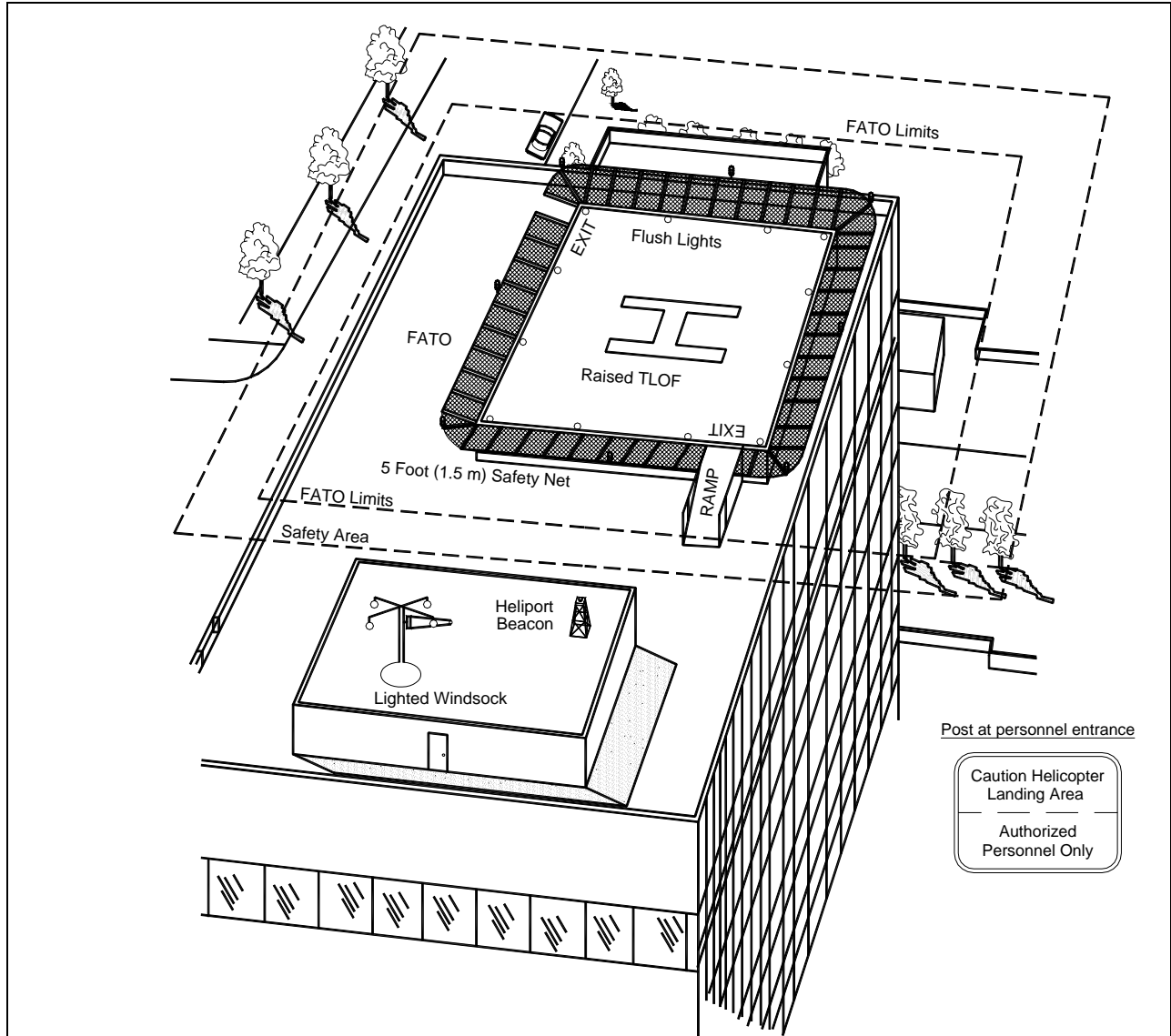
E – Minimum Separation between the perimeters of the TLOF and the FATO: $[0.5(1.5 OL - 1.0 RD)]$

F – Minimum Safety Area Width: See Table 2-1

RD: Rotor diameter of the design helicopter

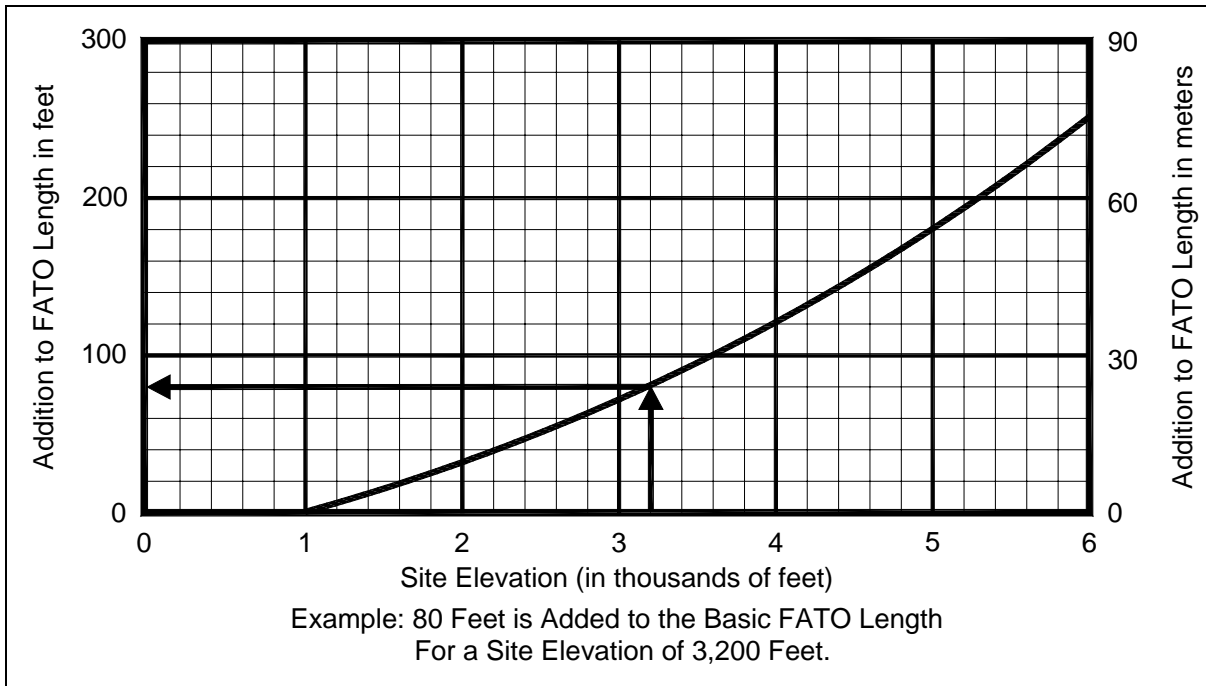
OL: Overall length of the design helicopter

**Figure 2-3. An Elongated FATO with Two Takeoff Positions:
GENERAL AVIATION**

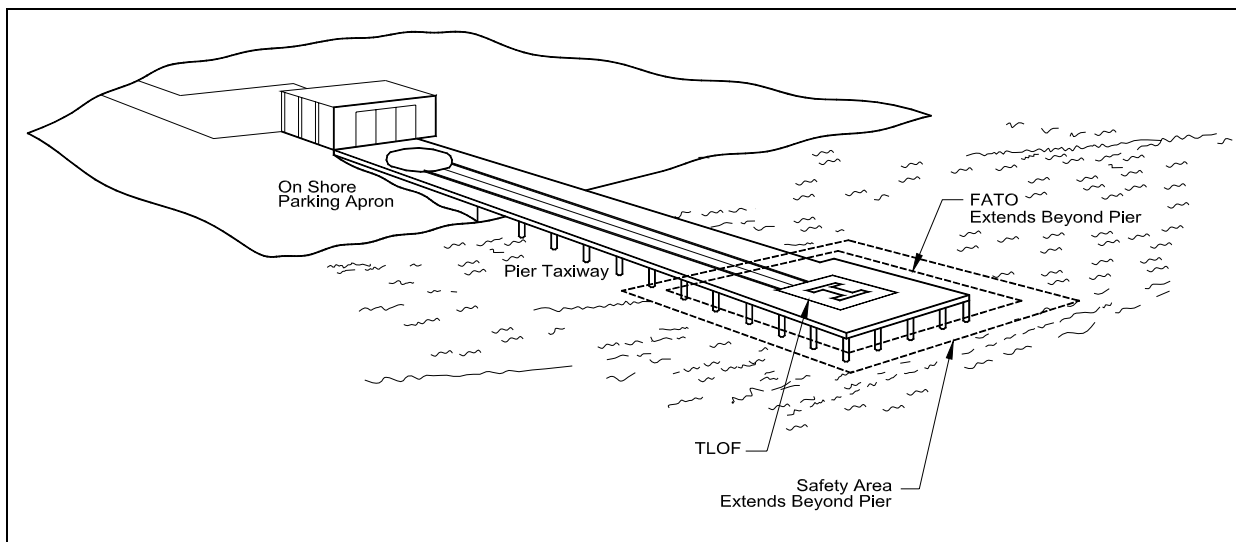


NOTE: See Figure 2-24, Elevated TLOF Perimeter Lighting, for more detailed view of the safety net and lighting.

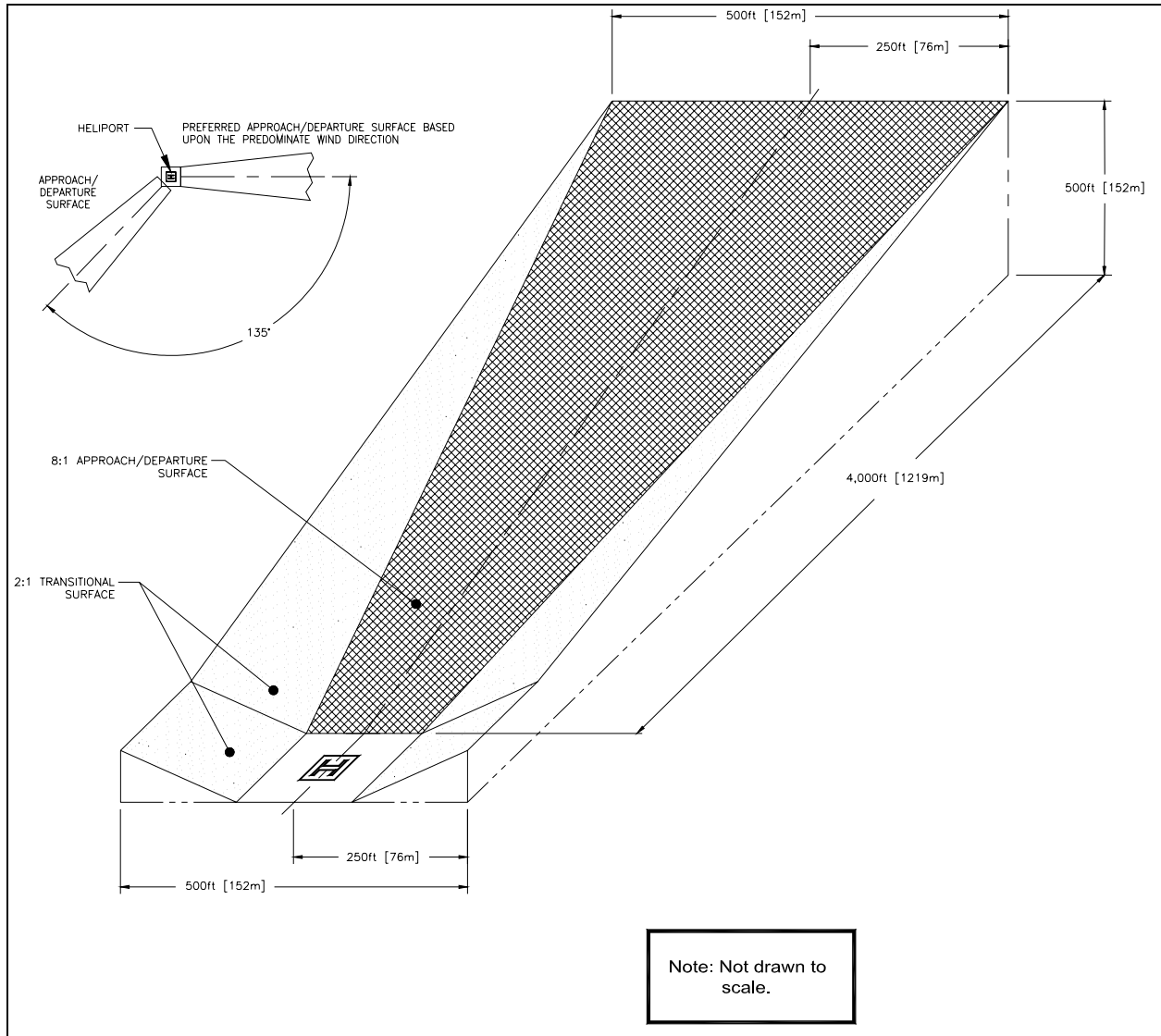
**Figure 2-4. Elevated Heliport:
GENERAL AVIATION**



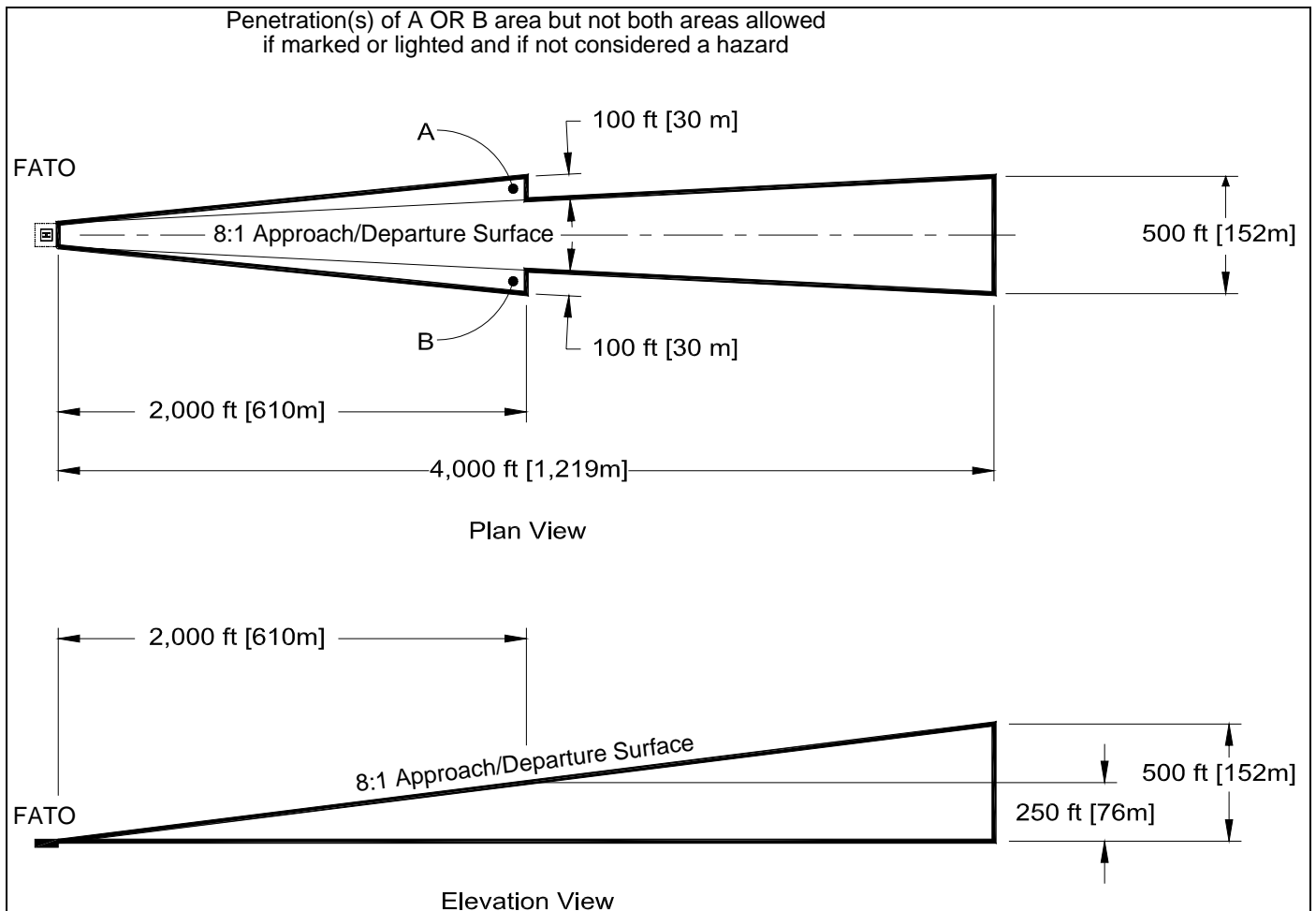
**Figure 2-5. Additional FATO Length for Heliports at Higher Elevations:
GENERAL AVIATION**



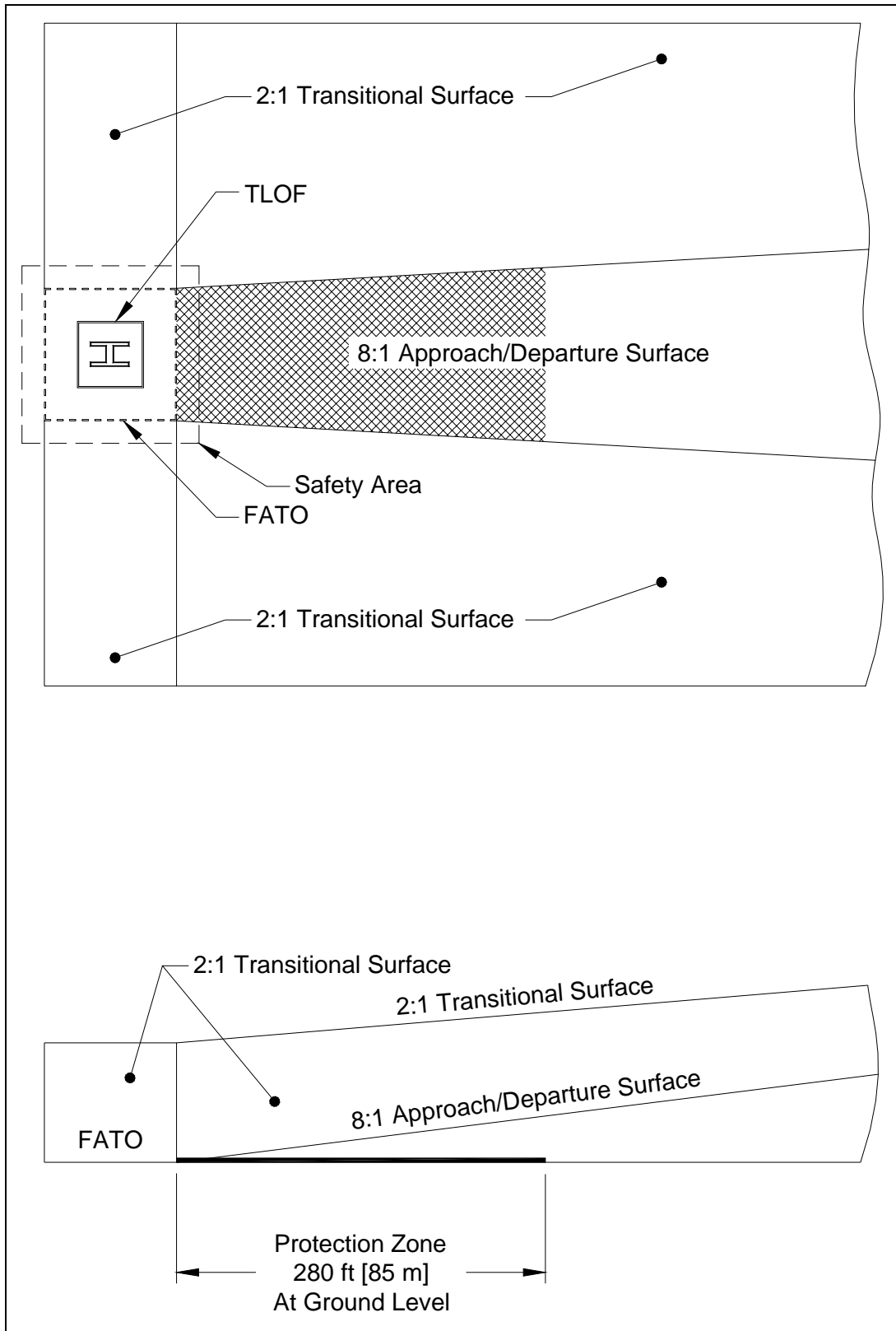
**Figure 2-6. Non-load-bearing FATO and Safety Area:
GENERAL AVIATION**



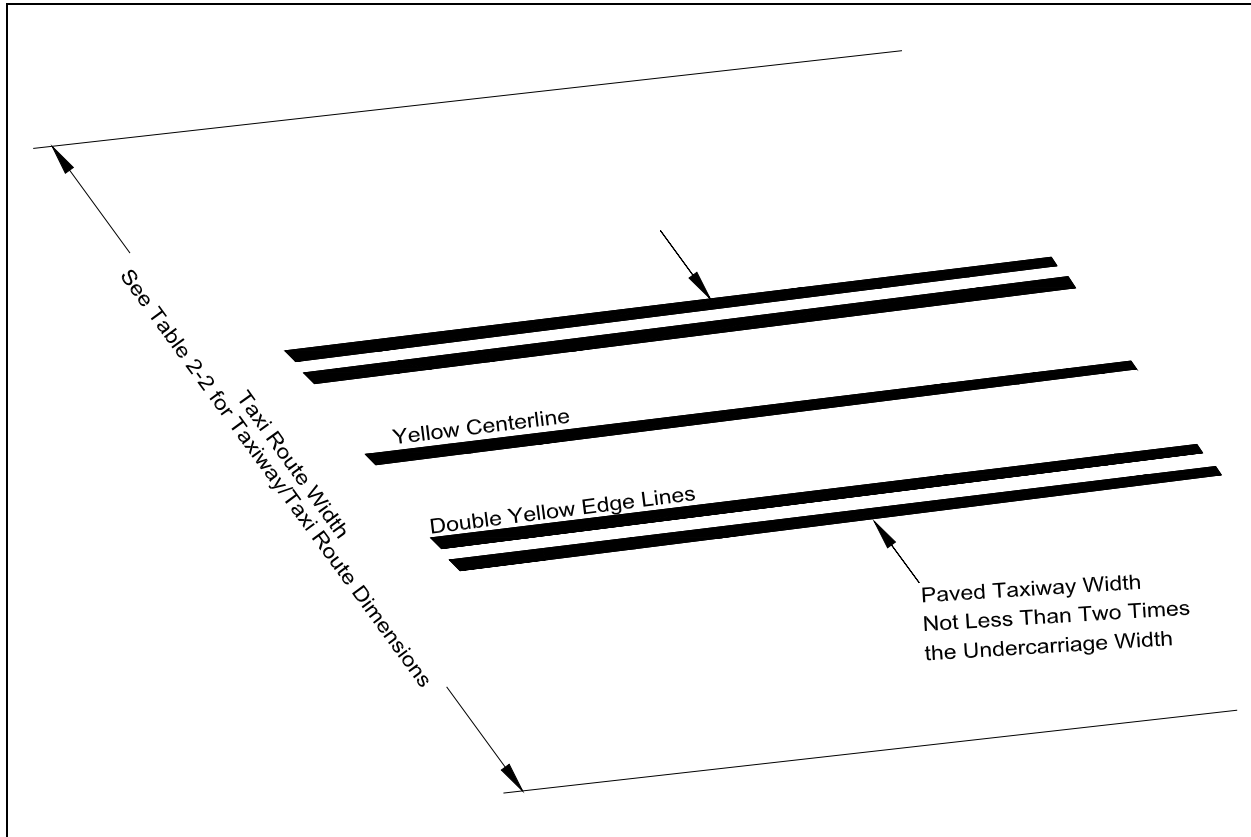
**Figure 2-7. VFR Heliport Approach/Departure and Transitional Surfaces:
GENERAL AVIATION**



**Figure 2-8. VFR PPR Heliport Lateral Extension of the 8:1 Approach/ Departure Surface:
GENERAL AVIATION**

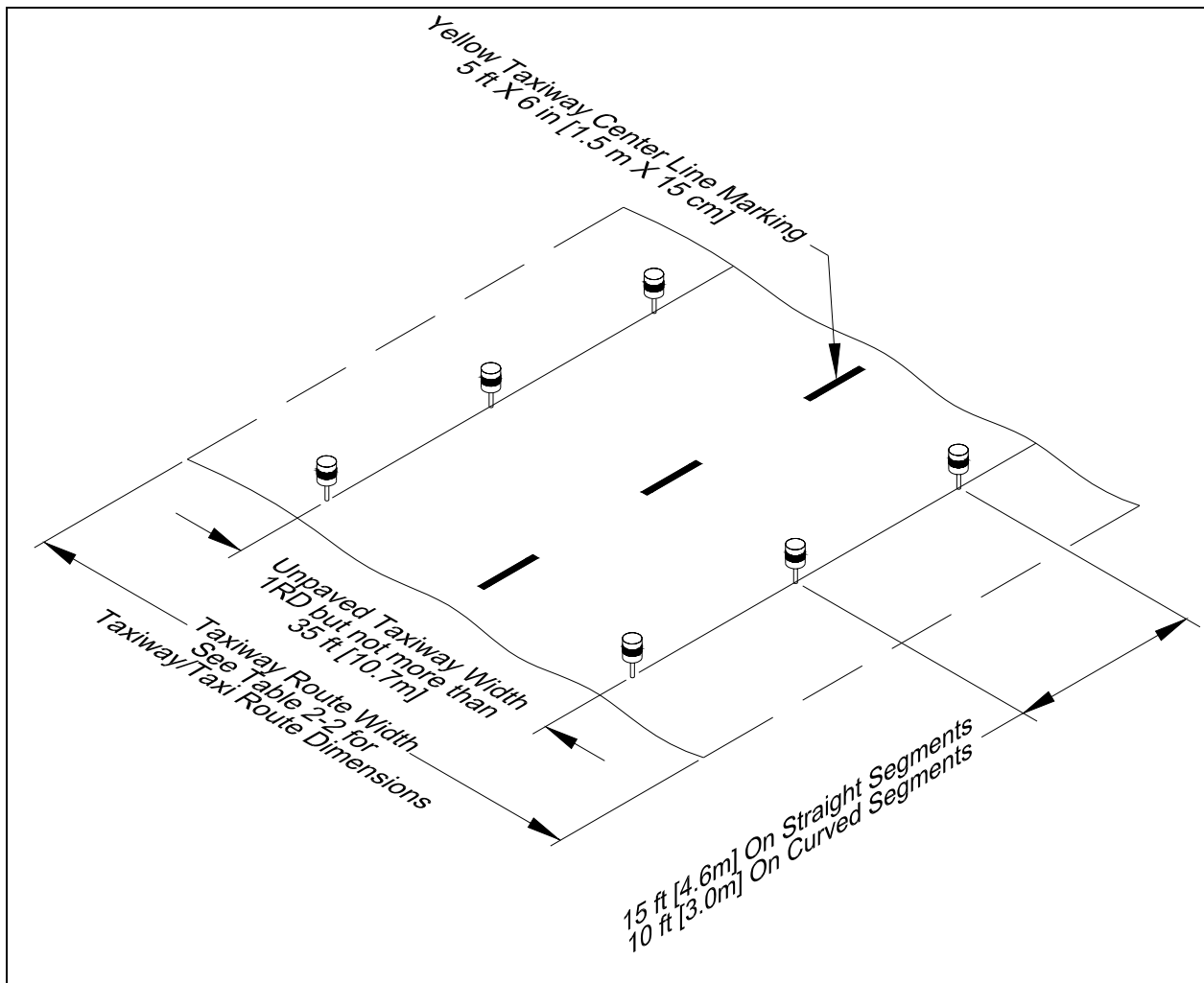


**Figure 2-9. Protection Zone:
GENERAL AVIATION**



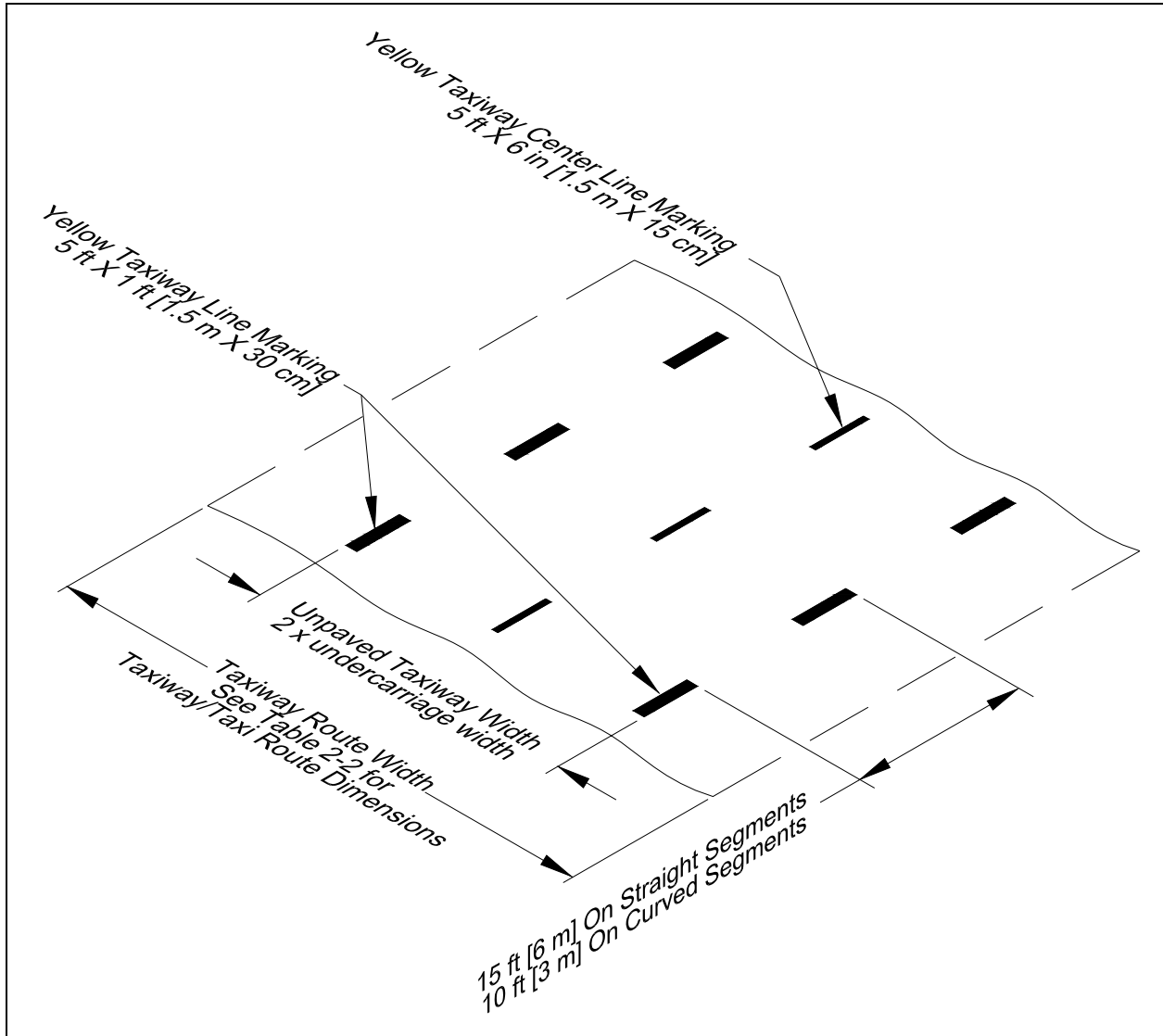
NOTE: See Table 2-2 for Taxiway/Taxi Route Dimensions

**Figure 2-10. Taxiway/Taxi Route Relationship - Paved Taxiway:
GENERAL AVIATION**



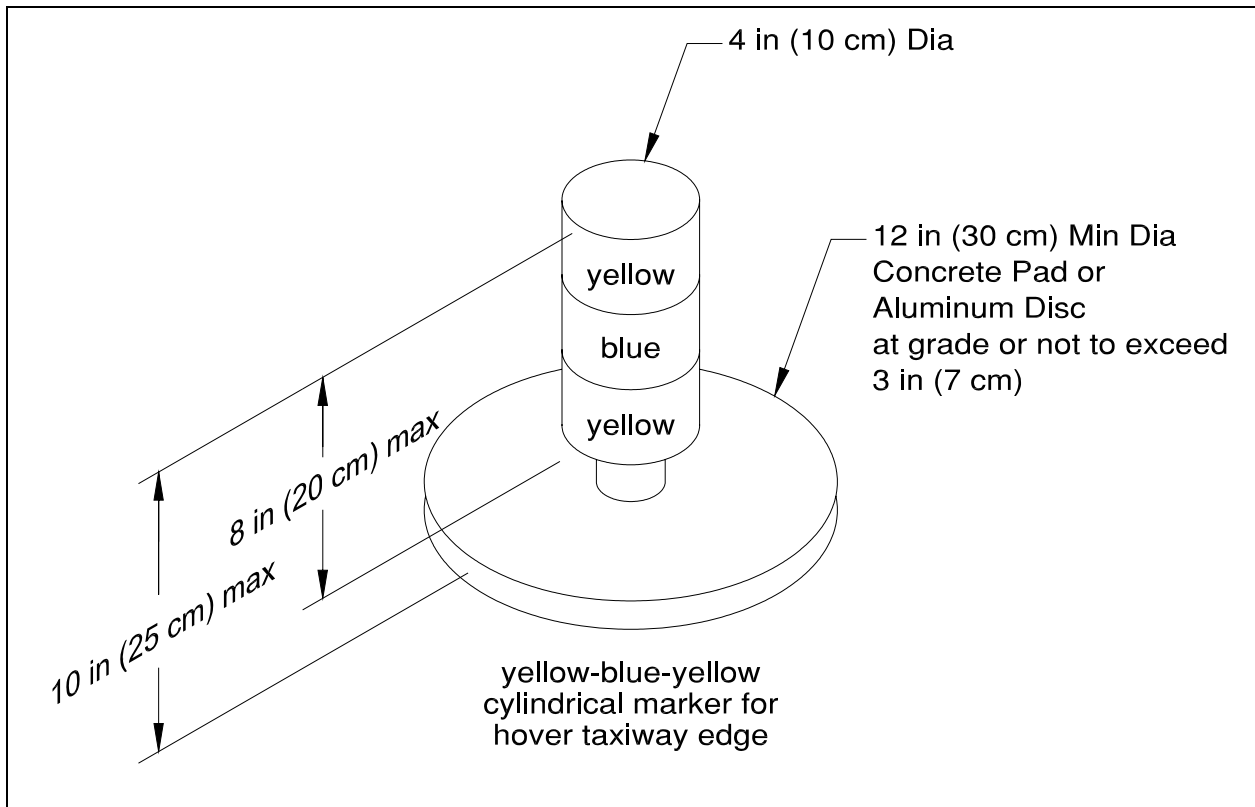
NOTE: See Table 2-2 for Taxiway/Taxi Route Dimensions

**Figure 2-11. Taxiway/Taxi Route Relationship - Unpaved Taxiway with Raised Edge Markers:
GENERAL AVIATION**

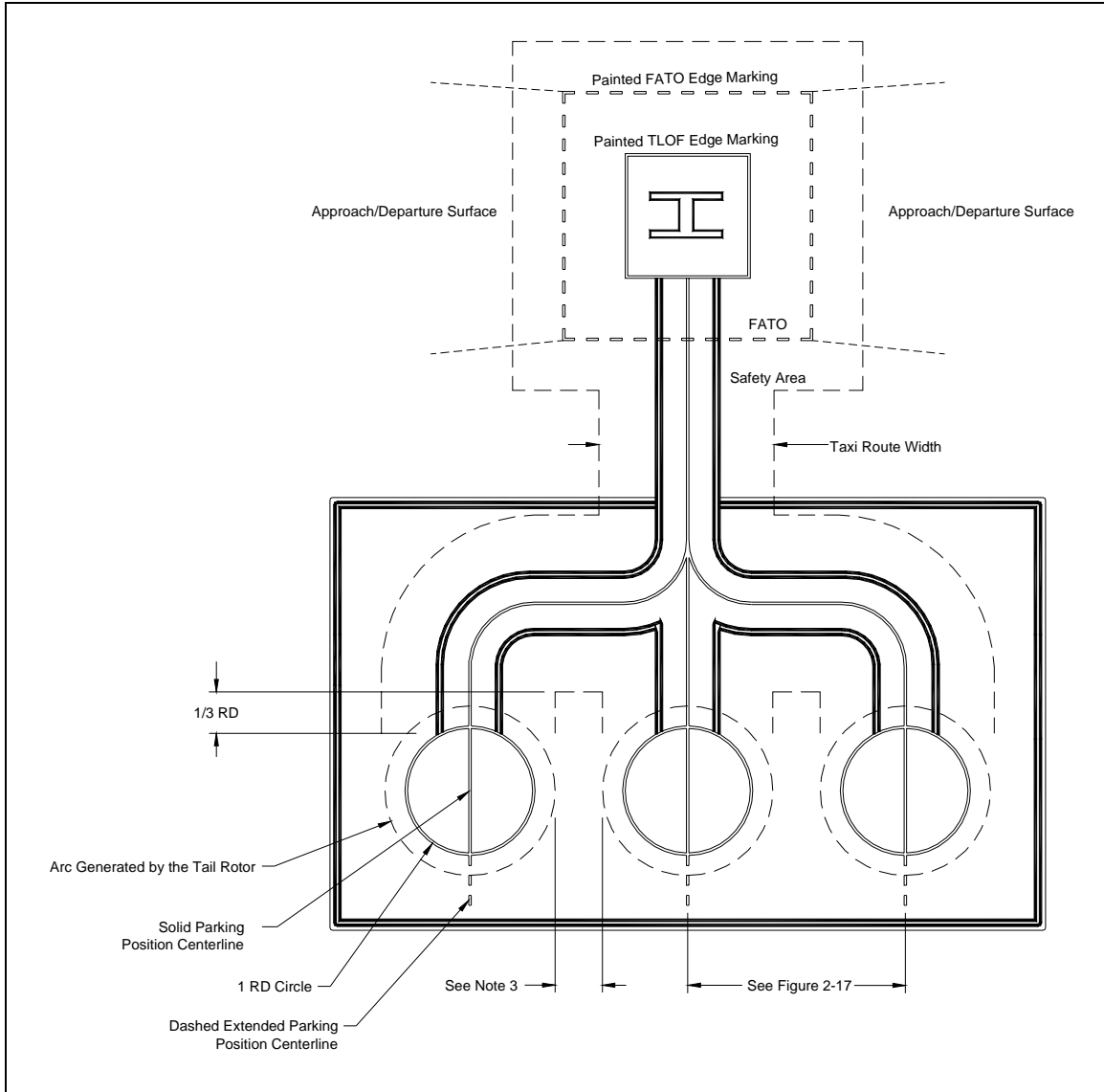


NOTE: See Table 2-2 for Taxiway/Taxi Route Dimensions

**Figure 2-12. Taxiway/Taxi Route Relationship - Unpaved Taxiway with Flush Edge Markers:
GENERAL AVIATION**

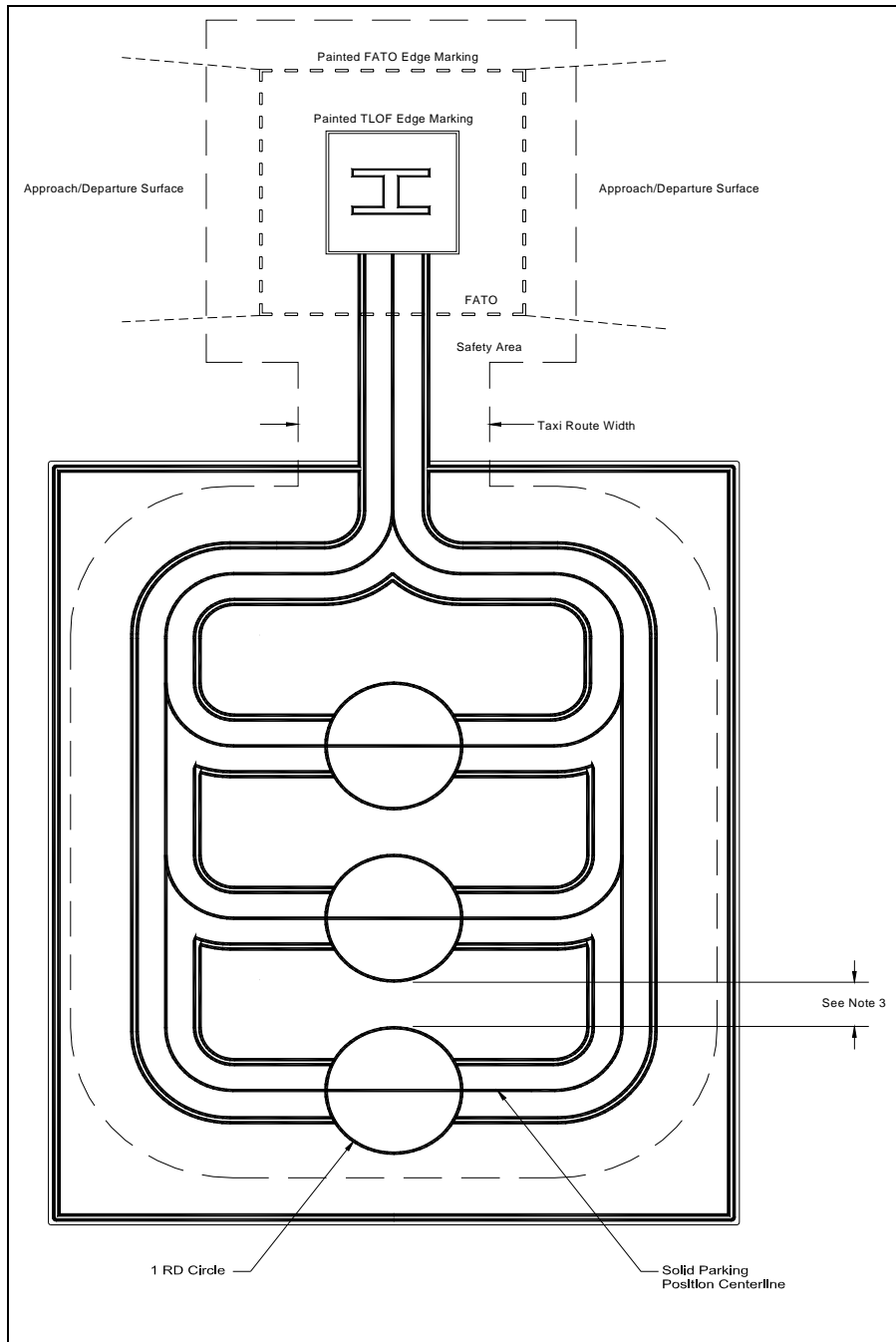


**Figure 2-13. Raised Taxiway Edge Marker:
GENERAL AVIATION**

**NOTES:**

1. For simplicity, some markings have not been shown on this figure such as parking position identifier, passenger walkway, and rotor diameter of the largest helicopter that the FATO/TLOF or the parking position is designed to accommodate.
2. The design of these parking positions is based on the presumption that the helicopter may pivot about the mast prior to exiting the parking position.
3. The minimum recommended clearance between the arcs generated by the tail rotor:
 - Hover taxi operations: 1/3 RD
 - Ground taxi operations: 10 ft (3 m)

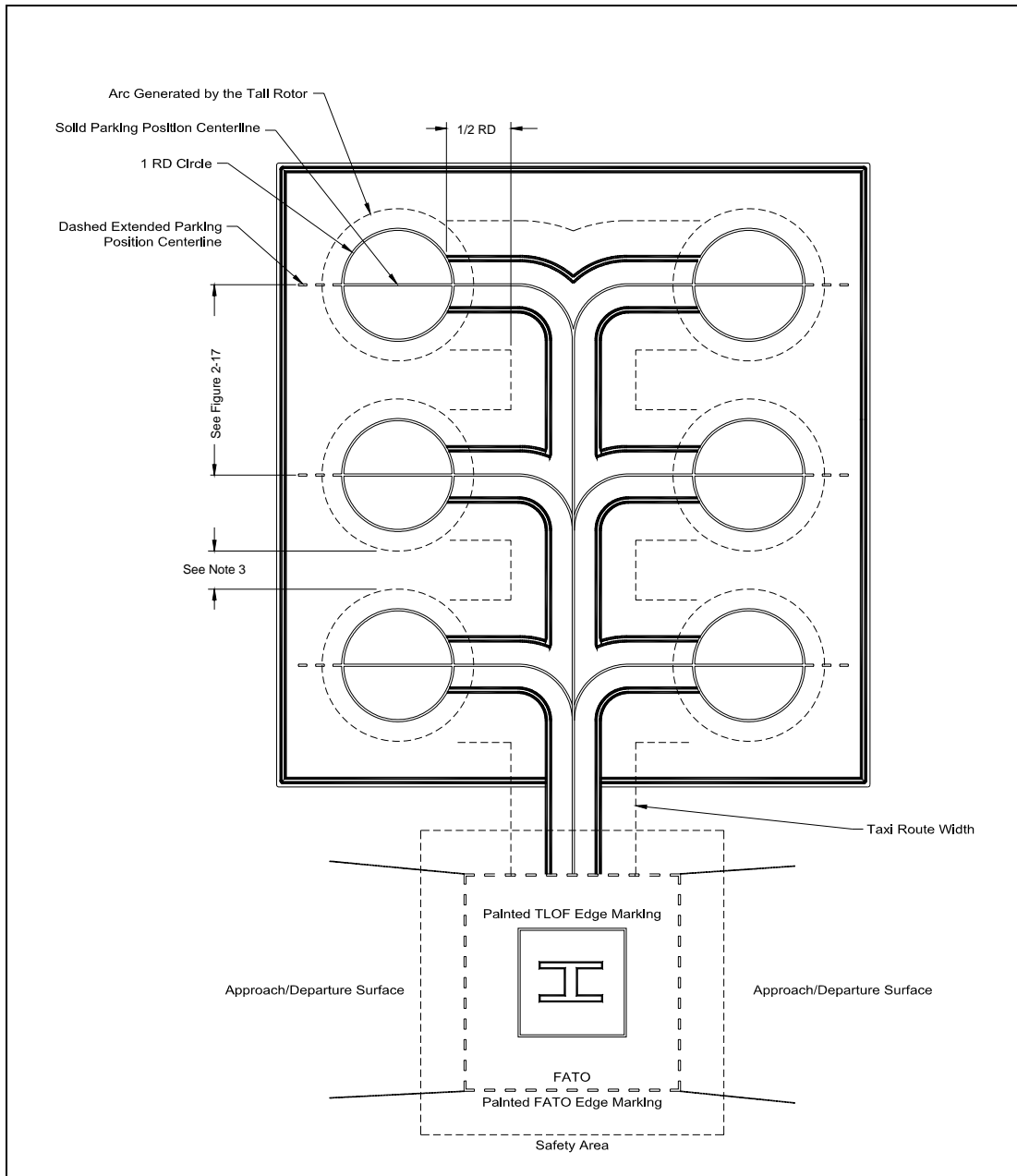
**Figure 2-14. Parking Area Design - "Turn-around" Parking Positions:
GENERAL AVIATION**



NOTES:

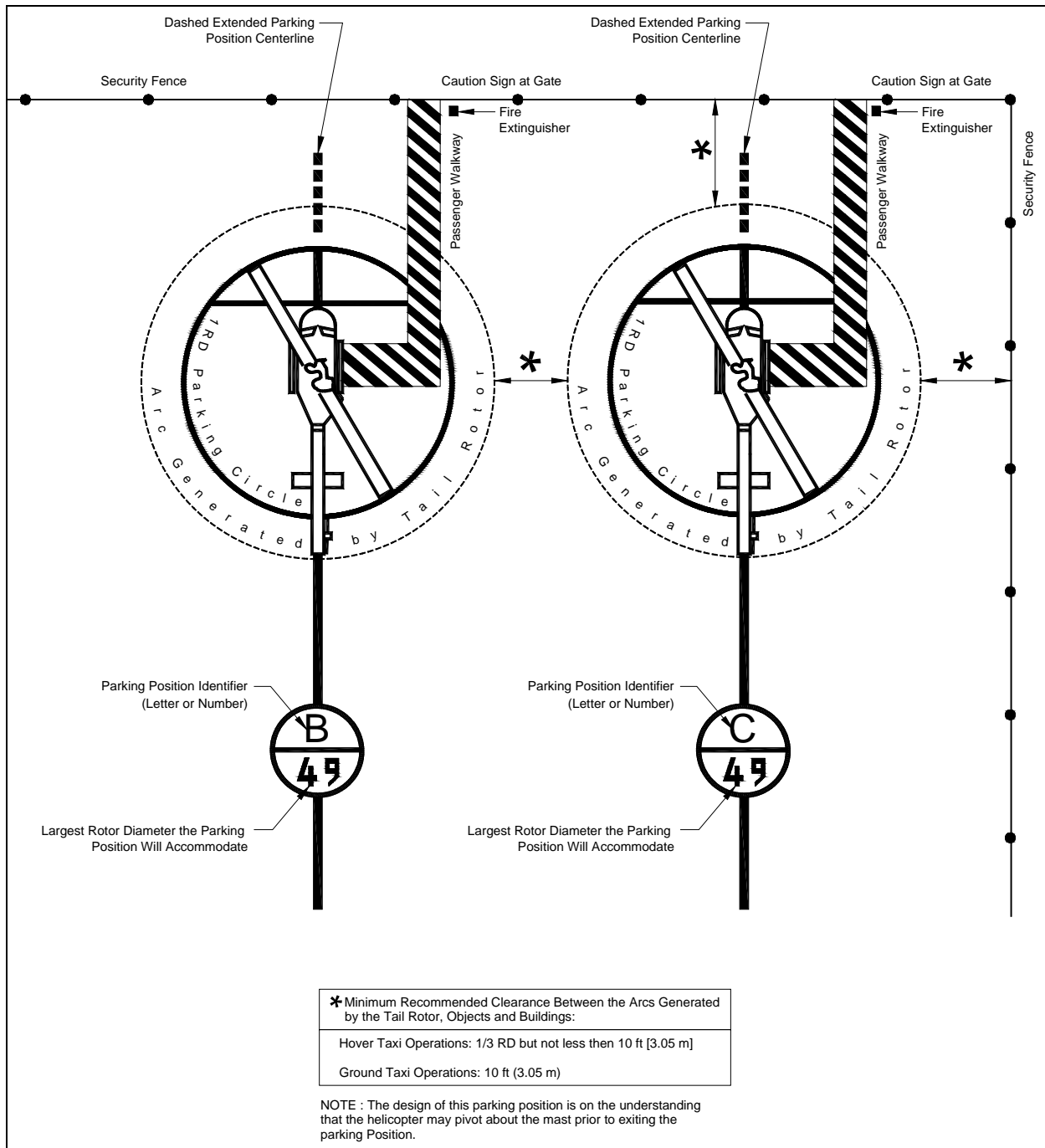
1. For simplicity, some markings have not been shown on this figure such as parking position identifier, passenger walkway, and rotor diameter of the largest helicopter that the FATO/TLOF or the parking position is designed to accommodate.
2. The minimum recommended clearance between parking positions:
 Hover taxi operations: $1/3$ RD
 Ground taxi operations: 10 ft (3 m)

**Figure 2-15. Parking Area Design - "Taxi-through" Parking Positions:
 GENERAL AVIATION**

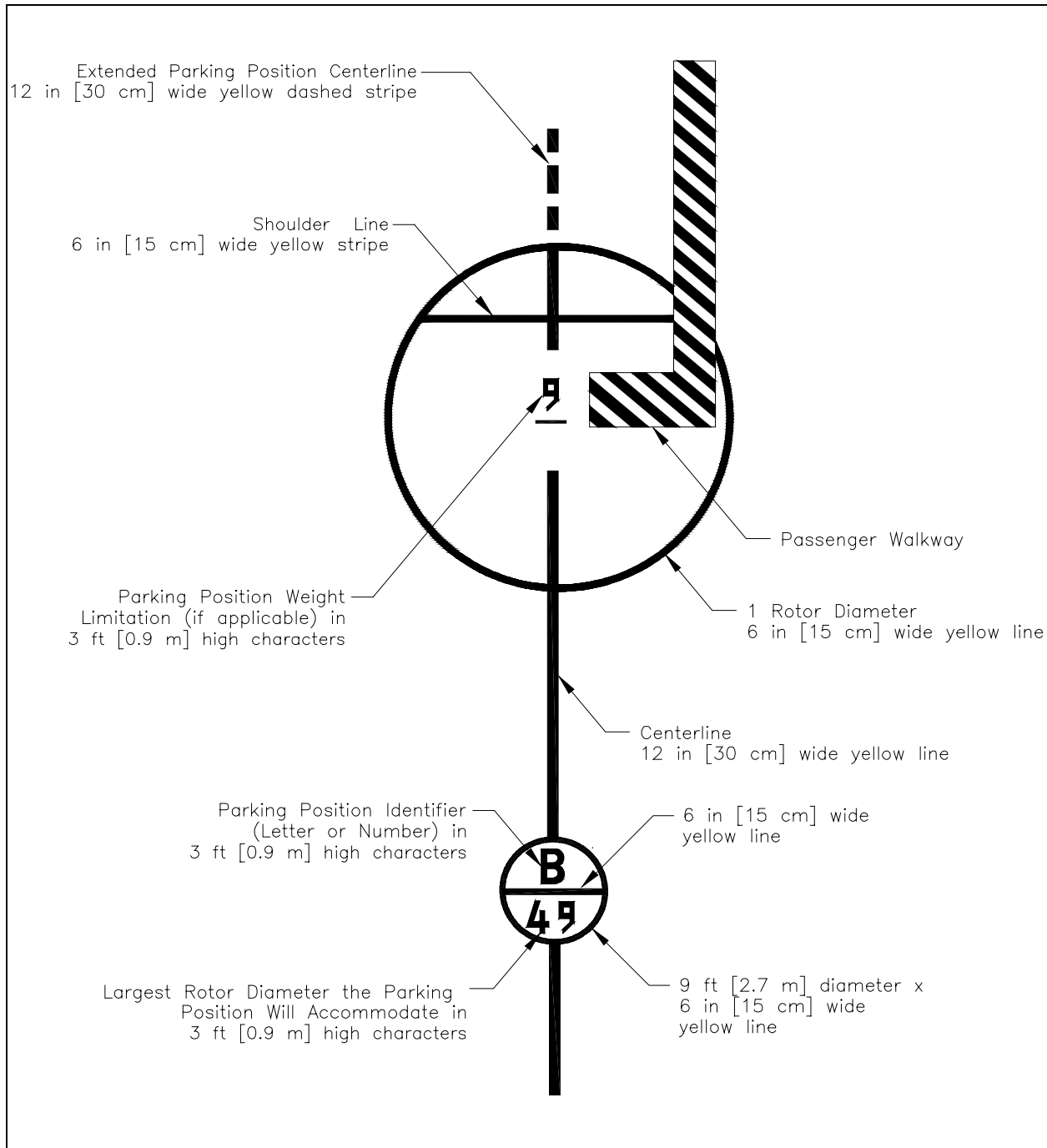
**NOTES:**

1. For simplicity, some markings have not been shown on this figure such as parking position identifier, passenger walkway, and rotor diameter of the largest helicopter that the FATO/TLOF or the parking position is designed to accommodate.
2. The design of these parking positions is based on the presumption that the helicopter may pivot about the mast prior to exiting the parking position.
3. The minimum recommended clearance between the arcs generated by the tail rotor:
 - Hover taxi operations: 1/2 RD
 - Ground taxi operations: 10 ft (3 m)

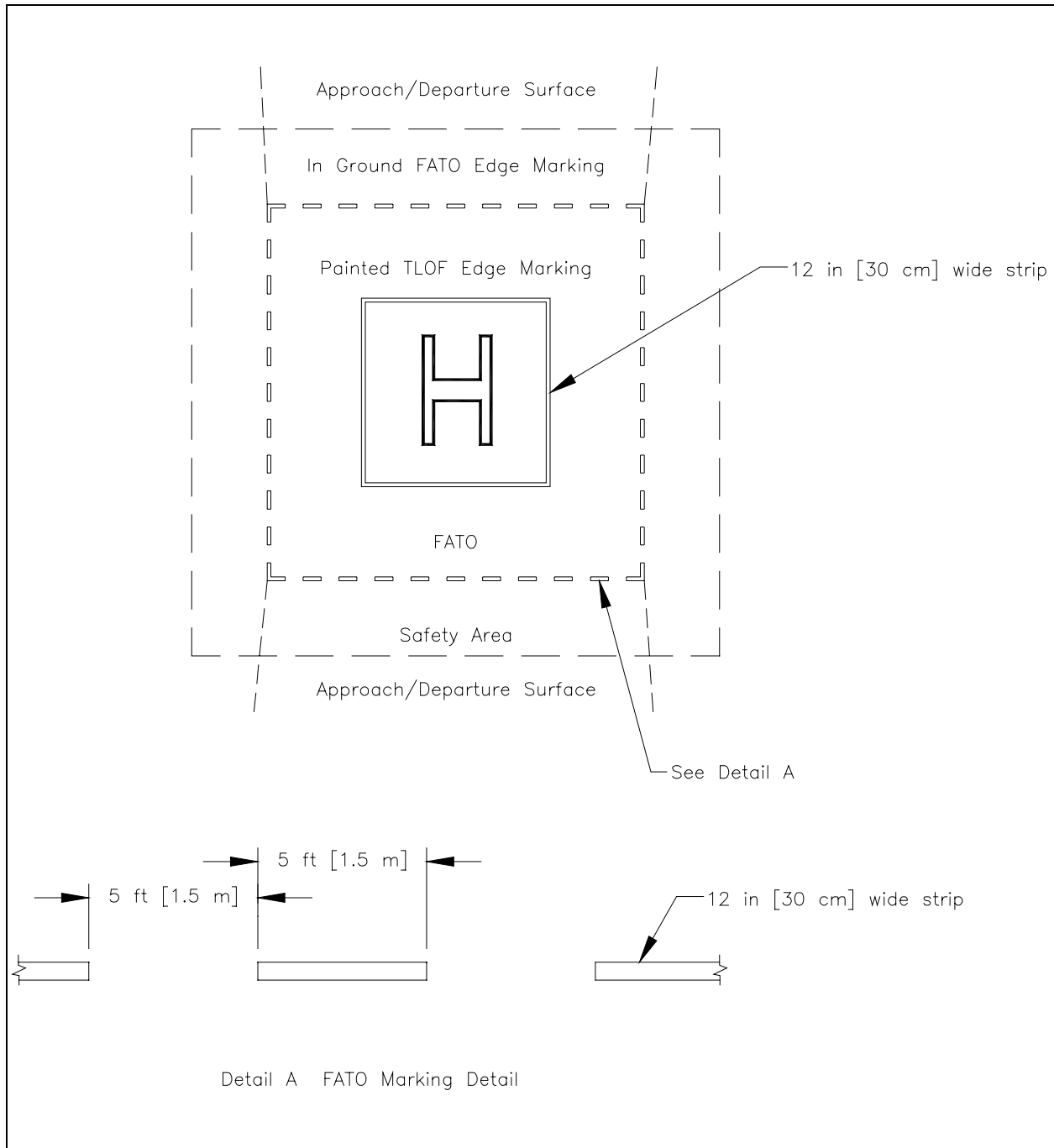
**Figure 2-16. Parking Area Design - "Back-out" Parking Positions:
GENERAL AVIATION**



**Figure 2-17. Parking Position Marking:
GENERAL AVIATION**



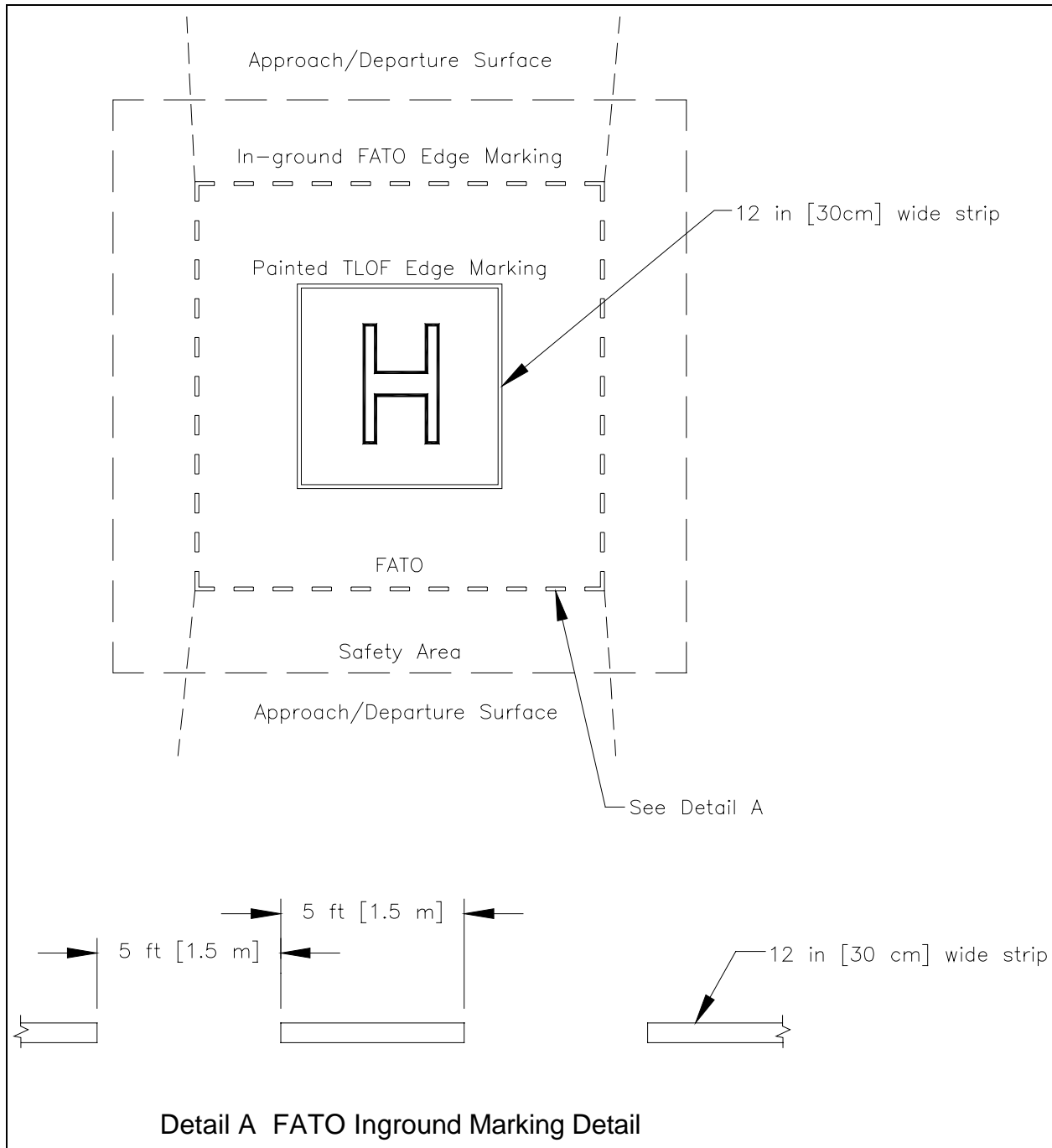
**Figure 2-18. Parking Position Identification, Size and Weight Limitations:
GENERAL AVIATION**



NOTES:

1. The perimeter of the TLOF and/or the FATO should be marked.
2. Paved or hard surfaced TLOF perimeters should be defined with a continuous, 12-inch-wide (30 cm), white line
3. The perimeter of a paved FATO should be defined with a 12-inch-wide (30 cm) dashed white line (See detail A).
4. Rotor diameter and weight limitation markings are not shown for simplicity.
5. See Figure 2-22 for the dimensions of the H.

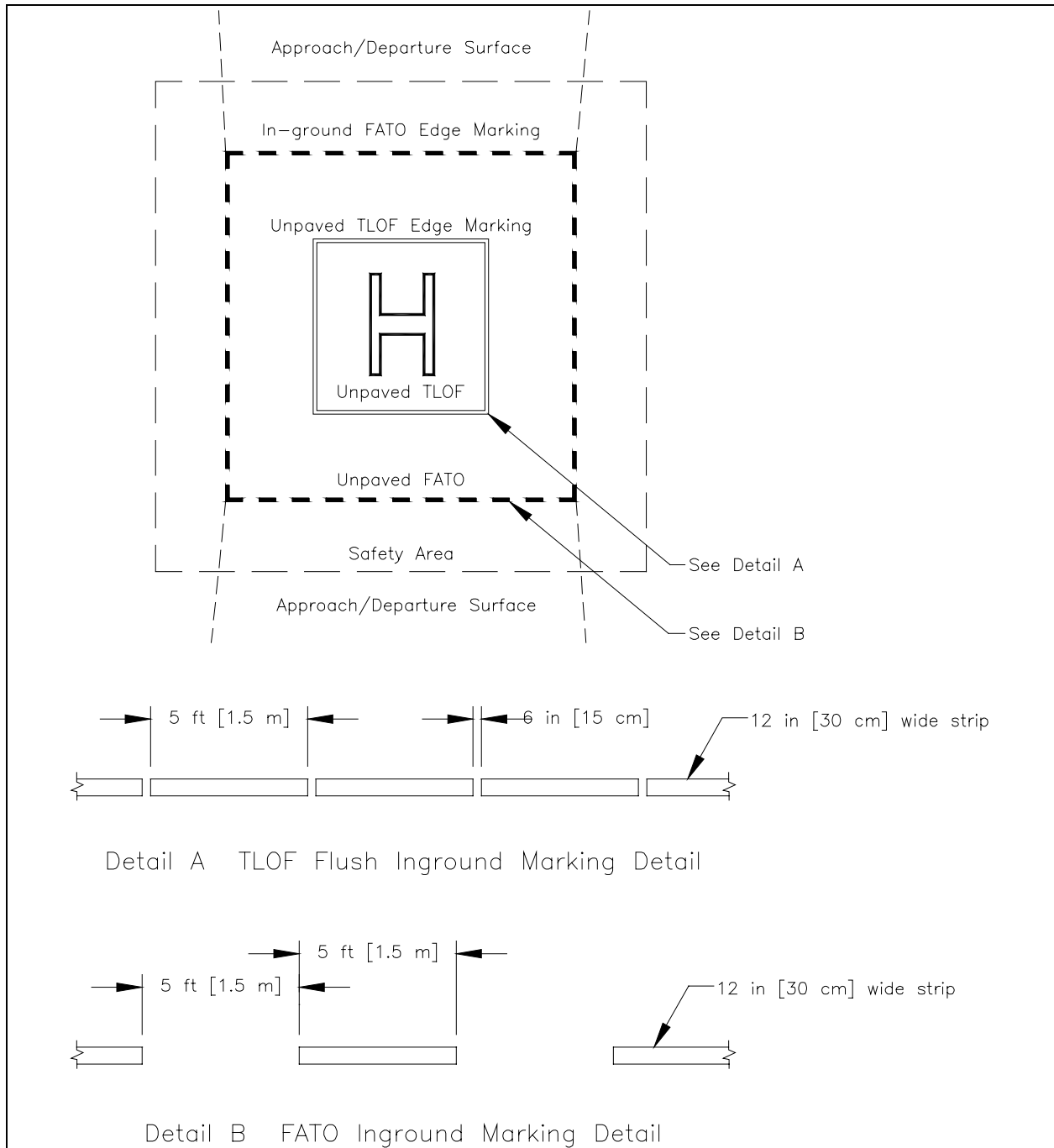
**Figure 2-19. Paved TLOF/Paved FATO - Marking:
GENERAL AVIATION**



NOTES:

1. The perimeter of the TLOF and/or the FATO should be marked.
2. The perimeter of a paved or hard surfaced TLOF should be defined with a continuous, white line.
3. The perimeter of an unpaved FATO should be defined with flush, in-ground markers. (See detail A.)
4. See Figure 2-22 for the dimensions of the **H**.
5. Rotor diameter and weight limitation markings are not shown for simplicity.

**Figure 2-20. Paved TLOF/Unpaved FATO - Marking:
GENERAL AVIATION**



NOTES:

1. The perimeter of the TLOF and/or the FATO should be marked
2. The perimeter of an unpaved TLOF should be defined with a series of flush, in-ground markers. (See detail A.)
3. The perimeter of an unpaved FATO should be defined with flush, in-ground markers. (See detail B.)
4. See Figure 2-22 for the dimensions of the **H**.
5. Rotor diameter and weight limitation markings are not shown for simplicity.

**Figure 2-21. Unpaved TLOF/Unpaved FATO - Markings:
GENERAL AVIATION**

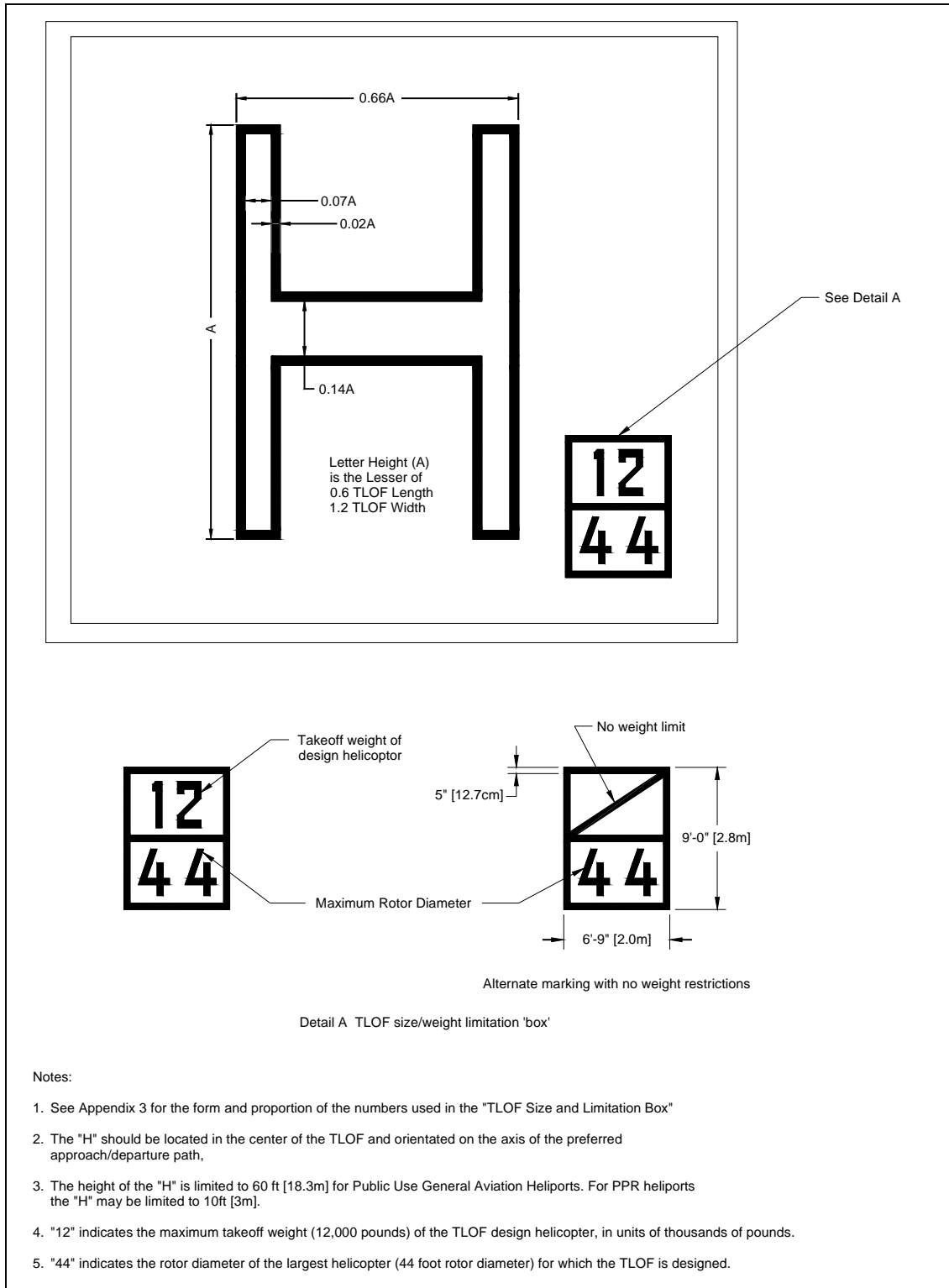
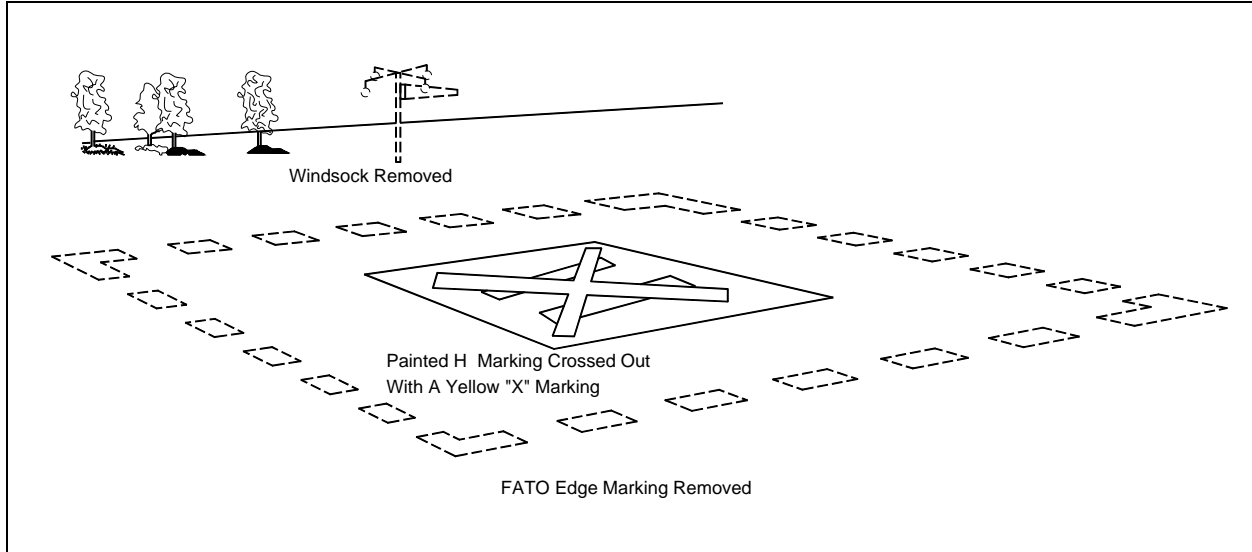
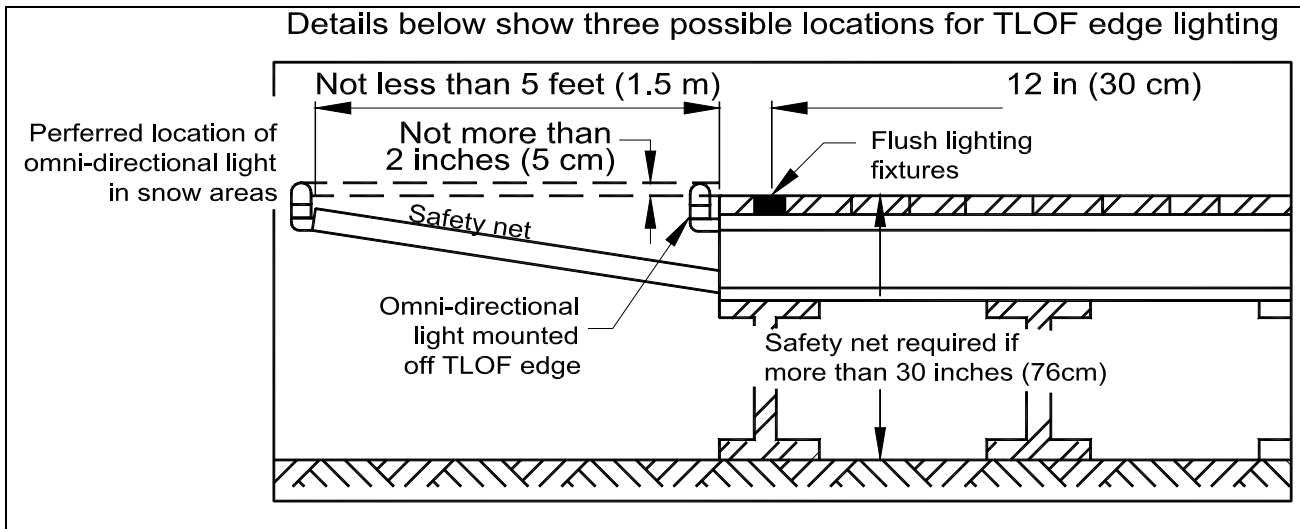


Figure 2-22. Standard Helicopter Identification Symbol, TLOF Size and Weight Limitations:

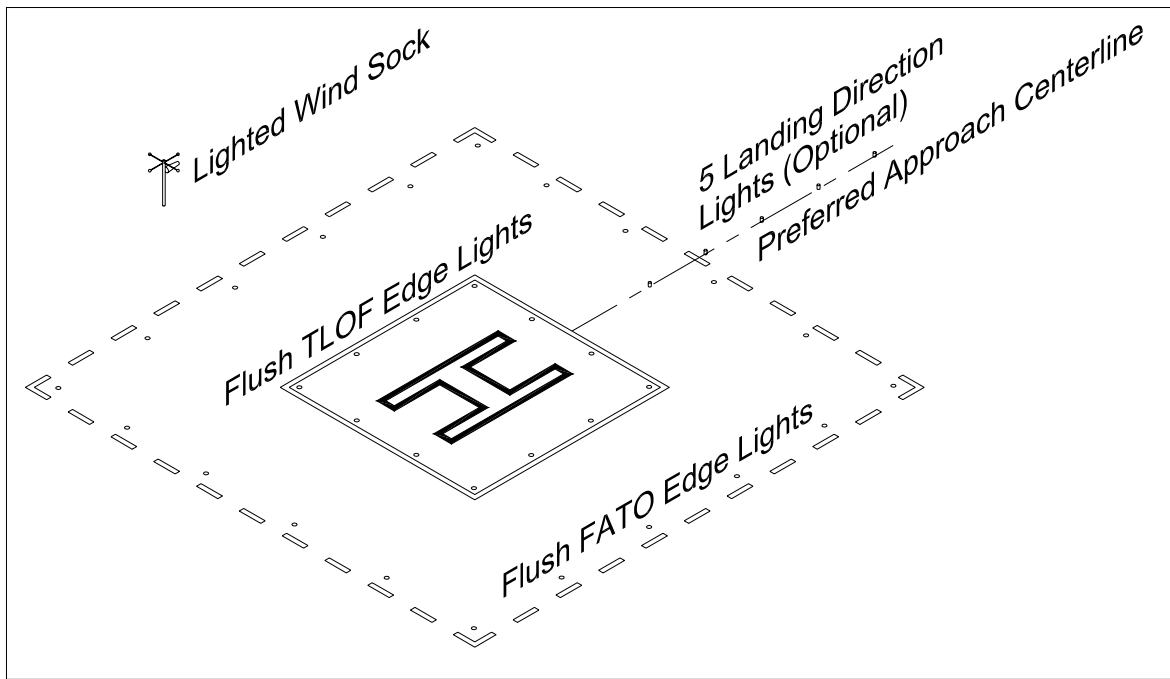
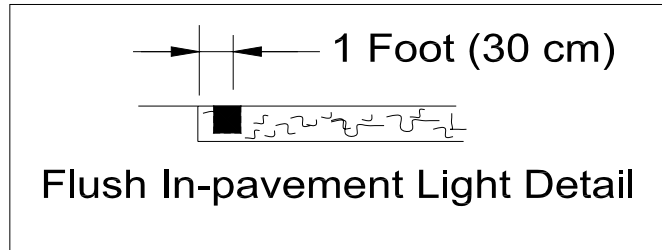
GENERAL AVIATION



**Figure 2-23. Marking a Closed Heliport:
GENERAL AVIATION**



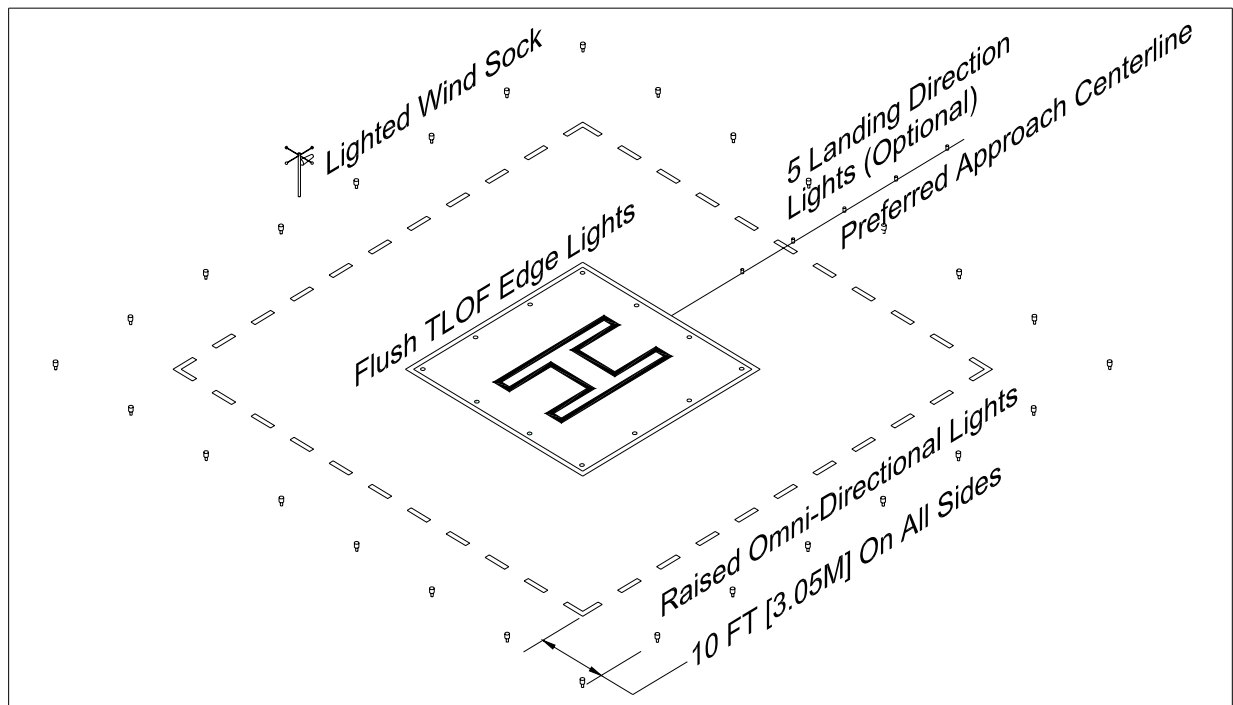
**Figure 2-24. Elevated TLOF - Perimeter Lighting:
GENERAL AVIATION**



NOTE:

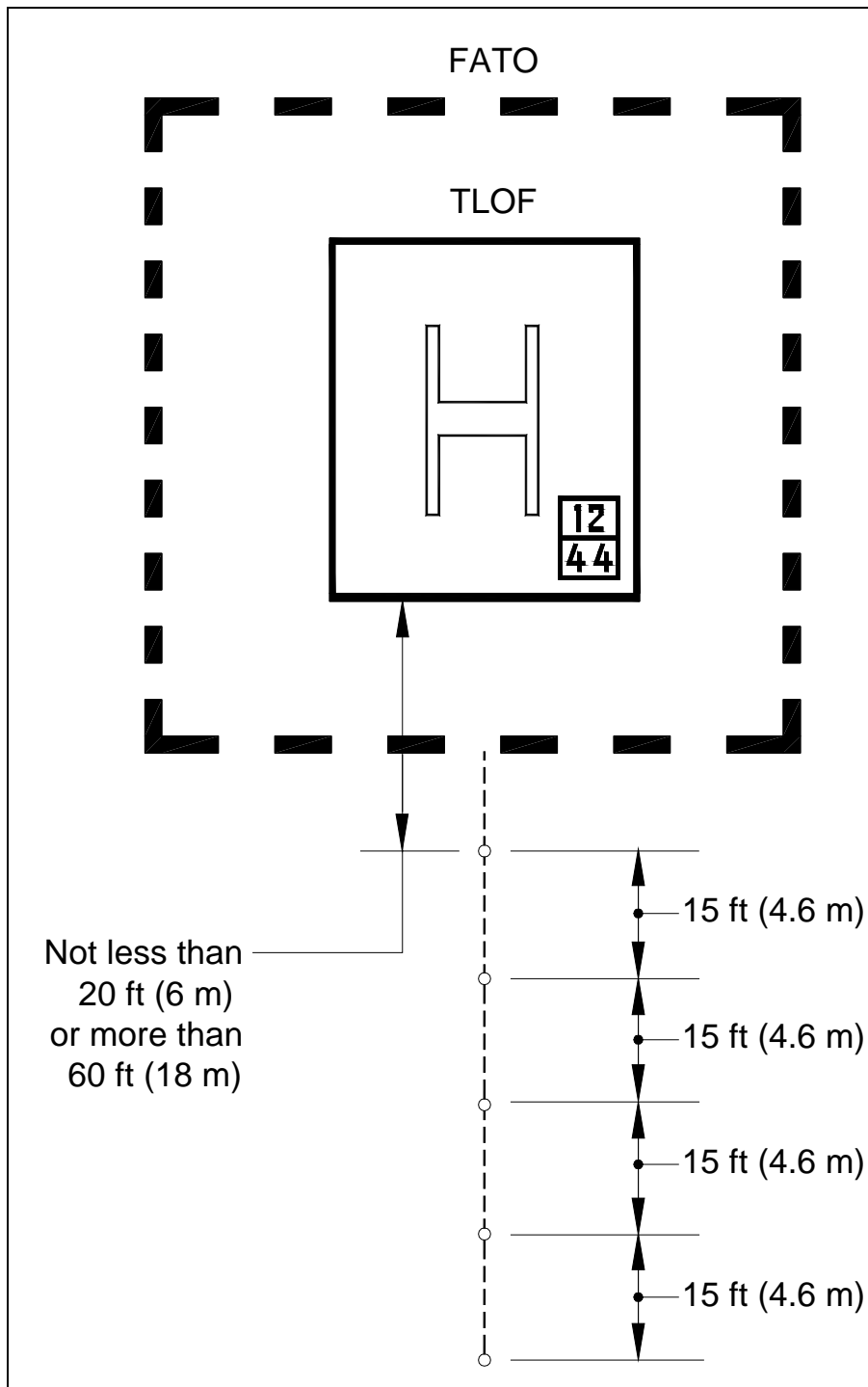
1. Flush FATO and TLOF perimeter lights may be installed inside or outside within 1-foot of the FATO and TLOF respective perimeters.
2. Rotor diameter and weight limitation markings are not shown for simplicity.

**Figure 2-25. FATO/TLOF Flush Perimeter Lighting:
GENERAL AVIATION**

**NOTE:**

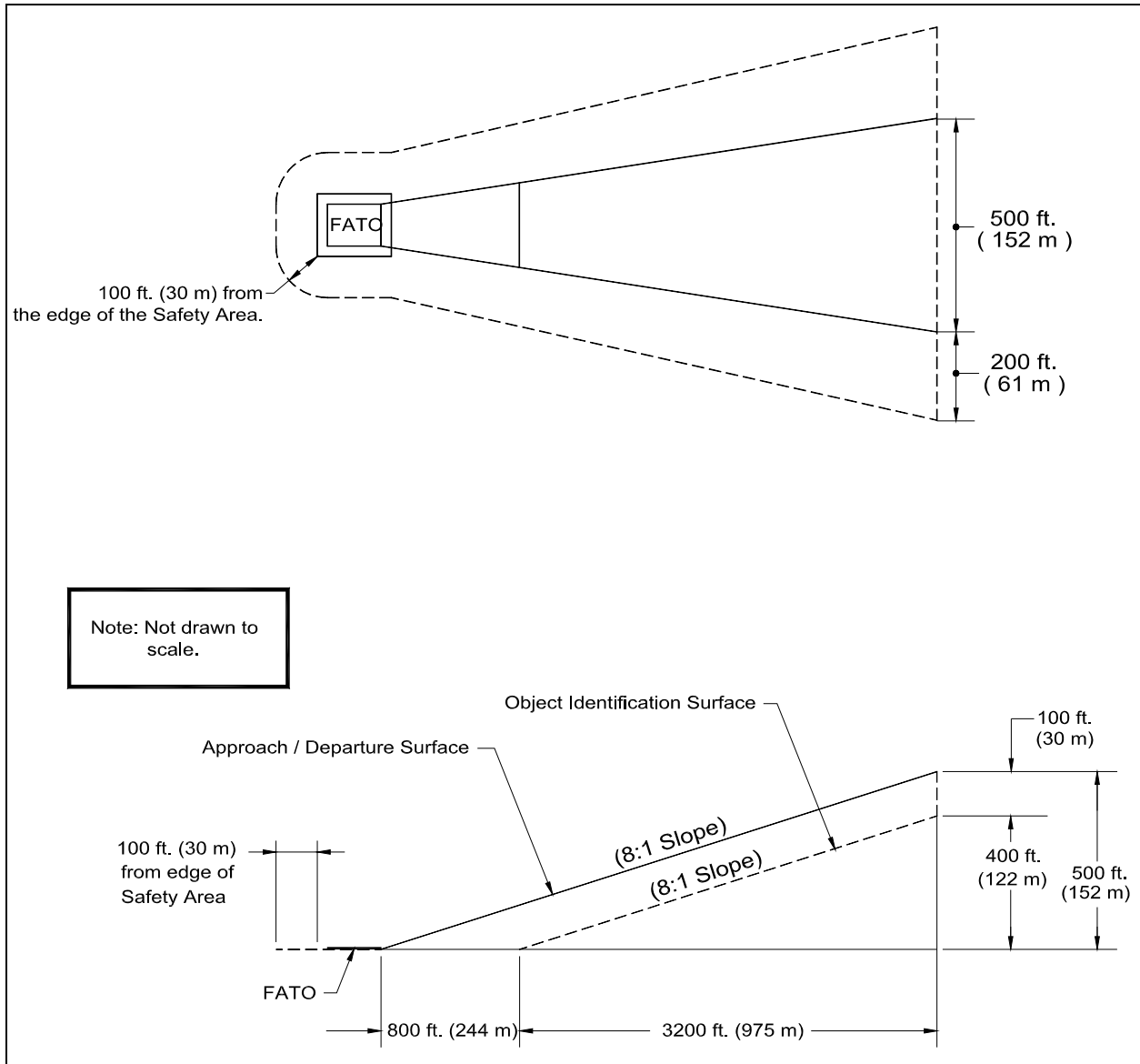
1. Flush TLOF perimeter lights may be installed inside or outside within 1-foot of the TLOF perimeter.
2. Raised FATO lights may be installed 10-feet outside the FATO perimeter.
3. Rotor diameter and weight limitation markings are not shown for simplicity.

**Figure 2-26. TLOF Flush and FATO Raised Perimeter Lighting:
GENERAL AVIATION**



NOTE: Yellow omni-directional lights

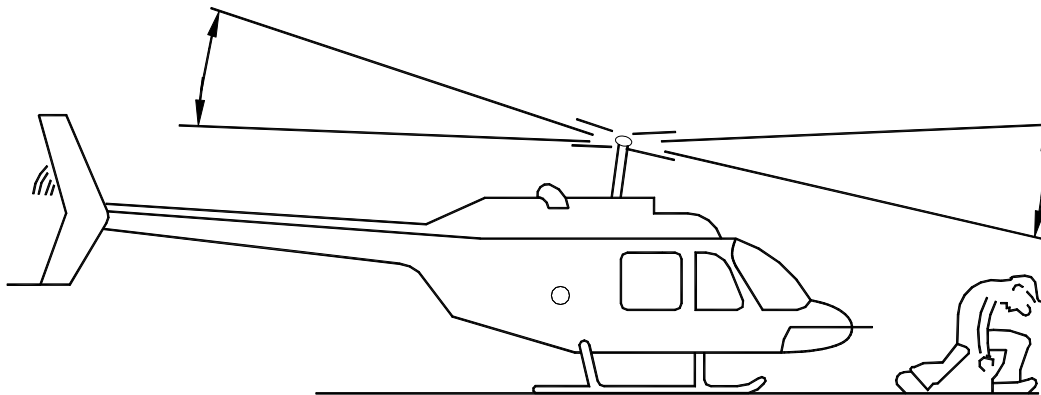
Figure 2-27. Landing Direction Lights:
GENERAL AVIATION



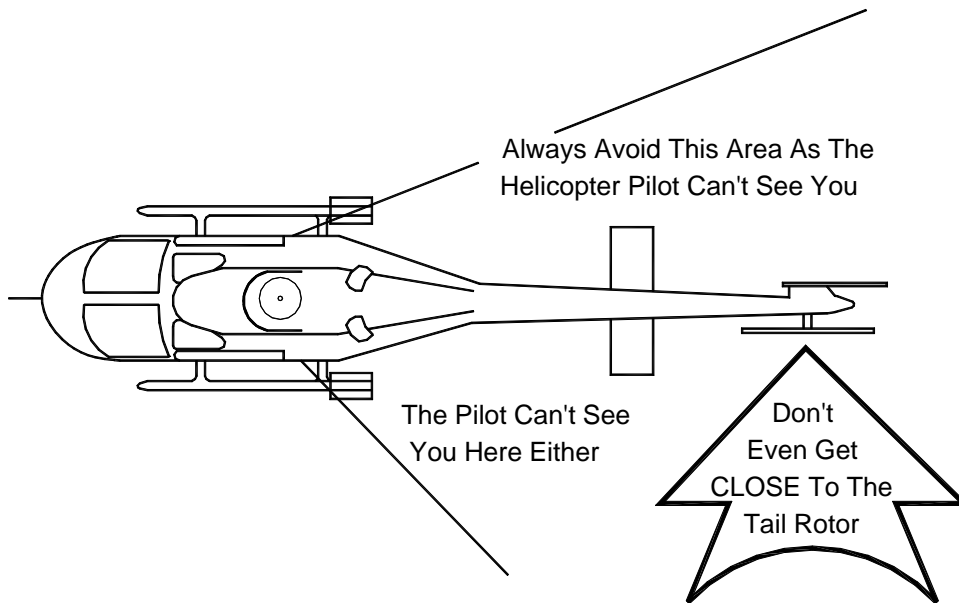
**Figure 2-28. Airspace Where Marking and Lighting are Recommended:
GENERAL AVIATION**

BE ALERT

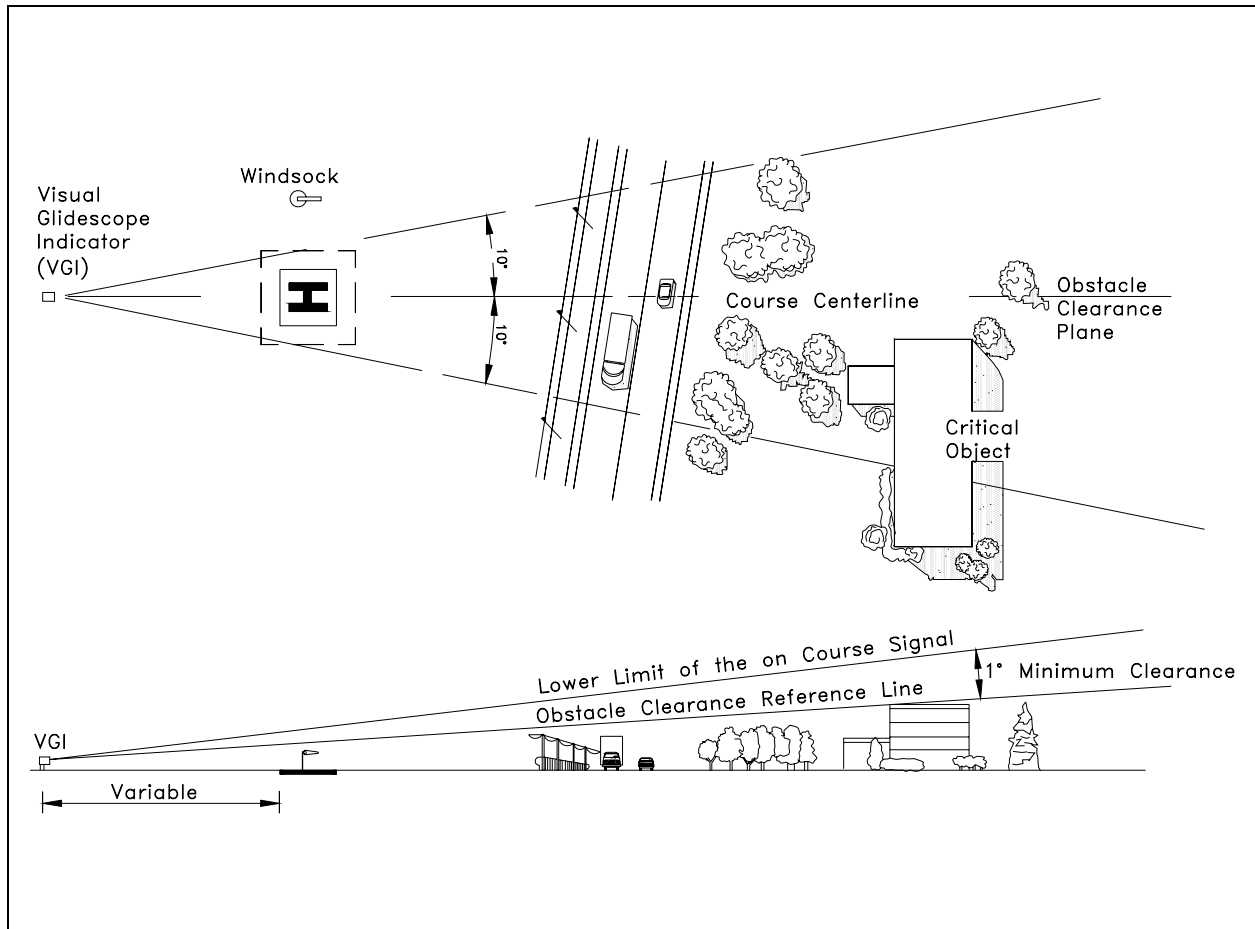
AROUND THE HELICOPTER



Approach And Leave The Helicopter In A Crouched Manner When Rotors Are Turning



**Figure 2-29. Caution Sign:
GENERAL AVIATION**



**Figure 2-30. Visual Glideslope Indicator Siting and Clearance Criteria:
GENERAL AVIATION**

CHAPTER 3. TRANSPORT HELIPORTS

300.GENERAL. A transport heliport is intended to accommodate air carrier operators providing scheduled or unscheduled service with large helicopters. This chapter contains standards and recommendations for designing such a facility. Figure 3-1 illustrates a typical transport heliport.

The heliport consists of a touchdown and lift-off area (TLOF) surrounded by a final approach and takeoff area (FATO). A safety area is provided around the FATO. The relationship of the TLOF to the FATO and the Safety Area is shown in Figure 3-2. A FATO may NOT contain more than one TLOF.

a. Appropriate approach/ departure airspace, to allow safe approaches to and departures from landing sites is required. See Paragraph 304.

b. Flight Manual Considerations. Where helicopter flight manuals specify the minimum size required for operations in intended at the facility, the size should be taken into account in the design of the facility.

c. Heliport Site Selection. Public agencies and others planning to develop a transport heliport are encouraged to select a site capable of supporting both instrument operations and future expansion.

d. When a heliport is served by aircraft with seats for more than 30 passengers, the heliport operator is required to have an FAA certificate issued under 14 CFR Part 139, Certification and Operations: Land Airports Serving Certain Air Carriers. A Part 139 certificate is also required if any Part 121 Operating Requirements; Domestic, Flag and Supplemental Operations passenger operations are to be conducted at the heliport.

NOTE: *If tiltrotor operations are contemplated, criteria in AC 150/5390-3, Vertiport Design, are applicable.*

NOTE: *The design recommendations given in this Chapter are based on the presumption that there will never be more than one helicopter within the FATO and the associated safety area. If there is a need for more than one TLOF at a heliport, each TLOF should be located within its own FATO and within its own Safety Area.*

301.TOUCHDOWN AND LIFT-OFF AREA (TLOF).

a. TLOF Location. The TLOF of a transport heliport is normally at ground level but may be developed with the TLOF located on a pier or, when carefully planned, on the roof of a building. The TLOF is centered on the major axis of the final approach and takeoff area (FATO).

b. TLOF Size.

(1) **Minimum Dimension.** The TLOF should be a square or rectangular surface whose minimum length and width should be 1.0 times the rotor diameter (RD) of the design helicopter but not less than 50 feet (15.2 m).

(2) **Elongated TLOF:** An elongated TLOF can provide an increased safety margin and greater operational flexibility. An elongated TLOF may contain a landing position located in the center and two takeoff positions located at either end as illustrated in Figure 3-3. The landing position should have a minimum length of 1.0 times the RD of the design helicopter.

NOTE: *If an elongated TLOF is provided an elongated FATO will also be required. See Figure 3-3.*

c. Ground-level TLOF Surface Characteristics. The entire TLOF should be load bearing. The TLOF should be capable of supporting the dynamic loads of the design helicopter (Paragraph 806b). The TLOF should be constructed of Portland Cement Concrete (PCC). (An asphalt surface is not recommended.) The pavement should have a broomed surface that provides a skid-resistant surface for helicopters and non-slippery footing for people.

d. Rooftop and Other Elevated TLOFs. Elevated TLOFs and any supporting TLOF structure should be capable of supporting the dynamic loads of the design helicopter (Paragraph 806b).

(1) **TLOF Surface Characteristics.** Rooftop and other elevated heliport TLOFs should be constructed of metal or concrete (or other materials subject to local building codes). TLOF surfaces

should have a broomed pavement or other roughened finish that provides a skid-resistant surface for helicopters and non-slippery footing for people.

e. TLOF Gradients. Recommended TLOF gradients are defined in Chapter 8.

302.FINAL APPROACH AND TAKEOFF AREA. A transport heliport should have at least one FATO. The FATO should contain a TLOF within its borders at which arriving helicopters terminate their approach, and from which departing helicopters take off.

a. FATO Location. The FATO of a transport heliport is normally at ground level but may be developed on a pier or, when carefully planned, on the roof of a building.

b. FATO Size. FATOs are rectangular surfaces with the long axis aligned with the preferred flight path. See Paragraph 304.

(1) **FATO Width.** The minimum width of a FATO should be at least 2.0 RD but not less than 100 feet (30.5 m).

(2) **FATO Length.** The minimum length of the FATO should be 2.0 RD but not less than 200 feet (61 m). At elevations well above sea level, a longer FATO can provide an increased safety margin and greater operational flexibility. The additional FATO length that should be used is depicted in Figure 3-4.

(3) The minimum distance between the TLOF perimeter and the FATO perimeter should be not less than the distance $[0.5 \times (1.5 \text{ OL} - 1 \text{ RD})]$, where OL is the overall length and RD is the RD of the design helicopter.

c. FATO Surface Characteristics. The entire FATO should be load bearing capable of supporting dynamic loads of the design helicopter. (See paragraph 806b). If it is unpaved, the FATO should be treated to prevent loose stones and any other flying debris caused by rotor wash. The portion of the FATO abutting the TLOF should be continuous with the TLOF and the adjoining edges should be at the same elevation.

d. Rooftop and Other Elevated FATOs. Elevated FATOs and any FATO supporting structure should be capable of supporting the dynamic loads of the design helicopter (Paragraph 806b).

(1) **Elevation.** The FATO should be elevated above the level of any obstacle, in the Safety Area, that can not be removed. (Exception: This does not apply to frangibly mounted objects that, due to their function, must be located within the Safety Area (see paragraph 303d).)

(2) **Obstructions.** Elevator penthouses, cooling towers, exhaust vents, fresh air vents, and other raised features can impact heliport operations. Helicopter exhausts can impact building air quality if the heliport is too close to fresh air vents. These issues should be resolved during facility design. In addition, control mechanisms should be established to ensure that obstruction hazards are not installed after the heliport is operational.

(3) **FATO Surface Characteristics.** Rooftop and other elevated heliport FATOs should be constructed of metal or concrete (or other materials subject to local building codes). FATO surfaces should have a non-slippery footing for people.

(4) **Safety Net.** When the FATO is on a platform elevated more than 30 inches (76 cm) above its surroundings, a safety net, not less than 5 feet (1.5 m) wide, should be provided. A railing or fence should not be used since it would be a safety hazard during operations. The safety net should have a load-carrying capability of 50 lb/ft² (244 kg/m²). The net, as illustrated in Figure 3-20, should not project above the level of the FATO. Both the inside and outside edges of the safety net should be fastened to a solid structure.

(5) **Ramp Access.** Heliports should provide access to and from the FATO via a ramp in order to accommodate individuals with disabilities. OSHA requires two separated access points for an elevated FATO. For a transport heliport, ramp access should be provided at both points. If stairs are used as a third access point, they should be built in compliance with regulations 29 CFR 1910.24. However, inside the FATO, any handrails should not extend above the elevation of the TLOF.

(6) **Ramp Design.** The ramp surface should provide a slip-resistant surface. The slope of the ramp should be no steeper than 12:1 (12 units horizontal in 1 unit vertical). The width of the ramp should be not less than 6 feet (1.8 m) wide. The ramp should be built in compliance with state and local requirements and with regulations Appendix A of 49 CFR Part 37, Transportation Services for Individuals with Disabilities, Section 4.8. However, inside the FATO, any handrails should not extend above the elevation of the TLOF. There should be a

safety net on the edges of the ramp where a handrail complying with Appendix A of 49 CFR 37, Section 4.8 is not provided.

e. Mobile Objects Within the FATO and the Safety Area. The FATO/Safety Area design recommendations of this AC are based on the assumption that the TLOF is closed to other aircraft if a helicopter or other mobile object is within the FATO or the associated Safety Area.

f. FATO/FATO Separation. If a heliport has more than one FATO, the separation between the perimeters of two FATOs should be such that the respective Safety Areas do not overlap. This separation is based on the assumption that simultaneous approach/ departure operations will not take place.

NOTE: *If simultaneous operations are planned, greater separation will be required.*

g. FATO Gradients. Recommended FATO gradients are defined in Chapter 8.

303.SAFETY AREA. A Safety Area surrounds a FATO and should be cleared of all obstacles except small, frangible objects that, because of their function, must be located there.

a. Safety Area Width. A Safety Area should extend outward on all sides of the FATO for a distance not less than 30 feet (9 m).

b. IFR Safety Area Width. RESERVED.

c. Mobile Objects Within the Safety Area. See paragraph 302e.

d. Fixed Objects Within a Safety Area. No fixed object should be permitted within a Safety Area except for frangibly mounted objects that, due to their function, must be located there. Those objects whose functions require them to be located within the Safety Area should not exceed a height of 8 inches (20 cm) above the elevation of the FATO perimeter nor penetrate the approach/ departure surfaces or transitional surfaces.

e. Safety Area Surface. This Safety Area need not be load bearing. Figure 3-5 depicts a Safety Area extending over water. If the Safety Area is load bearing, the portion abutting the FATO should be continuous with the FATO and the adjoining edges should be at the same elevation. This is needed to avoid the risk of catching a helicopter skid or wheel.

The Safety Area should be treated to prevent loose stones and any other flying debris caused by rotor wash.

f. Safety Gradients. Recommended Safety Area gradients are defined in Chapter 8.

304.VFR APPROACH/ DEPARTURE PATHS.

The purpose of approach/ departure airspace, is to provide sufficient airspace clear of hazards to allow safe approaches to and departures from landing sites

a. Number of Approach/ Departure Paths.

During approach and departure operations, flight into the wind is the ideal operation condition. Crosswind operations are acceptable within certain limitations. Heliports should be designed so pilots can choose an approach/ departure path that avoids downwind conditions and crosswind operations are kept to a minimum. To accomplish this under varying wind conditions, a heliport should have more than one approach/ departure path and the preferred flight approach/ departure path should, to the extent feasible, be aligned with the predominate wind direction. Other approach/ departure paths should be based on the assessment of the prevailing winds or when this information is not available the separation between such flight paths should be at least 135 degrees. See Figure 3-6.

b. VFR Approach/ Departure Surfaces. An approach/ departure surface is centered on each approach/ departure path. Figure 3-6 illustrates the approach/ departure and transitional surfaces that should be free of penetrations.

The approach / departure path starts at the edge of the FATO and slopes upward at 8:1 (8 units horizontal in 1 unit vertical) for a distance of 4000 ft (1219 m) where the width is 500 ft (152 m) at a height of 500 ft (152 m) above the elevation of TLOF surface.

The transitional surfaces start from the edges of the FATO parallel to the flight path center line, and from the outer edges of approach/ departure surface, and extend outwards at a slope of 2:1 (2 unit horizontal in 1 units vertical) for a distance of 250 ft (76 m) from the centerline. The transitional surfaces start at the edge of the FATO opposite the approach/ departure surfaces and extends to the end of the approach/ departure surface. See Figure 3-6.

c. Marking and Lighting of Objects that Are Difficult to See. See paragraph 311.

d. Control of Obstructions. Control mechanisms should be established to ensure that obstruction hazards are not introduced after a heliport is operational. Heliport operators should maintain a list of the GPS coordinates and the peak elevation of obstacles in the vicinity of the heliport and its approach and departure paths. Particular attention should be given to any obstacles that need to be marked or lighted. Heliport operators should reexamine obstacles in the vicinity of approach/ departure paths on at least an annual basis. This reexamination should include an appraisal of the growth of trees in close proximity to approach and departure paths. Paragraph 108 provides guidance on how to identify and mitigate hazards to air navigation.

e. Curved VFR Approach/ Departure Paths. VFR approach/ departure paths may curve in order to avoid objects or noise-sensitive areas. (More than one curve in the path is not recommended.) Heliport designers are encouraged to use the airspace above public lands, such as freeways or rivers.

NOTE: *In the next revision of this AC, the FAA intends to provide greater detail on the minimum dimensions of curved approach/ departure airspace.*

305.PROTECTION ZONE. The protection zone is the area under the approach/ departure surface starting at the FATO perimeter and extending out for a distance of 400 feet (122 m), as illustrated in Figure 3-7. The heliport proponent should own or control the property containing the protection zone. This control should include the ability to clear incompatible objects and to preclude the congregation of people.

306.WINDSOCK.

a. Specification. A windsock conforming to AC 150/5345-27, *Specification for Wind Cone Assemblies*, should be used to show the direction and magnitude of the wind. The windsock should provide the best possible color contrast to its background.

b. Windsock Location. The windsock should be located so it provides the pilot with valid wind information in the vicinity of the heliport under all wind conditions.

(1) The windsock should be sited so it is clearly visible to the pilot on the approach path when the helicopter is at a distance of 500 feet (152 m) from the TLOF.

(2) Pilots should be able to see a windsock from the TLOF.

(3) To avoid presenting an obstruction hazard, the windsock should be located outside the Safety Area, and it should not penetrate the approach/ departure or transitional surfaces.

(4) At many landing sites, there may be no single, ideal location for the windsock. At other sites, it may not be possible to site a windsock at the ideal location. Consequently, more than one windsock may be required in order to provide the pilot with all the wind information needed for safe operations.

c. Windsock Lighting. For night operations, the windsock should be internally lighted or externally illuminated to ensure that it is clearly visible.

307.TAXIWAYS AND TAXI ROUTES. Taxiways and taxi routes should be provided for the movement of helicopters from one part of a landing facility to another. They provide a connecting path between the FATO and a parking area. They also provide a maneuvering aisle within the parking area. A taxi route includes the paved taxiway plus the appropriate clearances needed on both sides. The relationship between a taxiway and a taxi route is illustrated in Figure 3-8.

a. Taxiway/Taxi Route Widths. The dimensions of taxiways and taxi routes are a function of helicopter size and type of taxi operations (ground taxi or hover taxi). These dimensions are defined in Table 3-1.

NOTE: *Normally, the requirement for hover taxi dictates the taxiway/taxi route widths. However, when the fleet comprises a combination of large ground taxiing helicopters and smaller air taxiing helicopters, the larger aircraft may dictate the taxiway/taxi route widths. If wheel-equipped helicopters taxi with wheels not touching the surface, the facility should be designed with hover taxiway widths rather than ground taxiway widths.*

b. Taxiway and Taxi Route Markings. The centerline of a taxiway should be marked with a continuous 6- inch wide (15 cm) yellow line. Both edges of the paved portion of the taxiway should be marked with two continuous 6- inch wide (15 cm) yellow lines spaced 6- inches (15 cm) apart. Figure 3-8 illustrates taxiway centerline and edge markings.

c. Taxiway to Parking Position Transition Requirements. Taxiway centerline markings should continue into parking positions and become the parking position centerlines.

d. Surfaces. Taxiways should be paved. The unpaved portions of taxi routes should have a turf cover or be treated in some way to prevent dirt and debris from being raised by a taxiing helicopter's rotor wash.

e. Gradients. Recommended taxiway and taxi route gradients are defined in chapter 8, paragraph 805.

f. Lighting. See paragraph 310.

308.HELICOPTER PARKING. A transport heliport should have a paved apron for parking helicopters. The size of the apron depends upon the number and size of helicopters to be accommodated. Parking positions should be designed to accommodate the full range of helicopter size and weights expected at the facility. Parking positions should support the static loads of the helicopters intended to use the parking area (Paragraph 806a). Separate aprons may be established for specific functions such as passenger boarding, maintenance, and parking of based and transient helicopters.

a. Location. Aircraft parking areas should not lie under an approach/ departure surface. However, aircraft parking areas may lie under the transitional surfaces. The nearest edge of a parking position should be located a minimum of ½ RD but not less than 30 feet (9.1 m) from the edge of a taxi route.

b. Size. Parking position sizes are dependent upon the helicopter size. The clearances between parking positions are dependent upon the type of taxi operations (ground-taxi or hover/ taxi) and the intended paths for maneuvering in and out of the parking position.

(1) If all parking positions are the same size, they should be large enough to accommodate the largest helicopter that will operate at the heliport.

(2) When there is more than one parking position, the facility may be designed with parking positions of various sizes with at least one position that will accommodate the largest helicopter that will operate at the heliport. Other parking positions may be smaller, designed for the size of the individual or range of individual helicopters planned to be parked at that position.

(3) The rotor diameter of the largest helicopter that the parking position is designed to accommodate should be marked (see paragraph 308c(2)).

(4) "Turn-around" parking positions should be designed as illustrated in Figure 3-9. Details of the recommended parking position marking are shown in Figure 3-10.

(5) "Taxi-through" parking positions should be designed as illustrated in Figure 3-11.

(6) "Back-out" parking positions are NOT recommended at transport heliports.

NOTE: *Heliport parking areas should be designed to allow helicopters to be parked in a direction that keeps tail rotors as far from passenger walkways as possible.*

c. Helicopter Parking Position Marking. Helicopter parking positions should have the following markings:

(1) A 12-inch wide (30 cm) solid yellow, painted line defining a circle of 1.0 RD of the largest helicopter that will park at that position (see Figure 3-12).

(2) The maximum rotor diameter of the largest helicopter that the position is designed to accommodate is indicate (e.g., 49) by numerals. This marking should be in yellow characters, clearly visible, and at least 3 feet (0.9 m) high. (See Figs. 3-12, and Appendix Figure A3-1).

(3) A 12-inch (30 cm) wide, solid yellow, painted centerline marking (see Figure 3-12).

(4) A 12-inch-wide (30-cm) extended centerline that the pilot can see when positioned in the center of the parking position. This should be a solid yellow painted line for a "taxi-through" parking position (see Figure 3-11). If the parking position will not accommodate taxi-through operations, this extended centerline should be a dashed yellow, painted line (see Figs. 3-10 and 3-12). The purpose of the extended centerline is to provide the pilot with better visual guidance during parking maneuvers.

(5) A 6-inch wide (15 cm) solid yellow shoulder line, perpendicular to the centerline, should be located so that it is under the pilot's shoulders when the main rotor of the largest helicopter for which the position is designed will be entirely within

the 1.0 RD parking circle (see Figure 3-12). This shoulder line should extend far enough from the parking position centerline so the pilot can see it on both sides of the helicopter.

(6) Parking position identifications (numbers or letters) should be marked if there is more than one parking position. These markings should be yellow characters that are clearly visible and 3 feet (0.9 m) high. (See Figs. 3-12, and Appendix Figure A3-1).

(7) A passenger walkway, as illustrated in Figure 3-10, should be clearly marked.

(8) If a parking position has a weight limitation, it should be stated in units of 1,000 pounds, as illustrated in Figure 3-12. (A number 9 indicates a weight-carrying capability of up to 9,000 pounds. Metric equivalents should NOT be used for this purpose.) This marking should be in yellow characters that are clearly visible and 3 feet (0.9 m) high. A bar may be placed under the number to minimize the possibility of being misread. See Figure 3-15, and Appendix Figures A3-1 and A3-2.

d. Passenger Walkways. Passenger movement in operational areas should be restricted to marked walkways. Layout of passenger walkways should minimize the passenger exposure to various risks during passenger loading and unloading. Figure 3-10 illustrates one marking scheme. The pavement should be designed so spilled fuel does not drain onto passenger walkways or toward parked helicopters. Two separated access points are required for elevated TLOFs.

e. Parking Area Size and Clearance Requirements for a Variety of Helicopters (Wheeled and Skid-equipped). The more demanding requirement will dictate what is required at a particular site. Usually, the parking area requirements for skid-equipped helicopters will be the most demanding. However, when the largest helicopter is a very large, wheeled aircraft (e.g., the S-61), and the skid-equipped helicopters are all much smaller, the parking size requirements for wheeled helicopters may be the most demanding. If wheel-equipped helicopters taxi with wheels not touching the surface, parking areas should be designed based on hover taxi operations rather than ground taxi operations.

f. Fueling. Helicopter fueling is typically accomplished with the use of a fuel truck or the use of a specific fueling area with stationary fuel tanks.

(1) Systems for storing and dispensing fuel must conform to Federal, state, and local requirements for petroleum handling facilities. Guidance is found in AC 150/5230-4, *Aircraft Fuel Storage, Handling, and Dispensing on Airports*, and in appropriate National Fire Protection Association (NFPA) 403, *Standard for Aircraft Rescue and Fire Fighting Services at Airports*, and NFPA 418, *Standards for Heliports*.

(2) Fueling locations should be designed and marked to minimize the potential for helicopters to collide with the dispensing equipment. Fueling areas should be designed so there is no object tall enough to be hit by the main or tail rotor blades within a distance of 1.0 times the Overall Length (OL) from the center point of the position where the helicopter would be fueled. If this is not practical at an existing facility, long fuel hoses should be installed.

(3) **Lighting.** The fueling area should be lighted if night fueling operations are contemplated. Care should be taken to ensure that any light poles do not constitute an obstruction hazard.

g. Tie-Downs. Recessed tie-downs should be installed to accommodate extended or overnight parking of based or transient helicopters. Caution should be exercised to ensure that any depression associated with the tie-downs should not have a diameter greater than one-half the width of the smallest helicopter landing wheel or landing skid anticipated to be operated on the heliport surface. In addition, tie-down chocks, chains, cables, and ropes should be stored off the heliport surface to avoid fouling landing gear. Guidance on tie-downs can be found in AC 20-35.

h. Taxiway-to-Parking-Position Transition Requirements. See paragraph 308c.

309. HELIPORT MARKERS AND MARKINGS. Markers and/or surface markings should identify the facility as a heliport. Surface markings may be paint, reflective paint, or preformed material. Lines/markings may be outlined with a 6-inch wide (15 cm) line of a contrasting color to enhance conspicuity. The following markers and markings should be used.

a. TLOF and FATO Perimeter Markings. The perimeter of the TLOF and the FATO should be defined with markers and/or lines.

(1) TLOFs. The perimeter of a TLOF should be defined with a continuous 12-inch wide (30 cm), white line, as shown in Figure 3-13 and Figure 3-14. The perimeter of an unpaved TLOF should be defined with a series of 12-inch-wide (30 cm) flush, in-ground markers, each approximately 5 feet (1.5 m) in length with end-to-end spacing of not more than 6 inches (15 cm).

(2) Unpaved FATOs. The perimeter of an unpaved FATO should be defined with 12-inch wide (30 cm), flush in-ground markers. The corners of the FATO should be defined and the perimeter markers should be 12 inches in width, approximately 5 feet (1.5 m) in length, and with end-to-end spacing of approximately 5 feet (1.5 m). (See Figure 3-13).

(3) Paved FATOs. The perimeter of a paved FATO should be defined with a 12-inch wide (30 cm) dashed white line. The corners of the FATO should be defined and the perimeter marking segments should be 12 inches in width, approximately 5 feet (1.5 m) in length, and with end-to-end spacing of approximately 5 feet (1.5 m). See Figure 3-14.

b. Standard Identification Marking. The standard identification marking is intended to identify the location as a heliport, to mark the TLOF, and to provide visual cues to the pilot. A white "H" marking should mark the TLOF. The proportions and layout of the letter H are illustrated in Figure 3-15. The height of the H is limited to 75 feet (22.9m). The H should be oriented on the axis of the preferred approach/ departure path. A bar may be placed under the H when it is necessary to distinguish the preferred approach/ departure direction. Arrows and/or landing direction lights (see paragraph 310e) may also be used to indicate one or more preferred approach/ departure paths.

c. Taxiway and Taxi Route Markings. See paragraph 307.

d. Apron Markings. In addition to the taxiway and parking position markings, the yellow (double) taxiway edge lines should continue around the apron to define its perimeter. Figures 3-9 and 3-11 illustrate apron markings.

e. Parking Position Markings. See paragraph 307.

f. Closed Heliport. All markings of a permanently closed heliport, FATO, or TLOF should be obliterated. If it is impractical to obliterate

markings, a yellow X should be placed over the H, as illustrated in Figure 3-16. The yellow X should be large enough to ensure early pilot recognition that the heliport is closed. The windsock(s) and other visual indications of an active heliport should also be removed.

g. TLOF Size Limitations. The TLOF should be marked to indicate the rotor diameter of the largest helicopter for which it is designed as indicated in Figure 3-15. (The rotor diameter should be given in feet. Metric equivalents should NOT be used for this purpose.) This marking should be centered in the lower section of a TLOF size/weight limitation 'box'. The numbers should be 5 ft (1.5 m) high (see Appendix A Figure A3-1). The numbers should be black with a white background. When viewed from the preferred approach direction, this TLOF size/weight limitation 'box' should be located on the TLOF in the lower right-hand corner, or the on right-hand side of the H of a circular TLOF.

h. Elevated TLOF Weight Limitations. If a TLOF has limited weight-carrying capability, it should be marked with the maximum takeoff weight of the design helicopter, in units of thousands of pounds as indicated in Figure 3-15 (A numeral 21 indicates a weight-carrying capability of up to 21,000 pounds. Metric equivalents should NOT be used for this purpose.) This marking should be centered in the upper section of a TLOF size/weight limitation 'box'. The numbers should be 5 ft (1.5 m) high (see Appendix A Figure A3-2). The numbers should be black with a white background. If the TLOF does not have a weight limit, a diagonal line, extending from the lower left hand corner to the upper right hand corner, should be added to the upper section of the TLOF size/weight limitation 'box'. (See Figure 3-15) When viewed from the preferred approach direction, this TLOF size/weight limitation 'box' should be located on the TLOF in the lower right-hand corner.

i. Equipment/Object Marking. Heliport maintenance and servicing equipment, as well as other objects used in the airside operational areas, should be made conspicuous with paint, reflective paint, reflective tape, or other reflective markings. Particular attention should be given to marking objects that are hard to see in marginal visibility, such as at night, heavy rain, or in fog.

j. Marking Obstructions Outside the Approach/ Departure Airspace. See paragraph 311.

k. Marking Proportions. See Appendix 3 for guidance on the proportions of painted numbers.

310.HELIPORT LIGHTING. For night operations, the TLOF, the FATO, taxiways, taxi routes, and the windsock need to be lighted. AC 150/5340-28, *Low Visibility Taxiway Lighting System*; AC 150/5340-24, *Runway and Taxiway Edge Lighting System*; and AC 150/5345-46, *Specification for Runway and Taxiway Light Fixtures*, contain technical guidance on lighting equipment and installation details. Heliport lighting ACs are available at <http://faa.gov/arp>.

a. Ground-level TLOF Perimeter Lights. Flush green lights should define the TLOF perimeter. A minimum of four flush light fixtures is recommended per side of a square or rectangular TLOF. A light should be located at each corner with additional lights uniformly spaced between the corner lights, with a maximum interval of 25 feet (8 m) between lights. Flush lights should be located within 1 foot (30 cm) inside or outside of the TLOF perimeter. Figures 3-18 and 3-19 illustrate this lighting.

b. Elevated TLOF Perimeter Lights. The TLOF perimeter should be lit with flush green lights located within 1 foot inside or outside of the TLOF edge. If raised omni-directional lights are used they should be located on the outside edge of the TLOF or the outer edge of the safety net as shown in Figure 3-20. The raised lights should not penetrate a horizontal plane at the TLOFs elevation by more than 2 inches (5 cm). In areas where it snows in the winter, the outside edge is the preferred location. (Lights on the outside edge of the TLOF are prone to breakage during snow removal.) Lighting on the outside edge also provides better visual cues to pilots at a distance from the heliport since they outline a larger area.

c. Optional TLOF Lights. An optional feature is a line of 7 white, flush L-850A lights spaced at 5-foot (1.5 m) intervals installed in the TLOF pavement. These lights are aligned on the centerline of the approach course to provide close-in directional guidance and improve TLOF surface definition. These lights are illustrated in Figure 3-17.

d. Ground FATO Perimeter Lights. Green lights should define the limits of the FATO. A light should be located at each corner with additional lights uniformly spaced between the corner lights with a maximum interval of 25 feet (8 m) between

lights. A circular pattern of FATO perimeter lights is not recommended.

(1) If flush lights are used, they should be located within 1 foot (30 cm) inside or outside of the FATO perimeter. (See Figure 3-18).

(2) If raised light fixtures are used, they should be no more than 8 inches (20 cm) high, should be located 10 feet (3 m) out from the FATO perimeter, and should not penetrate a horizontal plane at the FATO elevation by more than 2 inches (5 cm). See Figure 3-19.

e. Elevated FATO-Perimeter Lights. The FATO perimeter should be lit with green lights. If flush lights are used, they should be located within 1 foot (inside or outside) of the FATO edge. If raised omni-directional lights are used, they should be located on the outside edge of the FATO or outside edges of the safety net, as shown in Figure 3-20. The raised lights should not penetrate a horizontal plane at the FATO/TLOF elevation. In areas where it snows in the winter, the outside edge is the preferred location. (Lights on the inside edge of the safety net are prone to breakage during snow removal.) Lighting on the outside edge also provides better visual cues to pilots at a distance from the heliport since they outline a larger area.

f. Landing Direction Lights. Landing direction lights are an optional feature to be installed when it is necessary to provide directional guidance. Landing direction lights are a configuration of five yellow, omni-directional L-861 lights on the centerline of the preferred approach/ departure path. These lights are spaced at 15-foot (4.6 m) intervals beginning at a point not less than 30 feet (9 m) and not more than 60 feet (18 m) from the TLOF perimeter and extending outward in the direction of the preferred approach/ departure path, as illustrated in Figure 3-21.

g. Taxiway and Taxi Route Lighting. Flush green lights define taxiway centerlines. Blue omni-directional lights define the edges of the taxiway.

(1) Taxiway Centerline Lights. Taxiway centerlines are defined with flush L-852A bi-directional lights for straight segments and L852B lights for curved segments. These lights should be spaced at 50-foot (15 m) longitudinal intervals on straight segments and at 25-foot (7.5 m) intervals on curved segments with a minimum of four lights

needed to define the curve. Retroreflective markers are NOT recommended.

(2) Taxiway Edge Lights. Flush L-861T omni-directional blue lights should be used to mark the edges of a paved taxiway. These lights should be spaced at 50-foot (15 m) longitudinal intervals on straight segments and at 25-foot (7.5 m) intervals on curved segments with a minimum of four lights needed to define the curve. Retroreflective markers are NOT recommended.

h. Heliport Identification Beacon. A heliport identification beacon should be installed. The beacon, flashing white/green/yellow at the rate of 30 to 45 flashes per minute, should be located on or close to the heliport. Guidance on heliport beacons is found in AC 150/5345-12, *Specification for Airport and Heliport Beacon*.

i. Floodlights. Floodlights may be used to illuminate the parking apron. To eliminate the need for tall poles, these floodlights may be mounted on adjacent buildings. Care should be taken, however, to place floodlights clear of the TLOF, the FATO, the Safety Area, and the approach/ departure surfaces and any required transitional surfaces. Care should be taken to ensure that floodlights and their associated hardware do not constitute an obstruction hazard. Floodlights should be aimed down and provide a minimum of 3-foot candles (32 lux) of illumination on the apron surface. Floodlights that might interfere with pilot vision during takeoff and landings should be capable of being turned off.

j. Lighting of Obstructions. See paragraph 311.

k. Heliports at Airports. When a heliport on an airport is sited in close proximity to a taxiway, there may be a concern that the green taxiway centerline lights could be confused with the TLOF or FATO perimeter lights. In such cases, yellow lights may be used as an alternative color for marking the TLOF and the FATO.

311.MARKING AND LIGHTING OF OBSTRUCTIONS. The marking and lighting of obstructions within the approach/ departure airspace is discussed in paragraph 108b(3). This paragraph discusses the marking lighting of obstructions in close proximity but outside the approach/ departure airspace.

a. Background. Unmarked wires, antennas, poles, cell towers, and similar objects are often

difficult to see, even in the best daylight weather, in time for a pilot to successfully take evasive action. While pilots can avoid such objects during en route operations by flying well above them, approaches and departures require operation near the ground where obstacles may be in close proximity.

b. Airspace. If difficult-to-see objects penetrate the object identification surfaces illustrated in Figure 3-22, these objects should be marked to make them more conspicuous. If operations are conducted at a heliport between dusk and dawn, these difficult-to-see objects should be lighted. Guidance on marking and lighting objects is contained in AC 70/7460-1, *Obstruction Marking and Lighting*. The object identification surfaces in Figure 3-22 can also be described as follows:

(1) In all directions from the Safety Area except under the approach/ departure paths, the safety surface starts at the Safety Area perimeter and extends out horizontally a distance of 100 feet (30 m).

(2) Under the approach/ departure surface, the object identification surface starts from the outside edge of the FATO and extends horizontally out for a distance of 800 feet (244 m). From this point, the object identification surface extends out for an additional distance of 3,200 feet (975 m) while rising on a 8:1 slope (8 unit horizontal in 1 units vertical). From the point 800 feet (244 m) from the FATO perimeter, the object identification surface is 100 feet (30.5 m) beneath the approach/ departure surface.

(3) The width of the object identification surface increases as a function of distance from the Safety Area. From the Safety Area perimeter, the object identification surface extends laterally to a point 100 feet (30 m) outside the Safety Area perimeter. At the upper end of the surface, the object identification surface extends laterally 200 feet (61 m) on either side of the approach/ departure path.

c. Shielding of Objects. If there are a number of obstacles in close proximity, it may not be necessary to mark all of them if they are shielded. To meet the shielding guidelines a object would be shielded by existing structures of a permanent and substantial character or by natural terrain or topographic features of equal or greater height, and would be located in the congested area of a city, town, or settlement where it is evident beyond all reasonable doubt that the structure so shielded will not adversely affect safety in air navigation.

Additional guidance on this topic may be found in 14 CFR Part 77.15(a), Construction or alterations not requiring notice.

312.SAFETY CONSIDERATIONS.

Some safety enhancements to be considered in the design of a heliport are discussed below. Other areas such as the effects of rotor downwash may need to be addressed based on site conditions and the design helicopter.

a. Security. The operational areas of a heliport need to be kept clear of people, animals, and vehicles.

(1) **Safety Barrier.** At ground-level transport heliports, the heliport owner or operator should erect a safety barrier around the helicopter operational areas. This barrier may take the form of a fence or a wall. It should be no closer to the operation areas than the outer perimeter of the Safety Area. Barriers should not penetrate any approach/ departure (primary or transitional) surface. Thus, in the vicinity of the approach/ departure paths, the barrier may need to be well outside the outer perimeter of the Safety Area.

(2) Any barrier should be high enough to present a positive barrier to persons inadvertently entering an operational area and yet low enough to be non-hazardous to helicopter operations.

(3) Access to airside areas should be through controlled and locked gates and doors. Gates and doors should display a cautionary sign similar to that illustrated in Figure 3-23.

b. Rescue and Fire Fighting Services. State and local rescue and fire fighting regulations vary. Heliports should meet the criteria of NFPA Pamphlet 418, Standards for Heliports, and NFPA Pamphlet 403, Standard for Aircraft Rescue and Fire-fighting Services at Airports. A fire hose cabinet or extinguisher should be provided at each access gate and each fueling location. At elevated TLOF/FATOs, fire hose cabinets, fire extinguishers, and other fire fighting equipment should be located adjacent to, but below the level, of the TLOF/FATO. NFPA standards are available at the NFPA web site <http://www.nfpa.org/catalog/home/index.asp>.

c. Turbulence. Air flowing around and over buildings, stands of trees, terrain irregularities, etc. can create turbulence that may affect helicopter operations. FAA Technical Report FAA/RD-84/25,

Evaluating Wind Flow Around Buildings on Heliport Placement (Reference 41 of Appendix 4 addresses the wind's effect on helicopter operations). The following actions may be taken in selecting a site to minimize the effects of turbulence: The Technical Report is available from the National Technical Information Service (NTIS) web site <http://www.ntis.gov/>.

(1) **Ground-Level Heliports.** Helicopter operations from sites immediately adjacent to buildings trees and other large objects are subjected to air turbulence effects caused by such features. Therefore, locate the landing and takeoff area away from such objects in order to minimize air turbulence in the vicinity of the FATO and the approach/ departure paths.

(2) **Elevated Heliports.** Elevating heliports 6 feet (1.8 m) or more above the level of the roof will generally minimize the turbulent effect of air flowing over the roof edge. While elevating the platform helps reduce or eliminate the air turbulence effects, a safety net may be required (see paragraph 302d (4)).

d. Communications. A UNICOM radio may be used to provide arriving helicopters with heliport and traffic advisory information but may not be used to control air traffic. The Federal Communications Commission (FCC) should be contacted for information on UNICOM licensing.

e. Weather Information. An AWOS measures and automatically broadcasts current weather conditions at the heliport site. When an AWOS is installed, it should be located at least 100 feet (30.5 m) and not more than 700 feet (213 m) from the TLOF perimeter. Locate the AWOS so the instruments will NOT be affected by rotor wash from helicopter operations. Guidance on AWOS systems is found in AC 150/5220-16, *Automated Weather Observing Systems (AWOS) for Non-Federal Applications*.

f. Winter Operations. Swirling snow raised by a helicopter's rotor wash can cause the pilot to lose sight of the intended landing point. Swirling snow on takeoff can hide objects that need to be avoided. At least the TLOF, the FATO, and as much of the Safety Area as practical, should be kept free of snow. Heliport design should take into account the methods and equipment to be used for snow removal. The heliport design should allow the snow to be removed sufficiently so that the snow will not present an obstruction hazard to either the tail rotor or the main rotor. Guidance on winter operations is found

in AC150/5200-30, Airport Winter Safety and Operations. (Exception: In cases where the FATO is much larger than the minimum requirement, it may not be necessary to clear all of this additional area.)

313.VISUAL GLIDESLOPE INDICATORS (VGI). A VGI provides pilots with visual course and descent cues. The lowest on-course visual signal must provide a minimum of 1 degree of clearance over any object that lies within 10 degrees of the approach course centerline.

a. The optimal location of a VGI is on the extended centerline of the approach path at a distance that brings the helicopter to a hover between 3 and 8 feet (0.9 to 2.4 m) above the TLOF. Figure 3-24 illustrates VGI clearance criteria.

b. Control of the VGI. There may be merit in making operation of the visual glideslope indicator controllable from the approaching helicopter to ensure that it is “on” only when required.

c. VGI Needed. At many heliports, a VGI is an optional feature. However, a VGI should be provided if one or more of the following conditions exist, especially at night:

(1) Obstacle clearance, noise abatement, or traffic control procedures require a particular slope to be flown.

(2) The environment of the heliport provides few visual surface cues.

d. Additional Guidance. AC 150/5345-52, *Generic Visual Glideslope Indicators (GVGI)*, and AC 150/5345-28, *Precision Approach Path Indicator (PAPI) Systems*, provide additional guidance.

314.TERMINAL FACILITIES. The heliport terminal requires curbside access for passengers using private autos, taxicabs, and public transit vehicles. Public waiting areas need the usual amenities, and a counter for rental car services may be desirable. Passenger auto parking areas should accommodate current requirements and have the capability of being expanded to meet future requirements. Readily available public transportation may reduce the requirement for employee and service personnel auto parking spaces. The heliport terminal building or sheltered waiting area should be attractive and functional. AC 150/5360-9, *Planning and Design of Airport Terminal Building Facilities at Non-Hub Locations*, contains guidance on designing

terminal facilities. The AC is available at the FAA library web site:

[http://www.airweb.faa.gov/Regulatory and Guidance Library](http://www.airweb.faa.gov/Regulatory_and_Guidance_Library).

Unless screening was carried out at the helicopter passengers’ departure location, Transportation Security Administration regulations may require that a screening area and/or screening be provided before passengers enter the airport’s secured areas. Multiple helicopter parking positions and/or locations may be needed in the terminal area to service helicopter passenger and/or cargo inter connecting needs. Information about passenger screening is available at Transportation Security Administration web site <http://www.tsa.gov/public/>.

315.ZONING AND COMPATIBLE LAND USE.

Where state and local statutes permit, a transport heliport sponsor is encouraged to develop and promote the adoption of the following zoning measures to ensure that the heliport will continue to be available for public use as well as to protect the community’s investment in the facility.

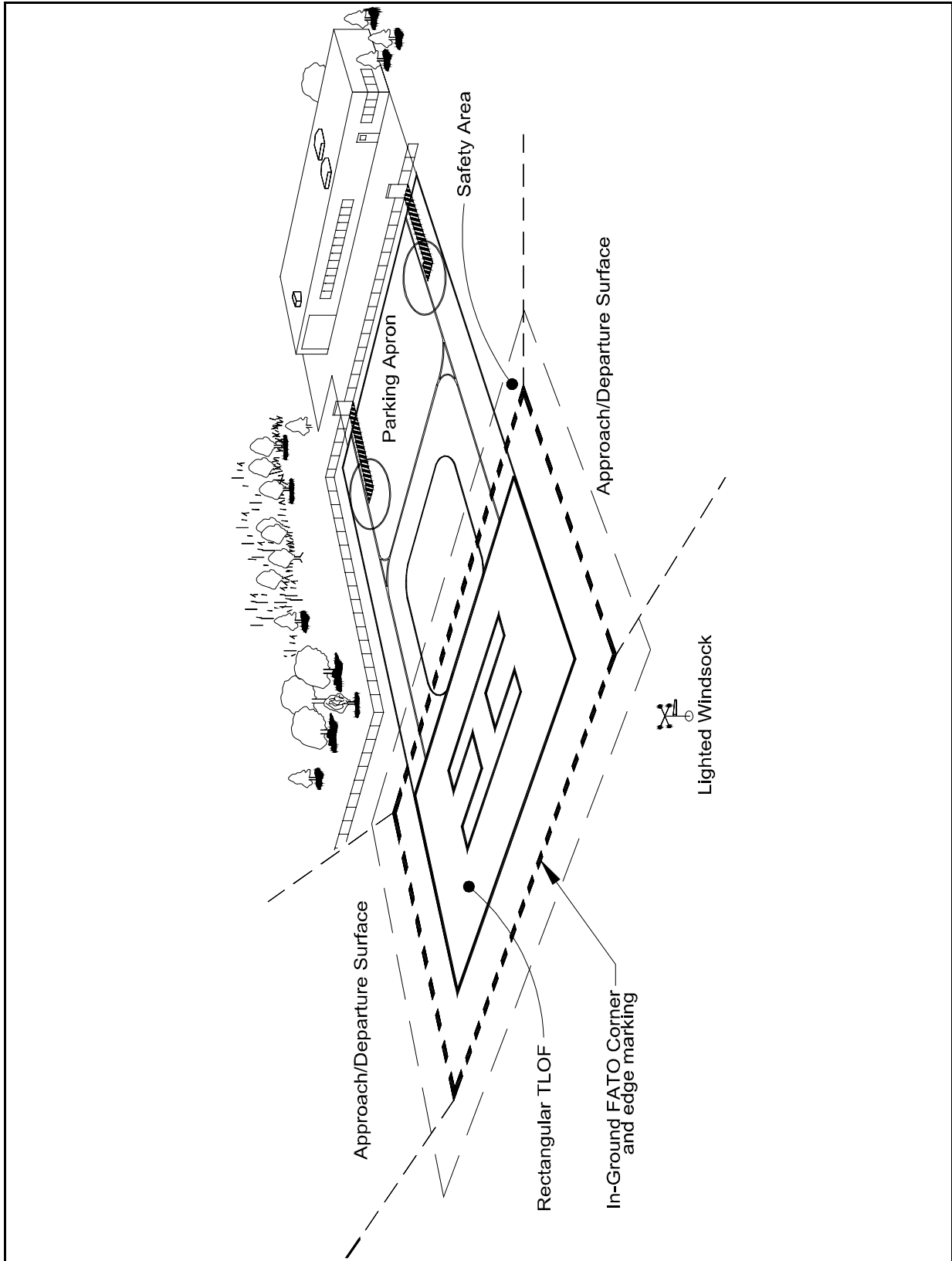
a. Zoning to Limit Building/Object Heights. General guidance on drafting an ordinance that would limit building and object heights is contained in AC 150/5190-4, *A Model Zoning Ordinance to Limit Height of Objects Around Airports*. The locally developed ordinance should substitute the heliport surfaces for the airport surfaces described in model ordinance.

b. Zoning for Compatible Land Use. A zoning ordinance may be enacted, or an existing ordinance modified, to control the use of property within the heliport approach/ departure path environment. The ordinance should restrict activities to those that are compatible with helicopter operations.

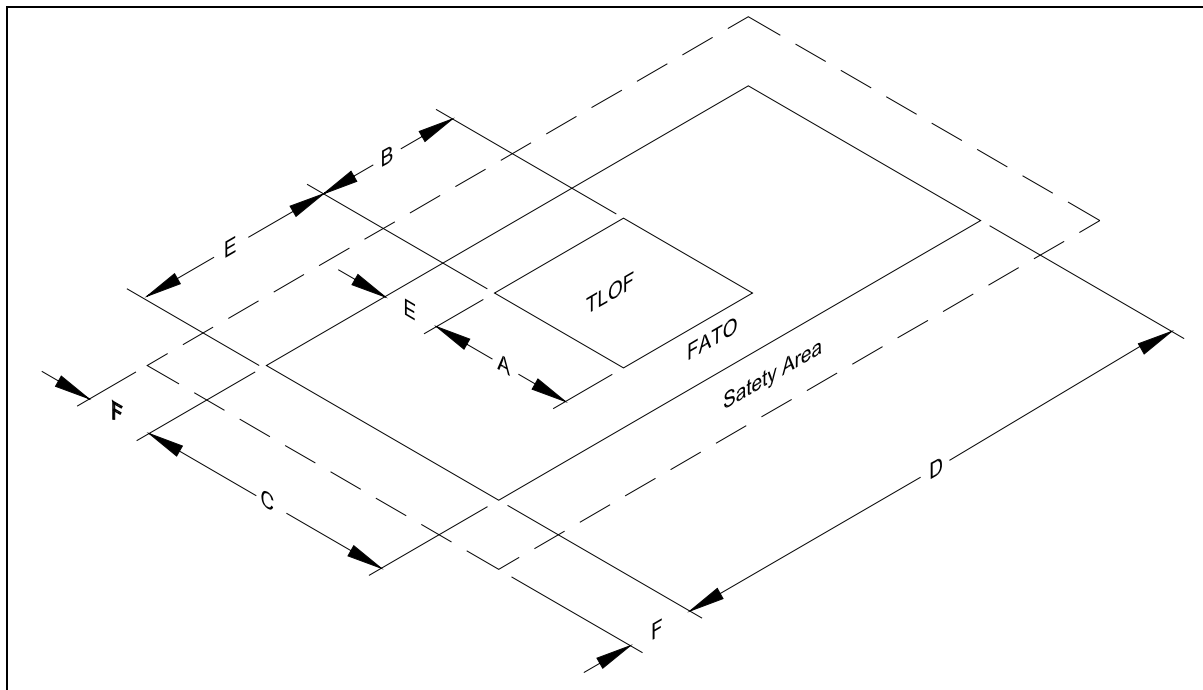
c. Air Rights and Property Easements are options that may be used to prevent the encroachment of obstacles in the vicinity of a heliport.

Table 3-1. Taxiway and Taxi Route Dimensions – Transport Heliports

Taxiway (TW) Type	Centerline Marking Type	TW Edge Marking Type	Minimum Width Of Paved Area	Lateral Separation Between TW Edge Markings	Tip Clearance on Each Side	Total Taxi Route Width
Ground Taxiway	Painted	Painted	2 x UC	2 x UC	10 ft (3 m)	1 RD plus 20 ft (6 m)
Hover Taxiway	Painted	Painted	2 x UC	2 x UC	1/3 RD plus 10 ft (3.m)	RD < 35 ft (11 m): 5/3 RD plus 20 ft (6 m) RD = 35 ft- (11 m): 78.3 ft (24 m) RD > 35 ft (11 m): 2/3 RD plus 55 ft (17 m)
<p>RD: rotor diameter of the design helicopter TW: taxiway UC: undercarriage length or width (whichever is larger) of the design helicopter</p>						



**Figure 3-1. A Typical Transport Heliport:
TRANSPORT**



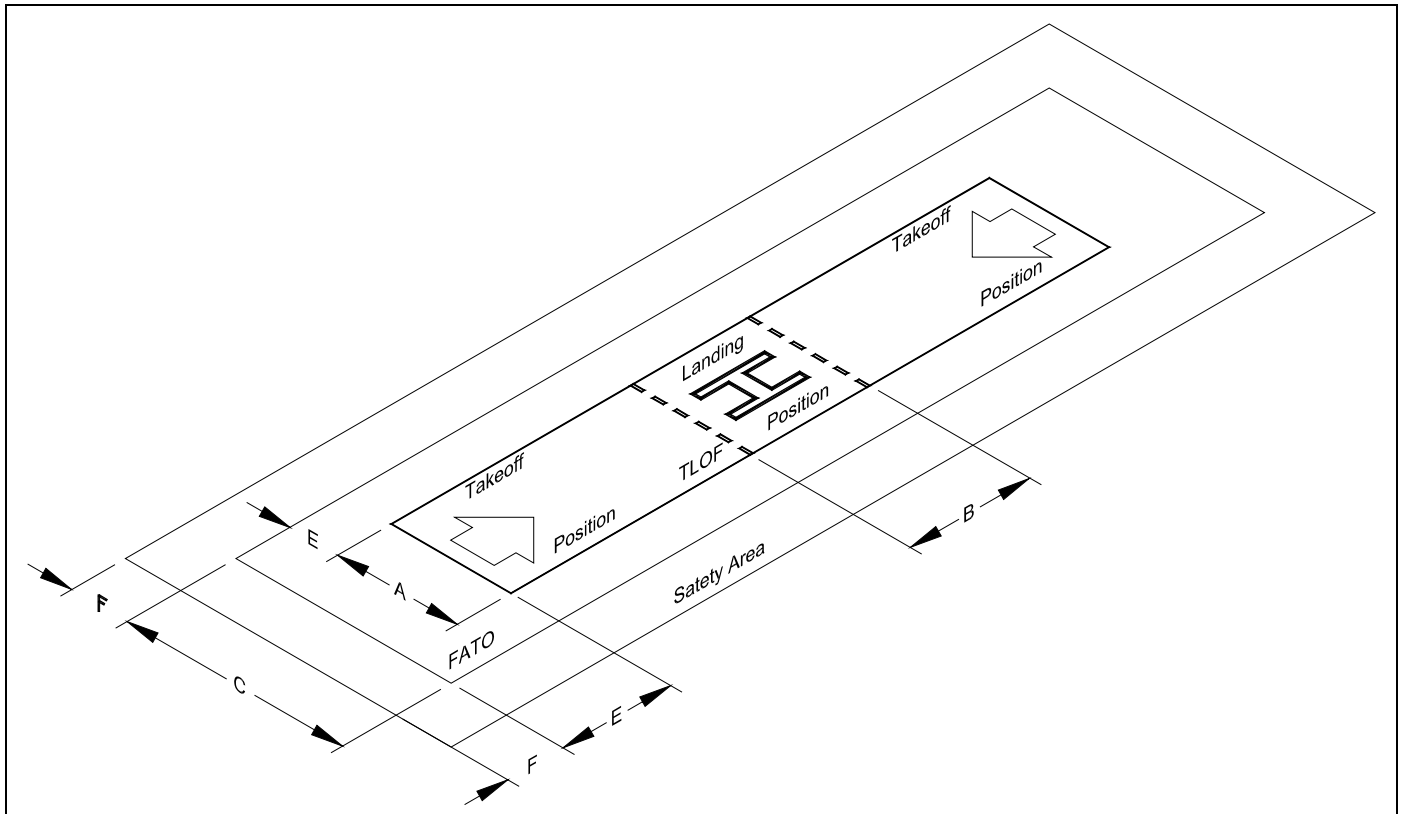
NOT DRAWN TO SCALE

- A. Minimum TLOF Width: 1.0 RD but not less than 50ft (15 m)
- B. Minimum TLOF Length: 1.0 RD but not less than 50ft (15 m)
- C. Minimum FATO Width: 2.0 RD but not less than 100 ft (30 m)
- D. Minimum FATO Length: 2.0 RD but not less than 200 ft (61 m). See paragraph 302b(2) and Figure 3-4 for adjustments for elevations above 1000ft.
- E. Minimum Separation Between the Perimeter of the TLOF and the FATO: $[0.5 (1.5 OL - 1.0 RD)]$
- F. Minimum Safety Area Width: $\frac{1}{2}$ RD but not less than 30 feet (9 m).

RD: Rotor diameter of the design helicopter

OL: Overall length of the design helicopter

**Figure 3-2. TLOF/FATO/Safety Area Relationships and Minimum Dimensions:
TRANSPORT**

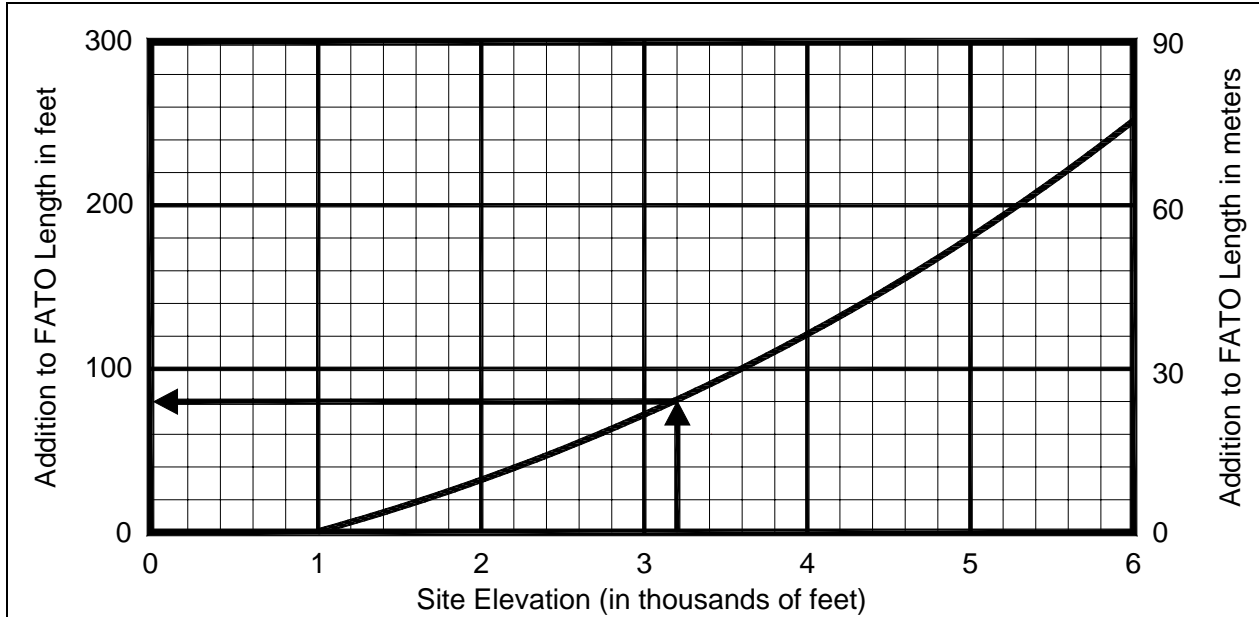


- A Minimum TLOF Width: 1.0 RD but not less than 50 feet (15 m)
- B Minimum TLOF Length: 1.0 RD but not less than 50ft (15 m)
- C Minimum FATO Width: 2.0 RD but not less than 100 ft (30 m)
- E Minimum Separation Between the Perimeters of the TLOF and the FATO: $[0.5(1.5 OL - 1.0 RD)]$
- F Minimum Safety Area Width: 30 feet (9 m)

RD: Rotor diameter of the design helicopter

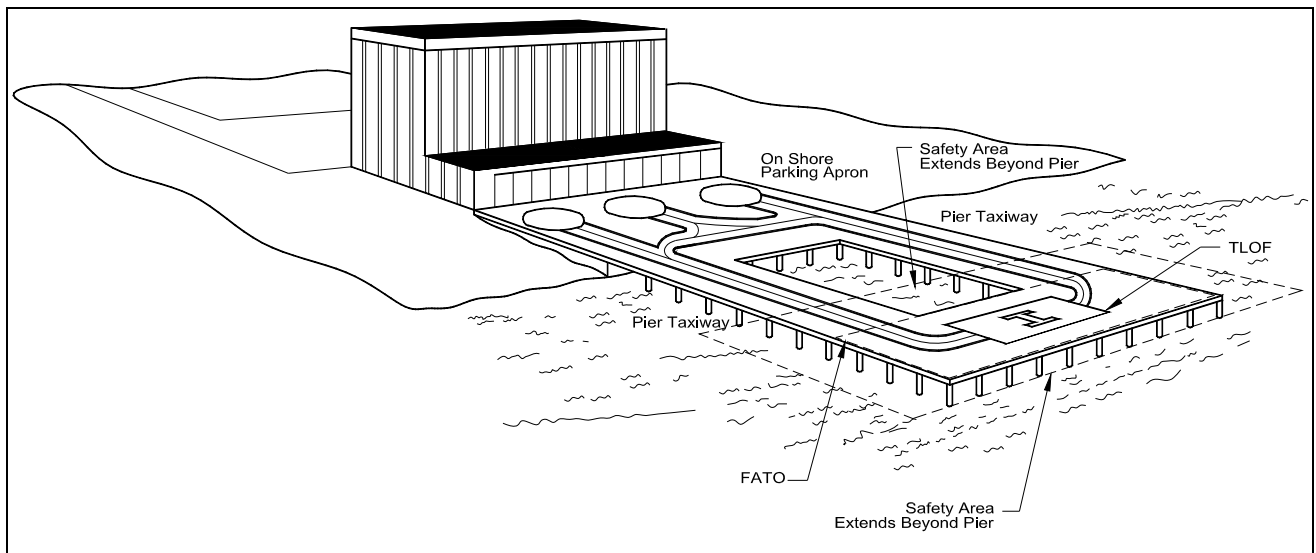
OL: Overall length of the design helicopter

**Figure 3-3. An Elongated FATO/TLOF with Two Takeoff Positions:
TRANSPORT**



Example: For a site elevation of 3,200 ft., 80 ft. should be added to the basic FATO length (200 ft. + 80 ft. = 280 ft.)

**Figure 3-4. Additional FATO Length for Heliports at Higher Elevations:
TRANSPORT**



**Figure 3-5. Non-load-bearing Safety Area:
TRANSPORT**

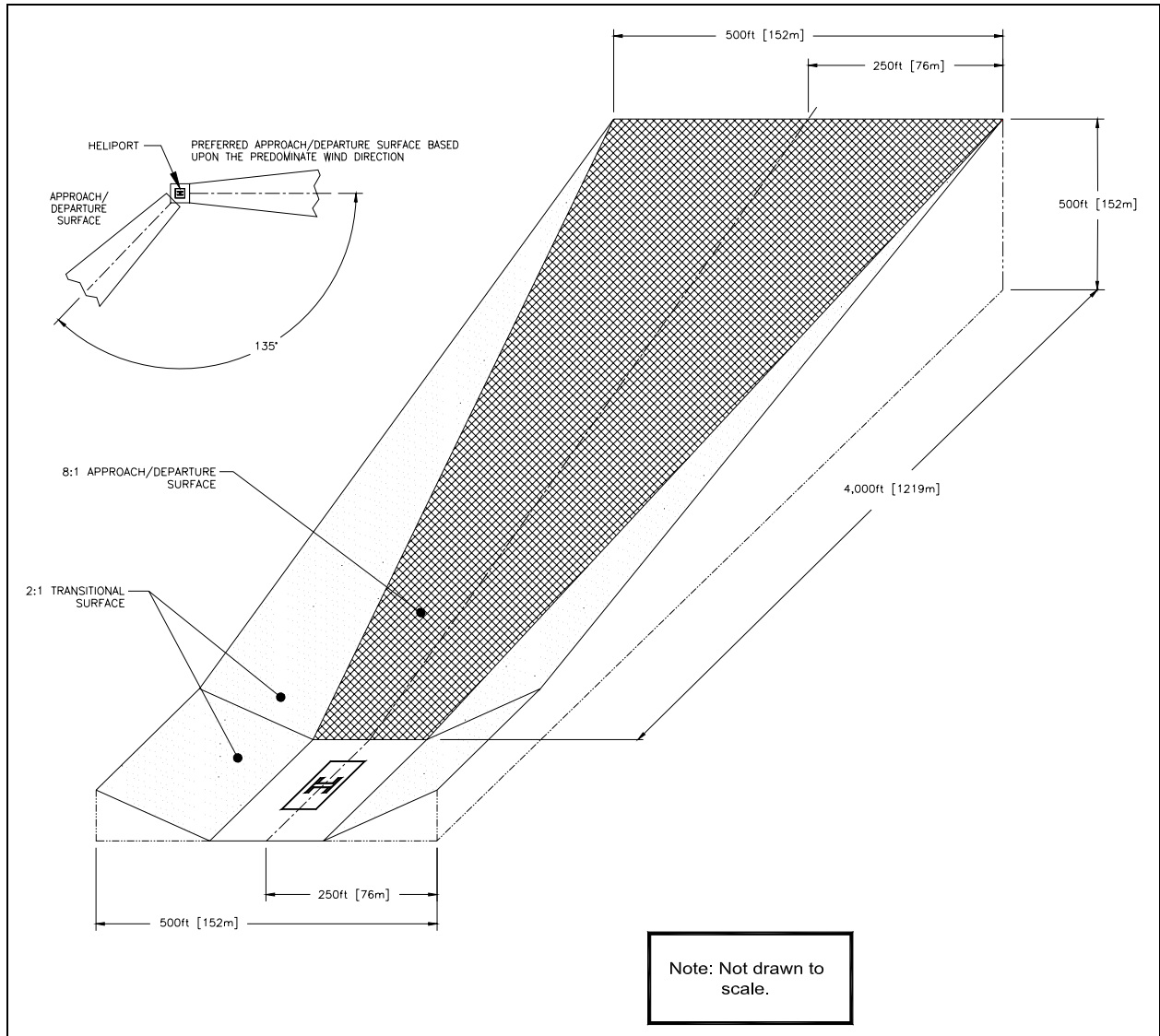
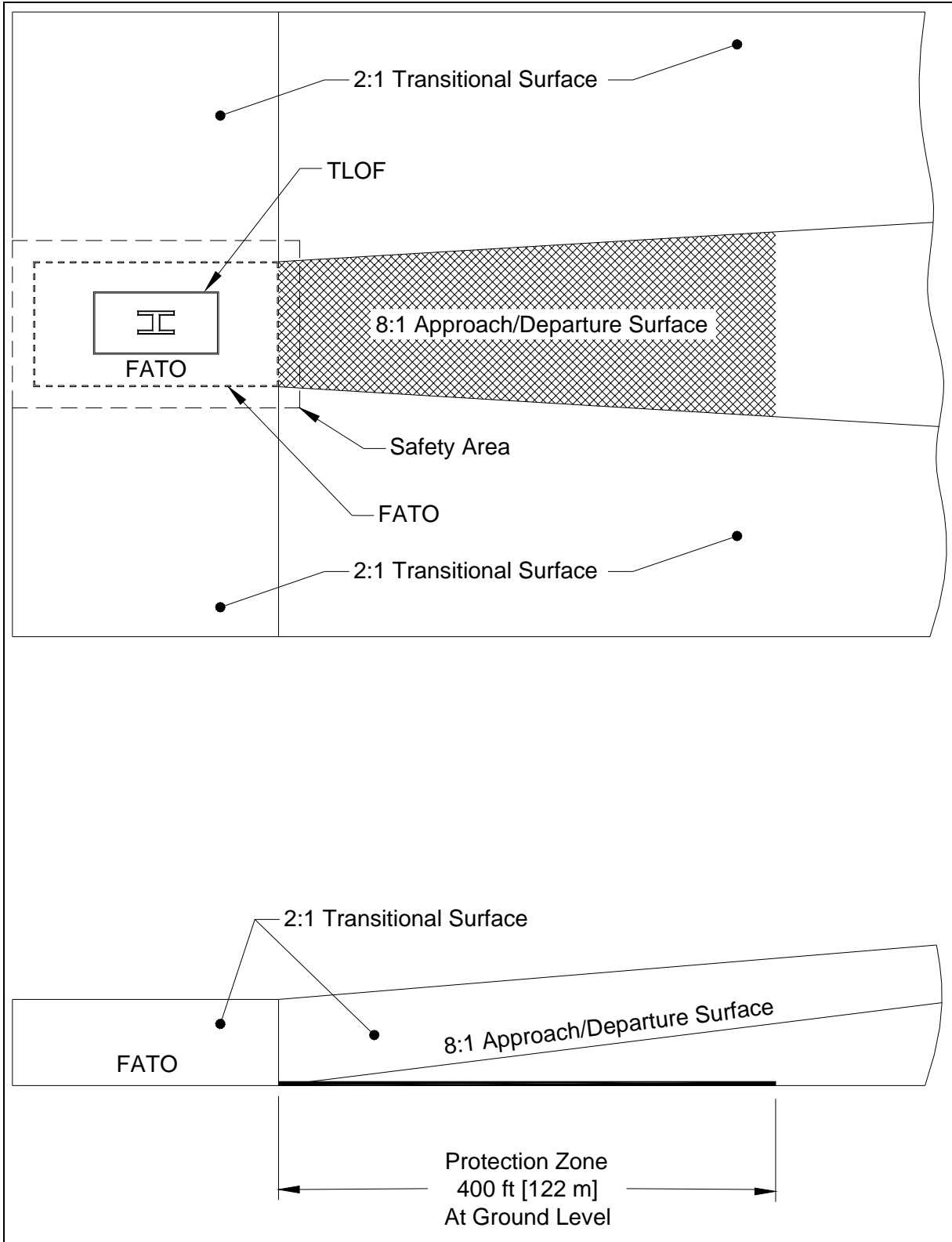
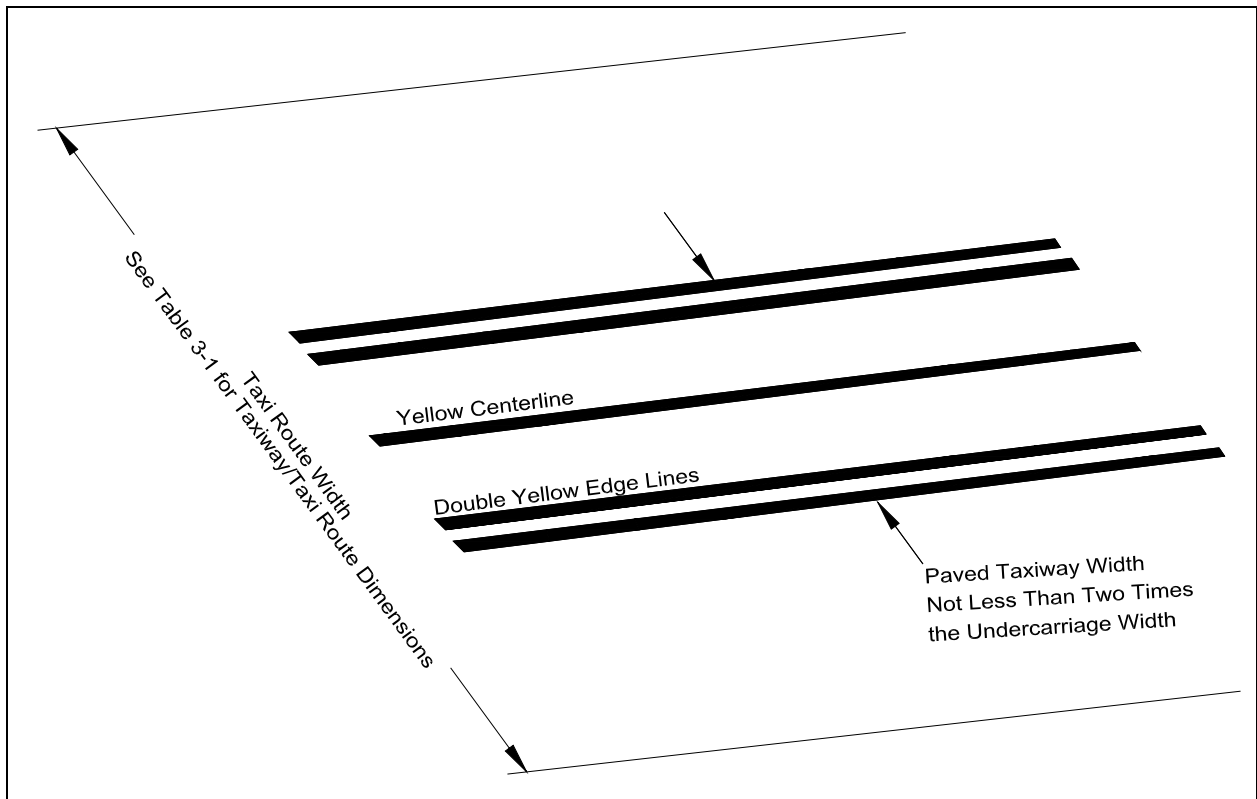


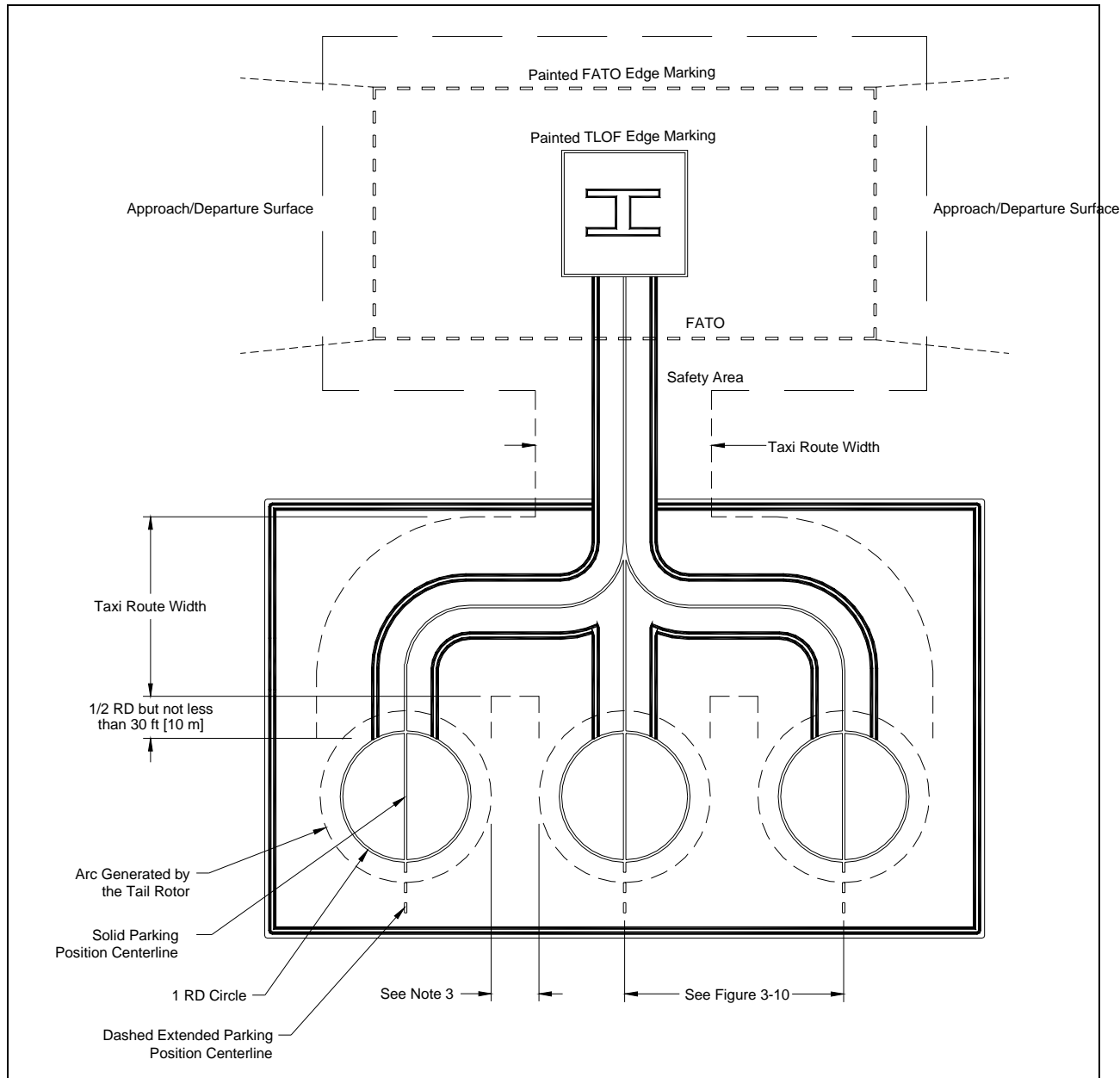
Figure 3-6. VFR Heliport Approach/ Departure and Transitional Surfaces: TRANSPORT



**Figure 3-7. Protection Zone:
TRANSPORT**



**Figure 3-8. Taxiway/Taxi Route Relationship, Centerline and Edge Marking:
TRANSPORT**



NOTES:

1. For simplicity, some markings have not been shown on this figure (such as parking position identifier, passenger walkway, and rotor diameter of the largest helicopter that the FATO/TLOF or the parking position is designed to accommodate).
2. The design of these parking positions is based on the presumption that the helicopter may pivot about the mast prior to exiting the parking position.
3. The minimum recommended clearance between the arcs generated by the tail rotor:
 Hover taxi operations: $1/3$ RD
 Ground taxi operations: 10 ft (3 m)
4. Rotor diameter and weight limitation markings are not shown for simplicity.

**Figure 3-9. Parking Area Design-“Turn-around” Parking Positions:
 TRANSPORT**

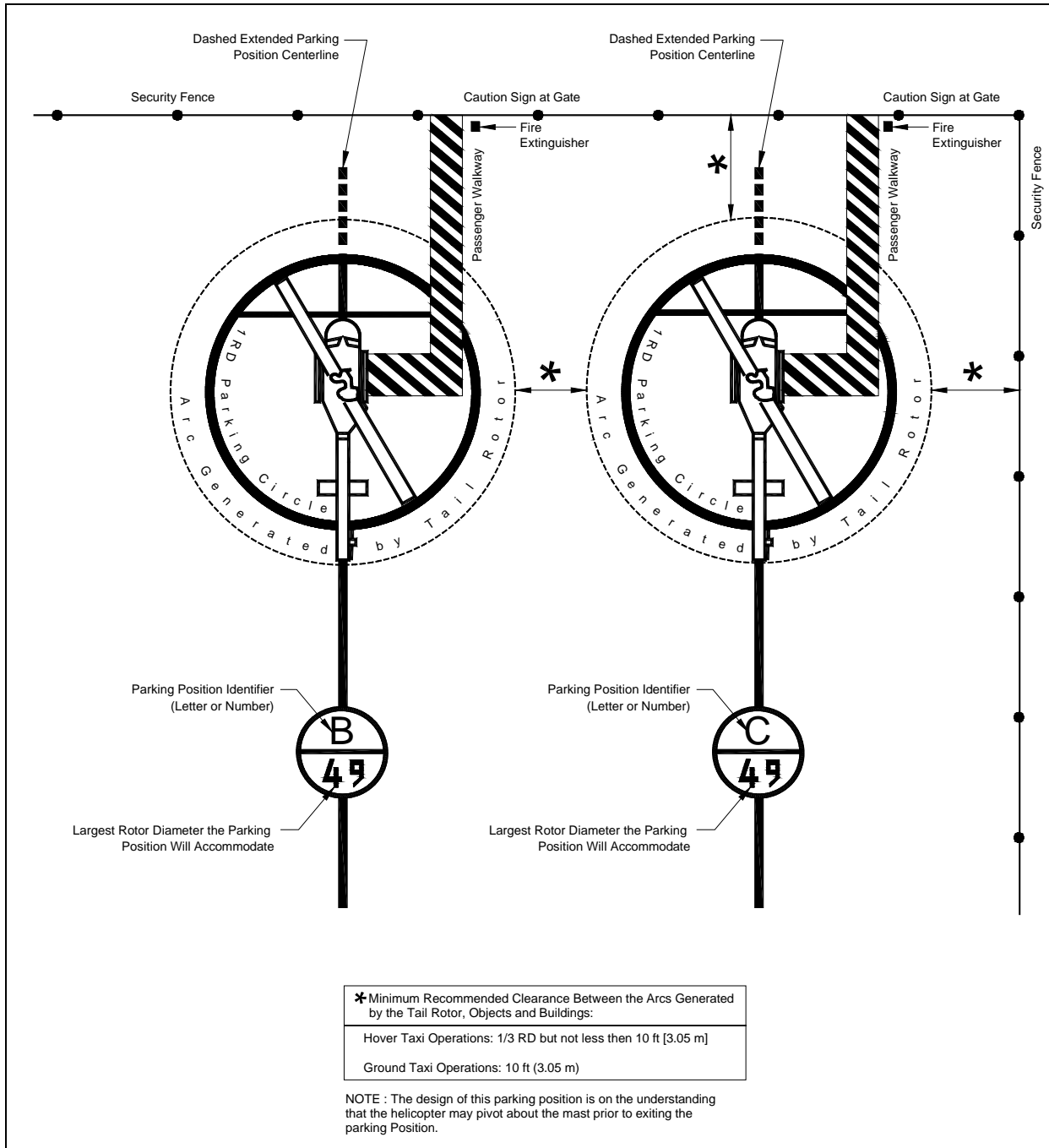
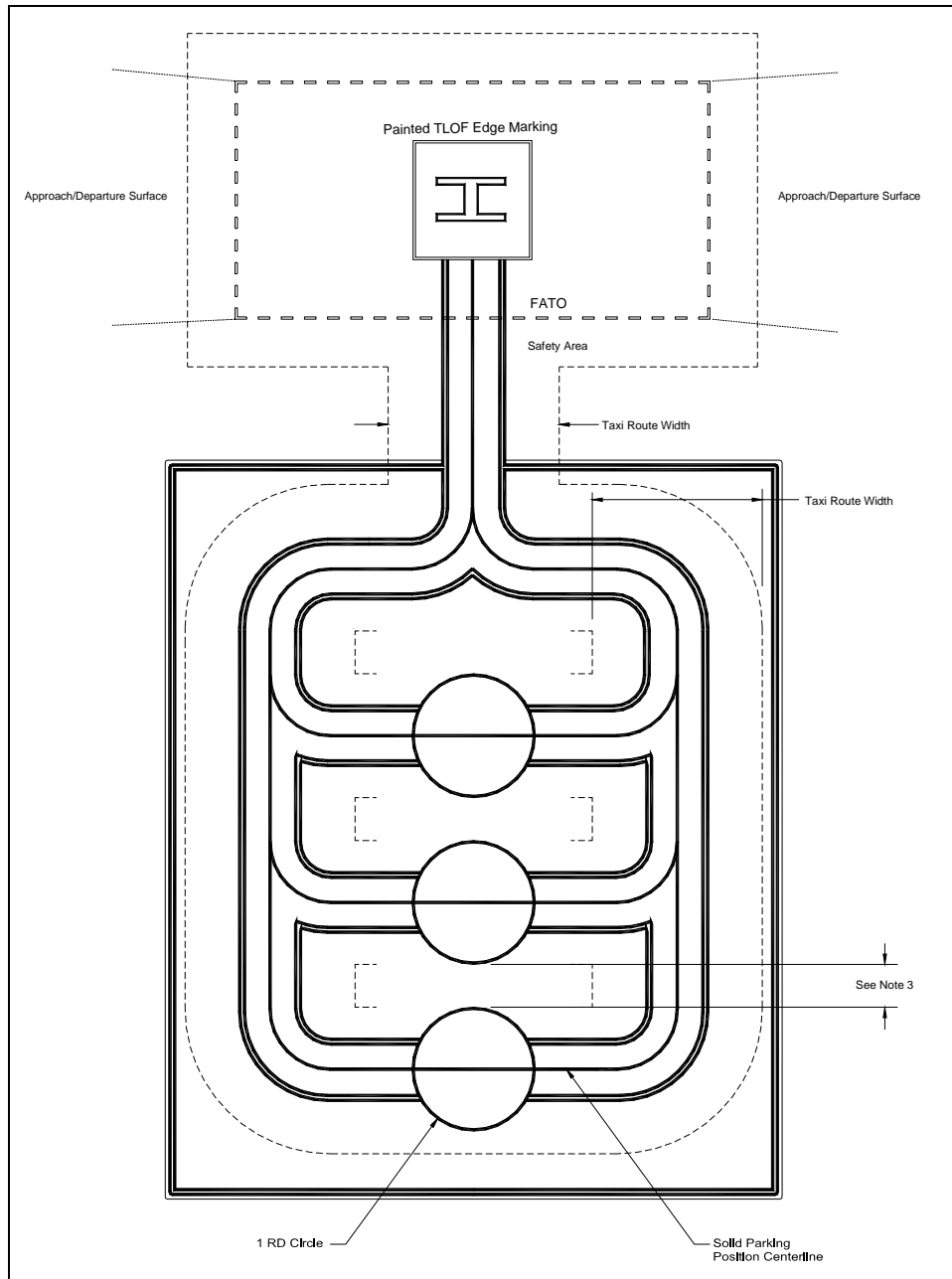


Figure 3-10. Parking Position Marking: TRANSPORT



NOTES:

1. For simplicity, some markings have not been shown on this figure such as parking position identifier, passenger walkway, and rotor diameter of the largest helicopter that the FATO/TLOF or the parking position is designed to accommodate.
2. The parking areas are designed so that helicopters exit taxiing forward.
3. The minimum recommended clearance between parking positions
 Hover taxi operations: $1/3$ RD
 Ground taxi operations: 10 ft (3 m)
4. Rotor diameter and weight limitation markings are not shown for simplicity.

Figure 3-11. Parking Area Design-“Taxi-through” Parking Positions: TRANSPORT

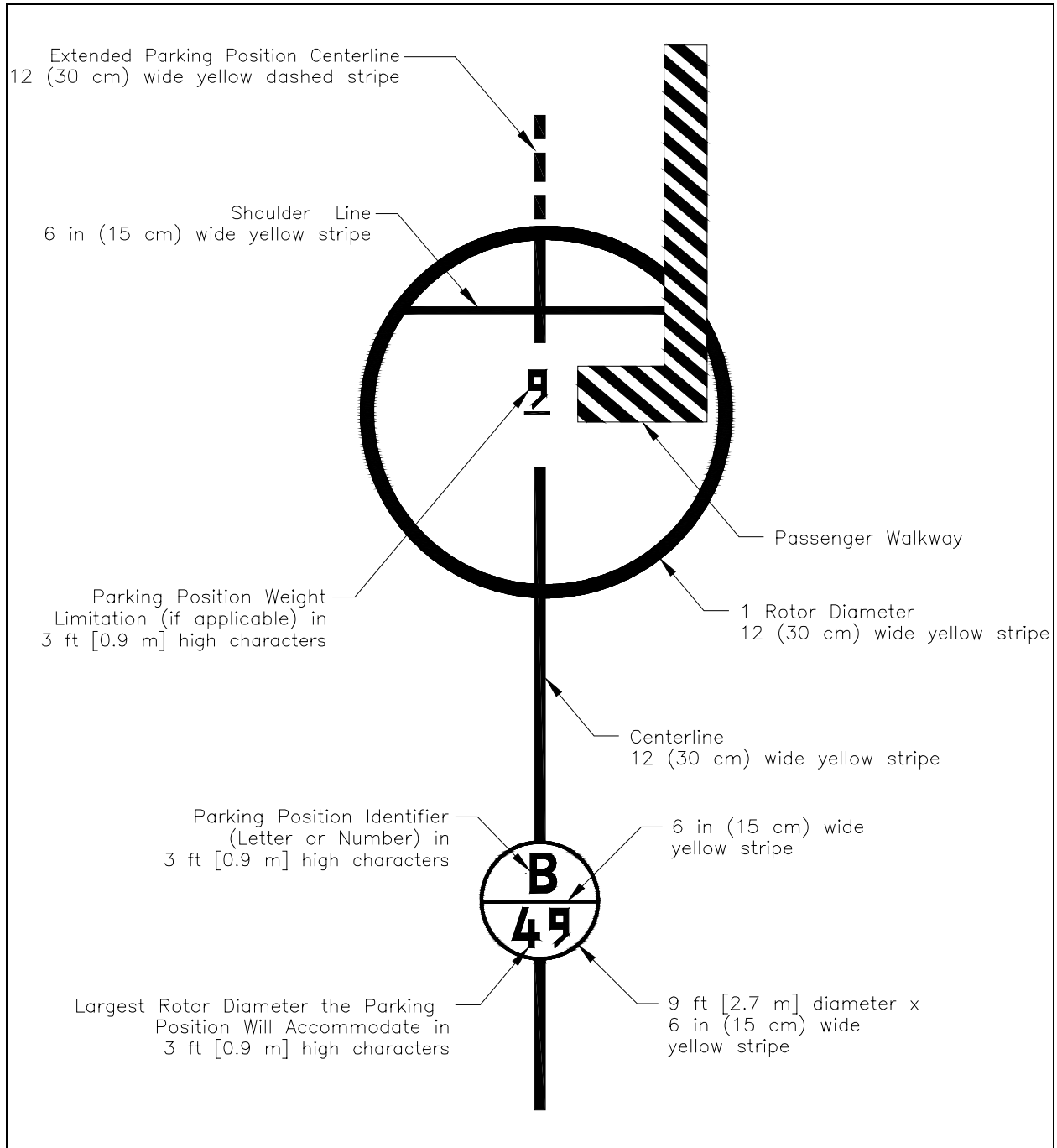
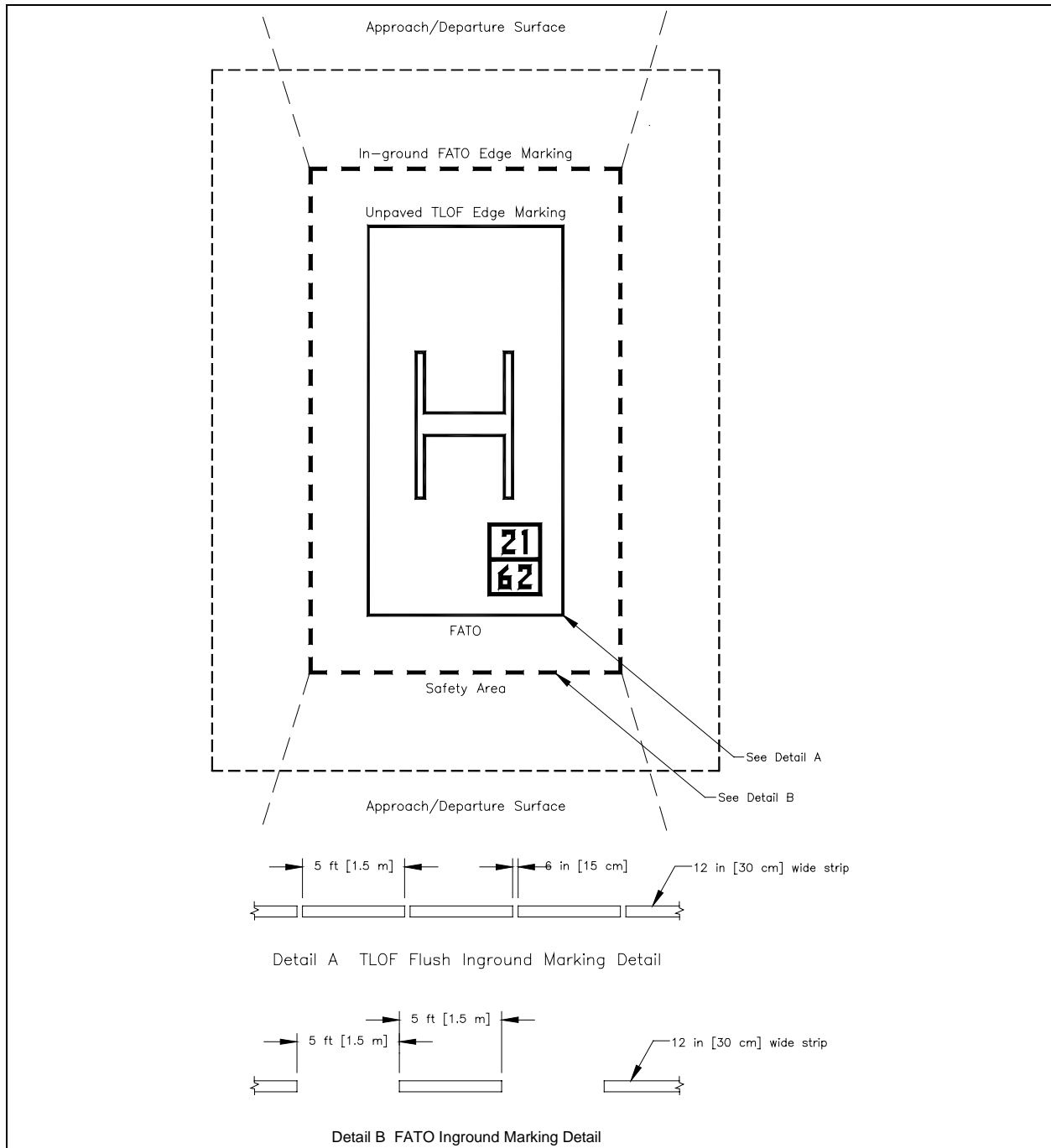


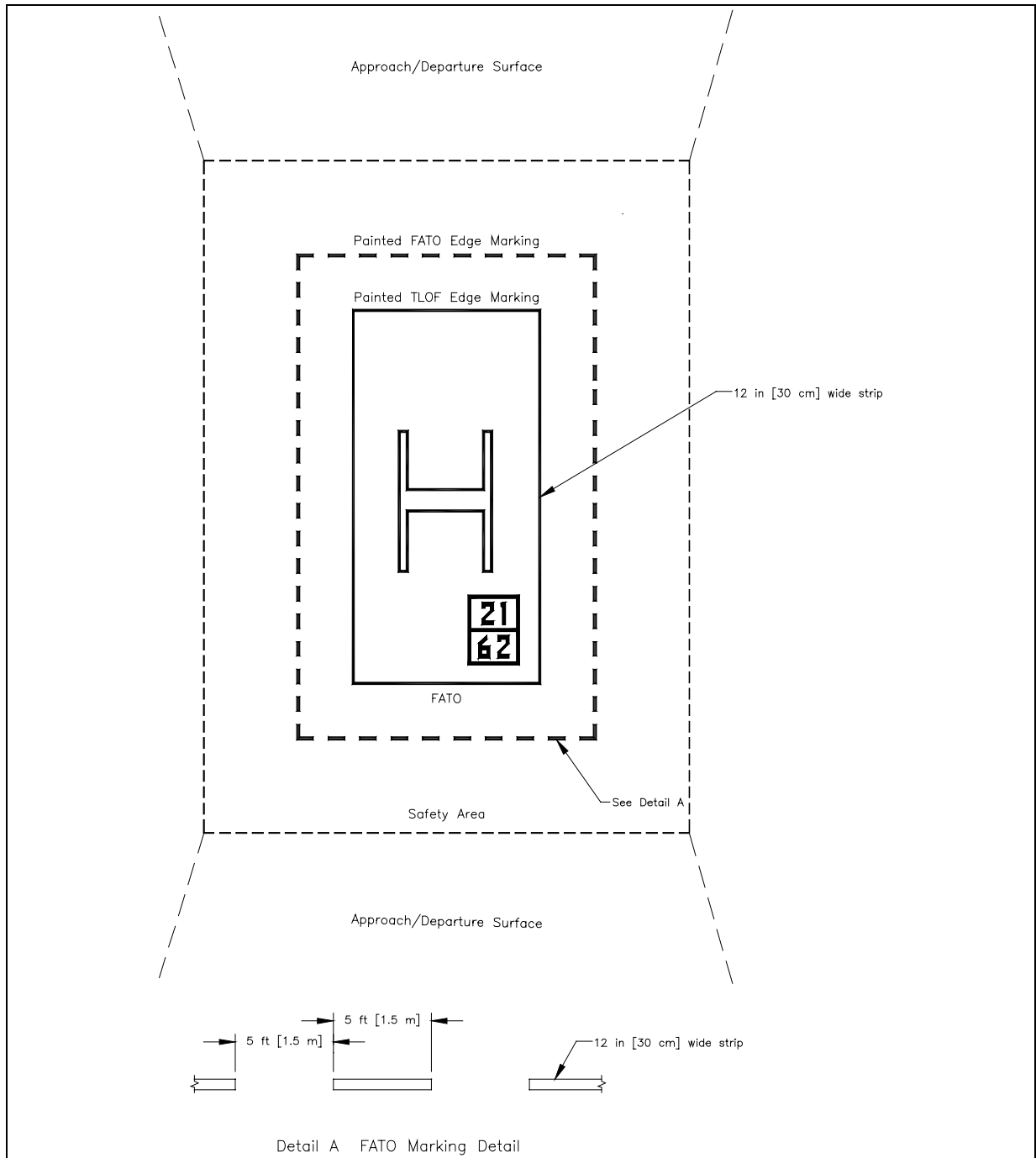
Figure 3-12. Parking Position Identification, Size and Weight Limitations: TRANSPORT



NOTES:

1. The **H** should be oriented on the axis of the preferred approach/ departure path.
2. The perimeter of the TLOF and/or the FATO should be marked.
3. The perimeter of a paved or hard surfaced TLOF should be defined with a continuous, white line.
4. The perimeter of an unpaved FATO should be defined with flush, in-ground markers.

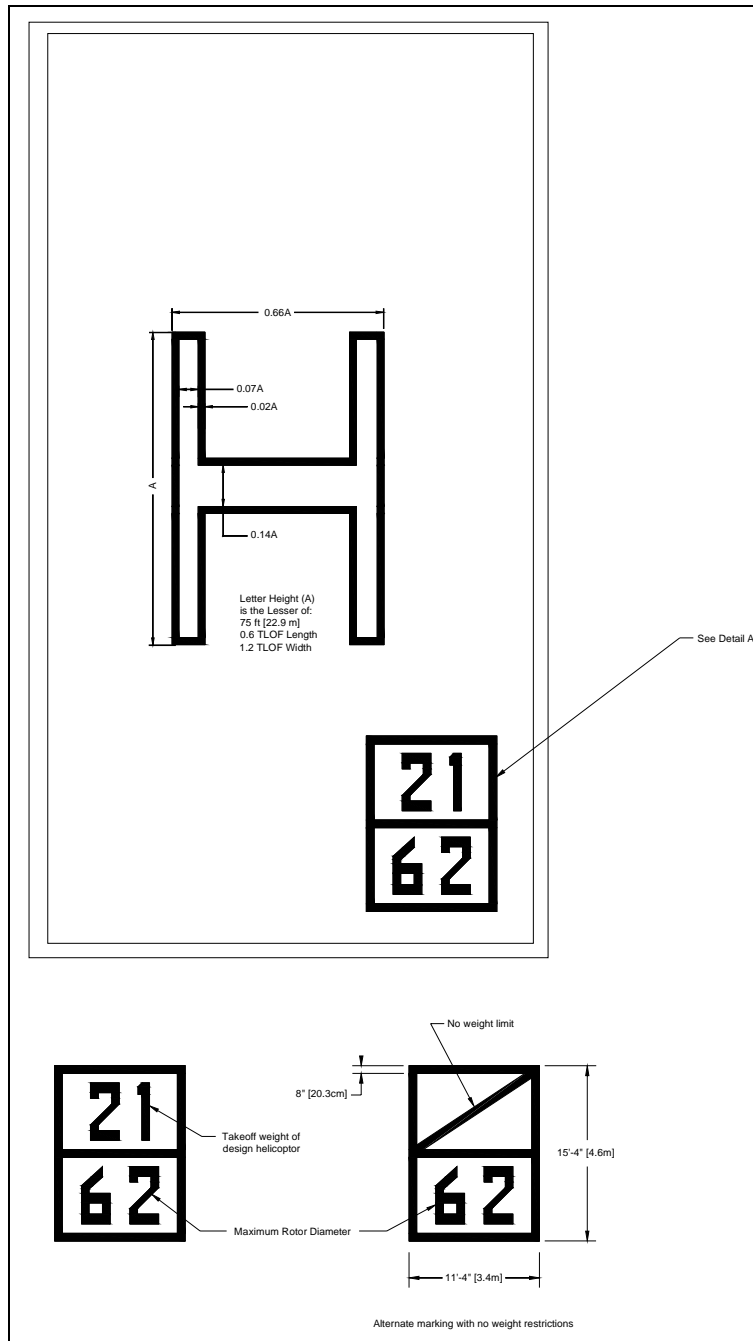
**Figure 3-13. Paved TLOF/Unpaved FATO – Markings:
TRANSPORT**



NOTES:

1. The **H** should be oriented on the axis of the preferred approach/ departure path.
2. The perimeter of the TLOF and/or the FATO should be marked.
3. The perimeter of a paved or hard surfaced TLOF should be defined with a continuous, white line.
4. The perimeter of a paved FATO should be defined with a 12-inch-wide (30 cm) dashed white line. (See detail A)
5. See Figure 3-15 for dimensions of the **H**.

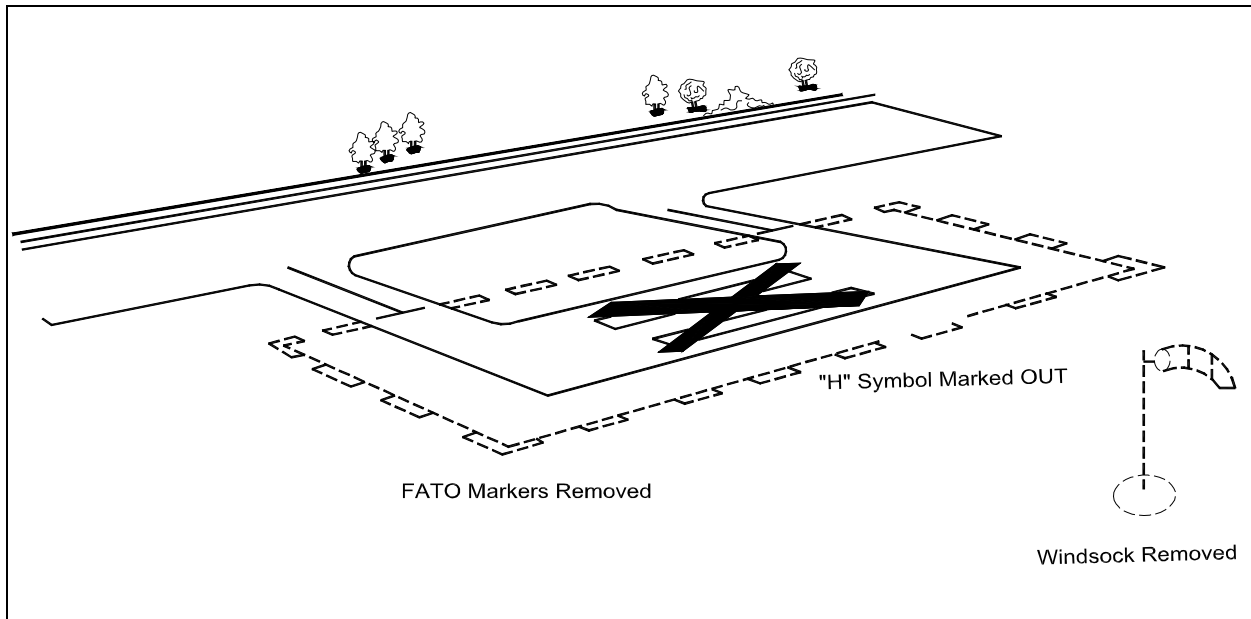
**Figure 3-14. Paved TLOF/Paved FATO – Markings:
TRANSPORT**



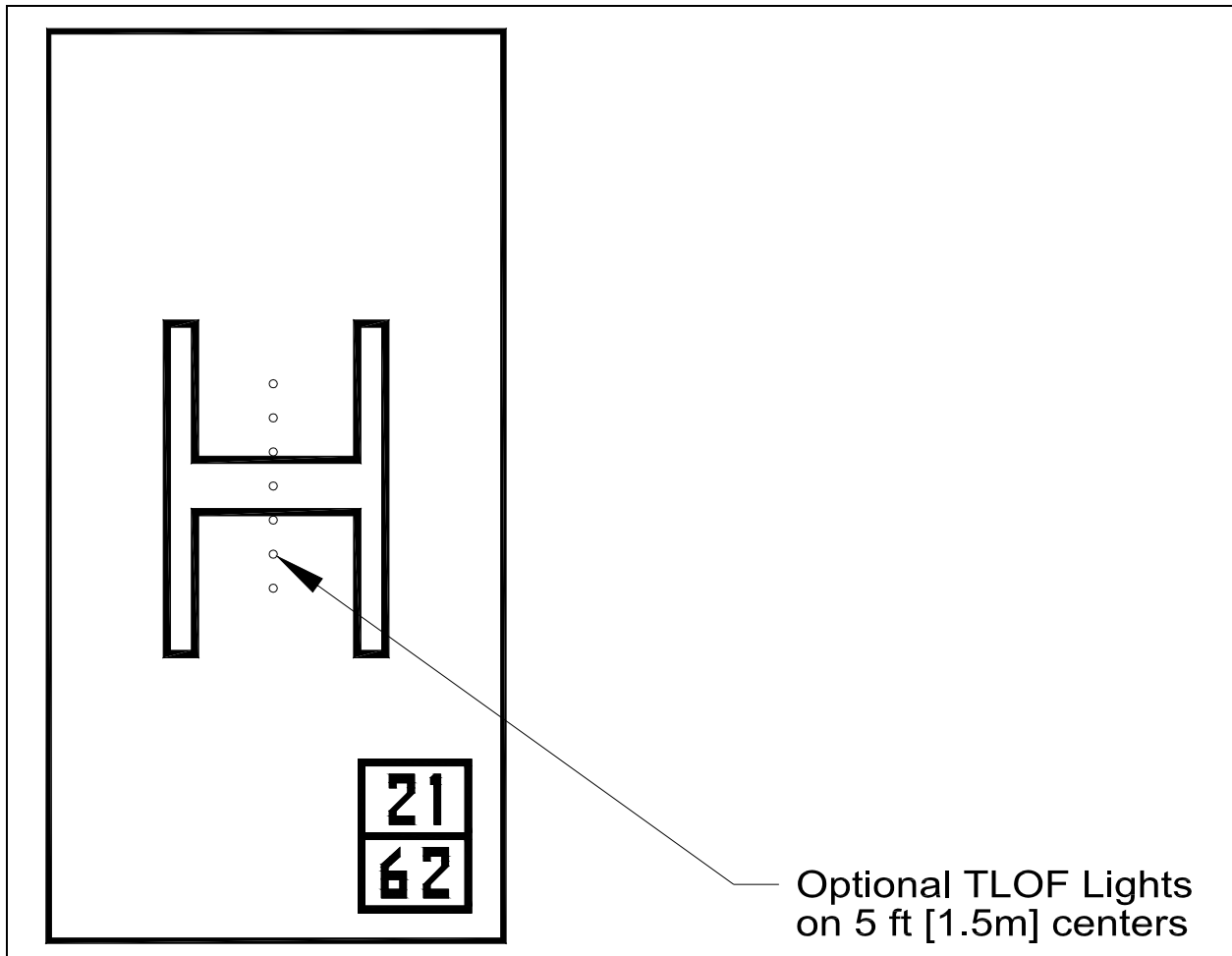
NOTES:

1. See Appendix 3 for the form and proportion of the numbers used in the size and weight limitations 'box'.
2. The **H** should be oriented on the axis of the preferred approach/ departure path.
3. **21** indicates the TLOF has limited weight-carrying capability in thousands of pounds
4. **62** indicates the rotor diameter of the largest helicopter for which the TLOF is designed.

**Figure 3-15. Standard Heliport Identification Symbol, TLOF Size, and Weight Limitations:
TRANSPORT**

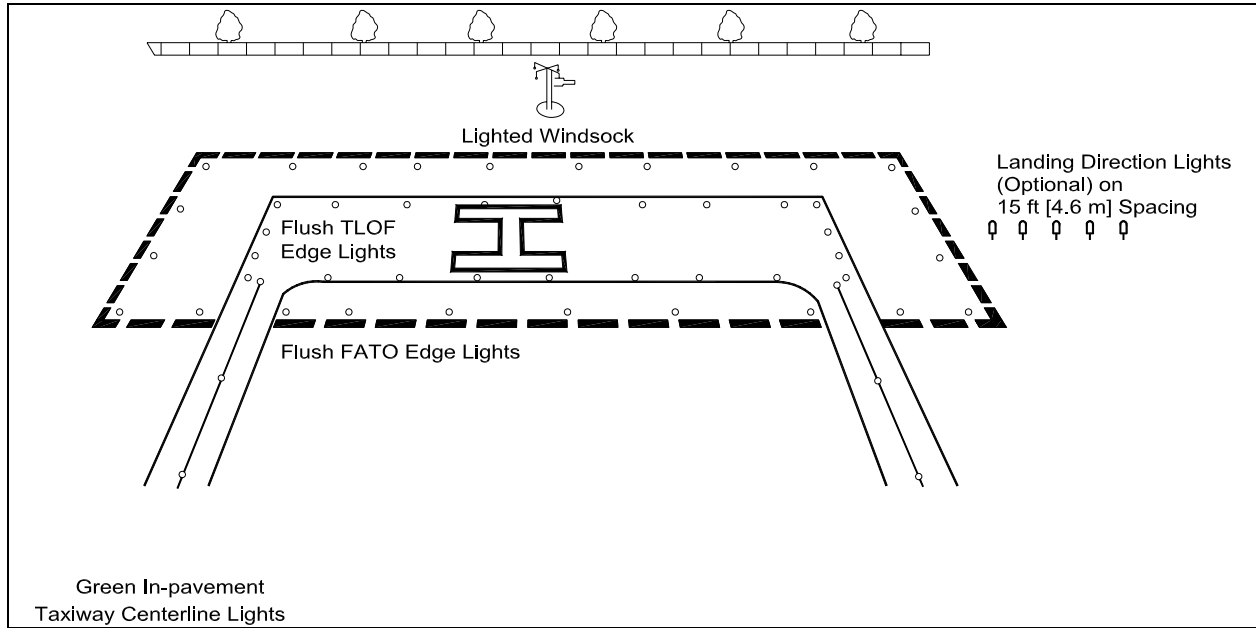


**Figure 3-16. Marking a Closed Heliport:
TRANSPORT**



NOTE: Optional white, flush L-850A TLOF lights

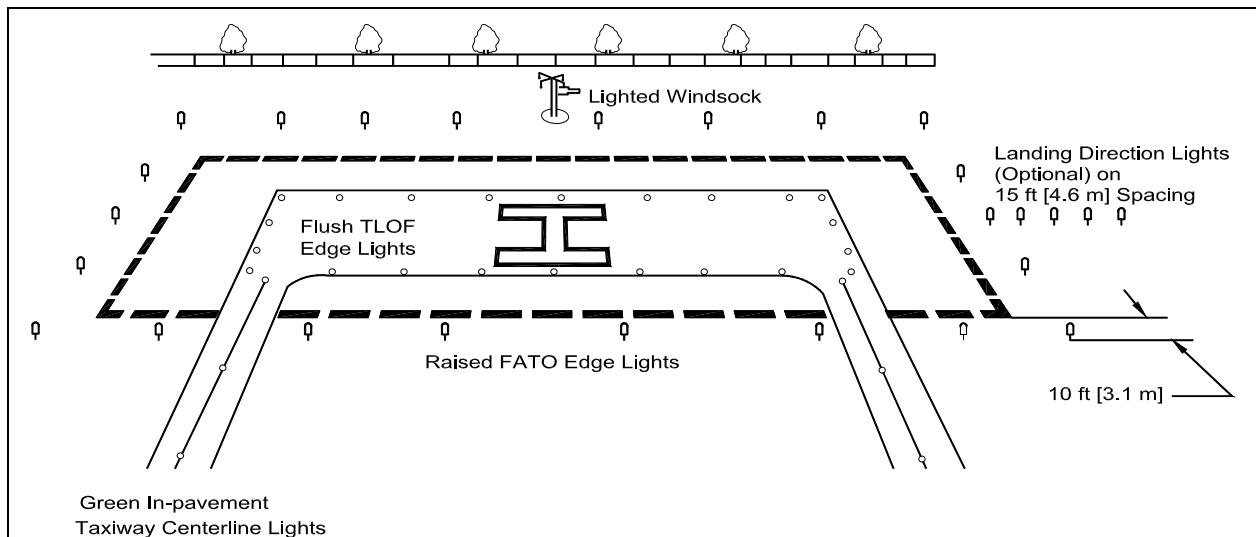
**Figure 3-17. Optional TLOF Lights:
TRANSPORT**



NOTES:

1. Flush FATO and TLOF lights may be installed inside or outside ± 1 foot of the FATO and TLOF respective perimeters.
2. Rotor diameter and weight limitation markings are not shown for simplicity

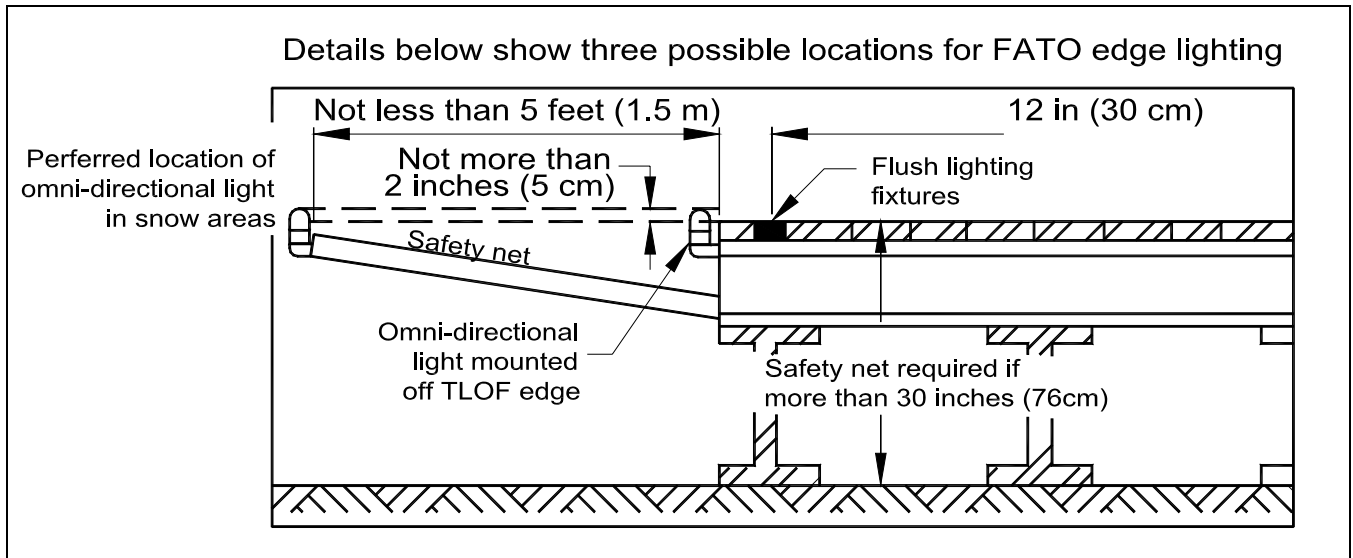
**Figure 3-18. FATO and TLOF Flush Perimeter Lighting:
TRANSPORT**



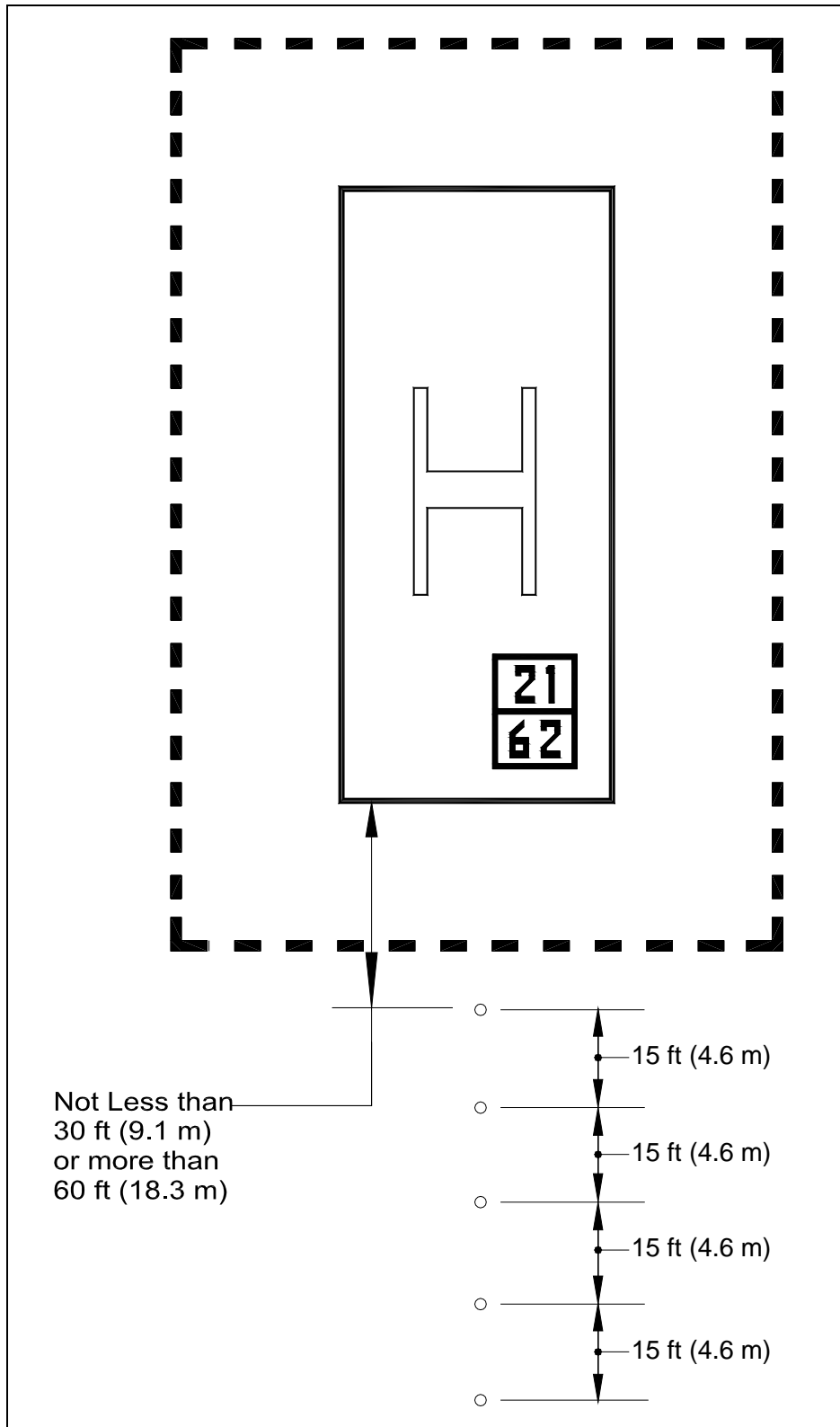
NOTES:

1. Flush TLOF lights may be installed inside or outside ± 1 foot of the TLOF perimeter.
2. Raised FATO lights may be installed 10-foot outside the FATO perimeter.
3. Rotor diameter and weight limitation markings are not shown for simplicity.

**Figure 3-19. FATO Raised and TLOF Flush Perimeter Lighting:
TRANSPORT**

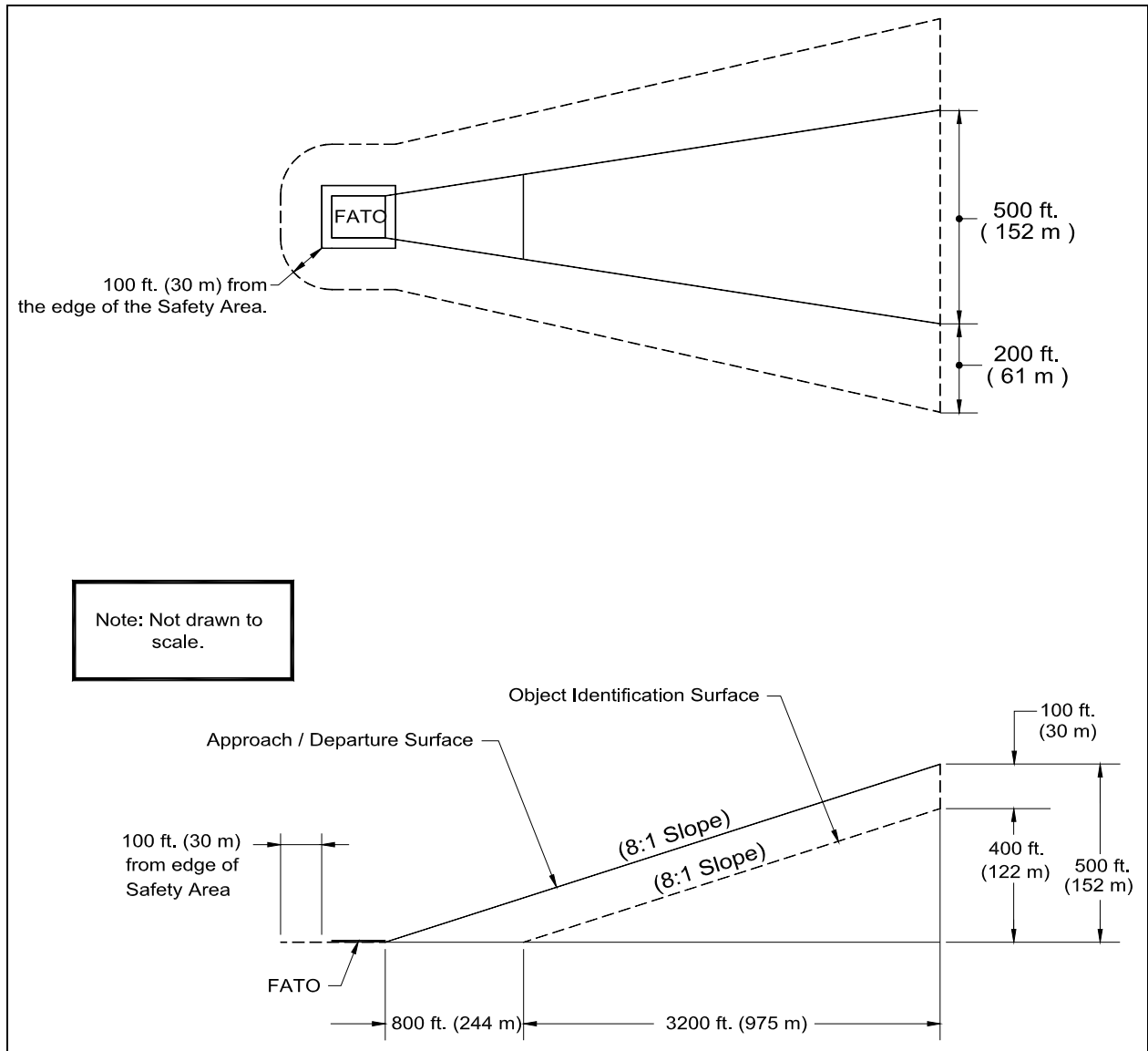


**Figure 3-20. Elevated FATO – Perimeter Lighting:
TRANSPORT**



NOTE: Yellow omni-directional lights

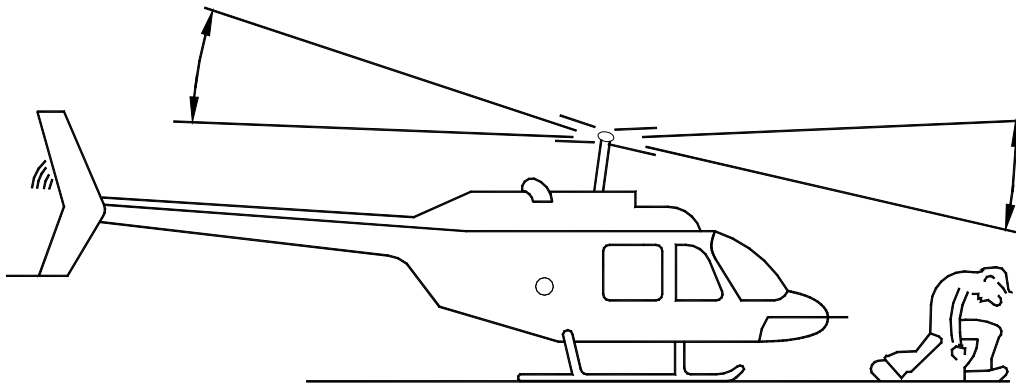
Figure 3-21. Landing Direction Lights:
TRANSPORT



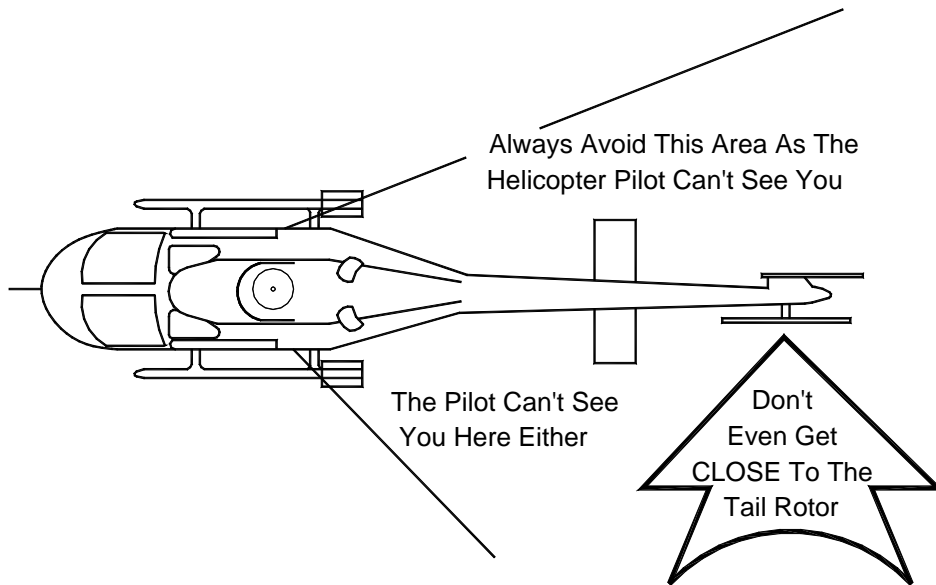
**Figure 3-22. Airspace Where Marking and Lighting Are Recommended:
TRANSPORT**

BE ALERT

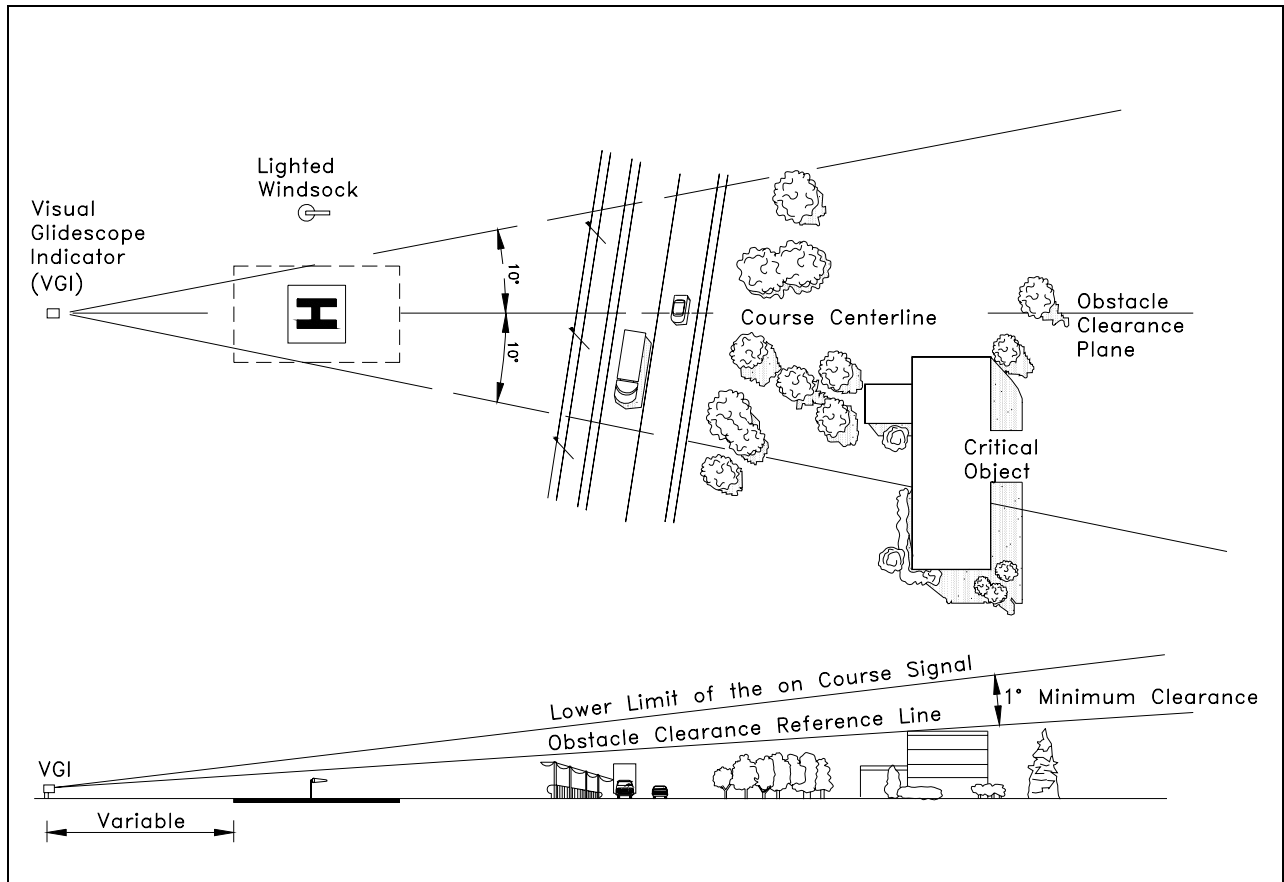
AROUND THE HELICOPTER



Approach And Leave The Helicopter In A Crouched Manner When Rotors Are Turning



**Figure 3-23. Caution Sign:
TRANSPORT**



**Figure 3-24. Visual Glideslope Indicator (VGI) Siting and Clearance Criteria:
TRANSPORT**

Intentionally Left Blank

CHAPTER 4. HOSPITAL HELIPORTS

400. GENERAL. Helicopters have proven to be an effective means of transporting injured persons from the scene of an accident to a hospital and in transferring patients in critical need of specialized services from one hospital to another hospital having that capability. A functional hospital heliport may be as simple as a cleared area on the ground, together with a windsock and a clear approach/ departure path. Figure 4-1 illustrates the essential elements of a ground-level hospital heliport.

The heliport consists of a touchdown and lift-off area (TLOF) surrounded by a final approach and takeoff area (FATO). A safety area is provided around the FATO.

The relationship of the TLOF to the FATO and the Safety Area is shown in Figure 4-2. A FATO may NOT contain more than one TLOF.

Appropriate approach/ departure airspace, to allow safe approaches to and departures from landing sites is required. (See Paragraph 404.)

NOTE: *The design recommendations given in this Chapter are based on the understanding that there will never be more than one helicopter within the FATO and the associated safety area. If there is a need for more than one TLOF at a heliport, each TLOF should be located within its own FATO.*

a. Hospital Heliports. This chapter addresses issues that are unique to hospital heliports and issues for which the design recommendations are different than what is recommended for other categories of heliports. These recommendations address the design of a heliport that will accommodate air ambulance helicopter operations and emergency medical service (EMS) personnel and equipment.

b. Heliport Site Selection. Public agencies and others planning to develop a hospital heliport are encouraged to select a site capable of supporting instrument operations, future expansion, and military helicopters that will be used in disaster relief efforts.

NOTE: *To the extent that it is feasible and practical to do so, the standards and recommendations in this AC should be used in planning and designing improvements to an existing heliport when significant expansion or reconstruction is undertaken. However, existing hospital heliports may continue to follow the*

recommendations and standards applicable at the time of design.

NOTE: *If Federal funds are used to build or modify a hospital heliport, the facility should meet the applicable sections in chapter 2 as well as the additional recommendations in this chapter. In addition, the facility should have sufficient size and weight-bearing capability to support the nominal-sized military medevac helicopter that might land at the heliport during emergencies.*

401. TOUCHDOWN AND LIFT-OFF AREA (TLOF).

a. TLOF Location. The TLOF of a hospital heliport may be at ground level, on an elevated structure, or at rooftop level. The TLOF is normally centered within the FATO.

b. TLOF Size. The minimum TLOF dimension (length, width, or diameter) should be 1.0 rotor diameter (RD) of the design helicopter but not less than 40 feet (12 m).

c. Elongated TLOF. An elongated TLOF can provide an increased safety margin and greater operational flexibility. An elongated TLOF may contain a landing position located in the center and two takeoff positions located at either end as illustrated in Figure 4-3. The landing position should have a minimum length of 1.0 times the RD of the design helicopter

NOTE: *If an elongated TLOF is provided an elongated FATO will also be required. See Figure 4-3.*

d. Ground-level TLOF Surface Characteristics. The entire TLOF must be load bearing, either a paved surface or aggregate turf (see AC 150/5370-10, Item P-217). A paved surface is preferable to provide an all-weather wearing surface for helicopters and a firm working surface for hospital personnel and the wheeled equipment used for moving patients on gurneys. The TLOF should be capable of supporting the support the dynamic loads of the helicopter intended to use the parking area (Paragraph 806b). Portland Cement Concrete (PCC) is recommended for ground-level facilities. (An asphalt surface is “less desirable” for heliports as it may rut under the wheels or skids of a parked

helicopter, a factor in some rollover accidents.) Pavements should have a broomed or other roughened finish that provides a skid-resistant surface for helicopters and non-slippery footing for people and for moving patients on gurneys.

e. Rooftop and Other Elevated TLOFs.

Elevated TLOFs and any TLOF supporting structure should be capable of supporting the dynamic loads of the helicopter intended to use the facility (Paragraph 806b).

(1) Elevated Hospital Heliports. The TLOF should be elevated above the level of any obstacle, in either the FATO or the Safety Area that can not be removed. [Exception: This does not apply to frangibly mounted objects that, due to their function, must be located within the Safety Area (see paragraph 403d).

(2) Obstructions. Elevator penthouses, cooling towers, exhaust vents, fresh-air vents, and other raised features can impact heliport operations. Helicopter exhausts can impact building air quality if the heliport is too close to fresh-air vents. These issues should be resolved during facility design. In addition, control mechanisms should be established to ensure that obstruction hazards are not installed after the heliport is operational.

(3) TLOF Surface Characteristics. Rooftop and other elevated heliport TLOFs should be constructed of metal or concrete (or other materials subject to local building codes). TLOF surfaces should have a broomed pavement or other roughened finish that provides a skid-resistant surface for helicopters and non-slippery footing for people.

(4) Safety Net. When the TLOF is on a platform elevated more than 30 inches (76 cm) above its surroundings, a safety net, not less than 5 feet (1.5 m) wide, should be provided. A railing or fence should not be used since it would be a safety hazard during helicopter operations. The safety net should have a load carrying capability of 25 lb/ft² foot (122 kg/m²). The net, as illustrated in Figure 4-4, should not project above the level of the TLOF. Both the inside and outside edges of the safety net should be fastened to a solid structure.

NOTE: *Designers should consider state and local regulations when determining the width required for the safety net.*

(5) Access to Elevated TLOFs. OSHA requires two separate access points for an elevated

structure such as a elevated TLOF. Hospital heliports should provide access to and from the TLOF via a ramp in order to provide for quick and easy transportation of a patient on a gurney. Ramps should be built in accordance with state and local requirements. The width of the ramp, and any turns in the ramp, should be wide enough to accommodate a gurney with a person walking on each side. Straight segments of the ramp should be not less than 6 feet (1.8 m) wide. Additional width may be required in the turns. The ramp surface should provide a slip-resistant surface. The slope of the ramp should be no steeper than 12:1 (12 unit horizontal in 1 units vertical). Inside the FATO and safety area, any handrails should not extend above the elevation of the TLOF. Where a handrail complying with Appendix A of 49 CFR 37, Section 4.8, is not provided, other means should be provide to protect personnel from fall hazards.

(6) Stairs should be built in compliance with regulation 29 CFR 1910.24.

(7) Access by individual with disabilities. Heliports operated by public entities and those receiving Federal financial assistance should provide reasonable accommodation for individual with disabilities if they do not impose undue hardship (significant difficulty or expense) on the operation of the organization. Refer to paragraph 112 and AC 150/5360-14 for additional guidance.

NOTE: *While it is possible to move a gurney to and from the TLOF using a lift, this is not recommended since it invariably results in a delay in the movement of patients with time-critical conditioning.*

f. TLOF Gradients. Recommended TLOF gradients are defined in Chapter 8.

402.FINAL APPROACH AND TAKEOFF AREA (FATO). A hospital heliport should have at least one FATO. The FATO should contain a TLOF within its borders at which arriving helicopters terminate their approach and from which departing helicopters takeoff.

a. FATO Location. The hospital FATO may be at ground level, on an elevated structure, or roof top level. To avoid or minimize the need for additional ground transport, the FATO location should provide ready access to the hospital's emergency room. However, the heliport should be located so buildings and other objects are outside the Safety Area.

b. FATO Size.

(1) The length and width of the FATO should not be less than 1.5 times the overall length (OL) of the design helicopter. At elevations well above sea level, a longer FATO can provide increased safety margin and greater operational flexibility.

(2) The minimum distance between the TLOF perimeter and the FATO perimeter should be not less than the distance $[0.5 \times (1.5 \text{ OL} - 1.0 \text{ RD})]$ where OL is the overall length and RD is the rotor diameter of the design helicopter.

c. FATO Surface Characteristics. The FATO outside of the TLOF need not be load bearing. There are some helicopter performance benefits and increased operational flexibility if the FATO outside the TLOF is load bearing. If the TLOF is marked, the FATO outside the TLOF and the Safety Area may extend into the clear airspace. If the TLOF is not marked (see Paragraph 409a) and/or it is intended that the helicopter can land any where within the FATO, the FATO outside the TLOF should, like the TLOF, be capable of supporting the dynamic loads of the design helicopter (Paragraph 806 b).

If the FATO is load bearing, the portion abutting the TLOF should be continuous with the TLOF and the adjoining edges should be at the same elevation. If it is unpaved, the FATO should be treated to prevent loose stones and any other flying debris caused by rotorwash.

d. Mobile Objects within the FATO and the Safety Area. The FATO and Safety Area design recommendations in this AC are based on the assumption that the FATO is closed to other aircraft if a helicopter or other mobile object is within the FATO or the associated Safety Area.

e. FATO/FATO Separation. If a heliport has more than one FATO, the separation between the perimeters of the two FATOs should be such that the respective safety areas do not overlap. This separation is based on the assumption that simultaneous approach/ departure operations will not take place.

NOTE: *If simultaneous operations are planned, greater separation will be required.*

f. FATO Gradients. Recommended FATO gradients are defined in Chapter 8.

403.SAFETY AREA. A Safety Area surrounds a FATO and should be clear of all obstacles except small, frangible objects that, because of their function, must be located there.

a. Safety Area Width. The minimum recommended width of a Safety Area is dependent upon the heliport markings. The Safety Area width is dependent upon the use of the TLOF perimeter markings (paragraph 409a(1)), the FATO edge perimeter (paragraph 409a(2) and 409a(3)), and the hospital heliport identification marking in paragraph 409b. Table 4-1 shows how the minimum recommended Safety Area width varies as a function of heliport markings. The recommended size of the Safety Area in Table 4-1 is increased if the TLOF perimeter is not marked. The minimum recommended width of the Safety Area is the same on all sides.

b. IFR Safety Area Width. RESERVED.

c. Mobile Objects within the Safety Area. See paragraph 402d.

d. Fixed Objects within a Safety Area. No fixed object should be permitted within a Safety Area, except for frangibly mounted objects that, due to their function, must be located there. Those objects whose functions require them to be located within the Safety Area should not exceed a height of 8 inches (20 cm) nor penetrate the approach/ departure surfaces or transitional surfaces.

e. Safety Area Surface. The Safety Area need not be load bearing. Figure 4-5 depicts a non-load-bearing Safety Area. If the Safety Area is load bearing, the portion abutting the FATO should be continuous with the FATO and the adjoining edges should be at the same elevation. This is needed in order to avoid the risk of catching a helicopter skid or wheel. The Safety Area should be treated to prevent loose stones and any other flying debris caused by rotor wash.

f. Safety Gradients. Recommended Safety Area gradients are defined in Chapter 8.

404.VFR APPROACH/ DEPARTURE PATHS.

The purpose of approach/ departure airspace as shown in Figure 4-6 is to provide sufficient airspace clear of hazards to allow safe approaches to and departures from landing sites.

a. Number of Approach/ Departure Paths. Approach/ departure paths should be such that

downwind operations are avoided and crosswind operations are kept to a minimum. To accomplish this, a heliport should have more than one approach/ departure paths. The preferred flight approach/ departure path should, to the extent feasible, be aligned with the predominate wind. Other approach/ departure paths should be based on the assessment of the prevailing winds or when this information is not available the separation between such flight paths and the preferred flight path should be at least 135 degrees. (See Figure 4-6).

Hospital facilities may have only single approach/ departure path although a second flight path provides additional safety margin and operational flexibility.

b. VFR Approach/ Departure and Transitional Surfaces. An approach/ departure surface is centered on each approach/ departure path. Figure 4-6 illustrates the approach/ departure (primary and transitional) surfaces.

The approach/ departure path starts at the edge of the FATO and slopes upward at 8:1 (8 units horizontal in 1 unit vertical) for a distance of 4000 ft (1219 m) where the width is 500 ft (152 m) at a height of 500 ft (152 m) above the elevation of TLOF surface.

The transitional surfaces start from the edges of the FATO parallel to the flight path center line, and from the outer edges of approach/ departure surface, and extend outwards at a slope of 2:1 (2 units horizontal in 1 unit vertical) for a distance of 250 ft (76 m) from the centerline. The transitional surfaces start at the edge of the FATO opposite the approach/ departure surfaces and extend to the end of the approach/ departure surface. See Figure 4.6.

NOTE: *The transitional surface is not applied on the FATO edge opposite the approach/ departure surface.*

The approach/ departure surface should be free of penetrations. Any penetration of the transitional surface should be considered a hazard unless an FAA aeronautical study determines that it will not have a substantial adverse effect upon the safe and efficient use of this airspace. Paragraph 108b provides guidance on how to identify and mitigate such hazards to air navigation.

The transitional surfaces need not be considered if the size of the approach/ departure surface is increased for a distance of 2000 ft. (610 m) as shown in Figure 4-7. The lateral extensions on each side of the 8:1 approach/ departure surface starts at the width

of the FATO and is increased so that at a distance of 2000 ft (610 m) from the FATO it is 100 ft (30 m) wide. Penetrations of area A or area B, but not both, shown on Figure 4-7 by obstacles may be allowed providing the penetrations are marked or lighted and not considered a hazard.

NOTE: *When the standard surface is incompatible with the airspace available at the heliport site, no operations may be conducted unless helicopter performance data supports a capability to safely operate using an alternate approach/ departure surface. The site would be limited to those helicopters meeting or exceeding the required performance and approved by the FAA.*

c. Marking and Lighting of Objects that are Difficult to See. See paragraph 411.

d. Periodic Review of Obstructions. Heliport operators should reexamine obstacles in the vicinity of approach/ departure paths on at least an annual basis. This reexamination should include an appraisal of the growth of trees in close proximity to approach and departure paths. Paragraph 108 provides guidance on how to identify and mitigate obstruction hazards.

e. Curved VFR Approach/ Departure Paths. VFR approach/ departure paths may curve in order to avoid objects or noise-sensitive areas. More than one curve in the path is not recommended. Heliport designers are encouraged to use the airspace above public lands, such as freeways or rivers.

NOTE: *In the next revision of this AC, the FAA intends to provide details on the minimum dimensions of curved approach/ departure airspace.*

405.MAGNETIC RESONANCE IMAGERS (MRI). Hospital equipment, such as an MRI used in diagnostic work, can create a strong magnetic field that will cause temporary aberrations in the helicopter's magnetic compass and may interfere with other navigational systems. Heliport proponents should be alert to the location of any MRI with respect to the heliport location. A warning sign alerting pilots to the presence of an MRI is recommended. Steps should be taken to inform pilots of the locations of MRIs and other similar equipment. For additional information, see reference 42 in Appendix 4.

406.WINDSOCK.

a. Specification. A windsock conforming to AC 150/5345-27, *Specification for Wind Cone Assemblies*, should be used to show the direction and magnitude of the wind. The windsock should provide the best possible color contrast to its background.

b. Windsock Location. The windsock should be located so it provides the pilot with valid wind direction and speed information in the vicinity of the heliport under all wind conditions.

(1) The windsock should be sited so it is clearly visible to the pilot on the approach path when the helicopter is at a distance of 500 feet (152 m) from the TLOF.

(2) Pilots should also be able to see a windsock from the TLOF.

(3) To avoid presenting an obstruction hazard, the windsock should be located outside the Safety Area and it should not penetrate the approach/ departure or transitional approach/ departure surfaces.

(4) At many landing sites, there may be no single, ideal location for the windsock. At other sites, it may not be possible to site a windsock at the ideal location. Consequently, more than one windsock may be required in order to provide the pilot with all the wind information needed for safe operations.

c. Windsock Lighting. For night operations, the windsock should be internally lighted, or externally illuminated to ensure that it is clearly visible.

407.TAXIWAYS AND TAXI ROUTES. At hospital heliports with no parking or refueling area outside the TLOF(s), no taxi route or taxiway is required. If helicopters taxi outside the TLOF(s), the recommendations on paragraph 207 should be followed.

408.HELICOPTER PARKING. A separate helicopter parking area is required at heliports that will accommodate more than one helicopter at a time. At hospital heliports with a parking or refueling area outside the safety area, the recommendations in paragraph 208 should be followed.

409.HELIPORT MARKERS AND MARKINGS. Markers and/or surface markings should identify the facility as a heliport. Surface markings may be paint,

reflective paint, reflective markers, or preformed material. Lines/markings may be outlined with a 6-inch wide (15 cm) line of a contrasting color to enhance conspicuity. The following markers and markings should be used.

a. TLOF and FATO Perimeter Markings. The perimeter of the TLOF and/or FATO should be marked. The perimeter of the FATO should be defined with markers and/or lines. It is suggested that the TLOF perimeter should also be defined with markers and/or lines since this provides a greater safety margin than marking only one perimeter. However, this greater safety margin may also be achieved by increasing the size of the Safety Area. Paragraph 403a and Table 4-1 recommend that the size of the Safety Area should be increased if the TLOF perimeter is not marked. [Exception: It is recognized that the FATO perimeter will not be marked a portion of the FATO is NOT a load-bearing surface. In such cases, the TLOF perimeter should be marked.]

(1) TLOFs. The perimeter of a paved or hard-surfaced TLOF should be defined with a continuous, 12-inch wide (30 cm) white line (see Figures 4-8 and 4-9). The perimeter of an unpaved TLOF should be defined with a series of 6-inch (15 cm) wide, flush, in-ground markers, each approximately 5 feet (1.5 m) in length with end-to-end spacing of not more than 6 inches (15 cm). While a paved TLOF is not required, it is suggested in order to provide an all-weather wearing surface for helicopters and a firm working surface for hospital personnel and the wheeled equipment used in moving patients.

(2) Unpaved FATOs. The perimeter of an unpaved FATO should be defined with 12-inch-wide (30 cm) flush, in-ground markers. The corners of the FATO should be defined and the perimeter markers should be 12 inches (30 cm) in width, approximately 5 feet (1.5 m) in length, and with end-to-end spacing of approximately 5 feet (1.5 m). (See Figure 4-8).

(3) Paved FATOs. The perimeter of a paved FATO should be defined with a 12-inch wide (30 cm) dashed white line. The corners of the FATO should be defined, and the perimeter marking segments should be 12 inches (30 cm) in width, approximately 5 feet (1.5 m) in length, and with end-to-end spacing of approximately 5 feet (1.5 m). (See Figure 4-9.)

b. Hospital Heliport Identification Marking. The identification marking is intended to identify the

location as a hospital heliport, mark the TLOF, and provide visual cues to the pilot.

(1) **Standard Marking.** A red H in a white cross, with a white border if required, should mark the TLOF. The H should be oriented on the axis of the preferred approach/ departure path. A bar may be placed under the H when it is necessary to distinguish the preferred approach/ departure direction. Arrows and/or landing direction lights (see paragraph 410d) may also be used to indicate one or more preferred approach/ departure directions. Figure 4-10a illustrates the requirements of the standard hospital marking. The cross may, as an option, have a 12 inch (30 cm) red border and the background TLOF area outside the white cross can be red.

(2) **Alternative Marking.** As an alternative to the standard marking, a red H with a white 6 inch (15 cm) wide border within a red cross with a 12 inch (30 cm) wide white border and a surrounding red TLOF may be used. Where it is impractical for the whole TLOF to be painted red, the minimum dimension (length, width, or diameter) of the outer red area should be 1.0 RD of the design helicopter but not less than 40 feet (12.2 m). Figure 4-10b illustrates this alternative marking.

NOTE: *In winter weather at a heliport with a dark TLOF surface, the marking in Figure 4-10b will absorb more heat from the sun and more readily melt residual ice and snow. In contrast, the white area in upper figure in Figure 4-10a is more likely to be icy during winter weather. Consequently, in areas that experience ice and snow, the markings of in Figure 4-10b should be used for unheated TLOFs.*

c. Taxi Route and Taxiway Markings. If a hospital heliport has a taxiway or taxi route, the recommendations of paragraph 207 should be followed.

d. Apron Markings. If a hospital heliport has an apron area, the recommendations of paragraph 209d should be followed.

e. Parking Position Markings. If a hospital heliport has a parking position the recommendations of paragraph 208 should be followed.

f. Closed Heliport. All markings of a permanently closed heliport, FATO, or TLOF should be obliterated. If it is impractical to obliterate markings, a yellow X should be placed over the H, as illustrated in Figure 4-11. The yellow X should be large enough to ensure early pilot recognition that the

heliport is closed. The windsock(s) and other visual indications of an active heliport should also be removed.

g. TLOF Size Limitations. The TLOF should be marked to indicate the rotor diameter of the largest helicopter for which the TLOF is designed. (The rotor diameter should be given in feet. Metric equivalents should NOT be used for this purpose.) This marking should be centered in the lower section of a TLOF size/weight limitation 'box'. The numbers should be 3 ft (0.9 m) high (see Appendix Figure A3-1). The numbers should be black with a white background. When viewed from the preferred approach direction, this TLOF size/weight limitation 'box' should be located in the TLOF in the lower right-hand corner, or the on right-hand of a circular TLOF. (see Figure 4-12)

h. Elevated TLOF Weight Limitations. If a TLOF has limited weight-carrying capability, it should be marked, in units in thousands of pounds. (A number 12 indicates a weight-carrying capability of up to 12,000 pounds. Metric equivalents should NOT be used for this purpose.) This marking should be located in the center of the upper section of a TLOF size/weight limitation 'box' of dimensions indicated in Figure 4-12. The numbers should be 3 ft (0.9 m) high (see Appendix Figure A3-1). The numbers should be black with a white background. If the TLOF does not have a weight limit a diagonal line, extending from the lower left hand corner to the upper right hand corner, should be added to the upper section of the TLOF size/weight limitation 'box'. When viewed from the preferred approach direction, this marking should be located on the TLOF in the lower right-hand corner, as illustrated in Figure 4-12 or the lower right-hand quadrant of a circular TLOF.

i. Equipment/Object Marking. Heliport maintenance and servicing equipment, as well as other objects used in the airside operational areas, should be made conspicuous with paint, reflective paint, reflective tape, or other reflective markings. Particular attention should be given to marking objects that are hard to see in marginal visibility, such as at night, in heavy rain, or in fog.

j. Marking Obstructions Outside the Approach/ Departure Airspace. See paragraph 411.

k. Marking Proportions. See Appendix 3 for guidance on the proportions of painted numbers.

410.HELIPORT LIGHTING. For night operations, the TLOF, the FATO, taxiways and taxi routes, and the windsock need to be lighted as described within this paragraph. AC 150/5340-28, *Low Visibility Taxiway Lighting System*; AC 150/5340-24, *Runway and Taxiway Edge Lighting System*; and AC 150/5345-46, *Specification for Runway and Taxiway Light Fixtures*; contain technical guidance on lighting equipment and installation details. Heliport lighting ACs are available at <http://faa.gov/arp>

a. Ground-level TLOF-Perimeter Lights.

Flush green lights should define the TLOF perimeter. A minimum of three flush light fixtures is recommended per side of a square or rectangular TLOF. A light should be located at each corner with additional lights uniformly spaced between the corner lights with a maximum interval of 25 feet (8 m) between lights. An even number of lights (at least eight should be used) uniformly spaced, with a maximum interval of 25 feet (8 m) between lights may be used to define a circular TLOF. Flush lights should be located within 1 foot (30 cm) inside or outside of the TLOF perimeter. Figure 4-13 illustrates these lights.

If only the TLOF is load bearing flush lights are recommended, but raised green omni-directional lights may be used. Raised lights should be located outside and within 10 foot (3m) of the edge of the TLOF and should not penetrate a horizontal plane at the TLOF elevation by more than 2 inches (5 cm).

b. Elevated TLOF-Perimeter Lights. The TLOF perimeter should be lit with green lights. If flush lights are used, they should be located within 1 foot of the TLOF perimeter. If raised omni-directional lights are used, they should be located on the outside edge of the TLOF or outer edge of the safety net, as shown in Figure 4-4. The raised lights should not penetrate a horizontal plane at the TLOF elevation by more than 2 inches (5 cm). In areas where it snows in the winter, the outside edge is the preferred location. (Lights on the inside edge of the safety net are prone to breakage during snow removal.) Lighting on the outside edge also provides better visual cues to pilots at a distance from the heliport since they outline a larger area.

c. Load Bearing FATO-Perimeter Lights.

Green lights should define the perimeter of a load-bearing FATO. A minimum of three flush or raised light fixtures is recommended per side of a square or rectangular FATO. A light should be located at each corner with additional lights uniformly spaced

between the corner lights, with a maximum interval of 25 feet (7.6 m) between lights. An even number of lights (at least eight should be used) uniformly spaced with a maximum interval of 25 feet (7.6 m) between lights may be used to define a circular FATO.

NOTE: *In the case of an elevated FATO with a safety net, the perimeter lights should be mounted in a similar manner as discussed in Paragraph 4-10b.*

(1) At a distance during nighttime operations, a square or rectangular pattern of FATO perimeter lights provides the pilot with better visual cues than a circular pattern. Thus, a square or rectangular pattern of FATO perimeter lights is preferable even if the TLOF is circular.

(2) If flush lights are used, they should be located within 1 foot (30 cm) inside or outside of the FATO perimeter. See Figure 4-13.

(3) If raised light fixtures are used, they should be no more than 8 inches (20 cm) high and should be located 10 feet (3.05 m) out from the FATO perimeter. (See Figure 4-14.)

d. Landing Direction Lights. Landing direction lights are an optional feature to be installed when it is necessary to provide directional guidance. Landing direction lights are a configuration of five yellow, omni-directional L-861 lights on the centerline of the preferred approach/ departure path. These lights are spaced at 15ft (4.6 m) intervals beginning at a point not less than 20 feet (6 m) and not more than 60 feet (18 m) from the TLOF perimeter and extending outward in the direction of the preferred approach/ departure path, as illustrated in Figure 4-15.

e. Taxi Route and Taxiway Lighting. See paragraph 407.

f. Heliport Identification Beacon. A heliport identification beacon is optional equipment. It should be installed when it is needed to aid the pilot in visually locating the heliport. When installed, the beacon, flashing white/green/yellow at the rate of 30 to 45 flashes per minute, should be located on or close to the heliport. Guidance on heliport beacons is found in AC 150/5345-12, *Specification for Airport and Heliport Beacon*. There may be merit in making operation of the beacon controllable from the approaching helicopter to ensure it is “on” only when required.

g. Floodlights. Floodlights may be used to illuminate the TLOF, the FATO, and/or the parking area. To eliminate the need for tall poles, these floodlights may be mounted on adjacent buildings. Care should be taken, however, to place floodlights clear of the TLOF, the FATO, the Safety Area, and the approach/ departure surfaces and any required transitional surfaces. Care should be taken to ensure that floodlights and their associated hardware do not constitute an obstruction hazard. Floodlights should be aimed down and provide a minimum of 3-foot candles (32 lux) of illumination on the apron surface. Floodlights that might interfere with pilot vision during takeoff and landings should be capable of being turned off.

h. Lighting of Obstructions. See paragraph 411.

411.MARKING AND LIGHTING OF OBSTRUCTIONS. Marking and lighting of obstructions within the approach/ departure airspace is discussed in paragraph 108b. This paragraph discusses marking and lighting of obstructions in close proximity but outside and below the approach/ departure surface.

a. Background. Unmarked wires, antennas, poles, cell towers, and similar objects are often difficult to see, even in the best daylight weather, in time for a pilot to successfully take evasive action. While pilots can avoid such objects during en route operations by flying well above them, approach and departure require operation near the ground where obstacles may be in close proximity.

b. Airspace. If difficult-to-see objects penetrate the object identification surfaces illustrated in Figure 4-16, these objects should be marked to make them more conspicuous. If operations are conducted at a heliport between dusk and dawn, these difficult-to-see objects should be lighted. Guidance on marking and lighting objects is contained in AC 70/7460-1, *Obstruction Marking and Lighting*. The object identification surfaces in Figure 4-16 can also be described as follows:

(1) In all directions from the Safety Area, except under the approach/ departure paths, the object identification surface starts at the Safety Area perimeter and extends out horizontally for a distance of 100 feet (30.5 m).

(2) Under the approach/ departure surface, the object identification surface starts from the outside edge of the FATO and extends horizontally

out for a distance of 800 feet (244 m). From this point, the object identification surface extends out for an additional distance of 3,200 feet (975 m) while rising on a 8:1 slope (8 units horizontal in 1 unit vertical). From the point 800 feet (244 m) from the FATO perimeter, the object identification surface is 100 feet (30.5 m) beneath the approach/ departure surface.

(3) The width of the safety surface increases as a function of distance from the Safety Area. From the Safety Area perimeter, the object identification surface extends laterally to a point 100 feet (30.5 m) outside the Safety Area perimeter. At the upper end of the surface, the object identification surface extends laterally 200 feet (61 m) on either side of the approach/ departure path.

c. Shielding of Objects. If there are a number of obstacles in close proximity, it may not be necessary to mark all of them if they are shielded. To meet the shielding guidelines an object would be shielded by existing structures of a permanent and substantial character or by natural terrain or topographic features of equal or greater height, and would be located in the congested area of a city, town, or settlement where it is evident beyond all reasonable doubt that the structure so shielded will not adversely affect safety in air navigation. Additional guidance on this topic may be found in 14 CFR Part 77.15(a), Construction or alterations not requiring notice.

412.SAFETY ENHANCEMENTS. Some safety enhancements to be considered in the design of a heliport are discussed below. Other areas such as the effects of rotor downwash may need to be addressed based on site conditions and the design helicopter.

a. Access Limitations. The operational areas of a hospital heliport should be kept clear of people, animals, and vehicles. The method used to control access depends upon the helicopter location and types of potential intruders.

(1) Safety Barrier. At ground-level hospital heliports, one method is to erect a safety barrier around the helicopter operational areas. This barrier may take the form of a fence, wall, or hedge. It should be no closer to the operating areas than the outer perimeter of the Safety Area. Barriers should not penetrate any approach/ departure (primary or transitional) surface. Thus, in the vicinity of the approach/ departure paths, the barrier may need to be well outside the outer perimeter of the Safety Area.

(2) Any barrier should be high enough to present a positive deterrent to persons inadvertently entering an operational area and yet low enough to be non-hazardous to helicopter operations.

(3) Guards and barriers. Hospital heliport operators may choose to secure their operational areas via the use of security guards and a mixture of fixed and movable barriers. Training of personnel should be considered as a part of any security program.

(4) Access. At some locations, it may be appropriate to restrict access to airside areas through controlled entryways. Entryways should display a cautionary sign similar to that illustrated in Figure 4-17. Training of personnel should be considered as a part of any security program.

b. Rescue and Fire Fighting Services. Heliports should meet the criteria of NFPA 418, Standards for Heliports, and NFPA 403, Aircraft Rescue Services and applicable state/local codes. A fire hose cabinet or extinguisher should be provided at each access gate/door and each fueling location. At elevated TLOFs, fire hose cabinets, fire extinguishers, and other fire fighting equipment should be located adjacent to, but below the level of, the TLOF. NFPA standards are available at National Fire Protection Association web site <http://www.nfpa.org>.

c. Turbulence. Air flowing around and over buildings, stands of trees, terrain irregularities, etc. can create turbulence that may affect helicopter operations. (Reference 41 in Appendix 4.)

(1) Ground-level Heliports. Helicopter operations from sites immediately adjacent to buildings and other large objects are subjected to air turbulence effects caused by such features. Therefore, it may be necessary locate the TLOF away from such objects in order to minimize air turbulence in the vicinity of the FATO and the approach/departure paths.

(2) Elevated Heliports. Elevating heliports 6 feet (1.8 m) or more above the level of the roof will generally minimize the turbulent effect of air flowing over the roof edge. While elevating the platform helps reduce or eliminate the air turbulence effects, a safety net may be required (see paragraph 401e (4)).

d. Communications. A UNICOM radio may be used to provide arriving helicopters with heliport and traffic advisory information but may not be used

to control air traffic. The Federal Communications Commission (FCC) should be contacted for information on UNICOM licensing.

e. Weather Information. An AWOS measures and automatically broadcasts current weather conditions at the heliport site. When an AWOS is installed, it should be located at least 100 feet (30.5 m) and not more than 700 feet (213 m) from the TLOF perimeter. Locate the AWOS so that its instruments will NOT be affected by rotor wash from helicopter operations. Guidance on AWOS systems is found in AC 150/5220-16, *Automated Weather Observing Systems (AWOS) for Non-Federal Applications*.

f. Winter Operations. Swirling snow raised by a helicopter's rotor wash can cause the pilot to lose sight of the intended landing point. Swirling snow on takeoff can hide objects that need to be avoided. At least the TLOF, the FATO, and as much of the Safety Area as practical should be kept free of snow. Heliport design should take into account the methods and equipment to be used for snow removal. The heliport design should allow the snow to be removed sufficiently so the snow will not present an obstruction hazard to either the tail rotor or the main rotor. Guidance on winter operations is found in AC150/5200-30, *Airport Winter Safety and Operations*. (Exception: In cases where the FATO is much larger than the minimum requirement, it may not be necessary to clear all of this additional area.)

413.ZONING AND COMPATIBLE LAND USE.

Where state and local statutes permit, the hospital heliport sponsor is encouraged to promote the adoption of the following zoning measures to ensure that the heliport will continue to be available and to protect the investment in the facility.

a. Zoning to Limit Building/Object Heights. General guidance on drafting an ordinance that would limit building and object heights is contained in AC 150/5190-4, *A Model Zoning Ordinance to Limit Height of Objects Around Airports*. The ordinance should substitute the heliport surfaces on the model ordinance.

b. Zoning for Compatible Land Use. A zoning ordinance may be enacted, or an existing ordinance modified, to control the use of property within the heliport approach/ departure path environment. The ordinance should restrict activities to those that area compatible with helicopter operations.

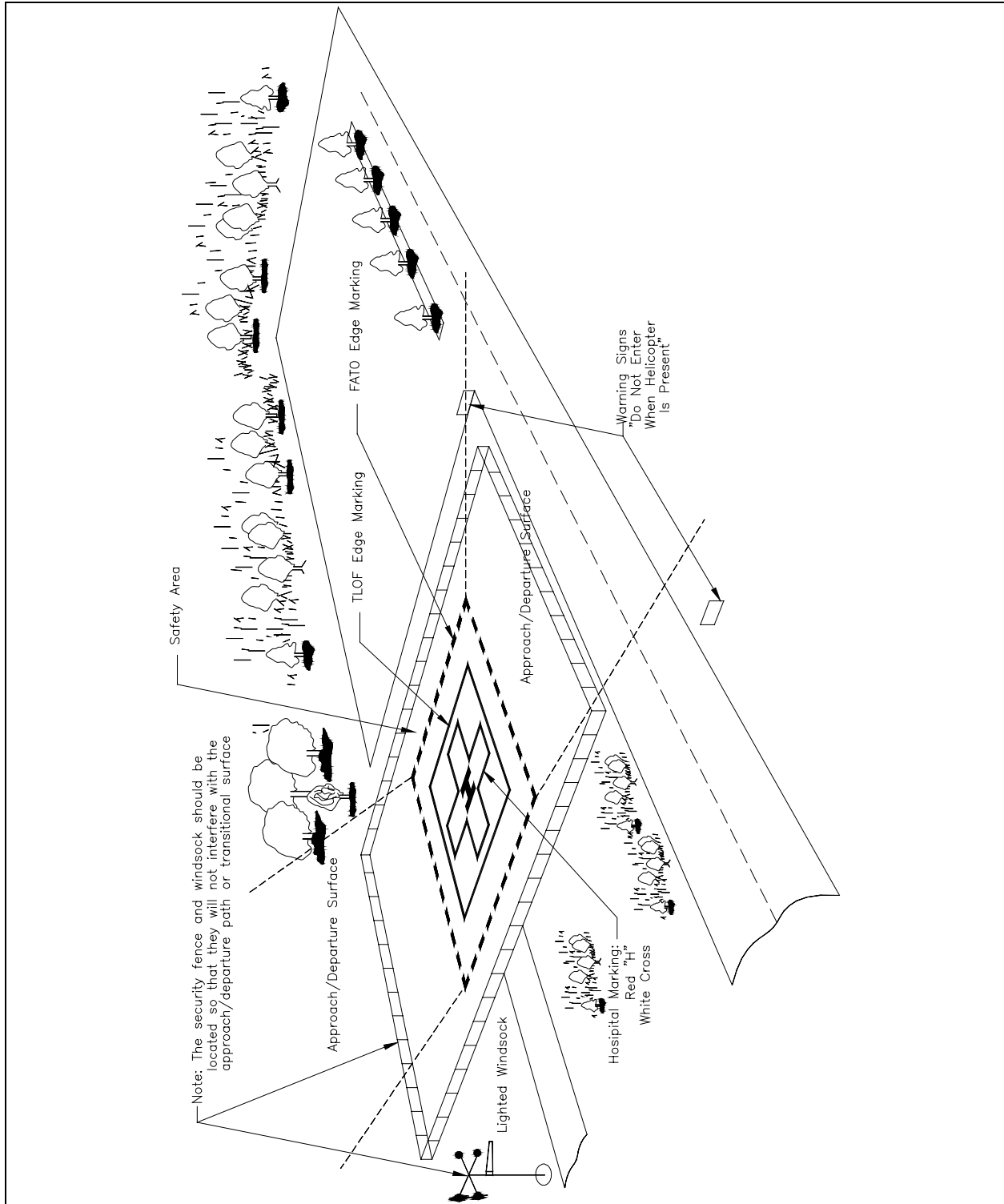
c. **Air Rights and Property Easements** are options that may be used to prevent the encroachment of obstacles in the vicinity of a heliport.

Table 4-1. Minimum VFR Safety Area Width as a Function Hospital Heliport Markings

TLOF perimeter marked:	Yes	Yes	No	No
FATO perimeter marked:	Yes	Yes	Yes	Yes
Standard Hospital marking symbol:	Yes	No	Yes	No
Hospital heliports:	1/3 RD but not less than 10 ft (3 m)**	1/3 RD but not less than 20 ft (6 m)**	½ OL but not less than 20 ft (6 m)	½ OL but not less than 30 ft (9 m)

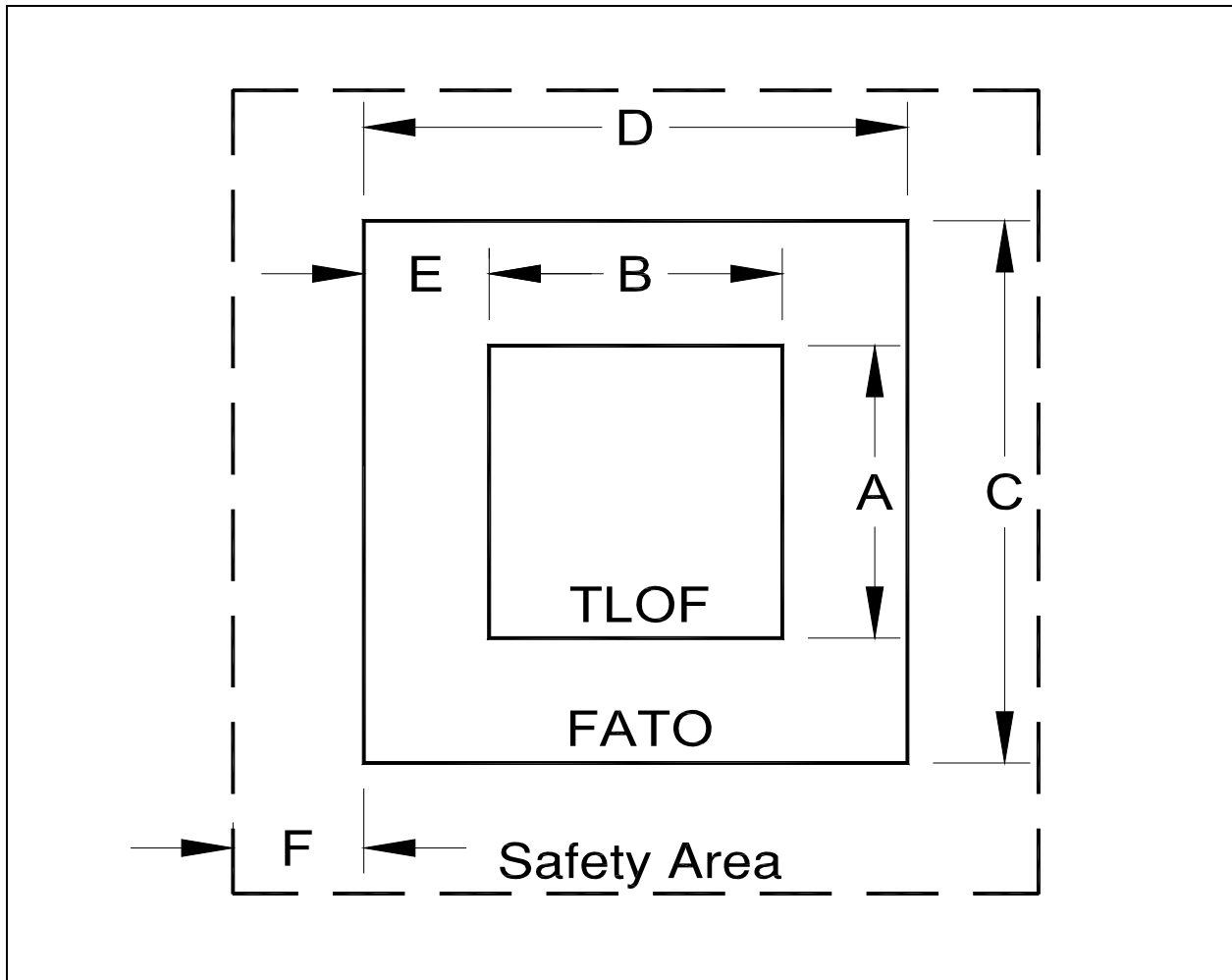
OL: overall length of the design helicopter
 RD: rotor diameter of the design helicopter

** Also applies when the FATO is NOT marked. The FATO should not be marked if (a) the FATO (or part of the FATO) is a non-load bearing surface and (b) the TLOF is elevated above the level of a surrounding load bearing area.



NOTE: Rotor diameter and weight limitation markings are not shown for simplicity.

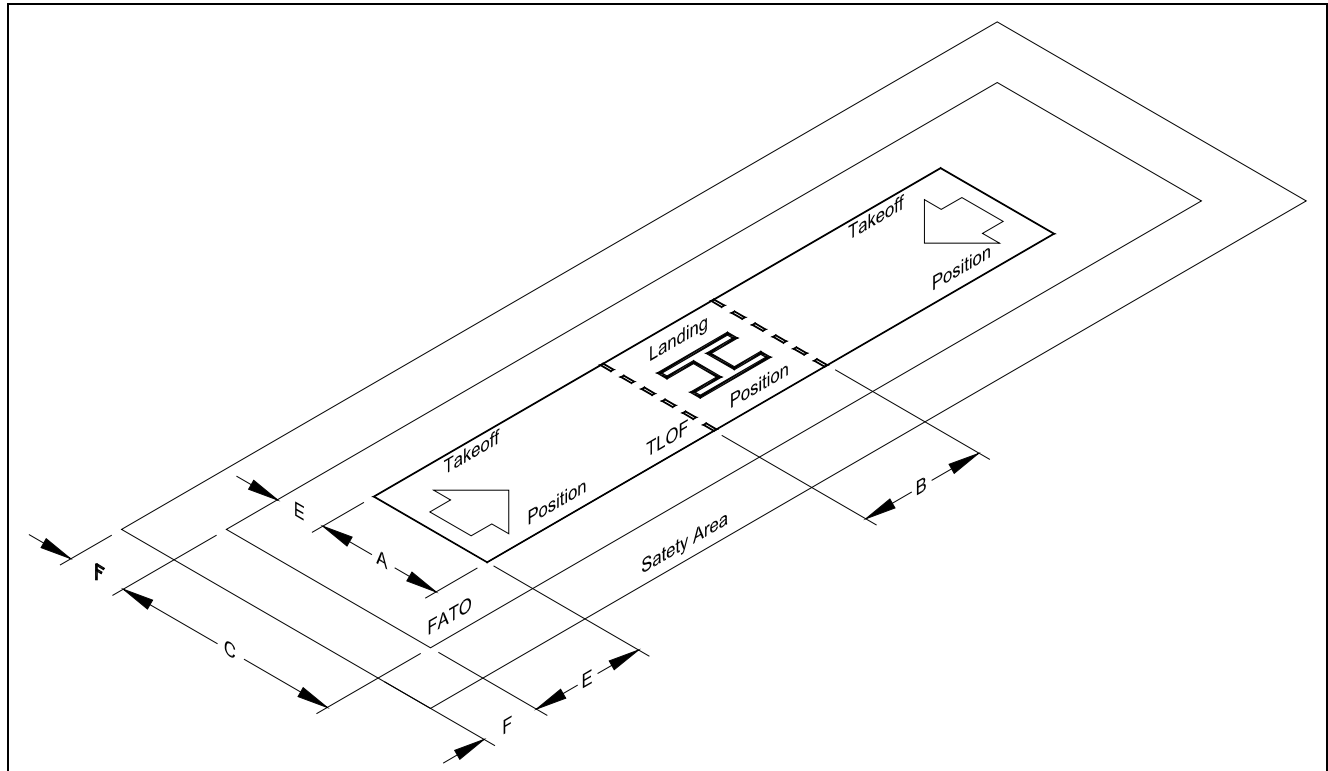
**Figure 4-1. Essential Elements of a Ground-level Hospital Heliport:
HOSPITAL**



- A – Minimum TLOF Width: 1.0 RD but not less than 40 ft. (12 m)
- B – Minimum TLOF Length: 1.0 RD but not less than 40 ft. (12 m)
- C – Minimum FATO Width: 1.5 OL
- D – Minimum FATO Length: 1.5 OL
- E – Minimum separation between the perimeters of the TLOF and the FATO $[0.5(1.5 OL - 1.0 RD)]$
- F – Minimum Safety Area Width: See Table 4-1

RD: Rotor diameter of the design helicopter
 OL: Overall length of the design helicopter

**Figure 4-2. TLOF/FATO/Safety Area Relationships and Minimum Dimensions:
 HOSPITAL**



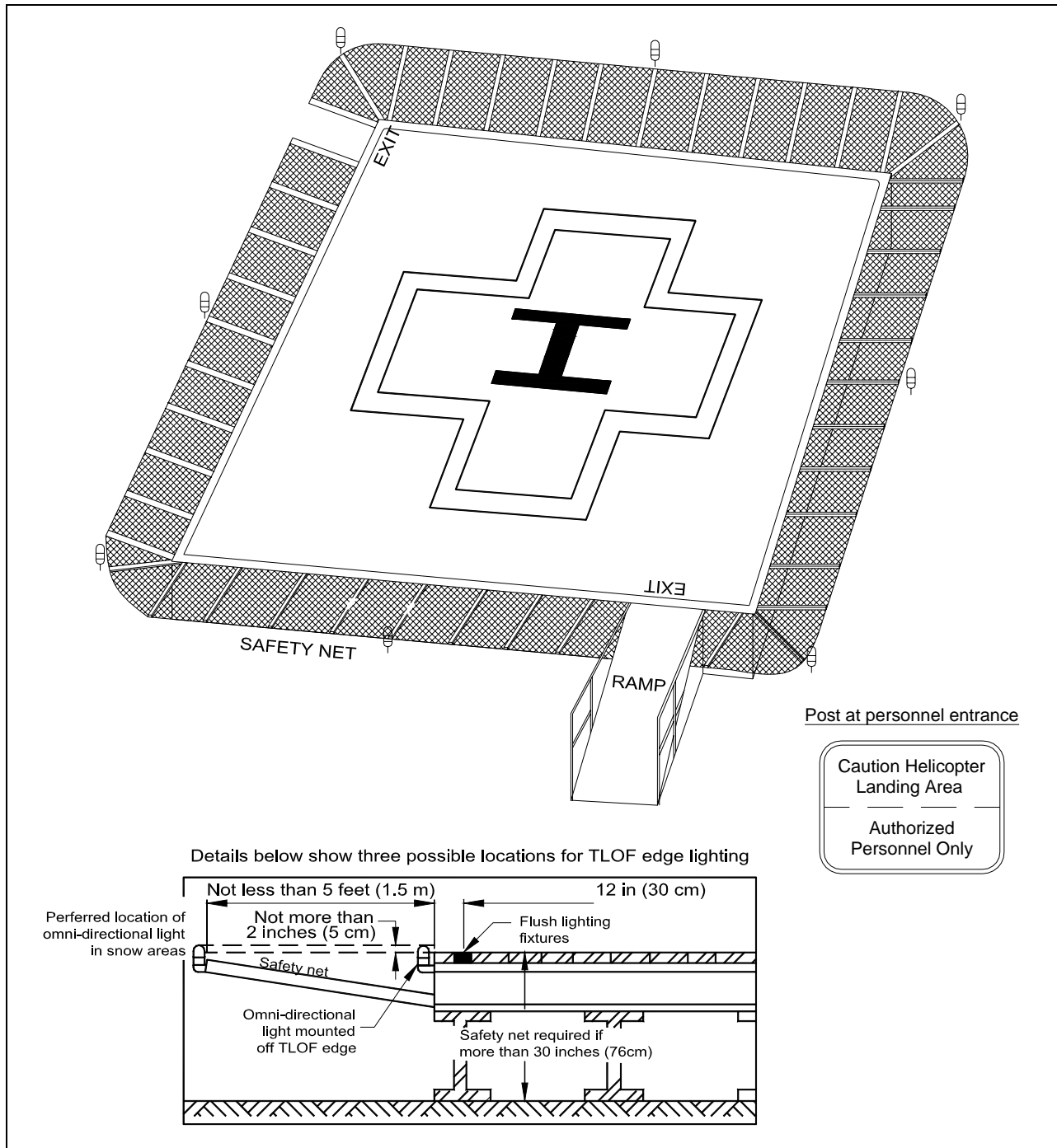
- A. Minimum TLOF width: 1.0 RD but not less than 40 ft (12 m)
- B. Minimum landing position length: 1.0 RD but not less than 40 ft (12 m)
- C. Minimum FATO width: 1.5 OL
- E. Minimum separation between the perimeters of the TLOF and the FATO [$0.5(1.5 OL - 1.0 RD)$]
- F. Minimum Safety Area width: See Table 4-1

RD: Rotor diameter of the design helicopter

OL: Overall length of the design helicopter

NOTE: Rotor diameter and weight limitation markings are not shown for simplicity.

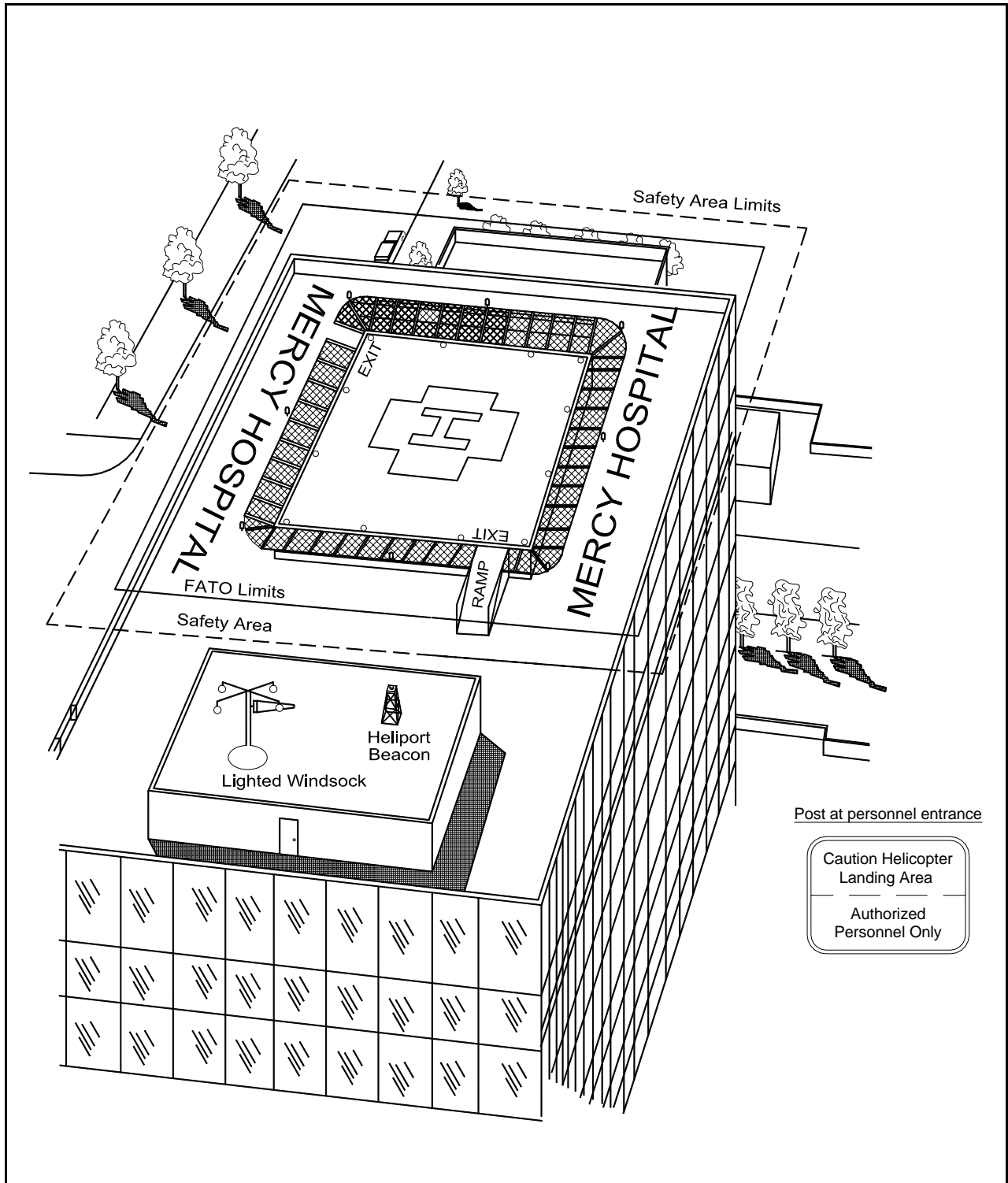
**Figure 4-3. An Elongated FATO/TLOF with Two Takeoff Positions:
HOSPITAL**



NOTE:

Rotor diameter and weight limitation markings are not shown for simplicity.

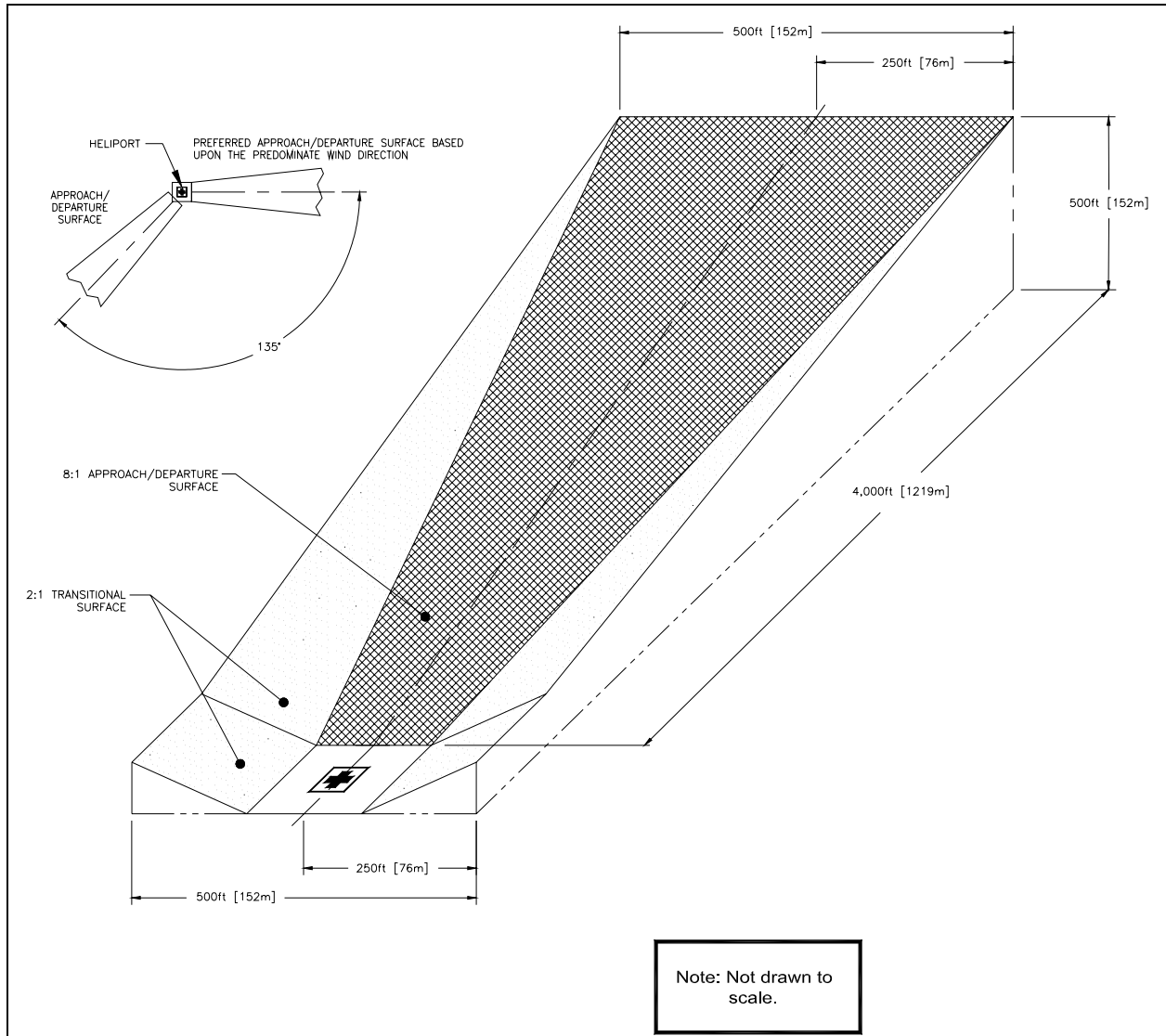
**Figure 4-4. Elevated TLOF, Safety Net and Lighting:
HOSPITAL**



NOTE:

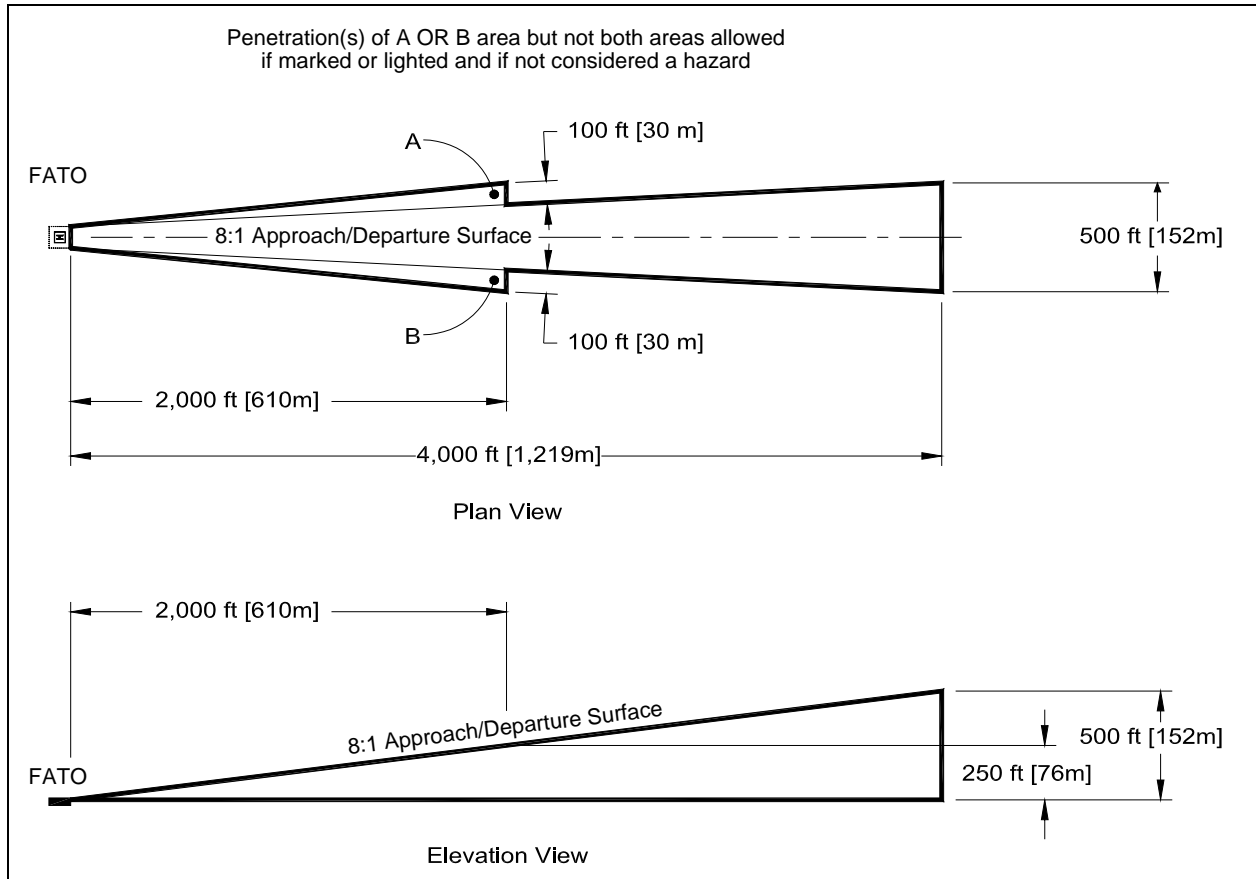
Rotor diameter and weight limitation markings are not shown for simplicity.

**Figure 4-5. A Rooftop Hospital Heliport:
HOSPITAL**

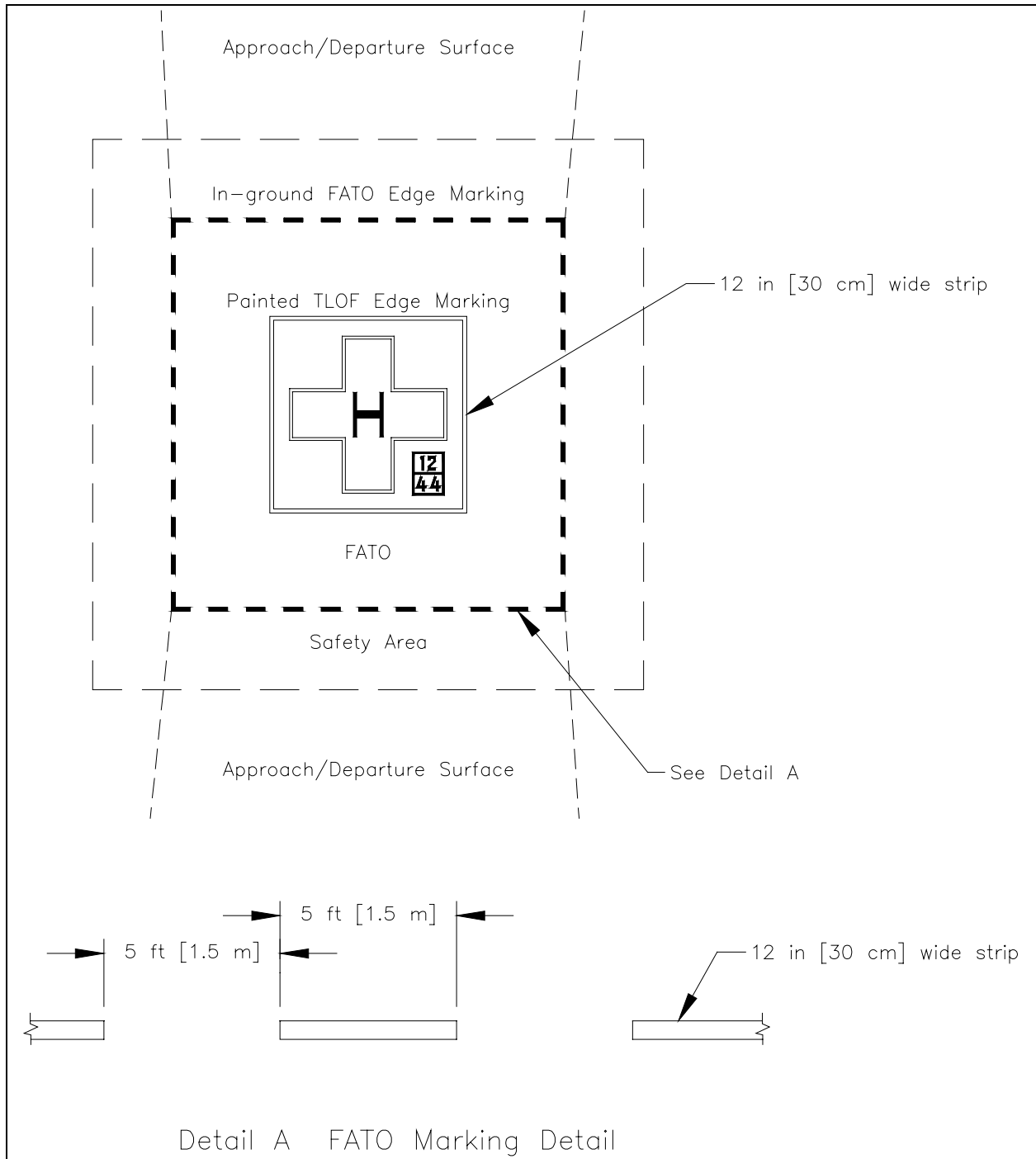


NOTE: Rotor diameter and weight limitation markings are not shown for simplicity.

**Figure 4-6. VFR Heliport Approach/ Departure and Transitional Surfaces:
HOSPITAL**



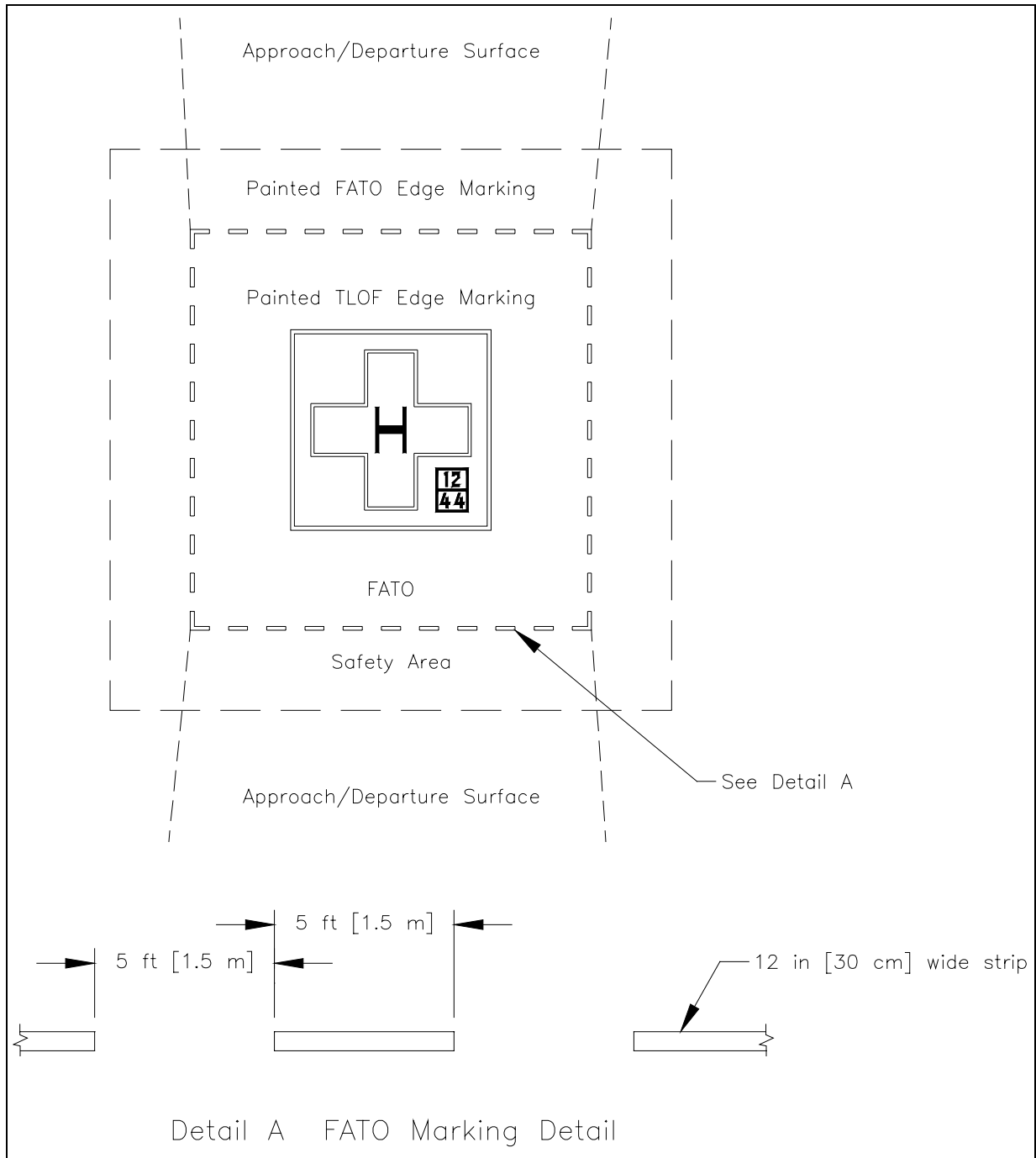
**Figure 4-7. VFR Heliport Lateral Extension of the 1:8 Approach/ Departure Surface:
HOSPITAL**



NOTES:

1. The H should be oriented on the axis of the preferred approach/ departure path.
2. The perimeter of a paved or hard- surfaced TLOF should be defined with a continuous, 12-inch wide (30 cm) white line.
3. The perimeter of an unpaved FATO should be defined with flush, in-ground markers. (See detail A) The corners of the FATO should be defined.
4. See Figure 4-12 for markings for weight and rotor diameter limitations.

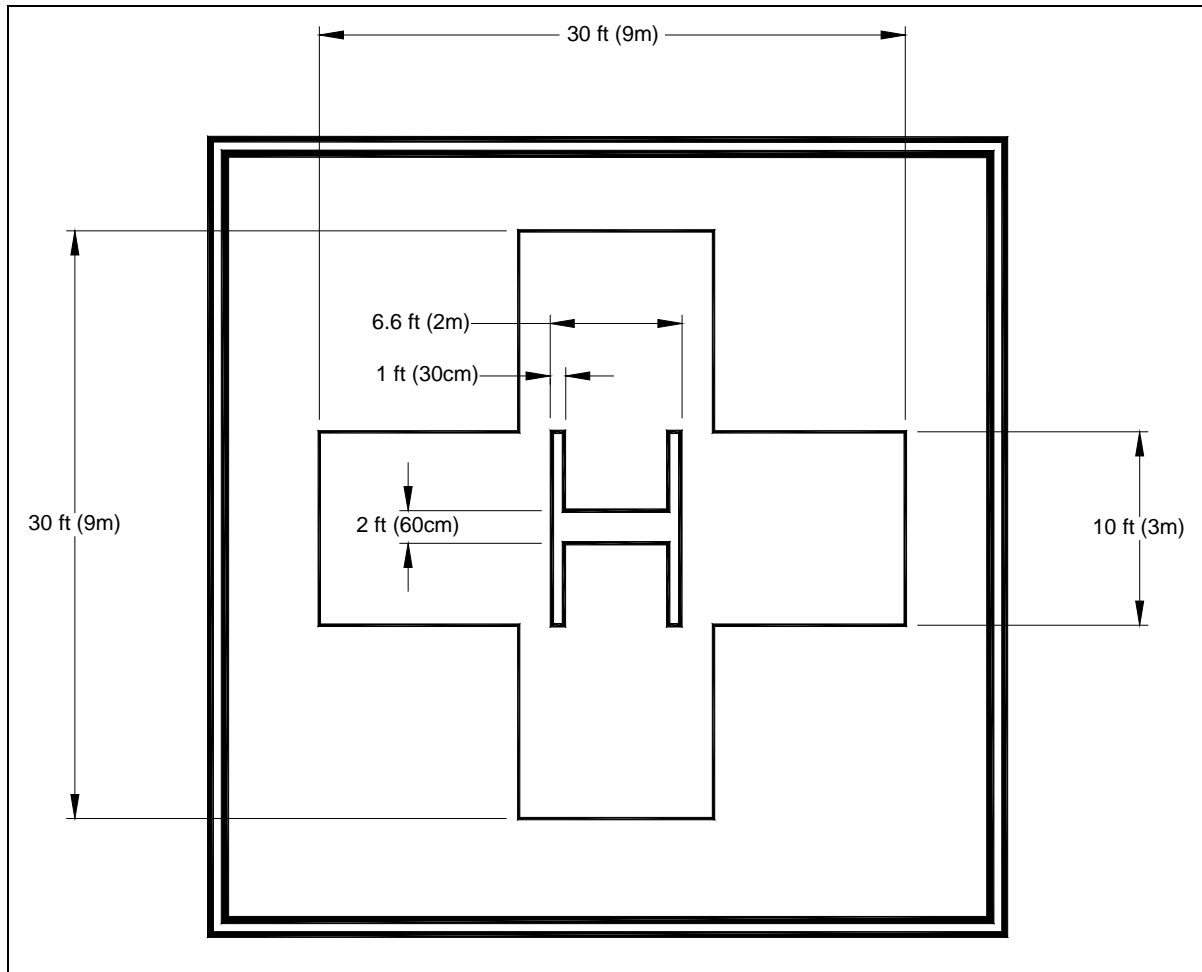
**Figure 4-8. Paved TLOF/Unpaved FATO – Markings:
HOSPITAL**



NOTES:

1. The **H** should be oriented on the axis of the preferred approach/ departure path.
2. The perimeter of a paved or hard-surfaced TLOF should be defined with a continuous, 12-inch wide (30 cm) white line.
3. The perimeter of a paved FATO should be defined with a 12-inch wide (30 cm) dashed white line approximately 5 feet (1.5 m) in length, and with end-to-end spacing of approximately 5 feet (1.5 m). The corners of the FATO should be defined. (See detail B)
4. See Figure 4-10 for dimensions for the **H** and hospital cross markings.

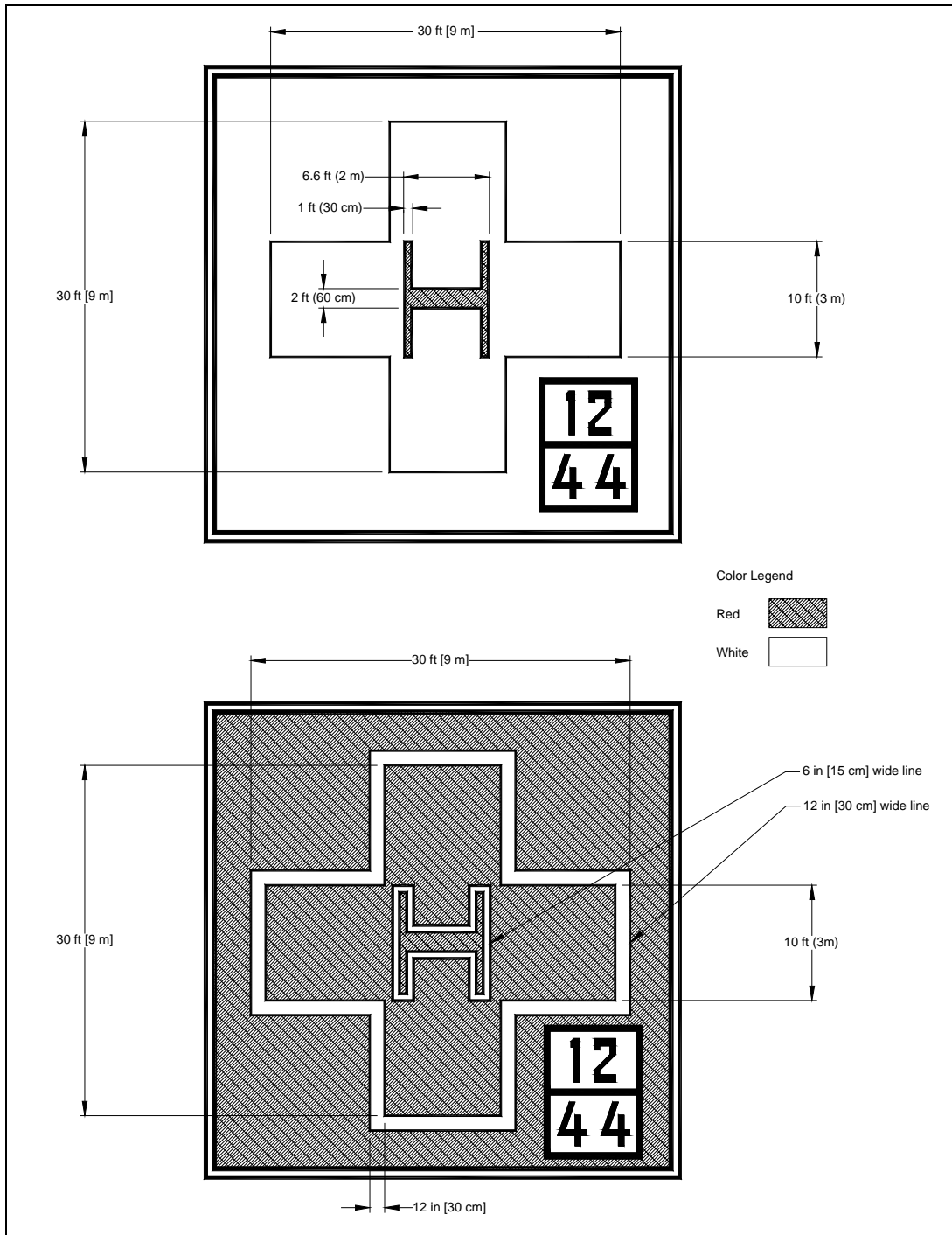
**Figure 4-9. Paved TLOF/Paved FATO – Markings:
HOSPITAL**



NOTES:

1. The standard hospital identification is a red **H** surrounded by a white cross.
2. An option may be a red **H** within a white cross surrounded by a 12 inch (30 cm) wide red border. (not illustrated)
3. The area outside of the cross may be colored red.
4. The surrounding box is a continuous 6 inch (15 cm) wide white TLOF perimeter marking.

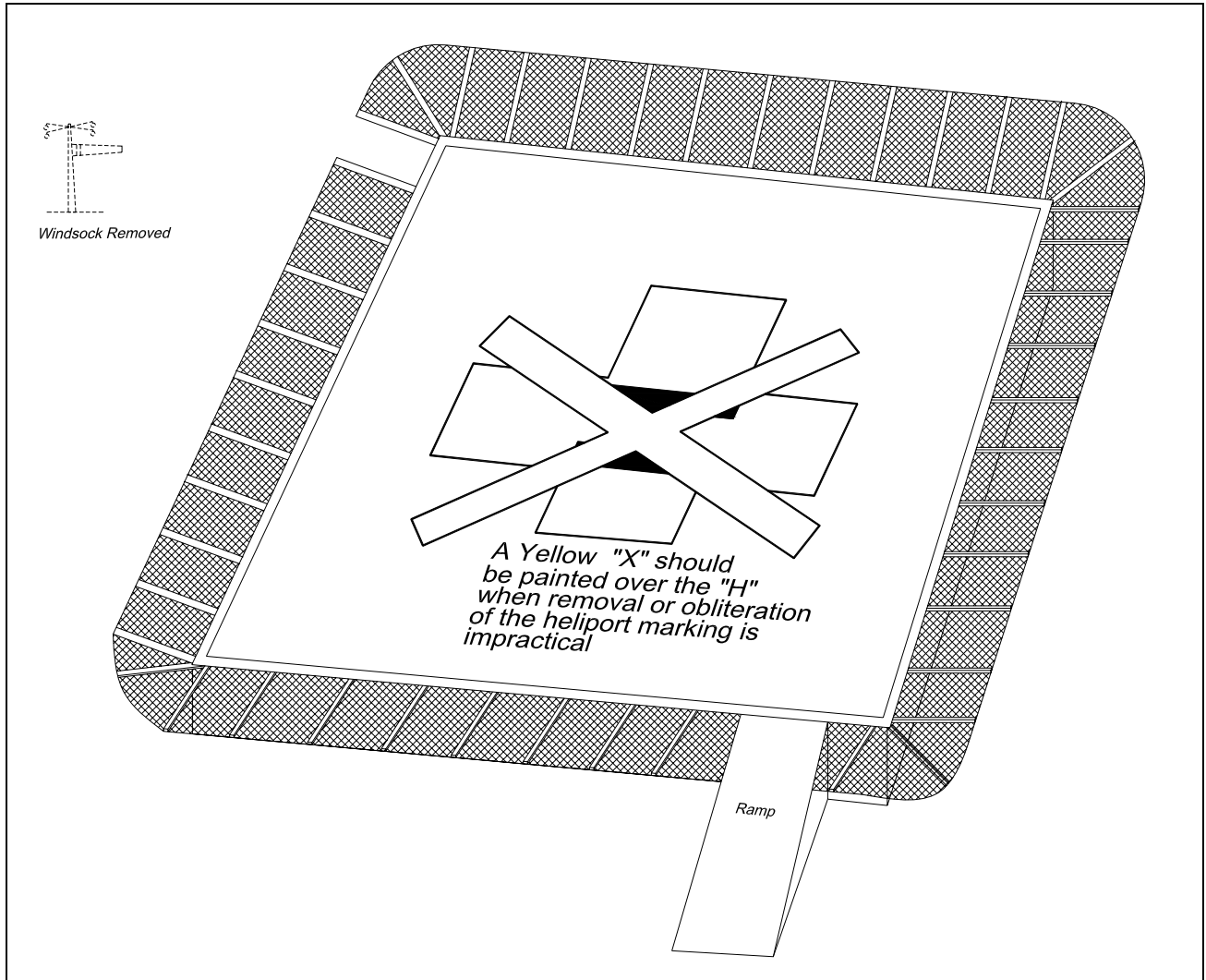
**Figure 4-10a. Standard Hospital Heliport Identification Symbols:
HOSPITAL**



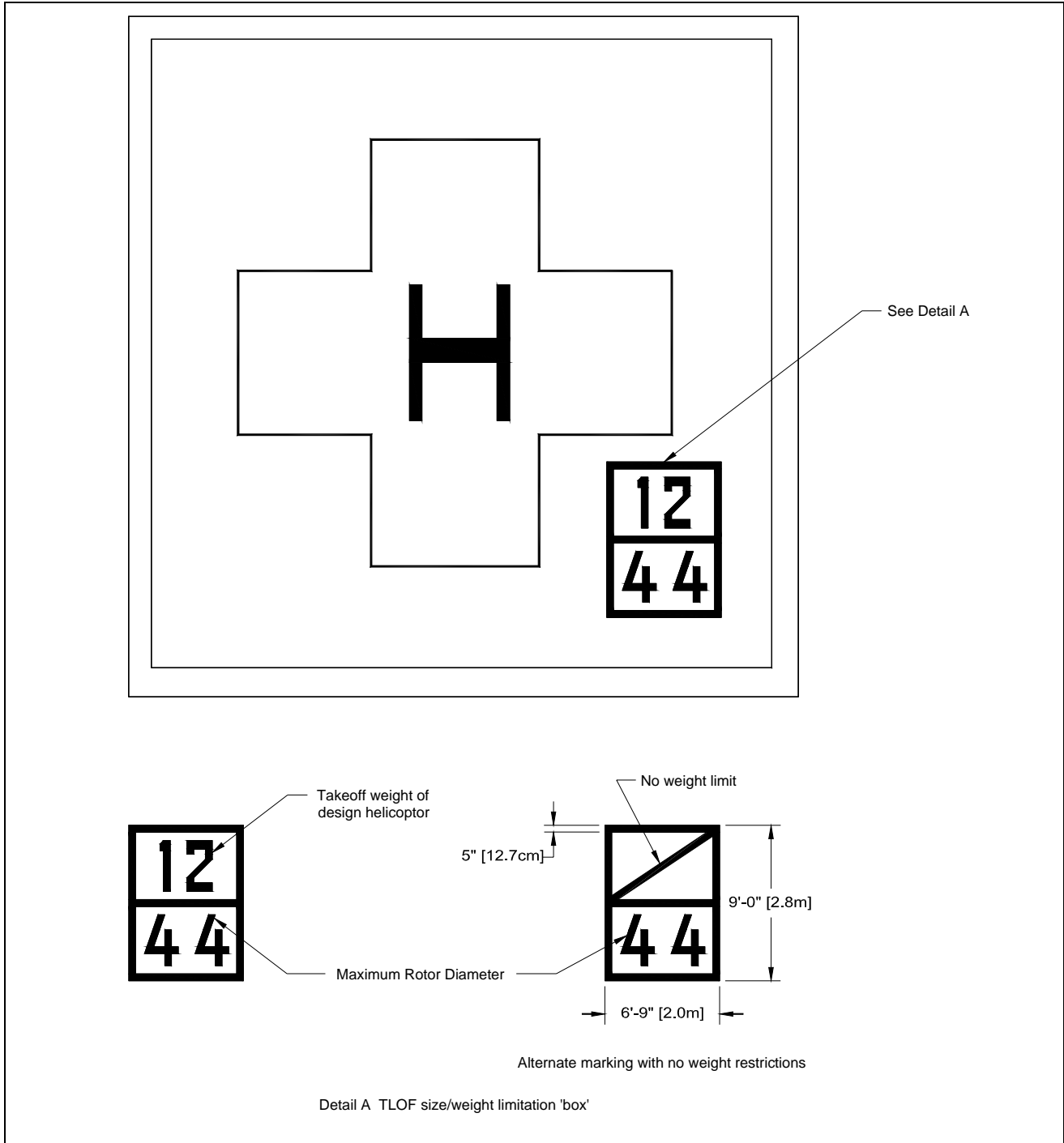
NOTES:

1. An alternative hospital heliport marking may be a red H with a white 6 inch (15 cm) wide border within a red cross with a 12 inch (30 cm) wide white border and a surrounding red TLOF.
2. The surrounding box is a continuous 6 inch (15 cm) wide white TLOF perimeter marking.

**Figure 4-10b: Alternative Hospital Heliport Identification Symbols:
HOSPITAL**



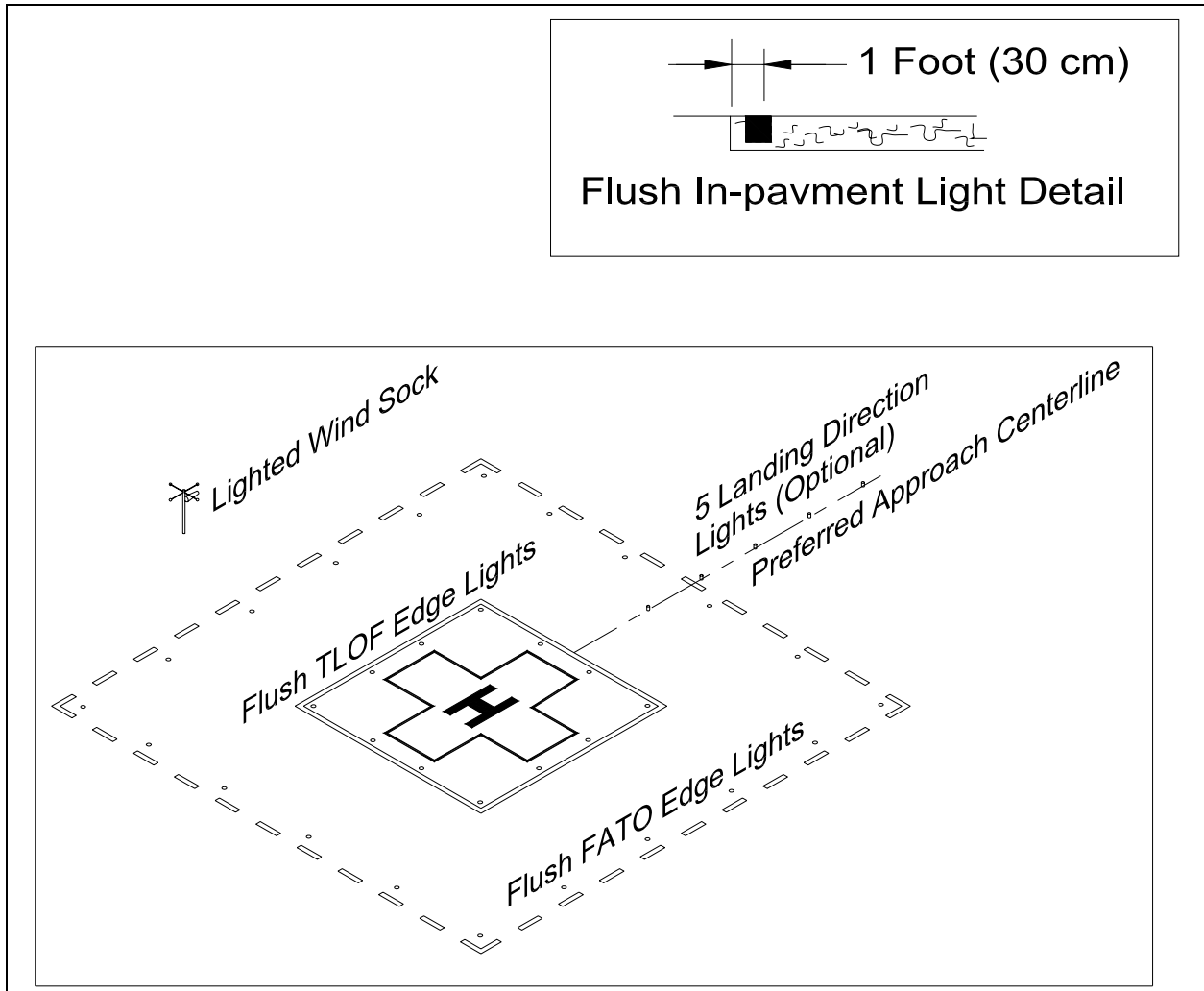
**Figure 4-11. Marking a Closed Heliport:
HOSPITAL**



NOTES:

1. See Appendix 3 for the form and proportion of the numbers used on the size and weight limitations.
2. **12** Indicates the TLOF has limited weight-carrying capability shown in thousands of pounds.
3. **44** indicates the rotor diameter of the largest helicopter for which the TLOF is designed.

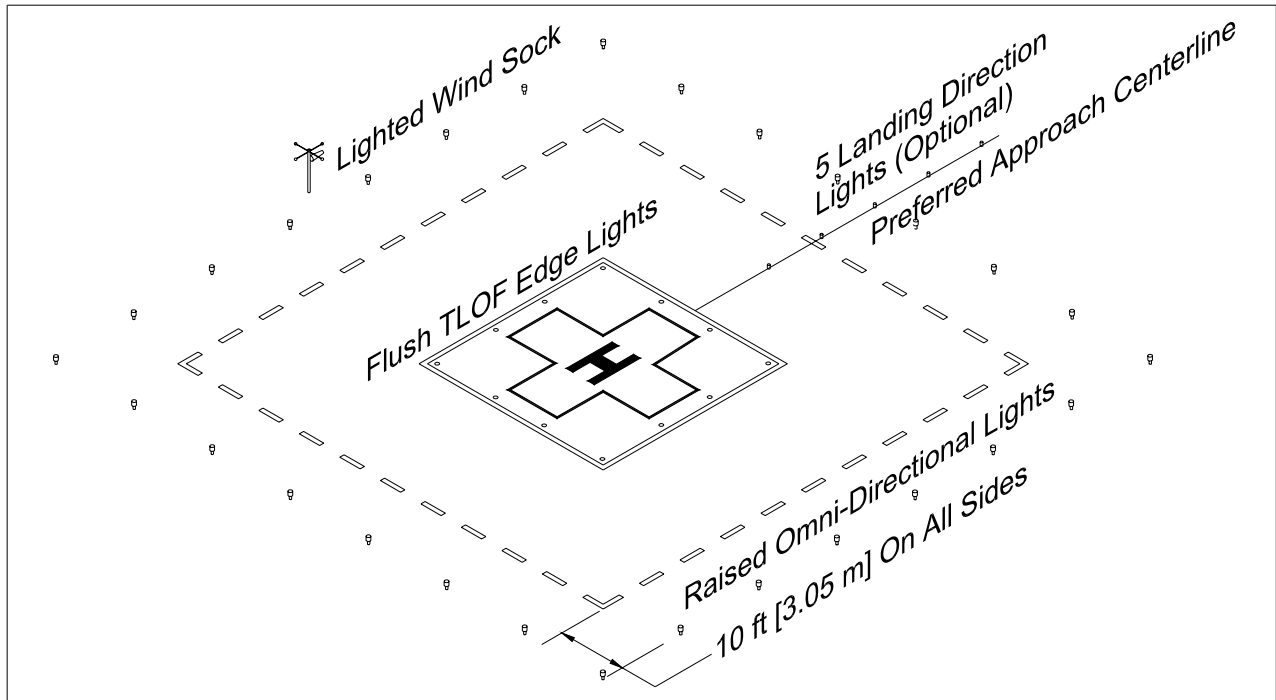
**Figure 4-12. TLOF Size and Weight Limitations:
HOSPITAL**



NOTES:

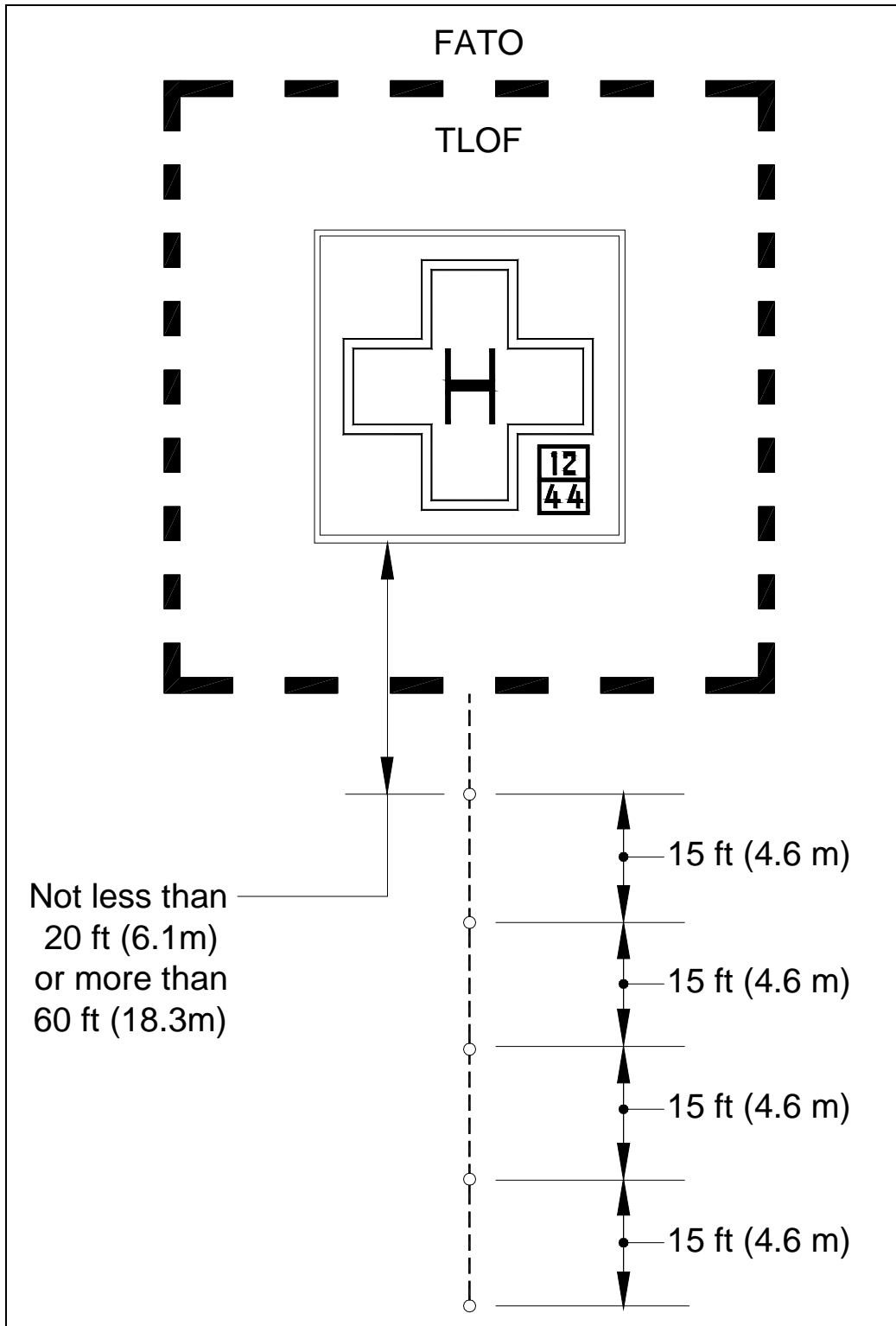
1. Flush FATO and TLOF lights may be installed inside or outside ± 1 -foot of the FATO and TLOF respective perimeters.
2. Rotor diameter and weight limitation markings are not shown for simplicity.

**Figure 4-13. Flush FATO and TLOF Perimeter Lighting:
HOSPITAL**

**NOTES:**

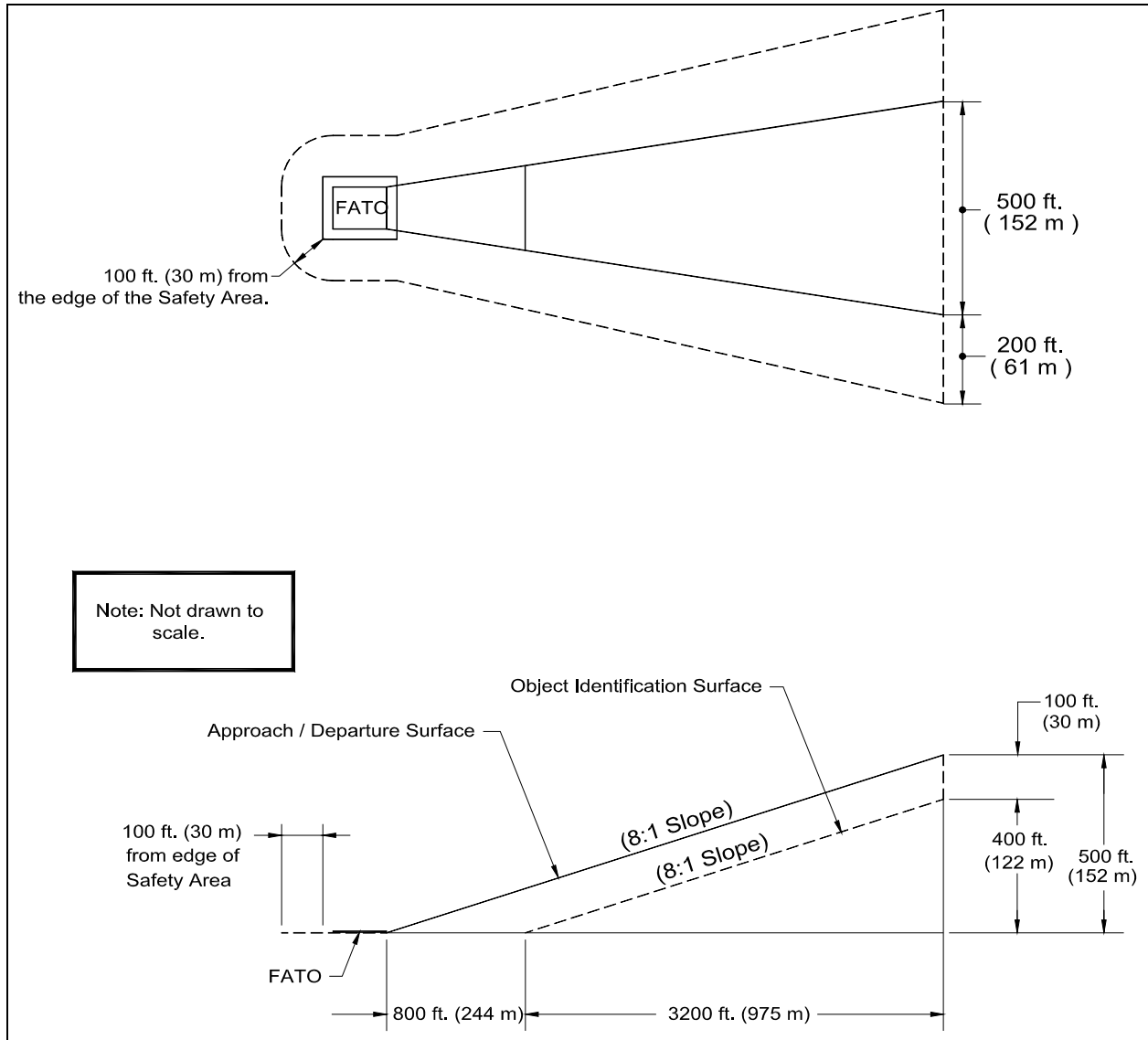
1. Flush TLOF lights may be installed inside or outside ± 1 -foot of the TLOF perimeter.
2. Raised FATO lights may be installed 10 ft (18.3 m) outside the perimeter of the FATO.
3. Rotor diameter and weight limitation markings are not shown for simplicity.

**Figure 4-14. Flush TLOF and Raised FATO Perimeter Lighting:
HOSPITAL**



NOTE: yellow omni-directional lights

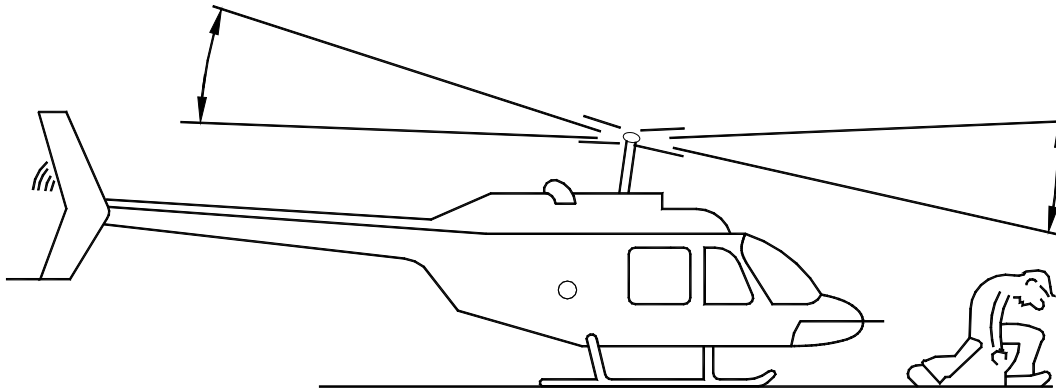
**Figure 4-15. Landing Direction Lights:
HOSPITAL**



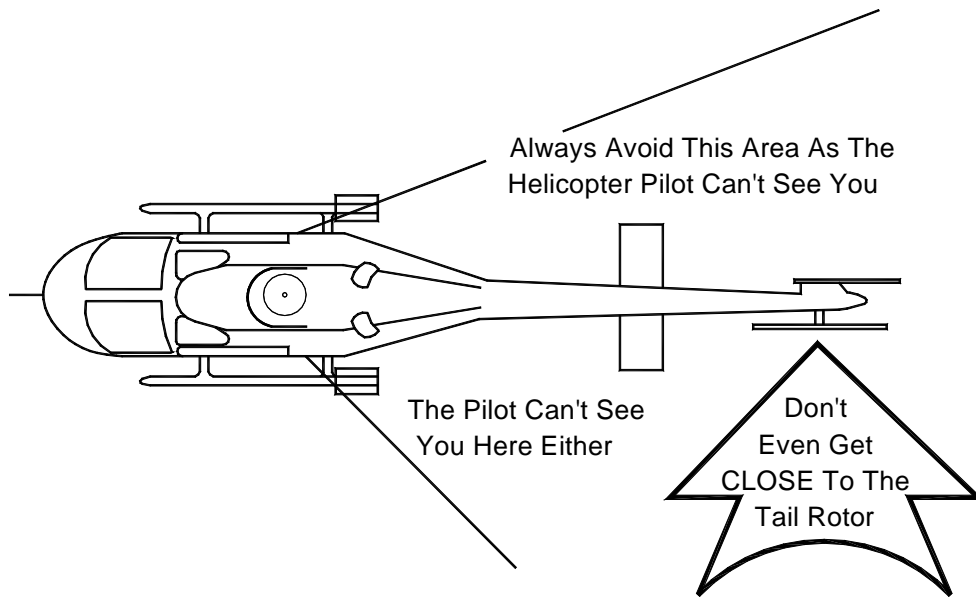
**Figure 4-16. Airspace Where Marking and Lighting Are Recommended:
HOSPITAL**

BE ALERT

AROUND THE HELICOPTER



Approach And Leave The Helicopter In A Crouched Manner When Rotors Are Turning



**Figure 4-17. Caution Sign:
HOSPITAL**

CHAPTER 5. HELICOPTER FACILITIES ON AIRPORTS

500.GENERAL. Helicopters are able to operate on most airports without unduly interfering with airplane traffic. Separate facilities and approach/ departure procedures may be necessary when the volume of airplane and/or helicopter traffic impacts operations. At airports with interconnecting passenger traffic, the terminal apron should provide gates for helicopter boarding. Persons who use a helicopter to go to an airport generally require convenient access to the airport terminal and the services provided to airplane passengers. The airport layout plan (ALP) should be amended or revised to identify the location of the exclusive-use helicopter facilities, TLOFs, FATOs, Safety Areas, approach/ departure paths, and helicopter taxi routes and taxiways. This chapter addresses design considerations for providing separate helicopter facilities on airports. Figure 5-1 shows an example of a heliport located on an airport. Other potential heliport locations are on the roofs of passenger terminals or parking garages serving passenger terminals.

501.TOUCHDOWN AND LIFT-OFF AREA (TLOF). The TLOF should be located and designed to provide ready access to the airport terminal or to the helicopter user's origin or destination. TLOF dimensions and clearances described in Chapter 2 should be applied to facilities being developed for GA helicopter usage on an airport. TLOF dimensions and clearances given in Chapter 3 should be applied to facilities being developed for transport helicopter usage on an airport.

502.FINAL APPROACH AND TAKEOFF AREA (FATO).

a. FATO dimensions. FATO dimensions and clearances described in Chapter 2 should be applied to facilities being developed for GA helicopter usage on an airport. FATO dimensions and clearances given in Chapter 3 should be applied to facilities being developed for transport helicopter usage on an airport.

b. Spacing Criteria. The recommended distance between the centerline of an approach to a runway and the centerline of an approach to a FATO for simultaneous, same direction, VFR operations is provided in Table 5-1.

503.SAFETY AREA. Safety Area dimensions and clearances described in Chapter 2 should be applied to facilities being developed on an airport for GA helicopter usage. Safety Area dimensions and clearances given in Chapter 3 should be applied to facilities being developed on an airport for transport helicopter usage.

504.VFR APPROACH/ DEPARTURE PATHS. For GA helicopter operations, each FATO/TLOF should have at least two approach/ departure paths meeting the criteria in Chapter 2. For transport helicopter operations, each FATO/TLOF should have at least two approach/ departure paths meeting the criteria in Chapter 3. To the extent practical, helicopter approach/ departure paths should be independent of approaches to and departures from active runways.

505.PROTECTION ZONE. The protection zone is the area under the approach/ departure path starting at the FATO perimeter and extending out for a distance of 280 feet (85.3 m) for GA facilities and 400 feet (122 m) for Transport facilities, as illustrated in Figures 2-8 and 3-7. In the event of an engine failure, the protection zone provides an emergency landing site that would minimize the risk of injury or damage to property on the ground. The heliport proponent should own or control the property containing the protection zone. This control should include the ability to clear incompatible objects and to preclude the congregation of people.

506.WINDSOCK. The recommendations in Chapter 2 should be applied to facilities being developed on an airport for GA helicopter usage. The recommendations in Chapter 3 should be applied to facilities being developed on an airport for Transport helicopter usage.

507.TAXIWAYS AND TAXI ROUTES. Facilities being developed for GA helicopter usage on an airport should meet or exceed the taxiway and taxi route dimensions and clearances in Chapter 2. Facilities being developed for Transport helicopter usage on an airport should meet or exceed the taxiway and taxi route dimensions and clearances in Chapter 3.

a. Ground Taxiing and Hover Taxiing. When exclusive helicopter taxiways or taxi routes are

developed at an airport, they should be located to minimize interaction with airplane operations.

b. Air Taxiing. Air taxiing at elevations approximately 100 feet (30.5 m) above the surface is often preferred when helicopters must traverse long distances across an airport.

508.HELICOPTER PARKING. Helicopter parking positions should be located as close to the intended destination or origination of the passengers as conditions and safety permit. Parking area dimensions and clearances given in Chapter 2 should be applied to facilities being developed for GA helicopter usage on an airport. Parking area dimensions and clearances described in Chapter 3 should be applied to facilities being developed for Transport helicopter usage on an airport. Parking positions should be located to minimize the risk of damage from helicopter rotor wash.

509.HELIPORT MARKERS AND MARKINGS. The recommendations in Chapter 2 should be applied to facilities being developed on an airport for GA helicopter usage. The recommendations in Chapter 3 should be applied to facilities being developed on an airport for Transport helicopter usage.

510.HELIPORT LIGHTING. The recommendations in Chapter 2 should be applied to facilities being developed on an airport for GA helicopter usage. The recommendations in Chapter 3 should be applied to facilities being developed on an airport for Transport helicopter usage.

511.MARKING AND LIGHTING OF OBSTRUCTIONS. The recommendations in Chapter 2 should be applied to facilities being developed on an airport for GA helicopter usage. The recommendations in Chapter 3 should be applied to facilities being developed on an airport for Transport helicopter usage.

512.SAFETY ENHANCEMENTS.

a. Security. The operational areas of a heliport need to be kept clear of people, animals, and vehicles. Ground-level general aviation heliports may require fenced operational areas to prevent the inadvertent or unauthorized entry of persons, animals, or vehicles. Fences should be as low as possible and located as far as possible from the FATO. Fences should not penetrate any approach/departure (primary or transitional) surface. Access to airside areas should be through controlled and locked

gates or doors that display a cautionary sign similar to that illustrated in Figure 2-27.

b. Rescue and Fire Fighting Services. Heliports should meet the criteria of NFPA Pamphlet 418, Standards for Heliports, and NFPA Pamphlet 403, Aircraft Rescue Services. A firehose cabinet or extinguisher should be provided at each access gate and each fueling location. Firehose cabinets, fire extinguishers, and other fire fighting equipment at elevated TLOFs should be located adjacent to, but below the level of, the TLOF. NFPA standards are available at National Fire Protection Association web site <http://www.nfpa.org>.

c. Communications. A UNICOM radio may be used to provide arriving helicopters with heliport and traffic advisory information but may not be used to control air traffic. The Federal Communications Commission (FCC) should be contacted for information on UNICOM licensing.

d. Weather. An AWOS measures and automatically broadcasts current weather conditions at the heliport site. When an AWOS is installed, it should be located at least 100 feet (30.5 m) and not more than 700 feet (213 m) from the TLOF perimeter. Locate the AWOS so its instruments will NOT be affected by rotor wash from helicopter operations. Guidance on AWOS systems is found in AC 150/5220-16, *Automated Weather Observing Systems (AWOS) for Non-Federal Applications*.

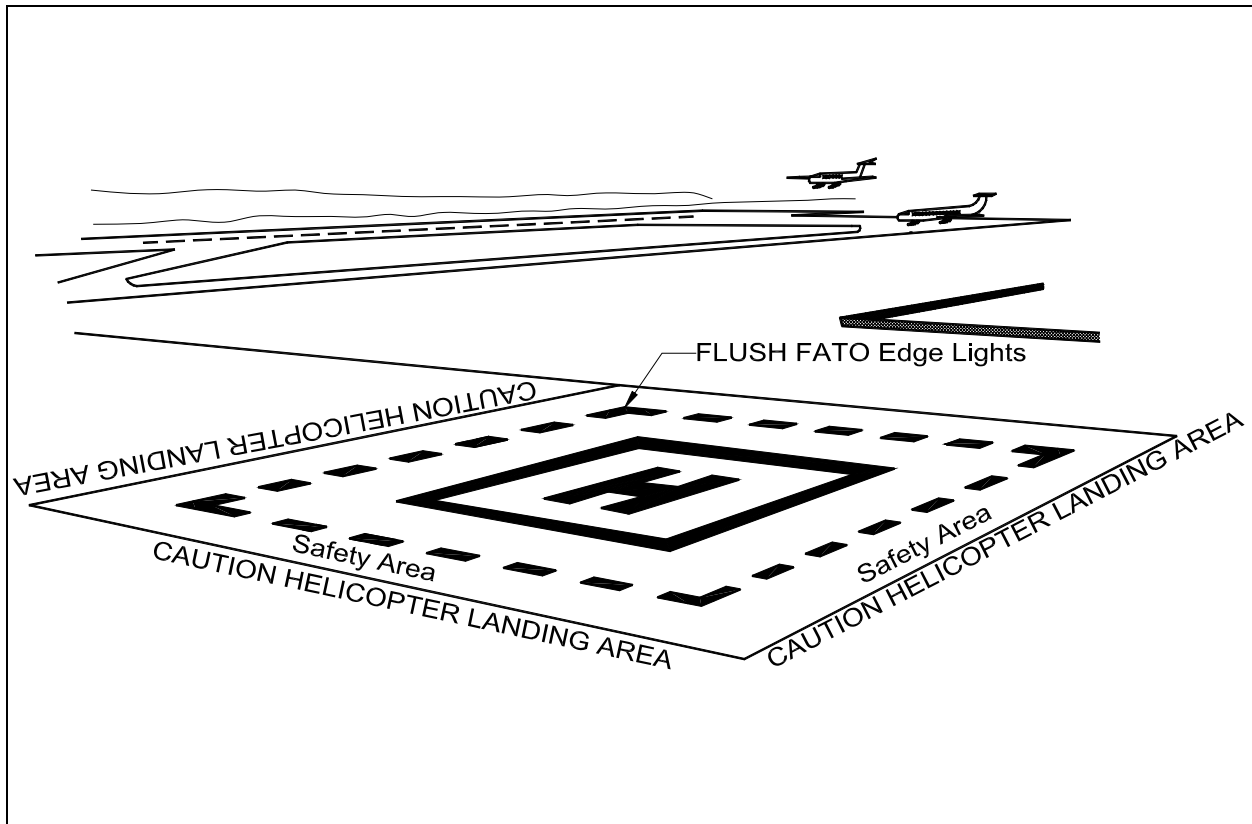
e. Winter Operations. Swirling snow raised by a helicopter's rotor wash can cause the pilot to lose sight of the intended landing point. Swirling snow on takeoff can hide objects that need to be avoided. At least the TLOF, the FATO, and as much of the Safety Area as practical, should be kept free of snow. Heliport design should take into account the methods and equipment to be used for snow removal. The heliport design should allow the snow to be removed sufficiently so the snow will not present an obstruction hazard to either the tail rotor or the main rotor. Guidance on winter operations is found in AC 150/5200-30, *Airport Winter Safety and Operations*. [Exception: In cases where the FATO is much larger than the minimum requirement, it may not be necessary to clear all of this additional area.]

513.VISUAL GLIDESLOPE INDICATORS. The recommendations in Chapter 2 should be applied to facilities being developed on an airport for GA helicopter usage. The recommendations in Chapter 3 should be applied to facilities being

developed on an airport for Transport helicopter usage.

514.PASSENGER SERVICES. The heliport terminal requires curbside access for passengers using private autos, taxicabs, and public transit vehicles. Public waiting areas need the usual amenities, and a counter for rental car services may be desirable. Passenger auto parking areas should accommodate current requirements and have the capability of being expanded to meet future requirements. Readily available public transportation may reduce the requirement for employee and service personnel auto parking spaces. The heliport terminal building or sheltered waiting area should be attractive and functional. AC 150/5360-9, *Planning and Design of Airport Terminal Facilities at Non-Hub Locations*, contains guidance on designing terminal facilities. The AC is available at the Airports web site <http://faa.gov/arp>.

Unless screening was carried out at the helicopter passengers' departure location, Transportation Security Administration regulations may require that a screening area and/or screening be provided before passengers enter the airport's secured areas. Multiple helicopter parking positions and/or locations may be needed in the terminal area to service helicopter passenger screening and/or cargo interconnecting needs. Information about passenger screening is available at Transportation Security Administration web site <http://www.tsa.gov/public/>.



**Figure 5-1. A Heliport Located on an Airport:
ON AIRPORT**

Table 5-1. Recommended Distance Between FATO Center to Runway Centerline for VFR Operations

Column 1	Column 2	Column 3	Column 4
	Small Helicopter 6,000 lbs or less	Medium Helicopter 6,001 to 12,000 lbs	Heavy Helicopter over 12,000 lbs
Small Airplane 12,500 lbs or less	300 feet (91 m)	500 feet (152 m)	700 feet (213 m)
Large Airplane 12,000 lbs to 300,000 lbs	500 feet (152 m)	500 feet (152 m)	700 feet (213 m)
Heavy Airplane Over 300,000 lbs	700 feet (213 m)	700 feet (213 m)	700 feet (213 m)

CHAPTER 6. NONPRECISION INSTRUMENT OPERATIONS

600.GENERAL. Non-precision approach/ departure missed approach procedures permit helicopter operations to continue during periods of reduced visibility. Non-precision procedures are established in accordance with FAA Order 8260.3. Volume 5 United States Standard for Terminal Instrument Procedures (TERPS) and FAA Order 8260.42, *Helicopter Non-precision Approach Criteria Utilizing the Global Positioning System (GPS)*. The FAA Orders are available at the AFS 420 web site <http://av-info.faa.gov/terps/>.

The following criteria for the improved lighting system and increased airspace are recommended.

a. Early FAA Contact Urged. This chapter addresses issues that heliport owners should consider before requesting the development of non-precision approach/ departure/missed approach procedures. The recommendations and standards in this AC are not intended to be sufficient to design an instrument procedure. Heliport owners desiring instrument procedures are urged to initiate early contact with the appropriate FAA Flight Procedures Office.

b. Non-precision Approach Airspace. Those who design non-precision approach/ departure/missed approach procedures have some flexibility in the design of such procedures. For this and other reasons, the clear airspace required to support non-precision operations is complex, and it does not lend itself to simple description, even using figures. Consequently, the figures in this chapter do NOT describe the full range of possibilities in this regard. Refer to the latest revision of FAA Order 8260.42 for more detailed information.

601.IMPROVED LIGHTING SYSTEM. Perimeter lighting enhancement and the Heliport Instrument Lighting System (HILS), illustrated in Figure 6-1, are recommended.

NOTE: *Lower visibility minimums may be possible if a Heliport Approach Lighting System (HALS) is installed (see Figure 7-2).*

a. FATO Perimeter Lighting Enhancement. An additional raised, green L-861SE light is inserted between each light in the front and rear rows of the raised perimeter lights to enhance the definition of the FATO.

b. HILS Lights. The HILS consists of 24 uni-directional PAR 56, 200-watt white lights that extend the FATO perimeter lights. The system extends both the right and left edge lights as “edge bars” and both the front and rear edge lights as “wing bars,” as shown in Figure 6-1.

(1) **Edge Bars.** Edge bar lights are spaced at 50-foot (15.2 m) intervals, measured from the front and rear row of the FATO perimeter lights.

(2) **Wing Bars.** Wing bar lights are spaced at 15-foot (4.57 m) intervals, measured from the line of FATO perimeter (side) lights.

c. Optional TLOF Lights. An optional feature is a line of seven white flush L-850A lights spaced at 5-foot (1.5 m) intervals installed in the TLOF pavement. These lights are aligned on the centerline of the approach course to provide close-in directional guidance and improve TLOF surface definition. These lights are illustrated in Figures 6-1.

602.OBSTACLE EVALUATION SURFACES. The following surfaces are evaluated for object penetrations.

a. Final Approach Segment Surfaces. Figure 6-2 illustrates these surfaces.

(1) FAA Order 8260.42 defines a Waypoint Tolerance Area around the Missed Approach Point (MAP). This area extends from a line 0.3 nmi [1823 feet] (556 M) prior to the MAP (known as the Earliest Point MAP) to a line 0.3 nmi [1823 feet] (556 m) past the MAP (known as the Latest Point MAP). Within this area and laterally to the primary course boundary, the obstacle evaluation surface is 250 feet (76.2 m) beneath the elevation of the MAP.

(2) **Primary Area Obstacle Evaluation Surfaces.** The obstacle evaluation surface extends longitudinally from the Final Approach Fix (FAF) to the Earliest Point MAP and laterally to the primary boundaries on each side of the final course centerline. At the FAF, the obstacle evaluation surface is at an elevation 250 feet (76.2 m) below the FAF. At the Earliest Point MAP, the obstacle evaluation surface is at an elevation 250 feet below (76.2 m) the MAP.

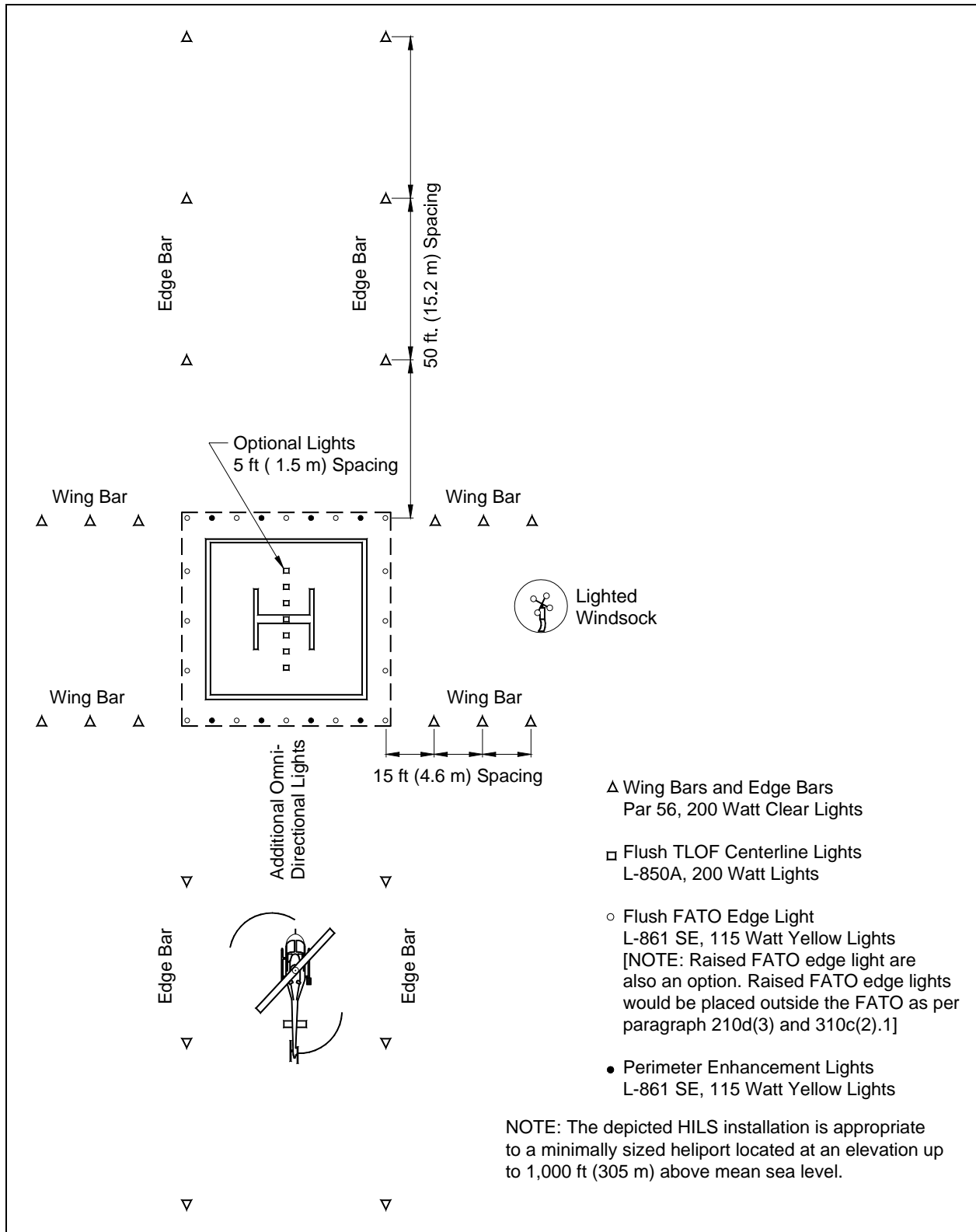
(3) Secondary Area Obstacle Evaluation Surfaces. The obstacle evaluation surface extends longitudinally from the FAF to the Latest Point MAP and laterally from the edge of the primary boundary to the edge of the secondary boundary. At the primary boundary, the secondary obstacle evaluation surface is at the same elevation as the primary obstacle evaluation surface. Moving laterally, the secondary obstacle evaluation surface rises uniformly to an elevation 250 feet (76.2 m) higher than its elevation at the primary boundary.

b. Visual Segment of the Non-precision Approach. The approach surface is a trapezoidally shaped plane starting at the visual segment reference line (VSRL) at the TLOF elevation. It begins at a width of 150 feet (46 m) and flares outward to a width of approximately 0.8 nmi [4,861 feet] (1,482 m). The surface rises upward on a slope that is one degree less than the visual segment descent angle (VSDA). Figure 6-3 illustrates these surfaces.

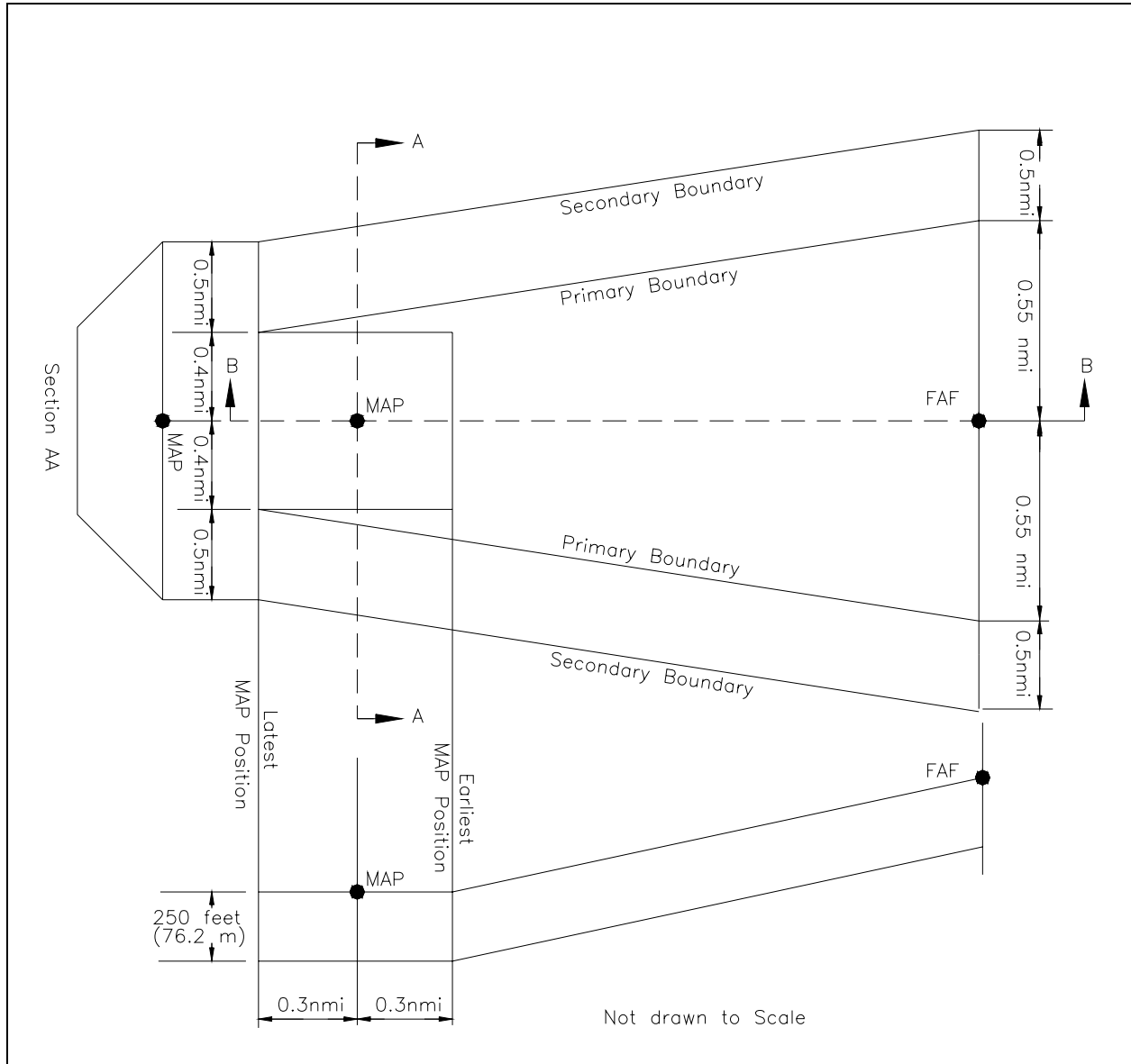
c. VFR Approach/ Departure Surfaces. The VFR approach/ departure surfaces described in paragraphs 204, 304, 404, and 504 also apply at a heliport with a non-precision instrument approach.

d. Missed Approach Surfaces. All instrument procedures require a missed approach procedure. The ability to support low-landing minima, even when the approach trapezoid is void of penetrations, may be controlled by objects in the missed approach segment of the procedure. Missed approach surfaces are complex and beyond the scope of this AC. Missed approach surfaces need to be discussed with an FAA airspace procedures specialist early in the effort to develop an instrument procedure.

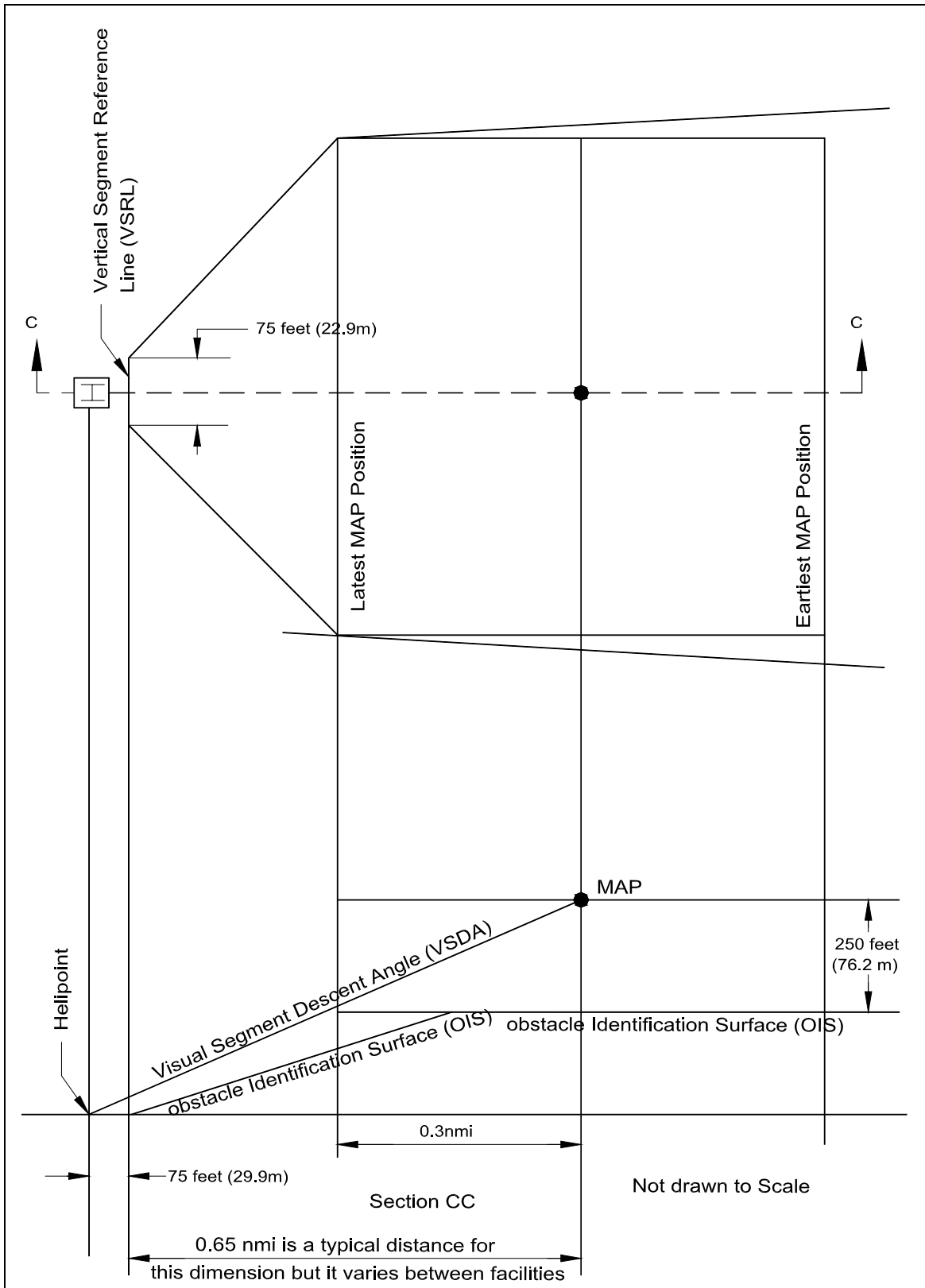
NOTE: *When a heliport does not meet the criteria of this AC, FAA Order 8260.42A requires that a non-precision approach be published as a SPECIAL procedure with annotations that special aircrew qualifications are required to fly the procedure.*



**Figure 6-1. Helicopter Instrument Lighting System (HILS):
NONPRECISION**



**Figure 6-2. Non-precision Approach/ Departure Surfaces – Final Approach Segment:
NONPRECISION**



**Figure 6-3. Non-precision Approach/ Departure Surfaces – Visual Segment:
NONPRECISION**

Intentionally Left Blank

CHAPTER 7. PRECISION APPROACH OPERATIONS

700.GENERAL. Precision instrument approach/ departure/missed approach procedures are necessary to provide the operational capability desired by many executive and corporate users. Such procedures are established in accordance with FAA Order 8260.3, *Volume 5, United States Standard for Terminal Instrument Procedures (TERPS)*, and are essential to ensure the all-weather reliability needed for a helicopter air carrier to be successful in offering scheduled service. This chapter describes the larger ground area (FATO) associated with precision instrument operations and describes the imaginary aerial surfaces that are evaluated for the impact of object penetrations. The FAA Order is available at the AFS 420 web site <http://av-info.faa.gov/terps/>.

a. Early FAA Contact Urged. This chapter addresses issues that heliport owners should consider before requesting the development of precision approach/ departure/missed approach procedures. The recommendation and standards in this AC are not intended to be sufficient to design instrument procedures. Heliport owners desiring instrument procedures are urged to initiate early contact with the appropriate FAA Flight Procedures Office.

b. Precision Airspace. Those who design precision approach/ departure/missed approach procedures have some flexibility in the design of such procedures. For this and other reasons, the clear airspace required to support precision operations is complex, and it does not lend itself to simple description, even using figures. Consequently, the figures in this chapter do NOT describe the full range of possibilities in this regard. Refer to FAA Order 8260.3, for more detailed information.

701.FINAL APPROACH REFERENCE AREA (FARA). A certificated helicopter precision approach procedure terminates with the helicopter coming to a hover or touching down within a 150-foot-wide (45 m) by at least 150-foot long (45 m) FARA. The FARA is located at the far end of a 300-foot-wide by 1,225-foot-long (91 m by 373 m) FATO required for a precision instrument procedure. Figure 7-1 illustrates the FARA/FATO relationship.

702.LIGHTING REQUIREMENTS. The following lighting systems are necessary for a helicopter precision instrument approach procedure with the lowest minimums.

a. The HALS installation, depicted in Figure 7-2, is a distinctive approach lighting configuration designed to prevent it from being mistaken for an airport runway approach lighting system.

b. Enhanced Perimeter Lighting System. The enhanced perimeter lighting system, as described in Chapter 6, strengthens the conspicuity of the front and back lines of perimeter lights.

c. Heliport Instrument Lighting System (HILS). The HILS system, described in Chapter 6, uses PAR-56 lights to extend the lines of perimeter lights fore and aft and right and left.

703.OBSTACLE EVALUATION SURFACES. The operational minimums, determined by the FAA in establishing a helicopter precision approach procedure, depend upon the extent that objects or structures penetrate the surfaces described below and depicted in Figure 7-3. The FAA needs to know the location and elevations of objects that penetrate the described surfaces to advise the heliport owner as to the lowest practical approach angle and prospective operational minimums.

a. Approach Surface. A precision approach surface is a trapezoidally shaped plane beginning at the near perimeter of the instrument FATO. The trapezoid extending outward for 25,000 feet (7,620 m) in the direction of the approach has an initial width of 1,000 feet (305 m) and flares to a width of 6,000 feet (1,829 m) at the far end. An approach surface rising upward on not more than a 34:1 slope (34 units horizontal to 1 unit vertical), as depicted in Figure 7-3, is required for a 3-degree glideslope approach angle. An approach surface rising upward on not more than a 22.7:1 slope (22.7 units horizontal in 1 unit vertical) is required for a 4.5-degree glideslope approach angle. An approach surface rising upward on not more than a 17.7:1 slope (17.7 units horizontal in 1 unit vertical) is required for a 6-degree glideslope approach angle. The glideslope approach angle can vary in increments

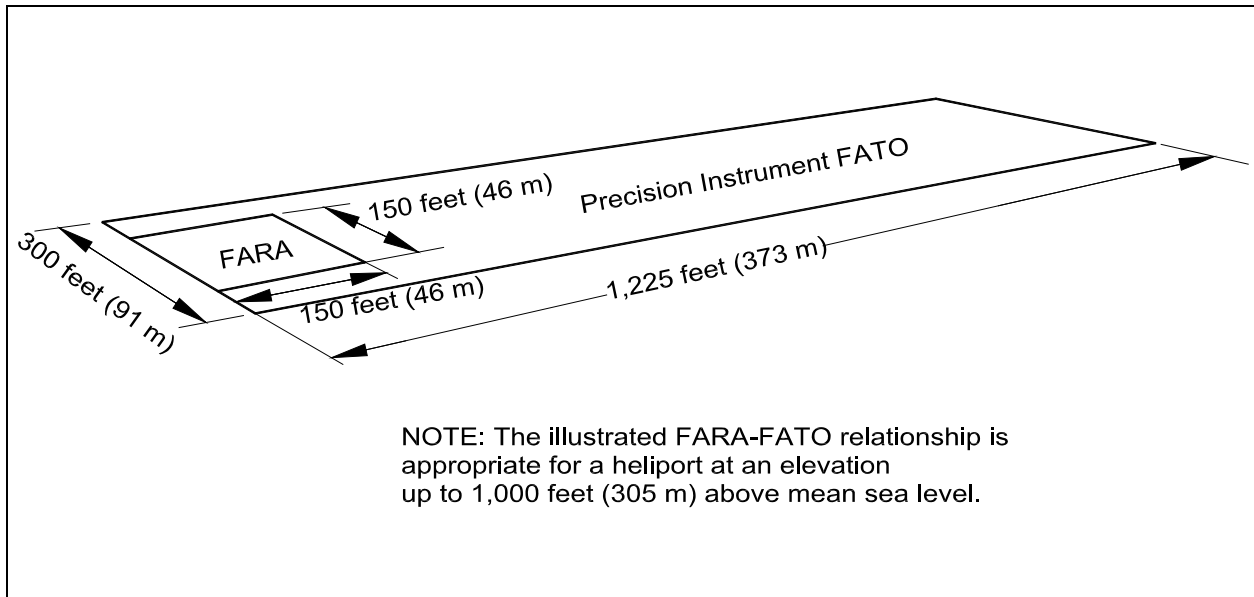
of 0.1 degree from 3 degrees up to 6 degrees with corresponding adjustments to the slope of the approach surface and to the landing minimums.

b. Transitional Surfaces. A precision instrument approach has transitional surfaces associated with the instrument FATO and the certificated approach surface.

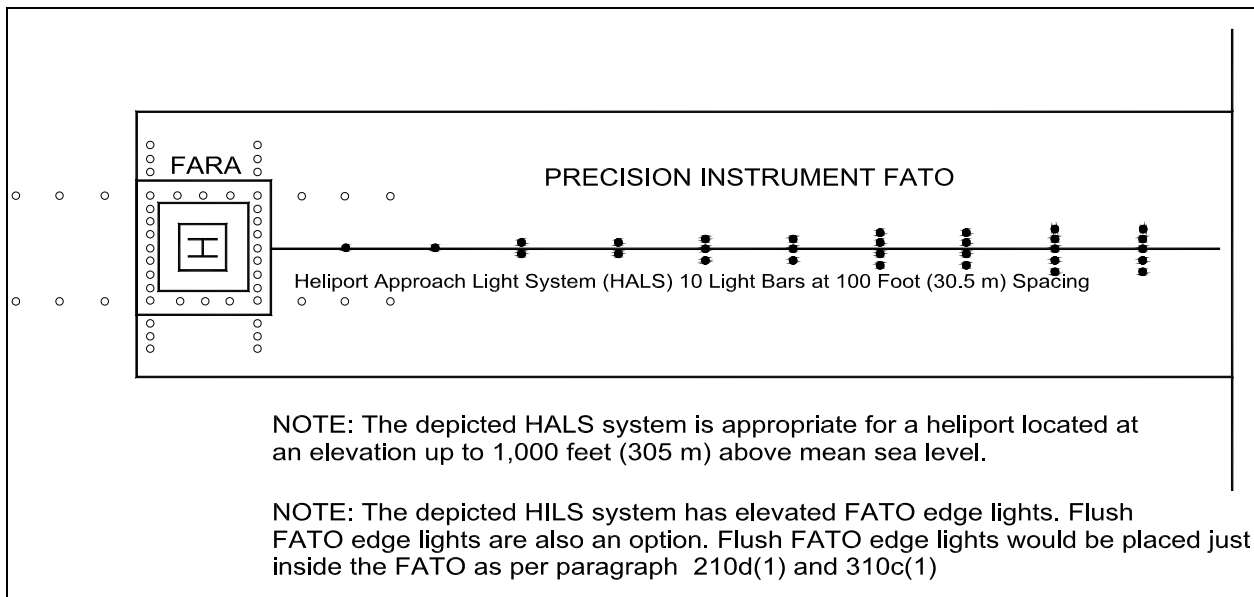
(1) FATO. Inner-transitional surfaces abut each side and, when there is no back approach, the non approach end of an instrument FATO. Transitional surfaces are 350 feet (107 m) wide and rise upward at right angles to the centerline of the instrument FATO on a 7:1 slope (7 units horizontal in 1 unit vertical).

(2) Approach Surface. Transitional surfaces abut each edge of the precision approach trapezoid. The surface is 600 feet (183 m) wide at the FATO end and flares to a width of 1,500 feet (457 m) at the far end of the approach trapezoid. Transitional surfaces rise upward at right angles to the centerline of the approach course on a 7:1 slope (7 units horizontal in 1 unit vertical).

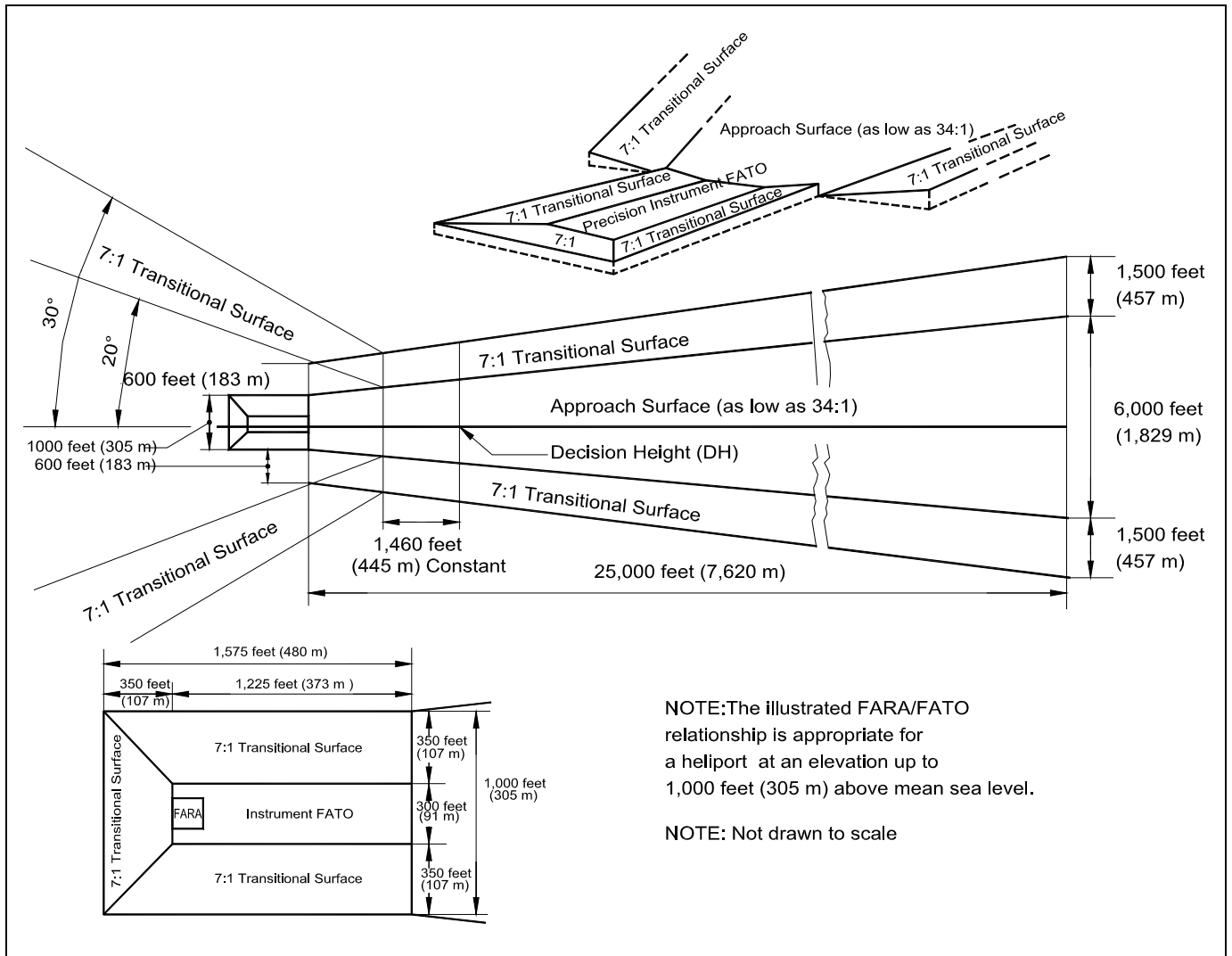
c. Missed Approach Surfaces. All instrument procedures require a missed approach procedure. The ability to support low-landing minima, even when the approach trapezoid is void of penetrations, may be controlled by objects in the missed approach segment of the procedure. While Figure 7-3 illustrates the initial portion of a missed approach surface, missed approach surfaces are complex and beyond the scope of this AC. Missed approach need to be discussed with an FAA flight procedures specialist early in the effort to develop an instrument procedure.



**Figure 7-1. FARA/FATO Relationship:
PRECISION**



**Figure 7-2. HALS Lighting System:
PRECISION**



**Figure 7-3. Precision Approach/ Departure Surfaces:
PRECISION**

CHAPTER 8. HELIPORT GRADIENTS AND PAVEMENT DESIGN

800.GENERAL. This chapter provides guidance on designing heliport pavements, including design loads, and addresses soil stabilization as a method of treating non paved operational surfaces. Operational surfaces such as the TLOF, FATO, Safety Areas, parking areas, taxi routes, and taxiways should present a reasonably smooth, uniformly graded surface. The surfaces of a heliport should be designed to provide positive drainage.

801.TLOF GRADIENTS.

a. General Aviation Heliport. To ensure drainage, the TLOF should have a minimum gradient of 0.5 percent and a maximum gradient of 2.0 percent.

b. Hospital Heliport. To ensure drainage, the TLOF should have a gradient between 0.5 and 1.0 percent and a maximum gradient of 2.0 percent.

c. Transport Heliport. To ensure drainage, the TLOF should have a longitudinal gradient between 0.5 and 1.0 percent and a transverse gradient between 0.5 and 1.5 percent.

802.FATO GRADIENTS. The recommended gradients for a load bearing FATO range from a minimum of 0.5 percent to a maximum of 5.0 percent. FATO grades in any areas where a helicopter is expected to land should not exceed 2.0 percent. To ensure TLOF drainage, gradients of rapid runoff shoulders should range between 3.0 and 5.0 percent. These recommendations are illustrated in Figure 8-1 for a concrete TLOF and stabilized turf FATO.

NOTE: *When the FATO is non-load bearing and/or not intended for use by the helicopter, there are no specific requirements for the gradient of the surface. In this case the gradient should be 5 percent or more to ensure adequate drainage away from the area of the TLOF.*

803.SAFETY AREA GRADIENTS. The surface of the Safety Area should not be steeper than a downward slope of 2:1 (2 units horizontal in 1 unit vertical). In addition, the surface of the Safety Area should not be higher than the FATO edge.

804.PARKING AREA GRADIENTS. Parking area grades should not exceed 2.0 percent in any area where a helicopter is expected to park.

805.TAXIWAY AND TAXI ROUTE GRADIENTS. Taxiway longitudinal gradients should not exceed 2.0 percent. Transverse gradients should not be less than 0.5 percent nor greater than 2.0 percent.

806.DESIGN LOADS. The TLOF and any load-bearing surfaces should be designed and constructed to support the weight of the design helicopter and any ground support vehicles. Loads are applied through the contact area of the tires for wheel-equipped helicopters or the contact area of the skid for skid equipped helicopters. Helicopter weights, landing gear configurations, and dimensional data are listed in Appendix 1.

a. Static Loads. For design purposes, the design static load is equal to the helicopter's maximum takeoff weight applied through the total contact area of the wheels or skids. Contact the manufacturers to obtain the contact area for the specific helicopters of interest.

b. Dynamic Loads. A dynamic load of one-fifth of a second or less duration may occur during a hard landing. For design purposes, dynamic loads should be assumed at 150 percent of the takeoff weight of the design helicopter. When specific loading data is not available, assume 75 percent of the weight of the design helicopter to be applied equally through the contact area of the rear two rear wheels (or the pair rear wheels of a dual-wheel configuration) of a wheel-equipped helicopter. For a skid equipped helicopter assume 75 percent of the weight of the design helicopter to be applied equally through the aft contact areas of the two skids of a skid-equipped helicopter. (See Figure 8-2.) The manufacturer should be contacted to obtain the aft contact area for a specific helicopter of interest.

c. Rotor Loads. Rotor downwash loads are approximately equal to the weight of the helicopter distributed uniformly over the disk area of the rotor. Tests have established that rotor downwash loads are generally less than the loads specified in building codes for snow, rain, or wind loads typically used in structural design calculations.

807.PAVEMENT DESIGN AND SOIL STABILIZATION. Pavements distribute the helicopters' weight over a larger area of the subsurface as well as provide a water-impervious, skid-resistant wearing surface. Paving TLOFs, FATOs, taxiways, and parking aprons is encouraged to improve their load carrying ability, minimize the erosive effects of rotor wash, and facilitate surface runoff. Stabilizing unpaved portions of the FATO and taxi routes subjected to rotor wash is recommended. In some instances, loads imposed by ground support vehicles may exceed those of the largest helicopter expected to use the facility. Guidance on pavement design and on stabilizing soils is contained in AC 150/5320-6, *Airport Pavement Design and Evaluation*, and AC 150/5370-10, *Standards for Specifying Construction of Airports*. The ACs are available at the Airports web site <http://faa.gov/arp>.

a. Pavements. In most instances, a 6-inch thick (15 cm) Portland Cement Concrete (PCC) pavement is capable of supporting operations by helicopters weighing up to 20,000 pounds (9,070 kg). Thicker pavements are required for heavier helicopters or where the quality of the subsurface soil is questionable. PCC pavement is recommended for all heliport surfaces used by helicopters.

b. Stabilizing Soils. Different methods of soil stabilization may be used to meet different site requirements. Helicopter weight, ground support vehicle weight, operational frequency, soil analysis, and climatic conditions should be considered in selecting the method(s) and extent of surface stabilization.

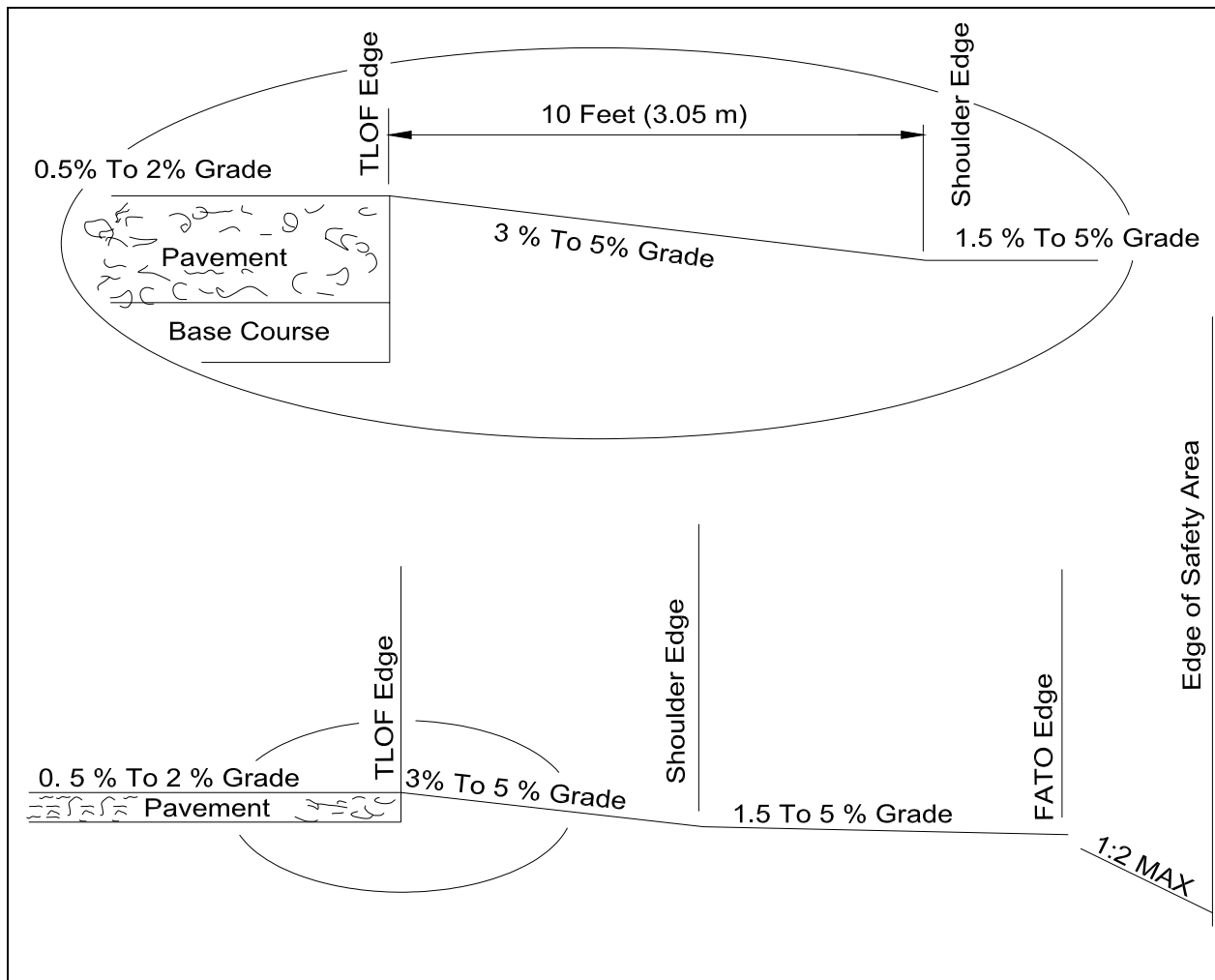
(1) Turf. A well-drained and well-established turf that presents a smooth, dense surface is generally considered to be the most cost-effective surface stabilization available. In some combinations of climates and weather conditions, turf surfaces are capable of supporting the weight of many of the smaller helicopters for low frequency use by private and corporate operators during much of the year. Turf surfaces also provide reasonable protection against wind, rotor wash, or water erosion. Climatic and soil conditions dictate the appropriate grass species to use at the site.

(2) Aggregate Turf. Heliports located on soils that have poor load-carrying capabilities when wet may be able to overcome this deficiency by mixing selected granular materials into the upper 12 inches (30 cm) of the soil. Suitable granular materials for this purpose are crushed stone, pit-run

gravel, coarse sand, or oyster shells. The ratio of aggregate to soil should be sufficient to improve the stability of the soil yet retain the soil's ability to support grass. For additional guidance, see Item 217 of AC 150/5370-10, *Standards for Specifying Construction of Airports*.

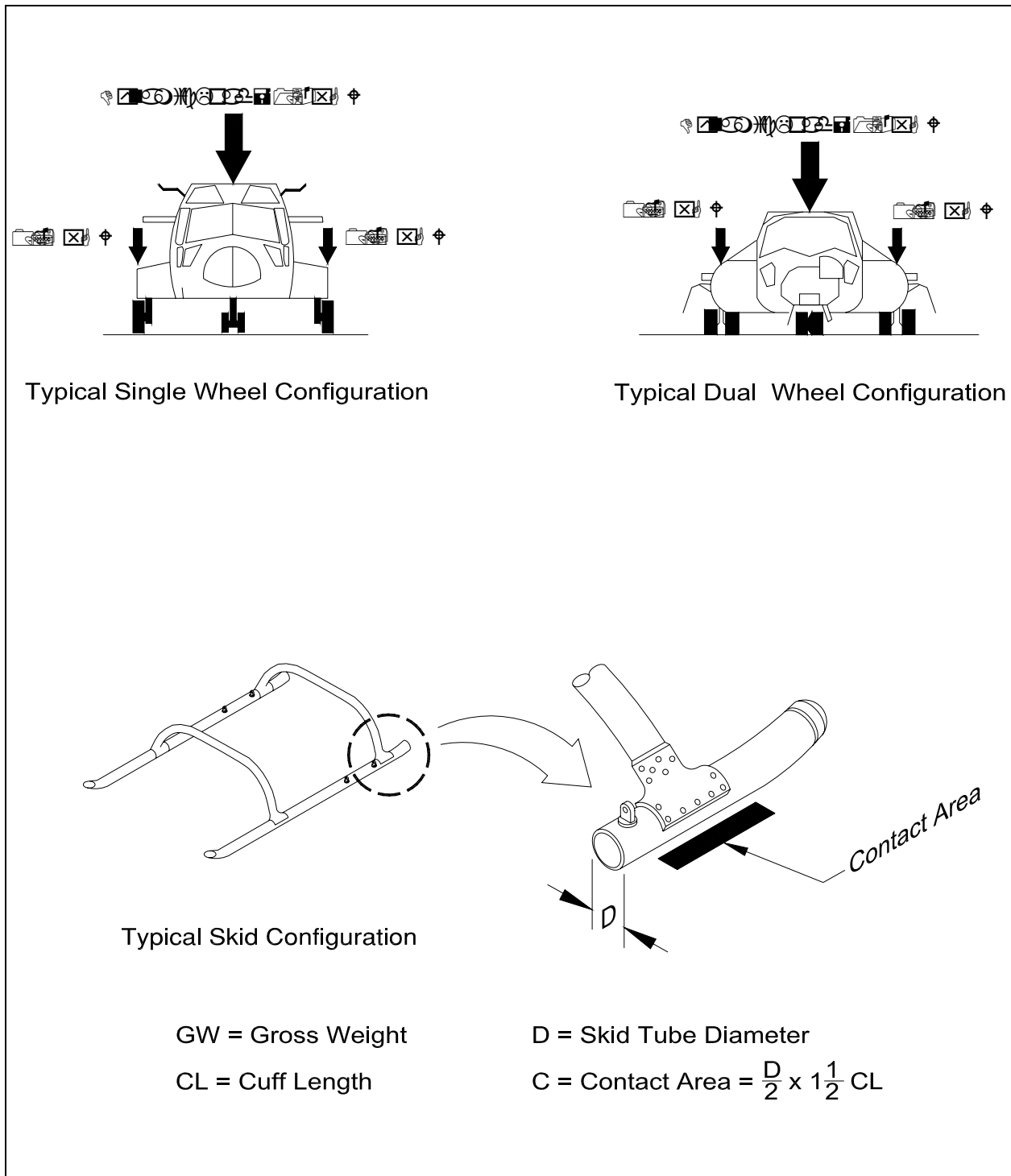
c. Formed Masonry Shapes. Precast masonry shapes vary in size and shape—from a brick paver to an open block. Pavers can be laid on a prepared bed to present a solid surface. Precast blocks can be embedded in the soil with grass growing in the natural openings. Architectural catalogs identify different masonry shapes that are commercially available for this purpose.

d. Pierced Metal Panels. Perforated metal panels that allow grass to grow through the openings can be laid on the ground to provide a hard surface for helicopter operations. Engineering catalogs identify commercially available panels.



NOTE: FATO non-loading bearing surfaces should be stabilized.

**Figure 8-1. Heliport Grades and Rapid Runoff Shoulder:
GRADIENTS AND PAVEMENT**



**Figure 8-2. Helicopter Landing Gear Loading:
 GRADIENTS AND PAVEMENT**

APPENDIX 1. HELICOPTER DATA

1. INTRODUCTION. This appendix contains selected helicopter data needed by a heliport designer. These data represent the most critical weight, dimensional, or other data entry for that helicopter model, recognizing that specific versions of the model may weigh less, be smaller in some feature, carry fewer passengers, etc.

2. VERIFICATION. The published information has been verified by the various helicopter manufacturers and is current as of the date of publication. If more specific data is needed, contact the manufacturer(s) of the specific helicopter(s) of interest.

- A Manufacturer name and helicopter model
- B Maximum takeoff weight in pounds.
- C Overall length in feet. (Rotors at their maximum extension.)
- D Overall height in feet. (Usually at tail rotor.)
- E Rotor diameter in feet.
- F Rotor plane clearance in feet.
- G Distance from rotor hub to tip of tail rotor in feet.
- H Tail rotor diameter (in feet)
- I Tail rotor ground clearance in feet.
- J Type of undercarriage.
- K Undercarriage length in feet.
- L Undercarriage width in feet. (The distance between the outside edges of the tires or the skids.)
- M Number and type of engines
- N Number of crew and passengers.
- O Standard fuel capacity in gallons

Table A1- 1. Legend for Figure A1-1 and Table A1-2

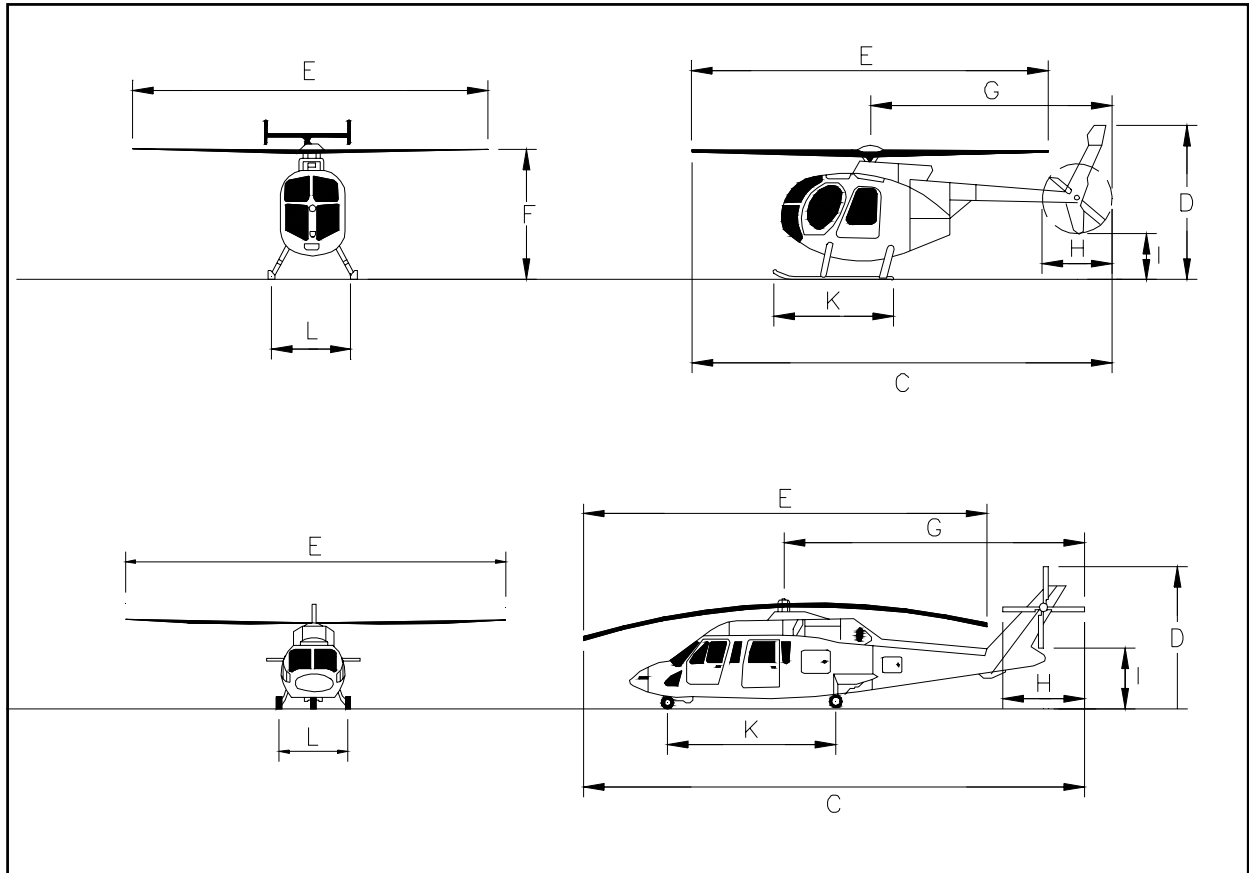


Figure A1-1. Helicopter Dimensions

Table A1-2 Helicopter Dimensions

A	B	C	D	E	F	G	H	I	J	K	L	M	N
	Max.			Main Rotor			Tail Rotor					Number	
	Takeoff	Overall		Dia.	Ground	Hub To	Dia.	Ground	Undercarriage			Engines	Crew
Manufacturer	Weight	Length	Height	# Blades	Clear.	Aft End	# Blades	Clear.	Type	Length	Width	Type	Passengers
Model	(lbs)	(feet)	(feet)	(feet/No)	(feet)	(feet)	(feet/No)	(feet)		(feet)	(feet)		(No&No)
Agusta													
A-109	5,997	43	11	37/4	10	25	6.7/2	2.3	wheel	11.6	7.5	2-T	1&7
A-109E Power	6,284	37.6	11.5	36.1/4	8.04	26.5	6.7/2	3	wheel	16.11	5.28	2-T	1&7
A119 Koala	5,997	42.7	11.5	36.1/4	8.33	25.5	6.6/2	4.23	skid	13.4	5.48	1-T	1&7
Bell/Agusta													
AB-139	13,228	54.8	12.5	45.3/5	7	32.2	8.9/4	7.5	wheel	14.2	10	2-T	1&13
BA-609 Tiltrotor	16,800	60	15	26/3 X 2	14	27	n/a	n/a	wheel	19	10	2-T	1 or 2&9
Bell Helicopter													
47	2,950	44	10	36/2	5	25	5.1/2	3.5	skid	9.9	7.5	1-P	1&3
205A, A-1	9,500	57.1	12.3	48/2	7.3	33.1	8.5/2	5.9	skid	12.1	8.8	1-T	1&14
205B & UH-1H II	10,500	57.1	11.8	48/2	7.3	33.1	8.5/2	5.9	skid	12.1	8.8	1-T	1&14
206B-3	3,200	39.1	10.4	33.3/2	6	22.5	5.4/2	2.1	skid	8.3	6.8	1-T	1&4
206L-1,3	4,150	42.5	10.3	37/2	6.2	24	5.4/2	3.5	skid	9.9	7.7	1-T	1&6
206L-4	4,450	42.5	10.3	37/2	6.2	24	5.4/2	3.5	skid	9.9	7.7	1-T	1&6
212	11,200	57.2	12.6	48/2	7.5	33.2	8.5/2	6.1	skid	12.1	8.8	2-T	1&14
214ST	17,500	63	16	52/2	6.5	37	9.7/2	3.5	skid	12.1	8.6	2-T	2&18
222B, UT	8,250	50.2	11.7	42/2	9.2	29.2	6.9/2	2.7	wheel/skid	12.2	7.8	2-T	1&9
230	8,400	50.2	12	42/2	9.2	29.2	6.9/2	2.7	wheel/skid	12.2	7.8	2-T	1&9
412EP	11,900	57	15	46/4	11	34	8.5/2	6.4	skid	7.9	8.3	2-T	1&14
407	5,250	41.8	10.9	35/4	8	24.3	5.4/2	3.3	skid	9.9	7.5	1-T	1&6
427VFR	6,350	42.6	10.6	37/4	6.3	24.1	5.7/2	3.8	skid	9.9	7.5	2-T	1&7
430	9,300	50.2	13.2	42/4	6.8	29.2	6.9/2	3.9	wheel/skid	12.5	8.3	2-T	1&9
Boeing													
107	20,000	84	17	50/3	15	59	50/3	16.9	wheel	24.9	12.9	2-T	3&25
234	48,500	99	19	60/3	15	69	60/3	18.7	wheel	25.8	10.5	2-T	3&44
360	36,160	84	20	50/4	14	59	50/4	19.6	wheel	32.7	13	2-T	3&30

A	B	C	D	E	F	G	H	I	J	K	L	M	N
	Max.			Main Rotor			Tail Rotor					Number	
	Takeoff	Overall		Dia.	Ground	Hub To	Dia.	Ground	Undercarriage			Engines	Crew
Manufacturer	Weight	Length	Height	# Blades	Clear.	Aft End	# Blades	Clear.	Type	Length	Width	Type	Passengers
Model	(lbs)	(feet)	(feet)	(feet/No)	(feet)	(feet)	(feet/No)	(feet)		(feet)	(feet)		(No&No)
Brantly													
B-2B	1,670	28	7	24/3	4.8	16	4.3/2	3	skid	7.5	6.8	1-P	1&1
305	2,900	33	8	29/3	8	19	4.3/2	3	skd/whl	6.2	6.8	1-P	1&4
E.H. Industries													
EH-101	31,500	75	22	61/5	21.3	45	13.1/4	8.2	wheel	22.9	14.9	3-T	3&30
Enstrom													
280/F28F	2,600	29.3	9	32/3	5.8	20.6	4.7/2	3.1	skid	8	7.3	1-P	1&2
480B/TH-28	3,000	30.1	9.7	32/3	6.5	21.2	5.0/2	3.6	skid	9.2	8.1	1-T	1&5
Eurocopter													
315 Lama	4,300	42.46	11	36.15/3	10.13	20	6.27/3	3.18	skid	10.8	7.8	1-T	1&4
316 Alouette III	4,630	33.37	9.74	36.08/3	9.8	27.72	6.27/3	2.8	wheel	11.5	8.5	1-T	1&4
330 Puma	16,315	60	17	50/4	14.4	35	10.0/5	6	wheel	13.3	9.8	2-T	2&20
332 Super Puma	18,960	61.34	16.24	51.17/4	14.56	36	10.0/5	7.1	wheel	17.3	9.8	2-T	2&24
341 Gazelle	3,970	39.27	10.4	34.5/3	8.9	23	Fenestron	2.44	skid	6.4	6.6	1-T	1&4
350 A Star/Ecureuil	4,960	42.45	10.96	35.07/3	10.63	25	6.1/2	2.3	skid	4.7	7.48	1-T	1&6
355 Twin Star	5,732	42.45	9.91	35.86/3	10.3	25	6.1/2	2.3	skid	9.56	7.12	2-T	176
360 Dauphin	6,600	43.3	11.48	37.72/4	10.73	25	Fenestron	2.6	wheel	23.71	6.4	1-T	1&13
365 Dauphin 2	9,480	45.05	13.32	39.17/4	11.38	24	Fenestron	2.6	wheel	11.94	6.23	2-T	1&11
BO-105	5,732	38.9	11.5	32.28/4	9.84	23	6.2/2	6.1	skid	8.3	8.2	2-T	1&5
BK-117	7,385	42.65	12.63	36.09/4	11.02	25	6.42/2	6.3	skid	11.6	8.2	2-T	1&10
EC-120	3,780	37.79	11.15	32.8/3	10.1	24.6	Fenestron	2.06	skid	9.4	6.79	1-T	1&4
EC-130	5,291	41.47	11.84	35.07/3	10.96	23.7	Fenestron	5.3	skid	10.5	7.87	1-T	1&7
EC-135	6,250	40	11.5	33.5/4	11	22.8	Fenestron	5.628	skid	10.5	6.6	2-T	1&6
EC 145	7,904	42.74	12.98	36.08/4	11.32	28	6.44/2	10.69	skid	9.51	7.87	2-T	1&8
EC-155	10,692	46.91	14.27	41.34/5	11.96	23	Fenestron	3.1	wheel	12.83	6.23	2-T	2&12
EC 225	11,060	63.98	16.3	53.14/5	15.09	38	10.33/4	3.5	wheel	17.22	9.84	2-T	2&24
Kaman													
K-Max K1200	6,000	52	21	48.2/4	10.7	28	na	na	wheel	15.3	11.3	1-T	1&0

A	B	C	D	E	F	G	H	I	J	K	L	M	N
	Max.			Main Rotor			Tail Rotor					Number	
	Takeoff	Overall		Dia.	Ground	Hub To	Dia.	Ground	Undercarriage		Engines	Crew	
Manufacturer	Weight	Length	Height	# Blades	Clear.	Aft End	# Blades	Clear.	Type	Length	Width	Type	Passengers
Model	(lbs)	(feet)	(feet)	(feet/No)	(feet)	(feet)	(feet/No)	(feet)		(feet)	(feet)		(No&No)
MD Helicopters													
500/520/550/530	3,100	32	9	28/5	8.5	19	4.6/2		skid	8.1	6.8	1-T	1&4
520N/530N	3,350	32	9	29/5	8.7	17	NOTAR		skid	4.5	6.5	1-T	1&4
MDX Explorer	6,500	39	12	34/5		23	NOTAR	3.3	skid	7.3	7.3	2-T	1&7
600N	4,100	37	10	27.5/2			NOTAR		skid			1-T	1&7
Piasecki													
PZ1, Sokol	14,080	61.7	13.8	51.5/4			10.0/3		wheel			2-T	2&12
Robinson													
R-22	1,370	29	9	26/2	8.8	16	3.5/2	4.1	skid	4.2	6.3	1-P	1&1
R-44 Astro	2,400	38	11	33/2	10.5	22	4.8/2	3.8	skid	4.2e	7.2	1-P	1&3
Rogerson-Hiller													
RH-1100	3,500	42	10	36/2	9.5	24	6.0/2	3	skid	7.9	7.2	1-T	1&6
UH-12	3,100	41	11	36/2	10.1	23	6.0/2	4	skid	8.3	7.5	1-P	1&2
Schweizer													
300C	2,050	30.8	8.7	26.8/3	8.7	15.3	4.3/2	2.8	skid	8.3	6.5	1-P	1&2
300CB	1,750	30.8	8.7	26.8/3	8.7	15.3	4.3/2	2.8	skid	8.3	6.5	1-P	1&1
333	2,550	31.3	8.8	27.5/3	9.2	15.3	4.3/2	3.2	skid	8.3	6.5	1-T	1&3
Sikorsky													
S-58	13,000	65.8	16	56/4	11.4	38	9.5/4	6.4	wheel	28.3	14	2-T	2&16
S-61N	20,500	72.8	19	62/5	12.3	40	10.3/5	8.6	wheel	23.5	14	2-T	3&28
S-64F Skycrane	47,000	88.5	25.3	72.3	15.7	53	16.0/4	9.4	wheel	24.4	19.8	2-T	3&0
CH-53E	69,750	99.5	28.3	79/7	17	59.6	20.0/4	9.5	wheel	27.3	13	3-T	3&55
UH-60L Blackhawk	22,000	64.8	16.8	53.8/4	9.4	38	11.0/4	6.5	wheel	29	8.9	2-T	3&11
S-76B/C+	11,700	52.5	14.5	44/4	8.1	30.5	8.0/4	6.5	wheel	16.4	8	2-T	2&12
S-92	26,150	68.5	17.9	64.8	9.8	39.9	11.0/4	7.4	wheel	20.33	10.4	2-T	2 & 19

Intentionally Left Blank

APPENDIX 2. AVIATION ORGANIZATIONS

STATE AVIATION OFFICES

ALABAMA

Alabama Department of Transportation
Aeronautics Bureau
1409 Coliseum Blvd.
Montgomery, AL 36130
Telephone: 334-242-6820
FAX: 205-240-3274

ALASKA

Department of Transportation &
Public Facilities
P.O. Box 196900
Anchorage, AK 99519-6900
Telephone: 907-269-0731
FAX: 907-243-1512
<http://www.dot.state.ak.us/stwdav/stwdav.html#>

ARIZONA

Division of Aeronautics
Arizona Department of Transportation
255 E. Osborn Road, Suite 101
Phoenix, AZ 85012
or
Mail Drop 426M
Phoenix, AZ 85002-3588
Telephone: 602-294-9144
FAX: 602-294-9141
<http://www.dot.state.az.us/Aero/index.htm>

ARKANSAS

Department of Aeronautics
Regional Airport Terminal Building
No. 1 Airport Drive, 3rd Floor
Little Rock, AR 72202
Telephone: 501-376-6781
FAX: 501-378-0820
<http://www.ahtd.state.ar.us/>

CALIFORNIA

Division of Aeronautics Program
Department of Transportation
1120 N. Street-Room 3300
P.O. Box 942874
Sacramento, CA 94274-0001
Telephone: 916-654-4959
FAX: 916-653-9531
<http://www.dot.ca.gov/hq/planning/aeronaut/htmlfile/index.php>

CALIFORNIA (continued)

Postal Address:
Department of Transportation
Division of Aeronautics, MS # 40
P. O. Box 942874
Sacramento, CA 94274-0001

COLORADO

Division of Aeronautics
Colorado Department of Transportation
6848 South Revere Parkway, Suite 3-101
Englewood, CO 80112-6703
Telephone: 303-397-3045
FAX: 303-397-3042
<http://www.colorado-aeronautics.org/>

5126 Front Range Parkway
Watkins, CO 80137
303-261-4418

CONNECTICUT

Bureau of Aviation and Ports
Connecticut Department of Transportation
2800 Berlin Turnpike
P.O. Box 317546
Newington, CT 06131-7546
Telephone: 860-594-2529
FAX: 860-594-2574
<http://www.ct.gov/dot/cwp/view.asp?a=1402&q=259246&dotPNavCtr=#40584>

DELAWARE

Aeronautics Administration
Delaware Transportation Authority
Department of Transportation
P.O. Box 778
Dover, DE 19903
Telephone: 302-739-3264
FAX: 302-739-5711

FLORIDA

Aviation Office
Florida Department of Transportation
605 Suwannee Street
Mail Stop 46
Tallahassee, FL 32399-0450
Telephone: 904-488-8444
FAX: 904-487-3403

GEORGIA

Georgia Department of Transportation
Office of Intermodal Programs
276 Memorial Drive, SW
Atlanta, GA 30303-3743
Telephone: 404-651-9201
FAX: 404-651-5209

HAWAII

Airports Division
Hawaii Department of Transportation
Honolulu International Airport
Honolulu, HI 96819-1898
Telephone: 808-836-6542
FAX: 808-836-6441

IDAHO

Bureau of Aeronautics
Idaho Department of Transportation
3483 Rickenbacker Street
P.O. Box 7129
Boise, ID 83705
Telephone: 208-334-8786
FAX: 208-334-8789

ILLINOIS

Division of Aeronautics
Department of Transportation
Capital Airport - One Langhorne Bond Dr.
Springfield, IL 62707-8415
Telephone: 217-785-8544
FAX: 217-785-4533

INDIANA

Division of Aeronautics
Indiana Department of Transportation
143 West Market Street, Suite 300
Indianapolis, IN 46204
Telephone: 317-232-1496
FAX: 317-232-1499

IOWA

Office of Aeronautics
Air and Transit Division
Iowa Department of Transportation
International Airport
Des Moines, IA 50321
Telephone: 515-287-3315
FAX: 515-287-7731

KANSAS

Division of Aviation
Kansas Department of Transportation
Docking State Office Building
915 SW Harrison
Topeka, KS 66612-1568
Telephone: 913-296-2553
FAX: 913-296-7927

KENTUCKY

Office of Aeronautics
Kentucky Transportation Cabinet
421 Ann Street
Frankfort, KY 40622
Telephone: 502-564-4480
FAX: 502-564-7953

LOUISIANA

Aviation Division
Department of Transportation & Development
P.O. Box 94245
Baton Rouge, LA 70804-9245
Telephone: 504-379-1242
FAX: 504-379-1394

MAINE

Office of Passengers Transportation
Maine Department of Transportation
Augusta State Airport Station #16
Augusta, ME 04333
Telephone: 207-287-3318
FAX: 207-287-1030

MARYLAND

Maryland Aviation Administration
Maryland Department of Transportation
P.O. Box 8766
Baltimore/Washington Intl. Airport
MD 21240
Telephone: 410-859-7100
FAX: 410-850-4729

MASSACHUSETTS

Massachusetts Aeronautics Commission
10 Park Plaza, Room 6620
Boston, MA 02116-3966
Telephone: 617-973-8881
FAX: 617-973-8889

MICHIGAN

Bureau of Aeronautics
Department of Transportation
2nd Floor, Terminal Building
Capital City Airport
Lansing, MI 48906
Telephone: 517-373-1834
FAX: 517-886-0366

MINNESOTA

Aeronautics Office
Minnesota Department of Transportation
Transportation Building, Room 417
395 John Ireland Boulevard
St. Paul, MN 55155
Telephone: 612-296-8202
FAX: 612-297-5643

MISSISSIPPI

Mississippi Aeronautics Bureau
Department of Economic & Community
Development
100 Airport Drive
Jackson, MS 39208
Telephone: 601-354-6970
FAX: 601-354-6969

MISSOURI

Department of Highways & Transportation
Aviation Section
P.O. Box 270
Jefferson City, MO 65102
Telephone: 314-751-2589
FAX: 314-751-6555

MONTANA

Aeronautics Division
Department of Transportation
P.O. Box 5178
Helena, MT 59604
Telephone: 406-444-2506
FAX: 406-444-2519

NEBRASKA

Nebraska Department of Aeronautics
P.O. Box 82088
Lincoln, NE 68501
Telephone: 402-471-2371
FAX: 402-471-2906

NEVADA

Nevada Department of Transportation
1263 South Stewart Street
Carson City, NV 89712
Telephone: 775-888-7353
FAX: 775-888-7207

NEW HAMPSHIRE

Division of Aeronautics
Municipal Airport
65 Airport Road
Concord, NH 03301-5298
Telephone: 603-271-2551
FAX: 603-271-1689

NEW JERSEY

Office of Aviation
New Jersey Department of Transportation
1035 Parkway Avenue CN 610
Trenton, NJ 08625
Telephone 609-530-2900
FAX 609-530-5719

NEW MEXICO

Aviation Division
State Highway and Transportation Department
P.O. Box 1149
Santa Fe, NM 87504-1149
Telephone 505-827-0332
FAX 505-827-0431

NEW YORK

Aviation Division
New York State Department of Transportation
1220 Washington Avenue
Albany, NY 12232
Telephone 518-457-2821
FAX 518-457-9779

NORTH CAROLINA

Division of Aviation
North Carolina Department of Transportation
P.O. Box 25201
Raleigh, NC 27611
Telephone 919-840-0112
FAX 919-840-0645

NORTH DAKOTA

North Dakota Aeronautics Commission
2301 University Drive
Box 5020
Bismarck, ND 58502
Telephone 701-224-2748
FAX 701-224-2780

OHIO

Ohio Department of Transportation
Division of Aviation
2829 West Dublin-Granville Road
Columbus, OH 43235
Telephone 614-793-5040
FAX 614 761-9609

OKLAHOMA

Oklahoma Aeronautics and Space Commission
Department of Transportation Building
200 NE 21st Street, B-7 1st Floor
Oklahoma City OK 73105
Telephone 405-521-2377
FAX 405-521-2524

OREGON

Division of Aeronautics
Oregon Department of Transportation
3040 25th Street, SE
Salem, OR 97310
Telephone: 503-378-4880
FAX: 503-373-1688

PENNSYLVANIA

Bureau of Aviation
Pennsylvania Department of Transportation
208 Airport Drive
Harrisburg International Airport
Middletown, PA 17057
Telephone: 717-948-3915
FAX: 717-948-3527

PUERTO RICO

Puerto Rico Ports Authority
P.O. Box 362829
San Juan, PR 00936-2829
Telephone: 809-723-2260
FAX: 809-722-7867

RHODE ISLAND

Rhode Island Airport Corporation
Department of Airports
Theodore Francis Green State Airport
2000 Post Road
Warwick, RI 02886
Telephone: 401-737-4000
FAX: 401-732-4953

SOUTH CAROLINA

South Carolina Aeronautics Commission
P.O. Box 280068
Columbia, SC 29228-0068
Telephone: 803-822-5400
FAX: 803-822-8002

SOUTH DAKOTA

Office of Aeronautics
700 Broadway Avenue East
Pierre, SD 57501-2586
Telephone: 605-773-3574
FAX: 605-773-3921

TENNESSEE

Office of Aeronautics
Tennessee Department of Transportation
P.O. Box 17326
Nashville, TN 37217
Telephone: 615-741-3208
FAX: 615-741-4959

TEXAS

Texas Department of Transportation
Division of Aeronautics
P.O. Box 12607
Austin, TX 78711-2607
Telephone: 512-476-9262
FAX: 512-479-0294

UTAH

Aeronautical Operations Division
Utah Department of Transportation
135 North 2400 West
Salt Lake City, UT 84116
Telephone: 801-533-5057
FAX: 801-533-6048

VERMONT

Agency of Transportation
133 State Street
Montpelier, VT 05602
Telephone: 802-828-2657
FAX: 802-828-2024

VIRGINIA

Department of Aviation
4508 S. Laburnum Avenue
Richmond, VA 23231-2422
Telephone: 804-786-1364
FAX: 804-786-3690

WASHINGTON

Division of Aeronautics
Washington Department of Transportation
8600 Perimeter Road-Boeing Field
Seattle, WA 98108-3885
Telephone: 206-764-4131
FAX: 206-764-4001

WEST VIRGINIA

Department of Transportation
Building 5, Room A-109
West Virginia State Capital
Charleston, WV 25305
Telephone: 304-348-0444
FAX: 304-348-4076

WISCONSIN

Bureau of Aeronautics
Division of Transportation Assistance
Wisconsin Department of Transportation
P.O. Box 7914
Madison, WI 53707-7914
Telephone: 608-266-3351
FAX: 608-267-6748

WYOMING

Wyoming Department of Transportation
5300 Bishop Boulevard
P.O. box 1708
Cheyenne, WY 82002-9019
Telephone: 307-777-4480
FAX: 307-637-7352

Aviation Organizations/Associations**AIRPORT CONSULTANTS COUNCIL**

908 King Street, Suite 100
Alexandria, VA 22314
Telephone: 703-683-5900
FAX: 703-683-2564
<http://www.acconline.org/>

**AMERICAN HELICOPTER SOCIETY
INTERNATIONAL**

217 N. Washington St.
Alexandria, VA 22314-2538
Telephone: 703-684-6777
FAX: 703-739-9279
<http://www.vtol.org/>
Email: Staff@vtol.org

ASSOCIATION OF AIR MEDICAL SERVICES

526 King St., Suite 415
Alexandria, VA 22314-3134
Telephone: 703-836-8732
FAX: 703-836-8920
<http://www.aams.org/>

HELICOPTER ASSOCIATION INTERNATIONAL

1635 Prince Street
Alexandria, VA 22314
Telephone: (703)683-4646
Fax: (703)683-4745
<http://www.rotor.com/>

**HELICOPTER SAFETY ADVISORY
CONFERENCE**

c/o Casey Lowery
225 Aviation Road
Houma, LA 70363
Telephone: 985-223-6152
FAX: 985-872-5258
<http://www.hsac.org/>

**NATIONAL ASSOCIATION OF STATE
AVIATION
OFFICIALS**

101 Wayne Ave. Suite 930
Silver Spring, MD 20910
Telephone: 301-588-0587
FAX: 301-585-1803
<http://www.nasao.org/>

**NATIONAL BUSINESS AIRCRAFT
ASSOCIATION**

1200 18th Street, Northwest, Suite 400
Washington, DC 20036-2527
Telephone: 202-783-9000
FAX: 202-331-8364
<http://www.nbaa.org/>

NATIONAL EMS PILOTS ASSOCIATION

526 King St., Suite 415
Alexandria, VA 22314-3134
Telephone: 703-836-8930
FAX: 703-836-8920
<http://www.nemspa.org/>

**FEDERAL AVIATION ADMINISTRATION
AIRPORTS DIVISION OFFICES**

ALASKAN REGION

Alaskan Regional Office
(AK) Airports Division, AAL-600
222 West 7th Avenue, Box 14
Anchorage, AK 99513
Telephone: 907-271-5438
FAX: 907-271-2851

NEW ENGLAND REGION

(CT, MA, ME, NH, RI, VT)
New England Regional Office
Airports Division, ANE-600
12 New England Executive Park
Burlington, MA 01803-5299
Telephone: 781-238-7600
FAX: 781-238-7608

EASTERN REGION

(DC, DE, MD, NJ, NY, PA, VA, WV)
Eastern Regional Office
Airports Division, AEA-600
1 Aviation Plaza
Jamaica, NY 11434-4809
Telephone: 718-553-3341
FAX: 718-995-5615

SOUTHERN REGION

(AL, FL, GA, KY, NC, SC, TN, PR, VI)
Southern Regional Office
Airports Division, ASO-600
P.O. Box 20636
Atlanta, GA 30320-0631
Telephone: 404-305-6700
FAX: 404-305-6730

GREAT LAKES REGION

(IL, IN, MI, MN, ND, OH, SD, WI)
Great Lakes Regional Office
Airports Division, AGL-600
2300 East Devon Avenue
Des Plaines, IL 60018
Telephone: 847-294-7272
FAX: 847-294-7036

CENTRAL REGION

(IA, KS, MO, NE)
Central Regional Office
Airports Division, ACE-600
901 Locust
Kansas City, MO 64106-2325
Telephone: 816-329-2647
FAX: 816-329-2610

SOUTHWEST REGION

(AR, LA, NM, OK, TX)
Southwest Regional Office
Airports Division, ASW-600
2061 Meacham Boulevard
Fort Worth, Texas 76173-4298
Telephone: 817-222-5600
FAX: 817-222-5984

NORTHWEST MOUNTAIN REGION

(CO, ID, MT, OR, UT, WA, WY)
Northwest Regional Office
Airports Division, ANM-600
1601 Lind Avenue SW, Suite 315
Renton, Washington 98055-4056
Telephone: 425-227-2600
FAX: 425-227-1600

WESTERN-PACIFIC REGION

(AZ, CA, HI, NV, GU)
Western-Pacific Regional Office
Airports Division, AWP-600
P.O. Box 92007
Los Angeles, CA 90009
Telephone: 310-725-3600
FAX: 310-725-6847

Intentionally Left Blank

APPENDIX 3. DIMENSIONS FOR MARKING SIZE AND WEIGHT LIMITATIONS

Introduction. The form and proportion of numbers for marking TLOF and parking area size and weight limitations are shown below.

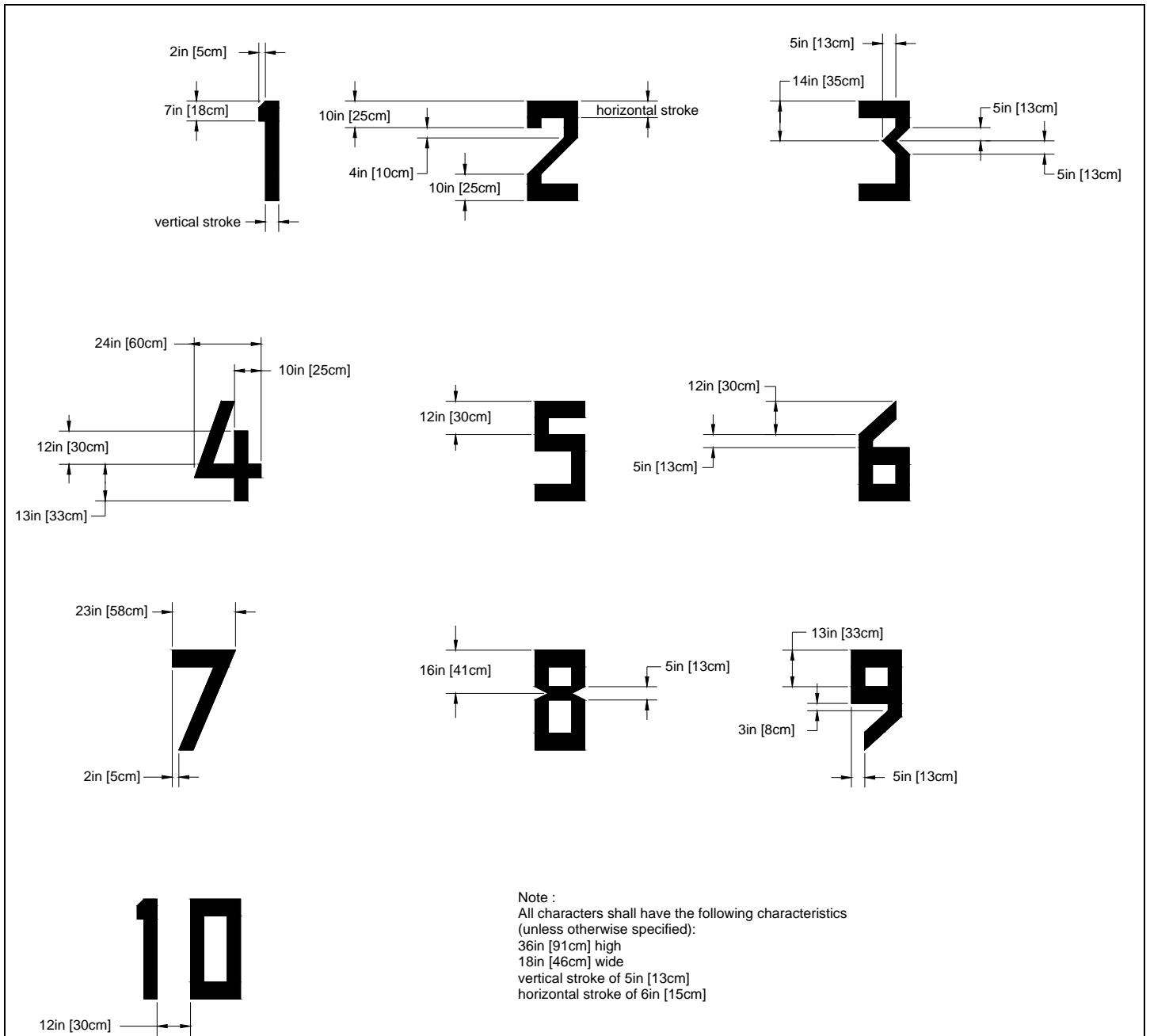


Figure A3- 1. Form and Proportions of 3 foot (0.9 m) Numbers for Marking Size and Weight Limitations

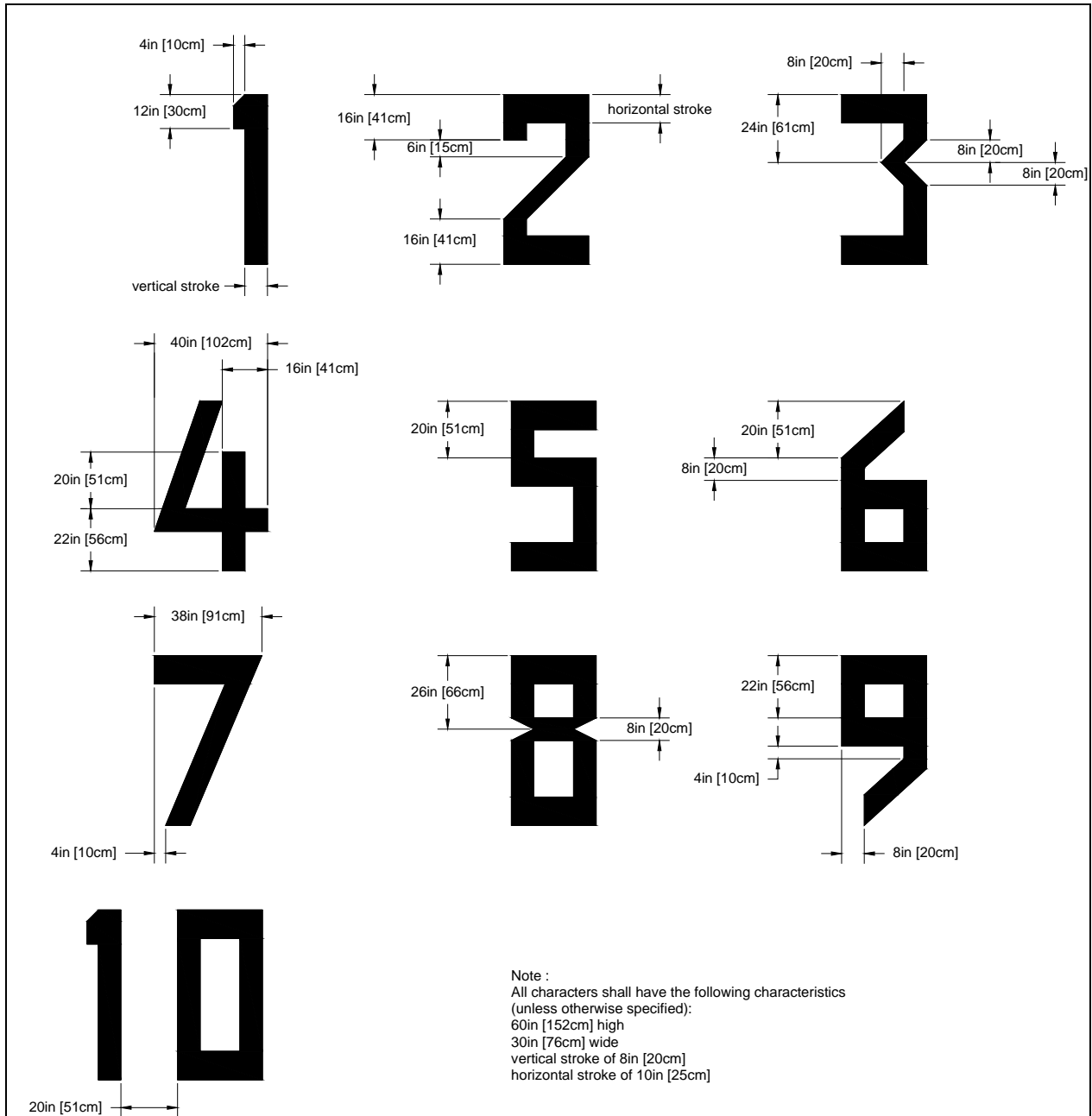


Figure A3- 2. Form and Proportions of 5 foot (1.5 m) Numbers for Marking Size and Weight Limitations

APPENDIX 4. ASSOCIATED PUBLICATIONS

The following is a listing of related documents. Current Advisory Circulars are available from the FAA web site <http://www.airweb.faa.gov/>. Current Electronic Code of Federal Regulations (e-CFRs) are available from the Government Printing Office web site <http://www.gpoaccess.gov/ecfr/>. Airport Advisory Circulars are available at the Airports web site <http://faa.gov/arp>. Technical reports are available at the National Technical Information Service (NTIS) web site <http://www.ntis.gov/>.

1. AC 00-2.14, *Advisory Circular Checklist*.
2. AC 20-35, *Tie-Down Sense*.
3. AC 70/7460-1, *Obstruction Marking and Lighting*.
4. AC 70/7460-2, *Proposed Construction or Alteration of Objects that May Affect the Navigable Airspace*.
5. AC 150/5000-3, *Address List for Regional Airports Divisions and Airports District/Field Offices*.
6. AC 150/5190-4, *A Model Zoning Ordinance to Limit Height of Objects Around Airports*.
7. AC 150/5200-30, *Airport Winter Safety and Operations*.
8. AC 150/5220-16, *Automated Weather Observing Systems (AWOS) for Non-Federal Applications*.
9. AC 150/5230-4, *Aircraft Fuel Storage, Handling, and Dispensing on Airports*.
10. AC 150/5320-6, *Airport Pavement Design and Evaluation*.
11. AC 150/5340-24, *Runway and Taxiway Edge Lighting System*.
12. AC 150/5340-28, *Low Visibility Taxiway Lighting System*.
13. AC 150/5340-30, *Design and Installation Detail for Airport Visual Aids*.
14. AC 150/5345-12, *Specification for Airport and Heliport Beacon*.
15. AC150/5345-27, *Specification for Wind Cone Assemblies*.
16. AC 150/5345-28, *Precision Approach Path Indicator (PAPI) Systems*.
17. AC 150/5345-39, *FAA Specification L-853, Runway and Taxiway Centerline Retroreflective Markers*.
18. AC 150/5345-46, *Specification for Runway and Taxiway Light Fixtures*.
19. AC150/5345-52, *Generic Visual Glideslope Indicators (GVGI)*.
20. AC 150/5360-9, *Planning and Design of Airport Terminal Facilities at Non-Hub Locations*.
21. AC 150/5360-14, *Access to Airports by Individuals with Disabilities*.
22. AC 150/5370-10, *Standards for Specifying Construction of Airports*.
23. 14 CFR Part 135, *Operating Requirements: Commuter and on demand operations and rules governing persons on board such aircraft*
24. 14 CFR Part 27, *Airworthiness Standards: Normal Category Rotorcraft*.
25. 14 CFR Part 29, *Airworthiness Standards: Transport Category Rotorcraft*.
26. 14 CFR Part 77, *Objects Affecting Navigable Airspace*.
27. 14 CFR Part 91, *General Operating and Flight Rules*.
28. 14 CFR Part 121, *Operating Requirements: Domestic, Flag, and Supplemental Operations*.
29. 14 CFR Part 139, *Certification and Operations: Land Airports Serving Certain Air Carriers*.
30. 14 CFR Part 151, *Federal Aid to Airports*

31. 14 CFR Part 152, *Airport Aid Program*.
32. 14 CFR Part 157, *Notice of Construction, Alteration, Activation, and Deactivation of Airports*.
33. FAA Order 1050.1 *Policies and Procedures for Considering Environmental Impacts*.
34. FAA Order 5050.4A, *Airport Environmental Handbook*.
35. FAA Order 7400.2, *Procedures for Handling Airspace Matters*.
36. FAA Order 8260.3, *United States Standard for Terminal Instrument Procedures (TERPS)*.
37. FAA Order 8260.42, *Helicopter Global Positioning System (GPS) Non-precision Approach Criteria*.
38. FAA Standard 405, *Standards for Aeronautical Surveys and Related Products*.
39. National Fire Protection Association (NFPA) Pamphlet 403, *Aircraft Rescue Services*.
40. NFPA Pamphlet 418, *Standards for Heliports*.
41. FAA Technical Report FAA/RD-84/25, *Evaluating Wind Flow Around Buildings on Heliport Placement*, National Technical Information Service (NTIS) accession number AD-A153512.
42. FAA Technical Report FAA/RD-92/15, *Potential Hazards of Magnetic Resonance Imagers to Emergency Medical Service Helicopter Services*, National Technical Information Service (NTIS), accession number AD-A278877.
43. Annex 14 – Aerodromes. *The Convention on International Civil Aviation*

APPENDIX 5. ACRONYMS

AC	advisory circular
AGL	above ground level
AIM	Aeronautical Information Manual
ATC	air traffic control
ATCT	air traffic control tower
AWOS	automated weather observing system
AZ	azimuth
CFR	Code of Federal Regulations
dB	decibel
DH	decision height
DNL	Day/Night Average Sound Level
DWP	decision waypoint
E-L	electroluminescent
EMS	emergency medical service
EPNL	Effective Perceived Noise Level
FAA	Federal Aviation Administration
FAF	final approach fix
FARA	final approach reference area
FATO	final approach and takeoff area
FCC	Federal Communications Commission
FIG	figure
FTE	flight technical error
GA	General Aviation
GPI	glide path indicator
GPI	ground point of intercept
GPS	global positioning system
GVGI	generic visual glideslope indicator
H	identification symbol for marking the TLOF
HALS	heliport approach lighting system
HF	high frequency
HIGE	hover in ground effect
HILS	heliport instrument lighting system
HLP	heliport layout plan
HNM	Heliport Noise Model
HOGE	hover out-of-ground effect
H/V	height/velocity
HRP	heliport reference point
IFR	instrument flight rules
IGE	in ground effect
IMC	instrument meteorological conditions
kg/m ²	kilograms per square meter
lbs	pounds
lb/ft ²	pound per square foot
LED	light emitting diode
m	meter
MAP	missed approach point
MAWP	missed approach waypoint
MDA	minimum descent altitude
MRI	magnetic resonance imager
MSL	mean sea level

NAS	National Airspace System
NAVAID	navigational aid
NEPA	National Environmental Policy Act
NFPA	National Fire Protection Association
nm	nautical mile
OGE	out of ground effect
OIS	obstacle identification surface
OL	overall length of the design helicopter
OSHA	Occupational Safety and Health Administration
PAPI	precision approach path indicator
PCC	Portland Cement Concrete
PLV	powered-lift vehicle
PPR	prior permission required
RD	rotor diameter of the design helicopter
sm	statute mile
STOL	short takeoff and landing
TERPS	terminal instrument procedures
TLOF	touchdown and liftoff area
TW	taxiway
UC	maximum undercarriage dimension of the design helicopter
UNICOM	frequencies authorized for aeronautical advisory services to private aircraft
USA	United States of America
VFR	visual flight rules
VFTE	vertical flight technical error
VGI	visual glideslope indicator
VMC	visual meteorological conditions
VSDA	visual segment descent angle
VSRL	visual segment reference line
VTOL	vertical takeoff and landing