

**FIELD INSTRUCTIONS**  
**FOR THE ANNUAL INVENTORY OF**  
**WASHINGTON, OREGON, AND CALIFORNIA**

**2007**



Forest Inventory and Analysis Program

Pacific Northwest Research Station

USDA Forest Service



**FIELD INSTRUCTIONS**

**FOR THE ANNUAL INVENTORY OF**

**WASHINGTON, OREGON, AND CALIFORNIA**

**2007**

**Based on Version 3.0 of the National Core Procedures Manual**



## Table of Contents

<b>1</b>	<b>INTRODUCTION .....</b>	<b>1</b>
1.1	<b>ORGANIZATION OF THIS MANUAL .....</b>	<b>3</b>
1.2	<b>THE INVENTORY .....</b>	<b>3</b>
1.3	<b>PRODUCTS.....</b>	<b>3</b>
1.4	<b>UNITS OF MEASURE .....</b>	<b>4</b>
1.5	<b>PLOT DESIGN GENERAL DESCRIPTION .....</b>	<b>4</b>
1.6	<b>SAFETY .....</b>	<b>6</b>
	SAFETY IN THE WOODS .....	6
	SAFETY ON THE ROAD .....	7
	WHAT TO DO IF INJURED .....	7
1.7	<b>QA/QC .....</b>	<b>8</b>
<b>2</b>	<b>LOCATE AND LAY OUT STANDARD PLOTS.....</b>	<b>9</b>
2.1	<b>PRELIMINARY PREPARATION.....</b>	<b>11</b>
	LANDOWNER CONTACT .....	11
	BEFORE LEAVING FOR THE FIELD .....	11
2.2	<b>NAVIGATING TO THE PLOT .....</b>	<b>12</b>
	LOCATING AN ESTABLISHED PLOT.....	12
	LOCATING A PLOT WITH A REFERENCE POINT AND BASELINE .....	13
	REPLACEMENT PLOT (LOST PLOT).....	13
	LOCATING NEW PLOTS.....	13
	PLOTS WITH ACTIVE LOGGING .....	14
	SITUATIONS THAT PREVENT VISITING PLOTS .....	14
2.3	<b>PLOT/SUBPLOT LAYOUT AND REFERENCING .....</b>	<b>14</b>
	THE REFERENCE POINT (RP).....	14
	THE WITNESS TREE.....	15
2.4	<b>ESTABLISHING AND MONUMENTING NEW PLOTS .....</b>	<b>16</b>
	REFERENCE AND MONUMENT THE PLOT CENTER .....	17
	LOCATE, REFERENCE, AND MONUMENT THE OTHER SUBPLOTS.....	17
	LOCATE AND MONUMENT THE MICROPLOT .....	17
2.5	<b>REFERENCING AND MONUMENTING PREVIOUSLY ESTABLISHED PLOTS .....</b>	<b>17</b>
	REPLACEMENT PLOTS.....	18
2.6	<b>OTHER FIELD PLOTS ESTABLISHED USING THE 4-SUBPLOT DESIGN .....</b>	<b>18</b>
2.7	<b>REFERENCING AND MONUMENTING ENTIRELY NON-FOREST PLOTS .....</b>	<b>19</b>
	PLOTS LOCATED ON NATIONAL FOREST OWNERSHIP .....	19
	PLOTS LOCATED ON ALL OTHER OWNERSHIPS .....	19

<b>3</b>	<b>PLOT DATA .....</b>	<b>21</b>
<b>3.1</b>	<b>Time Spent Plot.....</b>	<b>23</b>
3.1.1	Travel Time to Plot (PNW) .....	23
3.1.2	Measurement Time on Plot (PNW) .....	23
3.1.3	Travel Time from Plot (PNW).....	23
<b>3.2</b>	<b>REFERENCE POINT (RP) ATTRIBUTES .....</b>	<b>24</b>
3.2.1	RP Species (PNW).....	24
3.2.2	RP Diameter (PNW).....	24
3.2.3	RP Azimuth (PNW).....	24
3.2.4	RP Distance (PNW).....	24
3.2.5	RP Az/Dist to Subplot # (PNW) .....	24
<b>3.3</b>	<b>PLOT ATTRIBUTES DOWNLOADED TO THE PDR.....</b>	<b>25</b>
3.3.1	STATE (CORE 1.1).....	25
3.3.2	COUNTY (CORE 1.2).....	25
3.3.3	PLOT NUMBER (CORE 1.3).....	25
3.3.4	Old PNW-FIA Plot Number (PNW) .....	25
3.3.5	CORE FIELD GUIDE VERSION # (CORE 1.9).....	25
3.3.6	PNW Data Recorder Program Version # (PNW) .....	25
3.3.7	DECLINATION (CORE OPTIONAL 1.11).....	26
3.3.8	Elevation (PNW) .....	26
3.3.9	Precipitation (PNW).....	26
3.3.10	Hydrologic Unit Code (PNW) .....	26
3.3.11	MACROPLOT BREAKPOINT DIAMETER (CORE OPTIONAL 1.17).....	26
3.3.12	Hectare Plot? (PNW).....	26
3.3.13	Date of Previous Inventory (PNW).....	26
3.3.14	Remeasurement Period (PNW).....	26
3.3.15	Previous Ground Land Class (PNW).....	27
3.3.16	Ecological Unit (PNW) .....	27
	SPECIAL STUDIES (PNW) .....	27
3.3.17	Special Study 2002a (Platform and Moss Abundance) .....	27
3.3.18	Special Study 2007a (Fire Effects and Recovery: 2006 Day Fire).....	27
	GPS INFORMATION .....	27
3.3.19	Previous UTM Zone (PNW) .....	27
3.3.20	Previous Easting (X) UTM (PNW).....	27
3.3.21	Previous Northing (Y) UTM (PNW).....	27
3.3.22	Previous Coordinates Method (PNW) .....	27
<b>3.4</b>	<b>PLOT ATTRIBUTES COLLECTED IN THE FIELD .....</b>	<b>28</b>
3.4.1	NFS Plot Number (PNW).....	28
3.4.2	PLOT STATUS (CORE 1.4).....	28
3.4.3	PLOT NONSAMPLED REASON (CORE 1.5).....	28
3.4.4	SUBPLOTS EXAMINED (CORE 1.6).....	29
3.4.5	SAMPLE KIND (CORE 1.7) .....	29
3.4.6	PNW Plot Kind (PNW) .....	30
3.4.7	PREVIOUS PLOT NUMBER (CORE 1.8).....	31
3.4.8	CREW TYPE (CORE 1.15).....	31
3.4.9	QA STATUS (CORE 1.14).....	31
3.4.10	Crew Leader (PNW).....	32
3.4.11	Crew Member 1 thru 5 (PNW).....	32
	CURRENT DATE OF INVENTORY.....	32
3.4.12	MONTH (CORE 1.10.2).....	32
3.4.13	DAY (CORE 1.10.3).....	32
3.4.14	YEAR (CORE 1.10.1).....	32
3.4.15	Landowner Plot Summary Request (PNW) .....	33
3.4.16	Owner name/address update (PNW).....	33

3.4.17	Topographic Position (PNW) .....	33
3.4.18	HORIZONTAL DISTANCE TO IMPROVED ROAD (CORE 1.12) .....	34
	GPS COORDINATES .....	34
3.4.19	GPS UNIT TYPE (CORE 1.16.3) .....	35
3.4.20	GPS SERIAL NUMBER (CORE 1.16.4) .....	35
3.4.21	GPS DATUM (CORE 1.16.5).....	35
3.4.22	COORDINATE SYSTEM (CORE 1.16.6) .....	35
3.4.23	UTM ZONE (CORE 1.16.9).....	35
3.4.24	EASTING (X) UTM (CORE 1.16.10).....	36
3.4.25	NORTHING (Y) UTM (CORE 1.16.11).....	36
3.4.26	GPS ELEVATION (CORE 1.16.15) .....	36
3.4.27	GPS ERROR (CORE 1.16.16) .....	36
3.4.28	NUMBER OF READINGS (CORE 1.16.17) .....	36
3.4.29	GPS FILENAME (CORE OPTIONAL 1.16.18).....	37
	CORRECTION FOR "OFFSET" LOCATION .....	37
3.4.30	AZIMUTH TO PLOT CENTER (CORE 1.16.13).....	37
3.4.31	DISTANCE TO PLOT CENTER (CORE 1.16.14).....	37
3.4.32	PLOT-LEVEL NOTES (CORE 1.18).....	37
<b>3.5</b>	<b>DATA ITEMS RECORDED ON THE PLOT CARD .....</b>	<b>38</b>
<b>4</b>	<b>CONDITION CLASS .....</b>	<b>39</b>
<b>4.1</b>	<b>DETERMINATION OF CONDITION CLASS .....</b>	<b>41</b>
<b>4.2</b>	<b>CONDITION CLASS STATUS DEFINITIONS .....</b>	<b>41</b>
	1. ACCESSIBLE FOREST LAND .....	41
	2. NONFOREST LAND .....	43
	3. NONCENSUS WATER .....	44
	4. CENSUS WATER .....	44
	5. NONSAMPLED .....	44
<b>4.3</b>	<b>CONDITION CLASS ATTRIBUTES.....</b>	<b>45</b>
<b>4.4</b>	<b>DETERMINING CONDITION CLASS STATUS.....</b>	<b>45</b>
	4.4.1 CONDITION CLASS NUMBER (CORE 2.4.1).....	45
	4.4.2 CONDITION CLASS STATUS (CORE 2.4.2) .....	46
	DETERMINING CONDITION CLASSES DIFFERING IN CONDITION CLASS STATUS .....	46
	4.4.3 CONDITION NONSAMPLED REASON (CORE 2.4.3).....	48
<b>4.5</b>	<b>DELINEATING CONDITION CLASSES ON ACCESSIBLE FOREST LAND.....</b>	<b>48</b>
	DELINEATING CONDITION CLASSES WITHIN ACCESSIBLE FOREST LANDS.....	49
	4.5.1 RESERVED STATUS (CORE 2.5.1).....	50
	4.5.2 OWNER GROUP (CORE OPTIONAL 2.5.2).....	51
	4.5.3 FOREST TYPE (CORE 2.5.3).....	51
	4.5.4 STAND SIZE CLASS (CORE 2.5.4).....	52
	4.5.5 REGENERATION STATUS (CORE 2.5.5).....	53
	4.5.6 TREE DENSITY (CORE 2.5.6).....	53
<b>4.6</b>	<b>NON-DELINEATING VARIABLES FOR ACCESSIBLE FOREST LAND.....</b>	<b>54</b>
	4.6.1 Current Ground Land Class (PNW) .....	54
	4.6.2 OWNER CLASS (CORE OPTIONAL 2.5.7).....	55
	4.6.3 PRIVATE OWNER INDUSTRIAL STATUS (CORE 2.5.8).....	56
	4.6.4 ARTIFICIAL REGENERATION SPECIES (CORE 2.5.9).....	56
	4.6.5 STAND AGE (CORE 2.5.10) .....	57
	4.6.6 Stand Structure (PNW) .....	58
	4.6.7 DISTURBANCE 1 (CORE 2.5.11).....	58

4.6.8	DISTURBANCE YEAR 1 (CORE 2.5.12).....	59
4.6.9	DISTURBANCE 2 (CORE 2.5.13).....	59
4.6.10	DISTURBANCE YEAR 2 (CORE 2.5.14).....	59
4.6.11	DISTURBANCE 3 (CORE 2.5.15).....	60
4.6.12	DISTURBANCE YEAR 3 (CORE 2.5.16).....	60
4.6.13	Historical Disturbance 1 (PNW).....	60
4.6.14	Historical Disturbance Year 1 (PNW).....	60
4.6.15	Historical Disturbance 2 (PNW).....	60
4.6.16	Historical Disturbance Year 2 (PNW).....	60
4.6.17	Historical Disturbance 3 (PNW).....	60
4.6.18	Historical Disturbance Year 3 (PNW).....	60
4.6.19	TREATMENT 1 (CORE 2.5.17).....	60
4.6.20	TREATMENT YEAR 1 (CORE 2.5.18).....	62
4.6.21	TREATMENT 2 (CORE 2.5.19).....	62
4.6.22	TREATMENT YEAR 2 (CORE 2.5.20).....	62
4.6.23	TREATMENT 3 (CORE 2.5.21).....	62
4.6.24	TREATMENT YEAR 3 (CORE 2.5.22).....	62
4.6.25	Historical Treatment 1 (PNW).....	62
4.6.26	Historical Treatment Year 1 (PNW).....	62
4.6.27	Historical Treatment 2 (PNW).....	63
4.6.28	Historical Treatment Year 2 (PNW).....	63
4.6.29	Historical Treatment 3 (PNW).....	63
4.6.30	Historical Treatment Year 3 (PNW).....	63
4.6.31	Evidence of Stumps (PNW).....	63
4.6.32	Evidence of Fire (PNW).....	63
4.6.33	PHYSIOGRAPHIC CLASS (CORE 2.5.23).....	63
4.6.34	Soil Depth (PNW).....	63
4.6.35	Stand Condition/Stage of Development (PNW).....	64
4.6.36	Plant Association (PNW).....	64
4.6.37	Mixed Conifer Site (PNW-CA).....	65
4.6.38	Stockability Indicator Set (PNW).....	66
<b>4.7</b>	<b>NON-FOREST LANDS: DELINEATING CONDITION CLASS .....</b>	<b>66</b>
4.7.1	PRESENT NON-FOREST LAND USE (CORE OPTIONAL 2.5.24).....	66
<b>5</b>	<b>SUBPLOT ATTRIBUTES.....</b>	<b>69</b>
<b>5.1</b>	<b>SUBPLOT IDENTIFICATION.....</b>	<b>71</b>
5.1.1	SUBPLOT NUMBER (CORE 3.1).....	71
5.1.2	SUBPLOT/MACROPLOT STATUS (CORE 3.2).....	71
5.1.3	SUBPLOT/MACROPLOT NONSAMPLED REASON (CORE 3.3).....	72
5.1.4	SUBPLOT/MACROPLOT CONDITION LIST (CORE OPTIONAL 3.9).....	72
5.1.5	SUBPLOT CENTER CONDITION (CORE 3.4).....	73
<b>5.2</b>	<b>PHYSIOGRAPHIC CLASS INFORMATION.....</b>	<b>73</b>
5.2.1	SUBPLOT ASPECT (CORE 3.7).....	73
5.2.2	SUBPLOT SLOPE (CORE 3.6).....	73
5.2.3	<i>Macroplot</i> Physiographic Class (PNW).....	74
<b>5.3</b>	<b>WATER INFORMATION .....</b>	<b>75</b>
5.3.1	WATER ON <i>MACROPLOT</i> (CORE 1.13).....	75
5.3.2	Water Proximity (PNW).....	75
5.3.3	SNOW/WATER DEPTH (CORE 3.8).....	76
<b>5.4</b>	<b>MICROPLOT ATTRIBUTES .....</b>	<b>76</b>
5.4.1	MICROPLOT CENTER CONDITION (CORE 3.5).....	76
	MICROPLOT SEEDLING COUNT.....	76



5.4.2	SUBPLOT NUMBER (CORE 6.1).....	76
5.4.3	CONDITION CLASS NUMBER (CORE 6.3) .....	76
5.4.4	SPECIES (CORE 6.2).....	76
5.4.5	SEEDLING COUNT (CORE 6.4).....	76
	FUEL LOADING ON THE MICROPLOT.....	77
5.4.6	Fuel Loading: Subplot Number (PNW).....	77
5.4.7	Fuel Loading: Live Shrub Percent Cover (PNW).....	78
5.4.8	Fuel Loading: Live Shrub Height (PNW).....	78
5.4.9	Fuel Loading: Dead Shrubs Percent Cover (PNW).....	78
5.4.10	Fuel Loading: Dead Shrubs Height (PNW).....	78
5.4.11	Fuel Loading: Live Herbs Percent Cover (PNW).....	79
5.4.12	Fuel Loading: Live Herbs Height (PNW).....	79
5.4.13	Fuel Loading: Dead Herbs Percent Cover (PNW).....	79
5.4.14	Fuel Loading: Dead Herbs Height (PNW).....	79
5.4.15	Fuel Loading: Litter Percent Cover (PNW).....	79
<b>5.5</b>	<b>BOUNDARY REFERENCE MAPPING.....</b>	<b>80</b>
	REFERENCE PROCEDURES.....	80
	BOUNDARY DATA .....	81
5.5.1	SUBPLOT NUMBER (CORE 4.2.1).....	81
5.5.2	PLOT TYPE (CORE 4.2.2).....	81
5.5.3	CONTRASTING CONDITION (CORE 4.2.4) .....	81
5.5.4	LEFT AZIMUTH (CORE 4.2.5).....	81
5.5.5	CORNER AZIMUTH (CORE 4.2.6).....	82
5.5.6	CORNER DISTANCE (CORE 4.2.7).....	82
5.5.7	RIGHT AZIMUTH (CORE 4.2.8) .....	82
5.5.8	BOUNDARY CHANGE (CORE 4.2.3).....	82
	HECTARE PLOT MAPPING.....	82
	BOUNDARY MAPPING EXAMPLES .....	83
<b>5.6</b>	<b>SUBPLOT/MACROPLOT NON-FOREST INCLUSIONS .....</b>	<b>84</b>
5.6.1	Non-forest Inclusions: Mapping and Recording (PNW).....	84
	DOWNLOADED ESTIMATES OF NONFOREST INCLUSIONS.....	85
	EXAMPLES OF NONFOREST INCLUSIONS .....	85
	ESTIMATING NONFOREST INCLUSION AREA PERCENTAGES BY CONDITION CLASS.....	86
<b>5.7</b>	<b>ROOT DISEASE MAPPING/RATING.....</b>	<b>87</b>
5.7.1	Root Disease Mapping and Recording (PNW).....	87
	DOWNLOADED ESTIMATES OF ROOT DISEASE.....	87
	MAPPING ROOT DISEASE .....	87
	GUIDE FOR IDENTIFYING ROOT DISEASE .....	89
	ESTIMATING ROOT DISEASE AREA PERCENTAGES BY CONDITION CLASS.....	89
5.7.2	Root Disease Severity Rating (PNW).....	89
<b>5.8</b>	<b>SUBPLOT DISTURBANCE .....</b>	<b>90</b>
5.8.1	Burn Assessment (PNW).....	90
5.8.2	Mechanical Management Assessment (PNW).....	90
<b>6</b>	<b>DOWN WOODY MATERIALS .....</b>	<b>91</b>
<b>6.1</b>	<b>DEFINITION OF DOWN WOODY MATERIALS.....</b>	<b>93</b>
	CWD.....	93
	FWD.....	93
<b>6.2</b>	<b>LOCATING AND ESTABLISHING LINE TRANSECTS.....</b>	<b>94</b>
	CWD TRANSECTS.....	94
	FWD TRANSECTS .....	94

<b>6.3</b>	<b>TRANSECT LINE SEGMENTING</b> .....	<b>95</b>
6.3.1	Subplot Number (PNW).....	96
6.3.2	Transect (PNW).....	96
6.3.3	Condition Class Number (PNW).....	96
6.3.4	Beginning Distance PNW (PNW).....	96
6.3.5	Ending Distance (PNW).....	97
6.3.6	Slope Percent (PNW).....	97
<b>6.4</b>	<b>SAMPLING METHODS FOR COARSE WOODY DEBRIS (CWD)</b> .....	<b>97</b>
	MARKING CWD.....	100
	RECORDING PROCEDURES FOR CWD.....	100
6.4.1	Subplot Number (PNW).....	100
6.4.2	Transect (PNW).....	100
6.4.3	CWD Slope Distance (PNW).....	100
6.4.4	CWD Decay Class (PNW).....	101
6.4.5	Species (PNW).....	101
	DIAMETERS.....	102
6.4.6	Diameter at Point of Intersection (PNW).....	103
6.4.7	Diameter at the Small End (PNW).....	103
6.4.8	Diameter at the Large End (PNW).....	103
6.4.9	CWD Total length (PNW).....	104
6.4.10	Hollow (PNW).....	104
6.4.11	Percent of Log Charred by Fire (PNW).....	104
6.4.12	CWD History (PNW).....	105
<b>6.5</b>	<b>SAMPLING METHODS FOR FINE WOODY DEBRIS (FWD)</b> .....	<b>105</b>
6.5.1	Subplot Number (PNW).....	106
6.5.2	Condition Class Number (PNW).....	106
6.5.3	Residue Pile on Transect (PNW).....	106
6.5.4	Small FWD Count (PNW).....	106
6.5.5	Medium FWD Count (PNW).....	107
6.5.6	Large FWD Count (PNW).....	107
6.5.7	High Count Reason (PNW).....	107
<b>6.6</b>	<b>DUFF, LITTER, AND FUELBED DEPTH MEASUREMENTS</b> .....	<b>107</b>
	DEFINITIONS.....	107
	OVERVIEW OF MEASUREMENTS.....	108
6.6.1	Subplot Number (PNW).....	108
6.6.2	Transect (PNW).....	109
6.6.3	Duff, Litter, and Fuelbed Sample (PNW).....	109
6.6.4	Duff Depth (PNW).....	109
6.6.5	Litter Depth (PNW).....	109
6.6.6	Fuelbed Depth (PNW).....	109
<b>6.7</b>	<b>SAMPLING RESIDUE PILES WITHIN THE 58.9' MACROPLOT</b> .....	<b>109</b>
	SELECTION INSTRUCTIONS.....	110
6.7.1	Subplot Number (PNW).....	110
6.7.2	Condition Class (PNW).....	110
6.7.3	Pile Azimuth (PNW).....	111
6.7.4	Shape (PNW).....	111
6.7.5	Pile Length 1 (PNW).....	111
6.7.6	Pile Length 2 (PNW).....	111
6.7.7	Pile Width 1 (PNW).....	111
6.7.8	Pile Width 2 (PNW).....	112
6.7.9	Pile Height 1 (PNW).....	112
6.7.10	Pile Height 2 (PNW).....	112
6.7.11	Pile Density (PNW).....	112
6.7.12	Horizontal Distance to Pile (PNW).....	112

<b>7</b>	<b>LIVE AND STANDING DEAD TREE TALLY .....</b>	<b>113</b>
	DEFINITIONS .....	115
<b>7.1</b>	<b>SELECTING TALLY TREES.....</b>	<b>115</b>
	WHERE TO TALLY .....	115
	WITHIN PLOT AREA CRITERIA .....	116
	ADDITIONAL CRITERIA .....	116
<b>7.2</b>	<b>CONDUCTING THE TREE TALLY .....</b>	<b>117</b>
	CONDITION CLASS STATUS = 1: ACCESSIBLE FOREST LAND.....	117
	CONDITION CLASS NOT ACCESSIBLE FOREST LAND & NOT R6 OR R5 NATIONAL FORESTS .....	118
<b>7.3</b>	<b>PDR GENERATED TRACKING VARIABLES.....</b>	<b>118</b>
7.3.1	Line Number (PNW).....	118
7.3.2	TREE RECORD NUMBER (CORE 5.2).....	118
7.3.3	SUBPLOT NUMBER (CORE 5.1).....	118
<b>7.4</b>	<b>FIELD GENERATED TRACKING VARIABLES.....</b>	<b>118</b>
7.4.1	Tree Tag Number (PNW) .....	119
7.4.2	Previous Tree Tag Number (PNW).....	119
7.4.3	CONDITION CLASS NUMBER (CORE 5.3) .....	119
7.4.4	PREVIOUS TREE STATUS (CORE 5.6).....	120
7.4.5	Subplot Witness Flag (PNW) .....	120
7.4.6	PRESENT TREE STATUS (CORE 5.7).....	120
7.4.7	STANDING DEAD (CORE 5.7.2).....	121
7.4.8	RECONCILE (CORE 5.7.1) .....	122
7.4.9	SPECIES (CORE 5.8).....	123
<b>7.5</b>	<b>MONUMENTING INFORMATION.....</b>	<b>123</b>
7.5.1	AZIMUTH (CORE 5.4) .....	123
7.5.2	HORIZONTAL DISTANCE (CORE 5.5) .....	124
7.5.3	Witness Tree or Object Slope Distance (PNW) .....	124
<b>7.6</b>	<b>DIAMETER .....</b>	<b>124</b>
	MARKING CURRENT DIAMETER:.....	125
7.6.1	PREVIOUS DIAMETER AT BREAST HEIGHT (CORE 5.9.1) .....	125
7.6.2	DIAMETER AT BREAST HEIGHT (CORE 5.9.2).....	126
	SPECIAL DBH SITUATIONS .....	126
7.6.3	PREVIOUS DIAMETER AT ROOT COLLAR (CORE 5.9.3).....	129
	DIAMETER AT ROOT COLLAR (CORE 5.9.4) .....	129
7.6.4	DRC STEM DIAMETER (CORE 5.9.4.1).....	130
7.6.5	DRC STEM STATUS (CORE 5.9.4.2).....	130
7.6.6	PAST NUMBER OF STEMS (CORE 5.10).....	131
7.6.7	CURRENT NUMBER OF STEMS (CORE 5.11).....	131
7.6.8	DIAMETER CHECK (CORE 5.12).....	132
<b>7.7</b>	<b>GROWTH.....</b>	<b>132</b>
7.7.1	10-Year Increment (PNW).....	132
7.7.2	5-Year Increment (PNW).....	133
7.7.3	5-Year Height Growth (PNW) .....	133
7.7.4	Tree Age (PNW) .....	133
7.7.5	Tree Age Method (PNW).....	135
	LENGTH .....	135
7.7.6	ACTUAL LENGTH (CORE 5.15).....	135
7.7.7	TOTAL LENGTH (CORE 5.14).....	135
7.7.8	LENGTH METHOD (CORE 5.16) .....	136
7.7.9	Previous Actual Length (PNW).....	137

<b>7.8</b>	<b>TREE LIVE CROWN MEASUREMENTS.....</b>	<b>137</b>
7.8.1	COMPACTED CROWN RATIO (CORE 5.19).....	137
7.8.2	CROWN CLASS (CORE 5.17).....	137
<b>7.9</b>	<b>TREE DAMAGE .....</b>	<b>138</b>
	DAMAGE DEFINITIONS.....	138
	IDENTIFYING AND RECORDING DAMAGE .....	142
7.9.1	Damage Location 1 (PNW).....	143
7.9.2	Damage Agent 1 (PNW).....	143
7.9.3	Damage Severity 1A (PNW).....	144
7.9.4	Damage Severity 1B (PNW).....	144
7.9.5	Unknown Damage Type 1 (PNW).....	144
7.9.6	Damage Location 2 (PNW).....	144
7.9.7	Damage Agent 2 (PNW).....	144
7.9.8	Damage Severity 2A (PNW).....	144
7.9.9	Damage Severity 2B (PNW).....	144
7.9.10	Unknown Damage Type 2 (PNW).....	144
7.9.11	DWARF MISTLETOE CLASS (CORE OPTIONAL 5.26).....	145
7.9.12	ROTTEN/MISSING CULL (CORE 5.13).....	145
7.9.13	ROUGH CULL (CORE OPTIONAL 5.25).....	147
7.9.14	Cavity presence (PNW).....	147
<b>7.10</b>	<b>MISCELLANEOUS LIVE TREE MEASURED VARIABLES .....</b>	<b>147</b>
7.10.1	Remnant Tree (PNW).....	147
7.10.2	Hardwood Clump (PNW).....	148
7.10.3	Form Class (PNW).....	148
7.10.4	TREE NOTES (CORE 5.27).....	149
<b>7.11</b>	<b>DEAD STANDING OR REMOVED .....</b>	<b>149</b>
7.11.1	CAUSE OF DEATH (CORE 5.21).....	149
7.11.2	MORTALITY YEAR (CORE OPTIONAL 5.20).....	150
7.11.3	Stump (PNW).....	150
7.11.4	SNAG DECAY CLASS (CORE 5.23).....	150
7.11.5	Snag Reason for Disappearance (PNW).....	151
7.11.6	Utilization Class (PNW).....	151
<b>7.12</b>	<b>SPECIAL STUDIES.....</b>	<b>152</b>
	Special Study 2007a (Day Fire) Fire Effects and Recovery.....	152
	Special Study 2002a Platform and Moss Abundance.....	152
7.12.1	Platform Abundance (PNW).....	152
7.12.2	Moss Abundance (PNW).....	152
<b>7.13</b>	<b>MORTALITY AND GROWTH ASSESSMENT FROM PREVIOUS OCCASION (PNW).....</b>	<b>153</b>
7.13.1	Mortality Line # (PNW).....	153
7.13.2	Mortality Tree Tag # (PNW).....	153
7.13.3	Mortality Tree History (PNW).....	153
7.13.4	Cause of Death / Damaging Agent (PNW).....	154
7.13.5	Remeasured Diameter (PNW).....	154
7.13.6	Remeasured Diameter Check (PNW).....	154
<b>8</b>	<b>VEGETATION PROFILE.....</b>	<b>157</b>
<b>8.1</b>	<b>VEGETATION PLOT DESIGN .....</b>	<b>159</b>
<b>8.2</b>	<b>SPECIES RECORDS .....</b>	<b>159</b>
8.2.1	Species Growth Habit (PNW).....	160
8.2.2	Species (PNW).....	160

8.2.3	Species Height (PNW).....	161
8.2.4	Species Cover (PNW).....	162
8.2.5	Stage of Shrub Development (PNW).....	165
<b>8.3</b>	<b>LIFEFORM AND TOTAL VEGETATION RECORDS.....</b>	<b>165</b>
8.3.1	Percent Total Tree Seedling Cover (PNW).....	165
8.3.2	Percent Total Shrub Cover (PNW).....	165
8.3.3	Percent Total Forb Cover (PNW).....	165
8.3.4	Percent Total Graminoid Cover (PNW).....	165
8.3.5	Percent Bare Soil (PNW).....	165
8.3.6	Percent Total Vegetation Cover (PNW).....	166
<b>8.4</b>	<b>COLLECTION AND IDENTIFICATION OF UNKNOWN PLANTS.....</b>	<b>166</b>
<b>8.5</b>	<b>INDICATOR AND WEED LISTS.....</b>	<b>166</b>
	R5 Weed List (PNW).....	166
	R6 Indicator List (PNW).....	166
<b>8.6</b>	<b>Literature Cited.....</b>	<b>166</b>
<b>9</b>	<b>SITE INDEX.....</b>	<b>167</b>
<b>9.1</b>	<b>SITE TREES.....</b>	<b>169</b>
	GENERAL INSTRUCTIONS.....	169
	PREVIOUSLY VISITED PLOTS.....	170
	NEW PLOTS.....	170
<b>9.2</b>	<b>SELECTING SITE TREE SPECIES.....</b>	<b>171</b>
	HIERARCHY OF METHOD SELECTION: "HOW TO DECIDE METHOD".....	171
	KING'S SELECTION METHOD.....	171
	PRIMARY SELECTION METHOD, CONIFERS.....	172
	PRIMARY SELECTION METHOD, HARDWOODS.....	173
	MIXED CONIFER SELECTION METHOD.....	173
	SITE DESCRIPTIONS.....	173
<b>9.3</b>	<b>SITE TREE DATA VARIABLES.....</b>	<b>174</b>
9.3.1	Site Tree Number (PNW).....	174
9.3.2	SUBPLOT NUMBER (CORE OPTIONAL 7.2.7).....	174
9.3.3	CONDITION CLASS LIST (CORE 7.2.1).....	174
9.3.4	Tree Tag Number (PNW).....	174
9.3.5	AZIMUTH (CORE OPTIONAL 7.2.8).....	175
9.3.6	HORIZONTAL DISTANCE (CORE OPTIONAL 7.2.9).....	175
9.3.7	SPECIES (CORE 7.2.2).....	175
9.3.8	DIAMETER (CORE 7.2.3).....	175
9.3.9	SITE TREE LENGTH (CORE 7.2.4).....	175
9.3.10	TREE AGE AT DIAMETER (CORE 7.2.5).....	176
9.3.11	Site Tree Selection Method (PNW).....	176
9.3.12	Site Index (PNW).....	176
9.3.13	SITE TREE NOTES (CORE 7.2.6).....	176
<b>9.4</b>	<b>SITE TREES: POST FIELD REVIEW.....</b>	<b>176</b>
<b>9.5</b>	<b>STOCKABILITY IN OREGON AND CALIFORNIA.....</b>	<b>176</b>
9.5.1	Stockability Indicators for Oregon (PNW).....	176
9.5.2	Oregon Stockability Discount Factor (PNW).....	177
9.5.3	Stockability Indicators for California (PNW).....	178

<b>10</b>	<b>GROUND COVER ON NFS LANDS .....</b>	<b>183</b>
<b>10.1</b>	<b>GROUND COVER MEASUREMENTS .....</b>	<b>185</b>
10.1.1	Subplot Number (PNW) .....	185
10.1.2	Transect (PNW) .....	185
10.1.3	Segment ID (PNW).....	185
10.1.4	Ground Cover Type (PNW).....	186
10.1.5	Cover (PNW).....	187

## APPENDICES TABLE OF CONTENTS

<b>APPENDIX 1 NATIONAL FOREST PLOTS SPECIAL RULES .....</b>	<b>A1</b>
<b>A1.1 HECTARE PLOT ON NATIONAL FOREST LANDS.....</b>	<b>A1</b>
Mapping Hectare Condition Classes on R5 National Forest Lands .....	A1
Mapping Hectare Condition classes on R6 National Forest Lands .....	A1
<b>A1.2 NONFOREST CONDITION CLASS EXCEPTIONS ON NATIONAL FOREST LANDS .....</b>	<b>A1</b>
<b>A1.3 MONUMENTING WILDERNESS AREAS.....</b>	<b>A4</b>
<b>A1.4 GROUND COVER ON NFS LANDS .....</b>	<b>A4</b>
<b>A1.5 PREVIOUSLY USED REFERENCES, PROCEDURES, AND CODES.....</b>	<b>A4</b>
R4 (Idaho, Nevada) .....	A4
R5 (CALIFORNIA) .....	A5
A. R5 National Forest and Ranger District Codes .....	A5
B. R5 Periodic Survey Tree Type Measurement Codes (Used in R5 past data only) .....	A7
C. REGION 5 Periodic Survey plot vegetation profile information (Used in R5 past data only) .....	A8
D. Prism Factors used on past R5 Survey plots: 20 or 40 BAF .....	A9
E. R5 Past Survey Plot Designs .....	A10
R6 (OREGON, WASHINGTON).....	A11
A. R6 Past Survey Plot Designs (CVS) .....	A11
<b>A1.6 NATIONAL FOREST AND RANGER DISTRICT INFORMATION .....</b>	<b>A12</b>
REGION 4.....	A12
REGION 4 Nevada: National Forest and Ranger District Location Information.....	A12
REGION 5.....	A12
REGION 5 California: National Forest and Ranger District Location Information .....	A12
R5 National Forest Contacts for FIA (updated 2006 by K. Casey) .....	A14
REGION 6.....	A15
REGION 6 Oregon: National Forest and Ranger District Location Information .....	A15
REGION 6 Washington: National Forest and Ranger District Location Information .....	A16
<b>A1.7 REFERENCE TABLES FOR FIA PLOTS ON NATIONAL FOREST LANDS .....</b>	<b>A17</b>
A. R5 Survey Tree Species Codes and Current PNW-FIA Annual Tree Species Equivalent.....	A17
B. R5 Weed List.....	A18
C. R6 Plant Indicator and Weed Species Lists.....	A18
<b>A1.8 CHAPARRAL SPECIAL RULES FOR R5 NATIONAL FOREST LANDS .....</b>	<b>A41</b>
A. Introduction to Chaparral.....	A41
B. Chaparral Plot Installation and Layout Rules .....	A41
C. Chaparral Procedures .....	A42
<b>APPENDIX 2 OUTSIDE NATIONAL FORESTS.....</b>	<b>A47</b>
<b>A2.1 THE INVENTORY OF CALIFORNIA .....</b>	<b>A47</b>
California Background .....	A47
History of Survey Occasion dates in California: .....	A47
California Inventory Design .....	A47
PNW past Occasion 3 Plot layout in California .....	A48
<b>A2.2 THE INVENTORY IN OREGON AND WASHINGTON .....</b>	<b>A48</b>
Oregon/Washington Background .....	A48
Oregon/Washington Inventory design .....	A48

	Oregon/Washington Previous plot layouts .....	A50
<b>A2.3</b>	<b>PNW TREE HISTORY CODES AND DEFINITIONS FROM THE PAST PERIODIC INVENTORIES..</b>	<b>A52</b>
<b>A2.4</b>	<b>FOREST HEALTH MONITORING PROGRAM .....</b>	<b>A52</b>
	California Forest Health Monitoring Program .....	A52
	Oregon/Washington Forest Health Monitoring Program .....	A52
<b>A2.5</b>	<b>ADDITIONAL SOURCES OF DOCUMENTATION.....</b>	<b>A53</b>
	California.....	A53
	Oregon and Washington.....	A53
<b>A2.6</b>	<b>MONUMENTING WILDERNESS AREAS.....</b>	<b>A53</b>
	Monumenting within Wilderness Areas on BLM Lands .....	A53
	Monumenting within National Park Service Wilderness Areas .....	A53
<b>A2.7</b>	<b>SUDDEN OAK DEATH (SOD) SYNDROME ASSESSMENT IN CALIFORNIA .....</b>	<b>A54</b>
<b>APPENDIX 3 PLANT ASSOCIATION AND COUNTY .....</b>		<b>A55</b>
<b>A3.1</b>	<b>WASHINGTON COUNTY KEY .....</b>	<b>A55</b>
<b>A3.2</b>	<b>WASHINGTON PLANT ASSOCIATION GUIDES.....</b>	<b>A55</b>
	NW Washington.....	A55
	SW Washington .....	A56
	NE Washington.....	A56
<b>A3.3</b>	<b>OREGON COUNTY KEY .....</b>	<b>A58</b>
<b>A3.4</b>	<b>OREGON PLANT ASSOCIATION GUIDES.....</b>	<b>A59</b>
	NW Oregon.....	A59
	SW Oregon.....	A59
	CE Oregon.....	A59
	NE Oregon.....	A59
<b>A3.5</b>	<b>CALIFORNIA.....</b>	<b>A65</b>
<b>A3.6</b>	<b>CALIFORNIA PLANT ASSOCIATION GUIDES.....</b>	<b>A65</b>
<b>APPENDIX 4 PREVIOUS GROUND LAND CLASS .....</b>		<b>A67</b>
<b>APPENDIX 5 REFERENCE INFORMATION .....</b>		<b>A69</b>
<b>A5.1</b>	<b>STATE CODES .....</b>	<b>A69</b>
<b>A5.2</b>	<b>COUNTY CODES AND DECLINATIONS .....</b>	<b>A69</b>
	California County Codes.....	A69
	Oregon County Codes.....	A70
	Washington County Codes.....	A71
	Nevada County Codes .....	A71
	Idaho County Codes.....	A72
<b>A5.3</b>	<b>SLOPE CORRECTION TABLE .....</b>	<b>A72</b>
<b>A5.4</b>	<b>METRIC EQUIVALENTS AND AIDS.....</b>	<b>A73</b>



<b>APPENDIX 6 COORDINATES (GPS)</b> .....	<b>A75</b>
A6.1 OVERVIEW.....	A75
A6.2 WHEN AND WHERE TO COLLECT READINGS .....	A75
A6.3 RECORDING GPS INFORMATION.....	A75
A6.4 GPS KEYPAD LAYOUT AND COMMANDS.....	A76
GPS Keypad Commands .....	A76
A6.5 GPS SETUP OPTIONS .....	A77
NAVIGATION SCREENS .....	A77
Setup Units .....	A77
Customizing Navigation Screens.....	A77
A6.6 OPERATING THE GPS ON PLOT.....	A78
A6.7 COLLECTING COORDINATES AWAY FROM PLOT CENTER .....	A80
A6.8 WAYPOINTS (ADVANCED GPS USE).....	A80
A6.9 NAVIGATING WITH THE GPS (ADVANCED GPS USE).....	A81
A6.10 BATTERIES.....	A82
<b>APPENDIX 7 LASER 200 INSTRUCTIONS</b> .....	<b>A83</b>
A7.1 OVERVIEW.....	A83
A7.2 BASIC OPERATION .....	A83
A7.3 SETTINGS .....	A83
A7.4 FILTER AND REFLECTORS .....	A84
A7.5 DISTANCE AND % SLOPE .....	A84
A7.6 TREE HEIGHTS .....	A84
A7.7 GATES.....	A84
A7.8 CUMULATIVE DISTANCES .....	A85
<b>APPENDIX 8 FOREST TYPE CODES</b> .....	<b>A87</b>
<b>APPENDIX 9 TREE SPECIES LISTS</b> .....	<b>A91</b>
<b>APPENDIX 10 DISEASE KEYS</b> .....	<b>A99</b>
A10.1 Root Disease Identification Aids:.....	A99
General Root Disease Symptoms .....	A99
Individual Disease Descriptions:.....	A99
Listing of Disease-Tolerant Species by Root Disease: .....	A100

<b>APPENDIX 11 DETERMINATION OF STOCKING VALUES.....</b>	<b>A101</b>
A11.1 Stocking values for all tallied trees on the four subplots and microplots.....	A104
A11.2 Stocking values for all trees tallied on the subplot only .....	A105
A11.3 Stocking values for all trees < 7 inches, observed on the four subplots only.....	A106
A11.4 Stocking values for all trees 5.0 inches and greater observed on the four subplots only .....	A107
A11.5 DBH of the largest tally tree in the condition.....	A108
A11.6 Stocking values for all trees 5.0 inches and greater observed on one acre .....	A109
A11.7 Minimum number of trees per acre for forest land based on largest tally tree.....	A110
<b>APPENDIX 12 CORRESPONDENCE AND CONTACT EXAMPLES .....</b>	<b>A111</b>
A12.1 HELLO LETTER/DATA CONFIDENTIALITY .....	A111
A12.2 INTERIM LOCATION CONFIDENTIALITY POLICY .....	A112
Summary of FIA privacy (confidentiality) policy.....	A112
Conversation scenarios .....	A112
References .....	A114
A12.3 Access to Exact Coordinates for FIA Plots.....	A115
ACCESS TO EXACT COORDINATES ON PUBLIC LAND. ....	A115
ACCESS TO EXACT COORDINATES ON PRIVATE AND TRIBAL LAND .....	A116
A12.4 Confidentiality Certification.....	A117
A12.5 Sample Memorandum of Understanding .....	A120
A12.6 New Legislation on privacy for FIA data and information.....	A122
A12.7 LANDOWNER CONTACT LETTER .....	A127
A12.8 LIABILITY LETTER.....	A128
<b>APPENDIX 13 QUALITY ASSURANCE/QUALITY CONTROL .....</b>	<b>A129</b>
A13.1 Check Plots .....	A129
Objectives: Check Plots are Performed for Several Purposes:.....	A129
Check Plot Policies: The following policies for conducting check plots will be followed: .....	A129
Types of Check Plots:.....	A129
Check Plot Procedures: .....	A129
A13.2 2005 BLIND PLOT PROTOCOL.....	A129
What are blind plots?.....	A129
Blind Plot Selection.....	A130
State Coordinator Protocols .....	A130
Field Procedures.....	A131
<b>APPENDIX 14 GUIDELINES, TOLERANCE TABLES, PLOT FORMS .....</b>	<b>A133</b>

<b>A14.1</b>	<b>Tree Coding Guide for RECONCILE.....</b>	<b>A133</b>
<b>A14.2</b>	<b>Tolerances .....</b>	<b>A136</b>
<b>A14.3</b>	<b>Plot Card .....</b>	<b>A37</b>
<b>A14.4</b>	<b>Plot Card Write-Up.....</b>	<b>A139</b>
<b>A14.5</b>	<b>PLOT ATTRIBUTE DATA FORM .....</b>	<b>A140</b>
<b>A14.6</b>	<b>CONDITION CLASS ATTRIBUTES DATA FORM.....</b>	<b>A141</b>
<b>A14.7</b>	<b>SUBPLOT ATTRIBUTE DATA FORM.....</b>	<b>A142</b>
<b>A14.8</b>	<b>MICRO-PLOT ATTRIBUTES DATA FORMS .....</b>	<b>A143</b>
<b>A14.9</b>	<b>SITE TREE DATA FORM.....</b>	<b>A144</b>
<b>A14.10</b>	<b>VEGETATION PROFILE and SEEDLING COUNT DATA FORM .....</b>	<b>A145</b>
	VEGETATION PROFILE and SEEDLING COUNT DATA FORM, CONTINUED .....	A146
<b>A14.11</b>	<b>TRACKABLE TREE AND SNAG DATA FORM.....</b>	<b>A147</b>
<b>A14.12</b>	<b>WOODLAND STEM DIAMETER DATA FORM.....</b>	<b>A150</b>
<b>A14.13</b>	<b>DOWN WOODY MATERIAL DATA FORMS.....</b>	<b>A151</b>
	COARSE WOODY MATERIAL DATA FORM .....	A151
	CWM TRANSECT SEGMENTS .....	A152
	RESIDUE PILES.....	A152
	FINE WOODY MATERIALS and DUFF, LITTER, FUELBED DEPTH DATA FORMS .....	A153
	DUFF, LITTER, & FUELBED DEPTHS.....	A153
	GROUND COVER DATA FORM.....	A154
	<b>APPENDIX 15 GLOSSARY.....</b>	<b>A155</b>
	<b>APPENDIX 16 IMPORTANT PHONE NUMBERS.....</b>	<b>A159</b>
<b>A16.1</b>	<b>PNW-FIA.....</b>	<b>A159</b>
<b>A16.2</b>	<b>California .....</b>	<b>A161</b>
<b>A16.3</b>	<b>Oregon .....</b>	<b>A162</b>
<b>A16.4</b>	<b>Washington .....</b>	<b>A163</b>
	<b>APPENDIX 17 SUMMARY OF MANUAL CHANGES FROM 2006.....</b>	<b>A165</b>
	<b>APPENDIX 18 BLANK PAGE FOR NOTES .....</b>	<b>A169</b>



# 1 INTRODUCTION

## Table of Contents

<b>1</b>	<b>INTRODUCTION.....</b>	<b>1</b>
<b>1.1</b>	<b>ORGANIZATION OF THIS MANUAL .....</b>	<b>3</b>
<b>1.2</b>	<b>THE INVENTORY .....</b>	<b>3</b>
<b>1.3</b>	<b>PRODUCTS.....</b>	<b>3</b>
<b>1.4</b>	<b>UNITS OF MEASURE .....</b>	<b>4</b>
<b>1.5</b>	<b>PLOT DESIGN GENERAL DESCRIPTION .....</b>	<b>4</b>
<b>1.6</b>	<b>SAFETY .....</b>	<b>6</b>
	SAFETY IN THE WOODS .....	6
	SAFETY ON THE ROAD .....	7
	WHAT TO DO IF INJURED .....	7
<b>1.7</b>	<b>QA/QC .....</b>	<b>8</b>



## Chapter 1: INTRODUCTION

This manual documents the data collection procedures, codes, standards, and definitions used by the USDA Forest Service, Pacific Northwest Research Station's Forest Inventory and Analysis (PNW-FIA) program in the 2006 annual forest inventory of Oregon, Washington, and California. Five FIA programs across the country conduct forest inventories in most of the 50 states and the Pacific Islands. Consistent and uniform core data measurements are assured by following the procedures outlined by the National Forest Inventory and Analysis Field Guide. In addition to the core variables required by the National FIA program, PNW-FIA measures regional variables that are of interest to the clients and customers of the Pacific Northwest Research Station. PNW-FIA is also responsible for inventorying the forest resources of Alaska and the Pacific Islands.

### 1.1 ORGANIZATION OF THIS MANUAL

This manual is structured primarily for use by field personnel. Each chapter corresponds either to a separate function that must be performed in locating and measuring a field plot, or to a particular aspect of data recording that must be completed. The procedures in this manual are ordered to coincide as much as possible with the order in which field data items are collected and entered into the field data recorder.

This manual incorporates the field data collection procedures of the Forest Inventory and Analysis National CORE Field Guide, Version 3.0. Instructions in shaded text and data items in ALL CAPITAL letters describe data items or field procedures that are a part of that guide. Several of those items are still under development, or have unresolved issues at the time of this printing. Temporary regional adjustments are noted in *italic font* within the shaded text. Data items from the National Core Field Guide are distinguished by CAPITAL letters and followed by CORE and the Version 3.0 CORE variable number in parentheses. Portions of this manual which are not shaded are regional data items or procedures which supplement the national core data. These data items are not capitalized, and are followed by (PNW). In addition to the name of the data item, the following information is given for each item:

When collected:	When data item is recorded
Field width:	X digits
Tolerance:	Range of measurement that is acceptable
Values:	Legal values for coded variables

Background information about past inventories in California, Oregon, Washington, Region 6 National Forests, and Region 5 National Forests are located in Appendix 1. Additional reference information is also located in the appendices. A glossary is provided for quick reference.

### 1.2 THE INVENTORY

The national CORE FIA program consists of three phases. Phase one is a remote sensing phase aimed at classifying the land into forest and non-forest and taking spatial measurements such as fragmentation, urbanization, and distance variables. Phase 2 (P2) consists of a set of field sample locations distributed across the landscape with approximately one sample location (FIA plot) for every 6,000 acres. Forested sample locations are visited by field crews who collect a variety of forest ecosystem data. Non-forest locations are also visited as necessary to quantify rates of land use change. This field manual describes the P2 process. Phase 3 (P3) consists of a subset of the phase two plots (approximately 1 every 96,000 acres) which are visited during the growing season in order to collect an extended suite of ecological data including full vegetation inventory, tree and crown condition, soil data, lichen diversity, coarse woody material, and ozone damage. Under the annual approach, data will be collected on a subset of plots in all states every year. This is a departure from the historical FIA approach of sampling states sequentially in a cycle (periodic inventory).

### 1.3 PRODUCTS

Forest Inventory and Analysis (FIA) collects, analyzes, and reports information on the status and trends of America's forests. PNW-FIA provides information needed by resource planners, policy analysts, and others involved in forest resource decision-making. Data collected in PNW-FIA inventories are summarized, interpreted, analyzed, and published in statistical and analytical reports of national, state, regional, and subregional scope. PNW-FIA publishes information on area by forestland and owner classes and by degree of urbanization; land use change; timber volume, growth, mortality, and removals; potential forest productivity; opportunities for silvicultural

treatment; and kind and area of wildlife habitats. PNW-FIA also provides data to answer questions about forest resources.

The data collected in these inventories represent a wealth of information for both applied and basic questions concerning forest ecosystems. Topics include: the distribution of plant species and their relationship to the environment, the incidence of insects and disease in relation to forest type and condition, changes in forest structure and productivity due to disturbance, and improved prediction of forest growth and development on different sites and in response to management.

## 1.4 UNITS OF MEASURE

The PNW-FIA program uses ENGLISH units as the measurement system. Previous inventories used metric units. See Appendix 5.4 for commonly used conversion factors.

## 1.5 PLOT DESIGN GENERAL DESCRIPTION

The CORE field plot consists of four subplots approximately 1/24 acre in size with a radius of 24.0 feet. The center subplot is subplot 1. Subplots 2, 3, and 4 are located 120.0 feet horizontal at azimuths of 360, 120, and 240 degrees, respectively, from the center of subplot 1 (See Figure 1-1). In this field guide the word "plot" refers to the entire set of four subplots. "Plot center" is defined as the center of subplot 1.

Each subplot contains a microplot of approximately 1/300 acre in size with a radius of 6.8 feet. The center of the microplot is offset 90 degrees and 12.0 feet horizontal from each subplot center. Microplot numbers correspond to the number of their subplot.

In the PNW-FIA annual inventory the 4 subplots are laid out in the pattern shown in Figure 1-1. Subplots are never "substituted" or "moved" in order to keep the entire subplot within a homogeneous condition. This annual inventory plot layout is different than previous periodic inventory plot layouts. These previous layouts are described in Appendix 2.

### Plot Dimensions:

Macroplot - for sample intensification or sampling relatively rare events.

Radius = 58.9 feet  
Area = 10,899 square feet or 0.25 acre (ac) or 1/4 acre

Subplot - for tallying trees with diameter at breast height or diameter at root collar  $\geq$  5.0 inch (in)

Radius = 24.0 feet  
Area = 1,809.56 square feet or approximately 0.04 acre or approximately 1/24 acre

Microplot - for counting tree seedlings and tallying tree saplings

Radius = 6.8 feet  
Area = 145.27 square feet or approximately 0.003 acre or approximately 1/300 acre

Annular plot - outer ring of the macroplot. Adds area to the subplot for sampling relatively rare events.

Radius = from 24.0 feet to 58.9 feet  
Area = 9088.4 square feet or approximately 0.21 acre or 5/24 acre

Hectare plot - for tallying additional very large trees (Measured only on R6: all NFS lands in Oregon and Washington, R5: National Forests and certain BLM lands within the Northwest Forest Plan area-See Appendix 1)

Radius = 185.1 feet fixed-radius plot centered around subplot 1  
Area = 1 hectare (2.471 acres)

The distance between subplot centers is 120.0 feet horizontal.

The minimum area needed to qualify as an accessible forest land condition is 1.0 acre.

The minimum width to qualify as an accessible forest land condition is 120.0 feet horizontal.



**Data are collected on field plots at the following levels:**

- Plot Data that describe the entire cluster of four subplots.
- Subplot Data that describe a single subplot of a cluster.
- Condition Class A discrete combination of landscape attributes that describe the environment on all or part of the plot. These attributes include CONDITION CLASS STATUS, RESERVED STATUS, OWNER GROUP, FOREST TYPE, STAND SIZE CLASS, REGENERATION STATUS, and TREE DENSITY (See Chapter 4).
- Boundary An approximate description of the demarcation line between two condition classes that occur on a single subplot, microplot, or macroplot. There is no boundary recorded when the demarcation occurs beyond the fixed radius plots.
- Tree Data describing saplings with a diameter at breast height or root collar 1.0 inch through 4.9 inches, and trees with diameter greater than or equal to 5.0 inches at breast height or root collar.
- Seedling Data describing trees with a diameter less than 1.0 inch and greater than or equal to 0.5 feet in length (conifers) or greater than or equal to 1.0 foot in length (hardwoods).

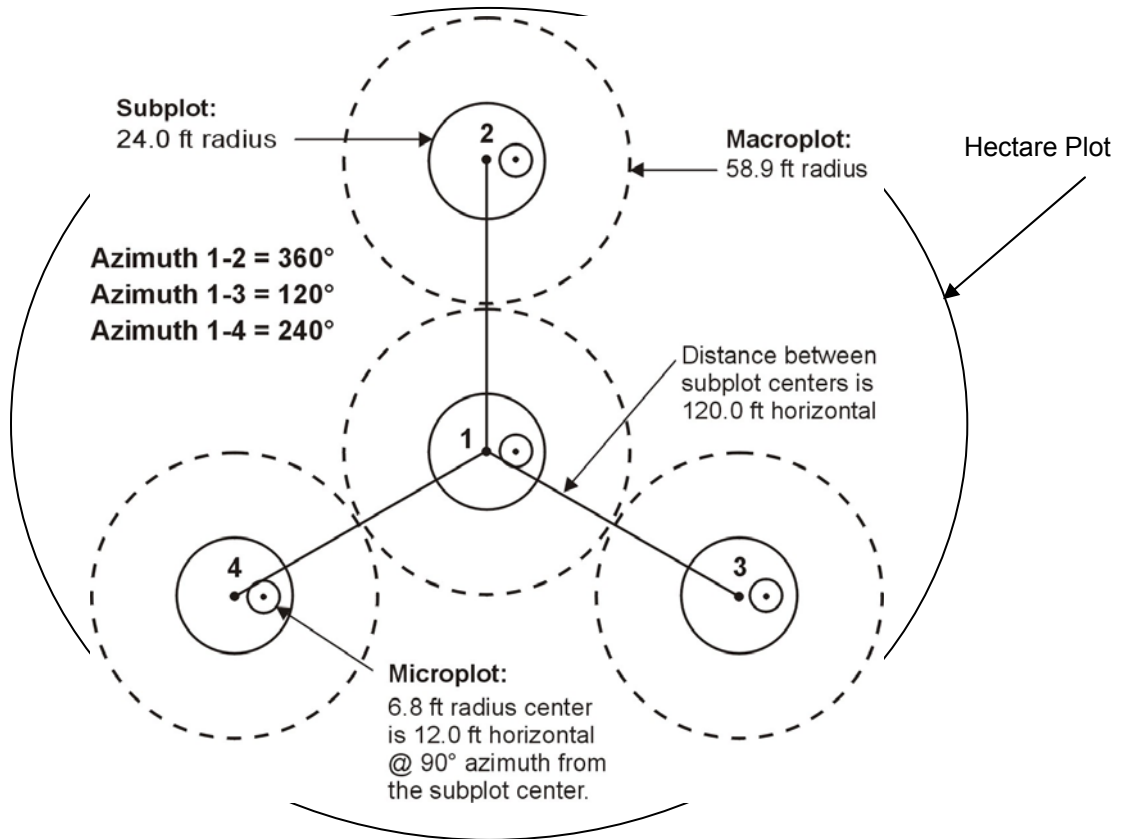

Figure 1-1: Standard 4-subplot plot diagram

## 1.6 SAFETY

Personnel working in the field are subject to many safety hazards. Each person must always be conscious of these hazards to avoid accidents:

1. Don't take chances!
2. Eliminate horseplay and carelessness!
3. Think safety!
4. No task is more important than personal safety!
5. Always make sure that someone else knows where you plan to work each day!

### SAFETY IN THE WOODS

**Wear protective clothing:** Long-sleeved shirts, long pants, and gloves may protect you from contact with brush and rocks, poison oak, and stinging insects. Trouser legs should be loose enough to avoid binding or cramping, and should not have cuffs. Wear a hardhat at all times in the woods. During hunting seasons, wear bright red or orange clothing.

**Wear good quality boots** that provide good support and traction. For example: 8-inch high leather work boots with lug-soles (Vibram-type soles).

**Walk, don't run in the woods.** Take your time and plan your route. Avoid plunging through the brush. The best route of travel may not be the shortest. Routes across brushy, irregular terrain with rocks and down logs can be hazardous.

**Be watchful of twigs and branches, which may cause eye injury.** Be especially alert when stepping up to trees which retain their small dead twigs. Keep a sufficient distance behind the person ahead of you to avoid being slapped by branches.

**Lift knees high to clear obstacles in heavy undergrowth or slash.** Slow down and watch your step.

**When contouring a steep slope, do not lean into the hill.** This tends to loosen footing. Erect posture or slightly leaning out gives more secure footing.

**Know how to fall to avoid hard impacts.** Keep flexible with knees slightly bent. If you feel yourself slipping, pick a landing spot. Do not stick your arms out to break a fall. Roll with the fall. Try to take the impact on the side of your body rather than your back.

**Don't take chances by walking across ravines on small logs.**

**Bee aware.** Keep an eye out for yellow jacket and hornet activity. Yellow jackets nest in the ground, often in well-decayed logs or in thick moss on trees or in snag cavities. Yellow jackets are particularly active (nasty) during late summer and early fall when forest conditions are very dry. Hornets nest above ground in "paper" nests that are suspended from branches; woe befalls those who unwittingly bump their head against a nest, or shake the sapling from which a nest is suspended. If allergic to insect stings, carry medication to counteract the effects of stings.

**Be alert to rattling or buzzing noises.** Look before putting hands or feet on or under rocks and logs. Be alert when walking in snake-infested areas.

**Avoid poison oak** if possible. Place oil on exposed skin before going to field. After contact with poison oak, remove clothes carefully, wash exposed areas with cool, soapy water, and wash clothes before wearing them again. Each crew person should bring an extra change of clothing to change into after leaving the plot and/or place a sheet over the seats in the vehicle.

**Keep someone posted as to where you plan to work each day,** particularly on long hikes into the forest, so that if you do not return in a reasonable time, someone can find you.

**Keep hatchets in their sheath** except when actually using them, and snap the sheath shut.

**First Aid.** Keep your individual first-aid kit completely supplied, and know how to use it. Treat all wounds promptly. Each vehicle is supplied with a large first-aid kit – keep it stocked.

**Carry matches and possibly a small flashlight.** On very long hikes, take extra food, clothing, and matches in case you are caught out in the woods at night. Never build fires in forest duff or leave a campfire until it is dead out.

**Check for ticks.** Prompt, proper removal reduces chance of Lyme disease transmission.

**Carry plenty of water.** Don't expect your partner to carry water for you.

**Beware of lightning.** Watch for approaching storms. Avoid prominent high exposed ground and tall/lone trees. Abandon field gear, especially that made of metal. Seek shelter in the vehicle if possible, otherwise in thick timber, large caves or in valley bottoms. Crouch on the balls of your feet with your head covered. Separate 100 feet from other crew members.

## **SAFETY ON THE ROAD**

It all pays the same, so drive with care, with courtesy, regardless of others' actions, and with common sense. Follow these tips:

**Seat belt use is required** in all government-owned or leased vehicles and is required by law in the States of Washington, Oregon and California. Do not ride in the back of pickups.

**DRIVE DEFENSIVELY!** Expect the other person, whether a vehicle operator or a pedestrian, to do the worst thing and be prepared. Observe all speed regulations and traffic signs.

**Do not drive when sleepy, taking medication, or when other personal conditions make it unsafe to drive a vehicle.** Get someone else to drive or, if alone, stop driving and nap (out of the public view).

**Always drive with your headlights on.** This practice increases the visibility of your vehicle. It is particularly important when driving in fog, on dusty roads, traveling in and out of shadows, and any other low light/visibility situations. Turn lights off when you park the vehicle.

**Do not operate a vehicle in an unsafe condition.** Check your vehicle frequently to keep it in good mechanical condition. Lights, horn, steering, and brakes should be kept in proper adjustment at all times. Make necessary repairs as soon as unsafe condition develops. Report any unsafe conditions to your supervisor.

**Keep the vehicle clean.** Windows, mirrors, and lights should be kept clean and free of obstructions to increase visibility. Keep the cab and driver area clean so material is not rolling under pedals or distracting the driver.

**Shift to a lower gear at the beginning of a grade, if the grade is a long, steep descent.**

**Adjust vehicle speed to the driving conditions.** Wet, icy, or snowy roads and decreased visibility require decreased speed. Be aware of speed when changing from one type of road to another, i.e., Freeway to secondary highway to gravel and adjust speed accordingly.

**Don't tailgate.** Allow at least three seconds of travel distance between yourself and the vehicle ahead. Under slippery road conditions and poor visibility, allow more distance.

**Be aware of your vehicle's idiosyncrasies and adjust your driving accordingly.**

**Be alert for heavily loaded trucks moving at high speeds when driving on privately-owned log-haul roads.**

Observe all traffic control signs, particularly signs requiring you to drive on the left side of the road.

**Back up safely.** Walk around your vehicle to check for hazards before backing and use a spotter to guide you.

**Do not drive and navigate at the same time.** If the driver needs to look at maps and photos, stop at a safe place, then look at them.

**Watch for animals on the road.** Most hooved animals travel in groups, so where there is one, assume there are many, with all just itching to jump out in front of your vehicle. Stop and let the animal move off the road, look for others to follow, then proceed on. If you cannot stop in time to avoid hitting an animal, it is generally better to hit it, than to go off the road or hit another vehicle.

**Park the vehicle so that it is not a hazard to other drivers.** Do not park where dry grass or other potential fuels can come in contact with your vehicle's hot exhaust system.

**Keep as far right as is safely possible on blind curves on logging roads.** If the curve is blind and less than two lanes wide, slow way down and be ready to take evasive action.

**Yield to uphill vehicles on roads wide enough only for one vehicle.**

## **WHAT TO DO IF INJURED**

**Treat the injury promptly.** If immediate medical attention is required, go directly to a hospital emergency room.

Try to make contact with your supervisor or the office to get instructions and assistance. Make sure the doctor fills out his/her part on the CA-1 form.

**Inform your supervisor of all injuries** and ask which, if any, forms need to be filled out. Supervisors must inform the office at the earliest opportunity.

**Fill out Federal accident forms completely with signatures.** ALWAYS make a copy for your personal records.

Give the completed forms to your supervisor. Have the supervisor check your entries for mistakes, fill out their section, and forward the completed forms to the appropriate person.

**Gather Information.** If you are in a multi-vehicle accident, provide the other parties with enough written information so that they can easily get in touch with you, your crew supervisor, and the office. In turn, you must get the following information from all involved parties and witnesses -- names, addresses, phone numbers, vehicle license numbers, driver's license numbers, insurance company names and policy numbers, and police report numbers. If possible, do not admit responsibility without first contacting your supervisor.

## 1.7 QA/QC

The goal of the FIA Quality Assurance/Quality Control (QA/QC) program is to ensure that all resource inventory data are scientifically sound, of known quality, and are thoroughly documented. Measurement quality objectives (MQO) are established as standards to define data quality.

The PNW QA staff works to continually improve the FIA inventory process by controlling, identifying, and documenting errors and sources of variability that could be detrimental to the quality of FIA inventory results. Emphasis is placed on extensive crew training, field inspections, and documentation of protocols and procedures used in the inventory.

The QA staff conducts periodic on-site inspections of field locations to ensure that the field work is being performed with the required accuracy and precision. Specifically, objectives of field checking are:

- To obtain uniform and consistent interpretation and application of field instructions among all field crews.
- To minimize technique errors.
- To check the performance of each individual crew member
- To reveal inadequacies in the instructions and in the training program.
- To assess and document the quality (accuracy, precision, completeness) of field data.

Field inspections are conducted using three methods:

**Hot Check:** an informal inspection in which the QA measures behind the production crew and provides instant feedback regarding data quality. The primary objective of a hot check is ongoing hands-on training. Through this process the QA can identify and correct improper measurement techniques, answer questions, share tricks, and clarify interpretation of the field manual.

**Cold Check:** an inspection done on production plots, either as part of the training process, or as part of the ongoing QC program. The production crew is normally not present and has no knowledge beforehand that a plot is slated for inspection. A cold check serves as a means to identify discrepancies and guide the ongoing training of the field crews. Through this process the quality of data produced by production crews can be documented. This is accomplished quantitatively with the QA software that compares production crew measurements with those of the QA and provides a score. This score may also serve to guide how contractors are paid.

**Blind Check:** a second crew revisits a plot during the same season and takes a second set of measurements, but they do not have data from the initial visit of that year. Unlike hot and cold checks, blind plots are not check plots, and they are not used to evaluate an individual or crew's work. Blind plots provide an estimate of measurement variation. This procedure provides a quality assessment and evaluation function. (See Appendix 13.2 for blind plot instructions).

## 2 LOCATE AND LAY OUT STANDARD PLOTS

### Table of Contents

<b>2</b>	<b>LOCATE AND LAY OUT STANDARD PLOTS .....</b>	<b>9</b>
<b>2.1</b>	<b>PRELIMINARY PREPARATION .....</b>	<b>11</b>
	LANDOWNER CONTACT .....	11
	BEFORE LEAVING FOR THE FIELD .....	11
<b>2.2</b>	<b>NAVIGATING TO THE PLOT .....</b>	<b>12</b>
	LOCATING AN ESTABLISHED PLOT .....	12
	LOCATING A PLOT WITH A REFERENCE POINT AND BASELINE .....	13
	REPLACEMENT PLOT (LOST PLOT).....	13
	LOCATING NEW PLOTS.....	13
	PLOTS WITH ACTIVE LOGGING .....	14
	SITUATIONS THAT PREVENT VISITING PLOTS .....	14
<b>2.3</b>	<b>PLOT/SUBPLOT LAYOUT AND REFERENCING .....</b>	<b>14</b>
	THE REFERENCE POINT (RP).....	14
	THE WITNESS TREE.....	15
<b>2.4</b>	<b>ESTABLISHING AND MONUMENTING NEW PLOTS .....</b>	<b>16</b>
	REFERENCE AND MONUMENT THE PLOT CENTER .....	17
	LOCATE, REFERENCE, AND MONUMENT THE OTHER SUBPLOTS.....	17
	LOCATE AND MONUMENT THE MICROPLOT .....	17
<b>2.5</b>	<b>REFERENCING AND MONUMENTING PREVIOUSLY ESTABLISHED PLOTS .....</b>	<b>17</b>
	REPLACEMENT PLOTS.....	18
<b>2.6</b>	<b>OTHER FIELD PLOTS ESTABLISHED USING THE 4-SUBPLOT DESIGN .....</b>	<b>18</b>
<b>2.7</b>	<b>REFERENCING AND MONUMENTING ENTIRELY NON-FOREST PLOTS .....</b>	<b>19</b>
	PLOTS LOCATED ON NATIONAL FOREST OWNERSHIP .....	19
	PLOTS LOCATED ON ALL OTHER OWNERSHIPS .....	19



## Chapter 2: LOCATING AND LAYING OUT STANDARD PLOTS

This chapter describes how to locate and establish new sample plots and locate and remeasure established sample plots.

### 2.1 PRELIMINARY PREPARATION

Several tasks must be completed prior to establishing and/or measuring an FIA plot. These include: 1) contacting the landowner and securing permission, 2) preparing documentation, equipment, and personal gear to go to the field, and 3) taking the necessary safety precautions.

#### LANDOWNER CONTACT

Written or verbal landowner permission must be obtained before a plot is visited. This responsibility lies with the State Coordinator who may delegate contacting the landowner to the field crew.

In preparing for the field season, PNW-FIA sends each non-industrial private landowner with a plot on their land a letter and a postcard that requests permission to visit and measure the plot (Appendix 12). If the owner returns the postcard prior to the field season, it is placed in the plot jacket. Owners of large land areas--primarily private timber companies and public agencies--are contacted individually; access information for these plots will be provided by the State Coordinator or will be included in the plot jacket.

#### Recording conversations with landowners

Include a record of each conversation with a plot landowner on the Ownership Contact form. While not a part of the official plot record, this information will document that permission was obtained, assist in accessing the area for check-plots, and possibly aid the field crew during a future inventory.

Ask landowners if they can confirm the dates of any disturbance or treatments (usually harvesting) on the plot since the previous visit; record this date on the Condition Class Attribute Record. Record any special circumstances about plot accessibility--such as locked gates or washed-out roads under "Access Description to the RP" on the Plot Card.

#### Data requests

Plot specific data are released only to the legal owner of the plot area. Requests for photocopies of the field data sheets, summarized plot data, or copies of future publications based on information collected in this inventory should be noted in "Landowner Plot Summary Request" (Section 3.4.15) and make comments on the plot jacket owner address label. Copies of the plotcard CANNOT be given to landowners because it can reveal confidential plot location information (See Appendix 12.2). Current plot data will generally be sent to the owner after the field season is completed and plots are returned to the office. At the landowner's request, the crew may provide photocopies of plot data immediately after collection. Any additional data requests should be referred to the client request person in the Portland office:

Karen Waddell		
Portland Forestry Sciences Lab	phone:	(503) 808-2046
P.O. Box 3890	email:	kwaddell@fs.fed.us
Portland, OR 97208		

#### BEFORE LEAVING FOR THE FIELD

- Make sure the landowner has been contacted (see above).
- Plan the route to the plot. Always bring two or more extra plots.
- Leave word of plot locations and expected destinations with the crew coordinator using the contracted answering service (877-295-4271).
- Make sure your vehicle has all of the necessary field gear and plot maps.
- Account for all electronics (data recorder, GPS, laser, cell phone, satellite phone); be sure that the data recorder is charged and pack extra batteries.
- Be in agreement with your crew partner(s) on a work procedure.
- Inspect vehicle for fuel, oil, lights, safety features, and plot supplies (stakes, tags, pins, and nails) prior to departure.

## 2.2 NAVIGATING TO THE PLOT

The first task is to find the ground location of the plot center (PC) delineated on the photos using resources such as maps, ortho photos, aerial photos, and a GPS unit. Each field crew should have a road map with the location of the plots marked and identified with the plot number, and a plot jacket for each plot that you may visit. The county, plot number, and legal description (township, range, section, and forty) are printed on the ownership label on the Plot Jacket. Use the road map to reach the general vicinity of the plot by vehicle. GPS units may be used as aids to reach plot vicinity, but photos should be used to establish a new plot center and confirm location (See Appendix 6 for instructions on using the GPS unit for navigation). All plots will be located on the ground from a reference point (RP) so that the location can be found during future remeasurement. At some locations, the PC can also be located on the ground visually without measuring from an RP.

### LOCATING AN ESTABLISHED PLOT

Established plots include: 1) Periodic Inventory plots installed with a different design (See Previous Plot Layouts in Appendices 1 and 2), 2) Field plots established by Forest Health Monitoring (P3) crews using the 4-subplot design, and 3) Annual Inventory remeasurement plots.

The plot jacket for each field plot will usually contain old and new photos, previous plot records with plot diagrams, current computer-printed Plot, Subplot, and Condition Class Attribute records, computer-printed current tree tally records, an Owner Contact Form and a plot edit sheet. The plot location is pinpricked and circled on the old photos. Use both new and old photos to proceed to the plot area when revisiting established plots. If new NAPP photos have not been pinpricked, transfer the pinprick from prior occasion photos in the field. The transferred pin prick should be accurate within +/- 1 mm. Plot jackets may also contain a USGS quad map printout showing the approximate plot location to aid in locating the plot center.

Use the road map, plot cards and aerial photos from the previous inventories to locate the plot. The plot number is marked in the upper right-hand corner on the front of the old photo. The plot number is also marked on the upper right-hand corner of the new (un-pinpricked) photos. It is often easier to use the new photos to arrive at the general location and the photos from previous inventories to find the exact location of the plot.

The RP tree has square aluminum tags on two sides at 6 feet above ground line, and one square aluminum tag below stump height facing towards the plot center. Usually travel notes, remarks, and a description of the RP trees can be found on the front of the previous plot cards and on the back of the previous photos. Before beginning the traverse from the RP to the plot, check the photos to see if the azimuth and distance seem reasonable. The species of the old RP, its DBH (to the nearest centimeter on old periodic PNW FIA plots), the azimuth from RP to the plot center monument, and the slope distance (in meters on old PNW FIA plots) from RP to the plot center were recorded on the plot card and aerial photo used at the last visit. Similar data were recorded for the nearby witnesses, to reference the plot center monument. However, the azimuth for witnesses was recorded from the plot or subplot center to the tree, and distance was recorded to the nearest centimeter on old periodic PNW FIA plots. Data downloaded to the PDR at the current inventory will be converted to English units. On some plots, the previous RP referenced a subplot center other than Subplot 1, the pinpricked location; on these plots, the plot center monument was still installed at the pinpricked location.

Some photos will be marked with a point-of-departure (POD). They are usually near a road and indicate how the crew approached the plot. It may be easier to locate an established plot by heading directly to the plot rather than to the Reference Point (RP) because the RP is a single tree with three tags, whereas within the plot area there may be numerous trees with reference tags, tree numbers and/or diameter nails; in short, more "signs" to detect. In searching out the plot, you may find a tagged/numbered tree on one of the subplots--use the plot printout from previous visits to determine which subplot you are on.

If you have difficulty finding an established plot, follow these steps:

1. Return to the last known point on your route into the plot. Plan a route to the pinpricked plot center; divide the route into stages with a physical feature at the end of each stage that you can identify on the photos and can find and confirm on the ground. Proceed stage by stage, never embarking on the next stage until you know without a doubt that you have identified the endpoint of the previous stage. The endpoint on the last stage is the pinpricked location with its witness trees, snags, stumps or objects.
2. If you tracked your way into the plot area but you do not find any signs of the plot, look for stream confluences, ridges, openings, groups of large trees, old skid roads, large snags etc. on the ground, to reconfirm without a doubt that you are at the pinpricked location.



## Annual Inventory 2007, Chapter 2: Locate and Lay Out Standard Plots

3. Still no plot? Try to locate the area where previous crews might have been when they thought they were at the pinpricked location. Check the previous plot card for information such as:
  - a) Remarks that provide insight on plot location. For example: "Point center moved back 20 feet on same azimuth to agree with photo pinprick."
  - b) Stand type and size of trees.
  - c) The size and species of the RP and subplot 1 witness trees.
  - d) Direction of travel from the RP--it could be 180 degrees off.
  - e) Other indicators such as slope and aspect.

### **LOCATING A PLOT WITH A REFERENCE POINT AND BASELINE**

You may encounter a plot that is difficult to locate using photo interpretation. In this case you can establish a baseline on the photos to determine true photo azimuth and scale. Directions for establishing and using a baseline follow:

#### A. Establish the baseline as follows:

- Identify and pinprick two objects on the aerial photo that can also be located on the ground. The points on the photo should be as close as possible to the center of the photo.
- Measure the distance between the objects on the ground to the nearest 1 foot (Horizontal Ground Distance).
  - The pinpricked objects on the ground should be at least 500 feet apart.
  - The sighting between the pinpricked objects should be straight (such as along a road).
  - The elevation of the pinpricked objects on the ground should be similar to the elevation of the plot.
- Draw a line on the backside of the aerial photo between the two pinpricked objects (the baseline).
- With a ruler measure the length of the baseline (Map Units).
- Calculate the Photo Scale Reciprocal = Ground Distance/Map Units.
- Determine the baseline azimuth with a compass by sighting between the two pinpricked objects on the ground. On the backside of the aerial photo, draw a straight line between a known object to the pinpricked plot center. Be sure to record the correct azimuth.

#### B. Determine the azimuth and the horizontal distance from a known object to the pinpricked plot center.

#### C. Measure out the calculated azimuth and horizontal distance to the pinpricked plot center.

#### D. Navigate to the pinpricked plot center. (The location will become the center of subplot 1 on the standard layout). If this is a new plot, carefully check the photos against the surrounding terrain and vegetation to make sure you are actually at the location pinpricked on the new photo.

### **REPLACEMENT PLOT (LOST PLOT)**

The following instructions apply to Annual inventory remeasurement plots (3.4.5 SAMPLE KIND = 3): If no sign of the plot can be found after an extensive search (at least a day) using all the data available, then the plot will be considered lost and the State Coordinator will be notified. Previous plot access information (Route to RP and RP Information) should correlate with the original photo pinprick. If these two plot references do not correlate to the same location, search at least a 200 foot radius around the ground location of the photo pinprick, and a 200 foot radius around the ground location of where the RP to plot traverse ended. If a major disturbance has occurred with no trees or monumentation remaining, then use photos, maps, and GPS to verify the plot location and consider it a remeasurement plot. Otherwise, once the crew leader determines that the plot is lost, a replacement plot will be installed following the guidelines in Section 2.5 for Replacement Plots. Plot locating and layout should be performed as if installing the plot for the first time.

### **LOCATING NEW PLOTS**

Annual Inventory plots installed for the first time where no Periodic P2 plot previously existed will have new aerial photos with the plot center pinpricked on them. Some plots may also have coordinates obtained by digitizing

USGS topographic maps or by some other means. Some plots may also contain a digital ortho photo printout, which can be used as an aid in plot center location. When you arrive at the point you believe to be the pinpricked location, carefully check the pinpricked location on the new photos against the surrounding terrain and pattern of tree crowns and vegetation to confirm that the pinpricked location on the photo and your location on the ground are the exact same spot. The new plot is installed accurately within +/- 10.0 feet of pin prick on a 1:12,000 or greater scale photo and within +/- 30.0 feet if the photo scale is 1:12,000 or smaller.

**PLOTS WITH ACTIVE LOGGING**

If the plot area is being actively logged (timber is being felled, bucked, or yarded) DO NOT ESTABLISH THE PLOT. Note on the plot jacket the status of the logging operation and return the plot to the State Coordinator. The State Coordinator will give the plot to a crew later in the season to be completed.

See mapping Condition class status in Section 5.5 for further instructions.

**SITUATIONS THAT PREVENT VISITING PLOTS**

When a subplot center can be physically occupied: At the current inventory for all subplots (including subplot 1 - plot center), if a subplot center can be physically occupied, then any Census water, Denied access, Hazardous, or Not in the sample areas are mapped as separate condition classes. Measurements are taken only in any accessible forest land condition classes.

If a subplot center can not be physically occupied (i.e. Census water, Denied access, or Hazardous) the subplot will not be installed or referenced. The entire subplot is classified as the subplot center condition, even though a portion of it may be in another condition class. Other subplots are installed using normal procedures. If subplot 1 cannot be occupied, use a photo template, GPS, or estimate of Azimuth and Horizontal Distance to locate the other subplots. When access to a subplot is denied by the landowner, the entire subplot is not installed; other subplots are installed and measured when they are located on different land ownership. If a crew has determined that a subplot is hazardous, the other subplots are established and measured according to standard procedures.

**2.3 PLOT/SUBPLOT LAYOUT AND REFERENCING**

In the current annual inventory the 4 subplots are laid out in the pattern shown in Figure 1-1 (with an accuracy of +/- 5 feet). Subplots are never "substituted" or "moved" in order to keep the entire subplot within a condition class.

TABLE 2-1: Azimuth and Horizontal Distance to Subplots

Subplot From	Subplot Numbers To	Azimuth degrees	Backsight	Distance feet
2	3	150	330	207.8
2	4	210	030	207.8
3	4	270	090	207.8

If a subplot was incorrectly located at the previous visit, the current crew should remeasure the subplot in its present location and contact the Data Manager, (Perry Colclasure). In cases where individual subplots are lost (cannot be relocated) the subplot will be reinstalled using the procedures in Section 5.0. Appendix 1 describes special rules about nonforest plots/condition classes on R5 (CA) and R6 (OR/WA) FS lands.

**THE REFERENCE POINT (RP)**

The RP references the Plot Center stake. It is an object (usually a tree) that is easily identified on the aerial photo and on the ground and apt to be present at the next visit. Do not reference a subplot other than the one with the plot center monument just because that subplot is closer to the RP. Reference a subplot other than N-1 only when there is a significant obstacle or other obstruction between the RP and Subplot 1, but not between the RP and the other subplot chosen.

Select an RP: The RP should be distinctive on both the ground and on the new photos. You may reuse the previous RP tree if it is suitable. If the old RP tree is dead, missing, or difficult to identify on the ground or on the aerial photo, select a new RP (but leave the tags on the old RP). If possible, it should be a tree that is not likely to die or be cut before the next inventory. You may select a snag or other object for an RP (i.e. a distinctive fence

## Annual Inventory 2007, Chapter 2: Locate and Lay Out Standard Plots

post, building corner, telephone pole, etc.). If you utilize such an RP, describe it on the plot photo and under "Access Description to RP" on the Plot Card. Record code 999 if the RP is something other than a tree.

Tag the RP: Mark the RP tree with new or reused tags. Nail aluminum square tags on two or more sides of the RP tree, 6 feet above ground line, facing directions you expect future crews to approach the RP. Also nail an aluminum square tag on the RP tree below stump height, on the side of the tree facing the plot center monument. When attaching a tag, drive the nail into the tree only enough to anchor the nail firmly into the wood; and always leave at least 2 inches of nail exposed. If the RP is a building, rock, or other item that can/should not be tagged, make a note in the "Access Description to RP" that it is not tagged.

Pinprick the RP location: Pinprick the ground location of the RP on the new photos UNLESS the RP pinprick would obscure another pinprick. Circle the RP pinprick on the back of the photo, write "RP" near the circle (but do not obscure any pinpricks) and provide RP data.

Record RP data: Record the species of the RP, its DBH/DRC to the nearest inch, azimuth FROM RP to cedar or plastic stake, and SLOPE DISTANCE measured to the nearest foot from the square tag at the base of the RP to the cedar or plastic stake. Record this on the back of the aerial photo, under "Access Description to RP" on the Plot Card, and in the Plot Attributes section of the plot data.

Access Description to RP: Record a clear, concise and legible narrative for the travel route to the RP. Provide information that will aid the next crew in relocating the plot. Begin at a permanent starting point. The term "starting point" is somewhat ambiguous. Normally the starting point is an arterial or secondary road junction. In some cases (wilderness access) the starting point may be a trailhead, or the end of a local road. Whatever starting point is selected, it should be easily identifiable on the map, aerial photo (if there is photo coverage of the starting point), and on the ground.

The narrative for the Route to RP identifies the mode of travel (driving, hiking, etc.), route traveled (include road and/or trail designation number), direction of travel (use cardinal directions), and the distance traveled on each segment. When foot travel becomes the predominant means of accessing the RP and/or when the travel route is long or complex, install a Point of Reference (POR). A POR is a tree or object. Monument each point of reference using the same methods as monumenting an RP. When a point of reference is identified on the aerial photo, pinprick the base of the object and label it POR (on the photo back). Record the POR information under "Access Description to RP" on the front of the plot card. Include the POR species and DBH and direction to the RP.

Describe prominent features present in the plot area that are unlikely to change in the next ten years. Examples include details such as slope, aspect, topographic position, recognizable physiographic features (i.e. streams, rock outcrops, benches), man-made features, and unusual or large trees. If any new roads have been built in the plot area since the date of the new field photos, sketch them in "Plot Diagram" and/or "Access to the Plot" on the Plot Card if it will help the next crew to find the plot.

Example: "The RP is a large Douglas-fir (over 120 feet tall) in a draw that descends northeast from mainline logging road 1000. Subplot N1 is down slope from the RP and is just down slope and next to a large rock outcrop."

### **THE WITNESS TREE**

A. Monumenting a witness tree: Witness trees reference each of the four subplot centers stakes or metal pins. To reference the cedar stake or a metal pin with nearby (witness) trees, snags, stumps or objects **do the following steps:**

Select two trees near the plot/subplot center monument that form, as closely as possible, a right angle with the stake or metal pin. Trees within 6 feet of the stake are preferable. If live trees are not available, use stumps or sound snags. On subplots established previously, reuse the previous witness trees, or if there are better trees available, use new witness trees. If you select a new witness tree, remove the square or round tags (if present) from the witness tree it is replacing to avoid confusing the next crew. Renew old witness tags as needed. When attaching a tag to a witness tree, drive the nail into the tree only enough to anchor the nail firmly into the wood;

Annual Inventory 2007, Chapter 2: Locate and Lay Out Standard Plots

always leaving at least 2 inches of nail exposed. The following table describes how to monument witnesses at Plot Center and at the centers of the other subplots.

At Plot Center (Subplot 1)	At Subplots (2 – 4)
<p><u>Nail a square aluminum tag well below stump height</u> (&lt; 0.5 foot above the ground) on each witness tree on the side facing the subplot center. If the trees are also numbered tally trees, attach the tree number tags with the same nails.</p> <p>In two locations on each witness tree, nail a square aluminum tag 6 feet high facing likely approaches to the subplot.</p>	<p><u>If the witness is a tally tree:</u> If the witness is a trackable (tally) tree that does not require a numbered tag (e.g. Dead), attach an aluminum yellow round tag below stump height facing subplot center.</p> <p><u>If a witness is not a tally tree:</u> Nail an aluminum yellow round tag 6 feet above ground line facing the direction you expect future crews to approach the subplot, and nail one aluminum yellow round tag below stump height facing the subplot center. If the witness is a live tree with a diameter 3.0 inches DBH/DRC or larger, attach an aluminum nail at DBH.</p> <p><u>If the witness is a stump:</u> If the witness is a stump &lt; 4.5 ft tall, attach an additional aluminum round tag, yellow side up, on top and in the center of the stump. Bend half of the aluminum round to a 90 degree angle so that the yellow portion faces subplot center N-1. Record "stump" in the tree comment and note the height of the stump. When nailing tags to stumps, pound the nail in flush to the bole. Tags nailed to stumps stay attached longer if the bark is removed prior to nailing the tag in.</p> <p><u>If the witness is a shrub:</u> nail an aluminum round tag to the base of the shrub facing subplot center. If possible, nail an additional round higher up which faces the direction you expect future crews to approach the subplot.</p> <p><u>If the witness is another object:</u> monument and tag as appropriate and record comments in the TREE NOTES.</p>

B. Recording witness data (all subplots on the standard layout): Azimuth (subplot center to tree), slope distance to the head of the nail affixing the basal tag or tree number tag, species, and diameter are recorded for each witness tree, snag, or stump. NOTE: Distance to witness is always SLOPE DISTANCE from the subplot center to the head of the nail affixing the basal aluminum tag or tree number tag. This is a different measurement than the horizontal distance to the center of the tree collected for all tally trees. See Section 7.4.5.

If the witness is a tally tree, snag or stump (a trackable tree record), enter a "w" after its TREE STATUS by pressing a "w" on the PDR; the PDR will then insert an asterisk after the tree status to indicate the tally is a witness. In addition to the standard data items, the PDR will require that slope distance be recorded.

If the witness tree or stump is not a tally tree or stump: enter a new record for the tree or stump; assign the record a TREE STATUS of 8, and record species, azimuth, slope distance to the head of the nail at basal tag (or to the front of a non-tagged object), and diameter (diameter for a stump is the average of two width measurements across the top of the stump).

If the witness is a shrub or another object: enter a new "tree" record for the shrub or object, assign a TREE STATUS of 9, and record azimuth and SLOPE DISTANCE from the subplot center to the head of the nail affixing the basal aluminum tag or appropriate monumentation. Record 999 as the species code and record the shrub species name under TREE NOTES.

## 2.4 ESTABLISHING AND MONUMENTING NEW PLOTS

Establishing the location is the crucial first step in collecting valid field data. While measurements at each location are used to collect statistical information for the entire inventory unit, each location is also compared to satellite information for the same point. Because these sampling layers must measure attributes on the same location, it is critical that the ground sample be located as accurately as possible.

The pinprick on the photo is always the first choice in determining plot center location. If the pinprick differs from the location shown on the USGS quad printout or the coordinates, assume that the photo pinprick is the correct field grid location and install the plot at this location. If the pinprick on the photo and the location marked on the USGS quad printout differ substantially (i.e. more than several hundred feet) contact Perry Colclasure (Data Coordinator) to determine reason for the discrepancy (phone # in Appendix 16).

### **REFERENCE AND MONUMENT THE PLOT CENTER**

Establish the plot location on the ground corresponding to the pinprick on the photo as described above.

A. Install a cedar stake at this location on the ground.

Exception: If the 58.9-foot fixed-radius plot at subplot 1 on the standard layout is **entirely non-forest land**  
**AND:**

- 1) the center of subplot 1 is too hazardous to visit (e.g. subplot center 1 is in the middle of a pond, or the middle of a freeway, or on the side of a cliff) **OR**
- 2) placing the plot center monument at the center of subplot 1 is very apt to irritate a landowner (e.g. subplot center 1 is in the middle of someone's front lawn), the plot center monument **is not placed at the field grid location.**

**THEN** reference the center of the lowest-numbered subplot on the standard layout that has a forestland condition class present within its 58.9-foot fixed-radius plot. Specifically, do the following steps:

- a) Place a cedar stake at the center of this subplot
- b) Reference the new stake to two nearby trees, snags, stumps or objects.
- c) Reference the new stake to an RP; see "THE REFERENCE POINT (RP)" on Page 14.
- d) If a revisited plot, determine and pinprick the location of the plot center on the new photos using photo interpretation. On all plots: use a red sharpie pen to circle the pinprick on the back of the photo and write "PC" (plot center) and the plot number near the circle.
- e) Determine and pinprick the ground location of the RP on the new photos using photo interpretation. Circle the pinprick with a red sharpie pen on the back of the photo, write "RP to subplot and required RP data (insert a number, such as N-1, N-4) near the circle (e.g. "RP to subplot N-3)". Keep in mind that the pinpricked location in this case, is not at the location of the plot center monument. The plot center is always the center of subplot 1 on the standard layout regardless of whether it is referenced or not.

B. Use a small aluminum nail to attach a round tag (yellow-side up) to the top of the cedar stake.

C. Reference the new stake to two nearby witnesses (See "THE WITNESS TREES" on Page 15).

D. Reference the new stake to an RP. (See "THE REFERENCE POINT (RP)" on Page 14).

E. Circle the pinprick with a red sharpie pen on the back of the photo and write "PC" (plot center).

F. Determine and pinprick the ground location of the RP on the new photos using photo interpretation. Circle the pinprick with a red sharpie pen on the back of the photo and write "RP" near the circle.

### **LOCATE, REFERENCE, AND MONUMENT THE OTHER SUBPLOTS**

One subplot on the standard layout, usually subplot 1, is referenced adequately by the cedar stake and its nearby witnesses and RP. Other subplots on the standard layout that have forest land present somewhere on their 58.9-foot fixed-radius subplot also require referencing. Do the following steps:

- A. Mark the subplot center with a metal pin and yellow round, and tie a small piece of flagging to the pin under the aluminum round.
- B. Reference the metal pin to two nearby witnesses (See "THE WITNESS TREES" on Page 15).

### **LOCATE AND MONUMENT THE MICROPLOT**

The center of each 6.8-foot microplot is located 12 feet from each subplot center at 90 degrees. Mark each microplot with a metal pin and aluminum round (white face up) at microplot center, and tie a small piece of flagging to the pin under the aluminum round. The microplot will be accurately located within +/- 0.1 foot.

Subplot numbering: Install the four subplots in the configuration described in Section 1.4. The subplots are labeled N# (N1, N2, N3, and N4) subplots. Other first digit codes (C or #) may be valid for other inventories.

## **2.5 REFERENCING AND MONUMENTING PREVIOUSLY ESTABLISHED PLOTS**

Find the location of the plot pinpricked on field photos at last visit. This previously pinpricked location is the field grid location for the plot. It was monumented at last visit with a cedar or plastic stake in the ground, and was

## Annual Inventory 2007, Chapter 2: Locate and Lay Out Standard Plots

referenced by an RP and two nearby witnesses. Both the RP and witnesses were marked distinctively with square and round tags. If the previous plot is found (regardless of any error in its position) the plot will be remeasured in the place it was previously installed. Notes are required when previously mislocated plots are encountered.

- Once the field grid coordinates are located on the ground (old plot center monument), do the following steps:
  - A. Install a new cedar or plastic stake at the plot center and remove the old stake. Check to see that the "exception" on Page 17 does not apply.
  - B. Reference the new stake to two nearby witness trees, snags, stumps or objects (See "THE WITNESS TREES" on Page 15).
  - C. Reference the new stake to an RP. (See "THE REFERENCE POINT" on Page 14).
  - D. Determine and pinprick the location of the plot center on the new photos using photo interpretation. Circle the pinprick on the back of the photo and write "PC" (plot center).
  - E. Determine and pinprick the ground location of the RP on the new photos using photo interpretation. Circle the pinprick on the back of the photo, write "RP" near the circle, and the RP data required.

### **REPLACEMENT PLOTS**

If a previously established Annual Inventory (4-subplot design) plot cannot be found, the plot will be considered "lost" and a replacement plot will be installed. In this case plot locating and layout should be performed as if installing the plot for the first time. The PLOT NUMBER for the new (replacement) plot will be assigned by NIMS.

Conduct an extensive search as described above. A thorough search may take several hours to a full day. If a plot can not be relocated because a major disturbance has destroyed the trees and no monumentation can be found, the following guidelines apply:

- Where no trees exist: use photos, maps, GPS to verify plot location and treat plot as re-measurement.
- Where trees exist and there is no evidence of disturbance: install replacement plot.
- Where trees exist and there is evidence of disturbance: efforts to locate plot must be documented and the State Coordinator must be notified. For the lost plot, an explicit description of the percent mortality and cause of death of trees must be recorded in plot notes. This plot will be reviewed by analysts at the end of the season. Install replacement plot.

In the event that some monumentation is present, but not all trees are found, the plot should be re-established and remeasurement protocol followed.

Once the crew leader determines that the plot is lost, then the plot will be closed out and a replacement plot will be installed. New plot locating and layout should be performed as if installing the plot for the first time. Enter the following codes for the plot variables shown below for lost plots and their new replacement plots (See Section 3.4).

	PLOT STATUS	SAMPLE KIND	QA STATUS	File Name ending
Lost (replaced) plot	3	2	8	"L"
New (replacement) plot	1	3	1	"P"

### **2.6 OTHER FIELD PLOTS ESTABLISHED USING THE 4-SUBPLOT DESIGN**

Forest Health Monitoring (FHM) plots (P3 plots) and Eastern Oregon juniper plots were established using the 4-subplot design and have current detailed information on finding the plot, including GPS coordinates downloaded/printed in the Plot Attribute record. In some cases previous Periodic Inventory plots and FHM plots were to have been co-located (almost always in Washington and Oregon, but less frequently in California), but mistakenly established at different ground locations (PCs). Past Annual Inventory (P2) design plot center and subplots have been installed at either the Periodic Inventory PC or the previously installed 4-subplot design PC, depending on how far apart these plots are located on the ground. Current rules for remeasurement or initial installation of Annual Inventory plots where previous plots have been installed follow:

- Remeasurement of a previously established Annual Inventory (P2) plot: If the previous P2 plot is found, always remeasure Subplots 1-4 at the location they were installed.
- New P2 Annual Inventory installation located on National Forest ownership at co-located Periodic and FHM (or Eastern Oregon Juniper) plots established at different ground locations: Install the new Annual Inventory (P2) plot at the previous Periodic Inventory PC. Note: The existing P3 plot will be treated as a "lost" plot and re-established with the new Annual P2 plot at the old Periodic PC.

- New P2 Annual Inventory installation located on all other ownerships at co-located Periodic and FHM (or Eastern Oregon Juniper) plots established at different ground locations: Install the new Annual Inventory (P2) plot at the existing P3 plot location. Mortality will be measured at the nearby Periodic plot when specified (See Section 7.13).

## **2.7 REFERENCING AND MONUMENTING ENTIRELY NON-FOREST PLOTS**

### **PLOTS LOCATED ON NATIONAL FOREST OWNERSHIP**

Plots that are entirely non-forest and are field visited need to be referenced. Follow the steps in Section 2.4. See Appendix 1 for special rules about National Forest plots/Condition Classes on R5 and R6 NFS lands.

### **PLOTS LOCATED ON ALL OTHER OWNERSHIPS**

Plots that are entirely non-forest and are field visited need to be referenced when stocking subplots are established. Follow the steps in Section 2.4 for Subplot 1. The other 3 subplots do not need to be referenced if the entire plot is non-forest.





## 3 PLOT DATA

### TABLE OF CONTENTS

<b>3</b>	<b>PLOT DATA .....</b>	<b>21</b>
<b>3.1</b>	<b>Time Spent Plot.....</b>	<b>23</b>
3.1.1	Travel Time to Plot (PNW) .....	23
3.1.2	Measurement Time on Plot (PNW).....	23
3.1.3	Travel Time from Plot (PNW).....	23
<b>3.2</b>	<b>REFERENCE POINT (RP) ATTRIBUTES .....</b>	<b>24</b>
3.2.1	RP Species (PNW).....	24
3.2.2	RP Diameter (PNW).....	24
3.2.3	RP Azimuth (PNW).....	24
3.2.4	RP Distance (PNW).....	24
3.2.5	RP Az/Dist to Subplot # (PNW).....	24
<b>3.3</b>	<b>PLOT ATTRIBUTES DOWNLOADED TO THE PDR.....</b>	<b>25</b>
3.3.1	STATE (CORE 1.1).....	25
3.3.2	COUNTY (CORE 1.2).....	25
3.3.3	PLOT NUMBER (CORE 1.3).....	25
3.3.4	Old PNW-FIA Plot Number (PNW) .....	25
3.3.5	CORE FIELD GUIDE VERSION # (CORE 1.9).....	25
3.3.6	PNW Data Recorder Program Version # (PNW) .....	25
3.3.7	DECLINATION (CORE OPTIONAL 1.11).....	26
3.3.8	Elevation (PNW) .....	26
3.3.9	Precipitation (PNW).....	26
3.3.10	Hydrologic Unit Code (PNW).....	26
3.3.11	MACROPLOT BREAKPOINT DIAMETER (CORE OPTIONAL 1.17).....	26
3.3.12	Hectare Plot? (PNW).....	26
3.3.13	Date of Previous Inventory (PNW).....	26
3.3.14	Remeasurement Period (PNW).....	26
3.3.15	Previous Ground Land Class (PNW).....	27
3.3.16	Ecological Unit (PNW) .....	27
	SPECIAL STUDIES (PNW) .....	27
3.3.17	Special Study 2002a (Platform and Moss Abundance).....	27
3.3.18	Special Study 2007a (Fire Effects and Recovery: 2006 Day Fire).....	27
	GPS INFORMATION .....	27
3.3.19	Previous UTM Zone (PNW) .....	27
3.3.20	Previous Easting (X) UTM (PNW).....	27
3.3.21	Previous Northing (Y) UTM (PNW).....	27
3.3.22	Previous Coordinates Method (PNW) .....	27
<b>3.4</b>	<b>PLOT ATTRIBUTES COLLECTED IN THE FIELD .....</b>	<b>28</b>
3.4.1	NFS Plot Number (PNW).....	28
3.4.2	PLOT STATUS (CORE 1.4).....	28
3.4.3	PLOT NONSAMPLED REASON (CORE 1.5).....	28
3.4.4	SUBPLOTS EXAMINED (CORE 1.6).....	29
3.4.5	SAMPLE KIND (CORE 1.7) .....	29
3.4.6	PNW Plot Kind (PNW) .....	30
3.4.7	PREVIOUS PLOT NUMBER (CORE 1.8).....	31
3.4.8	CREW TYPE (CORE 1.15).....	31
3.4.9	QA STATUS (CORE 1.14).....	31

Annual Inventory 2007, Chapter 3: Plot Data

3.4.10	Crew Leader (PNW)	32
3.4.11	Crew Member 1 thru 5 (PNW)	32
	CURRENT DATE OF INVENTORY	32
3.4.12	MONTH (CORE 1.10.2)	32
3.4.13	DAY (CORE 1.10.3)	32
3.4.14	YEAR (CORE 1.10.1)	32
3.4.15	Landowner Plot Summary Request (PNW)	33
3.4.16	Owner name/address update (PNW)	33
3.4.17	Topographic Position (PNW)	33
3.4.18	HORIZONTAL DISTANCE TO IMPROVED ROAD (CORE 1.12)	34
	GPS COORDINATES	34
3.4.19	GPS UNIT TYPE (CORE 1.16.3)	35
3.4.20	GPS SERIAL NUMBER (CORE 1.16.4)	35
3.4.21	GPS DATUM (CORE 1.16.5)	35
3.4.22	COORDINATE SYSTEM (CORE 1.16.6)	35
3.4.23	UTM ZONE (CORE 1.16.9)	35
3.4.24	EASTING (X) UTM (CORE 1.16.10)	36
3.4.25	NORTHING (Y) UTM (CORE 1.16.11)	36
3.4.26	GPS ELEVATION (CORE 1.16.15)	36
3.4.27	GPS ERROR (CORE 1.16.16)	36
3.4.28	NUMBER OF READINGS (CORE 1.16.17)	36
3.4.29	GPS FILENAME (CORE OPTIONAL 1.16.18)	37
	CORRECTION FOR "OFFSET" LOCATION	37
3.4.30	AZIMUTH TO PLOT CENTER (CORE 1.16.13)	37
3.4.31	DISTANCE TO PLOT CENTER (CORE 1.16.14)	37
3.4.32	PLOT-LEVEL NOTES (CORE 1.18)	37
<b>3.5</b>	<b>DATA ITEMS RECORDED ON THE PLOT CARD</b>	<b>38</b>

## Chapter 3: PLOT DATA

Plot attributes record plot location and information about the field crew visit and landowner contact. This information aids future crews in plot relocation, sets up date and inventory cycle information in the data recorder, and makes it possible to analyze the relationship of plot data to other mapped data (i.e. rivers).

All variables listed in Chapter 3 are collected on plots with at least one accessible forested condition (PLOT STATUS = 1) and all NONFOREST/NONSAMPLED plots (PLOT STATUS = 2 or PLOT STATUS = 3). In general, plot level data apply to the entire plot and they are recorded from the center of subplot 1. A plot is considered nonforest if no part of it is currently located in forest land (CONDITION CLASS STATUS = 1). A plot is nonsampled if the entire plot is not sampled for one of the reasons listed in PLOT NONSAMPLED REASON.

If a forest plot has been converted to nonforest or becomes a nonsampled plot, the previous data are reconciled and an attempt is made to visit the plot during the next inventory. If a nonforest plot becomes forest or access is gained to a previously nonsampled plot, a new forest ground plot is installed. All nonforest and nonsampled plots are visited if there is any reasonable chance that they might include some forest land condition class.

Trees on previously forest land plots will be reconciled during data processing. There is a distinction between plots that have been clearcut, and plots that have been converted to another land use. A clearcut plot is considered to be forest land until it is actively converted to another land use. Additional information concerning land use classifications is contained in Chapter 4 (Section 4.1).

See Appendix 1 for special rules about nonforest plots/condition classes on R5 and R6 NFS lands.

### 3.1 Time Spent Plot

Basic information about time spent collecting plot data is needed. Information about the time it takes to measure plots will help determine possible cost and time savings of changes or deletions to data collected, or cost and time expenditures of proposed new items.

#### 3.1.1 Travel Time to Plot (PNW)

Record the number of clock hours it took for the crew to reach and find the plot. Include all time reaching the plot including time spent driving, flying, getting keys from landowners, stopping for coffee, changing flat tires, hiking, searching for the plot location, etc. Typically, this will include the time driving from last night's lodging and hiking to the plot. (If multiple days were required to reach the plot, include travel from all days. If additional plots are measured from a single campsite, use travel time from the campsite for the additional plots. If time differs among crew, use the crew leader's travel time. If the plot was visited on subsequent days also, use only travel time to reach the plot on the initial visit.) Estimate travel time to the nearest half hour.

When collected:	All Field Visited Plots
Field width:	3 digits (xx.y)
Tolerance:	1 hour
Values:	00.0 to 99.5

#### 3.1.2 Measurement Time on Plot (PNW)

Record the number of person-hours it took to measure all items on the plot (number of people on plot \* number of hours on plot). If multiple days were required, add times for a total. Include all time on plot including breaks (if any), equipment repair, etc., as well as actual measurement time. Estimate measurement time on plot to the nearest half hour.

When collected:	All Field Visited Plots
Field width:	3 digits (xx.y)
Tolerance:	1 hour
Values:	00.0 to 99.5

#### 3.1.3 Travel Time from Plot (PNW)

Record the number of clock hours you think it will take to travel back from the plot. Do not include time for anticipated stops or delays. Typically this will be from the plot to the lodging where you are staying. (If multiple

days are required to return, use total travel time anticipated. If additional plots have been measured from a single campsite, use only travel time to the campsite for the additional plots.) Estimate travel time to the nearest half hour.

When collected:	All Field Visited Plots
Field width:	3 digits (xx.y)
Tolerance:	1 hour
Values:	00.0 to 99.5

### 3.2 REFERENCE POINT (RP) ATTRIBUTES

Record the following items which describe the RP and the course from the RP to the plot as described on Page 14. These data items should match what is recorded on the paper Plot Card form.

#### 3.2.1 RP Species (PNW)

If the RP is a tree or stump record the species code. If it is not, record 999.

When collected:	All plots
Field width:	4 digits
Tolerance:	No errors
Values:	See Appendix 9 for species codes. If it is not a tree or stump, record 999.

#### 3.2.2 RP Diameter (PNW)

If the RP is a tree or stump, measure (or estimate) and record the diameter (see Section 7.6) to the nearest inch. If it is not a tree or stump record 999.

When collected:	All plots
Field width:	3 digits
Tolerance:	+/- 10%
Values:	001 to 999 to the nearest inch. If it is not a tree or stump record 999.

#### 3.2.3 RP Azimuth (PNW)

Record, in degrees, the azimuth from the RP to the plot center.

When collected:	All plots
Field width:	3 digits
Tolerance:	+/- 4 degrees
Values:	001 to 360

#### 3.2.4 RP Distance (PNW)

Record, to the nearest foot, the slope distance from the RP to the plot center.

When collected:	All plots
Field width:	4 digits
Tolerance:	+/- 5 %
Values:	0000 - > 5000 feet

#### 3.2.5 RP Az/Dist to Subplot # (PNW)

Record the 1-digit number of the subplot which is referenced from the RP. Reference to subplot 1 whenever possible.

When collected:	All plots
Field width:	1 digits
Tolerance:	No errors
Values:	1 to 4

### 3.3 PLOT ATTRIBUTES DOWNLOADED TO THE PDR

Do not change the downloaded/printed code for the following variables.

#### 3.3.1 STATE (CORE 1.1)

Record the unique FIPS (Federal Information Processing Standard) code identifying the State where the plot center is located.

When collected:	All plots
Field width:	2 digits
Tolerance:	No errors
Values:	See Appendix 5.1

#### 3.3.2 COUNTY (CORE 1.2)

Record the unique FIPS (Federal Information Processing Standard) code identifying the county (or unit in AK) where the plot center is located.

When collected:	All plots
Field width:	3 digits
Tolerance:	No errors
Values:	See Appendix 5.1

#### 3.3.3 PLOT NUMBER (CORE 1.3)

Record the identification number for each plot, unique within a county.

This may be referred to as Hexagon Number on the plot jacket. The National Core procedures specify that Hex Number is a 4-digit variable. To keep the Hex Number unique within a state, PNW has numbered each Hex with a 5-digit number, the last 4 of which are unique within a county. Do not change the downloaded/printed code. If SAMPLE KIND = 3 (Replacement plot), the PLOT NUMBER for the new (replacement) plot will be assigned by NIMS. For the PDR use the current PLOT NUMBER and a QA STATUS code of 8 (indicates replacement plot).

When collected:	All plots SAMPLE KIND = 1 or SAMPLE KIND = 2
Field width:	5 digits
Tolerance:	No errors
Values:	1 to 99999

#### 3.3.4 Old PNW-FIA Plot Number (PNW)

A 3-digit code identifying the plot number (if any) used for this location at previous periodic inventories (e.g. county plot number). This item is included as a reference. Do not change the downloaded/printed code.

#### 3.3.5 CORE FIELD GUIDE VERSION # (CORE 1.9)

Record the version number of the Forest Inventory and Analysis National Core Field Guide which was used to collect the data on this plot. This will be used to match collected data to the proper version of the field manual. The 2006 field guide version is 3.0.

When collected:	All plots
Field width:	2 digits
Tolerance:	No errors
Values:	3.0

#### 3.3.6 PNW Data Recorder Program Version # (PNW)

A 3-digit field identifying the version number of the data recorder program used to collect data on the plot, in the format x.y.z. PNW data recorder program version # will start at 1.0.0 at the beginning of the field season. If minor modifications to the data recorder program are made in response to changes in field procedures or programming requirements, the z field will be changed to z+1. If more significant changes are made, the y field will be changed to y+1. The first field (x) will be changed only in the event of a major modification to the program. Field manuals are not reprinted during the season, but future printings would include any change(s) made to procedures. Do not change the data recorder generated code.

Values: x.y.z (starting at 1.0.0)

**3.3.7 DECLINATION (CORE OPTIONAL 1.11)**

Record in degrees the azimuth correction used to adjust magnetic north to true north. All azimuths are assumed to be magnetic azimuths unless otherwise designated. This field carries a decimal place because the USGS corrections are provided to the nearest half degree. DECLINATION is defined as:  $DECLINATION = (TRUE\ NORTH - MAGNETIC\ NORTH)$

The declination used for each plot will be downloaded/printed, and is listed by county in Appendix 5.1. This adjustment is made in the field by setting the declination for the plot as "East Declination" on the compass. Do not change the downloaded/printed code.

When collected:	CORE OPTIONAL All plots
Field width:	5 digits including sign. (+xxx.y)
Tolerance:	No errors
Values:	-015.0 to -017.0 (Oregon) -016.0 to -018.0 (Washington) -012.0 to -016.0 (California) -014.5 to -016.5 (Idaho) -013.0 to -015.0 (Nevada)

**3.3.8 Elevation (PNW)**

A 5-digit code downloaded/printed for the plot if recorded in a previous inventory. This item shows the elevation to the nearest 5-feet on the plot as obtained from a USGS topographic map. Do not change the downloaded/printed code. Leave this item blank if no code was downloaded/printed.

**3.3.9 Precipitation (PNW)**

A 3-digit code downloaded/printed for the plot if recorded in a previous inventory. This item shows average annual precipitation in inches on the plot. Do not change the downloaded/printed code. Leave this item blank if no code was downloaded/printed.

**3.3.10 Hydrologic Unit Code (PNW)**

A 12-digit code printed/downloaded for the plot. This item identifies the watershed in which the field grid point is located. Do not change the printed/downloaded code. Leave this item blank if no code was printed/downloaded.

**3.3.11 MACROPLOT BREAKPOINT DIAMETER (CORE OPTIONAL 1.17)**

When the macroplot core option is being utilized, the value selected for breakpoint diameter for that particular plot is downloaded with the PDR file. A macroplot breakpoint diameter is the diameter (either DBH or DRC) above which trees are measured on the plot extending from 0.01 to 58.9 feet horizontal distance from the center of each subplot. The Pacific Northwest FIA unit uses breakpoint diameters of 24 inches or 30 inches. Installation of macroplots is core optional and is used to have a larger plot size in order to more adequately sample large trees. See the PDR generated value.

**3.3.12 Hectare Plot? (PNW)**

A 2-digit code indicating if the hectare plot is sampled for large trees, and if so, what size tree is included in that sampling ( $\geq 32"$  or  $\geq 48"$  diameter). This item is downloaded for plots in California (including R6 lands in CA). In Washington and Oregon it will be calculated once the County and Owner group are recorded. In either case do not change the downloaded/calculated code.

**3.3.13 Date of Previous Inventory (PNW)**

4-digit code downloaded/printed if a date was assigned for the plot at the previous inventory. It indicates the month and year of the previous inventory. Do not change the downloaded/printed date.

**3.3.14 Remeasurement Period (PNW)**

During the 2006 Annual Inventory the remeasurement period (the number of years of growth counted on trees bored for radial growth) is 5 and 10 years on all plots. The increment period may be different at future inventories. Do not change the downloaded/printed code.

### 3.3.15 Previous Ground Land Class (PNW)

A 2-digit code is downloaded/printed for plots that were classified within inventoried area at the time of the previous inventory (See Appendix 4 for the GLC codes and their definitions). Do not change the downloaded/printed GLC code.

### 3.3.16 Ecological Unit (PNW)

A 1-digit code downloaded for the plot that records one of 8 Ecological Units for which separate stockability equations have been developed. Most counties in California have been assigned to one of these Ecological Units. Do not change the downloaded/printed code. See Section 9.5.3 Stockability Indicators for California.

## **SPECIAL STUDIES (PNW)**

### 3.3.17 Special Study 2002a (Platform and Moss Abundance)

A 1-digit code downloaded/printed for the plot. This item identifies whether or not the plot area is within the sample area for Special Study 2002a, which varies from 0 to roughly 50 miles from the coast, and if qualifying trees on this plot are sampled for Platform and Moss Abundance. Do not change the downloaded/printed code, but notify the state coordinator if you believe it is incorrect.

Code	Definition
Y	Qualifying trees are sampled for Platform and Moss Abundance
N	Trees are not sampled for Platform and Moss Abundance

### 3.3.18 Special Study 2007a (Fire Effects and Recovery: 2006 Day Fire)

A 1-digit code which identifies whether or not the plot area is within the Day Fire boundary. This item is downloaded/printed for PNW-FIA plots on the 6,000 acre grid. Do not change the downloaded/printed code. Enter the appropriate code for plots without downloaded plot files (i.e. R5 CVS plots).

When this item = Y, additional Tree Data variables are collected on the R5 remeasurement ("old") plot, additional ground cover variables are collected on the microplots, and one additional understory vegetation measurement is taken.

Code	Definition
Y	Plot is within the Day Fire boundary
N	Plot is not within the Day Fire boundary

See Fire Study Supplemental Field Guide for the Day Fire Study protocol.

## **GPS INFORMATION**

### Downloaded Plot Coordinates (PNW)

For some plots, previous estimates of plot coordinates (pinprick location) may be available. These estimates come from several sources and will be of undocumented accuracy, but can be used as an aid in plot location. If available, the approximate plot coordinates will be downloaded to the data recorder and will be printed on the previous plot data sheets. They can be saved as a waypoint on the GPS unit and used to help locate the plot. Do not change any of the downloaded/printed plot coordinates codes.

### 3.3.19 Previous UTM Zone (PNW)

A 2-digit and 1 character field indicating in which UTM zone the plot is located..

### 3.3.20 Previous Easting (X) UTM (PNW)

A 7-digit code indicating the Easting as determined from USGS maps, aerial photos, or a previous plot visit.

### 3.3.21 Previous Northing (Y) UTM (PNW)

A 7-digit code indicating the Northing as determined from USGS maps, aerial photos, or a previous plot visit.

### 3.3.22 Previous Coordinates Method (PNW)

A 1-character code indicating the method by which previous plot coordinates were obtained.

Code	Previous coordinates method
D	Digitized from USGS maps
M	Digitized (MDSD) from PI photography (usually small scale)
P	Digitized (MDSD) from PLOT photography (usually large scale)
G	Collected at the plot location using a GPS unit

### 3.4 PLOT ATTRIBUTES COLLECTED IN THE FIELD

#### 3.4.1 NFS Plot Number (PNW)

Record the unique identification number for each R6 plot which is not assigned a HEX NUMBER. Used for intensification and other plots not on the PNW-FIA 6,000 acre grid.

Record for all R5 NFS plots, including those with a HEX NUMBER. The NFS Plot Number will be downloaded for on grid FIA plots. Confirm that the downloaded value is correct.

When collected:	When STATE = 06 (California) and OWNER GROUP for Condition Class 1 = 10, or When STATE = 41 (Oregon) or 53 (Washington), OWNER GROUP for Condition Class 1 = 10 and HEX NUMBER is not assigned.
Field width:	5 digits when OWNER CLASS = a R5 National Forest 7 digits when OWNER CLASS = a R6 National Forest
Tolerance:	
Values:	1 to 1,000,000

#### 3.4.2 PLOT STATUS (CORE 1.4)

Record the code that describes the sampling status of the plot. In cases where a plot is inaccessible, but obviously contains no forest land, record PLOT STATUS = 2. In cases where a plot is access-denied or hazardous land use and has the possibility of forest, record PLOT STATUS = 3. See accessible forest land condition, Section 4.1.

When collected:	All plots		
Field width:	1 digit		
Tolerance:	No errors		
Values:	Code	Status	Status Definition
	1	Sampled	At least one accessible forest land condition present on plot.
	2	Sampled	No accessible forest land condition present on plot (use this code if accessible forest land condition is present only on the hectare plot).
	3	Non-sampled	Requires PLOT NONSAMPLED REASON code

#### 3.4.3 PLOT NONSAMPLED REASON (CORE 1.5)

For entire plots that cannot be sampled, record one of the following reasons.

When collected:	When PLOT STATUS = 3	
Field width:	2 digits	
Tolerance:	No errors	
Values:	Code	NONSAMPLED REASON
	01	Outside U.S. boundary – Entire plot is outside of the U.S. border.
	02	Denied access – Access to the entire plot is denied by the legal owner, or by the owner of the only reasonable route to the plot. Because a denied-access plot can become accessible in the future, it remains in the sample and is re-examined at the next occasion to determine if access is available.
	03	Hazardous – Entire plot cannot be accessed because of a hazard or danger, for example cliffs, quarries, strip mines, illegal substance plantations, high water, etc. Although most hazards will not change over time, a hazardous plot remains in the sample and is re-examined at the next occasion to determine if the hazard is still present.
	05	Lost data – Plot data file was discovered to be corrupt after a panel was completed and submitted for processing. This code is applied at the time of processing after notification to the units. This code is for office use only.
	06	Lost plot – Entire plot cannot be found. Whenever this code is assigned, a replacement plot is required. The plot that is lost is assigned SAMPLE KIND = 2 and NONSAMPLED



		REASON = 6. The replacement plot is assigned SAMPLE KIND = 3.
07		Wrong location – Previous plot can be found, but its placement is beyond the tolerance limits for plot location. Whenever this code is assigned, a replacement plot is required. The plot being relocated is assigned SAMPLE KIND = 2 and NONSAMPLED REASON = 7. Its replacement plot is assigned SAMPLE KIND = 3.
08		Skipped visit – Entire plot skipped. Used for plots that are not completed prior to the time a panel is finished and submitted for processing. This code is for office use only.
09		Dropped intensified plot - Intensified plot dropped due to a change in grid density. This code used only by units engaged in intensification. This code is for office use only.
10		Other – Entire plot not sampled due to a reason other than one of the specific reasons already listed. A field note is required to describe the situation.

### 3.4.4 SUBPLOTS EXAMINED (CORE 1.6)

Record the number of subplots examined.

When collected:	When PLOT STATUS = 2 or 3	
Field width:	1 digit	
Tolerance:	No errors	
Values:	Code	Status Definition
	1	Only subplot 1 center condition examined and all other subplots assumed to be the same
	4	All four subplots fully described (no assumptions/inferences)

### 3.4.5 SAMPLE KIND (CORE 1.7)

Record the code that describes the kind of plot being installed. Sample kind is printed/downloaded for the plot. Update if incorrect and note on the plot card in "Items for office attention".

When collected:	All Plots		
Field width:	1 digit		
Tolerance:	No errors		
Values:	Code	Sample Kind	Sample Kind Definition
	1	Initial 4-subplot plot establishment	The initial establishment and sampling of a national design plot (FIA Field Guide versions 1.1 and higher). SAMPLE KIND 1 is assigned under the following circumstances: --Initial activation of a panel or subpanel --Reactivation of a panel or subpanel that was previously dropped --Resampling of established plots that were not sampled at the previous visit No 4-subplot FIA (P2 or P3) plot was previously established Initial activation of a panel or subpanel
	2	Remeasurement	Remeasurement of a national design plot that was sampled at the previous inventory.
	3	Replacement plot	A replacement plot for a previously established plot. Assign SAMPLE KIND = 3 if a plot is re-installed at a location other than the original location (i.e. plots that have been lost, moved, or otherwise replaced). Note that replacement plots require a separate plot file for the previous plot. <i>Lost plots are assigned SAMPLE KIND = 2, PLOT STATUS = 3, the appropriate NONSAMPLED REASON code, and QA STATUS = 8. For the replacement plot, open a new file in the PDR; assign the current PLOT NUMBER, SAMPLE KIND = 3, PLOT STATUS = 1, and QA STATUS = 1.</i>

When a plot is lost and a replacement plot is installed enter the following codes for the plot variables shown below for lost plots and their new replacement plots.

	PLOT STATUS	SAMPLE KIND	QA STATUS	File Name ending
Lost (replaced) plot	3	2	8	"L"
New (replacement) plot	1	3	1	"P"

### 3.4.6 PNW Plot Kind (PNW)

PNW Plot Kind identifies Annual inventory plots installed at old Periodic plot locations (periodic-to-annual) so that estimates of forest change can be made. Although substantial differences exist between periodic and annual inventories, paired plots (annual-to-periodic) can be used to estimate annual net change for 5 year reports, and estimate mortality, growth, and net change for 10 year reports if "remeasured" periodic plots are clearly identified.

When collected:	All Plots Where SAMPLE KIND = 1	
Field width:	1 digit	
Tolerance:	No errors	
Values:	Code	Status Definition
	1	New plot: No previous periodic plot installed at this location, and plot is not a revisited plot or replacement plot.
	2	Periodic revisited plot – exact: Annual plot of 4-subplots is being established over a periodic plot and the center stake of subplot one is at the same position as for the periodic plot. Periodic plots include any FIA, R4, R5, R6, or BLM plots; most of these had 5-subplots (see appendices for more information). Crew should complete PNW mortality and growth assessment protocols.
	3	Periodic revisited plot - remonumented: Annual plot of 4-subplots is being established over a periodic plot, but ground disturbance (e.g., logging activities, fire, landslide) required re-establishing subplot 1 in the same location, as best as could be done. Crew should complete PNW mortality and growth assessment protocols.
	4	Periodic replacement plot – wrong location: Previous crew had established periodic plot in incorrect location. Current crew is putting in this new annual plot at the correct location. Crew should not complete PNW mortality and growth assessment protocols, and collection of data at new (correct) location should follow new plot procedures.
	5	Periodic replacement plot – could not find / lost plot: All attempts to locate the previous plot have failed. Crew is unable to complete PNW mortality and growth assessment protocols. Collect all data for this newly installed Annual inventory plot.

The following examples describe how to code PNW Plot Kind and associated variables under various scenarios.

#### **Annual inventory initial installation/remeasurement**

- I. Crew installs a new ANNUAL plot – no corresponding periodic plot.

SAMPLE KIND = 1

PNW Plot Kind = 1

*No remeasurement protocols apply*

- II. Crew remeasures an ANNUAL plot (annual to annual). Annual to annual remeasurement includes remeasurement of "P3" plots.

SAMPLE KIND = 2

PNW Plot Kind Does not apply

*Annual to annual remeasurement protocols apply*

#### **Annual inventory installation at previous Periodic plot location**

- III. Crew installs a new ANNUAL plot at the same location as an old PERIODIC plot and is able to locate the old plot and install the new Annual plot at the same location.

SAMPLE KIND = 1

PNW Plot Kind = 2

*Mortality and growth assessment protocols apply*

Annual Inventory 2007, Chapter 3: Plot Data

IV. Crew attempts to install a new ANNUAL plot at the same location of an old PERIODIC plot, but ground disturbance (e.g., logging, fire, landslide) has made it necessary to establish the center of Annual inventory subplot 1 in the same location, as best as could be done.

SAMPLE KIND = 1  
PNW Plot Kind = 3

*Mortality and growth assessment protocols apply*

V. Crew attempts to install a new ANNUAL plot at the same location as an old PERIODIC plot, but the old Periodic plot was in the incorrect location relative to the air photo. The correct location for the center of subplot 1 is based on the pinprick of the oldest air photo for the plot. DO NOT relocate an incorrectly installed plot to the correct location unless 1) it is more than 500 feet from the correct location OR 2) it appears that the crew avoided the correct location because of the difficulty of measurement at the correct location. A new plot is installed in the correct location only when the above conditions are not applicable.

SAMPLE KIND = 1  
PNW Plot Kind = 4

*No remeasurement protocols apply*

VI. Crew attempts to install a new ANNUAL plot at the same location as an old PERIODIC plot and cannot find the old periodic plot.

SAMPLE KIND = 1  
PNW Plot Kind = 5

*No remeasurement protocols apply*

### 3.4.7 PREVIOUS PLOT NUMBER (CORE 1.8)

Record the identification number for the plot that is being replaced.

When collected:	When SAMPLE KIND = 3
Field width:	5 digits
Tolerance:	No errors
Values:	00001 to 99999

### 3.4.8 CREW TYPE (CORE 1.15)

Record the code to specify what type of crew is measuring the plot.

When collected:	All plots	
Field width:	1 digit	
Tolerance:	No errors	
Values:	Code	Crew type
	1	Standard Forest Service field crew
	2	QA crew (any QA crew member present collecting data, regardless of plot QA Status)
	3	Standard Contractor field crew

### 3.4.9 QA STATUS (CORE 1.14)

Electronic data files are automatically named by the data recorder using the HEX NUMBER and File Name Code. Electronic data files for plots with QA STATUS 2 to 6 (and 8) are saved as separate files so that the original standard production plot data is preserved and can be used for quality control and statistical analysis.

See QA Check Plot definitions in Section 1.7.

Annual Inventory 2007, Chapter 3: Plot Data

When collected:	All plots		
Field width:	1 digit		
Tolerance:	No errors		
Values:	File Name Code	Code	Visit type
	P	1	Standard production plot
	C	2	Cold check
	R	3	Reference plot (off grid)
	T	4	Training/practice plot (off grid)
	D	5	Botched plot file (disregard during data processing)
	B	6	Blind check
	H	7	Production plot (hot check)
L	8	Replacement plot (for Lost plot)	

**3.4.10 Crew Leader (PNW)**

Enter the first initial and last name of the crew leader responsible for the plot.

When collected:	All plots
Field width:	12 characters
Tolerance:	No errors
Values:	1 name of up to 12 characters

**3.4.11 Crew Member 1 thru 5 (PNW)**

Enter the first initial and last name of up to five additional crew members taking measurements on the plot.

When collected:	All plots
Field width:	12 characters per name
Tolerance:	No errors
Values:	5 names of up to 12 characters each

**CURRENT DATE OF INVENTORY**

Record the month, day, and year that the current plot visit was completed as follows:

**3.4.12 MONTH (CORE 1.10.2)**

Record the month that the plot was completed.

When collected:	All plots							
Field width:	2 digits							
Tolerance:	No errors							
Values:	Month	Code		Month	Code		Month	Code
	January	01		May	05		September	09
	February	02		June	06		October	10
	March	03		July	07		November	11
	April	04		August	08		December	12

**3.4.13 DAY (CORE 1.10.3)**

Record the day of the month that the plot was completed.

When collected:	All plots
Field width:	2 digits
Tolerance:	No errors
Values:	01 to 31

**3.4.14 YEAR (CORE 1.10.1)**

Record the year that the plot was completed.

When collected:	All plots
Field width:	4 digits
Tolerance:	No errors
Values:	2006

**3.4.15 Landowner Plot Summary Request (PNW)**

1-digit code which indicates if a landowner of the plot area requests a summary of the data collected on their land. If a plot summary is requested by the owner of subplot 1, verify that the printed name/address is correct (see Section 3.4.16). Make any special comments relevant to the data request (i.e. landowner does not own all 4 subplots, the owner of subplot 2 wants data, etc.) on the plot jacket on the owner address label and use code 2.

When collected:	All plots	
Field width:	1 digit	
Tolerance:	No errors	
Values:	Code	Landowner Plot Summary Request
	0	No data request
	1	Plot summary requested
	2	Special case request

**3.4.16 Owner name/address update (PNW)**

1-digit code which indicates if the landowner name and address printed on the plot jacket label (the owner of subplot 1) needs to be updated. It is important that this information be verified for all plots, not just the ones where the owner has requested data. Write corrections to the printed name and address on the plot jacket on the ownership label. Be sure to include the full address. If there is no recorded landowner on the plot jacket label (it is blank) record a code 1. The crew should collect the owner's name and address and write it on the plot jacket label. Note: If a landowner of plot area other than subplot 1 requests data, make it clear in the PLOT NOTES that the 'official' (subplot 1) owner has not changed.

When collected:	All plots	
Field width:	1 digit	
Tolerance:	No errors	
Values: Code		Owner name/address update
	0	Current name and address is correct
	1	Name and/or address needs to be updated (see plot jacket)

**3.4.17 Topographic Position (PNW)**

Record a 1-digit code for topographic position that best describes the plot area. Use the common shape of slope listed in the table below as a guide. Record the code that best fits the topographic position (Figure 3-1).

If the plot straddles a canyon bottom or on a narrow ridge top, but most of the area lies on one side hill record the topographic position of the side hill.

When collected:	All plots with at least one accessible forest land condition class (PLOT STATUS = 1) and all entirely non-forest plots on National Forest System land		
Field width:	1 digit		
Tolerance:	1 class for codes 3, 4, and 5. No error for other codes.		
Values:	Code	Topographic Position	Common shape of slope
	1	Ridge top or mountain peak over 130 feet	Flat
	2	Narrow ridge top or peak less than 130 feet wide.	Convex
	3	Side hill -- upper 1/3	Convex
	4	Side hill -- middle 1/3	No rounding
	5	Side hill -- lower 1/3	Concave
	6	Canyon bottom less than 660 feet wide	Concave
	7	Bench, terrace or dry flat	Flat
	8	Broad alluvial flat over 660 feet wide	Flat
	9	Swamp or wet flat	Flat

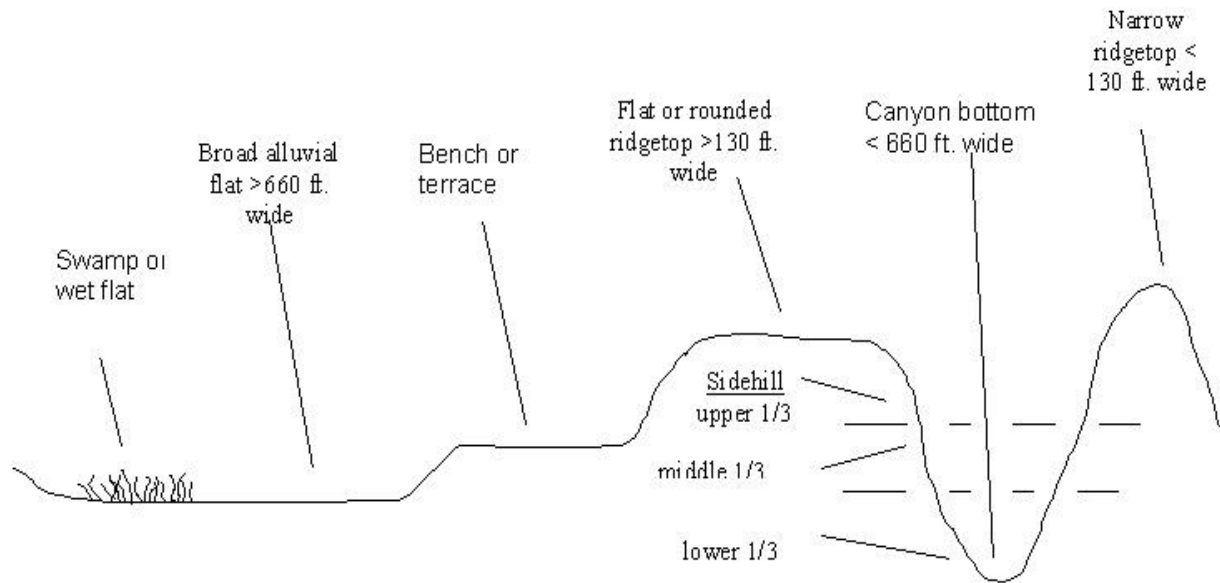

Figure 3-1: Illustration of Topographic Position codes.

**3.4.18 HORIZONTAL DISTANCE TO IMPROVED ROAD (CORE 1.12)**

Record the straight-line distance from plot center (subplot 1) to the nearest improved road. An improved road is a road of any width that is maintained as evidenced by pavement, gravel, grading, ditching, and/or other improvements.

When collected:	All plots with at least one accessible forest land condition class (PLOT STATUS =1) and all entirely non-forest plots on National Forest System land.	
Field width:	1 digit	
Tolerance:	No errors	
Values:	Code	Horizontal Distance
	1	100 feet or less
	2	101 to 300 feet
	3	301 to 500 feet
	4	501 to 1000 feet
	5	1001 feet to 1/2 mile
	6	1/2 to 1 mile
	7	1 to 3 miles
	8	3 to 5 miles
9	Greater than 5 miles	

**GPS COORDINATES**

Use a global positioning system (GPS) unit to determine the plot coordinates and elevation of all field visited plot locations (*including Nonforest and Not in the sample plot locations*).

**GPS Unit Settings, Datum, and Coordinate System**

Consult the GPS unit operating manual or other regional instructions to ensure that the GPS unit internal settings, including Datum and Coordinate system, are correctly configured. Use the NAD 27 Datum (also known as NAS-C or NA 27 CONUS/CLK66) and the UTM coordinate system. See Appendix 6 for instructions on setting up and using the GPS unit.

**Collecting Readings**

Collect at least 180 GPS readings at the plot center which will then be averaged by the GPS unit. Each individual reading should have an error of less than 70 feet if possible (the error of all the averaged readings is far less).

Soon after arriving at plot center, use the GPS unit to attempt to collect coordinates. If suitable readings (180 readings at error less than or equal to 70 feet) cannot be obtained, try again before leaving the plot center.

If it is still not possible to get suitable coordinates from plot center, attempt to obtain them from a location within 200 ft of plot center. Obtain the azimuth and horizontal distance from the "offset" location to plot center. Record the azimuth and horizontal distance to plot center (Sections 3.4.30 and 3.4.31).

Coordinates may be collected further than 200 feet away from the plot center if a laser measuring device is used to determine the horizontal distance from the "offset" location to plot center. Record the azimuth and horizontal distance to plot center (Sections 3.4.30 and 3.4.31). In all cases try to obtain at least 180 readings before recording the coordinates.

### 3.4.19 GPS UNIT TYPE (CORE 1.16.3)

Record the kind of GPS unit used to collect coordinates. If suitable coordinates cannot be obtained, record 0.

When collected:	All field visited plots	
Field width:	1 digit	
Tolerance:	No errors	
Values:	Code	GPS UNIT TYPE
	0	GPS coordinates not collected
	1	Rockwell Precision Lightweight GPS Receiver (PLGR)
	2	Other brand capable of field averaging
	3	Other brands capable of producing files that can be post processed
4	Other brands not capable of field averaging or post processing	

### 3.4.20 GPS SERIAL NUMBER (CORE 1.16.4)

Record the last six digits of the serial number on the GPS unit used.

When collected:	When GPS UNIT TYPE > 0
Field width:	6 digit
Tolerance:	No errors
Values:	Alphanumeric

### 3.4.21 GPS DATUM (CORE 1.16.5)

Record the acronym indicating the map datum that the GPS coordinates are collected in (i.e., the map datum selected on the GPS unit to display the coordinates).

When collected:	When GPS UNIT > 0
Field width:	5 characters (ccnn)
Tolerance:	No errors
Values:	NAD27 (North American Datum of 1927)

### 3.4.22 COORDINATE SYSTEM (CORE 1.16.6)

Record a code indicating the type of coordinate system used to obtain readings.

When collected:	When GPS UNIT TYPE > 0
Field width:	1 digit
Tolerance:	No errors
Values:	2 - UTM coordinate system

### 3.4.23 UTM ZONE (CORE 1.16.9)

Record a 2-digit and 1-character field UTM ZONE as determined by GPS.

When collected:	When COORDINATE SYSTEM = 2
Field width:	3 digits
Tolerance:	No errors
Values:	10, 11, and U, T, or S

### 3.4.24 EASTING (X) UTM (CORE 1.16.10)

Record, in meters, the Easting coordinate of the plot center as determined by GPS.

The PDR will require that this item be entered two times. The first entry is the UTM as displayed by the GPS unit. The second entry is the UTM numbers in reverse order (from right to left).

When collected:	When COORDINATE SYSTEM = 2
Field width:	7 digits
Tolerance:	+/- 140 ft
Values:	

### 3.4.25 NORTHING (Y) UTM (CORE 1.16.11)

Record, in meters, the Northing coordinate of the plot center as determined by GPS.

The PDR will require that this item be entered two times. The first entry is the UTM as displayed by the GPS unit. The second entry is the UTM numbers in reverse order (from right to left).

When collected:	When COORDINATE SYSTEM = 2
Field width:	7 digits
Tolerance:	+/- 140 ft
Values:	

### 3.4.26 GPS ELEVATION (CORE 1.16.15)

Record the elevation above mean sea level of the plot center, in feet, as determined by GPS.

When collected:	When GPS UNIT TYPE (3.4.19) = 1, 2, or 4
Field width:	6 digits (1 <sup>st</sup> digit is + or -, last 5 digits are numeric)
Tolerance:	+/- 280 ft
Values:	-00100 to +20000

### 3.4.27 GPS ERROR (CORE 1.16.16)

Record the error as shown on the GPS unit to the nearest foot. As described in Appendix 6, make every effort to collect readings only when the error less than or equal to 70 feet. However, if after trying several different times during the day, at several different locations, this is not possible, record readings with an error of up to 999 feet.

When collected:	When GPS UNIT TYPE (3.4.19) = 1, or 2
Field width:	3 digits
Tolerance:	No errors
Values:	000 to 070 if possible 071 to 999 if an error of less than 70 cannot be obtained

### 3.4.28 NUMBER OF READINGS (CORE 1.16.17)

Record a 3-digit code indicating how many readings were averaged by the GPS unit to calculate the plot coordinates. Collect at least 180 readings if possible.

The PDR requires that the number of averaged readings be entered. The Magellan unit does not have a number of readings counter, instead it utilizes a timer. The timer is displayed on the position screen. It displays in hours/minutes/and seconds. The GPS receiver collects one reading per second while averaging. To correctly enter the number of readings in the PDR, the time in minutes and seconds must be converted to number of readings. Since the unit collects 60 readings per minute of averaging crews must remember to multiply the number of minutes by 60 and then add the number of seconds shown to that figure. For example, if the Magellan receiver averages for three minutes and twelve seconds it will display 00:03:12. To convert this to number of readings multiple three minutes by sixty and add twelve.  $3 \times 60 = 180 + 12 = 192$ . Crews would enter 192 in the PDR for Number of Readings.



When collected:	When GPS UNIT TYPE (3.4.19) = 1 or 2
Field width:	3 digits
Tolerance:	No errors
Values:	001 to 999

### 3.4.29 GPS FILENAME (CORE OPTIONAL 1.16.18)

Record the filename containing the GPS positions collected on the plot.

When collected:	When GPS UNIT TYPE (3.4.19) = 3, STATE = 06 (CA), and CREW TYPE = 3 (contractor field crew)
Field width:	8 characters.3 characters (e.g., R0171519.ssf)
Tolerance:	No errors
Values:	Letters and numbers

### **CORRECTION FOR "OFFSET" LOCATION**

As described in the beginning of the GPS section, coordinates may be collected at a location other than the plot center (an "offset" location). If a PLGR unit is used all offset coordinates will be "corrected" back using the Rng/Calc function. If a GPS unit other than a PLGR is used, then record **AZIMUTH TO PLOT CENTER** and **DISTANCE TO PLOT CENTER**.

### 3.4.30 AZIMUTH TO PLOT CENTER (CORE 1.16.13)

Record, in degrees, the azimuth from the location where coordinates were collected to actual plot center. If coordinates are collected at plot center, record 000.

When collected:	When GPS UNIT = 2, 3 or 4
Field width:	3 digits
Tolerance:	+/- 3 degrees
Values:	000 when coordinates are collected at plot center 001 to 360 when coordinates are not collected at plot center

### 3.4.31 DISTANCE TO PLOT CENTER (CORE 1.16.14)

Record the horizontal distance in feet from the location where coordinates were collected to the actual plot center. If coordinates are collected at plot center, record 000. As described in under COLLECTING READINGS (page 34), if a Laser range finder is used to determine DISTANCE TO PLOT CENTER, offset locations may be up to 999 feet from the plot center. If a range finder is not used, the offset location must be within 200 feet.

When collected:	When GPS UNIT = 2, 3 or 4
Field width:	3 digits
Tolerance:	+/- 6 ft
Values:	000 when coordinates are collected at plot center 001 to 200 when a Laser range finder is not used to determine distance 001 to 999 when a Laser range finder is used to determine distance

### 3.4.32 PLOT-LEVEL NOTES (CORE 1.18)

Use this field to record notes pertaining to the entire plot. If the notes apply only to a specific subplot or other specific aspect of the plot, then make that clear in the notes.

When collected:	All plots
Field width:	Unlimited alphanumeric character field
Tolerance:	N/A
Values:	English language words, phrases and numbers

### **3.5 DATA ITEMS RECORDED ON THE PLOT CARD**

The following items are collected and recorded on the paper Plot Card form:

- Plot Information
- RP Data and Access Description to RP
- Plot Write Up
- Plot Diagram
- Access to Plot – Sketch Map
- Notes to Field Crew From Office Review
- Is the Documented Owner Correct?

See Appendix 14.4: “Plot Card Write Up” for descriptions of these items and detailed instructions.

## 4 CONDITION CLASS

### Table of Contents

<b>4</b>	<b>CONDITION CLASS .....</b>	<b>39</b>
<b>4.1</b>	<b>DETERMINATION OF CONDITION CLASS .....</b>	<b>41</b>
<b>4.2</b>	<b>CONDITION CLASS STATUS DEFINITIONS .....</b>	<b>41</b>
1.	ACCESSIBLE FOREST LAND .....	41
2.	NONFOREST LAND .....	43
3.	NONCENSUS WATER .....	44
4.	CENSUS WATER .....	44
5.	NONSAMPLED .....	44
<b>4.3</b>	<b>CONDITION CLASS ATTRIBUTES.....</b>	<b>45</b>
<b>4.4</b>	<b>DETERMINING CONDITION CLASS STATUS.....</b>	<b>45</b>
4.4.1	CONDITION CLASS NUMBER (CORE 2.4.1).....	45
4.4.2	CONDITION CLASS STATUS (CORE 2.4.2) .....	46
	DETERMINING CONDITION CLASSES DIFFERING IN CONDITION CLASS STATUS .....	46
4.4.3	CONDITION NONSAMPLED REASON (CORE 2.4.3).....	48
<b>4.5</b>	<b>DELINEATING CONDITION CLASSES ON ACCESSIBLE FOREST LAND.....</b>	<b>48</b>
	DELINEATING CONDITION CLASSES WITHIN ACCESSIBLE FOREST LANDS.....	49
4.5.1	RESERVED STATUS (CORE 2.5.1).....	50
4.5.2	OWNER GROUP (CORE OPTIONAL 2.5.2).....	51
4.5.3	FOREST TYPE (CORE 2.5.3).....	51
4.5.4	STAND SIZE CLASS (CORE 2.5.4).....	52
4.5.5	REGENERATION STATUS (CORE 2.5.5).....	53
4.5.6	TREE DENSITY (CORE 2.5.6).....	53
<b>4.6</b>	<b>NON-DELINEATING VARIABLES FOR ACCESSIBLE FOREST LAND.....</b>	<b>54</b>
4.6.1	Current Ground Land Class (PNW) .....	54
4.6.2	OWNER CLASS (CORE OPTIONAL 2.5.7).....	55
4.6.3	PRIVATE OWNER INDUSTRIAL STATUS (CORE 2.5.8).....	56
4.6.4	ARTIFICIAL REGENERATION SPECIES (CORE 2.5.9).....	56
4.6.5	STAND AGE (CORE 2.5.10) .....	57
4.6.6	Stand Structure (PNW).....	58
4.6.7	DISTURBANCE 1 (CORE 2.5.11).....	58
4.6.8	DISTURBANCE YEAR 1 (CORE 2.5.12).....	59
4.6.9	DISTURBANCE 2 (CORE 2.5.13).....	59
4.6.10	DISTURBANCE YEAR 2 (CORE 2.5.14).....	59
4.6.11	DISTURBANCE 3 (CORE 2.5.15).....	60
4.6.12	DISTURBANCE YEAR 3 (CORE 2.5.16).....	60
4.6.13	Historical Disturbance 1 (PNW).....	60
4.6.14	Historical Disturbance Year 1 (PNW) .....	60
4.6.15	Historical Disturbance 2 (PNW).....	60
4.6.16	Historical Disturbance Year 2 (PNW) .....	60
4.6.17	Historical Disturbance 3 (PNW).....	60
4.6.18	Historical Disturbance Year 3 (PNW) .....	60
4.6.19	TREATMENT 1 (CORE 2.5.17).....	60
4.6.20	TREATMENT YEAR 1 (CORE 2.5.18).....	62
4.6.21	TREATMENT 2 (CORE 2.5.19).....	62

Annual Inventory 2007, Chapter 4: Condition Class

4.6.22	TREATMENT YEAR 2 (CORE 2.5.20)	62
4.6.23	TREATMENT 3 (CORE 2.5.21)	62
4.6.24	TREATMENT YEAR 3 (CORE 2.5.22)	62
4.6.25	Historical Treatment 1 (PNW)	62
4.6.26	Historical Treatment Year 1 (PNW)	62
4.6.27	Historical Treatment 2 (PNW)	63
4.6.28	Historical Treatment Year 2 (PNW)	63
4.6.29	Historical Treatment 3 (PNW)	63
4.6.30	Historical Treatment Year 3 (PNW)	63
4.6.31	Evidence of Stumps (PNW)	63
4.6.32	Evidence of Fire (PNW)	63
4.6.33	PHYSIOGRAPHIC CLASS (CORE 2.5.23)	63
4.6.34	Soil Depth (PNW)	63
4.6.35	Stand Condition/Stage of Development (PNW)	64
4.6.36	Plant Association (PNW)	64
4.6.37	Mixed Conifer Site (PNW-CA)	65
4.6.38	Stockability Indicator Set (PNW)	66
<b>4.7</b>	<b>NON-FOREST LANDS: DELINEATING CONDITION CLASS</b>	<b>66</b>
4.7.1	PRESENT NON-FOREST LAND USE (CORE OPTIONAL 2.5.24)	66

## Chapter 4: CONDITION CLASS

Condition class attributes record information about the land type that allows grouping and analysis of similar land types. They also record information about forest structure, composition, and disturbance, which allows analysts to group similar forest types, understand management practices used by different landowners, examine effects of disturbance, and classify land types on which little data are collected--for example, when a condition class only occurs on a small portion of one subplot.

### 4.1 DETERMINATION OF CONDITION CLASS

#### STEP 1: DELINEATE THE PLOT AREA BY CONDITION CLASS STATUS

The first attribute considered when defining a condition class is **CONDITION CLASS STATUS**. The area sampled by a plot is assigned to condition classes based upon the following differences in **CONDITION CLASS STATUS**:

1. Accessible forest land
2. Nonforest land
3. Noncensus water
4. Census water
5. Nonsampled

Accessible forest land defines the population of interest for FIA purposes. This is the area where most of the data collection is conducted.

At time of re-inventory, one additional attribute, **PRESENT NONFOREST LAND USE**, is used to define new condition classes if the sampled area on a plot has changed from accessible forest land to nonforest land (See Section 4.7.1). This allows tracking of land use changes without requiring mapping of all nonforest condition classes on all plots. If in doubt whether a separate condition exists, then leave as a single condition.

#### STEP 2: FURTHER SUBDIVIDE ACCESSIBLE FOREST LAND BY 6 DELINEATION VARIABLES

Any condition class sampled as accessible forest land may be further subdivided, in order of listed priority, into smaller condition classes if distinct, contrasting condition classes are present because of variation in any of the following attributes within the sampled area:

1. RESERVED STATUS
2. OWNER GROUP
3. FOREST TYPE
4. STAND SIZE CLASS
5. REGENERATION STATUS
6. TREE DENSITY

No other attribute shall be the basis for recognizing contrasting accessible forest land condition classes. For each condition class recognized, several "ancillary attributes" that help describe the condition will be collected, but will not be used for delineation purposes (see Section 4.6).

All condition classes present within the 58.9 foot fixed-radius are mapped on the subplot diagram. Measure trees, snags, saplings, and seedlings on accessible forest land condition classes. Understory vegetation and down woody material are measured on accessible forest land condition classes in Oregon, Washington, and California. These data are not measured or collected in any other type of mapped condition classes (except on R5 & R6 lands where these data ARE collected on nonforest condition classes).

### 4.2 CONDITION CLASS STATUS DEFINITIONS

#### 1. ACCESSIBLE FOREST LAND

Land that is within the population of interest, is accessible, is on a subplot that can be occupied at subplot center, can safely be visited, and meets at least one of the two following criteria:

(a) the condition is at least 10-percent stocked by trees of any size (See Appendix 9 – Tree Species List) or has been at least 10-percent stocked in the past. Additionally, the condition is not subject to nonforest use(s) that

prevent normal tree regeneration and succession such as regular mowing, *current* intensive grazing, or recreation activities; or

(b) in several western woodland species (denoted with a "w" in Appendix 9 and listed below) where stocking cannot be determined, the condition has at least 5 percent crown cover by trees of any size, or has had at least 5 percent cover in the past. Additionally, the condition is not subject to nonforest use that prevents normal regeneration and succession such as regular mowing, chaining, or recreation activities. *Species codes with an \* below are unlikely to be found in PNW region.*

Code	Common Name	Genus	Species
62	California juniper	Juniperus	californica
65	Utah juniper	Juniperus	osteosperma
66	Rocky Mountain juniper	Juniperus	scopulorum
106	common pinyon	Pinus	edulis
133	singleleaf pinyon	Pinus	monophylla
134*	border pinyon	Pinus	discolor
140*	Mexican pinyon pine	Pinus	cembroides
321	Rocky Mountain maple	Acer	glabrum
475	curlleaf mountain-mahogany	Cercocarpus	ledifolius
756	Western honey mesquite	Prosopis	glandulosa var. torreyana
757	velvet mesquite	Prosopis	velutina
758	screwbean mesquite	Prosopis	pubescens
814*	Gambel oak	Quercus	gambelii
902	New Mexico locust	Robinia	neomexicana
990	tesota, Arizona-ironwood	Olneya	tesota

To qualify as forest land, the prospective condition must be at least 1.0 acre in size and 120.0 feet wide measured stem-to-stem from the outer-most edge. Forested strips must be 120.0 feet wide for a continuous length of at least 363.0 feet in order to meet the acre threshold. Forested strips that do not meet these requirements are classified as part of the adjacent nonforest land.

**Transition zones and forest/nonforest encroachment:** When an accessible forest land condition encroaches into a nonforest condition, the border between forest and nonforest is often a gradual change in tree cover or stocking with no clear and abrupt boundary. In addition, it may be difficult to determine exactly where the forested area meets the minimum stocking criteria and where it does not. For these cases, determine where the land clearly meets the 10 percent minimum forest land stocking, and where it clearly is less than required stocking; divide the zone between these points in half, and determine the side of the zone on which the subplot center is located.

Classify the condition class of the subplot based on this line (Figure 4-1).

For example, at measurement time 1, a clear and distinct boundary existed between the forest and nonforest condition classes. At time 2, however, there now exists a zone of regeneration or small diameter trees between the previous forest condition and where the nonforest clearly remains. If the zone of encroachment is clearly stocked where it meets the nonforest, classify the entire zone as forest. If the zone is clearly nonforest up to the original stand, call it all nonforest. If the encroachment or transition zone is not clearly stocked where it meets the nonforest, determine where it is clearly stocked (forest) and where it is clearly not stocked (nonforest); divide this zone in half, and classify the entire subplot based on which side of the line the subplot center falls.

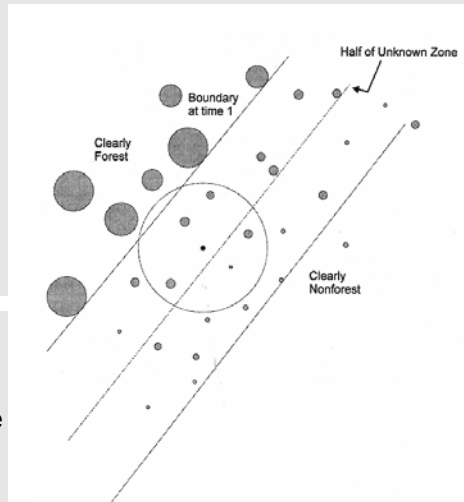

Figure 4-1: Example of classifying the condition class of the subplot in a transition zone with forest/nonforest encroachment.

**Treated strips** – Occasionally, crews will come across plantations of trees, in which rows of trees alternate with strips of vegetation that have been bulldozed, mowed, tilled, treated with herbicide, or crushed. Because these strip treatments are conducted to optimize growth or to release the stand, the areas are considered forest land, and

the treatment is considered a timber stand improvement operation. Do not confuse these practices with similar treatments on nonforest lands such as yards or rights-of-way. Contact with the landowner may help determine the intent of a treatment.

Indistinct boundary due to the condition minimum-width definition – Do not subdivide subplots where a condition class may change due only to the forest vs. nonforest minimum width (120.0 feet) definition. Although the point where the definition changes from forest to nonforest creates an invisible “line” between conditions, this definitional boundary is not distinct and obvious. See Figures 4-2a and 4-2b below. Where the point of the definition change occurs on the subplot, determine only if the subplot center is on the forest or nonforest side of that approximate boundary, and classify the entire subplot based on the condition of the subplot center. If the boundary crosses through the center of the subplot, classify the subplot as the condition it most resembles. If the boundary occurs between subplots, classify each subplot based on its relation to the definitional boundary.

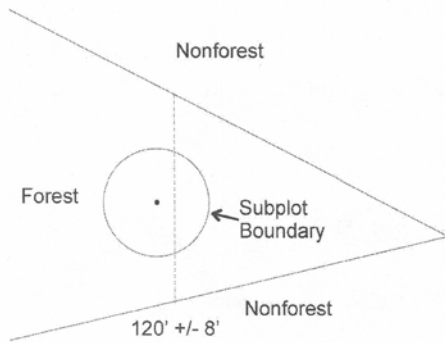

Figure 4-2a: Forest condition narrows within a nonforest condition. Examine the location of the subplot center in reference to the approximate line where the non forest narrows to 120.0 feet wide. In this example the entire subplot is classified as forest.

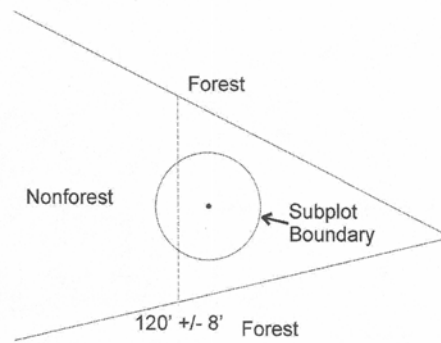

Figure 4-2b: Nonforest condition narrows within a forest condition. Examine the location of the subplot center in reference to the approximate line where the forest narrows to 120.0 feet wide. In this example the entire subplot is classified as forest.

Land may be considered for nonforest use even though tree cover is present. Indications of non-forest use may include the presence of fences or structures, the clearing of stumps, current extreme grazing, the absence of forest vegetation, evidence of human habitation and use around maintained structures such as landscaping, gardens, lawns, and play areas. The absence of forest vegetation means that some or all layers of the vegetation present--trees, shrubs and forbs--differ from what one would expect on forest land undisturbed by nonforest use. For example, a fenced, farm-lot may have forest trees present, but if extreme sustained grazing has severely diminished or eliminated forest shrub and forb communities and tree regeneration is stifled, the farm-lot is likely nonforest. (In the Pacific Northwest and California, grazing, common on forest lands, is rarely reason to classify a plot as "developed for nonforest use" unless a situation similar to the example is encountered).

The minimum area needed to qualify as accessible forest land is 1.0 acre. The minimum width to qualify as accessible forest land is 120.0 ft

## **2. NONFOREST LAND**

Non-forest land is any land within the sample that does not meet the definition of accessible forest land or any of the other CONDITION CLASS STATUS values defined in Section 4.2. To qualify, the area must be at least 1.0 acre in size and 120.0 feet wide, with 5 exceptions discussed in Section 4.2.2. Do not consider evidence of "possible" or future development or conversion. A nonforest land condition will remain in the sample and will be examined at the next occasion to see if it has become forest land.

Map non-forest condition classes at each established subplot on all field visited plots in California, Washington, and Oregon as follows:

- An accessible forest land condition class is present on the 58.9-foot fixed-radius: Map all of the nonforest condition classes present on the 58.9-foot fixed-radius. **Do not combine nonforest condition classes**

**present.** Example: if nonforest--urban land and nonforest--cropland are both present within a 58.9-foot fixed-radius plot, map each nonforest land use as a separate condition class.

- No accessible forest land condition classes exist within the 58.9 ft radius: Record only the nonforest land use at the subplot center. (See exceptions for R5 and R6 lands in Appendix A1.2)

All Nonforest land condition classes are assigned a use code. (See PRESENT NONFOREST LAND USE, Section 4.7.1)

Plots that are entirely non-forest fall into one of the following three categories:

1. The plot is field visited on the ground.
  - A plot file is created in the field data recorder.
  - GPS coordinates are collected.
  - PRESENT NONFOREST LAND USE is collected at each subplot center.
2. The plot is field visited and viewed from a distance.
  - A plot file is created in the field data recorder.
  - PRESENT NONFOREST LAND USE is collected for each subplot center.
3. The plot is not field visited.
  - A plot data file is created in the office.
  - PRESENT NONFOREST LAND USE is collected for each subplot center.

### **3. NONCENSUS WATER**

Noncensus water includes lakes, reservoirs, ponds, and similar bodies of water 1.0 acre to 4.5 acres in size and rivers, streams, canals, etc., 30.0 ft to 200 ft wide.

If a subplot center (including subplot 1) lands in Noncensus water, the entire subplot is considered Noncensus water and is classified as a condition class with CONDITION CLASS STATUS = 3 (Noncensus water). No field measurements are made on that subplot. Establish and measure other subplots following normal procedures.

If the center of a subplot is accessible, but the subplot has Noncensus water present within its 58.9-foot fixed-radius plot; 1) Map the Noncensus water area as a separate condition class. 2) Record the segment lengths of any CWD transects that extend into the noncensus water condition class. 3) Use normal procedures to map and measure other condition classes.

### **4. CENSUS WATER**

Census water includes lakes, reservoirs, ponds, and similar bodies of water 4.5 ac in size and larger; and rivers, streams, canals, etc. more than 200 ft wide (1990 U.S. Census definition).

If a subplot center (including subplot 1) lands in Census water, the entire subplot is considered Census water and is classified as a condition class with CONDITION CLASS STATUS = 4 (Census water). No field measurements are made on that subplot. Establish and measure other subplots following normal procedures.

If the center of a subplot is accessible, but the subplot has Census water present within its 58.9-foot fixed-radius plot: 1) Map the Census water area as a separate condition class. 2) Record the segment lengths of any CWM transects that extend into the Census water condition class. 3) Use normal procedures to map and measure other condition classes.

### **5. NONSAMPLED**

- Denied Access Area or Hazardous Situation:

If a subplot center (including subplot 1) is located in an access denied or hazardous area, the entire subplot is considered access denied (CONDITION NONSAMPLED REASON = 2 (denied access area)) or hazardous (CONDITION NONSAMPLED REASON = 3 (hazardous situation)). No field measurements are made on that subplot. Establish and measure other subplots following normal procedures.

If the center of a subplot is accessible, but the subplot has access denied or hazardous areas present within the 58.9-foot fixed-radius plot: 1) map the access denied or hazardous area as a separate condition class, 2) record the segment lengths of any CWM transects that extend into the access denied or hazardous condition class. 3) use normal procedures to map and measure other condition classes.

A plot, subplot, or portion of a subplot is hazardous according to the crew's judgment.



### 4.3 CONDITION CLASS ATTRIBUTES

A CONDITION CLASS NUMBER and a classification for CONDITION CLASS STATUS are required for every condition class sampled on a plot. For each condition class classified as accessible forest land, a classification is required for each of the following attributes:

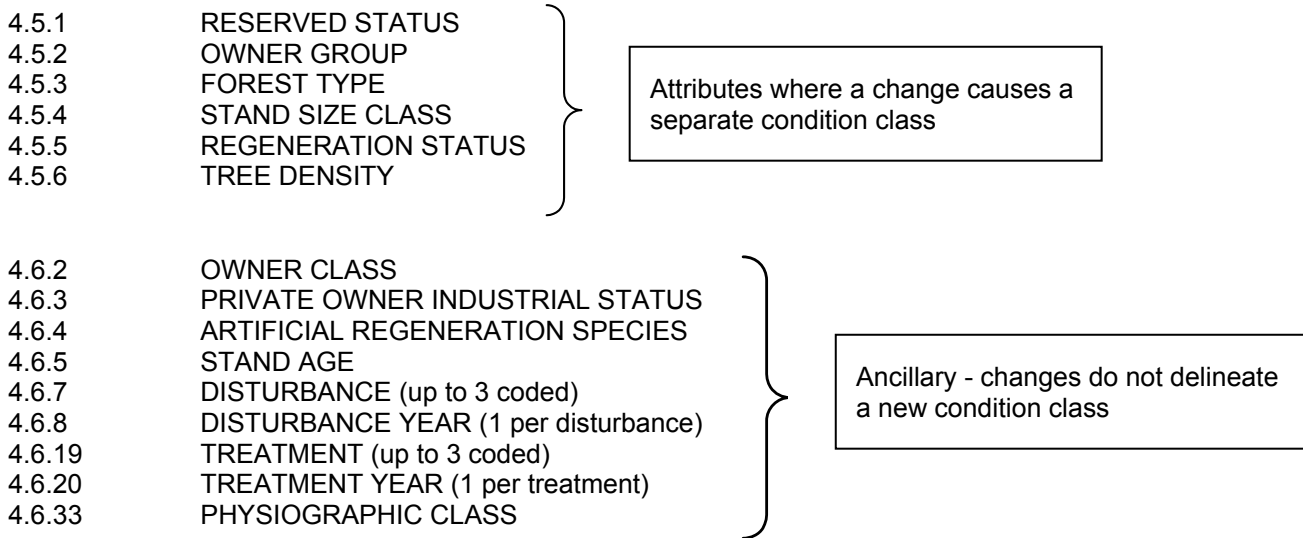

PRESENT NONFOREST LAND USE (4.7.1) records area converted from accessible forest land condition class to non-forest land since last inventory).

When classifying CONDITION CLASS STATUS, OWNER GROUP, RESERVED STATUS, and PRESENT NONFOREST LAND USE, base the classification on what is present within the area defined by the fixed radius plot (macroplot, subplot, or microplot). When classifying all other condition class variables, base the classification on the macroplot.

**Remeasurement Plots:** The downloaded condition class delineation variables should always be reviewed and updated as necessary. If changes have occurred then reassess the condition class boundaries mapped by the previous crew. On remeasurement plots use the plot condition class printout located in the plot jacket to review the previous Condition Class layouts and assess whether any change has occurred. Retain the previous CONDITION CLASS NUMBER assignments whenever possible, even if they were assigned in the wrong order.

### 4.4 DETERMINING CONDITION CLASS STATUS

The first step in delineating condition classes is to recognize differences in CONDITION CLASS STATUS.

#### 4.4.1 CONDITION CLASS NUMBER (CORE 2.4.1)

On a plot, assign and record a number for each condition class. The condition class at plot center (the center of subplot 1) is always designated condition class 1. Other condition classes are assigned numbers sequentially at the time each condition class is delineated.

Number condition classes sequentially as encountered going from subplot 1 thru 4, numerically. See Remeasurement Plots above for numbering instructions on these plots.

When collected:	All condition classes
Field width:	1 digit
Tolerance:	No errors
Values:	1 to 9 (Note: PDR only records 5 condition classes)

**4.4.2 CONDITION CLASS STATUS (CORE 2.4.2)**

Record the code that describes the status of the condition. Record for all condition classes sampled on a plot.

When collected:	All condition classes												
Field width:	1 digit												
Tolerance:	No errors												
Values:	<table border="1"> <thead> <tr> <th>CODE</th> <th>CONDITION CLASS STATUS</th> </tr> </thead> <tbody> <tr> <td>1</td> <td>Accessible forest land</td> </tr> <tr> <td>2</td> <td>Nonforest land</td> </tr> <tr> <td>3</td> <td>Noncensus water</td> </tr> <tr> <td>4</td> <td>Census water</td> </tr> <tr> <td>5</td> <td>Nonsampled</td> </tr> </tbody> </table>	CODE	CONDITION CLASS STATUS	1	Accessible forest land	2	Nonforest land	3	Noncensus water	4	Census water	5	Nonsampled
CODE	CONDITION CLASS STATUS												
1	Accessible forest land												
2	Nonforest land												
3	Noncensus water												
4	Census water												
5	Nonsampled												

**DETERMINING CONDITION CLASSES DIFFERING IN CONDITION CLASS STATUS**

The following guidelines, and those regarding boundaries, depicted in Figure 4-4, apply when delineating condition classes that differ by CONDITION CLASS STATUS.

The most common difference is adjacent accessible forest land and nonforest land. Adjacent accessible forest land and nonforest land condition classes are recognized only if each of the two prospective condition classes is at least 1.0 acre in size, and each is at least 120.0 feet in width. These size and width minimums apply to both accessible forest land and nonforest land.

Within an accessible forest land condition class, unimproved roads, rock outcrops, and natural nonforest openings less than 1.0 ac in size and less than 120.0 feet in width are considered forest land and are not delineated and classified as a separate nonforest condition class.

Within a nonforest land condition class, forested areas or linear strips of trees less than 1.0 acre in size and less than 120.0 feet in width are considered part of the nonforest condition class.

**Five exceptions to these size and width requirements apply:**

1. Developed nonforest condition: human-caused nonforest land condition classes such as homes or cabins that are less than 1.0 acre in size and 120.0 feet in width and are surrounded by forest land. There are three kinds of developed nonforest conditions that do not have to meet area or width requirements (Figure 4-3).

- a) Improved roads: paved roads, gravel roads, or improved dirt roads regularly maintained for long-term continuing use by normal passenger vehicles. Generally constructed using machinery. The area where the original topography has been disturbed by cutbanks and fill is considered part of the road, if that area is maintained. Unimproved traces and roads created for skidding logs are not considered improved roads.
- b) Maintained rights-of-way: corridors created for railroads, power lines, gas lines, and canals that are periodically treated to limit the establishment and growth of trees and shrubs. Areas under powerlines are considered maintained right of way even if no evidence of vegetation treatment is currently evident.
- c) Developments: structures and the maintained area next to a structure, all less than 1.0 acre in size and surrounded by forest land. Examples of developments are houses or trailers on very small lots, communication installations in a small cleared area within forest land, and barns and sheds.

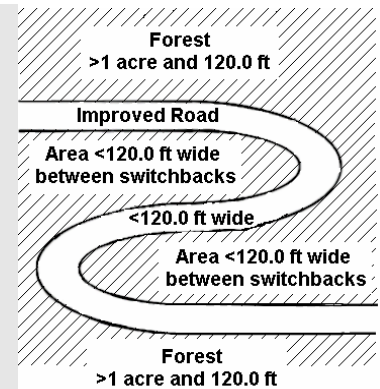

Figure 4-3. Example of a switchback road.

2. Distinct, alternating strips of forest and nonforest land: this situation occurs when a plot or subplot samples a condition class that is less than 1.0 acre in size and less than 120.0 feet in width. The condition class is one of a series of parallel strips of forest and nonforest land in which none of the strips meet the minimum width requirement. This exception applies only to nonforest conditions that are not listed under #1, e.g., improved roads, maintained rights-of-way, and developments.

For many small intermingled strips, determine the total area that the alternating strips occupy, and classify according to the CONDITION CLASS STATUS (forest land or nonforest land) that occupies the greater area. If

the area of alternating strips is so large or indistinct as to make a total area determination impractical, then classify the sample as forest land.

For two alternating strips of forest and nonforest between two qualifying areas of nonforest land and forest land, see Figure 4-4 below. The figure delineates the boundary between the forest and nonforest condition classes for four different examples. The plot center defines the plot condition for all strips covered by the arrow. Any subplot that falls in the alternating strips uses the rule. Any subplot that falls in assigned nonforest / forest is assigned that type.

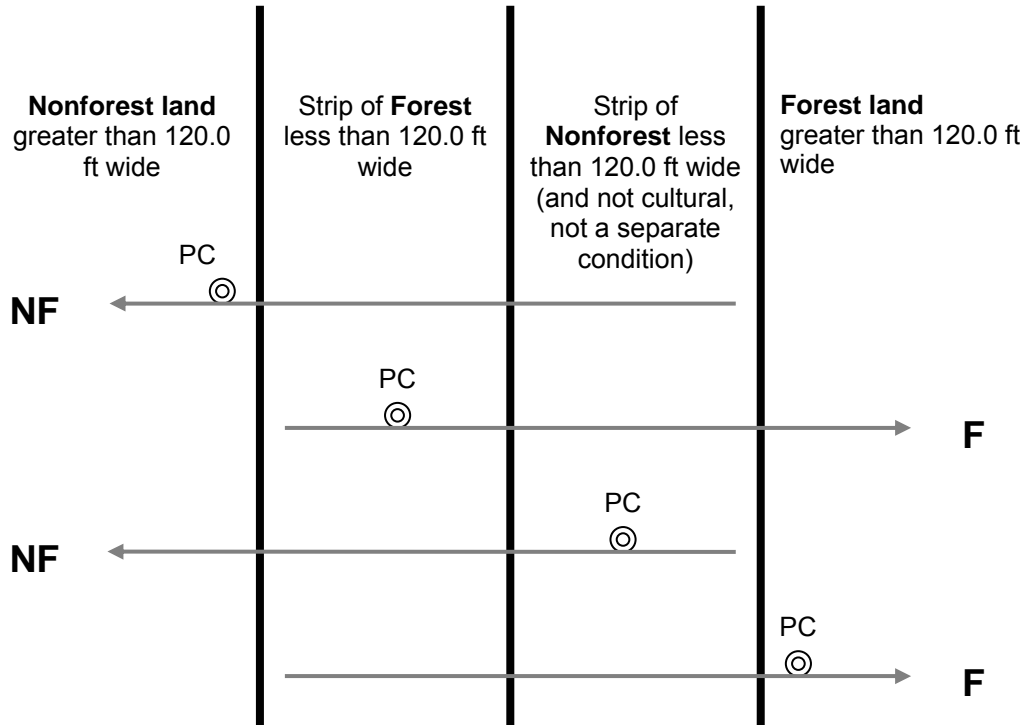

Figure 4-4. Example of alternating strips of forested and nonforested conditions. PC is the plot center (center of subplot 1).

3. The 120.0 foot minimum width for delineation does not apply when a corner angle is 90 degrees or greater (Figure 4-5).

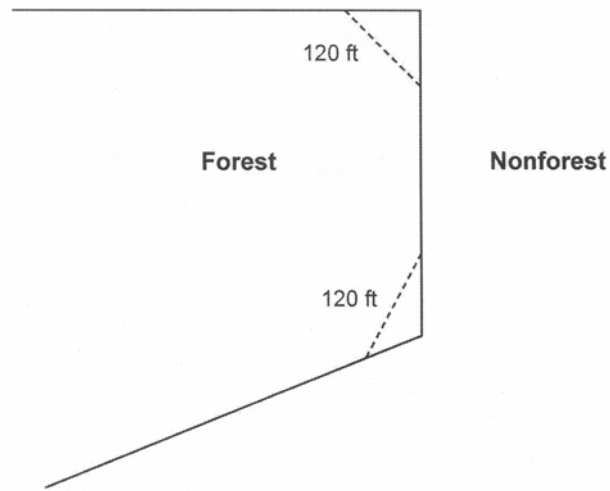

Figure 4-5: Illustration of the 90 degree corner rule. The dotted lines do not create non-forest conditions.

4. Linear water features: natural water features that are linear in shape such as streams and rivers. A linear water feature must meet the definition for Census or Non-census water to be non-forest area. Therefore, a linear water feature must be at least 30.0 feet wide and cover at least 1.0 acre. The width of a linear water feature is measured across its channel between points on either side up to which water prevents the establishment and survival of trees. To determine whether a linear water feature qualifies as non-forest, rely on all available information on hand such as aerial photos, topographic maps, past survey land calls, and ocular estimates at the current survey visit. Linear water features that do not meet the definition for Census or non-census water should be classified as forest land only if bounded by forest land on both shores. Crews are NOT expected to measure the length of a linear water feature to determine if it meets the 1.0 acre requirement; use professional judgment and common sense on any linear water feature. A 30 ft wide stream needs to be 1452 ft long to be an acre in size.
5. Non-sampled conditions within accessible forest land are delineated, regardless of size, as a separate condition.

**4.4.3 CONDITION NONSAMPLED REASON (CORE 2.4.3)**

For portions of plots that cannot be sampled (CONDITION CLASS STATUS = 5), record one of the following reasons.

When collected:	When CONDITION CLASS STATUS = 5	
Field width:	2 digits	
Tolerance:	No errors	
Values:	Code	Non-sampled Reason
	01	Outside U.S. boundary – Assign this code to condition classes beyond the U.S. border.
	02	Denied access area – Any area within the sampled area of a plot to which access is denied by the legal owner, or to which an owner of the only reasonable route to the plot denies access. There are no minimum area or width requirements for a condition class delineated by denied access. Because a denied-access condition can become accessible in the future, it remains in the sample and is re-examined at the next occasion to determine if access is available. In some regions denied access plots may be replaced; check with the field supervisor regarding regional protocols for plot replacement.
	03	Hazardous situation – Any area within the sampled area on plot that cannot be accessed because of a hazard or danger, for example cliffs, quarries, strip mines, illegal substance plantations, temporary high water, etc. Although the hazard is not likely to change over time, a hazardous condition remains in the sample and is re-examined at the next occasion to determine if the hazard is still present. There are no minimum size or width requirements for a condition class delineated by a hazardous condition. In some regions hazardous plots may be replaced; check with the field supervisor regarding regional protocols for plot replacement.
	10	Other – This code is used whenever a plot or condition class is not sampled due to a reason other than one of the specific reasons listed. A field note is required to describe the situation.

**4.5 DELINEATING CONDITION CLASSES ON ACCESSIBLE FOREST LAND**

On revisited plots, some attributes were recorded at the previous visit and are downloaded/printed for condition class 1. Some may require updating.

See Appendix 1 for special rules about non-forest plots/condition classes on R5 and R6 NFS lands.

Accessible forest land is subdivided into condition classes that are based on differences in RESERVED STATUS, OWNER GROUP, FOREST TYPE, STAND SIZE CLASS, REGENERATION STATUS, and TREE DENSITY. Section 4.1 applies when delineating contrasting forest condition classes. Specific criteria apply for each of the six attributes and are documented by attribute in 4.5.1 to 4.5.6. “Stands” are defined by plurality of stocking for all live trees that are not overtopped.

**Additionally**, each separate forest condition class recognized within accessible forest land must be at least 1.0 acre in size and at least 120.0 feet in width. If prospective contrasting forest land condition classes do not each

meet these minimum size and width requirements, the most similar prospective conditions should be combined until these minimums are attained.

No other attribute shall be the basis for recognizing contrasting condition classes within accessible forest land. For each condition class recognized, many “ancillary attributes” that help describe the condition will be collected, but will not be used for delineation purposes (see Section 4.6).

### **DELINEATING CONDITION CLASSES WITHIN ACCESSIBLE FOREST LANDS**

1. Distinct boundary within a macroplot (if applicable), subplot or microplot: Separate condition classes ARE recognized if, within a subplot, two (or more) distinctly different condition classes are present and delineated by a distinct, abrupt boundary. The boundary is referenced.
2. Indistinct boundary within a subplot: Separate condition classes are NOT recognized if the prospective condition classes abut along an indistinct transition zone, rather than on an abrupt, obvious boundary. Only one condition is recognized, and the subplot is classified entirely as the condition it most resembles.

Example: The four subplots all sample only accessible forest land. Subplots 1, 3, and 4 sample what is clearly a stand of large diameter trees. Subplot 2 falls in the middle of a stand size transition zone. In the zone, the large diameter stand phases into a sapling stand.

Subplot 2 must not be divided into two condition classes on the basis of stand size. Instead, it is treated entirely as part of the large diameter condition class or is assigned entirely to a new condition class that is classified as a seedling/sapling stand. The latter occurs only if the crew thinks the entire subplot is more like a stand of seedlings/saplings than a stand of large diameter trees; then the boundary between the large and small diameter stands is assumed to occur between and not on the subplots.

3. A boundary or transition zone between fixed radii plots that sample distinctly different condition classes: Separate condition classes are recognized and recorded when a valid attribute obviously differs between two fixed radius plots, but a distinct boundary or indistinct transition zone exists outside the sampled (fixed-radius) area of the subplots. In such cases, a boundary, if present, is not referenced.

Example: The northernmost subplot (2) samples entirely accessible forest land. The other three subplots, 1, 3, and 4, fall clearly in a non-forest meadow. Between subplot 1 and 2 is a transition zone; the number of trees present goes from none to what clearly represents at least 10-percent tree stocking. Two condition classes are sampled: accessible forest land sampled on subplot 2, and non-forest land sampled on the other subplots.

4. Riparian forest area: A riparian forest area is defined as a forest area between 30.0 and 120.0 feet wide, and 1.0 acre or more in size, cumulative, but not necessarily present on both sides of and adjacent to a naturally occurring or artificially created body of water or watercourse with continuous or intermittent flow. Riparian forest areas may be associated with but not limited to streams, rivers, lakes, sloughs, seeps, springs, marsh, bogs, beaver ponds, sink holes, cypress domes and ponds, man-made ditches and canals. **A riparian forest area must be associated “within forest” and contain at least one distinct and obvious change in a condition class delineation attribute from its adjacent accessible forest land condition class.**

Note: When the width of forest adjacent to a stream is between 120.0 feet and 150.0 feet and the width of the riparian forest is at least 30.0 feet wide, the rules for identifying the non-riparian forest (at least 30.0 feet but less than 120.0 feet) need to be modified. The non-riparian forest can be between 30.0 feet and 120.0 feet and mapped as a separate condition as long as it meets the criteria for delineating a separate condition class, otherwise it will be an inclusion in the riparian forest condition class.

A riparian area (i.e. a band of alder trees along a creek within a Douglas fir condition class) is typically different from the surrounding forest because of forest type. However, a change in any of the 6 condition class delineating variables makes the riparian area a candidate for a riparian area condition class. A riparian condition class only needs to be at least 30.0 ft wide instead of the standard 120.0 feet. It still must be at least 1.0 ac in size, and must be surrounded by forest on at least one side.

Because chaparral is considered non-forest, riparian areas through chaparral must qualify as accessible forest land (120 ft wide and 1 ac in size) on their own in order to be delineated as a separate condition class.

An area 30 ft wide needs to be 1452 ft long to be an acre in size. An area 60 wide needs to be 726 ft wide, and an area 90 ft wide needs to be 484 ft long.

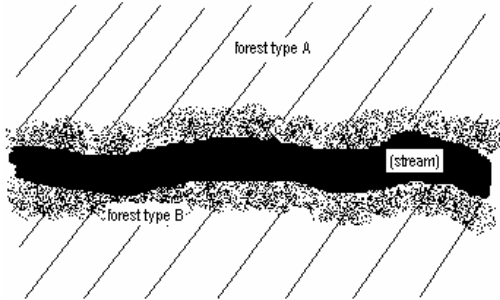

Figure 4-6: If the stream is > 30.0 feet wide, forest type B is a separate condition class (riparian) if either of the two widths of the bands falls between 30.0 feet and 120.0 feet wide and is > 1.0 acre in size.

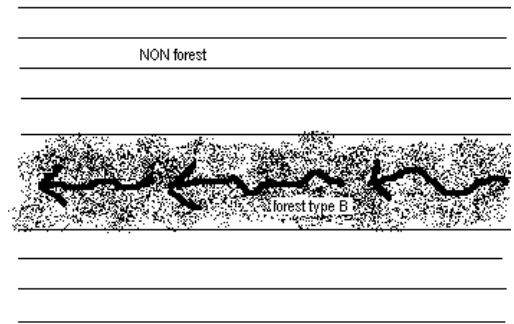

Figure 4-7: In a non-forested area, a band of forest type B that is < 120.0 feet wide is NOT considered a riparian area. It is not a separate condition class at all.

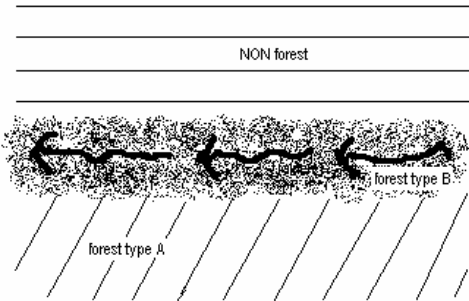

Figure 4-8: Forest type B is a separate condition class (riparian) if the band of it is between 30.0 feet and 120.0 feet wide, and is  $\geq 1.0$  acre in size.

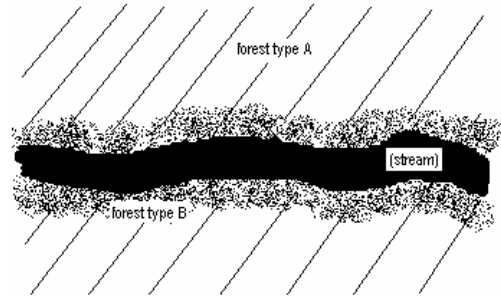

Figure 4-9: If the stream is < 30.0 feet wide, forest type B is a separate condition class (riparian) if the sum of the two widths of the bands falls between 30.0 feet and 120.0 feet wide, and is  $\geq 1.0$  acre in size.

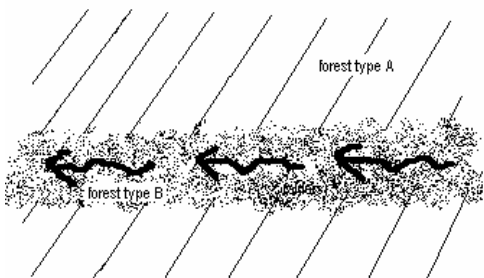

Figure 4-10: Forest type B is a separate condition class (riparian) if the band of it is between 30.0 feet and 120.0 feet wide, and is  $\geq 1.0$  acre in size.

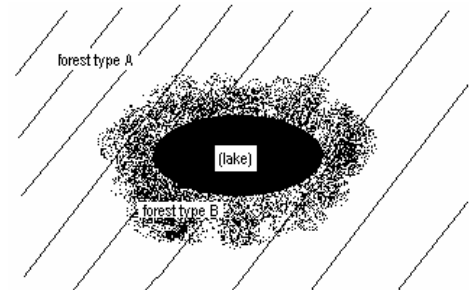

Figure 4-11: Forest type B is a separate condition class (riparian) if the band of it is between 30.0 feet and 120.0 feet wide, and is  $\geq 1.0$  acre in size.

#### 4.5.1 RESERVED STATUS (CORE 2.5.1)

Record the code that identifies the reserved designation for the condition. Reserved land is withdrawn by law(s) prohibiting the management of land for the production of wood products (not merely controlling or prohibiting wood

harvesting methods). Such authority is vested in a public agency or department, and supersedes rights of ownership. The prohibition against management for wood products cannot be changed through decision of the land manager (management agency) or through a change in land management personnel, but is permanent in nature

Such areas include Congressional designated wilderness areas, National Parks, state parks, or other lands protected by law or deed. Private owners such as the Nature Conservancy may have areas of land on which timber harvest is prohibited by deed. Record land as reserved only if the landowner has verified this status or if somehow (i.e. posted sign) it is otherwise clearly defined.

When collected:	All accessible forestland condition classes (CONDITION CLASS STATUS = 1)						
Field width:	1 digit						
Tolerance:	No errors						
Values:	<table border="0"> <tr> <td><b>Code</b></td> <td>Reserve Status</td> </tr> <tr> <td>0</td> <td>Not reserved</td> </tr> <tr> <td>1</td> <td>Reserved</td> </tr> </table>	<b>Code</b>	Reserve Status	0	Not reserved	1	Reserved
<b>Code</b>	Reserve Status						
0	Not reserved						
1	Reserved						

#### 4.5.2 OWNER GROUP (CORE OPTIONAL 2.5.2)

Record the OWNER GROUP code identifying the ownership (or the managing Agency for public lands) of the land in the condition class. Conditions will be delineated based on changes in OWNER GROUP only; separate conditions due to changes in OWNER GROUP are recognized only where differences can be clearly identified on the ground when visiting the plot.

When collected:	All accessible forest land and non-forest condition classes (CONDITION CLASS STATUS >= 1).										
Field width:	2 digits										
Tolerance:	No errors										
Values:	<table border="0"> <tr> <td><b>Code</b></td> <td>Owner Group</td> </tr> <tr> <td>10</td> <td>Forest Service</td> </tr> <tr> <td>20</td> <td>Other Federal</td> </tr> <tr> <td>30</td> <td>State and Local Government</td> </tr> <tr> <td>40</td> <td>Private</td> </tr> </table>	<b>Code</b>	Owner Group	10	Forest Service	20	Other Federal	30	State and Local Government	40	Private
<b>Code</b>	Owner Group										
10	Forest Service										
20	Other Federal										
30	State and Local Government										
40	Private										

#### 4.5.3 FOREST TYPE (CORE 2.5.3)

Record the code corresponding to the FOREST TYPE (from Appendix 8) that best describes the species with the plurality of stocking for all live trees in the condition class that are not overtopped.

If STAND SIZE CLASS is nonstocked, then FOREST TYPE is determined by the following hierarchy:

- For SAMPLE KIND = 2 plots, record the FOREST TYPE of the condition at the previous inventory.
- For all other plots:
  1. Evaluate any seedlings available to determine the FOREST TYPE.
  2. If no seedlings exist, use adjacent stands and your best professional judgment to determine FOREST TYPE.

The instructions in section 4.1 and 4.3 apply when delineating, within accessible forest land, contrasting conditions based on differences in FOREST TYPE. Examples follow:

- An area dominated by softwood tree species bordering an area dominated by hardwood species.
- A pure pine stand adjacent to a mixed conifer stand.
- A hardwood stand principally composed of dry site hardwood species that borders a stand dominated by wet site hardwood tree species.

When collected:	All accessible forestland condition classes (CONDITION CLASS STATUS = 1)
Field width:	3 digits
Tolerance:	No errors in group or type
Values:	See Appendix 8

**4.5.4 STAND SIZE CLASS (CORE 2.5.4)**

Record the code that best describes the predominant size class of all live trees in the condition class.

When collected:	All accessible forestland condition classes (CONDITION CLASS STATUS = 1)		
Field width:	1 digit		
Tolerance:	No errors		
Values:	Code	Stand Size Class	Definition
	0	Nonstocked	Meeting the definition of accessible forest land, and one of the following applies: (a) Less than 10 percent stocked by trees of any size, and not classified as cover trees, or (b) For several western woodland species where stocking standards are not available, less than 5 percent crown cover of trees of any size.
	1	< 4.9 inches (seedling, sapling)	At least 10 percent stocking (or 5 percent crown cover if stocking standards are not available) in trees of any size; and at least 2/3 of the crown cover is in trees less than 5.0 inches DBH/DRC
	2	5.0 - 8.9 inches (softwoods) 5.0 - 10.9 inches (hardwoods)	At least 10 percent stocking (or 5 percent crown cover if stocking standards are not available) in trees of any size; and at least 1/3 of the crown cover is in trees greater than 5.0 inches DBH/DRC and the plurality of the crown cover is in softwoods between 5.0 - 8.9 inches diameter and/or hardwoods between 5.0 - 10.9 inches DBH, and/or western woodland trees 5.0 - 8.9 inches DRC.
	3	9.0 - 19.9 inches (softwoods) 11.0 - 19.9 inches (hardwoods)	At least 10 percent stocking (or 5 percent crown cover if stocking standards are not available) in trees of any size; and at least 1/3 of the crown cover is in trees greater than 5.0 inches DBH/DRC and the plurality of the crown cover is in softwoods between 9.0 - 19.9 inches diameter and/or hardwoods between 11.0 - 19.9 inches DBH, and for western woodland trees 9.0 - 19.9 inches DRC.
	4	20.0 - 39.9 inches	At least 10 percent stocking (or 5 percent crown cover if stocking tables are not available) in trees of any size; and at least 1/3 of the crown cover is in trees greater than 5.0 in DBH/DRC and the plurality of the crown cover is in trees between 20.0 - 39.9 in DBH
	5	40.0 + inches	At least 10 percent stocking (or 5 percent crown cover if stocking standards are not available) in trees of any size; and at least 1/3 of the crown cover is in trees greater than 5.0 inches DBH/DRC and the plurality of the crown cover is in trees $\geq$ 40.0 inches DBH
	6	Cover trees (trees not on species list, used for plots classified as nonforest)	Less than 10 percent stocking by trees of any size, and greater than 5 percent crown cover of species that comprise cover trees

The instructions in Sections 4.1 and 4.3 apply when delineating, on accessible forest land, contrasting conditions based on differences in STAND SIZE CLASS.

Within the sampled area on a microplot, subplot, or macroplot, recognize only very obvious contrasting stands of different mean diameter with an abrupt boundary. Example: an obvious abrupt boundary exists within the sampled (fixed-radius) area of a subplot and demarcates a stand size class change. Use tree stocking of all live trees that are not overtopped to differentiate between stand-size classes; for most western woodland forest types (e.g., pinyon, California juniper, Gambel oak) where stocking standards are not readily available, use percent tree cover to represent stocking.

**Use crown cover as the surrogate for stocking** to determine STAND SIZE CLASS. View the plot from the top down and examine crown cover. The stand must have at least 5 percent of the crown cover in STAND SIZE CLASSES of 1,2,3,4, and 5 or any combination of these STAND SIZE CLASSES; otherwise the STAND SIZE CLASS is 0. If 2/3 of the crown cover is STAND SIZE CLASS=1, classify the condition as STAND SIZE CLASS=1. If less than 2/3 of the crown cover is STAND SIZE CLASS=1, classify the condition as STAND SIZE CLASS=2, 3, 4, or 5 based on which of these STAND SIZE CLASSES has the most crown cover.



#### 4.5.5 REGENERATION STATUS (CORE 2.5.5)

Record the code that best describes the artificial regeneration that occurred in the condition.

The instructions in Section 4.3 apply when delineating, within accessible forest land, contrasting conditions based on differences in REGENERATION STATUS.

For a forest land condition to be delineated and/or classified as artificially regenerated, the condition must show distinct evidence of planting or seeding. If it is difficult to determine whether or not a stand has been planted or seeded, then use code 0. If no distinct boundary exists within the sampled (fixed-radius) area on any subplot, then do not recognize separate conditions. In many regions of the West, trees are not planted in rows, and planted stands do not differ in physical appearance from natural conditions. In these cases, there is no need to differentiate conditions based on stand origin. Plot records or verbal evidence from landowner is acceptable for determining regeneration status.

When collected:	All accessible forestland condition classes (CONDITION CLASS STATUS = 1)		
Field width:	1 digit		
Tolerance:	No errors		
Values:	Code	Regeneration	Description
	0	Natural	Present stand shows no clear evidence of artificial regeneration. Includes unplanted, recently cut lands.
	1	Artificial	Present stand shows clear evidence of artificial regeneration.

#### 4.5.6 TREE DENSITY (CORE 2.5.6)

Record a code to indicate the relative tree density classification. Base the classification on the number of stems/unit area, basal area, tree cover, or stocking of all live trees in the condition that are not overtopped, compared to any previously defined condition class TREE DENSITY.

The instructions in Section 4-3 apply when delineating, within accessible forest land, contrasting conditions based on differences in TREE DENSITY.

Codes 2 and higher are used ONLY when all other attributes used to delineate separate condition classes are homogenous, i.e. when a change in density is the ONLY difference within what would otherwise be treated as only one forest condition. Otherwise, code 1 for all condition classes. Codes 2 and higher are usually, but not always, used to demarcate areas that differ from an adjacent area due to forest disturbance or treatment, e.g., a partial harvest or heavy but not total tree mortality due to a ground fire. Delineation on density should only be done when the less-dense condition is 50 percent or less as dense as the more dense condition.

Do not distinguish between low-stocked stands or stands of sparse and patchy forest.

When collected:	All accessible forestland condition classes (CONDITION CLASS STATUS = 1)		
Field width:	1 digit		
Tolerance:	No errors		
Values:	Code	Tree Density	
	1	Initial density class	
	2	Density class 2 - density different than 1	
	3	Density class 3 - density different than 1 and 2	

In order to qualify as a separate condition based on density, there MUST be a distinct, easily observed change in the density of an area's tree cover or basal area.

Examples of valid contrasting conditions defined by differences in tree density are:

1. The eastern half of an otherwise homogeneous, 20 acre stand has many trees killed by a bark beetle outbreak,
2. One portion of a stand is partially cut over (with 40 square feet basal area per acre) while the other portion is undisturbed (with 100 square feet basal area per acre).

NOTE: In these examples, RESERVED STATUS, OWNER GROUP, FOREST TYPE, STAND SIZE CLASS, and REGENERATION STATUS are the same.

## 4.6 NON-DELINEATING VARIABLES FOR ACCESSIBLE FOREST LAND

### 4.6.1 Current Ground Land Class (PNW)

Record the 3-digit code that corresponds to the best Ground Land Class (GLC) description listed below.

When collected:	All accessible forest land condition classes (CONDITION CLASS STATUS = 1)		
Field width:	3 digits		
Tolerance:	No error		
Values:	Code	GLC	Description
	120	Timberland	Forest land which is potentially capable of producing at least 20 cubic feet/acre/year at culmination in fully stocked, natural stands (1.4 cubic meters/hectares/year) of continuous crops of trees to industrial roundwood size and quality. Industrial roundwood requires species that grow to size and quality adequate to produce lumber and other manufactured products (exclude fence posts and fuel wood which are not considered manufactured). Timberland is characterized by no severe limitations on artificial or natural restocking with species capable of producing industrial roundwood.
	141	Other forest-rocky	Other forest land which can produce tree species of industrial roundwood size and quality, but which is unmanageable because the site is steep, hazardous, and rocky, or is predominantly nonstockable rock or bedrock, with trees growing in cracks and pockets. Other forest-rocky sites may be incapable of growing continuous crops due to inability to obtain adequate regeneration success.
	142	Other forest-unsuitable site (wetland, subalpine or coastal conifer scrub)  (CA Only)	Other forest land which is unsuited for growing industrial roundwood because of one of the following environment factors: willow bogs, spruce bogs, sites with high water tables or even standing water for a portion of the year, and harsh sites due to extreme climatic and soil conditions. Trees present are often extremely slow growing and deformed. Examples: whitebark pine, lodgepole, or mountain hemlock stands at timberline; shore pine along the sparkling blue Pacific Ocean (Monterey, Bishop, and Douglas-Fir); willow wetlands with occasional cottonwoods present; Sitka spruce-shrub communities bordering tidal flats and channels along the coast. Includes aspen stands in high-desert areas or areas where juniper/mountain mahogany are the predominate species.
	143	Other forest-pinyon-juniper	Areas currently capable of 10 percent or more tree stocking with forest trees, with juniper species predominating. These areas are not now, and show no evidence of ever having been, 10 percent or more stocked with trees of industrial roundwood form and quality. Stocking capabilities indicated by live juniper trees or juniper stumps and juniper snags less than 25 years dead or cut. Ten percent juniper stocking means 10 percent crown cover at stand maturity. For western woodland juniper species (see Appendix 9), ten percent stocking means 5 percent crown cover at stand maturity.
	144	Other forest-oak (formally oak woodland)	Areas currently 10 percent or more stocked with forest trees, with low quality forest trees of oak, gray pine, madrone, or other hardwood species predominating, and which are not now, and show no evidence of ever having been, 10 percent or more stocked with trees of industrial roundwood form and quality. Trees on these sites are usually short, slow growing, gnarled, poorly formed, and generally suitable only for fuel wood. The following types are included: blue oak, white oak, live oak, oak-gray pine.

146	Other forest-unsuitable site (OR & WA Only)	Other forest land which is unsuited for growing industrial roundwood because of one of the following environment factors: willow bogs, spruce bogs, sites with high water tables or even standing water for a portion of the year, and harsh sites due to climatic conditions. Trees present are often extremely slow growing and deformed. Examples: whitebark pine or mountain hemlock stands at timberline, shore pine along the Pacific Ocean, willow wetlands with occasional cottonwoods present, and sitka spruce-shrub communities bordering tidal flats and channels along the coast. Aspen stands in high-desert areas or areas where juniper/mountain mahogany are the predominate species are considered other forest-unsuitable site.
148	Other forest-Cypress (CA Only)	Forest land with forest trees with cypress predominating. Shows no evidence of having had 10 percent or more cover of trees of industrial roundwood quality and species.
149	Other forest-Low Productivity (this code will be calculated in the office; field crews should never use this code)	Forestland capable of growing crops of trees to industrial roundwood quality, but not able to grow wood at the rate of 20 cubic feet/acre/year. Included are areas of low stocking potential and/or very low site index.
150	Other forest-curlleaf mountain mahogany	Areas currently capable of 10 % or more tree stocking with forest trees, with curlleaf mountain mahogany species predominating. These areas are not now, and show no evidence of ever having been, 10 % or more stocked with trees of industrial roundwood form and quality. 10 % mahogany stocking means 5 % crown cover at stand maturity (See Appendix 9 for western woodland species.)

**4.6.2 OWNER CLASS (CORE OPTIONAL 2.5.7)**

Record the OWNER CLASS code that best corresponds to the ownership (or the managing agency for public lands) of the land in the condition class. Conditions will NOT be delineated based on changes in owner class. If multiple owner classes within an OWNER GROUP occur on a single condition class, record the owner class closest to the plot center.

Owner class is [downloaded/printed] for condition class 1, and indicates the owner classification collected in the county courthouse for subplot 1 center (the pinpricked field grid location). Update this code for condition class 1 if incorrect. Previous owner class is found on the last survey plot card. If the difference is due to a real change in ownership since last field visit, record the date of the ownership change, if known, make a note on the plot jacket. A change in owner does not necessarily mean that owner class changed. For example, if Tubafore Lumber Co. was the owner at the previous visit but sold the site to Big Stick Wood Products, the owner class remained private.

When collected:	When collected: All accessible forest land and non-forest condition classes (CONDITION CLASS STATUS > = 1), and on all non-forest chaparral condition classes (PRESENT NONFOREST LAND USE = 45)	
Field width:	3 digits	
Tolerance:	No errors	
Values:	Owner Classes within Forest Service lands (Owner Group 10): 11 National Forest not included in the following: 104 Idaho Panhandle National Forest      602 Fremont National Forest 417 Toiyabe National Forest                      603 Gifford Pinchot National Forest 501 Angeles National Forest                      604 Malheur National Forest 502 Cleveland National Forest                      605 Mt. Baker Snoqualmie National Forest 503 Eldorado National Forest                      606 Mt. Hood National Forest 504 Inyo National Forest                              607 Ochoco National Forest 505 Klamath National Forest                      608 Okanogan National Forest 506 Lassen National Forest                      609 Olympic National Forest 507 Los Padres National Forest                      610 Rogue River National Forest 508 Mendocino National Forest                      611 Siskiyou National Forest	

	509	Modoc National Forest	612	Siuslaw National Forest
	510	Six Rivers National Forest	614	Umatilla National Forest
	511	Plumas National Forest	615	Umpqua National Forest
	512	San Bernardino National Forest	616	Wallowa-Whitman Nat. Forest
	513	Sequoia National Forest	617	Wenatchee National Forest
	514	Shasta-Trinity National Forest	618	Willamette National Forest
	515	Sierra National Forest	620	Winema National Forest
	516	Stanislaus National Forest	621	Colville National Forest
	517	Tahoe National Forest	622	Columbia River Gorge NSA
	519	Lake Tahoe Basin Mgmt. Unit	650	Crooked River National Grassland
	601	Deschutes National Forest		
	12	National Grassland		
	13	Other Forest Service		
	Owner Classes within Other Federal lands (Owner Group 20)			
	21	National Park Service		
	22	Bureau of Land Management		
	23	Fish and Wildlife Service		
	24	Departments of Defense/Energy		
	25	Other Federal		
	Owner Classes within State and Local Government lands (Owner Group 30)			
	31	State		
	32	Local (County, Municipality, etc.)		
	33	Other Non Federal Public		
	Owner Classes within Private lands (Owner Group 40)			
	41	Corporate		
	42	Non Governmental Conservation / Natural Resources Organization - examples: Nature Conservancy, National Trust for Private Lands, Pacific Forest Trust, Boy Scouts of America, etc.		
	43	Unincorporated Partnerships / Associations / Clubs – examples: Hunting Clubs that own, not lease property, recreation associations, 4H, etc.		
	44	Native American (Indian) within reservation boundaries		
	45	Individual		

#### 4.6.3 PRIVATE OWNER INDUSTRIAL STATUS (CORE 2.5.8)

Record the code identifying the status of the owner with regard to being considered industrial as determined by whether or not they own and operate a primary wood processing plant. A primary wood processing plant is any commercial operation, which originates the primary processing of wood on a regular and continuing basis. Examples include: pulp or paper mill, sawmill, panel board mill, post or pole mill, etc. Cabinet shops, “mom & pop” home-operated businesses, etc., should not be considered as industrial plants. If any doubt exists with the determination by the field crew about the owner’s industrial status due to name, commercial plant size, type plant, etc., choose code 0.

NOTE: FIA unit or State headquarters may have to maintain a list of recognized industrial owners within a State for crews to use when making these determinations.

When collected:	All accessible forest land condition classes (CONDITION CLASS STATUS = 1) when the owner group is private (OWNER GROUP 40)
Field width:	1 digit
Tolerance:	No errors
Values:	0 Land is not owned by industrial owner with a wood processing plant 1 Land is owned by industrial owner with wood processing plant

#### 4.6.4 ARTIFICIAL REGENERATION SPECIES (CORE 2.5.9)

Record the species code of the predominant tree species for which evidence exists of artificial regeneration in the stand (REGENERATION STATUS (4.5.5) is coded "1"). This attribute is ancillary; that is, contrasting condition classes are never delineated based on variation in this attribute.

When collected:	All accessible forest land condition classes (CONDITION CLASS STATUS = 1) with evidence of artificial regeneration (REGENERATION STATUS = 1)
Field width:	4 digits
Tolerance:	No errors
Values:	See Appendix 9 species list

#### 4.6.5 STAND AGE (CORE 2.5.10)

Record the average total age, to the nearest year, of the trees (plurality of all live trees not overtopped) in the predominant STAND SIZE CLASS of the condition, determined using local procedures. Record 000 for non-stocked stands.

An estimate of STAND AGE is required for every forest land condition class defined on a plot. Stand age is usually highly correlated with stand size and should reflect the average age of all trees that are not overtopped. Unlike the procedure for site tree age (tree age at diameter), estimates of stand age should estimate the time of tree establishment (e.g., not age at the point of diameter measurement). Note: For planted stands, estimate age based on the year the stand was planted (e.g., do not add in the age of the planting stock).

To estimate STAND AGE, select two or three dominant or codominant trees from the overstory. If the overstory covers a wide range of tree sizes and species, try to select the trees accordingly, but it is not necessary to core additional trees in such stands. The variance associated with mean stand age increases with stand heterogeneity, and additional cores are not likely to improve the estimate. Core each tree at the point of diameter measurement and count the rings between the outside edge and the core to the pith. Add in the number of years that passed from germination until the tree reached the point of core extraction to determine the total age of the tree.

The field crew should use their best judgment in estimating a stand age by taking the average total age of the predominate overstory trees in the stand.

In some cases, it may be possible to avoid coring trees to determine age. If a stand has not been seriously disturbed since the previous survey, simply add the number of years since the previous inventory to the previous STAND AGE. In other situations, cores collected from site trees can be used to estimate STAND AGE.

If a condition class is non-stocked, assign a STAND AGE of 000.

If all of the trees in a condition class are of a species, which, by regional standards, cannot be bored for age (e.g., mountain mahogany, tupelo) record 998. This code should be used in these cases only.

If an accurate estimated age can be determined for hardwoods not bored, then use that estimated age in figuring overall stand age.

If tree cores are not counted in the field, but are collected and sent to the office for the counting of rings, record 999. Note on the core the % of stand that type of core represents so that STAND AGE can be calculated later.

When collected:	All accessible forest land condition classes (CONDITION CLASS STATUS = 1)
Field width:	3 digits
Tolerance:	+/- 10%
Values:	000 to 997, 998, 999

General guide for converting BH age to total age for PNW species. Adjust as needed due to site variation and observed growth rates.

Species/location	Number of years to add to BH age
west side conifers	5
west side hardwoods	4
east side conifers	8
east side hardwoods	5

**4.6.6 Stand Structure (PNW)**

Record one of the following codes that best represents the overall structure of the stand.

When collected:	All accessible forest land condition classes (CONDITION CLASS STATUS = 1)		
Field width:	1 digit		
Tolerance:	No error		
Values:	Code	Stand Structure	Description
	1	Even-aged single-storied	A single even canopy characterizes the stand. The greatest numbers of trees are in a height class represented by the average height of the stand; there are substantially fewer trees in height classes above and below this mean. The smaller trees are usually tall spindly members that have fallen behind their associates. The ages of the trees usually do not differ by more than 20 years.
	2	Even-aged two-storied	Stands composed of two distinct canopy layers, such as, an overstory with an understory sapling layer possibly from seed tree and shelterwood operations. This may also be true in older plantations where shade-tolerant trees may become established. Two relatively even canopy levels can be recognized in the stand. Understory or overtopped trees are common. Neither canopy level is necessarily continuous or closed, but both canopy levels tend to be uniformly distributed across the stand. The average age of each level differs significantly from the other.
	3	Uneven-aged	Theoretically, these stands contain trees of every age on a continuum from seedlings to mature canopy trees. In practice, uneven-aged stands are characterized by a broken or uneven canopy layer. Usually the largest number of trees is in the smaller diameter classes. As trees increase in diameter, their numbers diminish throughout the stand. Many times, instead of producing a negative exponential distribution of diminishing larger diameters, uneven-aged stands behave irregularly with waves of reproduction and mortality. Consider any stand with 3 or more structural layers as uneven-aged. Logging disturbances (examples are selection, diameter limit, and salvage cutting) will give a stand an uneven-aged structure.
	4	Mosaic	At least two distinct size classes are represented and these are not uniformly distributed but are grouped in small repeating aggregations, or occur as stringers less than 120 feet wide, throughout the stand. Each size class aggregation is too small to be recognized and mapped as an individual stand. The aggregations may or may not be even-aged.

**4.6.7 DISTURBANCE 1 (CORE 2.5.11)**

Record the code corresponding to the presence of the following disturbances. Disturbance can connote positive or negative effects. The area affected by any natural or human-caused disturbance must be at least 1.0 acre in size. Record up to three different disturbances per condition class from most important to least important as best as can be determined. This attribute is ancillary; that is, contrasting conditions are never delineated based on variation in this attribute.

For initial forest plot establishment (initial grid activation of *the annual inventory* or newly forested plots), the disturbance must be within the last 5 years (*since January 1, 2002*). For remeasured plots (*SAMPLE KIND = 2*) recognize only those disturbances that have occurred since the previous inventory (*of the 4-subplot design*).

The following disturbance codes require "significant threshold" damage, which implies mortality and/or damage to 25 percent of all trees in a stand or 50 percent of an individual species' count. Additionally, some disturbances affect forests but initially may not affect tree growth or health (e.g., grazing, browsing, flooding, etc.). In these cases, a disturbance should be coded when at least 25 percent of the soil surface or understory vegetation has been affected.

Code the general disturbance codes (i.e. 10, 20, 30, ...) only if one of the more specific codes (i.e. 41, 42, ..) does not apply. When coding fire (30), it is important to distinguish ground fire (31) from crown fire (32) where possible. Note: Null is erroneous for this variable. Code 00 if no disturbance is observed.

When collected:	All accessible forest land condition classes (CONDITION CLASS STATUS = 1)		
Field width:	2 digits		
Tolerance:	No errors		
Values:	Code	Disturbance	Definition
	00	None	No observable disturbance.
	10	Insect damage	
	11		Insect damage to understory vegetation
	12		Insect damage to trees, including seedlings and saplings
	20	Disease damage	
	21		Disease damage to understory vegetation
	22		Disease damage to trees, including seedlings and saplings
	30	Fire	Crown or ground fire, prescribed or natural
	31	Ground fire	
	32	Crown fire	
	40	Animal damage	
	41	Beaver	Includes flooding caused by beaver
	42	Porcupine	
	43	Deer/ungulate	
	44	Bear (CORE OPTIONAL)	
	45	Rabbit (CORE OPTIONAL)	
	46	Domestic animal or livestock	Includes grazing
	50	Weather	
	51	Ice	
	52	Wind	Includes hurricane, tornado
	53	Flooding	Weather induced
	54	Drought	
	55	Earth movement / avalanches	
	60	Vegetation	Suppression, competition, vines
70	Unknown / unsure / other	Describe in PLOT NOTES	
80	Human caused damage	Any significant threshold of human damage, not described in the DISTURBANCE codes listed or in the TREATMENT codes listed. Must include plot-level note to describe further.	
91	Landslide		
92	Avalanche track		
93	Volcanic blast zone		
94	Other geologic event		

**4.6.8 DISTURBANCE YEAR 1 (CORE 2.5.12)**

Record the year in which DISTURBANCE 1 occurred. If the disturbance occurs continuously over a period of time, record 9999.

When collected:	When DISTURBANCE 1 > 00
Field width:	4 digits
Tolerance:	+/- 1 year for measurement cycles of 5 years +/- 2 years for measurement cycles of > 5 years
Values:	Since the previous plot visit, or the past 5 years for plots visited for the first time

**4.6.9 DISTURBANCE 2 (CORE 2.5.13)**

If a stand has experienced more than one disturbance, record the second disturbance here. See DISTURBANCE 1 for coding instructions. Code 00 if no DISTURBANCE 2 is observed.

**4.6.10 DISTURBANCE YEAR 2 (CORE 2.5.14)**

Record the year in which DISTURBANCE 2 occurred. See DISTURBANCE YEAR 1 for coding instructions.

**4.6.11 DISTURBANCE 3 (CORE 2.5.15)**

If a stand has experienced more than two disturbances, record the third disturbance here. See DISTURBANCE 1 for coding instructions. Code 00 if no DISTURBANCE 3 is observed.

**4.6.12 DISTURBANCE YEAR 3 (CORE 2.5.16)**

Record the year in which DISTURBANCE 3 occurred. See DISTURBANCE YEAR 1 for coding instructions.

**4.6.13 Historical Disturbance 1 (PNW)**

Record the corresponding disturbance code for disturbances before the previous Annual inventory field visit, or before the past 5 years if the plot is measured for the first time. If the plot is a remeasurement plot or has been measured previously as a periodic plot, use previous plot write-ups and records as guides to code the important historical disturbances affecting the current stand (including those which originated the stand). Use the same procedures and codes used for DISTURBANCE 1. Note: Null is erroneous for this variable. Code 00 if no historic disturbance is observed.

When collected:	All accessible forest land condition classes (CONDITION CLASS STATUS = 1)
Field width:	2 digits
Tolerance:	No errors
Values:	See Disturbance 1 (4.6.7)

**4.6.14 Historical Disturbance Year 1 (PNW)**

Record the year in which the disturbance occurred. Use the same procedures and codes used for DISTURBANCE YEAR 1.

When collected:	When Historical Disturbance 1 > 00
Field width:	4 digits
Tolerance:	+/- 1 year for measurement cycles of 5 years +/- 2 years for measurement cycles of > 5 years
Values:	Prior to the previous plot visit or > 5 years for plots visited for the first time

**4.6.15 Historical Disturbance 2 (PNW)**

Record the corresponding disturbance code for disturbances before the previous Annual inventory field visit, or before the past 5 years if the plot is measured for the first time. If the plot is a remeasurement plot or has been measured previously as a periodic plot, use previous plot write-ups and records as guides to code the most important historical disturbances affecting the current stand (including those which originated the stand). Use the same procedures and codes used for Historical Disturbance 1 (Section 4.6.13). Code 00 if no historic disturbance is observed.

**4.6.16 Historical Disturbance Year 2 (PNW)**

Record the year in which the disturbance occurred. Use the same procedures and codes used for Historical Disturbance Year 1 (Section 4.6.14).

**4.6.17 Historical Disturbance 3 (PNW)**

Record the corresponding disturbance code for disturbances before the previous Annual inventory field visit, or before the past 5 years if the plot is measured for the first time. If the plot has been measured previously as a periodic plot, use previous plot write-ups and records as guides to code the most important historical disturbances affecting the current stand (including those which originated the stand). Use the same procedures and codes used for Historical Disturbance 1 (Section 4.6.13). Code 00 if no historic disturbance is observed.

**4.6.18 Historical Disturbance Year 3 (PNW)**

Record the year in which the disturbance occurred. Use the same procedures and codes used for Historical Disturbance Year 1 (Section 4.6.14).

**4.6.19 TREATMENT 1 (CORE 2.5.17)**

Forestry treatments are a form of disturbance. These human disturbances are recorded separately here for ease of coding and analysis. The term treatment further implies that a silvicultural application has been prescribed. This does not include occasional stumps of unknown origin or sparse removals for firewood, Christmas trees, or other miscellaneous purposes. The area affected by any treatment must be at least 1.0 acre in size. Record up to three



different treatments per condition class from most important to least important as best as can be determined. This attribute is ancillary; that is, contrasting conditions are never delineated based on variation in this attribute.

For initial forest plot establishment (initial grid activation of *the annual inventory* or newly forested plots), the treatment must be within the last 5 years. For remeasured plots (*SAMPLE KIND = 2*) recognize only those treatments that have occurred since the previous inventory (*of the 4-subplot design*).

Code the general treatment codes (i.e. 10, 20, 30, etc) only if one of the more specific codes (i.e. 11, 12, etc) does not apply. Note: Null is erroneous for this variable. Code 00 if no treatment is observed.

When collected:	All accessible forest land condition classes (CONDITION CLASS STATUS = 1)		
Field width:	2 digits		
Tolerance:	No errors		
Values:	Code	Treatment	Description
	00	None	No observable treatment.
	10	Cutting	The removal of one or more trees from a stand.
	11	Clearcut	Residual trees of all sizes have < 25 percent crown cover. The residual trees usually are cull trees and low-value hardwoods. Not a firewood or local use harvest.
	12	Partial cut (heavy) (>20% removed)	Remaining trees comprise > 25 percent crown cover and >20 percent of the trees live and 5.0 inches DBH/DRC or larger were harvested. The residual stand usually consists of commercially desirable trees. Not a firewood or local use harvest.
	13	Partial cut (light) (<20% removed)	Remaining trees comprise > 25 percent crown cover and < 20 percent of the trees live and 5.0 inches DBH/DRC or larger were harvested. The residual stand usually consists of commercially desirable trees. Not a firewood or local use harvest.
	14	Firewood or local use cut	The harvest of trees for firewood, or the harvest of trees for products manufactured and used locally by "do-it-yourselfers", often on the ownership of origin, for improvements such as buildings, bridges and fences.
	15	Incidental cut	Includes 1) the haphazard, seemingly random harvest of occasional trees in an otherwise undisturbed stand, or 2) the harvest of one or more trees sampled or reconstructed as live at Oc5 in a harvest activity which occurred primarily in an adjacent unmapped condition class but slopped over a bit into a mapped condition, or 3) any harvest activity that does not qualify as another kind of disturbance.
	16	Precommercial thin	An intermediate harvest in which excess growing stock are cut but not removed.
	17	Improvement cut	Cutting of commercial-sized, unsalable trees to free crop trees from competition. Improvement cutting differs from a commercial thinning in that the trees cut are not marketable.
	20	Site preparation	Clearing, slash burning, chopping, disking, bedding, or other practices clearly intended to prepare a site for either natural or artificial regeneration.
	30	Artificial regeneration	Following a disturbance or treatment (usually cutting), a new stand where at least 50% of the live trees present resulted from planting or direct seeding.
	31	Planting through-out the stand	Planting the area to establish a manageable stand.
	32	Planting within nonstocked holes in the stand	Planting of nonstocked openings to fill-in or create a manageable stand
	33	Underplanting	Planting under a sawtimber overstory.
	40	Natural regeneration	Following a disturbance or treatment (usually cutting), a new stand where at least 50% of the live trees present (of any size) were established through the growth of existing trees and/or natural seeding or sprouting.

	50	Other silvicultural treatment	The use of fertilizers, herbicides, girdling, pruning or other activities ( <i>not already listed above</i> ) designed to improve the commercial value of the residual stand, or chaining, which is a practice used on western woodlands to encourage wildlife forage.
	51	Stand conversion	Killing of low-value or unmarketable trees-often hardwoods-and planting of the area to establish a manageable stand. Most commonly, low-value hardwood stands are converted to conifer stands.
	52	Clean and release	Killing or suppression of undesirable, competing vegetation-usually brush or hardwoods-from a manageable stand. A herbicide treatment in young, regenerated stands is one method of clean and release.
	60	Chaining	Removal or killing of undesired woody species, not a silvicultural treatment.

**4.6.20 TREATMENT YEAR 1 (CORE 2.5.18)**

Record the year in which TREATMENT 1 occurred.

When collected:	When TREATMENT 1 > 00
Field width:	4 digits
Tolerance:	+/- 1 year for measurement cycles of 5 years +/- 2 years for measurement cycles of > 5 years
Values:	Since the previous plot visit, or the past 5 years for plots visited for the first time

**4.6.21 TREATMENT 2 (CORE 2.5.19)**

If a stand has experienced more than one treatment, record the second treatment here. See TREATMENT 1 for coding instructions, code 00 if none.

**4.6.22 TREATMENT YEAR 2 (CORE 2.5.20)**

Record the year in which TREATMENT 2 occurred. See TREATMENT YEAR 1 for coding instructions.

**4.6.23 TREATMENT 3 (CORE 2.5.21)**

If a stand has experienced more than two treatments, record the third treatment here. See TREATMENT 1 for coding instructions, code 00 if none.

**4.6.24 TREATMENT YEAR 3 (CORE 2.5.22)**

Record the year in which TREATMENT 3 occurred. See TREATMENT YEAR 1 for coding instructions.

**4.6.25 Historical Treatment 1 (PNW)**

Record the corresponding treatment that occurred before the previous field visit, or before the past 5 years if the plot is measured for the first time. If the plot has been measured at the previous field visit cycle, use previous plot write-ups and records as guides to code the most important historical treatments affecting the current stand (including those which originated the stand).

When collected:	All accessible forest land condition classes (CONDITION CLASS STATUS = 1)
Field width:	2 digits
Tolerance:	No errors
Values:	Use the same procedures and codes used for TREATMENT 1 (Section 4.6.19)

**4.6.26 Historical Treatment Year 1 (PNW)**

Record the year in which the corresponding treatment occurred. See TREATMENT YEAR 1 for coding instructions.

When collected:	When Historical Treatment 1 > 00
Field width:	4 digits
Tolerance:	+/- 1 year for measurement cycles of 5 years +/- 2 years for measurement cycles of > 5 years
Values:	Prior to the previous plot visit or > 5 years for plots visited for the first time

**4.6.27 Historical Treatment 2 (PNW)**

Record the corresponding treatment that occurred before the previous field visit, or before the past 5 years if the plot is measured for the first time. If the plot has been measured at the previous field visit cycle, use previous plot write-ups and records as guides to code the most important historical treatments affecting the current stand (including those which originated the stand). Use the same procedures and codes used for Historical Treatment 1 (Section 4.6.25)

**4.6.28 Historical Treatment Year 2 (PNW)**

Record the year in which the corresponding treatment occurred. Use the same procedures and codes used for TREATMENT YEAR 1.

**4.6.29 Historical Treatment 3 (PNW)**

Record the corresponding treatment that occurred before the previous field visit, or before the past 5 years if the plot is measured for the first time. If the plot has been measured at the previous field visit cycle, use previous plot write-ups and records as guides to code the most important historical treatments affecting the current stand (including those which originated the stand). Use the same procedures and codes used for TREATMENT 1.

Use the same procedures and codes used for Historical Treatment 1 (Section 4.6.25)

**4.6.30 Historical Treatment Year 3 (PNW)**

Record the year in which the corresponding treatment occurred. Use the same procedures and codes used for DISTURBANCE YEAR 1.

**4.6.31 Evidence of Stumps (PNW)**

Record a “Y” if the condition class has been harvested for wood production in the past or present (any signs of past cutting such as old stumps). Record an “N” if there is no evidence of past cutting or management.

When collected:	All accessible forest land condition classes (CONDITION CLASS STATUS = 1)
Field width:	1 digit
Tolerance:	No errors
Values:	Y, N

**4.6.32 Evidence of Fire (PNW)**

Record a “Y” if the condition class has evidence of a past or present fire occurrence. Record an “N” if there is no evidence of fire.

When collected:	All accessible forest land condition classes (CONDITION CLASS STATUS = 1)
Field width:	1 digit
Tolerance:	No errors
Values:	Y, N

**4.6.33 PHYSIOGRAPHIC CLASS (CORE 2.5.23)**

Record the code that best describes the PHYSIOGRAPHIC CLASS of the condition; land form, topographic position, and soil generally determine physiographic class. *Apply the same coding system used for Macroplot Physiographic Class (Section 5.2.3).*

When collected:	All accessible forest land condition classes (CONDITION CLASS STATUS = 1)
Field width:	2 digits
Tolerance:	No errors
Values:	See Subplot PHYSIOGRAPHIC CLASS (Section 5.2.3)

**4.6.34 Soil Depth (PNW)**

1-digit code downloaded/printed for condition class 1 if recorded in a previous inventory. This item describes soil depth (the depth tree roots can penetrate to) within each forest land condition class. Required for all forest condition classes. Code this item "1" when more than half of area in the condition class is estimated to be less than 20 inches deep. Ground pumice, decomposed granite, and sand all qualify as types of soil. Use clues such as abundance of rock outcrops, root wads, and soil depth on cutbanks to make the estimate.

When collected:	All accessible forest land condition classes (CONDITION CLASS STATUS = 1)
Field width:	1 digit
Tolerance:	No errors
Values:	(1) $\leq$ 20 inches      (2) $>$ 20 inches

#### 4.6.35 Stand Condition/Stage of Development (PNW)

A 1-digit code that best describes the condition of the stand within forest condition classes. Stand condition is defined here as "the size, density, and species composition of a plant community following disturbance and at various time intervals after disturbance." Information on stand condition is used in describing wildlife habitat. The code is downloaded/printed for condition class 1 if recorded at previous field visit. Update this downloaded/printed code if obviously incorrect.

When collect	All accessible forest land condition classes (CONDITION CLASS STATUS = 1)		
Field width:	1 digit		
Tolerance:	No errors		
Values:	Code	Stand Condition	Definition
	0	Not applicable	Condition class is juniper, chaparral, or curleaf mountain mahogany forest type.
	1	Grass-forb	Shrubs less than 40% crown cover and less than 5 feet tall; plot may range from being largely devoid of vegetation to dominance by herbaceous species (grasses and forbs); tree regeneration generally less than 5 feet tall and 40% cover.
	2	Shrub	Shrubs 40% crown canopy or greater, of any height; trees less than 40% crown canopy and less than 1.0 inches DBH/DRC. When average stand diameter exceeds 1.0 inches DBH/DRC, plot is "open sapling" or "closed sapling."
	3	Open sapling-poletimber	Average stand diameter 1.0-8.9 inches DBH/DRC, and tree crown canopy poletimber is less than 60%.
	4	Closed sapling, pole, sawtimber	Average stand diameter is 1.0-21.0 inches DBH/DRC and crown cover is 60% or greater.
	5	Open sawtimber	Average stand diameter is 9.0-21.0 inches DBH/DRC, and crown cover is less than 60%.
	6	Large sawtimber	Average stand diameter exceeds 21.0 inches DBH/DRC; crown cover may be less than 100%; decay and decadence required for old-growth characteristics is generally lacking, successional trees required by old-growth may be lacking, and dead and down material required by old-growth is lacking.
	7	Old-growth	Average stand diameter exceeds 21.0 inches DBH/DRC. Stands over 200 years old with at least two tree layers (overstory and understory), decay in living trees, snags, and down woody material. Some of the overstory layer may be composed of long-lived successional species (i.e. Douglas-fir, western redcedar).

#### 4.6.36 Plant Association (PNW)

Plant associations describe the climax or mature, plant community on a site based on the combined abundance of all vascular plant species (trees, shrubs, and forbs). They are used to infer climate conditions and link plots to other information on suitability for management, productivity, and habitat.

**Oregon, Washington, and R6 NFS (Klamath NF and Rogue River NF) lands in California:** most of the lands in this area have plant association guides applicable to forested lands (see maps in Appendix 3 for which guides to use where). Some areas on R6 NFS lands also have non-forest plant associations available (e.g., the Oregon Dunes and the Pumice Zone). In these areas, the plant association code is a 6-digit code that describes the predominant plant association of the site. The first 2 digits describe the series, defined by the climax (most shade-tolerant) tree species found in the reproduction layer, the third and fourth digits relate to the dominant lifeform in the understory (e.g. shrub, forb, or grass) and the fifth and sixth digits relate to understory vegetation composition. The code is downloaded/printed for condition class 1 if recorded at the previous visit. If the downloaded code is a 4-letter code, it should be updated to the full 6-letter association if at all possible. If no guide exists to cover the area a

plot is in, or if a stand is too young (<30 yrs old) or too disturbed to determine the full plant association, keep the previous 4-letter code if available or record the first 2 digits of the plant association series from the table below.

<b>Code</b>	<b>Plant Community Association</b>
CA	Sub-alpine fir, mountain hemlock, whitebark pine (open forest)
CC	Western redcedar
CD	Douglas-fir
CS	Sitka spruce
CE	Sub-alpine fir, Englemann spruce (closed forest)
CF	Silver fir, noble fir
CH	Western hemlock
CJ	Juniper, pinyon pine
CL	Lodge pole pine (climax or seral)
CM	Mountain hemlock
CP	Ponderosa, Jeffrey pine
CW	White fir, grand fir
CX	Coniferous forest
HX	Hardwood forest
HA	Alder
HB	Bigleaf maple
HC	Cottonwood, ash bottomland, overflow bottomland
HO	Oregon white oak
HQ	Quaking Aspen
HT	Tanoak

**R5 NFS land in California, not R6 NFS:** In forested and nonforested areas in Region 5 in California that are covered by regional or forest-type specific plant association guides (see Appendix 3), enter the appropriate code in the guide that describes the vegetation on the plot. If no guide is available for the region, then no Plant Association is needed.

When collected:	All accessible forest and nonforest condition classes, (CONDITION CLASS STATUS = 1 and OWNER GROUP for Condition Class 1 = 10 when STATE = 06 (California), 41 (Oregon) or 53 (Washington), and plant association guides are available, Also, All accessible forest condition classes off NFS land when STATE = 41 or 53, and plant association guides are available..
Field width:	6 digits Washington and Oregon, 8 digits California
Tolerance:	No errors
Values:	Specific for each guide. See Appendix 3: Plant Associations

#### 4.6.37 Mixed Conifer Site (PNW-CA)

This variable is collected in California only. Record a 1-character code indicating if the condition class is a mixed conifer site. To classify as a mixed conifer site the condition class must be capable of being stocked with greater than 70% conifers and one of the following must be true:

1. Douglas-fir predominates and the County is NOT Del Norte (015), Humbolt (023), Marin (041), Mendocino (045), Napa (055), San Mateo (081), Santa Clara (085), Santa Cruz (087), or Sonoma (097).
2. Sugar pine (117) or incense-cedar (081) predominates.
3. Ponderosa pine (122) and/or Jeffery pine (116) either singly or in combination predominate but make up less than 80% of the conifer stocking.
4. White fir (015), and/or red fir (020) and/or Shasta red fir (021) either singly or in combination predominate, but make up less than 80% of the conifer stocking.

On a mixed conifer site a complex association of ponderosa pine, sugar pine, Douglas-fir, white fir and red fir may exist. Incense-cedar may also be a component. Generally these five or six conifer species are intermixed either as single trees or in small groups. Vertical mixing is also common with one to three species in the overstory and one or two species in the understory. Mixed conifer sites are often on east facing slopes of the Coast Range, and on the west facing and higher elevation east facing slopes of the Cascade and Sierra Nevada Mountains.

When collected.:	All accessible forest land condition classes (CONDITION CLASS STATUS = 1) when STATE = 6 (CA)
Field width:	1 digit
Tolerance:	No errors
Values:	Y, N

#### 4.6.38 Stockability Indicator Set (PNW)

A 1-digit code showing which plant indicator list (Set 1 or 2) is associated with an accessible forest land condition class in Douglas, Jackson, or Josephine counties in Oregon and in any of seven Eco Units in California. Record a Stockability Indicator Set Number for each accessible forest land condition class mapped at each subplot/macropoint in these areas. Usually one set of indicators is sufficient on a plot and all forested condition classes will use Set 1. Occasionally a condition class change is also a change in stocking limitations. If so, an additional set of indicators (Set 2) will be collected and each condition class will be assigned one of the two sets. See Section 9.5 for related instructions.

Many forest sites in southwestern Oregon and in parts of California are incapable of supporting the number of trees ordinarily associated with full utilization of growing space. These limitations are due to inherent environmental problems such as poor water-holding properties of the soil or toxic soils. The presence of certain plants and physical conditions correlate well with the presence of these limitations and can be used to estimate the extent of the limitation. The presence of indicator plants and key physical indicators are collected, using check-off lists (see Section 9.5).

When collected:	All accessible forest land condition classes (CONDITION CLASS STATUS = 1), -- in Oregon (STATE = 41) when COUNTY=19, 29, or 33 -- in California (STATE = 06) when the plot is in one of the seven Eco Units listed in Section 9.5.3 Stockability Indicators for California. This is also displayed on the PDR.
Field width:	1 digit
Tolerance:	No errors
Values:	1, 2

## 4.7 NON-FOREST LANDS: DELINEATING CONDITION CLASS

Determining condition classes on nonforest land:

Nonforest land (Condition class status = 2) is subdivided into condition classes that are based on differences in the following nonforest land uses:

### 4.7.1 PRESENT NON-FOREST LAND USE (CORE OPTIONAL 2.5.24)

Record the Present Nonforest Land Use for all nonforest conditions (Condition class status 2), regardless of past condition. *Use the codes and classifications listed below.*

On all visited plots with an accessible forest land condition class, map nonforest land condition classes present on the 58.9-foot fixed-radius at each subplot on the 4-subplot standard layout.

If a subplot has an accessible forest land condition class present within the 58.9 ft radius, map each nonforest land condition class present. Do not combine nonforest condition classes. Example: if nonforest-urban land and nonforest-cropland are both present within a 58.9-foot fixed-radius plot, map each land class as a separate condition class.

If there are no accessible forest land condition classes present within a macropoint's 58.9 ft radius, record only the nonforest condition class present at the subplot center. Do not separate nonforest condition classes. Example: if nonforest-urban land and nonforest-cropland are both present within a 58.9-foot fixed-radius macropoint, record only the condition class which occupies the subplot center. An exception, always delineate any Census Water and/or Not in the Sample

See CONDITION CLASS STATUS 2-Nonforest (Section 4.2-2) for information on plots that are entirely nonforest.

Annual Inventory 2007, Chapter 4: Condition Class

See Appendix A1.2 for instructions on mapping and measuring nonforest condition classes on R5 and R6 National Forests.

When collected:	All nonforest land condition classes (CONDITION CLASS STATUS = 2)
Field width:	2 digits
Tolerance:	No errors
Values:	<p>10 <u>Agricultural land</u> – Land managed for crops, pasture, or other agricultural use; the area must be at least 1.0 acre in size and 120.0 feet wide. Use code 10 only for cases not better described by one of the following</p> <ul style="list-style-type: none"> <li>11 <u>Cropland</u>: i.e. mint, wheat, rye, corn, planted berry fields</li> <li>12 <u>Pasture</u>: Improved through cultural practices <i>such as grading and mowing</i></li> <li>13 <u>Idle farmland</u></li> <li>14 <u>Orchard</u></li> <li>15 Christmas tree plantation</li> </ul> <p>20 <u>Rangeland</u> -- Land primarily composed of grasses, forbs, or shrubs. This includes lands vegetated naturally or artificially to provide a plant cover managed like native vegetation and does not meet the definition of pasture. The area must be at least 1.0 acre in size and 120.0 feet wide</p> <p>30 <u>Developed</u> -- Land used primarily by humans for purposes other than forestry or agriculture. Use the code 30 only for land not better described by one of the following:</p> <ul style="list-style-type: none"> <li>31 <u>Cultural or Urban</u>: Business, residential, and other places of intense human activity</li> <li>32 <u>Rights-of-way</u>: Improved roads, railway, power lines, maintained canal</li> <li>33 <u>Recreation</u>: Parks, skiing, golf courses</li> </ul> <p>40 <u>Other</u> -- Land parcels greater than 1.0 acre in size and greater than 120.0 feet wide, that do not fall into one of the uses described above or below. Examples include undeveloped beaches, barren land (rock, sand), noncensus water, marshes, bogs, ice, and snow. Use the code 40 only for land not better described by the following:</p> <ul style="list-style-type: none"> <li>41 <u>Naturally nonvegetated</u>: Barren rock, sand, lava, glaciers</li> <li>45 <u>Nonforest-chaparral</u>: Areas covered with heavily branched dwarfed trees or shrubs, usually evergreen, the crown canopy of which currently covers greater than 10 percent of the ground. The principal species are dwarf Quercus, Cercocarpus, Garrya, Ceanothus, Arctostaphylos, Baccharis, and Adenostoma. Areas in which the predominate cover is Artemisia, Purshia, Gutierrezia, Opuntia, or semi-desert species are considered RANGELAND.</li> </ul>





## 5 SUBPLOT ATTRIBUTES

### TABLE OF CONTENTS

<b>5</b>	<b>SUBPLOT ATTRIBUTES.....</b>	<b>69</b>
<b>5.1</b>	<b>SUBPLOT IDENTIFICATION.....</b>	<b>71</b>
5.1.1	SUBPLOT NUMBER (CORE 3.1).....	71
5.1.2	SUBPLOT/MACROPLOT STATUS (CORE 3.2).....	71
5.1.3	SUBPLOT/MACROPLOT NONSAMPLED REASON (CORE 3.3).....	72
5.1.4	SUBPLOT/MACROPLOT CONDITION LIST (CORE OPTIONAL 3.9).....	72
5.1.5	SUBPLOT CENTER CONDITION (CORE 3.4).....	73
<b>5.2</b>	<b>PHYSIOGRAPHIC CLASS INFORMATION.....</b>	<b>73</b>
5.2.1	SUBPLOT ASPECT (CORE 3.7).....	73
5.2.2	SUBPLOT SLOPE (CORE 3.6).....	73
5.2.3	<i>Macroplot</i> Physiographic Class (PNW).....	74
<b>5.3</b>	<b>WATER INFORMATION.....</b>	<b>75</b>
5.3.1	WATER ON <i>MACROPLOT</i> (CORE 1.13).....	75
5.3.2	Water Proximity (PNW).....	75
5.3.3	SNOW/WATER DEPTH (CORE 3.8).....	76
<b>5.4</b>	<b>MICROPLOT ATTRIBUTES.....</b>	<b>76</b>
5.4.1	MICROPLOT CENTER CONDITION (CORE 3.5).....	76
	MICROPLOT SEEDLING COUNT.....	76
5.4.2	SUBPLOT NUMBER (CORE 6.1).....	76
5.4.3	CONDITION CLASS NUMBER (CORE 6.3).....	76
5.4.4	SPECIES (CORE 6.2).....	76
5.4.5	SEEDLING COUNT (CORE 6.4).....	76
	FUEL LOADING ON THE MICROPLOT.....	77
5.4.6	Fuel Loading: Subplot Number (PNW).....	77
5.4.7	Fuel Loading: Live Shrub Percent Cover (PNW).....	78
5.4.8	Fuel Loading: Live Shrub Height (PNW).....	78
5.4.9	Fuel Loading: Dead Shrubs Percent Cover (PNW).....	78
5.4.10	Fuel Loading: Dead Shrubs Height (PNW).....	78
5.4.11	Fuel Loading: Live Herbs Percent Cover (PNW).....	79
5.4.12	Fuel Loading: Live Herbs Height (PNW).....	79
5.4.13	Fuel Loading: Dead Herbs Percent Cover (PNW).....	79
5.4.14	Fuel Loading: Dead Herbs Height (PNW).....	79
5.4.15	Fuel Loading: Litter Percent Cover (PNW).....	79
<b>5.5</b>	<b>BOUNDARY REFERENCE MAPPING.....</b>	<b>80</b>
	REFERENCE PROCEDURES.....	80
	BOUNDARY DATA.....	81
5.5.1	SUBPLOT NUMBER (CORE 4.2.1).....	81
5.5.2	PLOT TYPE (CORE 4.2.2).....	81
5.5.3	CONTRASTING CONDITION (CORE 4.2.4).....	81
5.5.4	LEFT AZIMUTH (CORE 4.2.5).....	81
5.5.5	CORNER AZIMUTH (CORE 4.2.6).....	82
5.5.6	CORNER DISTANCE (CORE 4.2.7).....	82
5.5.7	RIGHT AZIMUTH (CORE 4.2.8).....	82
5.5.8	BOUNDARY CHANGE (CORE 4.2.3).....	82
	HECTARE PLOT MAPPING.....	82
	BOUNDARY MAPPING EXAMPLES.....	83

<b>5.6</b>	<b>SUBPLOT/MACROPLOT NON-FOREST INCLUSIONS .....</b>	<b>84</b>
5.6.1	Non-forest Inclusions: Mapping and Recording (PNW).....	84
	DOWNLOADED ESTIMATES OF NONFOREST INCLUSIONS .....	85
	EXAMPLES OF NONFOREST INCLUSIONS .....	85
	ESTIMATING NONFOREST INCLUSION AREA PERCENTAGES BY CONDITION CLASS.....	86
<b>5.7</b>	<b>ROOT DISEASE MAPPING/RATING .....</b>	<b>87</b>
5.7.1	Root Disease Mapping and Recording (PNW).....	87
	DOWNLOADED ESTIMATES OF ROOT DISEASE.....	87
	MAPPING ROOT DISEASE .....	87
	GUIDE FOR IDENTIFYING ROOT DISEASE .....	89
	ESTIMATING ROOT DISEASE AREA PERCENTAGES BY CONDITION CLASS.....	89
5.7.2	Root Disease Severity Rating (PNW).....	89
<b>5.8</b>	<b>SUBPLOT DISTURBANCE .....</b>	<b>90</b>
5.8.1	Burn Assessment (PNW).....	90
5.8.2	Mechanical Management Assessment (PNW).....	90

## Chapter 5: SUBPLOT ATTRIBUTES

This and the following chapters describe important attributes measured on each subplot or the associated microplot or macroplot. Chapter 5 describes information about the physical setting of the subplot and the presence and location of contrasting land types on the subplot, as well as some microplot attributes. This information is used for a variety of topics, including: calculating accurate area estimates of land types and their associated forest information (e.g. tree volume, disease), identifying potential limits to management (e.g. topography), and relating physical site features to forest composition and productivity. Other attributes referenced to each subplot include Down Woody Materials (Chapter 6), Live and Standing Dead Tree Tally (Chapter 7), Vegetation Profile (Chapter 8), and Site Index (Chapter 9).

Plots will be established according to the regional guidelines of each FIA unit. When the crew cannot occupy the plot center because safety hazards exist, or the plot center is inaccessible or out of the sample, the crew should check the other subplots. If any subplot centers can be occupied and are in the sample, the subplots that can be occupied should be established and sampled following normal procedures. When a subplot center or microplot center cannot be occupied, no data will be collected from that subplot or microplot; instead, the entire subplot or microplot should be classified according to the condition preventing occupancy.

The following table will assist in locating subplot 2-4 from a subplot other than subplot 1.

Subplot From	Numbers To	Azimuth degrees	Backsight	Distance feet
2	3	150	330	207.8
2	4	210	030	207.8
3	4	270	090	207.8

If a subplot was installed at an incorrect location at the previous visit, the current crew should remeasure the subplot in its present location and document the discrepancy in plot notes. In cases where individual subplots are lost (cannot be relocated), reinstall the subplot at the appropriate location and use the following procedures:

- assign the appropriate present CONDITION CLASS STATUS Code(s) to the new subplot (usually CONDITION CLASS STATUS = 1 or 2)
- assign TREE STATUS = 0 to all downloaded trees (i.e., incorrectly tallied at the previous survey). Exception: If the subplot was lost due to a major disturbance and no trees are standing where the subplot was expected to be found, then assign TREE STATUS = 3 and explain in PLOT NOTES.
- assign RECONCILE codes 3 or 4 (i.e., missed live or missed dead) to all trees on the new subplot.
- The next TREE RECORD NUMBER will be assigned by the PDR.

See Appendix 1 for special rules about nonforest plots/condition classes on R5 and R6 NFS lands.

### 5.1 SUBPLOT IDENTIFICATION

Each subplot is described by a series of area parameters relating to topographic features and existing cover type. These data also relate to the microplot, since the microplot is contained within the subplot perimeter.

#### 5.1.1 SUBPLOT NUMBER (CORE 3.1)

Record a 2-digit code for each subplot that is assessed at the current visit. The second digit is the subplot. At this inventory the first digit is "N" (this is referred to as an "N#" subplot). Other first digit codes (#, C, or R) may be valid for other inventories. See Section 2.4 for instructions regarding subplot numbering. See plot layout diagram in Section 1.5.

When collected:	All established subplots
Field width:	2 digits
Tolerance:	No errors
Values:	N1 Center subplot N2 North subplot N3 Southeast subplot N4 Southwest subplot

#### 5.1.2 SUBPLOT/MACROPLOT STATUS (CORE 3.2)

Indicate whether or not this macroplot currently has at least one accessible forested condition class.

When collected:	All subplots
Field width:	1 digit
Tolerance:	No errors
Values:	1 Sampled – at least one accessible forest land condition present on macroplot 2 Sampled – no accessible forest land condition present on macroplot 3 Nonsampled

### 5.1.3 SUBPLOT/MACROPLOT NONSAMPLED REASON (CORE 3.3)

For entire macroplots that cannot be sampled, record one of the following reasons.

When collected:	When SUBPLOT/MACROPLOT STATUS = 3	
Field width:	2 digits	
Tolerance:	No errors	
Values:	Code	Nonsampled Reason
	01	Outside U.S. boundary – Assign this code to condition classes beyond the U.S. border.
	02	Denied access area – Any area within the sampled area of a plot to which access is denied by the legal owner, or to which an owner of the only reasonable route to the plot denies access. There are no minimum area or width requirements for a condition class delineated by denied access. Because a denied-access condition can become accessible in the future, it remains in the sample and is re-examined at the next occasion to determine if access is available. In some regions denied access plots may be replaced; check with the field supervisor regarding regional protocols for plot replacement.
	03	Hazardous situation – Any area within the sampled area on plot that cannot be accessed because of a hazard or danger, for example cliffs, quarries, strip mines, illegal substance plantations, temporary high water, etc. Although the hazard is not likely to change over time, a hazardous condition remains in the sample and is re-examined at the next occasion to determine if the hazard is still present. There are no minimum size or width requirements for a condition class delineated by a hazardous condition. In some regions hazardous plots may be replaced; check with the field supervisor regarding regional protocols for plot replacement.
	04	Time limitation – This code applies to full subplots that cannot be sampled due to a time restriction. This code is reserved for areas with limited access, and in situations where it is imperative for the crew to leave before the plot can be completed (e.g., scheduled helicopter rendezvous). Use of this code requires notification to the field supervisor. This code should not be used for an entire plot (use code 8 (skipped visit) when an entire plot is skipped; (See 3.4.3 PLOT NONSAMPLED REASON).
	05	Lost data – The plot data file was discovered to be corrupt after a panel was completed and submitted for processing. This code is assigned to entire plots or full subplots that could not be processed, and is applied at the time of processing after notification to the region. Note: This code is for office use only.
10	Other – This code is used whenever a plot or condition class is not sampled due to a reason other than one of the specific reasons already listed. A field note is required to describe the situation.	

### 5.1.4 SUBPLOT/MACROPLOT CONDITION LIST (CORE OPTIONAL 3.9)

This is a listing of all condition classes located within the 58.9-foot radius around the macroplot center. A maximum of four conditions is permitted at any individual subplot / macroplot. If a condition class has already been defined at a previously completed subplot / macroplot, use the same condition class number whenever that condition is encountered. Define new condition classes as they are encountered. If more than one condition class is listed here, boundary data are required. If only one condition class is listed, this condition is automatically assigned to the subplot center and microplot center. If less than four condition classes occur on this subplot, complete the remainder of this field with zeros. For example, if condition 1 is the only condition class on a subplot, record 1000.

When collected:	All plots
Field width:	4 digits
Tolerance:	No errors
Values:	1000 to 9876

**5.1.5 SUBPLOT CENTER CONDITION (CORE 3.4)**

Record the CONDITION CLASS NUMBER of the condition class at the subplot center.

When collected:	All established subplots
Field width:	1 digit
Tolerance:	No errors
Values:	1 to 9

**5.2 PHYSIOGRAPHIC CLASS INFORMATION**

Aspect, slope, and physiographic class are recorded by subplot as well as by (accessible forestland) condition class. Code these items for each established subplot on the 4-subplot standard layout if one or more accessible forestland condition classes are present within the subplot's fixed-radius plot, i.e., if all condition classes present on a subplot are non-forestland, leave aspect, slope, and physiographic class blank. Physioclass data by subplot aids in determining these variables by forest condition class. See Appendix 1 for nonforest rules on R5 and R6 NFS lands

**5.2.1 SUBPLOT ASPECT (CORE 3.7)**

Record the aspect across the *24.0 ft radius* subplot, to the nearest 1-degree. SUBPLOT ASPECT is determined along the direction of slope for land surfaces with at least 5 percent slope in a generally uniform direction. SUBPLOT ASPECT is measured with a hand compass along the same direction used to determine slope. If aspect changes gradually across the subplot, record an average aspect. If aspect changes across the subplot but the aspect is predominately of one direction, code the predominate direction rather than the average.

If the subplot falls on or straddles a canyon bottom or narrow ridge top, code the aspect of the ridgeline or canyon bottom. If the subplot falls on a canyon bottom or on a narrow ridge top, but most of the area lies on one side hill, code the aspect of the side hill.

When the previous aspect data is downloaded/printed as a 2-character code, it requires updating with a current 3-digit numerical code.

When collected:	All subplots with at least one accessible forestland condition present in subplot (SUBPLOT/MACROPLOT STATUS = 1)
Field width:	3 digits
Tolerance:	+/- 10 degrees
Values:	000 no aspect, slope < 5 percent 001 1 degree 002 2 degrees . . . 360 360 degrees, due north

**5.2.2 SUBPLOT SLOPE (CORE 3.6)**

Record the angle of slope across the *24.0 ft radius* subplot to the nearest 1 percent. SUBPLOT SLOPE is determined by sighting the clinometer along a line parallel to the average incline (or decline) of each subplot. This angle is measured along the shortest pathway down slope before the drainage direction changes. To measure SUBPLOT SLOPE, Observer 1 should stand at the uphill edge of the subplot and sight Observer 2, who stands at the downhill edge of the subplot. Sight Observer 2 at the same height as the eye-level of Observer 1. Read the slope directly from the percent scale of the clinometer.

If slope changes gradually across the subplot, record an average slope. If slope changes across the subplot but the slope is predominately of one direction, code the predominant slope percentage rather than the average. If the subplot falls directly on or straddles a canyon bottom or narrow ridge top, code the average slope of the side hill(s). If the subplot falls on a canyon bottom or on a narrow ridge top, but most of the area lies on one side hill, code the slope of the side hill where most of the area lies.

When collected:	All subplots with at least one accessible forestland condition present in subplot (SUBPLOT/MACROPLOT STATUS = 1)
Field width:	3 digits
Tolerance:	+/- 10 %
Values:	000 to 155

### 5.2.3 Macroplot Physiographic Class (PNW)

Record the code that best describes the PHYSIOGRAPHIC CLASS of the condition macroplot; land form, topographic position, and soil generally determine physiographic class. As a rule of thumb, look over the 58.9 ft radius macroplot area to determine physiographic class.

When collected:	All macroplots with an accessible forestland condition class (CONDITION CLASS STATUS = 1) where STATE = California (06), Oregon (41), or Washington (53)																																											
Field width:	2 digits																																											
Tolerance:	No errors																																											
Values:	<p><b>Xeric</b> Sites that are normally low or deficient in moisture available to support vigorous tree growth. These areas may receive adequate precipitation, but experience a rapid loss of available moisture due to runoff, percolation, evaporation, etc.</p> <table border="1"> <thead> <tr> <th>Code</th> <th>Physiographic class</th> <th>Description</th> </tr> </thead> <tbody> <tr> <td>11</td> <td>Dry Tops</td> <td>Ridge tops with thin rock outcrops and considerable exposure to sun and wind.</td> </tr> <tr> <td>12</td> <td>Dry Slopes</td> <td>Slopes with thin rock outcrops and considerable exposure to sun and wind. Includes most mountain/steep slopes with a southern or western exposure.</td> </tr> <tr> <td>13</td> <td>Deep Sands</td> <td>Sites with a deep, sandy surface subject to rapid loss of moisture following precipitation. Typical examples include sand hills, sites along the beach and shores of lakes and streams.</td> </tr> <tr> <td>19</td> <td>Other Xeric</td> <td>All dry physiographic sites not described above. Describe in Plot Notes</td> </tr> </tbody> </table> <p><b>Mesic</b> Sites that have moderate but adequate moisture available to support vigorous tree growth except for periods of extended drought. These sites may be subjected to occasional flooding during periods of heavy or extended precipitation.</p> <table border="1"> <thead> <tr> <th>Code</th> <th>Physiographic class</th> <th>Description</th> </tr> </thead> <tbody> <tr> <td>21</td> <td>Flatwoods</td> <td>Flat or fairly level sites outside flood plains. Excludes deep sands and wet, swampy sites.</td> </tr> <tr> <td>22</td> <td>Rolling Uplands</td> <td>Hills and gently rolling, undulating terrain and associated small streams. Excludes deep sands, all hydric sites, and streams with associated floodplains.</td> </tr> <tr> <td>23</td> <td>Moist Slopes and Coves</td> <td>Moist slopes and coves with relatively deep, fertile soils. Often these sites have a northern or eastern exposure and are partially shielded from wind and sun. Includes moist mountain tops and saddles.</td> </tr> <tr> <td>24</td> <td>Narrow Floodplains/ Bottomlands</td> <td>Flood plains and bottomlands less than 1/4-mile in width along rivers and streams. These sites are normally well drained but are subjected to occasional flooding during periods of heavy or extended precipitation. Includes associated levees, benches, and terraces within a 1/4 mile limit. Excludes swamps, sloughs, and bogs</td> </tr> <tr> <td>25</td> <td>Broad Floodplains/ Bottomlands</td> <td>Flood plains and bottomlands 1/4 mile or wider in width along rivers and streams. These sites are normally well drained but are subjected to occasional flooding during periods of heavy or extended precipitation. Includes associated levees, benches, and terraces. Excludes swamps, sloughs, and bogs with year-round water problems.</td> </tr> <tr> <td>29</td> <td>Other Mesic</td> <td>All moderately moist physiographic sites not described above. Describe in Plot Notes</td> </tr> </tbody> </table> <p><b>Hydric</b> Sites that generally have a year-round abundance or over-abundance of moisture. Hydric sites are very wet sites where excess water seriously limits both growth and species occurrence.</p> <table border="1"> <thead> <tr> <th>Code</th> <th>Physiographic class</th> <th>Description</th> </tr> </thead> <tbody> <tr> <td>31</td> <td>Swamps/Bogs</td> <td>Low, wet, flat forested areas usually quite extensive that are</td> </tr> </tbody> </table>		Code	Physiographic class	Description	11	Dry Tops	Ridge tops with thin rock outcrops and considerable exposure to sun and wind.	12	Dry Slopes	Slopes with thin rock outcrops and considerable exposure to sun and wind. Includes most mountain/steep slopes with a southern or western exposure.	13	Deep Sands	Sites with a deep, sandy surface subject to rapid loss of moisture following precipitation. Typical examples include sand hills, sites along the beach and shores of lakes and streams.	19	Other Xeric	All dry physiographic sites not described above. Describe in Plot Notes	Code	Physiographic class	Description	21	Flatwoods	Flat or fairly level sites outside flood plains. Excludes deep sands and wet, swampy sites.	22	Rolling Uplands	Hills and gently rolling, undulating terrain and associated small streams. Excludes deep sands, all hydric sites, and streams with associated floodplains.	23	Moist Slopes and Coves	Moist slopes and coves with relatively deep, fertile soils. Often these sites have a northern or eastern exposure and are partially shielded from wind and sun. Includes moist mountain tops and saddles.	24	Narrow Floodplains/ Bottomlands	Flood plains and bottomlands less than 1/4-mile in width along rivers and streams. These sites are normally well drained but are subjected to occasional flooding during periods of heavy or extended precipitation. Includes associated levees, benches, and terraces within a 1/4 mile limit. Excludes swamps, sloughs, and bogs	25	Broad Floodplains/ Bottomlands	Flood plains and bottomlands 1/4 mile or wider in width along rivers and streams. These sites are normally well drained but are subjected to occasional flooding during periods of heavy or extended precipitation. Includes associated levees, benches, and terraces. Excludes swamps, sloughs, and bogs with year-round water problems.	29	Other Mesic	All moderately moist physiographic sites not described above. Describe in Plot Notes	Code	Physiographic class	Description	31	Swamps/Bogs	Low, wet, flat forested areas usually quite extensive that are
Code	Physiographic class	Description																																										
11	Dry Tops	Ridge tops with thin rock outcrops and considerable exposure to sun and wind.																																										
12	Dry Slopes	Slopes with thin rock outcrops and considerable exposure to sun and wind. Includes most mountain/steep slopes with a southern or western exposure.																																										
13	Deep Sands	Sites with a deep, sandy surface subject to rapid loss of moisture following precipitation. Typical examples include sand hills, sites along the beach and shores of lakes and streams.																																										
19	Other Xeric	All dry physiographic sites not described above. Describe in Plot Notes																																										
Code	Physiographic class	Description																																										
21	Flatwoods	Flat or fairly level sites outside flood plains. Excludes deep sands and wet, swampy sites.																																										
22	Rolling Uplands	Hills and gently rolling, undulating terrain and associated small streams. Excludes deep sands, all hydric sites, and streams with associated floodplains.																																										
23	Moist Slopes and Coves	Moist slopes and coves with relatively deep, fertile soils. Often these sites have a northern or eastern exposure and are partially shielded from wind and sun. Includes moist mountain tops and saddles.																																										
24	Narrow Floodplains/ Bottomlands	Flood plains and bottomlands less than 1/4-mile in width along rivers and streams. These sites are normally well drained but are subjected to occasional flooding during periods of heavy or extended precipitation. Includes associated levees, benches, and terraces within a 1/4 mile limit. Excludes swamps, sloughs, and bogs																																										
25	Broad Floodplains/ Bottomlands	Flood plains and bottomlands 1/4 mile or wider in width along rivers and streams. These sites are normally well drained but are subjected to occasional flooding during periods of heavy or extended precipitation. Includes associated levees, benches, and terraces. Excludes swamps, sloughs, and bogs with year-round water problems.																																										
29	Other Mesic	All moderately moist physiographic sites not described above. Describe in Plot Notes																																										
Code	Physiographic class	Description																																										
31	Swamps/Bogs	Low, wet, flat forested areas usually quite extensive that are																																										

			flooded for long periods of time except during periods of extreme drought. Excludes cypress ponds and small drains.
	32	Small Drains	Narrow, stream-like, wet strands of forestland often without a well-defined stream channel. These areas are poorly drained or flooded throughout most of the year and drain the adjacent higher ground.
	33	Bays and wet pocosins	Low, wet, boggy sites characterized by peaty or organic soils. May be somewhat dry during periods of extended drought. Examples include sites in the Lake States with lowland swamp conifers or the Carolina bays in the southeast US.
	34	Beaver ponds	
	35	Cypress ponds	
	39	Other hydric	All other hydric physiographic sites. Describe in Plot Notes

### 5.3 WATER INFORMATION

#### 5.3.1 WATER ON MACROPLOT (CORE 1.13)

Record the water source that has the greatest impact on the area within the accessible forestland portion of any of the four (58.9 foot) macroplots. The coding hierarchy is listed in order from large permanent water to temporary water. This variable may be used for recreation, wildlife, hydrology, and timber availability studies.

If no water evidence occurs on the 58.9 foot macroplot, then record the code for any water source that occurs within 215 horizontal feet of subplot center. An individual water source may be recorded on two or more subplots. On P3 plots where the annular ring is not being measured (not co-visited for the current panel), evaluate the 24.0 ft radius subplot only.

See the definitions in Section 4.1.

When collected:	All subplots with at least one accessible forestland condition present in subplot (SUBPLOT/MACROPLOT STATUS = 1, where STATE = 06 (California), 41 (Oregon), or 53 (Washington))	
Field width:	1 digit	
Tolerance:	No errors	
Values:	Code	Water on subplot
	0	None -- no water sources within the accessible forestland condition class
	1	Permanent ( <i>year-round</i> ) streams or ponds too small to qualify as noncensus water
	2	Permanent water in the form of deep swamps, bogs, marshes <i>with or without</i> standing trees present and less than 1.0 ac in size or with standing trees
	3	Ditch/canal – human made channels used as a means of moving water, such as irrigation or drainage which are too small to qualify as noncensus water
	4	Temporary (intermittent) streams that flows only part time because it receives water from seasonal sources such as springs and bank storage as well as precipitation
	5	Flood zones – evidence of flooding when bodies of water exceed their natural banks
	8	Census or noncensus water (Census and noncensus water within the 58.9 ft radius macroplot is already delineated in Subplot Mapping. Record code 8 census/noncensus water within 215 feet, but not within the 58.9 foot macroplot) Note: Not valid on P3 only plots.
9	Other temporary water – specify in field notes	

#### 5.3.2 Water Proximity (PNW)

Record a 3-digit code indicating the horizontal distance in feet from the edge of the water source to the subplot center. If there is no water source within 215 feet horizontal distance of subplot center, record "000". Valid codes are 000 through 215.

When collected:	When WATER ON MACROPLOT > 0
Field width:	3 digits
Tolerance:	+/- 10%
Values:	0 to 215

### 5.3.3 SNOW/WATER DEPTH (CORE 3.8)

Record to the nearest 0.1 foot the average approximate depth of water or snow covering the 24.0 ft radius subplot at the time of data collection. This variable is used to indicate plots where some variables (e.g. seedling count, total lengths) may be measured with less certainty due to conditions at the time of measurement.

This item is intended for water/snow which covers substantial portions of subplots. Do not record the depth of streams or other water sources if contained within their established banks and are not affecting tree or vegetation measurements.

When collected:	All subplots with an accessible forestland condition class (CONDITION CLASS STATUS=1)
Field width:	2 digits (x y)
Tolerance:	+/- 0.5 ft
Values:	0.0 to 9.9

## 5.4 MICROPLOT ATTRIBUTES

### 5.4.1 MICROPLOT CENTER CONDITION (CORE 3.5)

Record the CONDITION CLASS NUMBER of the condition class at the microplot center.

When collected:	All microplots where subplot center is CONDITION CLASS STATUS = 1, 2, 3
Field width:	1 digit
Tolerance:	No errors
Values:	1 to 9

### MICROPLOT SEEDLING COUNT

Stocking and regeneration information are obtained by counting live seedlings within the 6.8 foot radius microplot located 90 degrees and 12.0 feet from each subplot center within each of the four subplots. Conifer seedlings must be at least 0.5 feet in length and less than 1.0 inch at DBH/DRC in order to qualify for tallying counting. Hardwood seedlings must be at least 1.0 foot in length and less than 1.0 inch at DBH/DRC in order to qualify for counting. For western woodland species, each stem on a single tree must be less than 1.0 inch in DRC. Seedlings are counted in groups by species and condition class. Only count seedlings occurring in accessible forestland condition classes.

Count all live seedlings that have their base inside the microplot boundary regardless of vigor, damage, or closeness to other trees, but count only one seeding from a clump; a clump is 3 or more live stems that sprouted from a common root base (including stumps).

Seedlings are counted within each accessible forestland condition class on each microplot. Record the following data items for each seedling count:

### 5.4.2 SUBPLOT NUMBER (CORE 6.1)

Use the procedures and tolerances outlined in Section 5.1.1

### 5.4.3 CONDITION CLASS NUMBER (CORE 6.3)

Use the procedures and tolerances outlined in Chapter 4. See Section 4.4.1

### 5.4.4 SPECIES (CORE 6.2)

Use the procedures and codes outlined in Section 7.4.9

When collected:	All counts of seedlings
Field width:	4 digit
Tolerance:	No errors
Values:	See Appendix 9 Tree Species Lists

### 5.4.5 SEEDLING COUNT (CORE 6.4)

On each microplot, record the number of live tally tree seedlings, by species and condition class. Conifer seedlings must be at least 6.0 inches in length and less than 1.0 inch at DBH to qualify for counting. Hardwood seedlings must be at least 12.0 inches in length and less than 1.0 inch at DBH in order to qualify for counting. For western woodland species, each stem on a single tree must be less than 1.0 inch at DRC.



Multiple “suckers” that originate from the same location, and stump sprouts are considered one seedling. Do not tally or count “layers” (undetached branches partially or completely covered by soil, usually at the base) as seedlings. Do not tally any seedlings that sprout from a live tally tree.

When collected:	Each accessible forestland condition class on each microplot
Field width:	3 digit
Tolerance:	No errors
Values:	001 through 999

**FUEL LOADING ON THE MICROPLOT**

A component of the total fuel loading on a plot is the biomass of live and dead understory material. The 6.8 foot radius microplot will be used to estimate the percent cover and height of live and dead shrubs, live and dead herbs (includes grasses) and litter. Microplot fuel loading is sampled ONLY across all accessible forest land conditions on the microplot. Enter one value for all forested conditions combined.

Shrubs are plants with woody stems, including woody vines and mistletoe. Note: Tree seedlings (See Appendix 9) are not included in the shrubs measurement.

Herbs are non-woody herbaceous plants, including ferns, mosses, lichen, sedges, and grasses up to six feet in height. Although many forbs and grasses will die by the end of the growing season, an estimate of live and dead biomass on a given date will help fire modelers predict the phenology of herbaceous material during the year, allowing them to estimate fire danger patterns across the landscape.

Percent cover is estimated for each of the five fuel categories (live shrubs, dead shrubs, live herbs, dead herbs, and litter) in 10-percent classes for the accessible forested conditions of the microplot. For live fuels, estimate the percent of the microplot area that is covered by live plant material. Include whole plants that are entirely green (alive) and the live portions of plants that have live and dead parts. Include live branches or leaves that extend into the microplot area from a plant that is actually rooted outside of the microplot. **Do not include herbaceous material above 6 feet** (i.e. moss, ferns, lichens, epiphytes that are growing in tree branches above 6 feet).

For dead fuels, estimate the percent cover using the same procedures as live fuels, including plants that are entirely dead and dead branches or leaves still attached to a live plant. Dead plant material must be clearly visible. **Do not include dead material that has fallen to the ground, or is detached and suspended.** Cover estimates are made by visualizing an outline around the dead material (with all ‘air’ space included) and accumulating this across the forested microplot area.

An estimate of the height of the shrub and herbaceous layers is also needed to calculate biomass and fuel loadings. Record a height estimate for each fuel category, except litter. Height is estimated using the tallest shrub on the microplot.

Microplot Cover Estimation Guide (Hint: 8.5” x 11” = about 0.5% coverage)

%	area (sq ft)	radius (ft)	square (ft)
1	1.45	0.68	1.20
10	14.52	2.15	3.81
20	29.04	3.04	5.39
30	43.56	3.72	6.60
40	58.08	4.30	7.62
50	72.60	4.81	8.52
60	87.12	5.27	9.33
70	101.64	5.69	10.08
80	116.16	6.08	10.78
90	130.68	6.45	11.43
100	145.2	6.80	12.05

**5.4.6 Fuel Loading: Subplot Number (PNW)**

Record the code indicating the number of the subplot center from which the transect originates. Note: This is a CORE data item on P3 plots.

When collected:	All microplots with at least one CONDITION CLASS STATUS = 1
Field width:	1 digit
Tolerance:	No errors
Values:	1 Center subplot 2 North subplot 3 Southeast subplot 4 Southwest subplot

#### 5.4.7 Fuel Loading: Live Shrub Percent Cover (PNW)

Record the code for the cover class that indicates the percent cover of the forested microplot area covered with live shrubs.

When collected:	All microplots with at least one CONDITION CLASS STATUS = 1
Field width:	2 digits
Tolerance:	+/- 1 class
Values:	00 Absent 01 Trace ( < 1% cover) 10 1 – 10% 20 11-20% 30 21-30% .. .. 90 81-90% 99 91-100%

#### 5.4.8 Fuel Loading: Live Shrub Height (PNW)

Record the height of the tallest shrub to the nearest 0.1 foot. Measure heights < 6 feet and estimate heights > 6 feet.

When collected:	All microplots with at least one CONDITION CLASS STATUS = 1
Field width:	3 digits
Tolerance:	+/- 0.5 feet
Values:	0 to 99.9

#### 5.4.9 Fuel Loading: Dead Shrubs Percent Cover (PNW)

Record the code for the cover class that indicates the percent cover of the forested microplot area covered with dead shrubs and dead branches attached to live shrubs if visible from above.

When collected:	All microplots with at least one CONDITION CLASS STATUS = 1
Field width:	2 digits
Tolerance:	+/- 1 class
Values:	00 Absent 01 Trace ( < 1% cover) 10 1 – 10% 20 11-20% 30 21-30% .. .. 90 81-90% 99 91-100%

#### 5.4.10 Fuel Loading: Dead Shrubs Height (PNW)

Record the height of the tallest dead shrub layer to the nearest 0.1 foot. Measure heights < 6 feet and estimate heights > 6 feet.

When collected:	All microplots with at least one CONDITION CLASS STATUS = 1
Field width:	3 digits
Tolerance:	+/- 0.5 feet
Values:	0 to 99.9

**5.4.11 Fuel Loading: Live Herbs Percent Cover (PNW)**

Record the code for the cover class that indicates the percent cover of the forested microplot area covered with live herbaceous plants.

When collected:	All microplots with at least one CONDITION CLASS STATUS = 1
Field width:	2 digits
Tolerance:	+/- 1 class
Values:	00 Absent 01 Trace ( < 1% cover) 10 1 – 10% 20 11-20% 30 21-30% .. .. 90 81-90% 99 91-100%

**5.4.12 Fuel Loading: Live Herbs Height (PNW)**

Record the height (at the tallest point) of the live herbaceous layer to the nearest 0.1 foot. Maximum height is 6 feet.

When collected:	All microplots with at least one CONDITION CLASS STATUS = 1
Field width:	2 digits
Tolerance:	+/- 0.2 feet
Values:	0.0 to 6.0

**5.4.13 Fuel Loading: Dead Herbs Percent Cover (PNW)**

Record the code for the cover class that indicates the percent cover of the forested microplot area covered with dead herbaceous plants and dead leaves attached to live plants if visible from above.

When collected:	All microplots with at least one CONDITION CLASS STATUS = 1
Field width:	2 digits
Tolerance:	+/- 1 class
Values:	00 Absent 01 Trace ( < 1% cover) 10 1 – 10% 20 11-20% 30 21-30% .. .. 90 81-90% 99 91-100%

**5.4.14 Fuel Loading: Dead Herbs Height (PNW)**

Record the height (at the tallest point) of the dead herbaceous layer to the nearest 0.1 foot. Maximum height is 6 feet.

When collected:	All microplots with at least one CONDITION CLASS STATUS = 1
Field width:	2 digits
Tolerance:	+/- 0.2 feet
Values:	0.0 to 6.0

**5.4.15 Fuel Loading: Litter Percent Cover (PNW)**

Record the code for the cover class that indicates the percent cover of the forested microplot area covered with litter. Litter is the layer of freshly fallen leaves, twigs, dead moss, dead lichens, and other fine particles of organic matter found on the surface of the forest floor. Decomposition is minimal.

When collected:	All microplots with at least one CONDITION CLASS STATUS = 1
Field width:	2 digits
Tolerance:	+/- 1 class
Values:	00 Absent 01 Trace (< 1% cover) 10 1 – 10% 20 11-20% 30 21-30% .. .. 90 81-90% 99 91-100%

## 5.5 BOUNDARY REFERENCE MAPPING

Boundary reference data are used to compute the area for the condition classes sampled on a plot and to remeasure plots. Record all boundaries between condition classes that occur within the sampled (fixed-radius) area on subplots and microplots (and optionally macroplots). Boundaries outside sampled (fixed-radius) areas are not referenced.

In addition to using the recording procedures described herein, sketch maps of condition class boundaries onto the pre-printed plot diagrams on paper field tally sheets.

If the national mapping procedures do not accurately represent the boundary, enter the national boundary data as best as possible into the data recorder, then sketch the boundary on the back of the plotcard so that it accurately represents the area mapped.

### REFERENCE PROCEDURES

Reference within the sampled area on each microplot, subplot, and macroplot, the approximate boundary of each condition class that differs from the condition classes at a subplot center. Trees selected on these fixed-radius plots are assigned to the actual condition in which they lie regardless of the recorded approximate boundary delineated.

Boundary referencing is done by recording azimuths and distances from subplot center to the reference points and/or from microplot center to the reference points (See Boundary Mapping Examples, Figures 5-1 through 5-3). Each boundary is marked by a maximum of three points - two where the boundary intersects the subplot circumference or microplot circumference, and one "corner" point between the two end points, if necessary. Only the corner point requires a distance, since the distance from the center to the circumference is always equal to the fixed plot radius.

Microplot boundaries are referenced *from* the microplot center, and macroplot boundaries are referenced to the subplot center in the same manner described for subplots. Note that the larger the plot, the greater likelihood of a need for a boundary corner to record boundaries that are not straight lines.

**Hectare** boundaries are always referenced from the center of Subplot 1.

Refer to the general condition class delineation guidelines *for Condition class status and Accessible Forestland in Section 4.4*. The following additional rules apply when referencing a boundary within a subplot, microplot, or macroplot:

1. When a boundary between accessible forestland and non-forest land or between two contrasting accessible forestland condition classes is clearly marked, use that feature to define the boundary. Examples of clear demarcation are a fence line, plowed field edge, sharp ridgeline, *defined stem line*, and water's edge along a stream course, ditch, or canal.
2. When a boundary between forestland and non-forestland is not clearly marked by an obvious feature, the boundary should follow the non-forest side of the stems of the trees at the forest edge.
3. When a boundary between two contrasting forestland condition classes is not clearly marked, map along the stems of the contrasting condition. When the boundary between two contrasting forestland condition classes is separated by a narrow linear inclusion (creek, fire line, narrow meadow, unimproved road), establish the boundary at the far edge, relative to subplot center, of the inclusion.

4. When a plot is remeasured, the crew will examine the boundaries referenced at the last inventory *and reassess the condition class delineating variables*. If no change has occurred, the current crew will retain the boundary data that were recorded at last inventory. If a boundary has changed, or a new boundary is present, or the previous crew made an obvious *serious* error, record the new or updated boundary data. Delete boundaries that are no longer distinct. *If in doubt whether a condition change has occurred, then leave as delineated at the last inventory.* (See 5.5.8 BOUNDARY CHANGE)
5. Although individual MQOs are specified for the azimuths and distances, in practice a crew will be considered 'correct' when the difference in areas as mapped by the original crew and by the QA crew is less than 10 percent of the *macroplot*, subplot, or microplot area. This allows for slight variations in azimuths or distances due to the approximate nature of mapping procedures.

## **BOUNDARY DATA**

Record the appropriate value *for each of the following data items* for each boundary mapped on the subplot, microplot or macroplot as follows.

**Remeasurement plots:** All previous mapping records will be downloaded to the PDR to be updated as necessary. Only update if you are sure a condition change has occurred. Record the reason for the change in BOUNDARY CHANGE (5.5.8).

### **5.5.1 SUBPLOT NUMBER (CORE 4.2.1)**

Record the code corresponding to the number of the subplot. *Use the same code used for SUBPLOT NUMBER in Section 5.1.1.*

When collected:	All boundaries
Field width:	2 digits
Tolerance:	No errors
Values:	N1, N2, N3, N4

### **5.5.2 PLOT TYPE (CORE 4.2.2)**

Record the code to specify whether the boundary data are for a subplot, microplot, annular, or hectare plot. *If no boundaries are recorded for a subplot, enter one record with PLOT TYPE = 0.*

When collected:	All boundaries	
Field width:	1 digit	
Tolerance:	No errors	
Values:	Code	Plot Type
	0	No boundaries are recorded for the subplot
	1	Subplot boundary (will prompt for the associated macroplot (PLOT TYPE = 3) boundary)
	2	Microplot boundary
	3	macroplot boundary (coded only when macroplots are taken)
4	Hectare plot boundary (coded from subplot 1 only)	

### **5.5.3 CONTRASTING CONDITION (CORE 4.2.4)**

Record the CONDITION CLASS NUMBER of the condition class that contrasts with the condition class located at the subplot center (for boundaries on the subplot, macroplot *or hectare* plot) or at the microplot center (for boundaries on the microplot), e.g., the condition class present on the other side of the boundary line.

When collected:	All boundaries
Field width:	1 digit
Tolerance:	No errors
Values:	1 to 9

### **5.5.4 LEFT AZIMUTH (CORE 4.2.5)**

Record, *in degrees*, the azimuth from the subplot, microplot, macroplot, *or hectare* plot center to the farthest left point (facing the contrasting condition class) where the boundary intersects the subplot, microplot, or annular, or hectare plot circumference.

When collected:	All boundaries
Field width:	3 digits
Tolerance:	+/- 10 degrees
Values:	001 to 360

### 5.5.5 CORNER AZIMUTH (CORE 4.2.6)

Record, *in degrees*, the azimuth from the subplot, microplot, *macroplot*, or *hectare* plot center to a corner or curve in a boundary. If a boundary is best described by a straight line between two circumference points, then record 000 for CORNER AZIMUTH (000=none).

When collected:	All boundaries
Field width:	3 digits
Tolerance:	+/- 10 degrees
Values:	001 to 360

### 5.5.6 CORNER DISTANCE (CORE 4.2.7)

Record the horizontal distance, to the nearest 1 foot, from the subplot, microplot, *macroplot*, or *hectare* plot center to a boundary corner point.

When collected:	All boundaries	
Field width:	3 digits	
Tolerance:	+/- 1 ft	
Values:	Plot Type	Values for Corner Distance
	Microplot	01 to 07 ft (actual limiting distance is 6.8 feet )
	Subplot	01 to 24 feet
	Macroplot	01 to 59 feet (actual limiting distance is 58.9 ft)
	hectare plot	01 to 185 feet (actual limiting distance is 185.1 ft)

### 5.5.7 RIGHT AZIMUTH (CORE 4.2.8)

Record, *in degrees*, the azimuth from the subplot, microplot, macroplot, or *hectare* plot center to the farthest right point (facing the contrasting condition class) where the boundary intersects the subplot, microplot, macroplot, or *hectare* plot circumference.

When collected:	All boundaries
Field width:	3 digits
Tolerance:	+/- 10 degrees
Values:	001 to 360

### 5.5.8 BOUNDARY CHANGE (CORE 4.2.3)

Remeasurement (SAMPLE KIND = 2) locations only. Record the appropriate code to indicate the relationship between previously recorded and current boundary information.

When collected:	SAMPLE KIND = 2, All boundaries	
Field width:	1 digit	
Tolerance:	No errors	
Values:	0	No change - boundary is the same as indicated on plot map and/or data collected by a previous crew.
	1	New boundary, or boundary data has been changed to reflect an actual on-the-ground physical change resulting in a difference from the boundaries recorded.
	2	Boundary has been changed to correct an error from previous crew.
	3	Boundary has been changed to reflect a change in variable definition.

## HECTARE PLOT MAPPING

See Appendix A1.1 to determine if Hectare measurements are made on a plot.

### 1. Region 6 Hectare Plot Mapping

A hectare plot (185.1 foot fixed-radius plot around the center of subplot 1) is established if the center of subplot 1 is on R6 national forest land. The hectare plot is established even if there are no forested condition classes present

on the subplots or macroplots.

**Mapping Condition Classes in R6:** All forest and nonforest condition classes present on the hectare plot are sketch mapped on the dot-map on the back of the plot card. The condition class boundaries are entered into the BOUNDARY MAPPING for subplot 1. Attributes for all condition classes mapped on the hectare are assigned.

2. Region 5 Hectare Plot Mapping

A hectare plot (185.1 feet fixed-radius plot around the center of subplot 1) will be established for designated plots within the Northwest Forest Plan area. The hectare plot is established on these plots even if there are no forested condition classes present on any of the subplots or macroplots. Size requirements are for trees of 32.0" DBH/DRC on "east" side plots, and 48.0" DBH/DRC on "west" side plots. The data recorder will designate if a plot is a hectare plot or not. There will also be an indication on the plot jacket. See Appendix 1 for more information.

Mapping condition classes in R5: Condition classes are mapped on the subplots and macroplots using normal procedures. Any additional condition classes present on the hectare plot that contain a hectare tally tree, but are not already delineated are mapped. Sketch the condition class on the dot-map on the back of the plot card. The boundaries are entered into the BOUNDARY MAPPING for subplot 1.

**BOUNDARY MAPPING EXAMPLES**

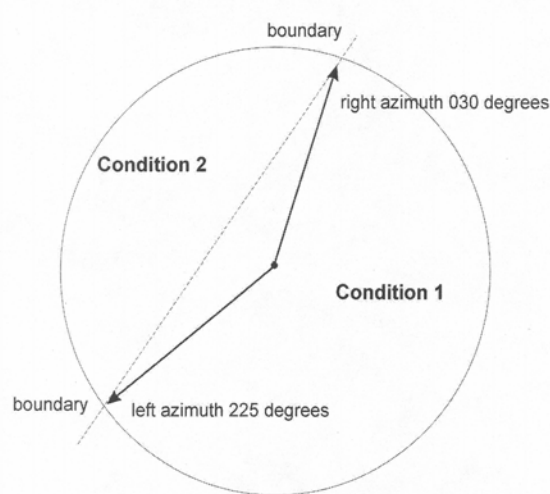

Figure 5-1: How to measure a straight boundary on a 2-condition subplot.

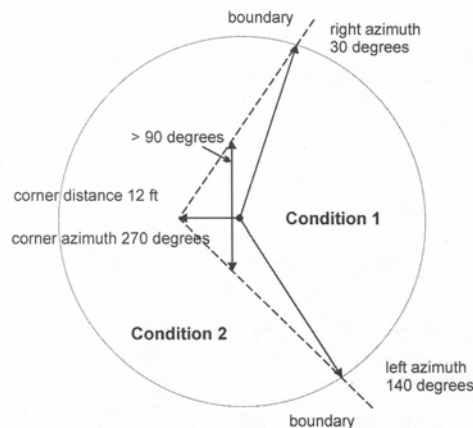

Figure 5-2: How to measure a boundary with a corner on a 2-condition plot or subplot.

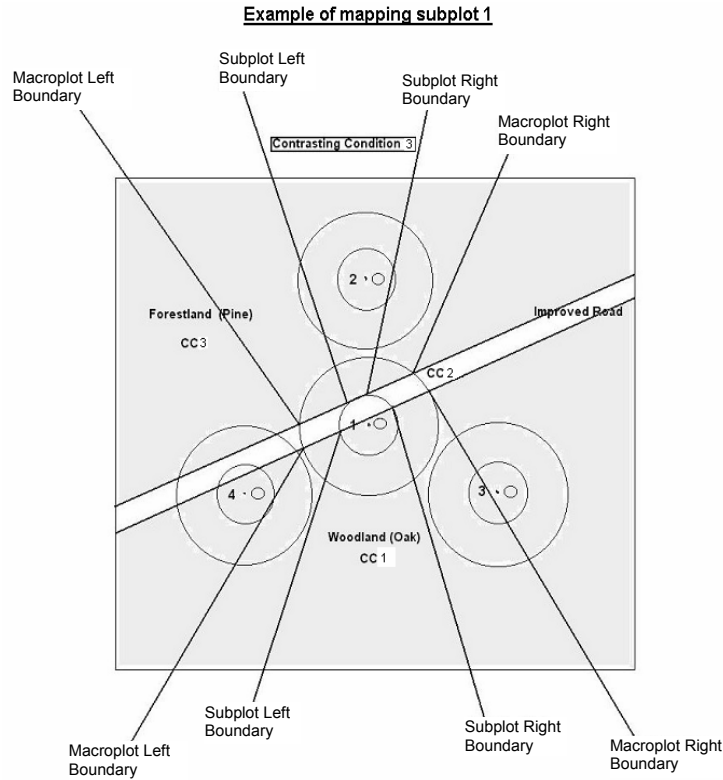

Figure 5-3: How to map subplot 1.

## 5.6 SUBPLOT/MACROPLOT NON-FOREST INCLUSIONS

Non-forest inclusions are areas that are non-forest but are too small by definition to qualify as a separate non-forest condition class. These inclusions are inherently incapable of supporting tree stocking at 10 percent or more of normal full stocking for the life of a stand. Examples of non-forest inclusions can be unimproved dirt lanes, small streams, and sites with standing or running water, a high water table, a rock outcropping occupying at least 65 square feet, severe soil compaction (i.e. an old landing), or mass soil movement (slips, slides, or slumps). A stream or improved non-forest road, which qualifies as non-forestland, should be recognized as a separate non-forest condition class and not as a non-forest inclusion.

### 5.6.1 Non-forest Inclusions: Mapping and Recording (PNW)

Non-forest inclusions are mapped and recorded by subplot/macroplot and condition class. This is done only if the non-forest inclusion is present within a mapped accessible forestland condition class in Oregon, Washington, and California, and is partially or entirely within the subplot's 58.9-foot fixed-radius plot.

Map and label non-forest inclusions lying within the 58.9-foot fixed-radius plot on the subplot diagram. For each accessible forestland condition class mapped on the subplot, estimate the area of the 24.0-foot fixed-radius plot area occupied by the mapped non-forest inclusions; then separately estimate the area of the entire 58.9-foot fixed-radius plot area (including the 24.0 ft subplot) occupied by the mapped non-forest inclusions. See Section 5.6.1 for how to map and estimate percentages. Record these percentages, their assigned condition class numbers and the type(s) of inclusion under "Inclusions %" on the subplot diagram. Then, record by condition class and by subplot/macroplot, these percentages and their assigned condition class numbers in the PDR under "Non-forest inclusions" within SUBPLOT ATTRIBUTES. Record "00" in the "%" column for each forest condition class without non-forest inclusions. If all condition classes present on a subplot/macroplot are non-forest, record "00" in the "%" columns for both the 24.0 ft and 58.9 ft radius.



Example:	<u>Condition # 1</u>		<u>Condition # 2</u>	
	24.0 ft	58.9 ft	24.0 ft	58.9 ft
Rocks	12%	53%	00%	15%

When collected:	All subplots with an accessible forestland condition class
Field width:	2 digits
Tolerance:	+/- 15%
Values:	1 to 99

**DOWNLOADED ESTIMATES OF NONFOREST INCLUSIONS**

Non-forest inclusions were mapped and recorded by subplot on FIA timberland plots visited previously. These data are on the old plot sheets, and may assist the present crew in mapping non-forest inclusions. These previous data are downloaded/printed. If a previous subplot is remeasured at the current inventory and data for previous non-forest inclusions are downloaded, revise the previous estimate and enter the appropriate condition class number to reflect the situation at the current inventory. You may need to record more than one estimate for non-forest inclusions if there is more than one forest condition class mapped on the subplot's 58.9-foot fixed-radius plot. If there are no non-forest inclusions present, set the downloaded estimate to "00".

When the present plot is remeasured, non-forest inclusion data will be downloaded/printed and will be revised to reflect the situation at future inventories.

**EXAMPLES OF NONFOREST INCLUSIONS**

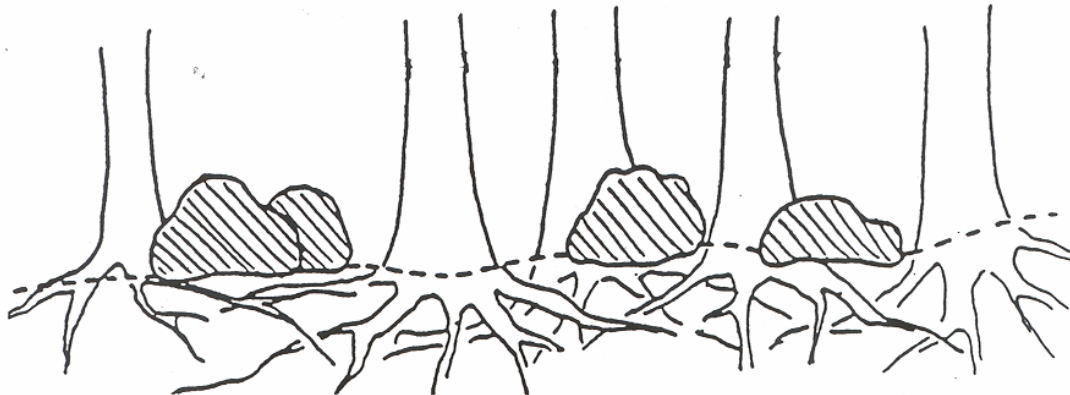

Figure 5-4: Large, scattered boulders cover 25 percent of the 58.9-foot fixed-radius subplot. However, tree roots can fully utilize the space beneath the boulders. The boulders thus have no effect on potential tree stocking, and the item is coded "00" and the rocks are not mapped on the 58.9-foot fixed-radius subplot diagram as non-forest inclusions.

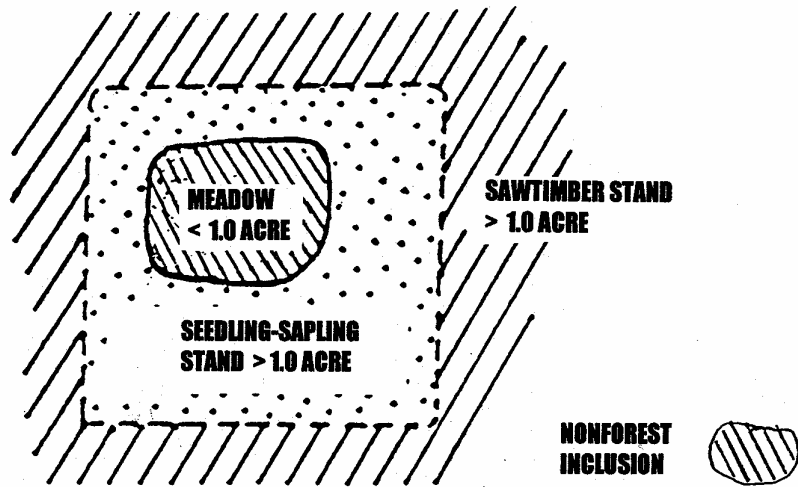

Figure 5-5: A swampy meadow less than 1.0 acre in area is surrounded by forestland that is greater than 1.0 acre. The meadow is a non-forest inclusion, and the portion of the meadow within the 58.9-foot fixed-radius plot is mapped as a non-forest inclusion on the subplot diagram.

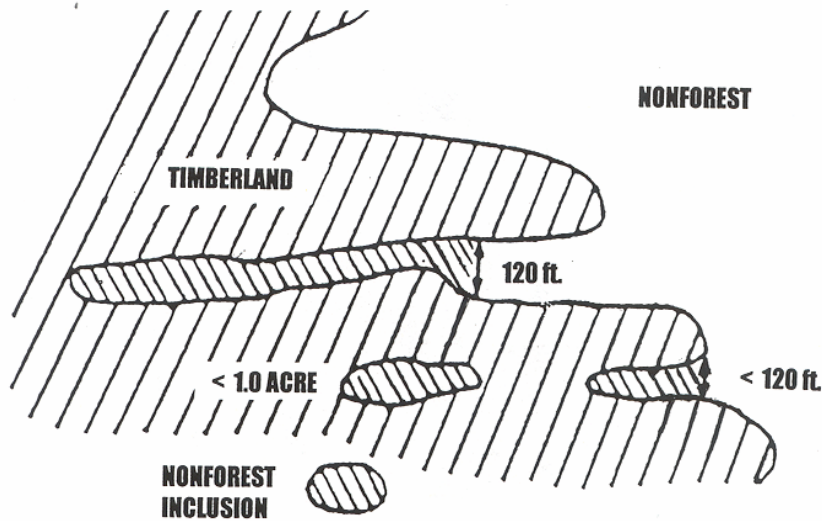

Figure 5-6: In the above example each non-forest area (see Chapter VI) is classified as accessible forestland because each is not 120.0 feet wide and 1.0 acre in size. They would be mapped as non-forest inclusions. Where the non-forest area becomes greater than 120.0 feet wide is classified as a part of the non-forest condition class and it would not be mapped as a non-forest inclusion.

**ESTIMATING NONFOREST INCLUSION AREA PERCENTAGES BY CONDITION CLASS**

Use the following steps to estimate, by condition class, the percentage of subplot area mapped as non-forest inclusion.

The following refers to mapping on the dot map on the back of the plotcard:

1. Each dot represents 1.45 percent of the area within the 24.0 foot subplot plot.
2. Each dot represents 0.23 percent of the area within the entire 58.9 foot macroplot.
3. Draw the non-forest inclusion boundary and count the number of dots within the 24.0 foot subplot boundary within each condition class. Count every other dot of those which fall directly on a boundary.
4. Multiply the number of dots from step 3 by 1.45 to get percent of the 24.0 foot subplot in that condition class. Alternatively, count the number of dots from step 3; divide by 69 (total number of dots) and multiply by 100 to get the percent of the subplot in that condition class. See the legend on the diagram plot card.

5. Count the number of dots within the 58.9 foot macroplot boundary within each condition class. Include any dots previously counted in the subplot. Count every other dot of those which fall directly on a boundary.
6. Multiply the number of dots from step 5 by 0.23 to get percent of the 58.9 foot macroplot (including the subplot) in that condition class. Alternatively, count the number of dots from step 5; divide by 437 (total number of dots) and multiply by 100 to get the percent of the macroplot in that condition class.

## 5.7 ROOT DISEASE MAPPING/RATING

Root diseases, especially laminated root rot in western Oregon, are serious forest pathogens. Information collected about root disease is developed into estimates of the area affected by each of several major diseases. These estimates can be combined with other data from the inventory to analyze the impact of root disease on forestland.

### 5.7.1 Root Disease Mapping and Recording (PNW)

Root diseases are mapped and recorded on established 58.9 foot macroplots in Oregon, Washington, and California. Each disease is mapped and recorded separately (see "Mapping root disease below). A root disease is mapped and recorded only if the area of infection is partially or entirely within a macroplot's 58.9 foot fixed-radius plot and is within one or more accessible forestland condition classes mapped on the macroplot. If all condition classes mapped on a macroplot's 58.9 foot fixed-radius plot are non-forestland all root disease records are set or left blank for the macroplot.

Map and label each disease present within the 58.9 foot macroplot on the subplot diagram on the back of the plot card. For each accessible forestland condition class mapped on the macroplot, estimate the percentage of the 58.9 foot fixed-radius plot area occupied by each mapped root disease; see below on how to map and estimate percentages. By disease, record these percentages, their assigned forest condition class numbers and the root disease code under "Root Disease" on the subplot diagram; enter "NO" if no disease is present. Then record, by condition class these percentages, their assigned condition class numbers, and the disease code under "Disease 1, 2, or 3" within SUBPLOT ATTRIBUTES. Record a disease code of "NO" (no disease) and "00" in the "%" column for each disease and forest condition class without disease present.

When collected:	All macroplots with an accessible forestland condition class (and accessible nonforest on R5 and R6 NFS lands – See Appendix 1)
Field width:	2 digits
Tolerance:	+/- 15%
Values:	00 to 99

### DOWNLOADED ESTIMATES OF ROOT DISEASE

Root diseases were mapped and recorded individually by subplot on timberland plots visited last occasion. These data are on the old plot cards and printed records and may help map at the current occasion. When the current plot is remeasured, root disease data will be downloaded/printed and will be revised to reflect the situation at the next plot visit.

### MAPPING ROOT DISEASE

- Western OR, Western WA, and CA (North Coast only)

Define the boundary of an infection zone using straight lines connecting the boles of healthy-appearing trees on the perimeter of a root disease center. A healthy-appearing tree is defined by the following criteria:

- a) The tree lacks crown symptoms of root disease (reduced terminal growth increment, thinning or yellowing crown, or a distress cone crop present);
- b) The tree has a root disease-infected tree as its nearest neighbor on the side facing the infection center; and
- c) The tree has a healthy tree as its nearest neighbor on the side facing away from the infection center.

When determining the area infected by a root disease, do not exclude an island of healthy-appearing trees inside the infected area unless the trees in the island are all of non-host species; susceptible trees in an "island" are likely to be infected. Tally trees may require damaging agent and severity coding for root disease; this includes cases where a tally tree is not within the boundary of a mapped infection zone but, because of proximity to an infected tree or stump, requires a root disease agent code that has a severity rating of 1 (see Section 7.9).

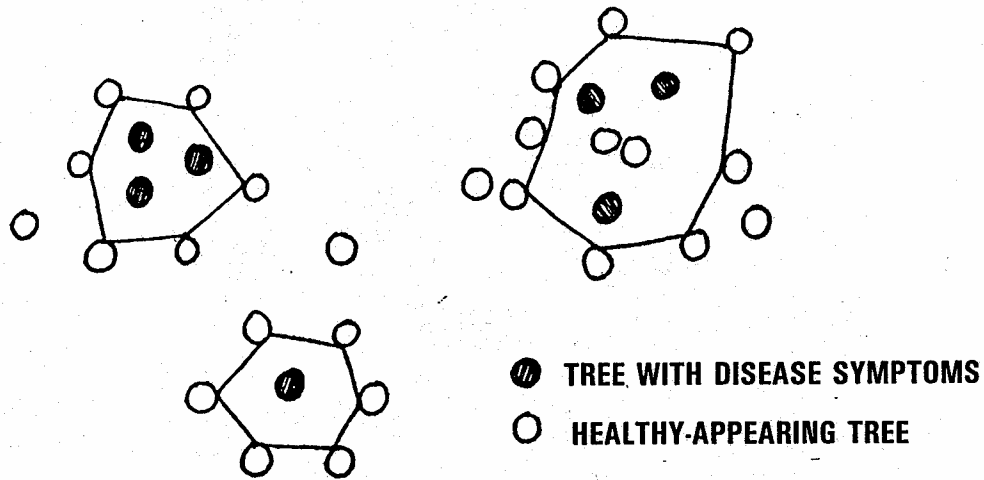

Figure 5-7: Diagram showing how infection center boundaries would be defined in several situations.

Mapped areas of infection should include conifer sites that have no conifers present due to root disease. When mapping areas of infection, do not include areas of non-forest inclusions or areas that will not support susceptible host species.

Map and estimate percent cover only if a disease is a primary cause of tree death. Do not map and estimate percent cover for secondary infections (e.g. *Armillaria* that invaded a tree that was killed by *Phellinus*). If you find evidence of a secondary agent, note the situation in Present Condition/Past Disturbance on the plot card.

Sketch the boundaries on the subplot map diagram on the back of the plot card; shade the infected area, and label with the appropriate code:

Code	Causal fungus	Disease
PW	<i>Phellinus weirii</i>	laminated root disease
CW	<i>Ceratocystis wagneri</i>	black stain root disease (do not map)
FA	<i>Fomes annosus</i>	annosus root disease
AM	<i>Armillaria ostoyae(mellea)</i>	armillaria (shoestring) root disease
UK	Unknown	--
NO	None present	--

If there is evidence of root disease, but the specific disease cannot be identified, enter "UK" (unknown) for the disease code. Do not map or record *Phytophthora lateralis* (Port-Orford-cedar root rot) on the subplot diagram.

- Eastern OR, and Eastern WA, and CA (except the North Coast)

On east-side (mixed conifer) stands where mapping contiguous areas is difficult, map a 30 foot radius circle around all trees and stumps infected with root disease. These circles may overlap. Include in the percent estimate for the macroplot, area that is within 30 ft of an infected tree or stump even if that tree/stump is outside the macroplot being evaluated.

Use the codes and other mapping rules as described above.

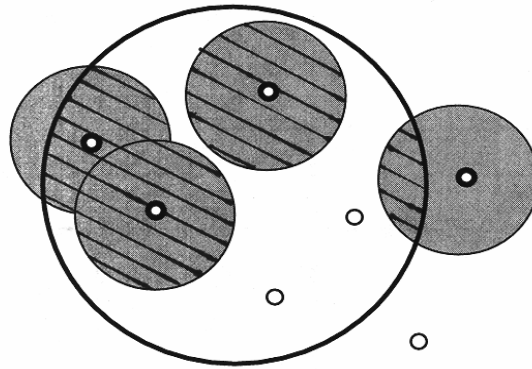

Figure 5-8: Root disease mapped within a plot boundary

Estimate the percentage of area within the subplot/macroplot boundary (indicated by dashed lines in the diagram above)

**GUIDE FOR IDENTIFYING ROOT DISEASE**

See Appendix 10 for insect and disease identification information.

**ESTIMATING ROOT DISEASE AREA PERCENTAGES BY CONDITION CLASS**

Use the following steps to estimate by condition class, the percentage of the macroplot area mapped with a root disease.

The following refers to mapping on the dot map on the back of the plot card:

1. Each dark dot represents 0.23 percent of the area within the entire 58.9-ft macroplot.
2. Draw the root disease area boundary and count the number of dark dots within the 58.9-foot macroplot boundary within each condition class. Count every other dark dot of those which fall directly on a boundary.
3. Multiply the number of dark dots from step 2 by 0.23 to get percent of the 58.9-foot macroplot (including the subplot) in that condition class. Alternatively, count the number of dark dots from step 2; divide by 437 (total number of dark dots) and multiply by 100 to get the percent of the macroplot in that condition class.
4. Root disease mapping percentages are not divided into separate percents for the subplot and percent for the macroplot.

**5.7.2 Root Disease Severity Rating (PNW)**

In addition to the root disease mapping described above, the macroplot is assigned a Root Disease Rating. Evaluate all accessible forestland area within the 58.9-ft radius macroplot boundary in Oregon, Washington, and California and assign the Root Disease Severity Rating that best describes the degree of root disease present.

When collected:	All macroplots with an accessible forestland condition class	
Field width:	1 digit	
Tolerance:	+/- 1 class	
Values:	Code	Root disease severity rating
	0	No evidence of root disease visible within 50feet of the 58.9 foot macroplot.
	1	Root disease present within 50 feet of the macroplot, but no evidence of disease on the macroplot.
	2	Minor evidence of root disease on the macroplot, such as suppressed tree killed by root disease, or a minor part of the overstory showing symptoms of infection. Little or no detectable reduction in canopy closure or volume.
	3	Canopy reduction evident, up to 20%; usually as result of death of 1 codominant tree on an otherwise fully stocked site. In absence of mortality, numerous trees showing symptoms of root disease infection.
4	Canopy reduction at least 20%; up to 30% as a result of root disease mortality. Snags and downed tress removed from canopy by disease as well as live trees with advance	

		symptoms of disease contribute to impact.
	5	Canopy reduction 30-50% as a result of root disease. At least half of the ground area of macroplot considered infested with evidence of root disease-killed trees. Macroplots representing mature stands with half of their volume in root disease-tolerant species usually do not go much above severity 5 because of the ameliorating effect of the disease-tolerant trees.
	6	50-75% reduction in canopy with most of the ground area considered infested as evidenced by symptomatic trees. Much of the canopy variation in this category is generally a result of root disease-tolerant species occupying infested ground.
	7	At least 75% canopy reduction. Macroplots that reach this severity level usually are occupied by only the most susceptible species. There are very few of the original overstory trees remaining although infested ground is often densely stocked with regeneration of susceptible species.
	8	The entire macroplot falls within a definite root disease pocket with only one or very few susceptible overstory trees present.
	9	The entire macroplot falls within a definite root disease pocket with no overstory trees of the susceptible species present.

## 5.8 SUBPLOT DISTURBANCE

The following variables are collected on Region 5 chaparral plots only.

### 5.8.1 Burn Assessment (PNW)

Record the code for the percentage of the 24.0 foot subplot that shows evidence of having been burned since the previous inventory. On plots visited for the first time record evidence of burn within the past 5 years.

When collected:	When PLOT STATUS = 2, CONDITION CLASS STATUS=2, and Nonforest Land Use=45 <b>(R5 NFS chaparral)</b>
Field width:	1 digit
Tolerance:	No errors
Values:	0 No evidence of fire 1 1 to 50 % of subplot burned 2 51 to 100 % of subplot burned

### 5.8.2 Mechanical Management Assessment (PNW)

Record the code for percentage of the 24.0 foot subplot that shows evidence of having been affected by mechanical manipulation such as tractor use, shear, bulldozer, etc. since previous inventory (periodic or annual) or with the last 5 years on new plots.

When collected:	When PLOT STATUS = 2, CONDITION CLASS STATUS=2, and Nonforest Land Use=45 <b>(R5 NFS chaparral)</b>
Field width:	1 digit
Tolerance:	No errors
Values:	0 No evidence of mechanical manipulation 1 1 to 50 % of subplot affected(coded only when macroplots are taken) 2 51 to 100 % of subplot affected

## 6 DOWN WOODY MATERIALS

### Table of Contents

<b>6</b>	<b>DOWN WOODY MATERIALS .....</b>	<b>91</b>
<b>6.1</b>	<b>DEFINITION OF DOWN WOODY MATERIALS.....</b>	<b>93</b>
	CWD .....	93
	FWD.....	93
<b>6.2</b>	<b>LOCATING AND ESTABLISHING LINE TRANSECTS.....</b>	<b>94</b>
	CWD TRANSECTS.....	94
	FWD TRANSECTS .....	94
<b>6.3</b>	<b>TRANSECT LINE SEGMENTING.....</b>	<b>95</b>
6.3.1	Subplot Number (PNW).....	96
6.3.2	Transect (PNW).....	96
6.3.3	Condition Class Number (PNW).....	96
6.3.4	Beginning Distance PNW (PNW).....	96
6.3.5	Ending Distance (PNW).....	97
6.3.6	Slope Percent (PNW).....	97
<b>6.4</b>	<b>SAMPLING METHODS FOR COARSE WOODY DEBRIS (CWD).....</b>	<b>97</b>
	MARKING CWD .....	100
	RECORDING PROCEDURES FOR CWD .....	100
6.4.1	Subplot Number (PNW).....	100
6.4.2	Transect (PNW).....	100
6.4.3	CWD Slope Distance (PNW) .....	100
6.4.4	CWD Decay Class (PNW).....	101
6.4.5	Species (PNW).....	101
	DIAMETERS .....	102
6.4.6	Diameter at Point of Intersection (PNW).....	103
6.4.7	Diameter at the Small End (PNW) .....	103
6.4.8	Diameter at the Large End (PNW).....	103
6.4.9	CWD Total length (PNW) .....	104
6.4.10	Hollow (PNW).....	104
6.4.11	Percent of Log Charred by Fire (PNW) .....	104
6.4.12	CWD History (PNW).....	105
<b>6.5</b>	<b>SAMPLING METHODS FOR FINE WOODY DEBRIS (FWD).....</b>	<b>105</b>
6.5.1	Subplot Number (PNW).....	106
6.5.2	Condition Class Number (PNW).....	106
6.5.3	Residue Pile on Transect (PNW) .....	106
6.5.4	Small FWD Count (PNW).....	106
6.5.5	Medium FWD Count (PNW).....	107
6.5.6	Large FWD Count (PNW).....	107
6.5.7	High Count Reason (PNW).....	107
<b>6.6</b>	<b>DUFF, LITTER, AND FUELBED DEPTH MEASUREMENTS.....</b>	<b>107</b>
	DEFINITIONS .....	107
	OVERVIEW OF MEASUREMENTS.....	108
6.6.1	Subplot Number (PNW).....	108
6.6.2	Transect (PNW).....	109
6.6.3	Duff, Litter, and Fuelbed Sample (PNW) .....	109

Annual Inventory 2007, Chapter 6: Down Woody Materials

6.6.4	Duff Depth (PNW).....	109
6.6.5	Litter Depth (PNW).....	109
6.6.6	Fuelbed Depth (PNW).....	109
<b>6.7</b>	<b>SAMPLING RESIDUE PILES WITHIN THE 58.9' MACROPLOT.....</b>	<b>109</b>
	SELECTION INSTRUCTIONS.....	110
6.7.1	Subplot Number (PNW).....	110
6.7.2	Condition Class (PNW).....	110
6.7.3	Pile Azimuth (PNW).....	111
6.7.4	Shape (PNW).....	111
6.7.5	Pile Length 1 (PNW).....	111
6.7.6	Pile Length 2 (PNW).....	111
6.7.7	Pile Width 1 (PNW).....	111
6.7.8	Pile Width 2 (PNW).....	112
6.7.9	Pile Height 1 (PNW).....	112
6.7.10	Pile Height 2 (PNW).....	112
6.7.11	Pile Density (PNW).....	112
6.7.12	Horizontal Distance to Pile (PNW).....	112



## Chapter 6: Down Woody Material

Down woody materials (DWM) are important components of forest ecosystems across the country. DWM is dead material on the ground in various stages of decay. Wildlife biologists, ecologists, mycologists, foresters, and fuels specialists are some of the people interested in DWM because it helps describe the:

- quality and status of wildlife habitats
- structural diversity within a forest
- fuel loading and fire behavior
- carbon sequestration-the amount of carbon tied up in dead wood
- storage and cycling of nutrients and water-important for site productivity.

Down woody components and fuels estimated by the FIA program are: coarse woody, fine woody, litter, herb/shrubs, slash, duff, and fuelbed. Any crew member can learn to collect down woody materials data.

DWM is only sampled in accessible forest conditions intersected by the transect. If a transect crosses a nonforest condition, the boundaries of the condition are recorded, but no DWM or fuels measurements are taken along this portion of the transect. On NFS lands in R5 and R6 DWM is sampled on transects that cross nonforest conditions. See Appendix 1 for special rules about nonforest plots/condition classes on R5 and R6 NFS lands. The majority of DWM in the inventory is sampled using the line intersect sampling method (also called planar intercept method). In this method, transects are established, and individual pieces of CWD or FWD are tallied if the central axis of the piece is intersected by the plane of the transect. In addition, each piece must meet specified dimensions and other criteria before being selected for tally. Special procedures apply when a CWD piece lays across a condition class boundary. Transects will always be used to sample FWD. Transects will be used to sample CWD when crews are able to see and measure individual pieces.

The line intersect method is not practical for sampling CWD when it is part of machine-piled windrows or slash piles, or part of log "jumbles" at the bottom of steep-sided ravines. In these situations, individual pieces are impractical to tally separately and are labeled as "residue piles". A different sampling method is used to tally and measure CWD residue piles (See "Sampling residue piles" in Section 6.7).

### 6.1 DEFINITION OF DOWN WOODY MATERIALS

#### CWD

In this inventory, CWD includes downed, dead tree and shrub boles, large limbs, and other woody pieces that are severed from their original source of growth and on the ground. CWD also includes dead trees (either self-supported by roots, severed from roots, or uprooted) leaning > 45 degrees from vertical. Also included are non-machine processed round wood such as fence posts and cabin logs. For multi-stemmed woodland trees such as juniper, only tally stems that are dead, detached, and on the ground; or dead and leaning > 45 degrees from vertical.

CWD does **not** include:

- Woody pieces < 3.0 inches in diameter at the point of intersection with the transect.
- Dead trees leaning 0 to 45 degrees from vertical
- Dead shrubs, self-supported by their roots.
- Trees showing any sign of life.
- Stumps that are rooted in the ground (i.e. not uprooted).
- Dead foliage, bark or other non-woody pieces that are not an integral part of a bole or limb. (Bark attached to a portion of a piece is an integral part).
- Roots or main bole below the root collar.

#### FWD

In this inventory, FWD includes downed, dead branches, twigs, and small tree or shrub boles that are not attached to a living or standing dead source. FWD can be connected to a larger branch, as long as this branch is on the ground and not connected to a standing dead or live tree. Only the woody branches, twigs, and fragments that intersect the transect are counted. FWD can be connected to a down, dead tree bole or down, dead shrub. FWD can be twigs from shrubs and vines. FWD must be no higher than 6 feet above the ground to be counted.

FWD does **not** include:

- Woody pieces  $\geq 3.0$  inches in diameter at the point of intersection with the transect.
- Dead branches connected to a live tree or shrub; or to a standing dead tree or dead shrub.
- Dead foliage (i.e. pine or fir needles, or leaf petioles).
- Bark fragments or other non-woody pieces that are not an integral part of a branch, twig, or small bole.
- Small pieces of decomposed wood (i.e. chunks of cubical rot)

## 6.2 LOCATING AND ESTABLISHING LINE TRANSECTS

Transects are established on each subplot if the subplot center is accessible (i.e. not census water, access denied, or hazardous), and there is at least one forest land condition class mapped within the 58.9 ft macroplot (CONDITION CLASS STATUS = 1). Transects begin at the subplot center and extend 58.9 feet horizontal distance to the edge of the macroplot. The location of condition class boundaries are recorded along the transect. It is extremely important to lay out the transect in a straight line to avoid biasing the selection of pieces and to allow the remeasurement of transect lines and tally pieces for future change detection.

Transect lines should be marked with a small piece of flagging at the end of the line (58.9 feet, horizontal distance) to help the QA staff identify the path of the transect during the check-plot procedure. Because the tolerance for the transect azimuth is  $\pm 2$  degrees, the line might have been laid down in a slightly different direction from the check-plot crew. This could affect the location of diameter measurements for CWD pieces as well as identifying whether a CWD piece is a valid tally piece. It is also helpful to mark the point where the FWD transect begins (14 feet, slope distance).

### CWD TRANSECTS

Two transects are established that originate at the subplot center and extend out 58.9-foot horizontal distance (the radius of the macroplot).

Transect orientation differs depending on subplot number (See Figure 6-1):

- Subplots 1 and 4: azimuths are 150 and 270 degrees (from subplot center).
- Subplots 2 and 3: azimuths are 30 and 150 degrees (from subplot center).

Note: the reasons that different azimuths were chosen are:

- to avoid sampling bias on sloped land, where it is possible that CWD may be oriented in one direction. This configuration of transects should pick up CWD logs that are lying parallel to the slope, perpendicular to the slope, and across slope;
- the outer ends of the transects do not meet at the edge of the macroplot, avoiding the possibility of double counting CWD tallied at the transect ends;
- these azimuths correspond to previously installed transects in the 3-year DWD pilot.

### FWD TRANSECTS

One transect is established on each subplot, along the 150 degree azimuth. FWD is tallied within 3 size classes. Because FWD is generally present in higher densities, a shorter transect will pick up an acceptable amount of tally. The transect begins at 14 feet (slope distance) from the subplot center and extends out either 6 or 10 feet (slope distance) depending on the FWD size class, as follows:

Category of FWD	Size Class	Diameter range	Transect length (slope distance)	Transect location (slope distance)
Small FWD	1	.01 in. to .24 in.	6 feet	14 to 20 feet
Medium FWD	2	0.25 in. to .9 in.	6 feet	14 to 20 feet
Large FWD	3	1.0 in. to 2.9 in.	10 feet	14 to 24 feet

Note that the FWD transects are slope distance not horizontal distance. The formulas used to estimate biomass from the data contain an adjustment for slope.

It is helpful to have a size gauge available until your eye is 'trained' to recognize the 3 size classes. Examples include a plastic or cardboard card with 3 notches cut for each size class, or a set of 3 dowels representing each size class.

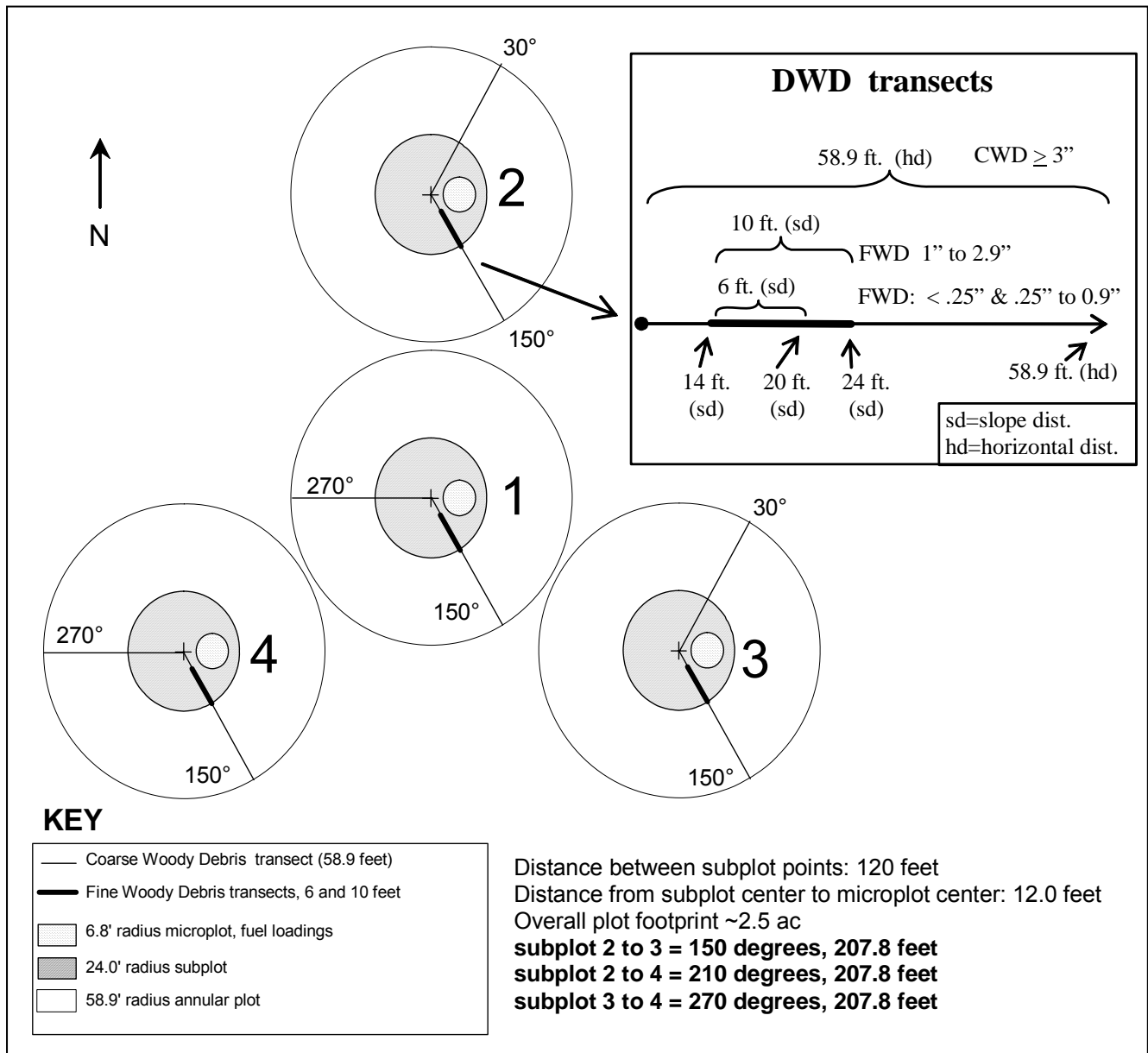

Figure 6-1: Line transect layout for sampling CWD and FWD on the subplot.

### 6.3 TRANSECT LINE SEGMENTING

Transect lines are segmented to determine the length of transect that occurs within each mapped condition class intersecting the line. A segment is a length of transect that is in one condition. Segments are identified by recording the Beginning Distance and Ending Distance of the slope from subplot center out to the end of the macroplot. In the office, the segmenting data will be combined with CWD distances to determine which condition class each piece falls in (condition classes are not assigned to CWD pieces in the field). If more than one condition is found on the FWD transects, the segmenting information recorded here, will provide the length of transect in each condition. Note: The following transect line segmenting variables are CORE data items for P3 plots.

Starting at the subplot center and working towards the fixed radius plot boundary, each segment of transect line in a different condition class is delineated and recorded as a separate record. On each record, the Beginning Distance and ending distance of the slope are recorded for each condition class encountered. The first record for each transect will have a Beginning Distance of 0 feet. If only one condition class occurs on the transect line, only one segment is recorded. The transect must extend a total of 58.9 feet horizontal distance. If the entire 58.9-foot subplot is nonforest, transect data are not required. Enter codes for Subplot Number, Transect, and Condition Class Number (see Appendix 1 for special rules about nonforest plots/condition classes on R5 and R6 NFS lands).

On subplots where a transect intersects a boundary between condition classes, the transect continues across the boundary into the adjacent class. **All condition class boundaries (beginning and ending distances) are recorded on each transect.**

Individual pieces of DWM intersected by a transect are tallied or counted if they meet the tally rules for CWD or FWD specified in the sections that follow. It is expected that the majority of FWD transects will be in one condition, but if the condition class changes along the transect, a count is recorded for each condition. Again, the segmenting data recorded here will identify which condition class is associated with each count.

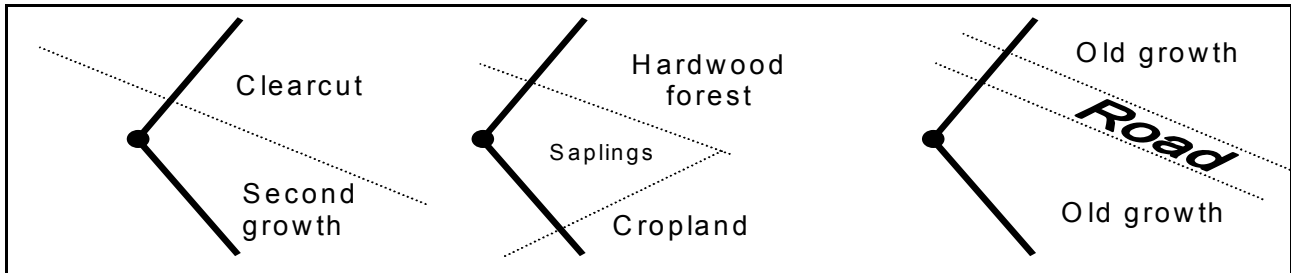

Figure 6.2: Transects installed across condition class boundaries:

**6.3.1 Subplot Number (PNW)**

Record the code indicating the subplot center from which the transect originates.

When collected:	All tally segments
Field width:	1 digit
Tolerance:	No errors
Values:	1 Center subplot 2 North subplot 3 Southeast subplot 4 Southwest subplot

**6.3.2 Transect (PNW)**

Record the code indicating the transect on which a condition class is being delineated. The three transects used are 30 degrees, 150 degrees, and 270 degrees. These transects, when being installed, have a tolerance of +/- 2 degrees.

When collected:	All tally segments		
Field width:	3 digits		
Tolerance:	No errors for code +/- 2 degrees for azimuth		
MQO:	At least 99% of the time		
Values:	<b>Code</b>	<b>Azimuth tolerance</b>	<b>Definition</b>
	030	30° +/- 2°	Transect extends 30° from subplot center
	150	150° +/- 2°	Transect extends 150° from subplot center
	270	270° +/- 2°	Transect extends 270° from subplot center

**6.3.3 Condition Class Number (PNW)**

Record the code indicating the number of the condition class for the transect segment. Use the same code used for CONDITION CLASS NUMBER, Section 4.4.1. The first segment recorded for each transect will have the same CONDITION CLASS NUMBER as assigned to the subplot center.

When collected:	All tally segments
Field width:	1 digit
Tolerance:	No errors
Values:	1 to 9 (See CONDITION CLASS NUMBER (4.2.1))

**6.3.4 Beginning Distance PNW (PNW)**

Beginning at subplot center, record the slope distance along the transect line where the transect intersects the boundary with the adjacent condition class nearer to the subplot center. The first record for each transect will have

a Beginning Distance of 0.0 feet. Each subsequent record will have a Beginning Distance equal to the Ending Distance of the previous record. Record to the nearest 0.1 foot.

When collected:	All tally segments
Field width:	3 digits
Tolerance:	+/- 1.0 foot
Values:	00.0 to 99.9

**6.3.5 Ending Distance (PNW)**

Record the slope distance along the transect line where the transect exits the condition class segment being delineated and intersects the boundary with a different condition class further away from the subplot center. If no other condition classes are encountered, record the slope distance on the transect line to the edge of the macroplot. Record to the nearest 0.1 foot.

When collected:	All tally segments
Field width:	3 digits
Tolerance:	+/- 1.0 foot
Values:	00.1 to 99.9

**6.3.6 Slope Percent (PNW)**

Record the code indicating the average slope percent along the transect within the condition class being segmented. When only one condition class is present on a transect, slope percent is the average slope percent along the entire transect. Measure to the nearest 5%.

When collected:	All tally segments
Field width:	3 digits
Tolerance:	+/- 10 %
Values:	005 to 155

**6.4 SAMPLING METHODS FOR COARSE WOODY DEBRIS (CWD)**

1. Coarse woody debris (CWD) is sampled in accessible forest land conditions only. Tally a piece if the central longitudinal axis intersects the transect, and the condition class is accessible forest land at the point of intersection (Figure 6-3). The entire piece is assigned to this condition class.

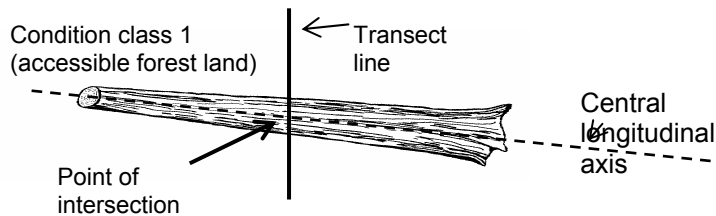

Figure 6-3: CWD tallied when central longitudinal axis intersects the transect.

2. Tally dead trees IF they are leaning > 45 degrees from vertical. Do not tally live trees or standing dead trees and stumps that are still upright and leaning < 45 degrees from vertical. Most CWD will be lying on the ground.
3. The minimum length of any tally piece is 3.0 feet. When CWD pieces are close to 3 feet, measure the length to the nearest 0.1 foot to determine if it is ≥ 3.0 feet.
4. Decay class of the piece determines whether or not the piece is tallied.

For decay classes 1 to 4: tally a piece if it is  $\geq 3.0$  inches in diameter at the point of intersection with the transect. The piece must be  $\geq 3.0$  feet in length and  $\geq 3.0$  inches or more in diameter along that length. If the intersect diameter is close to 3.0 inches, measure the diameter to the nearest 0.1 inches to determine if the piece qualifies.

For decay class 5: tally a piece if it is  $\geq 5.0$  inches in diameter at the point of intersection and  $\geq 5.0$  inches high from the ground. The piece must be  $\geq 3.0$  feet in length and  $\geq 5.0$  inches or more in diameter along that length. The reason for treating decay class 5 pieces differently is because they are difficult to identify, especially when heavily decomposed. Only pieces that still have some shape and log form are tallied—humps of decomposed wood that are becoming part of the duff layer, are not tallied. Do not record Diameter at the small end (6.4.7) and Diameter at the large end (6.4.8) for decay class 5.

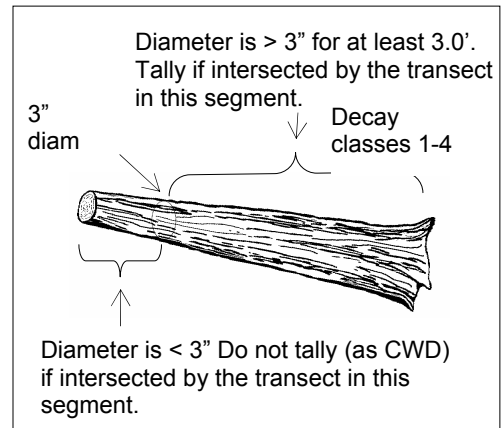

Figure 6-4: Tallying CWD for Decay Classes 1-4.

5. Tally pieces created by natural causes (examples: natural breakage or uprooting) or by human activities such as cutting only if not systematically machine-piled. Do not record pieces that are part of machine-piled slash piles or windrows, or that are part of a log "jumble" at the bottom of a steep-sided ravine in which individual pieces are impractical to tally separately. Instead, sample these piles according to instructions on "Sampling residue piles" (see Section 6.7). A slash pile or windrow consists of broken logs, limbs, and other vegetative debris.
6. Tally a piece only if the point of intersection occurs above the ground. If one end of a piece is buried in the soil, the piece ends at the point where it is no longer visible. Measure the diameter and length at this point.
7. If the central longitudinal axis of a piece is intersected more than once on a transect line or if it is intersected by two transect lines, tally the piece each time it is intersected (uncommon situation, see Figure 6-5).

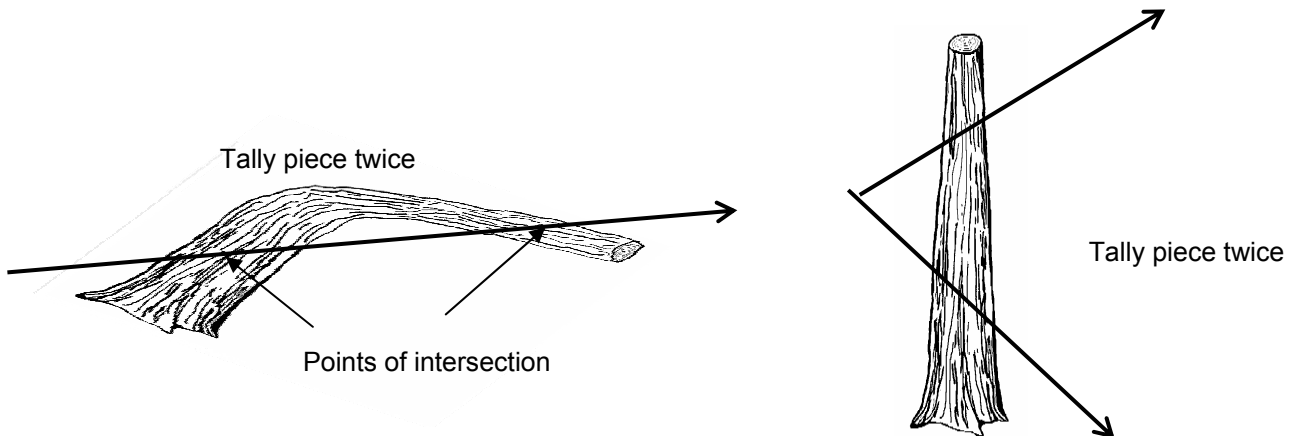

Figure 6-5: CWD tally rules: intersections.

8. Tally a piece only once if the subplot center falls directly on the central longitudinal axis of the piece. Tally the piece on the 30 degree transect on subplots 2 and 3, and on the 150 degree transect on subplots 1 and 4. Record the CWD Distance as 001.
9. If a piece is fractured across its diameter or length, and would pull apart at the fracture if pulled from either end or sides, treat it as two separate pieces. If judged that it would not pull apart, tally as one piece. Tally only the piece intersected by the transect line.
10. Do not tally a piece if it intersects the transect on the root side of the root collar. Do not tally roots.
11. When the transect crosses a forked down tree bole or large branch connected to a down tree (Figure 6-6), tally each qualifying piece separately. To be tallied, each individual piece must meet the minimum diameter and length requirements.

12. In the case of forked trees, consider the "main bole" to be the piece with the largest diameter at the fork. Characteristics for this fork such as length and decay class should pertain to the entire main bole. For smaller forks, or branches connected to a main bole (even if the main bole is not a tally piece) characteristics pertain only to that portion of the piece up to the point where it attaches to the main bole (see Figure 6-6).

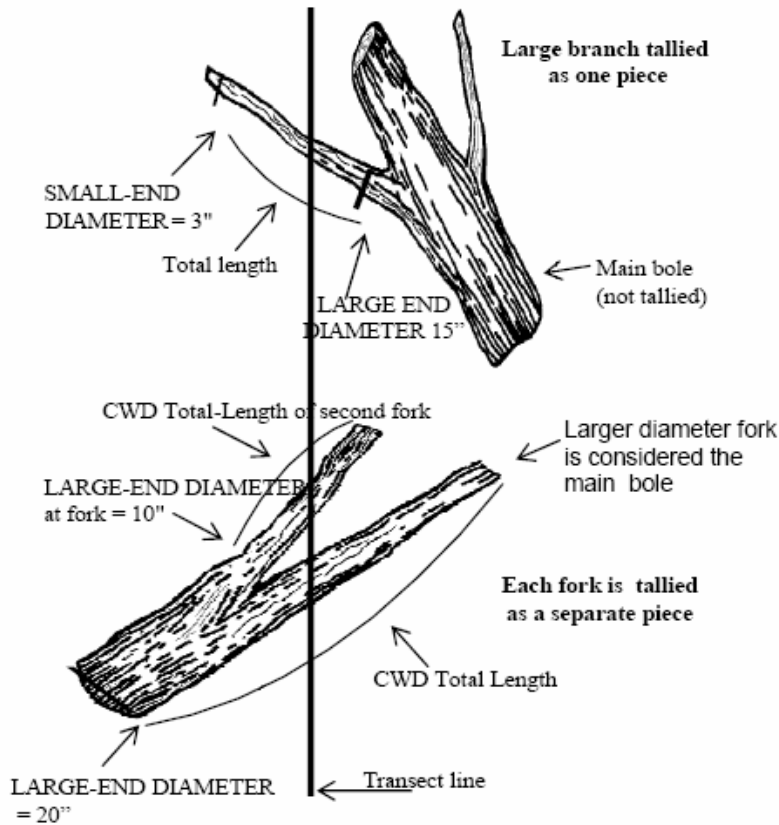
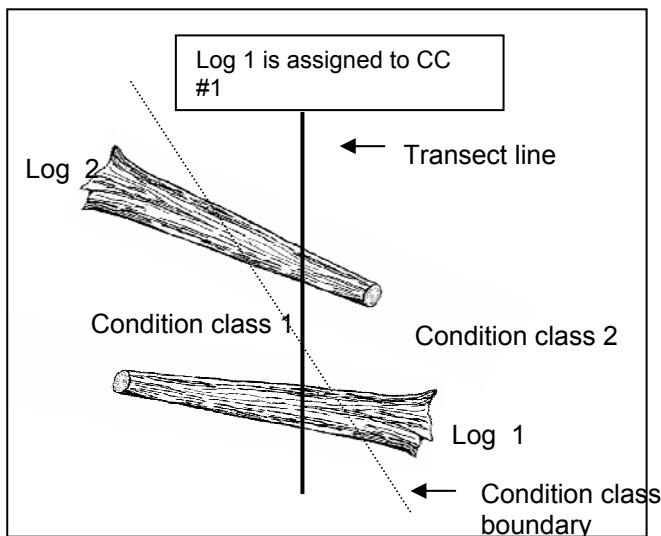

Figure 6-6: CWD tally rules for forked trees

Figure 6-6: CWD tally rules for forked trees

13. If a transect intersects a nonforest condition (e.g., a road), no CWD is tallied (see Appendix 1 for special rules about nonforest plots/condition classes on R5 and R6 NFS lands).



Note Crews do not actually record a condition class for each piece. The computer 'assigns' the piece to a condition class by comparing the recorded distance to the piece with the beginning and ending distances recorded for each condition class boundary.

Figure 6-7: A transect and two logs that cross two condition classes.

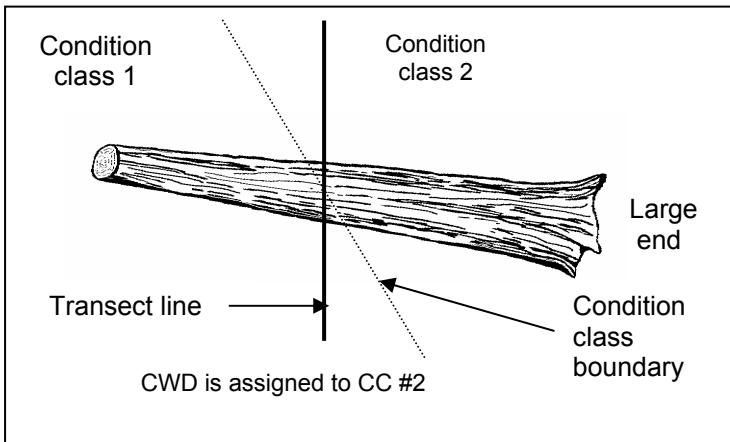

For example:  
 Slope distance to the point of intersection and the beginning boundary of condition class #2 is 15 feet.  
 The large end is in CC#2, so...  
 record the CWD DIST as 15.1 feet.  
 This forces the CWD piece into CC#2.

Figure 6-8: A transect that crosses a log at the boundary between two condition classes

**MARKING CWD**

Marking CWD is optional. Marked CWD is an aid to future crews returning to the plot for a QA check or to remeasure the plot at the next remeasurement period. Nails can be used to mark the location of the point of intersection, if the piece is in decay class 1, 2, or 3. Position the nail on top of the piece, and if possible, drive the nail into the piece so that about 1 inch of the nail is left exposed. Please see the section on Transect Segmenting, for information on the required marking of the transect line.

**RECORDING PROCEDURES FOR CWD**

The tolerance for the total number of pieces ( $\geq 3$  inches, transect diameter) tallied across all transects on the plot is: +/- 2 piece or +/- 5%, whichever is greater for the plot. Note: always round up to a whole piece count when using the 5% option.

**6.4.1 Subplot Number (PNW)**

Record the code indicating the number of the subplot center from which the transect originates.

When collected:	All tally pieces
Field width:	1 digit
Tolerance:	No errors
Values:	1) Center subplot; 2) North subplot; 3) Southeast subplot; 4) Southwest subplot

**6.4.2 Transect (PNW)**

Record the code indicating the azimuth of the transect on which the piece is sampled.

When collected:	All tally pieces
Field width:	3 digits
Tolerance:	No errors
Values:	030 Transect extends 30 degrees from subplot center 150 Transect extends 150 degrees from subplot center 270 Transect extends 270 degrees from subplot center

**6.4.3 CWD Slope Distance (PNW)**

Record the code indicating the slope distance from the subplot center to the point where the transect intersects the longitudinal center of the piece. If two or more pieces have the same slope distances, record the top piece first. Measure and record to the nearest 0.1 feet. CWD slope distance is an important item because it will be used to assign the CWD piece to a condition class by comparing the recorded distance to the piece with the recorded beginning distance and ending distance to the condition class boundary. CWD slope distance is also used to locate the piece for remeasurement in future inventories.

When collected:	All tally pieces
Field width:	3 digits
Tolerance:	+/- 1.0 ft
Values:	00.1 to 99.9



#### 6.4.4 CWD Decay Class (PNW)

Record a 1-digit code indicating the decay class of the piece. Code the decay class which predominates along the recorded CWD TOTAL LENGTH of the piece. Use the guide below to determine CWD DECAY CLASS.

When collected:	All tally pieces					
Field width:	1 digit					
Tolerance:	+/- 1 class					
Values:	Decay Class	Structural Integrity	Texture of Rotten Portions	Color of Wood	Invading Roots	Branches and Twigs
	1	Sound, freshly fallen, intact logs	Intact, no rot; conks of stem decay absent	Original color	Absent	If branches are present, fine twigs are still attached and have tight bark
	2	Sound	Mostly intact; sapwood partly soft (starting to decay) but can't be pulled apart by hand	Original color	Absent	If branches are present, many fine twigs are gone and remaining fine twigs have peeling bark
	3	Heartwood sound; piece supports its own weight	Hard, large pieces; sapwood can be pulled apart by hand or sapwood absent	Reddish-brown or original color	Sapwood only	Branch stubs will not pull out
	4	Heartwood rotten; piece does not support its own weight, but maintains its shape	Soft, small blocky pieces; a metal pin can be pushed into heartwood	Reddish or light brown	Through-out	Branch stubs pull out
	5	None, piece no longer maintains its shape, it spreads out on ground	Soft; powdery when dry	Red-brown to dark brown	Through-out	Branch stubs and pitch pockets have usually rotted down

Note: CWD DECAY CLASS 5 pieces can be difficult to identify because they often blend into the duff and litter layers. They must still resemble a log, therefore, the first tally rule is that they must be  $\geq 5.0$  inches in diameter,  $\geq 5.0$  inches from the surface of the ground, and at least 3.0 feet long. Decomposed logs that are slightly elevated 'humps' on the ground are not tallied.

CWD DECAY CLASS: The chart above was developed primarily for Douglas-fir in the Pacific Northwest. At the present time, there are no other charts available to use to describe decay classes for other species or locations. Concentrate on the structural integrity and texture when estimating a decay class for CWD logs.

If a log is case hardened (hard, intact outer sapwood shell) but the heartwood is rotten, code this log as a CWD DECAY CLASS 2 with a HOLLOW PIECE code of 1. CWD DECAY CLASS 1 should be reserved for 'freshly fallen' logs that are completely intact (i.e., recent windfalls, or harvest).

#### 6.4.5 Species (PNW)

Record the code indicating the species of the piece. Species codes are the same as those used for tree tally (see Appendix 9). Because CWD includes the tally of qualifying shrub boles, **enter a code of '001' for SPECIES if the tally piece is a shrub or vine.**

Species identification may be uncertain for some pieces. The piece's bark (either attached or sloughed and laying beside the piece), branching pattern (if the branches are still present), or heartwood smell (particularly if cedars, Douglas-fir, or western hemlock) may provide clues. On remeasurement plots, see what tree species were tallied in past inventories. One way to distinguish hardwoods from softwoods is by the type of decay present. Hardwoods usually have a white or grayish stringy rot, while softwoods usually have a reddish-brown blocky rot. If it is not

possible to identify the species, attempt to determine if it is a softwood or hardwood. Enter code 0299 for unknown conifer or 0998 for unknown hardwood.

When collected:	CWD Decay Class 1 to 4 tally pieces
Field width:	3 digits
Tolerance:	No errors
Values:	See Appendix 9 –Tree Species Lists

**DIAMETERS**

The diameter is most commonly measured by holding a tape above the log, at a position perpendicular to the length. It is useful to carry a steel carpenters retracting tape to measure diameters. Other methods include wrapping a tape around the bole if possible, holding a straight-edge ruler above the piece, or using calipers.

For pieces that are not round in cross-section because of missing chunks of wood or "settling" due to decay, measure the diameter in two directions and take an average. Estimate the longest and shortest axis of the cross-section ("A" and "B" in the diagram below), and enter the average in the diameter field. This technique applies to intersect, small-end, and large-end diameters.

If the transect intersects the log at the decayed or splintered end (i.e. the portion where it is not considered part of the log because it is falling apart), record the diameter at this location as the intersect diameter, but record the large end and small end diameter according to established rules (i.e. at the points where they best represent the log volume). If the splintered end appears to be two separate pieces (i.e. a major split located just at the end) treat it as one log and take a diameter around the end (take two measurements if it is odd shaped – Figure 6-9). Length is measured between the large and small end diameters (Figure 6-10).

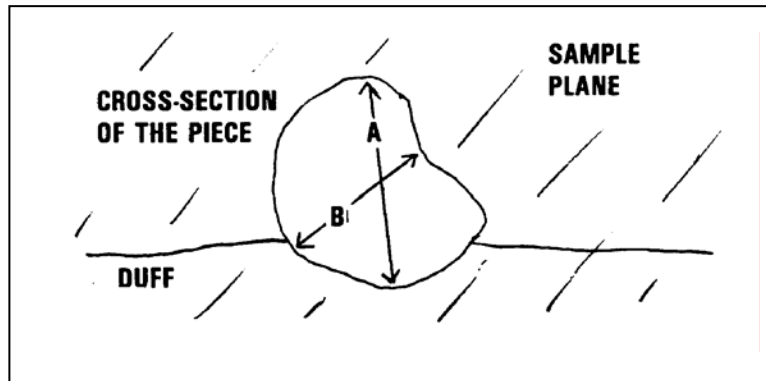

Figure 6-9: This figure illustrates how to measure the diameter of a splintered log

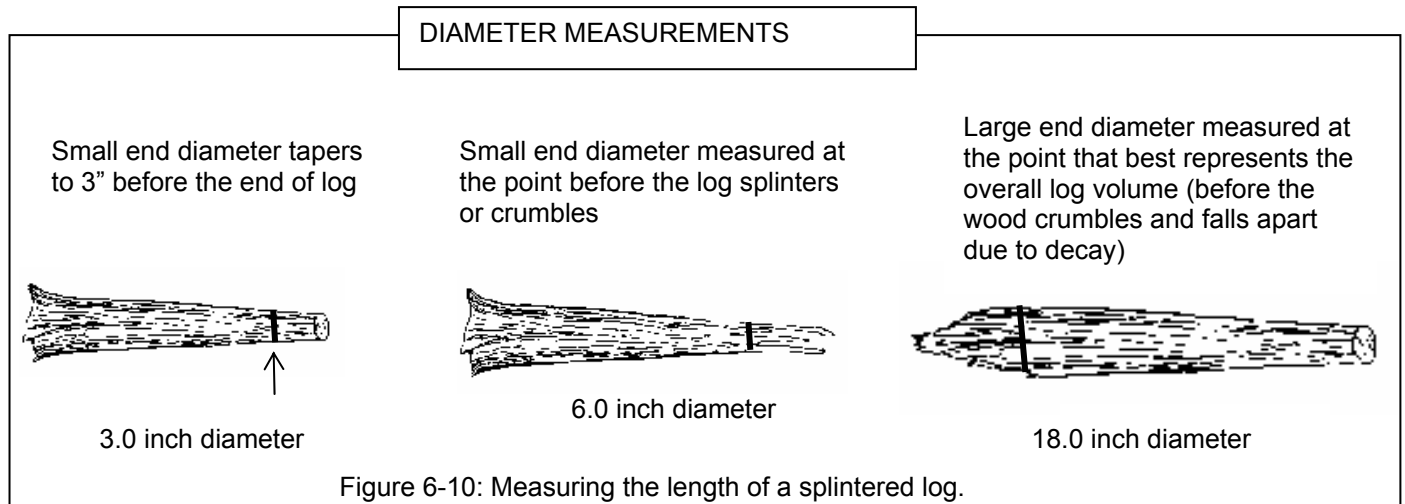

Figure 6-10: Measuring the length of a splintered log.

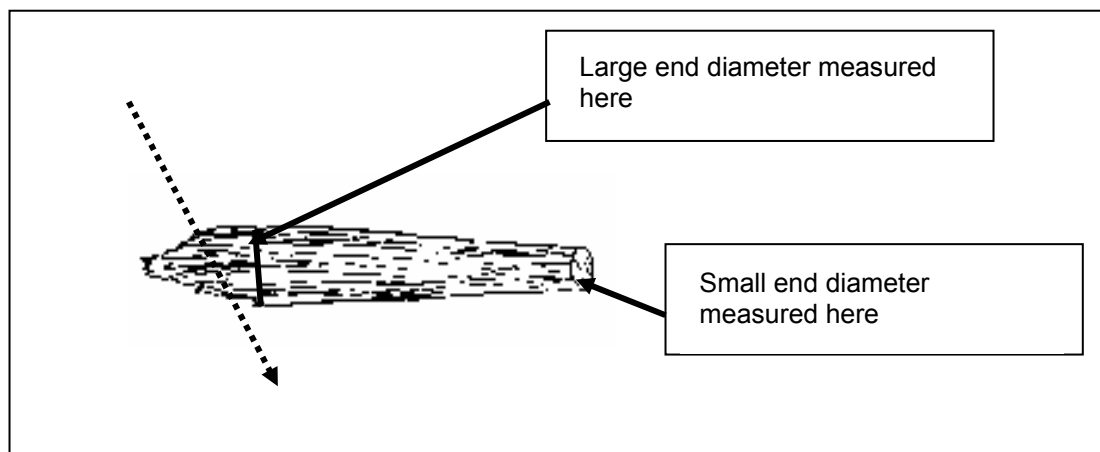

Figure 6-11: Measuring diameters on splintered logs.

#### 6.4.6 Diameter at Point of Intersection (PNW)

Record the code indicating the piece's diameter at the point where the transect intersects the longitudinal center of the piece. If the diameter is close to 3 inches, measure the diameter to the nearest 0.1 inch to determine if the piece is actually  $\geq 3.0$  inches and a valid tally piece. The diameter is recorded to the nearest inch.

When collected:	All tally pieces
Field width:	3 digits
Tolerance:	No errors on whether or not a piece is to be tallied Pieces < 20.0 inches diameter: +/- 3.0 inches Pieces > 20.0 inches diameter: +/- 20%
Values:	003 to 200

#### 6.4.7 Diameter at the Small End (PNW)

Record the code indicating the diameter at the piece's small end. The diameter is recorded to the nearest inch. The diameter at the small end occurs either at 1) the actual end of the piece, if the end has a diameter  $\geq 3.0$  inches, or 2) at the point where the piece tapers down to 3.0 inches in diameter. If the end is splintered or decomposing (sloughing off), measure the diameter at the point where it best represents the overall log volume. Use the same measuring procedures described for Diameter at Point of Intersection (6.4.6). See Figure 6-11.

When collected:	CWD Decay Class = 1 to 4
Field width:	3 digits
Tolerance:	Pieces < 20.0 inches diameter: +/- 2.0 inches Pieces > 20.0 inches diameter: +/- 10%
Values:	003 to 200

#### 6.4.8 Diameter at the Large End (PNW)

Record the code indicating the diameter at the piece's large end. The diameter is recorded to the nearest inch. The large end will occur either at a broken or sawn end, at a fracture, or at the root collar. If the end is splintered or decomposing (sloughing off), measure the diameter at the point where it best represents the overall log volume. Use the same measuring procedures used for Diameter at Point of Intersection (6.4.6).

When collected:	CWD Decay Class = 1 to 4
Field width:	3 digits
Tolerance:	Pieces < 20.0 inches diameter: +/- 2.0 inches Pieces > 20.0 inches diameter: +/- 15%
Values:	003 to 200

**6.4.9 CWD Total length (PNW)**

Record the code indicating the total length of the piece. CWD total length is the length of the piece that lies between the piece's recorded small and large end diameters (6.4.7 and 6.4.8). For Decay Class 5, small and large end diameters are not recorded for a log, therefore the length is measured between the two physical ends of the log. For curved logs, measure along the curve. The minimum log length is 3.0 feet before it is a valid tally log. CWD total length is recorded to the nearest foot.

When collected:	All tally pieces
Field width:	3 digits
Tolerance:	+ / - 20%
Values:	003 to 250

**6.4.10 Hollow (PNW)**

Record the code indicating whether or not the piece is hollow (See Figure 6-12). A piece is considered hollow if a cavity extends at least 2 feet along the central longitudinal axis of the piece, and the diameter of the entrance to the cavity is at least 1/4 of the diameter of the piece where the entrance occurs. The entrance occurs at the point where wood is present completely around the circumference of the cavity. The length of the cavity begins at this point.

When collected:	All CWD Decay Class = 1 to 4	
Field width:	1 digit	
Tolerance:	No errors	
Values:	<u>Code</u>	<u>Description</u>
	N	Does NOT meet criteria for being a hollow log
	Y	Does meet criteria for being a hollow log

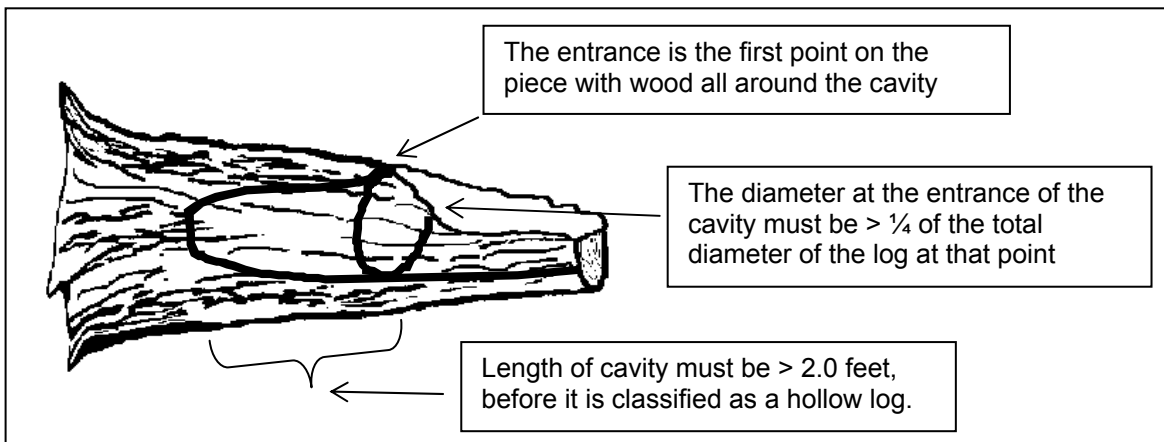

Figure 6-12: Hollow log with cavity

**6.4.11 Percent of Log Charred by Fire (PNW)**

Record a 1-digit code that represents the percentage of the log's surface area that has been charred by fire. Only examine the visible surface of the log. This data will be used by wildlife biologists to determine the impact fire has had on wildlife habitat. Wildlife tend to avoid charred logs because fire seals the wood making it slow to rot and hard to excavate.

When collected:	All tally pieces > 20 inches Transect Diameter and Decay Class 1, 2 or 3	
Field width:	1 digit	
Tolerance:	+/- 1 class	
Values:	0	None of the log is charred by fire
	1	Up to 1/3 of the log is charred by fire
	2	1/3 to 2/3 of the log is charred by fire
	3	2/3 or more of the log is charred by fire

**6.4.12 CWD History (PNW)**

Record the code that indicates whether or not the piece of CWD is on the ground as a result of harvesting operations or as a result of natural circumstances. One objective of this Item is to identify those pieces that are considered logging residue. If the piece appears to have fallen to the ground as a result of natural causes such as decomposition or windfall, enter a code of 1. This category would include blown out tops, snapped off boles, wind-fallen trees on clearcut edges, and trees that basically collapsed and fell over due to decomposition.

If the piece is on the ground as a result of RECENT (since last annual remeasurement; if the plot is new, the time between the panel remeasurements) harvesting activity, either because the tree was cut down with a chainsaw (or other device) or pushed over by harvesting equipment (bulldozer), enter a code of 2. A code of 2 would be considered logging residue (usually in a recent clearcut).

If the piece is on the ground as a result of OLDER (more than 15 years) harvesting activity, enter a code of 3. This would be a situation where you tally an old decomposing log that has a sawn end – if it appears that the log was cut and left on site, then enter a code of “3”.

If a piece is on the ground as a result of incidental harvest (such as a standing tree was cut for firewood or small clearing), enter a code of “4”. Incidental harvest involves a few trees and is not a part of a major organized harvesting operation.

If the crew cannot decide the history of the CWD log, classify it as “unknown”, and record code of “5”.

When collected:	CWD Decay Class = 1 to 4
Field width:	1 digit
Tolerance:	No errors
Values:	1 CWD piece is on the ground as a result of natural causes 2 CWD piece is on the ground as a result of major RECENT harvest activity (<=15 yrs old) 3 CWD piece is on the ground as a result of OLDER harvest activity(>15 yrs old) 4 CWD piece is on the ground as a result of an incidental harvest (such as firewood cutting) 5 Exact Reason Unknown

**6.5 SAMPLING METHODS FOR FINE WOODY DEBRIS (FWD)**

Fine Woody Debris (FWD) is only sampled in accessible forest conditions intersected by the transect. The length of FWD transects are measured in slope distance--no correction is applied to obtain a horizontal distance. The FWD transects start at 14 feet slope distance and extend for 6 or 10 feet slope distance. Estimates of FWD biomass calculated in the office, will include a slope correction factor obtained from the transect segmenting data on the subplot.

Only sample FWD that intersects the transect from the ground to a height of 6 feet.

FWD is sampled in three size classes, on the 150 degree azimuth transect. Two of the FWD size classes (0.01 to 0.24 inches and 0.25 to 0.9 inches) are counted on a 6 foot transect, from 14 to 20 feet. Pieces in the third size class (1.0 to 2.9 inches) are counted on a 10 foot transect, from 14 to 24 feet (see Sections 6.2 and 6.3 for details on transects). These transects overlap. Note: individual diameters are not recorded for FWD. Only count a piece of FWD if it intersects the transect, and if the twig, branch, wood fragment (splinters), or shrub/tree bole are woody. Do not count conifer needles or non-woody parts of a tree or shrub. Do not count rotted pieces of a larger log.

Accumulate the number of pieces counted within each size class and enter the total count on one record for the subplot (unless there are >1 condition classes). If there is no tally on a transect, enter zero’s for the count. Count only what can be seen from a “bird’s-eye view”; do not dig under any litter or debris to count pieces not normally seen.

Accurate counts of FWD can be conducted efficiently up to about 50 pieces for small and medium size classes, and up to 20 pieces for the large size class. After that, crews can begin estimating counts in a systematic fashion. Transects that fall on very dense FWD where counting is nearly impossible, can be subsampled and calculated. For example, an accurate count can be conducted on a 2.0 foot-section of the transect and then multiplied by 3 to provide an estimate for the 6 foot transect, as long as the crew feels that the remaining transect has a similar density of FWD pieces.

If a transect intersects a large pile of material such as a wood rat's nest or a recently fallen tree (with many attached fine branches), crews should estimate a count based on Item 5 above, but also enter a code indicating that this is an unusual situation (see HIGH COUNT REASON below).

If rocks, logs, or other obstructions are present along the transect (14 to 24 foot section) include any FWD that is present on top of these obstructions in the respective FWD counts. If the obstructions are so large (huge boulder) that the top surface cannot be seen, assume the count is Zero in this area, and continue counting if there is transect line beyond the boulder.

If a residue pile intersects the FWD transect **at any point** along the 14 to 24 foot section, **do not measure FWD on this transect**. It is too subjective determining exact boundaries of the pile, and how they relate to the exact point on the transect line. To identify this situation, code 1 in RESIDUE PILE ON TRANSECT which indicates that a residue pile has intersected the transect line.

If a transect crosses a condition class boundary, record the condition class number and enter a count for each condition on separate records. Transect lengths within each condition class will be obtained from the transect segmenting data entered for the subplot.

### 6.5.1 Subplot Number (PNW)

Record the code indicating the subplot center from which the transect originates.

When collected:	All tally segments
Field width:	1 digit
Tolerance:	No errors
Values:	1) Center subplot; 2) North subplot; 3) Southeast subplot; 4) Southwest subplot

### 6.5.2 Condition Class Number (PNW)

Record the code indicating the number of the condition class that pertains to the FWD count.

When collected:	All tally segments
Field width:	1 digit
Tolerance:	No errors
Values:	1 to 9

### 6.5.3 Residue Pile on Transect (PNW)

Enter a code that indicates whether a residue pile intersects the FWD transect segment. The default is always 0; crews will enter a 1 if the situation is encountered on the transect.

When collected:	On all FWD transects (between 14 and 24 feet)
Field width:	1 digit
Tolerance:	No errors
Values:	0 There is no residue pile on the transect 1 There is a residue pile on the transect

### 6.5.4 Small FWD Count (PNW)

Record the number of pieces counted in this size class (0.01 to 0.24 inch diameter) along the transect segment. An accurate count should be conducted up to 50 pieces. If the count exceeds 50, the transect can be subsampled to estimate a total count for the transect segment.

When collected:	On the 150 degree transect in CONDITION CLASS STATUS = 1, when Residue Pile on Transect (6.5.3) = 0
Field width:	3 digits
Tolerance:	0 to 50 +/- 20% of the total count for the transect 51 to 100 +/- 25% of the total count for the transect 100 +/- 50% of the total count for the transect (if Slope Percent (6.3.6) > 0)
Values:	000 to 999

**6.5.5 Medium FWD Count (PNW)**

Record the number of pieces counted in this size class (0.25 TO 0.9 inch diameter) along the transect segment. An accurate count should be conducted up to 50 pieces. If the count exceeds 50, the transect can be subsampled to estimate a total count for the transect segment.

When collected:	On the 150 degree transect in CONDITION CLASS STATUS = 1, when Residue Pile on Transect (6.5.3) = 0
Field width:	3 digits
Tolerance:	+/- 20% of the total count for the transect
Values:	000 to 999

**6.5.6 Large FWD Count (PNW)**

Record the number of pieces counted in this size class (1.0 to 2.9 inch diameter) along the transect segment. An accurate count should be conducted up to 20 pieces. If the count exceeds 20, the transect can be subsampled to estimate a total count for the transect segment.

When collected:	On the 150 degree transect in CONDITION CLASS STATUS = 1, when Residue Pile on Transect (6.5.3) = 0
Field width:	3 digits
Tolerance:	+/- 20% of the total count for the transect
Values:	000 to 500

**6.5.7 High Count Reason (PNW)**

Enter the appropriate code when the count on a transect exceeds 100 pieces.

When collected:	When any count on the transect >100
Field width:	1 digit
Tolerance:	No errors
Values:	0 FWD is not unusually high 1 High count is due to an overall high density of FWD across the transect 2 Wood Rat's nest located on transect 3 Tree or shrub laying across transect 4 Other reason

**6.6 DUFF, LITTER, AND FUELBED DEPTH MEASUREMENTS**

Depth measurements are sampled in accessible forest land conditions. The depth of the duff layer, litter layer, and overall fuelbed are important components of fire models used to estimate fire behavior, fire spread, fire effects, and smoke production. These measurements are taken at the 24 foot location on each transect. Mark the location that depth measurements are taken with a small piece flagging. An average depth will be calculated in the office and stored with other information about the condition class on the plot. **If a residue pile, log, rock, or other obstruction intersects the transect at the 24 ft location, DO NOT measure the duff or litter depth. But, DO measure the fuelbed depth if the obstruction is a log or residue pile.**

**DEFINITIONS**

1. Litter is the layer of freshly fallen leaves, needles, twigs (< 0.25 inch in diameter), cones, detached bark chunks, dead moss, dead lichens, detached small chunks of rotted wood, *dead grasses*, dead herbaceous stems and flower parts (detached and not upright). Litter is the loose plant material found on the top surface of the forest floor. Little decomposition has begun in this layer.

Litter is flash fuel – so think about it as the loose material that is exposed to the air, capable of igniting quickly and carrying a fire across the surface of the forest floor.

Litter does not include bark that is still attached to a down log, or rotten chunks of wood that are still inside a decaying log or log end (i.e. if a decayed log end has a lot of rotten cubes or pieces laying on a log surface and exposed to air, they are considered part of the log and not litter – fire would burn differently if it hit a pile of rotten punky wood chips, cradled by the unrotted sapwood shell). If these rotten chunks have spilled out to the ground and are actually on the ground surface, then they would be included in the litter layer.

Litter does not include animal manure.

Microplot estimates: *Litter is the material that can be seen on the surface of the forest floor; it does not include litter underneath a log or other obstruction.*

2. Duff is the layer just below litter. It consists of decomposing leaves and other organic material. You should see NO recognizable plant parts, the duff layer is usually dark decomposed organic matter. When moss is present, the top of the duff layer is just below the green portion of the moss. The bottom of this layer is the point where mineral soil (A horizon) begins.
3. The fuelbed is the accumulated mass of dead, woody material on the surface of the forest floor. It begins at the top of the duff layer, and includes litter, FWD, CWD, and dead woody shrubs. In this definition, the fuelbed does not include dead hanging branches from standing trees or standing dead seedlings or saplings.

**OVERVIEW OF MEASUREMENTS**

Depth measurements will be taken at the 24 foot (slope distance) location on each transect: If a log, rock or other obstruction occurs at the sample location do not measure duff or litter depth, regardless of what is on top of the obstruction. However, if the obstruction is a log, proceed with the fuelbed depth estimate.

The DUFF, LITTER, AND FUELBED SAMPLE variable has three options for indicating if duff, litter, and/or fuelbed were measured at each sample location. The default value for this variable is 1, indicating that all three variables were measured (duff, litter, and fuelbed). A value of 0 is entered if duff and litter were not sampled (obstruction), but fuelbed was sampled. A value of 2 is entered if none of the three (duff, litter, and the fuelbed) were sampled (i.e., submerged part of plot).

Duff and Litter: The duff layer is the organic material layer between the A-horizon (or uppermost soil mineral horizon) and the litter layer. The duff is a soil layer dominated by organic material derived from the decomposition of plant and animal litter (pine straw, leaves, twigs, etc) and deposited on either an organic or a mineral surface. This layer is distinguished from the litter layer in that the original organic material has undergone sufficient decomposition that the source of this material (e.g., individual plant parts) can no longer be identified. Litter is defined as undecomposed or only partially decomposed organic material that can be readily identified (e.g., plant leaves, twigs, etc.). As a general rule, duff depth should rarely exceed a few inches. Crews should be absolutely sure they are measuring deep duff depths, instead of mineral soil layers or parts of the litter layer. Duff can easily weigh more than 6 times that of litter. If unsure of the bottom of the duff layer, crews should feel the texture of the suspect material in their hand. Rub the soil between your fingers. Does it crumble (duff) or feel more like modeling clay (mineral).

Carefully expose a shallow profile of the forest floor by digging out an area at the sample point using a knife, hatchet, or other tool. Estimate the depth of each layer with a ruler to the nearest 0.1 inch. If there is a log, rock, or other obstruction on the surface at the sample point, do not measure the litter or duff depth (record DUFF, LITTER, AND FUELBED SAMPLE = N); a value of 99.9 will be entered by the program for each depth. As you dig the hole for this measurement, if you encounter a rock, root, or buried log – stop the depth measurement at this point.

The height of the litter should be measured at the top of the loose material located at the sample point on the transect. Try to preserve the conditions of this location by walking around this point, so the QA staff will measure the same height as the original crew.

Fuelbed: Measure the height of the fuelbed from the top of the duff layer (just below the litter) to the highest piece of woody debris found at the transect point. Round to the nearest 0.1 foot. If a rock or other obstruction occurs at the 24.0 foot sample location, do not measure fuelbed depth. Logs are not considered an obstruction to Fuelbed measurements.

**6.6.1 Subplot Number (PNW)**

Record the code indicating the number of the subplot center from which the transect originates.

When collected:	All tally segments
Field width:	1 digit
Tolerance:	No errors
Values:	1) Center subplot; 2) North subplot; 3) Southeast subplot; 4) Southwest subplot



### 6.6.2 Transect (PNW)

Record the code indicating the azimuth of the transect.

When collected:	All tally segments
Field width:	3 digits
Tolerance:	No errors
Values:	030 Transect extends 30 degrees from subplot center 150 Transect extends 150 degrees from subplot center 270 Transect extends 270 degrees from subplot center

### 6.6.3 Duff, Litter, and Fuelbed Sample (PNW)

Record the code indicating if the depth of the duff and litter layer was measured.

When collected:	At 24.0 ft on each transect
Field width:	1 digit
Tolerance:	No errors
Values:	0 Duff and litter depth not sampled; Fuelbed is sampled 1 All sampled; Duff, litter, and fuelbed 2 Nothing sampled; Duff litter, fuelbed are not sampled

### 6.6.4 Duff Depth (PNW)

Record the code indicating the depth of the duff layer to the nearest 0.1 inch.

When collected:	At 24.0 ft on each transect
Field width:	3 digits
Tolerance:	+/- 0.5 inch
Values:	00.0 to 99.9 inches

### 6.6.5 Litter Depth (PNW)

Record the code indicating the depth of the litter layer to the nearest 0.1 inch.

When collected:	At 24.0 ft on each transect
Field width:	3 digits
Tolerance:	+/- 0.5 inch
Values:	00.0 to 99.9 inches

### 6.6.6 Fuelbed Depth (PNW)

Record the code indicating the depth of the fuelbed layer, to the nearest 0.1 foot. If the fuelbed depth is > 0 and <= 0.1 foot enter 0.1 foot. In this situation finer depth resolution will be obtained from the duff and litter measurements.

When collected:	At 24.0 ft on each transect
Field width:	3 digits
Tolerance:	+/- 20%
Values:	00.0 to 99.9 feet

## 6.7 SAMPLING RESIDUE PILES WITHIN THE 58.9' MACRO PLOT

The line transect method is not practical when sampling CWD within piles and windrows. Piles and windrows will be located and sampled on the 58.9-foot macroplot, regardless of whether they intersect a transect.

Piles and windrows created directly by human activity and log piles at the bottom of steep-sided ravines in which individual pieces are impossible to tally separately, are more efficiently sampled by using the following instructions. However, loose CWD in piles created by wind throw, landslides, fires, and other natural causes should be tallied using line transects (if this material intersects the established transects on the subplot) unless it is physically impossible to measure the pieces in the natural pile.

**SELECTION INSTRUCTIONS**

For a pile to be tallied on a subplot that contains forest land, all of the following criteria must be met;

- The pile's center must be within 58.9 horizontal feet of subplot center.
- The pile's center must be in an accessible forestland condition class.
- The pile contains any pieces of CWD  $\geq 3.0$  inches that would be impossible to tally separately.

Use the PILE DENSITY variable to estimate the percent of the pile that contains woody material  $\geq 3$  inches. The pile is assigned to the condition class in which the pile center lies.

**Apply the following steps to determine the center of a pile or windrow:**

1. Determine the longest axis of a pile.
2. Determine the midpoint of this axis.
3. Project a line through this midpoint that is perpendicular to the axis determined in step 1.
4. Determine the midpoint of the segment of this projected line that crosses the pile.
5. This is the center of the pile.

**Piles that cross the 58.9-foot fixed-radius macroplot boundary:** If the center of a pile is within 58.9 horizontal feet of subplot center, tally the pile, recording the dimensions of the entire pile even if part of the pile is beyond 58.9 feet. If the center of a pile is more than 58.9 horizontal feet of subplot center, do not tally the pile or any portion of the pile.

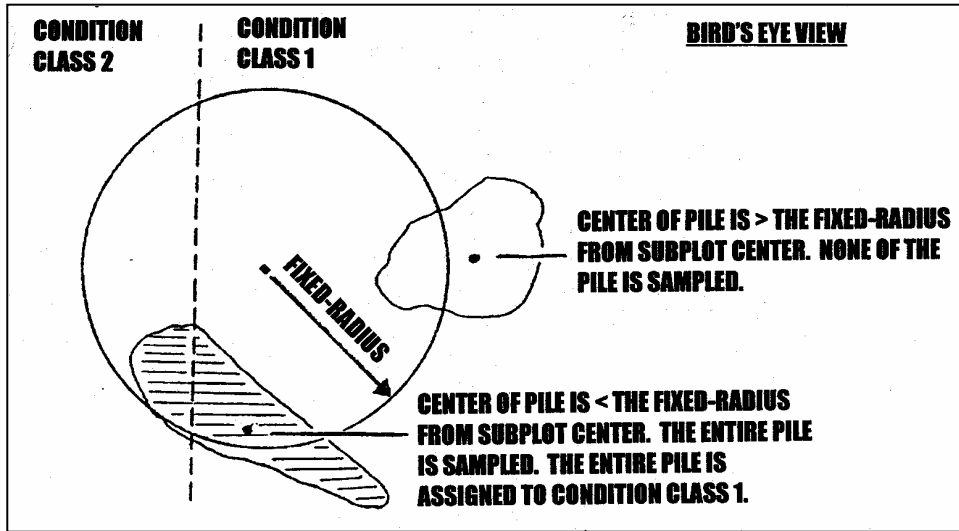

Figure 6-13: A residue pile that crosses the 58.9 foot macroplot boundary.

**6.7.1 Subplot Number (PNW)**

Record the code indicating the subplot number.

When collected:	Record for all sampled residue piles
Field width:	1 digit
Tolerance:	No errors
MQO:	At least 99% of the time
Values:	1) Center subplot; 2) North subplot; 3) Southeast subplot; 4) Southwest subplot

**6.7.2 Condition Class (PNW)**

Record the code indicating the number of the condition class to which the pile is assigned. Use the same code used for CONDITION CLASS NUMBER in Section 4.4.1.

When collected:	Record for all sampled residue piles
Field width:	1 digit
Tolerance:	No errors
Values:	1 to 9

### 6.7.3 Pile Azimuth (PNW)

Record the code indicating the azimuth from the subplot center to the pile center so that it can be relocated. Record 000 for subplots on which no piles are tallied. Use 360 for north.

When collected:	All sampled residue piles
Field width:	
Tolerance:	+/- 10
Values:	001 to 360

### 6.7.4 Shape (PNW)

Record the code indicating the shape of the pile. Determine which of the four shapes diagrammed below most resembles the pile and record the dimensions. Pile dimensions should be ocularly smoothed out when making estimates. Average the unevenness of protruding pieces.

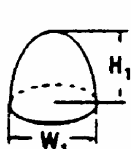
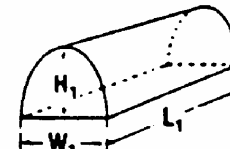
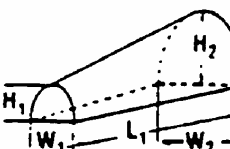
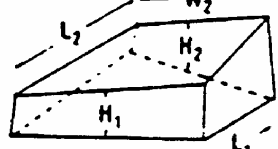
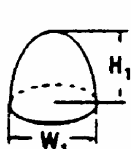
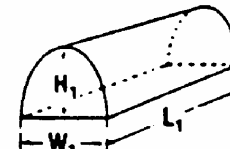
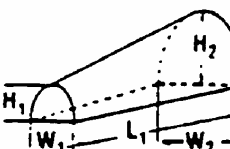
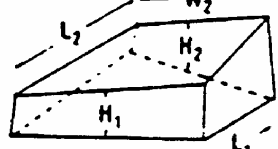
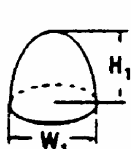
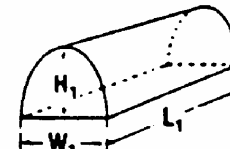
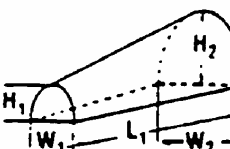
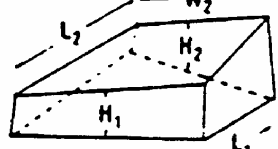
When collected:	All sampled residue piles												
Field width:	1 digit												
Tolerance:	No errors												
Values:	<table border="1" style="width: 100%; text-align: center;"> <tr> <th>SHAPE CODE 1</th> <th>SHAPE CODE 2</th> <th>SHAPE CODE 3</th> <th>SHAPE CODE 4</th> </tr> <tr> <td></td> <td></td> <td></td> <td></td> </tr> <tr> <td>RECORD W<sub>1</sub>H<sub>1</sub></td> <td>RECORD W<sub>1</sub> H<sub>1</sub>L<sub>1</sub></td> <td>RECORD W<sub>1</sub> H<sub>1</sub> W<sub>2</sub> H<sub>2</sub> L<sub>1</sub></td> <td>RECORD W<sub>1</sub> H<sub>1</sub> W<sub>2</sub> H<sub>2</sub> L<sub>1</sub> L<sub>2</sub></td> </tr> </table>	SHAPE CODE 1	SHAPE CODE 2	SHAPE CODE 3	SHAPE CODE 4					RECORD W <sub>1</sub> H <sub>1</sub>	RECORD W <sub>1</sub> H <sub>1</sub> L <sub>1</sub>	RECORD W <sub>1</sub> H <sub>1</sub> W <sub>2</sub> H <sub>2</sub> L <sub>1</sub>	RECORD W <sub>1</sub> H <sub>1</sub> W <sub>2</sub> H <sub>2</sub> L <sub>1</sub> L <sub>2</sub>
SHAPE CODE 1	SHAPE CODE 2	SHAPE CODE 3	SHAPE CODE 4										
													
RECORD W <sub>1</sub> H <sub>1</sub>	RECORD W <sub>1</sub> H <sub>1</sub> L <sub>1</sub>	RECORD W <sub>1</sub> H <sub>1</sub> W <sub>2</sub> H <sub>2</sub> L <sub>1</sub>	RECORD W <sub>1</sub> H <sub>1</sub> W <sub>2</sub> H <sub>2</sub> L <sub>1</sub> L <sub>2</sub>										

### 6.7.5 Pile Length 1 (PNW)

Record the code indicating the length of the sides of the pile. Estimate to the nearest foot. Pile length 1 may often equal pile length 2.

When collected:	All sampled residue piles and SHAPE = 1, 2, 3, 4
Field width:	2 digits
Tolerance:	+/- 10%
Values:	1 to 99

### 6.7.6 Pile Length 2 (PNW)

Record the code indicating the length of the sides of the pile. Estimate to the nearest foot. PILE LENGTH 1 may often equal PILE LENGTH 2.

When collected:	All sampled residue piles and SHAPE = 4
Field width:	2 digits
Tolerance:	+/- 10%
Values:	01 to 99

### 6.7.7 Pile Width 1 (PNW)

Record the code indicating the width of the sides of the pile. Estimate to the nearest foot. Pile width 1 may often equal pile width 2.

When collected:	All sampled residue piles and SHAPE = 1, 2, 3, 4
Field width:	2 digits
Tolerance:	+/- 10%
Values:	01 to 99

**6.7.8 Pile Width 2 (PNW)**

Record the code indicating the width of the sides of the pile. Estimate to the nearest foot. PILE WIDTH 1 may often equal PILE WIDTH 2.

When collected:	All sampled residue piles and SHAPE = 3, 4
Field width:	2 digits
Tolerance:	+/- 10%
Values:	01 to 99

**6.7.9 Pile Height 1 (PNW)**

Record the code indicating the height of either end of the pile. Estimate to the nearest foot. Pile height 1 may often equal Pile height 2.

When collected:	All sampled residue piles and SHAPE = 1, 2, 3, 4
Field width:	2 digits
Tolerance:	+/- 10%
Values:	01 to 99

**6.7.10 Pile Height 2 (PNW)**

Record the code indicating the height of either end of the pile. Estimate to the nearest foot. PILE HEIGHT 1 may often equal PILE HEIGHT 2.

When collected:	All sampled residue piles and SHAPE = 3, 4
Field width:	2 digits
Tolerance:	+/- 10%
Values:	01 to 99

**6.7.11 Pile Density (PNW)**

Record the code estimating the percent of the pile that consists of wood. Visualize the shape of the pile you selected in Item 4, and factor air, soil, rock, plants out of the estimate. Estimate to the nearest 10 percent.

When collected:	All sampled residue piles
Field width:	
Tolerance:	+/- 20%
Values:	00 Absent 01 Trace (< 1% cover) 10 1 – 10% 20 11-20% 30 21-30% .. .. 90 81-90% 99 91-100%

**6.7.12 Horizontal Distance to Pile (PNW)**

Record the horizontal distance from subplot center to the center of the residue pile for piles recorded on co-located Phase 2 and Phase 3 plots. Estimate to the nearest foot. The Horizontal distance recorded for each pile must reflect the size radius plot the pile actually occurs in. For example: a pile at 24 feet has a distance tolerance of +/- 1 foot, but its distance must be recorded as < 24 or the recorded distance is incorrect.

When collected:	All sampled residue piles on co-located Phase 2 and Phase 3 plots
Field width:	2 digits
Tolerance:	Subplot: +/- 1 foot Macroplot: +/- 10 feet
Values:	00 to 59

## 7 LIVE AND STANDING DEAD TREE TALLY

### Table of Contents

<b>7</b>	<b>LIVE AND STANDING DEAD TREE TALLY .....</b>	<b>113</b>
	DEFINITIONS .....	115
<b>7.1</b>	<b>SELECTING TALLY TREES.....</b>	<b>115</b>
	WHERE TO TALLY .....	115
	WITHIN PLOT AREA CRITERIA .....	116
	ADDITIONAL CRITERIA .....	116
<b>7.2</b>	<b>CONDUCTING THE TREE TALLY .....</b>	<b>117</b>
	CONDITION CLASS STATUS = 1: ACCESSIBLE FOREST LAND.....	117
	CONDITION CLASS NOT ACCESSIBLE FOREST LAND & NOT R6 OR R5 NATIONAL FORESTS .....	118
<b>7.3</b>	<b>PDR GENERATED TRACKING VARIABLES.....</b>	<b>118</b>
7.3.1	Line Number (PNW).....	118
7.3.2	TREE RECORD NUMBER (CORE 5.2).....	118
7.3.3	SUBPLOT NUMBER (CORE 5.1).....	118
<b>7.4</b>	<b>FIELD GENERATED TRACKING VARIABLES.....</b>	<b>118</b>
7.4.1	Tree Tag Number (PNW) .....	119
7.4.2	Previous Tree Tag Number (PNW).....	119
7.4.3	CONDITION CLASS NUMBER (CORE 5.3) .....	119
7.4.4	PREVIOUS TREE STATUS (CORE 5.6).....	120
7.4.5	Subplot Witness Flag (PNW) .....	120
7.4.6	PRESENT TREE STATUS (CORE 5.7).....	120
7.4.7	STANDING DEAD (CORE 5.7.2).....	121
7.4.8	RECONCILE (CORE 5.7.1) .....	122
7.4.9	SPECIES (CORE 5.8).....	123
<b>7.5</b>	<b>MONUMENTING INFORMATION.....</b>	<b>123</b>
7.5.1	AZIMUTH (CORE 5.4) .....	123
7.5.2	HORIZONTAL DISTANCE (CORE 5.5) .....	124
7.5.3	Witness Tree or Object Slope Distance (PNW) .....	124
<b>7.6</b>	<b>DIAMETER .....</b>	<b>124</b>
	MARKING CURRENT DIAMETER:.....	125
7.6.1	PREVIOUS DIAMETER AT BREAST HEIGHT (CORE 5.9.1).....	125
7.6.2	DIAMETER AT BREAST HEIGHT (CORE 5.9.2).....	126
	SPECIAL DBH SITUATIONS .....	126
7.6.3	PREVIOUS DIAMETER AT ROOT COLLAR (CORE 5.9.3).....	129
	DIAMETER AT ROOT COLLAR (CORE 5.9.4) .....	129
7.6.4	DRC STEM DIAMETER (CORE 5.9.4.1).....	130
7.6.5	DRC STEM STATUS (CORE 5.9.4.2).....	130
7.6.6	PAST NUMBER OF STEMS (CORE 5.10).....	131
7.6.7	CURRENT NUMBER OF STEMS (CORE 5.11).....	131
7.6.8	DIAMETER CHECK (CORE 5.12) .....	132
<b>7.7</b>	<b>GROWTH.....</b>	<b>132</b>
7.7.1	10-Year Increment (PNW).....	132
7.7.2	5-Year Increment (PNW).....	133
7.7.3	5-Year Height Growth (PNW) .....	133
7.7.4	Tree Age (PNW) .....	133
7.7.5	Tree Age Method (PNW).....	135

Annual Inventory 2007, Chapter 7: Live and Standing Dead Tree Tally

LENGTH .....	135
7.7.6 ACTUAL LENGTH (CORE 5.15).....	135
7.7.7 TOTAL LENGTH (CORE 5.14).....	135
7.7.8 LENGTH METHOD (CORE 5.16).....	136
7.7.9 Previous Actual Length (PNW).....	137
<b>7.8 TREE LIVE CROWN MEASUREMENTS.....</b>	<b>137</b>
7.8.1 COMPACTED CROWN RATIO (CORE 5.19).....	137
7.8.2 CROWN CLASS (CORE 5.17).....	137
<b>7.9 TREE DAMAGE .....</b>	<b>138</b>
DAMAGE DEFINITIONS.....	138
IDENTIFYING AND RECORDING DAMAGE .....	142
7.9.1 Damage Location 1 (PNW).....	143
7.9.2 Damage Agent 1 (PNW).....	143
7.9.3 Damage Severity 1A (PNW).....	144
7.9.4 Damage Severity 1B (PNW).....	144
7.9.5 Unknown Damage Type 1 (PNW).....	144
7.9.6 Damage Location 2 (PNW).....	144
7.9.7 Damage Agent 2 (PNW).....	144
7.9.8 Damage Severity 2A (PNW).....	144
7.9.9 Damage Severity 2B (PNW).....	144
7.9.10 Unknown Damage Type 2 (PNW).....	144
7.9.11 DWARF MISTLETOE CLASS (CORE OPTIONAL 5.26).....	145
7.9.12 ROTTEN/MISSING CULL (CORE 5.13).....	145
7.9.13 ROUGH CULL (CORE OPTIONAL 5.25).....	147
7.9.14 Cavity presence (PNW).....	147
<b>7.10 MISCELLANEOUS LIVE TREE MEASURED VARIABLES .....</b>	<b>147</b>
7.10.1 Remnant Tree (PNW).....	147
7.10.2 Hardwood Clump (PNW).....	148
7.10.3 Form Class (PNW).....	148
7.10.4 TREE NOTES (CORE 5.27).....	149
<b>7.11 DEAD STANDING OR REMOVED .....</b>	<b>149</b>
7.11.1 CAUSE OF DEATH (CORE 5.21).....	149
7.11.2 MORTALITY YEAR (CORE OPTIONAL 5.20).....	150
7.11.3 Stump (PNW).....	150
7.11.4 SNAG DECAY CLASS (CORE 5.23).....	150
7.11.5 Snag Reason for Disappearance (PNW).....	151
7.11.6 Utilization Class (PNW).....	151
<b>7.12 SPECIAL STUDIES.....</b>	<b>152</b>
Special Study 2007a (Day Fire) Fire Effects and Recovery.....	152
Special Study 2002a Platform and Moss Abundance.....	152
7.12.1 Platform Abundance (PNW).....	152
7.12.2 Moss Abundance (PNW).....	152
<b>7.13 MORTALITY AND GROWTH ASSESSMENT FROM PREVIOUS OCCASION (PNW).....</b>	<b>153</b>
7.13.1 Mortality Line # (PNW).....	153
7.13.2 Mortality Tree Tag # (PNW).....	153
7.13.3 Mortality Tree History (PNW).....	153
7.13.4 Cause of Death / Damaging Agent (PNW).....	154
7.13.5 Remeasured Diameter (PNW).....	154
7.13.6 Remeasured Diameter Check (PNW).....	154

## Chapter 7: LIVE AND STANDING DEAD TREE TALLY

'Tally trees' are defined as all live and standing dead trees in accessible forest land condition classes encountered on the macroplot the first time a macroplot is established, and all trees that grow into a macroplot thereafter. These data yield information on tree volume, growth, mortality, and removals; wildlife habitats; forest structure and composition; biomass; and carbon sequestration. This chapter describes how and where to measure (tally) live and dead trees, and saplings. Determining how and where to tally a tree is based on tree size, condition, and regional location, as well as land ownership type.

Whether a tree species is tallied depends on its distance from subplot center, its condition (live or dead), and its size (diameter at breast height (4.5 feet above the ground) or at root collar (DBH/DRC) and length).

### DEFINITIONS

An individual tree is categorized as a live tree, a snag, a sapling, or a seedling based on the following criteria.

	Diameter	Length
Live tree	≥ 5.0 inches DBH/DRC	≥ 4.5 feet in length
Snag (standing dead)	≥ 5.0 inches DBH/DRC	≥ 4.5 feet in length (leaning less than 45°)
Sapling	1.0 inch to 4.9 inches DBH/DRC	≥ 4.5 feet in length
Seedling: Conifers	<1.0 inch DBH/DRC	≥ 0.5 feet in length
Seedling: Hardwoods	<1.0 inch DBH/DRC	≥ 1.0 foot in length

Woodland species are species that frequently have multiple stems and require diameter measurement at the root collar (DRC). Examples include mesquite, juniper, mountain mahogany, Gambel oak and Rocky Mountain maple. These species are listed in Appendix 9.

Trees are alive if they have any living parts (leaves, buds, cambium) at or above the point of diameter measurement, either diameter at breast height (DBH) or diameter at root collar (DRC). Trees that have been temporarily defoliated are still alive.

Once tallied, dead trees over 5.0 inches in diameter are tracked until they no longer qualify as standing dead.

**Working around dead trees is a safety hazard - crews should exercise extreme caution! Trees that are deemed unsafe to measure should be estimated.** To qualify as a standing dead tally tree, dead trees must be at least 5.0 inches in diameter, have a bole which has an unbroken ACTUAL LENGTH of at least 4.5 feet, and lean less than 45 degrees from vertical as measured from the base of the tree to 4.5 feet. Portions of boles on dead trees that are separated greater than 50 percent (either above or below 4.5 feet), are considered severed and are included in Down Woody Material (DWM) if they otherwise meet DWM tally criteria. Live and dead standing tally trees, and partially separated boles of dead tally trees, do not have to be self-supported. They may be supported by other trees, branches, or their crown.

For western woodland species (Appendix 9) with multiple stems, a tree is considered down if more than 2/3 of the volume is no longer attached or upright; do not consider cut and removed volume. For western woodland species with single stems to qualify as a standing dead tally tree, dead trees must be at least 5.0 inches in diameter, be at least 1.0 foot in unbroken ACTUAL LENGTH, and lean less than 45 degrees from vertical.

Trees that have been cut above DBH qualify as tally trees, provided they meet the size requirement.

### 7.1 SELECTING TALLY TREES

#### WHERE TO TALLY

Trees are tallied within the subplot, microplot, annular, and hectare areas according to the following rules:

- **Subplot** - 1/24 acre fixed-radius (24.0 feet horizontal):  
All large trees and snags (≥ 5.0 inches DBH/DRC) are tallied in the subplot and referenced to the subplot center.
- **Microplot** - 1/300 acre fixed-radius (6.8 feet horizontal):  
All live saplings (1.0 inches to 4.9 inches DBH/DRC) are tallied within the microplot and referenced to the microplot center.

Note: Seedlings are no longer tallied. Seedlings on the microplot are counted by species and condition class (See Section 5.4.5 "Seedling Count").

- **Annular area** - area within the 1/4 acre fixed radius macroplot (from 24.0 feet to 58.9 feet horizontal)

In addition to tallying all trees  $\geq 5.0$  inches DBH/DRC on the subplot, large live trees and snags are tallied within the annular area and referenced to the subplot center when they reach the following size requirements:

$\geq 24.0$  inches DBH/DRC in Eastern Washington, Eastern Oregon, and all of California

$\geq 30.0$  inches DBH/DRC in Western Washington and Western Oregon

Note: See Appendix 5 (A5.2) for east/west designation for each county.

- **Hectare** – extends to a fixed radius of 185.1 feet horizontal from plot center

Tally large live trees and snags on R5 national forests and BLM land within the Northwest Forest Plan and on all R6 NFS land when SAMPLE KIND = 1 (See Appendix 1.1 for special rules on NFS lands):

$\geq 32.0$  inches DBH/DRC in Eastern Washington, Eastern Oregon, and parts of California that fall within the eastern section of the Northwest Forest Plan area

$\geq 48.0$  inches DBH/DRC in Western Washington, Western Oregon, and parts of California that fall within the western section of the Northwest Forest Plan area

Note: The size class to use will be downloaded and displayed in the data recorder. The hectare plot has a fixed radius of 185.1 feet horizontal from plot center. These trees are referenced to the nearest subplot center. All large trees that fall within a subplot or annular area must be referenced to that subplot, as described above. See Appendix 1 for additional special rules about nonforest plots/condition classes on R5 and R6 NFS lands.

### WITHIN PLOT AREA CRITERIA

Trees are selected for tally only when the horizontal distance from their bole center at the ground to the subplot center is less than or equal to the radius of that subplot/microplot/annular/hectare plot (Figure 7.1). Trees must be selected for tally within the appropriate plot area without error. The tolerances for horizontal distance to trees measurement (Section 7.5.2) do not apply when determining whether a tree is tallied within the specified plot area.

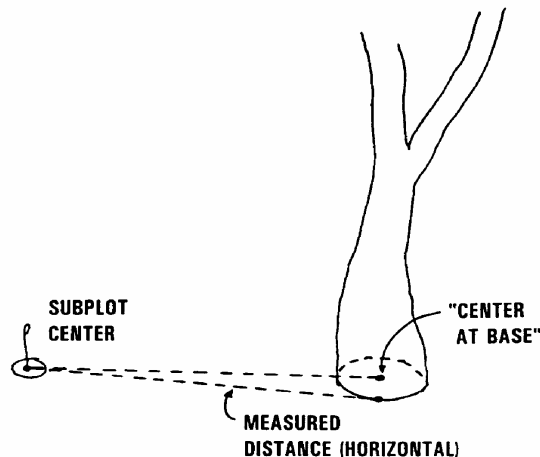

Figure 7.1: Horizontal distance from plot center criteria for determining tally trees.

### ADDITIONAL CRITERIA

- Determine that a forked tree meets the tree requirements (See the rule for forked trees in Section 7.6.2)
- High stumps meeting size and lean angle requirements shall be tallied as standing dead tally trees and are noted as a stump.



## 7.2 CONDUCTING THE TREE TALLY

This section describes the steps by which trees are tallied on accessible forest land (CONDITION CLASS STATUS = 1). Each step also defines the correct TREE STATUS that should be assigned. TREE STATUS is described in Section 7.4.6. This variable tracks the status of sample trees over time. Begin tallying trees at an azimuth of 001 degrees from subplot center and continue clockwise around the subplot. Follow the steps below:

### **CONDITION CLASS STATUS = 1: ACCESSIBLE FOREST LAND**

- a) Tally all live trees ( $\geq 5.0$  inches DBH/DRC) that are within the 24.0 foot subplot.  
Assign a TREE STATUS = 1.
- b) Tally all standing dead trees ( $\geq 5.0$  inches DBH/DRC,  $\geq 4.5$  feet tall), leaning  $< 45$  degrees, that are within the 24.0 foot radius subplot.  
Assign a TREE STATUS = 2.
- c) Tally all live saplings (1.0 to 4.9 inches DBH/DRC) that are within the 6.8 foot radius microplot.  
Assign a TREE STATUS = 1.
- d) Tally all live trees  $\geq 24.0$  inches DBH/DRC in Eastern Washington, Eastern Oregon, and all of California, and  $\geq 30.0$  inches DBH/DRC in Western Washington and Western Oregon that are within the macroplot (between 24.0 and 58.9 feet from subplot center) which were not already tallied within the 24 foot radius).  
Assign a TREE STATUS = 1.
- e) Tally all standing dead trees,  $\geq 24.0$  inches DBH/DRC in Eastern Washington, Eastern Oregon, and California, and  $\geq 30.0$  inches DBH/DRC in Western Washington and Western Oregon,  $\geq 4.5$  feet tall, leaning  $< 45$  degrees, that are within the annular area (between 24.0 and 58.9 feet from subplot center) which were not already tallied within the 24 foot radius).  
Assign a TREE STATUS = 2.
- f) On R6 national forests, and on R5 national forests within the Northwest Forest Plan area only: Tally all live trees  $\geq 32.0$  inches DBH/DRC in Eastern Washington, Eastern Oregon, and 'east-side' California, and  $\geq 48.0$  inches DBH/DRC in Western Washington, Western Oregon, and 'west-side' California that are within the 185.1 foot hectare plot which were not already tallied within the 24 foot or 58.9 foot radius).  
Assign a TREE STATUS = 1.
- g) On R6 national forests, and on R5 national forests within the Northwest Forest Plan area only: Tally all standing dead trees  $\geq 32.0$  inches DBH/DRC in Eastern Washington, Eastern Oregon, and 'east-side' California, and  $\geq 48.0$  inches DBH/DRC in Western Washington and Western Oregon, and 'west-side' California that are within the 185.1 foot hectare plot which were not already tallied within the 24 foot or 58.9 foot radius).  
Assign a TREE STATUS = 2.

### **Data Recording**

Record one line on the data recorder for each tree sampled. Required data items for these trees vary by subplot, condition class and tree status.

For each condition class where there are no live tally trees within the macroplot (within 58.9 feet of subplot center), record one line with the subplot number, the condition class number, a TREE STATUS of "N" and enter "NO TALLY" in remarks.

If all forest condition classes within subplot 1 are "NO TALLY", two additional records are required to witness subplot center. These witness records can represent sound stumps or snags, but live trees are preferable (see Section 2.3 for instructions on referencing subplots).

If the plot is entirely nonforest and stocking subplots were installed to determine condition class status, record two witness records for subplot 1. If the plot is entirely nonforest and is on NFS lands, record two witness records for subplot 1.

If both forest and one or more nonforest condition classes are mapped on an macroplot (58.9-foot fixed-radius plot), enter one line for each nonforest condition class; for each of these records, enter the subplot number, condition class number, and a TREE STATUS of N, and enter "NO TALLY" in remarks.

See Appendix 1 for additional special rules about nonforest plots/condition classes on R5 and R6 NFS lands.

**Summary of Tree Limiting Dimensions:**

breast height	4.5 ft
stump height	1.0 ft
merchantable top	4.0 inches Diameter outside bark (DOB)
merchantable top for woodland	1.5 inches Diameter outside bark (DOB)
seedling/sapling DBH/DRC break	1.0 inch Diameter outside bark (DOB)
sapling/tree DBH/DRC break	5.0 inches Diameter outside bark (DOB)

**CONDITION CLASS NOT ACCESSIBLE FOREST LAND & NOT R6 OR R5 NATIONAL FORESTS**

Do not tally live trees or dead trees.

**7.3 PDR GENERATED TRACKING VARIABLES**

The following variables are office generated and are not entered or changed in the field.

**7.3.1 Line Number (PNW)**

New records are assigned a line number by the PDR. At the time of remeasurement, Line Number will be printed/downloaded for previously recorded trees, snags, witness-only trees, and "no tally" records. The line number should not be changed by the field crew.

**7.3.2 TREE RECORD NUMBER (CORE 5.2)**

This item is NOT the tree tag number and will not be collected in the field. It will be derived in the office for inclusion in the database. It is different than (LINE #) and Tree Number.

Record a 3-digit code to uniquely and permanently identify each tree on a given subplot. The TREE RECORD NUMBERS must be unique within a subplot - that is more important than being sequential. In general, work clockwise from azimuth 001 to 360, and work outwards from subplot center to subplot perimeter. On remeasured plots, use the previously assigned tree number. Saplings tallied on microplots will retain their initially assigned tree number if they grow to tree size. Missed trees will be assigned the next available tree number. DO NOT renumber all plot trees in order to assign a more 'correct' tree number to a missed tree. Numbers assigned to trees which are subsequently found to be extra trees will be dropped and not reused.

**7.3.3 SUBPLOT NUMBER (CORE 5.1)**

Record the subplot number where the tree occurs.

A 2-digit code recorded for all trees on all subplots. The second digit is the previous visit subplot. At this inventory the first digit is "N" (this is referred to as a "N#" subplot). Other first digit codes (C, or #) may be valid for other inventories. See Chapter 2 for further instructions.

When collected:	All live and standing dead tally trees $\geq$ 1.0 in DBH/DRC, witness only trees
Field width:	2 digits
Tolerance:	No errors
Values:	N1, N2, N3, N4

**7.4 FIELD GENERATED TRACKING VARIABLES**

The remaining variables in this chapter are recorded in the field. This section describes variables used to track each tally tree.

**7.4.1 Tree Tag Number (PNW)**

All trees live and 5.0 in DBH/DRC or larger sampled at the current inventory must be marked with an aluminum tree number tag and have the number recorded EXCEPT for trees that are witnesses trees only. Number trees in a clockwise order from azimuth 001 to 360, and work outwards from subplot center to subplot perimeter.

Be sure the tag is nailed to the tree below stump height and faces subplot center. The nail should be driven in only as far as necessary to firmly anchor it in the wood. If a tree which requires a Tree Number has a PNW-FIA tag from a previous inventory, reuse the old tag if serviceable or attach a new tag. When replacing an old PNW-FIA tag, discard it. If an old tag cannot be removed, pound it in until flush with the bark so it will be overgrown and not confused with the new tag.

Do not use a tree number more than once on the same plot. Before leaving the vehicle, make sure the tree numbers previously assigned to downloaded trees are different than the numbers on the new tags you may use.

On R6 National Forests use blue colored number tags at the current visit to differentiate them from the old CVS tag. DO NOT REMOVE previous R6 CVS tree number tags.

On R5 National Forests use standard number tags at the current visit. DO NOT REMOVE previous R5 inventory tree number tags.

Follow any special monumenting protocols specified for wilderness or National Park plots (see Appendix 1).

When collected:	All live tally trees $\geq$ 5.0 inches DBH/DRC
Field width:	3 digits
Tolerance:	No errors
Values:	1 to 999 (100 to 999 in California)

**7.4.2 Previous Tree Tag Number (PNW)**

If any tree tallied at the current inventory has a tree number tag from a previous R6 CVS plot, R5 inventory plot, or PNW-FIA plot, record the number that is on that tag. If more than one old tree number tag is present record the one from the most recent inventory. This item is recorded for live trees, dead trees, and saplings, and will help link current data to previously collected data.

When collected:	All tally trees with a previous R6 CVS, R5, or PNW-FIA number tag on the tree
Field width:	3 digits
Tolerance:	No errors
Values:	1 to 999

**7.4.3 CONDITION CLASS NUMBER (CORE 5.3)**

Record the CONDITION CLASS NUMBER in which each tree is located (See Section 4.4.1). Often, a referenced boundary is approximate, and trees selected for tally are assigned to the actual condition in which they lie regardless of the recorded approximate boundary (Figure 7-2).

Record the CONDITION CLASS NUMBER of the condition class the tree actually occurs in regardless of its position to the mapped boundary line recorded in BOUNDARY DATA. The mapped boundary line is approximate; it is limited to a maximum of two straight lines.

At remeasurement: The previous CONDITION CLASS NUMBER is downloaded and displayed on the PDR for each remeasurement tree. Change the CONDITION CLASS NUMBER to reflect the current CONDITION CLASSES and boundaries. Note: A current CONDITION CLASS NUMBER must be entered for each tree - even if there is no change from the previous value.

When collected:	All tally trees
Field width:	1 digit
Tolerance:	No errors
Values:	1 to 9

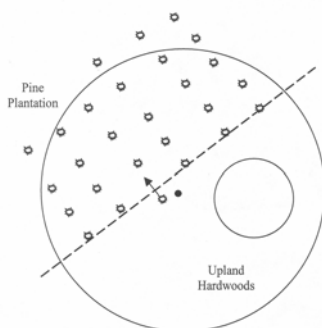

Figure 7-2: Ragged CONDITION CLASS boundary and tree condition class designation.

#### 7.4.4 PREVIOUS TREE STATUS (CORE 5.6)

If not downloaded from the previous inventory, *refer to the last occasion's printout and* record PREVIOUS TREE STATUS for each remeasured tally tree. This code is used to track the status of sample trees over time. This information is needed to correctly assign volume information to the proper component of volume change.

When collected:	On remeasurement plots (SAMPLE KIND = 2), all previously tallied trees > 1.0 inch DBH
Field width:	1 digit
Tolerance:	No errors
Values:	1 - Live Tree – alive at previous inventory, 2 - Dead tree – standing dead tree at previous inv.

#### 7.4.5 Subplot Witness Flag (PNW)

Use this flag to mark the current tally tree (live or dead) as a witness. To activate the flag press the “w” key (this should display a w next to PRESENT TREE STATUS). To turn the witness flag off (when you do not want the current record as a witness) then hit the “w” key again.

When collected:	When PRESENT TREE STATUS = 1 or 2, and the tally tree is chosen to be a subplot witness.
Field width:	1 digit
Tolerance:	No errors
Values:	No mark – current record is not a tally tree witness w – current record is a tally tree witness

#### 7.4.6 PRESENT TREE STATUS (CORE 5.7)

Record a current PRESENT TREE STATUS for each tallied tree; this code is used to track the status of sample trees over time: as they first appear, as ingrowth, as they survive, and when they die or are removed. This information is needed to correctly assign volume information to the proper component of volume change.

When collected:	All new live tally trees $\geq$ 1.0 inches DBH/DRC, All new dead tally trees $\geq$ 5.0 inches DBH/DRC, Witness only trees On remeasurement plots (SAMPLE KIND = 2), all previously tallied trees		
Field width:	1 digit		
Tolerance:	No errors		
Values:	Code	TREE STATUS	Description
	0	No Status	Remeasurement plots only. Tree is not presently in the sample. Tree was incorrectly tallied at the previous inventory or currently is not tallied due to definition or procedural change, or is not tallied due to natural causes. Requires RECONCILE code=5-9
	1	Live	Live tree (new, remeasured or ingrowth)
	2	Dead	Any dead tree (new, remeasured or ingrowth) regardless of cause of death Includes all previously standing dead trees that no longer qualify as standing dead, as well as trees killed by sivicultural or land clearing activity, and are assumed not to have been utilized. Stumps meeting size and lean criteria are tallied as dead trees. <i>Includes previously dead, now down.</i>

	3	Removed	Remeasurement plots only. Tree that has been cut or removed by direct human activity related to harvesting, silvicultural activity or land clearing. The tree is assumed to have been utilized.
	8	Witness Non-Tally Tree	A <b>non-tally</b> live or dead tree that is to be used for a subplot witness.
	9	Witness Only	A subplot <b>witness that is not a tree</b> . It may be a shrub, rock, or other; notes are required to describe the witness.
	N	No Live Tally	Used for each condition class on each subplot without live tally trees (TREE STATUS 1)

**7.4.7 STANDING DEAD (CORE 5.7.2)**

Record the code that describes whether the tree qualifies as standing dead or not. Standing dead trees must be 5.0 inches DBH/DRC or greater, at least 4.5 feet in length, and must have less than 45 degrees of lean from vertical as measured from the base of the tree to 4.5 feet. Trees supported by other trees or by their own branches that meet these requirements are considered standing. They do not have to be self-supporting. See Figures 7-3, 7-4, and 7-5.

“Unbroken” is defined as at least 50 percent attached to the original source of growth. The degree of lean on dead trees with partially separated (i.e., 1 to 50 percent) boles is measured from the base of the tree to the top of ACTUAL LENGTH.

Portions of boles on dead trees that are separated greater than 50 percent (either above or below 4.5 feet), are considered severed and are included in Down Woody Material (DWM) if they otherwise meet DWM tally criteria.

For western woodland species (Appendix 9) with multiple stems, a tree is considered down if more than 2/3 of the volume is no longer attached or upright; do not consider cut and removed volume. For western woodland species with single stems to qualify as a standing dead tally tree, dead trees must be at least 5.0 inches in diameter, be at least 1.0 foot in unbroken ACTUAL LENGTH, and lean less than 45 degrees from vertical.

Live and dead standing tally trees, and partially separated boles of dead tally trees, do not have to be self-supported. They may be supported by other trees, branches, or their crown.

When collected:	SAMPLE KIND = 2 only: All dead tally trees (PRESENT TREE STATUS = 2)	
Field width:	1 digit	
Tolerance:	No errors	
Values:	0	No – tree does not qualify as standing dead
	1	Yes – tree does qualify as standing dead

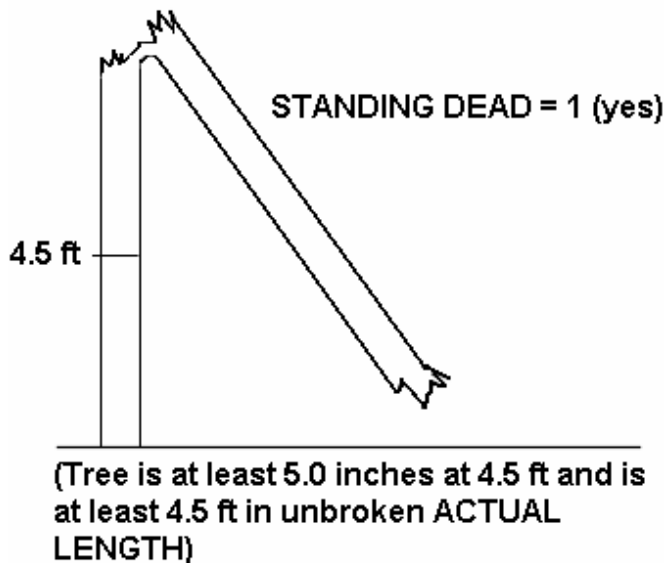

Figure 7-3: Example of an unbroken bole to 4.5 feet.

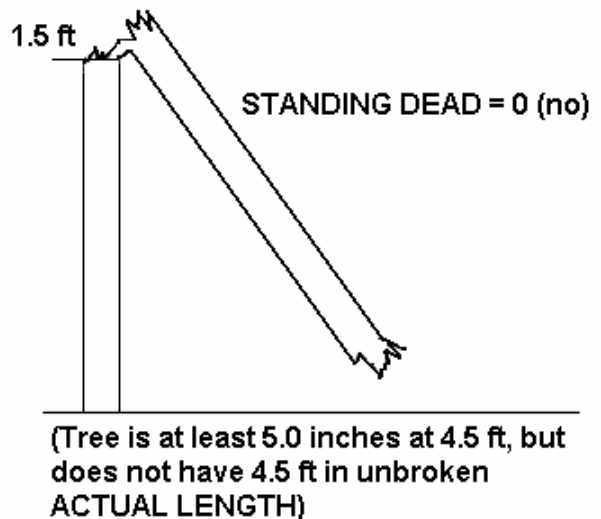

Figure 7-4: Example of an unbroken length of < 1.5 feet.

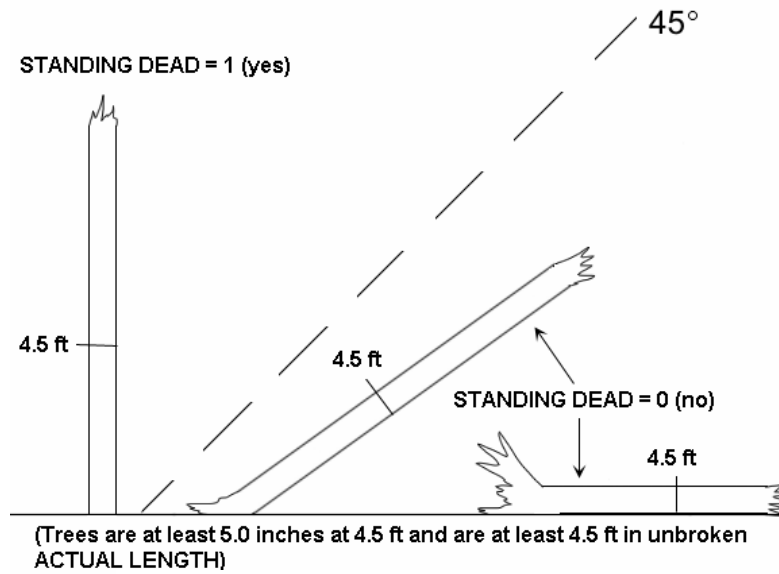

Figure 7-5: Other examples of dead trees.

**7.4.8 RECONCILE (CORE 5.7.1)**

For remeasurement locations only, record a RECONCILE code for any new tally tree that was not tallied in the previous inventory, and for all no status remeasurement trees (PRESENT TREE STATUS = 0). This code is used to identify the reason a new tree appeared in the inventory, and identify the reason a remeasurement tree no longer qualifies as a tally tree. This information is needed to correctly assign volume information to the proper component of volume change.

When collected:	On SAMPLE KIND = 2; all new live tally trees > 1.0 in DBH/DRC (PRESENT TREE STATUS = 1 and no PREVIOUS TREE STATUS), all new dead tally trees ≥ 5.0 in (PRESENT TREE STATUS = 2 and no PREVIOUS TREE STATUS), all no status trees (PRESENT TREE STATUS = 0)
Field width:	1 digit
Tolerance:	No errors

Values: Codes 1-4 are valid for new trees on the plot:

1	Ingrowth or reversions – either a new tally tree not qualifying as through growth or a new tree on land that was formerly nonforest and now qualifies as forest land (includes reversion or encroachments).
2	Through growth – new tally tree 5.0 inches DBH/DRC and larger, within the microplot, which was not missed at the previous inventory.
3	Missed live – a live tree missed ( <i>or not in the inventory</i> ) at previous inventory and that is live or dead now.
4	Missed dead – a dead tree missed ( <i>or not in the inventory</i> ) at previous inventory that is dead now.

Codes 5-9 are valid for remeasured trees that no longer qualify as tally:

5	Shrank – live tree that shrank below threshold diameter on microplot/subplot/macroplot plot.
6	Missing (moved) – tree was correctly tallied in previous inventory, but has now moved beyond the radius of the plot due to natural causes (i.e., small earth movement, hurricane). Tree must be either live before and still alive now or dead before and dead now. If tree was live before and now dead, this is a mortality tree and should have PRESENT TREE STATUS = 2 (not 0).
7	Cruiser error – erroneously tallied at previous inventory.
8	Procedural change – tree was tallied at the previous inventory, but is no longer tallied due to a definition or procedural change.
9	Tree was sampled before, but now the area where the tree was located is nonsampled. All trees on the nonsampled area have RECONCILE = 9.

Code 5 is used to indicate live trees that shrink below the diameter threshold on the microplot/subplot/macroplot. For example, if a live remeasurement tree shrinks below the 5.0 inch DBH/DRC, then record the following combination of codes: PREVIOUS TREE STATUS = 1, PRESENT TREE STATUS = 0, RECONCILE = 5. If a live measured tree shrinks below the 5.0 inch threshold on the subplot and is currently greater than or equal to 1.0 inch on the microplot, then record PREVIOUS TREE STATUS = 1, PRESENT TREE STATUS = 1. Record all required items for a tally sapling. Use the tree coding guide in Appendix 14.1 to determine the national coding method for remeasurement trees.

**7.4.9 SPECIES (CORE 5.8)**

Record the appropriate SPECIES code from the list in Appendix 9. If you encounter a species not listed in Appendix 9 *it should not be tallied*. If the species cannot be determined in the field, tally the tree, but bring branch samples, foliage, cones, flowers, bark, etc. to your supervisor for identification. If possible, collect samples outside the subplots from similar specimens and make a note to correct the SPECIES code later. Use code 0299 for unknown dead conifer and 0998 for unknown dead hardwood when the genus or species codes cannot be used. The generic codes should *not* be used *and are not included in Appendix 9*. *In the case of standing dead trees on newly established plots, use the sample collections procedures described earlier in this paragraph.*

Note: Appendix 9 contains all tree species designated as CORE on the national list and all additional species tallied in PNW during the current inventory (included on previous PNW tree code lists from 2002 - 2005), but does not contain “genus-only” codes. They are not valid in PNW. Code 999 is NOT A VALID SPECIES CODE in PNW. This code is used only for a reference object, not a species. SPECIES is a 4-digit code; PNW uses only 3 digits. If PEAM3 (7211 Avocado) is encountered, code as 721 and add a tree note.

Remeasurement: Previous SPECIES information is downloaded and displayed on the PDR for each remeasurement tree. Correct the SPECIES code if the species was incorrectly identified or SPECIES code = 0999 at the last inventory and the tree is still a valid tally tree. Do not change the SPECIES code if the tree is no longer a valid tally tree (PRESENT TREE STATUS = 0).

Plants included in the tree species list are measured as trees regardless of form. Procedures will be developed in the future to record tree species with shrub form. At the current inventory use the standard tree rules (1.0 inches diameter to be a sapling, etc.) and make notes in the plot card as needed. Those plants not included in the list are never tallied as trees, but are included in understory vegetation data collection.

When collected:	All live tally trees $\geq$ 1.0 in DBH/DRC and standing dead tally trees $\geq$ 5.0 in DBH/DRC, <i>witness-only trees</i>
Field width:	3 digits ( <i>PNW only</i> )
Tolerance:	No errors
Values:	See Appendix 9 Tree Species List

**7.5 MONUMENTING INFORMATION**

Tree azimuth, distance, and tree number are used to relocate subplots and the live and dead trees tallied on subplots. For remeasurement plots (SAMPLE KIND = 2) Previous monumenting information is downloaded and displayed on the PDR for each remeasurement tree. Remeasure and update the AZIMUTH and DISTANCE values only if the previous measurements were obviously out of tolerance.

**7.5.1 AZIMUTH (CORE 5.4)**

Record the AZIMUTH from the subplot center (for trees greater than or equal to 5.0 inches DBH/DRC) or the microplot center (for trees greater than or equal to 1.0 inch and less than 5.0 inches DBH/DRC), sight the center of the base of each tree with a compass. Sight to the geographic center for multi-stemmed western woodland species. The geographic center is a point of equal distance between all tallied stems for a given woodland tree. Record AZIMUTH to the nearest degree. Use 360 for north.

Note: For microplot trees (saplings) which become trees (at the time of plot remeasurement), crews must collect new azimuth and distance information from the subplot center.

Use the magnetic declinations shown in Appendix 5.2.

“Hectare” trees (see Section 7.1) within a 58.9’ radius subplot boundary must be referenced to that subplot. Hectare trees not within a 58.9’ radius subplot boundary can be referenced to any subplot.

When collected:	All live tally trees $\geq 1.0$ in DBH/DRC and standing dead tally trees $\geq 5.0$ in DBH/DRC, <i>witness-only trees</i>
Field width:	3 digits
Tolerance:	+/- 10 degrees
Values:	001 to 360

### 7.5.2 HORIZONTAL DISTANCE (CORE 5.5)

Record the measured HORIZONTAL DISTANCE, to the nearest 0.1 foot, from the subplot center (for trees greater than or equal to 5.0 inches DBH/DRC) or microplot center (for trees greater than or equal to 1.0 inch and less than 5.0 inches DBH/DRC) to the pith of the tree at the base. For all multi-stemmed western woodland trees (woodland species indicated in Appendix 9), the HORIZONTAL DISTANCE is measured from subplot or microplot center to the "geographic center" of the tree. The geographic center is a point of equal distance between all tallied stems for a given woodland tree.

The HORIZONTAL DISTANCE recorded for each tree must reflect the size radius plot where the tree actually occurs. For example: a tree at 23.4 feet has a distance tolerance of +/- 1.0 foot, but its distance must be recorded as  $\leq 24.0$  or the recorded distance is incorrect. Remeasurement trees that fall within within 1 foot of the subplot/macroplot boundary should be remeasured and the data updated as necessary; the PDR will provide a warning each time one of these trees is encountered.

"Hectare" trees (see Section 7.1) within a 58.9 foot radius subplot boundary must be referenced to that subplot. Hectare trees not within a 58.9' radius subplot boundary are referenced to the nearest subplot center.

When collected:	All live tally trees $\geq 1.0$ in DBH/DRC and standing dead tally trees $\geq 5.0$ in DBH/DRC
Field width:	4 digits (xxx.y)
Tolerance:	Microplot: +/- 0.2 ft Microplot woodland species: +/- 0.4 ft Subplot: +/- 1.0 ft Subplot woodland species: +/- 2.0 ft Macroplot: +/- 10.0 ft Macroplot woodland species: +/- 10.0 ft Hectare plot: +/- 10.0 ft
Values:	Microplot: 00.1 to 06.8 Subplot: 00.1 to 24.0 Macroplot: 24.1 to 58.9 Hectare plot: 58.9 to 185.1

### 7.5.3 Witness Tree or Object Slope Distance (PNW)

Record the slope distance to the nearest 0.1 foot from subplot center to the head of the nail that affixes the tree number/basal tag or other witness object. In wilderness areas or National Parks where number/basal tags can not be used, measure from subplot center to front of the tree at the base.

When collected:	All witness trees
Field width:	3 digits (xx.y)
Tolerance:	+/- 0.2 feet
Values:	00.1 to 99.9

## 7.6 DIAMETER

Diameters are measured at either breast height (DBH) or at the root collar (DRC). Species requiring DRC, referred to as woodland species, are noted by a "w" in Appendix 9. Trees with diameters between 1.0- and 4.9-inches are measured on the 6.8-foot radius microplot, those with diameters of 5.0-inches and larger are measured on the 24-foot radius subplots.

Diameters are used in calculating volume, growth, average stand diameter, and stocking-related estimates such as forest type and stand size.



**MARKING CURRENT DIAMETER:**

A. Marking DBH/DRC on trees previously marked:

The place where diameter was measured at the previous visit on trees tallied live and  $\geq 3.0$  inches DBH/DRC was marked with an aluminum nail. On these trees, remeasure diameter at the location of the previous crew's nail if appropriate using the rules below. Reset the old nail enough so that as much of the old nail is exposed as possible. If the old nail cannot be pulled out to meet this requirement, set a new nail at the same location. If the previous location is no longer accessible (i.e. covered in a landslide), there is an abnormality at the previous DIAMETER measurement point, or is more than 12 inches away from where the diameter should be measured according to current protocols (either because protocols have changed or the previous crew made a mistake) move the point of measurement and assign a DIAMETER CHECK code of 2. If the old nail marks a point of diameter measurement not used at the current inventory, remove it if possible; otherwise pound it in flush with the tree.

B. The following apply at remeasurement:

- If at the previous visit a forked tree was recorded as two separate trees but should have been recorded as one tree, delete one tree from the inventory by giving it a reconcile code of 8, and correct the PREVIOUS DIAMETER (7.6.1) for the remaining tree. Record an explanation in TREE NOTES.
- If at the previous visit a forked tree was recorded as one tree but should have been recorded as two separate trees, correct the PREVIOUS DIAMETER (7.6.1) for the remeasured tree to represent one tree, and add the other fork as a new tree. Record an explanation in TREE NOTES.

C. Marking trees  $\geq 3.0$  inches DBH/DRC, or snags  $\geq 5.0$  inches DBH/DRC, tallied for the first time:

Set an aluminum nail at the point of diameter measurement. On level ground, place the nail on the side of the tree facing the sample point. On a slope, place the nail on the uphill side of the bole. Leave as much of the nail exposed as possible, but be sure it is firmly affixed to the tree. For trees with multiple stems measured at d.r.c., place a nail at the point of measurement on each stem. Use caution to avoid damaging trees with scribes and nails. Do not scribe or nail trees less than 3.0 inches in diameter.

D. General instructions on marking diameter:

If a tree or snag (new or remeasured) is 32.0 inches DBH/DRC or larger, affix an additional nail for every additional (above 32.0 inches) 12 inches of diameter, distributing the nails evenly around the circumference of the bole. Set these nails while the diameter tape is girdling the tree at the point of diameter.

Use painted nails if required by special monumenting protocols for wilderness or National Park plots.

When collected:	All live tally trees $\geq 1.0$ in DBH/DRC, all standing dead tally trees $\geq 5.0$ in DBH/DRC, <i>witness-only trees</i>
Field width:	4 digits (xxx.y)
Tolerance:	--Live trees and dead trees with Decay Class 1, 2: +/- 0.1 inches per 20.0 in increment of measured diameter. For example, a tree with a diameter of 41.0 in would have a tolerance of +/- 0.3 inch --Dead trees with Decay Class 3, 4, 5: +/- 1.0 inches per 20.0 in increment of measured diameter. --For woodland species: +/- 0.2 inch per stem.
Values:	001.0 to 999.9

**7.6.1 PREVIOUS DIAMETER AT BREAST HEIGHT (CORE 5.9.1)**

This is the DBH assigned at the previous survey. It has been downloaded from the previous inventory. Any change made to this field signifies an error at the time of the previous inventory. "DIAMETER CHECK" should be set to 2 and an explanation is required in the notes if previous DBH is changed.

Estimate the new value for PREVIOUS DIAMETER AT BREAST HEIGHT by doing one of the following:

- Take an increment core at the location of the previous diameter measurement: Measure the increment length of most recent number of rings equivalent to the PNW Remeasurement Period (3.3.14). The PDR will calculate the new PREVIOUS DIAMETER estimate.

- Measure current diameter both at the correct diameter location and at the previous diameter location (DIAMETER CHECK = 2); determine the difference by adding or subtracting the difference to the previous diameter; use this value to adjust the PREVIOUS DIAMETER estimate.
- Estimate the correct previous diameter based on the “best” information at hand (e.g. the PREVIOUS DIAMETER of similar sized nearby trees of the same species).

### 7.6.2 DIAMETER AT BREAST HEIGHT (CORE 5.9.2)

Unless one of the following special situations is encountered, measure DBH at 4.5 ft above the ground line on the uphill side of the tree. Round each measurement down to the last 0.1 inch. For example, a reading of 3.68 inches is recorded as 3.6 inches.

#### SPECIAL DBH SITUATIONS

1) Forked tree: In order to qualify as a fork, the stem in question must be at least 1/3 the diameter of the main stem and must branch out from the main stem at an angle of 45 degrees or less. Forks originate at the point on the bole where the piths intersect. Forked trees are handled differently depending on whether the fork originates below 1.0 foot, between 1.0 and 4.5 feet, or above 4.5 feet.

- Trees forked below 1.0 foot: Trees forked in this region (*Figure 7-6*) are treated as distinctly separate trees. Distances and azimuths are measured individually to the center of each stem where it splits from the stump. DBH is measured for each stem at 4.5 feet above the ground. When stems originate from pith intersections below 1 foot, it is possible for some stems to be within the limiting distance of the microplot or subplot, and others to be beyond the limiting distance. If stems originating from forks that occur below 1.0 foot fork again between 1.0 and 4.5 feet, the rules in the next paragraph apply.

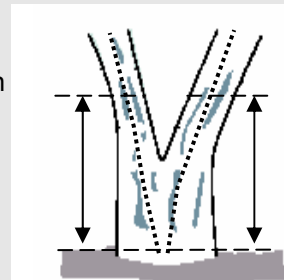

Figure 7-6: Tree forked below 1.0 ft.

Trees forked between 1.0 foot and 4.5 feet: Trees forked in this region (*Figure 7-7*) are also counted as separate trees, but only one distance and azimuth (to the central stump) is used for all. Although a single azimuth and distance applies to all, multiple stems should be recorded as they occur in clockwise order (from front to back when one stem is directly in front of another). The DBH of each fork is measured at a point 3.5 feet above the pith intersection. When forks originate from pith intersections between 1.0 and 4.5 feet, the limiting distance is the same for all forks—they are either all on, or all off the plot.

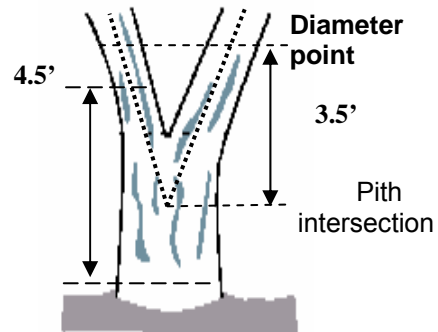

Figure 7-7: Forked between 1.0 and 4.5 feet.

Multiple forks are possible if they all originate from approximately the same point on the main stem. In such cases, measure DBH on all stems at 3.5 feet above the common pith intersection.

Once a stem is tallied as a fork that originated from a pith intersection between 1.0 and 4.5 feet, do not recognize any additional forks that may occur on that stem. Measure the diameter of such stems below the base of stem separation (i.e. do not move the point of diameter the entire 3.5 feet above the first fork).

- Trees forked at or above 4.5 feet: Trees forked in this region count as one single tree (*Figure 7-8*). If a fork occurs at or immediately above 4.5 feet, measure diameter below the fork just beneath any swelling that would inflate DBH.

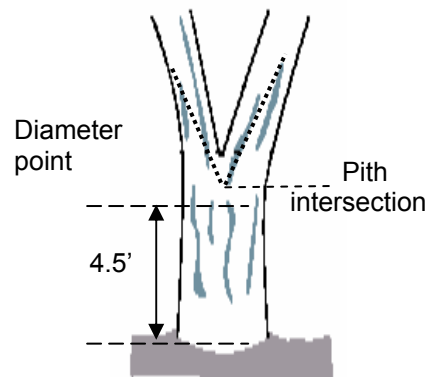

Figure 7-8: One tree

2) Stump Sprouts: Stump sprouts originate between ground level and 4.5 feet on the boles of trees that have died or been cut. Stump sprouts are handled the same as forked trees, with the exception that stump sprouts are not required to be 1/3 the diameter of the dead bole. Stump sprouts originating below 1.0 foot are measured at 4.5 feet from ground line. Stump sprouts originating between 1.0 foot and 4.5 feet are measured at 3.5 foot above their point of occurrence. As with forks, rules for measuring

distance and azimuth depend on whether the sprouts originate above or below 1.0 foot. For multi-stemmed woodland species, treat all new sprouts as part of the same new tree.

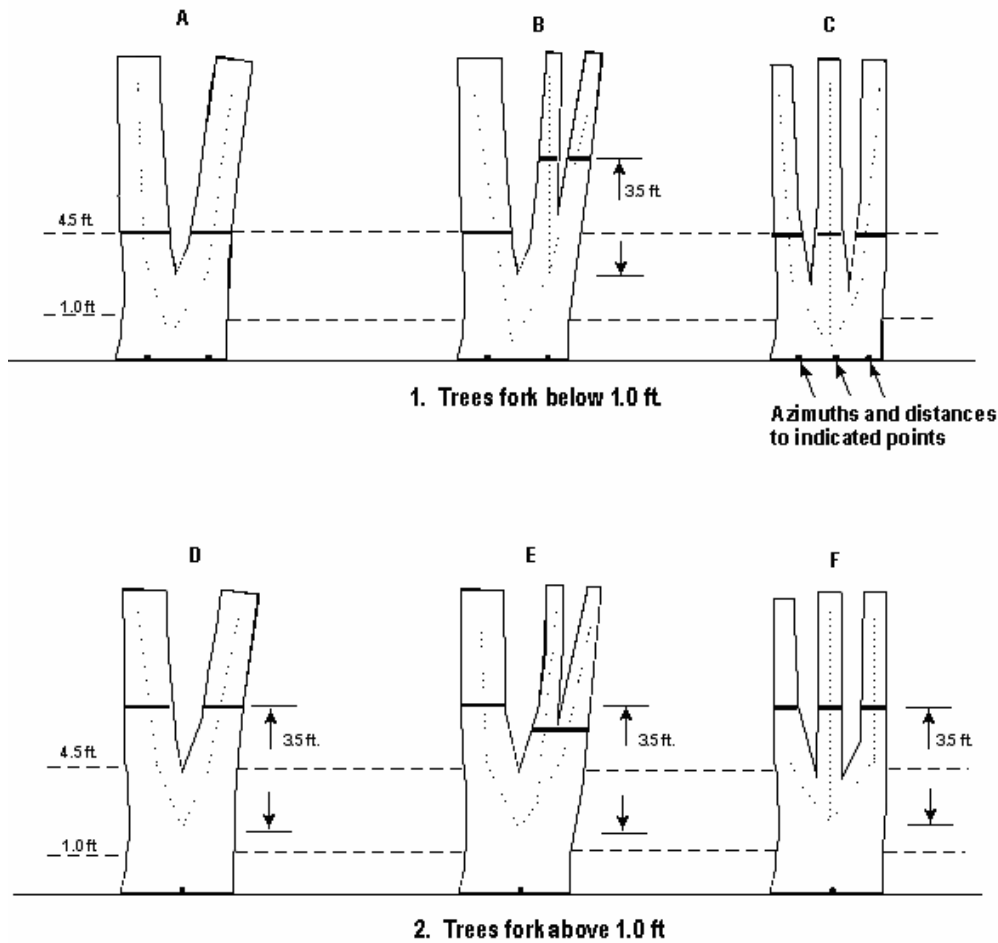

Figure 7-9: Summary of where to measure DBH, distance, and azimuth on forked trees.

- 3) Tree with butt-swell or bottleneck: Measure these trees 1.5 feet above the end of the swell or bottleneck if the swell or bottleneck extends 3.0 feet or more above the ground (Figure 7-10).
- 4) Tree with irregularities at DBH: On trees with swellings, bumps, depressions, and branches at DBH, diameter will be measured immediately above the irregularity at the place it ceases to affect normal stem form (Figure 7-11a & 7-11b).

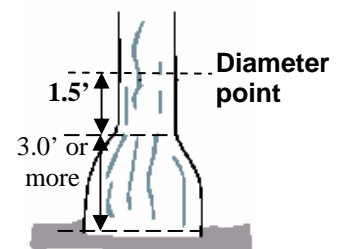

Figure 7-10: Butt swell

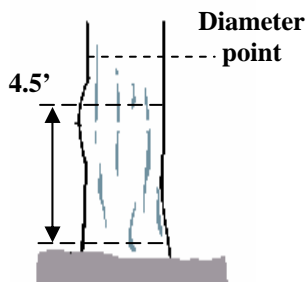

Figure 7-11a: Tree with swell at 4.5'.

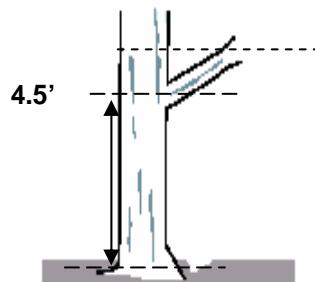

Figure 7-11b: Tree with branch at 4.5'.

5) Tree on slope: Measure diameter at 4.5 ft from the ground along the bole on the uphill side of the tree (Fig 7-12).

6) Leaning tree: Measure diameter at 4.5 feet from the ground along the bole. The 4.5 foot distance is measured along the underside face of the bole (Figure 7-13).

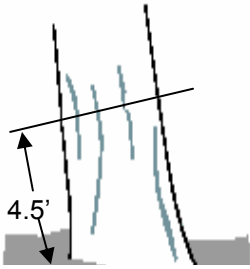

Figure 7-13: Leaning tree

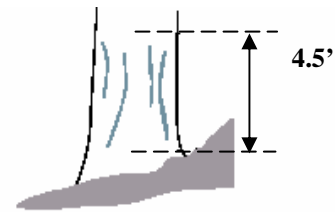

Figure 7-12: Tree on slope

7) Turpentine tree: On trees with turpentine face extending above 4.5 feet, estimate the diameter at 10.0 feet above the ground and multiply by 1.1 to estimate DBH outside bark.

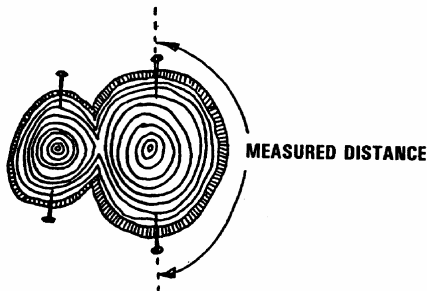

Figure 7-14: Independent trees that grow together

8) Independent trees that grow together: If two or more independent stems have grown together at or above the point of DBH (Figure 7-14), continue to treat them as separate trees. Estimate the diameter of each, set the "DIAMETER CHECK" code to 1, and explain the situation in the notes.

*Set two diameter nails at DBH/DRC halfway around the tree's circumference from each other. Measure the distance between the nails with a diameter tape. Multiply the measurement by 2 and record the result as the current diameter. Example: Distance measured = 12.8 inches (12.8 X 2) = 25.6 inches Set DIAMETER CHECK = 7.*

9) Missing wood or bark: Do not reconstruct the DBH of a tree that is missing wood or bark at the point of measurement (Figure 7-15). Record the diameter, to the nearest 0.1 inch, of the wood and bark that is still attached to the tree. If a tree has a localized abnormality (gouge, depression, etc.) at the point of point of DBH, apply the procedure described for trees with irregularities at DBH.

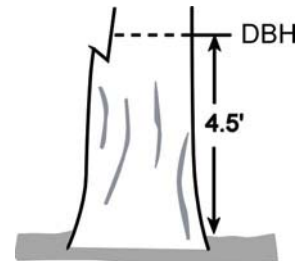

Figure 7-15: Missing wood or bark.

10) Live windthrown tree: Measure from the top of the root collar along the length to 4.5 feet (Figure 7-16).

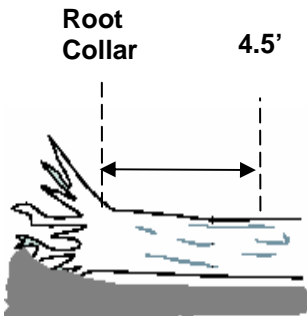

Figure 7-16: Live windthrown tree.

11) Down live tree with tree-form branches growing vertical from main bole: When a down live tree, touching the ground, has vertical (less than 45 degrees from vertical) tree-like branches coming off the main bole, first determine whether or not the pith of the main bole (averaged along the first log of the tree) is above or below the duff layer.

- If the pith of the main bole is above the duff layer, use the same forking rules specified for a forked tree, and take all measurements accordingly (Figure 7-17).
- If the pith intersection of the main down bole and vertical tree-like branch occurs below 4.5 feet from the stump along the main bole, treat that branch as a separate tree, and measure DBH 3.5' above the pith intersection for both the main bole and the tree-like branch (Figure 7-17).

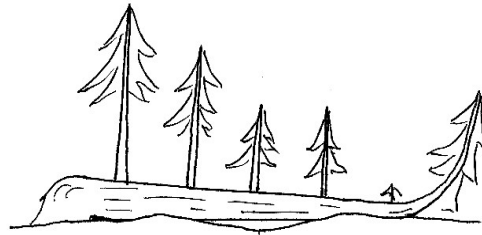

Figure 7-17: Down tree above duff.

- If the intersection between the main down bole and the tree-like branch occurs beyond the 4.5 foot point from the stump along the main bole, treat that branch as part of the main down bole (Figure 7-17).
- If the pith of main tree bole is below the duff layer, ignore the main bole, and treat each tree-like branch as a separate tree; take DBH and length measurements from the ground, not necessarily from the top of the down bole (Figure 7-18). However, if the top of the main tree bole curves out of the ground towards a vertical angle, treat that portion of that top as an individual tree originating where the pith leaves the duff layer.

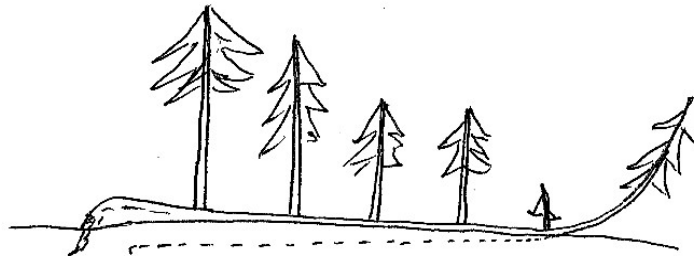

Figure 7-18: Down tree below duff.

12) Tree with curved bole (pistol butt tree): Measure along the bole on the uphill side (upper surface) of the tree (Figure 7-19).

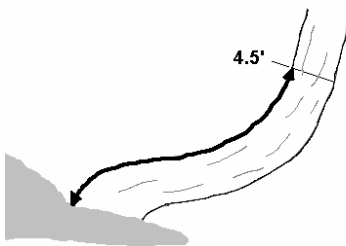

Figure 7-19: Tree with curved bole (pistol butt)

13) Diameter on stump: Use a logger's tape, cloth tape or ruler to measure the longest and shortest axis across the top of the stump. Record diameter as the average of the two measurements.

### 7.6.3 PREVIOUS DIAMETER AT ROOT COLLAR (CORE 5.9.3)

This is the DRC assigned at the previous survey. It has been downloaded from the previous inventory. Any change made to this field signifies a misclassification at the time of the previous inventory. "DIAMETER CHECK" should be set to 2 and an explanation is required in the notes if previous DRC is changed.

### DIAMETER AT ROOT COLLAR (CORE 5.9.4)

For species requiring diameter at the root collar (refer to Appendix 9), measure the diameter at the ground line or at the stem root collar, whichever is higher. For these trees, treat clumps of stems having a unified crown and common root stock as a single tree; examples include mesquite, juniper, and mountain mahogany. Treat stems of woodland species such as Gambel oak and bigtooth maple as individual trees if they originate below the ground.

For woodland trees record DRC STEM DIAMETER and DRC STEM STATUS (described below). Then compute and record the DRC value from the individual stem diameter information.

The data recorder has a feature to compute DRC, and forms are available.

**Measuring woodland stem diameters DRC:** Before measuring DRC, remove the loose material on the ground (e.g., litter) but not mineral soil. Measure just above any swells present, and in a location so that the diameter measurements are a good representation of the volume in the stems (especially when trees are extremely deformed at the base). Stems must be at least 1.0 foot in length and at least 1.0 inch in diameter 1 foot up from the stem diameter measurement point to qualify for measurement. Whenever DRC is impossible or extremely difficult to measure with a diameter tape (e.g., due to thorns, extreme number of limbs), stems may be estimated and recorded to the nearest 1.0 inch class. Additional instructions for DRC measurements are illustrated in Figure 7-20 below. For each qualifying stem of the woodland tree, measure and record DRC STEM DIAMETER (7.6.4) and indicate the DRC STEM STATUS (7.6.5).

**Computing and Recording DRC:** For all tally trees requiring DRC, with at least one stem 1 foot in length and at least 1.0 inch in diameter 1 foot up from the stem diameter measurement point, DRC is computed as the square root of the sum of the squared stem diameters. For a single-stemmed DRC tree, the computed DRC is equal to the single diameter measured.

Use the following formula to compute DRC:

$$\text{DRC} = \text{SQRT} [\text{SUM} (\text{stem diameter}^2)]$$

Round the result to the nearest 0.1 inch. For example, a multi-stemmed woodland tree with stems of 12.2, 13.2, 3.8, and 22.1 would be calculated as:

$$\begin{aligned} \text{DRC} &= \text{SQRT} (12.2^2 + 13.2^2 + 3.8^2 + 22.1^2) \\ &= \text{SQRT} (825.93) \\ &= 28.74 \\ &= 28.7 \end{aligned}$$

#### 7.6.4 DRC STEM DIAMETER (CORE 5.9.4.1)

Record the diameter of each individual qualifying stem on the woodland tree.

When collected:	All stems on woodland tree species that are at least 1 ft in length and at least 1.0 inch in diameter 1 ft up from the stem diameter measurement point <i>when CURRENT NUMBER OF STEMS &gt; 0.</i>
Field width:	4 digits
Tolerance:	+/- 0.2 in per stem
Values:	001.0 to 999.9

#### 7.6.5 DRC STEM STATUS (CORE 5.9.4.2)

Record the status of each individual stem on the woodland tally tree.

When collected:	All stems on woodland tree species that are at least 1 ft in length and at least 1.0 inches in diameter 1 ft up from the stem diameter measurement point <i>when CURRENT NUMBER OF STEMS &gt; 0.</i>
Field width:	1 digit
Tolerance:	No errors
Values:	1 live stem 2 dead stem

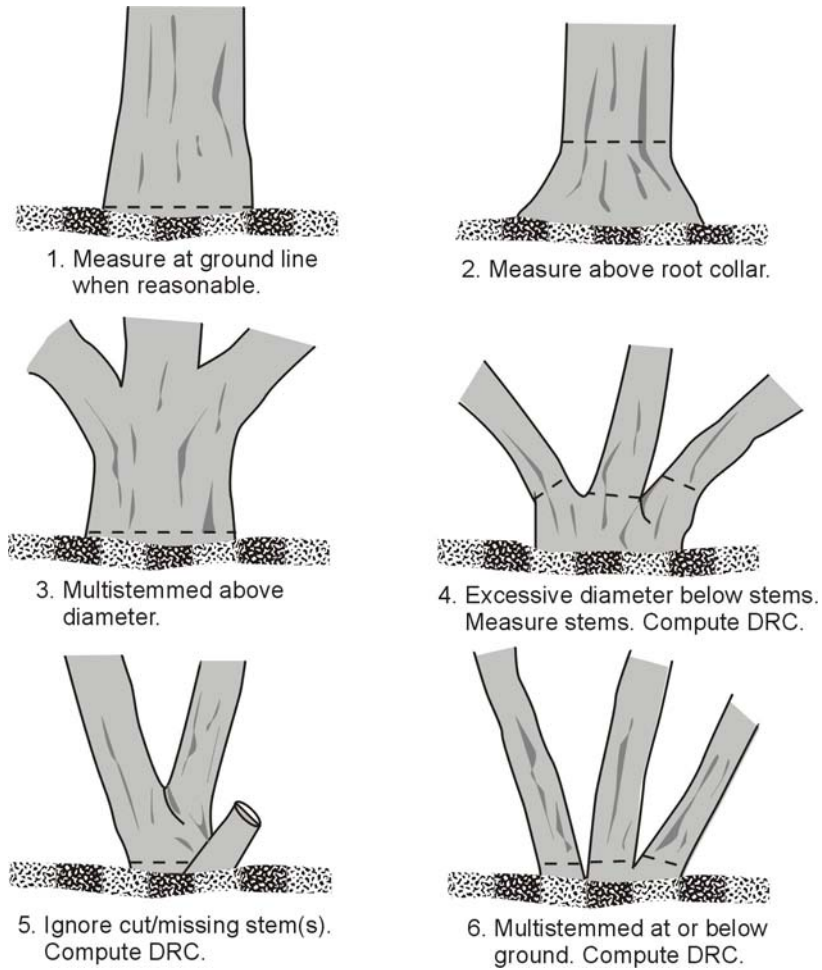

Figure 7-20: How to measure DRC in a variety of situations.

### 7.6.6 PAST NUMBER OF STEMS (CORE 5.10)

If the PAST NUMBER OF STEMS does not equal the CURRENT NUMBER OF STEMS, **do not** change the preprinted value. Make a note in TREE NOTES suggesting the possible reason for the difference.

When collected:	Value is preprinted for SAMPLE KIND = 2 locations
Field width:	2 digits
Tolerance:	No errors
Values:	1 to 99

### 7.6.7 CURRENT NUMBER OF STEMS (CORE 5.11)

Record the total number of stems that were measured for DRC (e.g., record 1 stem as 01; record 12 stems as 12). Count only the number of qualifying stems used to calculate DRC. Qualifying stems are those *live or standing dead* that are at least 1.0 foot in length and at least 1.0 inch in diameter, 1 foot up from the measurement point.

When collected:	For tallied <b>woodland</b> species with at least one stem 1.0 inch in diameter or larger; includes woodland species tallied on the microplot
Field width:	2 digits
Tolerance:	No errors
Values:	1 to 99

**7.6.8 DIAMETER CHECK (CORE 5.12)**

Record this code to identify any irregularities in diameter measurement positions (i.e. abnormal swellings, diseases, damage, new measurement positions, etc.) that may affect use of this tree in diameter growth/change analyses. If both codes 1 and 2 apply, diameter is both estimated and moved, use code 2 and change the PREVIOUS DIAMETER (7.6.1) as necessary.

If diameter is estimated because of moss/vine/obstruction etc., record an estimate of the diameter without the obstruction.

If diameter at the current inventory is measured at a different location than at the previous inventory, record DIAMETER CHECK=2 and remove the d-nail(s) from the previous inventory. If the previous point of diameter measurement can not be found on a live tree (i.e. nail fell out) also record code 2.

When collected:	All live tally trees $\geq 1.0$ in DBH/DRC, all standing dead tally trees $\geq 5.0$ in DBH/DRC	
Field width:	1 digit	
Tolerance:	No errors	
Values:	Code	Diameter check
	0	Diameter measured accurately <i>at correct location</i>
	1	Diameter estimated for reason other than moss or vines.
	2	Diameter measured at different location than previous measurement (remove original d-nail.) or previous diameter was obviously incorrect; value has been updated
	5	Diameter estimated because of moss.
	6	Diameter estimated because of vines.
	7	Diameter estimated (double nail diameter)

**7.7 GROWTH**

**7.7.1 10-Year Increment (PNW)**

This code records bored radial increment inside the bark to the nearest 1/20<sup>th</sup> inch for a 10-year period. Bored increment is required for every tree cored for tree age with an increment borer at the current inventory. Additional increment data will be derived in the office by comparing old diameter measurements to current diameter, and eliminating trees where current diameter is not measured at the same place as past). Note: Do not collect for trees bored for age at a previous visit (when SAMPLE KIND = 2).

**To obtain radial increment:**

- 1) Bore the tree just below the point of diameter measurement (to avoid impacting the diameter measurement), on the side of the tree facing the point. If slope and tree size make this impossible, bore the tree on the side opposite the point.
- 2) Count back 10 growth rings from the cambium end of the core starting from the first fully-formed ring (and skipping this year's summer growth).
- 3) Measure the length of this segment of the core to the nearest 1/20 inches to get radial increment. Enter this radial increment as the number of twentieths, e.g. 18/20 is recorded "18" and 27/20 is recorded "27".

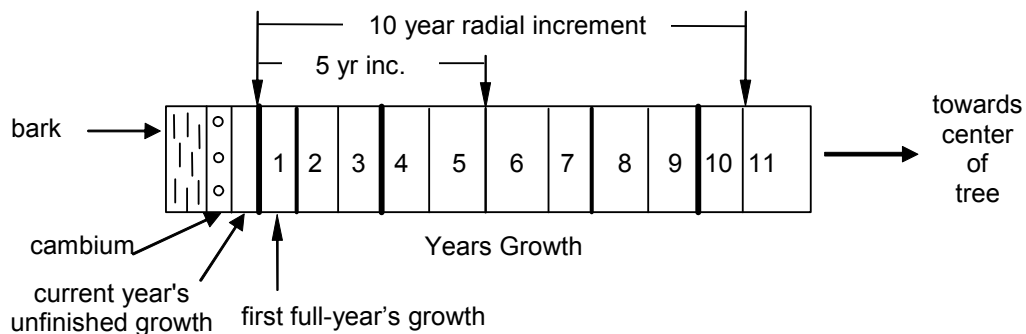

Figure 7-21: Bored tree core showing where to measure 5 and 10 year radial increments.



The cambium is often pinkish in color with a squishy, moist, corklike texture. The current year's unfinished growth is usually very light colored.

When collected:	All trees bored for tree age with an increment borer at the current visit.
Field width:	3 digits
Tolerance:	1/20th per 1 inch of increment
Values:	1 to 999

**7.7.2 5-Year Increment (PNW)**

This code records bored radial increment inside the bark to the nearest 1/20th inch for a 5-year period. 5-Year Bored increment is required for every tree cored for tree age with an increment borer. The procedures for the 5-year increment are the same as for growth 10-Year Increment (10 Inc), except that the increment period is 5 years.

When collected:	All trees cored for 10-Year increment
Field width:	3 digits
Tolerance:	1/20th per 1 inch of increment
Values:	1 to 999

**7.7.3 5-Year Height Growth (PNW)**

For R6 and R5 national forests only, a 5-year height growth will be recorded on saplings (trees  $\geq 1.0$  in and  $< 5.0$  inches DBH). Begin at the sixth branch whorl from the top of the tree and measure to the first branch whorl from the top. Do not count false whorls or the current year's growth. Measure to the nearest 0.1 foot.

Starting from North and working in a clockwise direction on each microplot, record a 5-year height growth measurement for at least the first tree representing each species, in each crown class, for each condition class present on the plot for which a bored increment has not already been measured. Do not count whorls on suppressed trees (either a CROWN CLASS of 5 or Damage Agent 50 is recorded). Although this selection method is to be used on each subplot, only one tree in each species/crown class/ condition class needs a growth measurement on the entire plot.

When collected:	Live saplings (trees $\geq 1.0$ inch and $< 5.0$ inches DBH) on R5 or R6 NFS lands by species/crown class/condition class where bored increment is not being measured. Do NOT record for suppressed trees (CROWN CLASS = 5 and Damage Agent = 50), western woodland species, Pacific yew, hemlocks, or hardwoods.
Field width:	3 digits
Tolerance:	The tolerance depends on the height of the tree: $< 15$ feet    +/- 0.1 feet $15 - 35$ feet    +/- 1.0 ft. $36 - 50$ feet    +/- 2.0 ft. $\geq 50$ feet    +/- 3.0 ft.
Values:	0.1 to 25.0

**7.7.4 Tree Age (PNW)**

This variable is used to determine stand age, and to develop regression estimators of tree growth, mortality and harvest. Trees sampled live, tagged (not tagged in wilderness), and bored at a previous occasion, have Age updated to the current year on the PDR. Trees that have a previous tree number and were bored at previous inventories do not need to be reaged.

Selection: Starting from North and working in a clockwise direction on each microplot and each subplot/macropplot, determine the age of one live tree representing each species, within each crown class, for each condition class present on the plot. Although this selection method is to be used on each subplot, only one tree in each species/crown class/condition class needs to be aged on the entire plot. Example: subplot 1 has a white fir in condition class 1, with a crown class of 3. Over the entire plot, only one white fir in condition class 1 with a crown class of 3 needs to be aged. This selection method is applied regardless of differences in diameter of the trees. On USFS lands where hectare trees are measured (See Section 7.1 and Appendix A1.1), for each species, if no hectare tree has been aged using the selection criteria above, bore the first live hectare tree tallied for each species (regardless of crown class).

The PDR will identify trees to be aged using the above selection criteria.

Do not bore trees with any rot present within the length of the bored increment on which age cannot be accurately determined, or any tree with severe deformities at DBH. Bypass these trees and select the next one by species/crown class/condition class.

Do not bore any western woodland species or any hardwood species except red alder.

Leave the extracted increment core at the base of the tree in a relatively protected location, so it can be relocated if necessary.

**Remeasurement Plots:** It is important to have the age of one live tree representing each species, in each crown class, for each condition class present on the plot at each occasion. Although tree age data were obtained at the previous visit, changes such as death of an aged tree, species corrections, or changes in condition class or crown class may have occurred. Tree data from the previous visit will be downloaded to the PDR on remeasurement plots and will be available for updating. The PDR will alert the user that an additional tree age is required for a given species/crown class/condition class category whenever updated information indicates a missing category.

- **Ages from Previously Cored Trees:** Tree age may be obtained from measurements made at previous inventories. If the previous inventory data are not downloaded to the data recorder, use the plot data sheets to determine which trees were bored for age. Add the number of growing seasons to that age and record the current age. (Note: in R5 NFS only, the previously recorded Tree Age includes 10 years that were added to DBH ages to allow for tree growth to 4.5 feet. Subtract this 10 years before adding the number of seasons to the current year). In some cases, new printed sheets may be provided which update the previous ages to the current year. Ages obtained from previous inventories can be used to fulfill the selection requirements above (species/crown class/condition class), however, the current crew is responsible for the accuracy of these ages.
- **Aging Trees That Have Not Been Cored Previously:** Age trees using one of the following methods:
  - 1) **Core the tree** with an increment borer and record the number of rings between the current year's increment and the pith (See Section 7.7.1. **Core a tree only if it measures  $\geq 5.0$  inches in diameter at 4.5 feet.** Bore the tree just below the point where you took the diameter measurement to avoid impacting future diameter measurements. Extrapolate ages on trees too big to reach the center of the tree with the borer (see instructions below).
  - 2) **Determining Breast-Height Age of Large Trees:** Large tree size is not a valid reason for bypassing a tree from coring. To determine the age of a tree whose radius is greater than the length of the increment borer, use the following procedure. This procedure may be available as a "pop-up" menu on the data recorder.
    - 1 Bore into the tree as far as possible, extract the core (do not discard the bark), and count the rings.
    - 2 Count the number of rings in the inner 2 inches of the core closest to the center of the tree.
    - 3 Measure the total length of the extracted core to the nearest 0.1 inch. (include the entire thickness of bark at point of measurement, even though some of it may not be in the core because it crumbled or the tree was cored in a bark furrow)
    - 4 Divide the tree's diameter by 2 to determine the radius in inches.
    - 5 Subtract #3 (length of the extracted core) from #4 (the radius in inches). The result is the length in inches that the extracted core is short of reaching the tree center.
    - 6 Divide #5 (inches from the core to tree center) by 2 inches. The result equals the number of 2 inch lengths to the tree center.
    - 7 Multiply #6 by the number of rings in the inner 2 inches (#2) to determine the number of rings from the inner end of the extracted core to the tree center.
    - 8 Add #7 to the total number of rings in the extracted core (#1). This is the tree's estimated breast-high age (i.e. number of rings in the entire radius).
    - 9 Note "extrapolated age" with an "e" by typing a "v" after the age to summon a drop down list, then choosing "e".

**Example:** Determine the age of a 59.6-inch Douglas-fir. The core has 110 rings, and has 10 rings in the inner 2 inches. 0.8 inches of the 16.4-inch-long increment borer did not penetrate the tree. Each number below is associated with its corresponding step above:

- Step 1: 110 rings counted
- Step 2: 10 rings in the inner 2 inches of the core
- Step 3: 14.6 inches of core was extracted + 1 in of bark that was not in the core = 15.6
- Step 4: 59.6 inches is the tree's diameter and you then divide by 2 = 29.8 inches to center of tree (pith)
- Step 5: 29.8 inches (true center) – 15.6 inches (measured core) = 14.2 inches short of reaching the pith

Annual Inventory 2007, Chapter 7: Live and Standing Dead Tree Tally

- Step 6: 14.2 inches / 2 = 7.1 (2 inches ) lengths short
- Step 7: 7.1 (from step 6) x 10 (from step 2) = 71 rings not counted
- Step 8: 110 rings counted (step 1) + 71 rings not counted (step 7) = 181 years old at BH
- Step 9: Note “extrapolated age” with an “e” by typing a “v” after the age to summon a drop down list then choosing “e”

3) Age can also be determined by counting the whorls of tally saplings (trees < 5.0 inches at DBH). If no suitable tree ≥ 5.0 inches DBH is available for a given species/crown class/condition class combination, check for the species in the microplot sapling tally. Count whorls above the 4.5 foot mark if < 5.0 inches at DBH. ONLY age pines, Douglas fir, and true fir trees < 5.0 inches in diameter by whorl count.

When collected:	First live tree by species/crown class/ condition class, and first hectare tree by species if no hectare tree of that species selected by above rule
Field width:	3 digits
Tolerance:	Trees with measured age: +/- 10% Trees with estimated age: +/- 20% Trees with extrapolated age: +/- 30%
Values:	1 to 999

**7.7.5 Tree Age Method (PNW)**

Trees bored or ‘whorl-counted’ at the current inventory are marked with a “+” to the right of the age. Ages that are derived from previous printed inventory data are marked with a “p”. Ages that are downloaded from the previous annual inventory and updated to the current year are marked with an “\*”. Extrapolated ages are marked with an “e”. The “+”, “p”, “\*”, and “e” are entered on the PDR by typing the “V” key while the cursor is in the tree age field.

When collected:	Trees bored or whorl-counted at the current inventory
Field width:	1 digit
Tolerance:	No errors
Values:	+, *, p, e

**LENGTH**

**7.7.6 ACTUAL LENGTH (CORE 5.15)**

For trees with missing tops (top on live trees is completely detached; top on dead trees is greater than 50 percent detached from the tree). Record the ACTUAL LENGTH of the tree to the nearest 1.0 foot from ground level to the break. Use the length to the break for ACTUAL LENGTH until a new leader qualifies as the new top for TOTAL LENGTH; until that occurs, continue to record ACTUAL LENGTH to the break. Trees with previously broken tops are considered recovered (i.e., ACTUAL LENGTH = TOTAL LENGTH) when a new leader is 1/3 the diameter of the broken top at the point where the top was broken (not where the new leader originates from the trunk). Forked trees should be treated the same as unforked trees. *ACTUAL LENGTH is the length of the bole, not the vertical height and should only differ from TOTAL LENGTH if the tree has a broken or missing top.*

When collected:	All live and standing dead tally trees
Field width:	3 digits
Tolerance:	Live trees < 60 feet : +/- 5% of true length Live trees ≥ 60 feet and all dead trees: +/- 10% of true length
Values:	001 to 400

**7.7.7 TOTAL LENGTH (CORE 5.14)**

Record the TOTAL LENGTH of the tree, to the nearest 1.0 ft from ground level to the top of the tree. For trees growing on a slope, measure on the uphill side of the tree. If the tree has a missing top (top is broken and completely detached from the tree), estimate what the total length would be if there were no missing top. Forked trees should be treated the same as unforked trees.

Height on leaning trees: Measure or estimate total normally-formed bole length (from the base to the tip of the tree), and not the perpendicular from the ground to the tip. To measure heights of leaning trees using a clinometer, follow these steps:

- 1) Move to a point along a line (point D) that is perpendicular to the plane in which the tree is leaning.
- 2) Using your clinometer, measure the height of point A above point B.
- 3) By standing at the base of the tree and sighting up the bole with your clinometer, measure the slope of the bole in degrees. (Angle E in the diagram above)
- 4) Subtract the degrees of lean (step 3.) from 90 degrees. This gives you the degrees of angle F.
- 5) By sighting through your clinometer, convert the angle calculated in step 4 to a percentage.
- 6) Use the slope correction table, Appendix 5.3 to determine the expansion factor for the percent slope determined in step 5. Multiply the expansion factor by the measured distance from point A to point B (step 2). This gives the length of the bole (point A to point C).

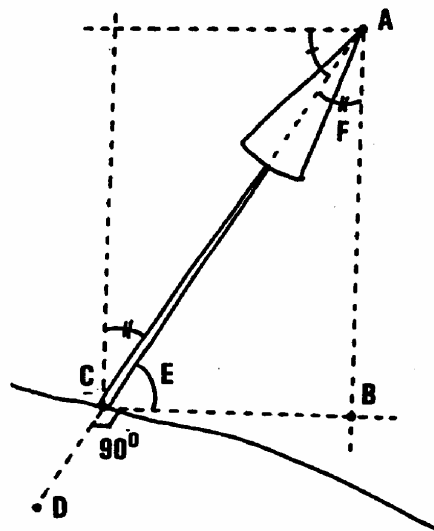

Figure 7-22: Measuring height of leaning tree.

When collected:	All live tally trees $\geq 1.0$ inches DBH/DRC and, All standing dead tally trees $\geq 5.0$ inches DBH/DRC
Field width:	3 digits
Tolerance:	+/- 10% of true length
Values:	001 to 400

**7.7.8 LENGTH METHOD (CORE 5.16)**

Record the code that indicates the method used to determine tree lengths.

When collected:	Phase 2 CORE - All live tally trees $\geq 5.0$ in DBH/DRC and all standing dead tally trees $\geq 5.0$ in DBH/DRC		
Field width:	1 digit		
Tolerance:	No errors		
Values:	Data Recorder Code	Code	Length Method
	B	1	Actual and total lengths are field measured with a measurement instrument (e.g., laser, clinometer, relascope)
	A	2	Actual length is measured with an instrument, total length is visually estimated
	N	3	Actual and total and lengths are visually estimated (not measured).

**7.7.9 Previous Actual Length (PNW)**

This is the tree height (Actual Length) assigned at the previous survey. It has been downloaded from the previous inventory.

**7.8 TREE LIVE CROWN MEASUREMENTS**

**7.8.1 COMPACTED CROWN RATIO (CORE 5.19)**

Record the COMPACTED CROWN RATIO for each live tally tree, 1.0 in and larger to the nearest 1 percent. COMPACTED CROWN RATIO is that portion of the tree supporting live foliage (or in the case of extreme temporary defoliation, should be supporting live foliage) and is expressed as a percentage of the ACTUAL TREE LENGTH (i.e. include dead tops, but not missing tops in the ratio). To determine COMPACTED CROWN RATIO, ocularly transfer lower live branches to fill in large holes in the upper portion of the tree until a full, even crown is visualized. Try to picture the normal density of photosynthetic foliage and adjust for it (i.e. some branches may be very sparse with needles/leaves). Do not over-compact trees beyond their typical full crown situation. For example, if tree branches tend to average 2-feet between whorls, do not compact crowns any tighter than the 2-foot spacing. Include epicormic branches once they are 1" diameter.

Crown ratio is based on the ratio of foliage, not where the limbs attach to the tree bole.

Crown ratio is an indicator of a tree's vigor. In data analysis, trees with a crown ratio of 30 percent or less are considered less vigorous. For this reason, be particularly careful when deciding between codes greater or less than "30." It is preferable to use a laser or clinometer to measure live crown ratios on these trees.

When collected:	All live tally trees $\geq$ 1.0 inches DBH/DRC
Field width:	2 digits
Tolerance:	+/- 10% (10% of 100)
Values:	00 to 99

**7.8.2 CROWN CLASS (CORE 5.17)**

Rate tree crowns in relation to the sunlight received and proximity to neighboring trees (Figure 7-23). Base the assessment on the position of the crown at the time of observation. Example: a formerly overtopped tree which is now dominant due to tree removal is classified as dominant.

Crown class describes a tree's "social" position in the stand and may indicate how well the tree is competing for light.

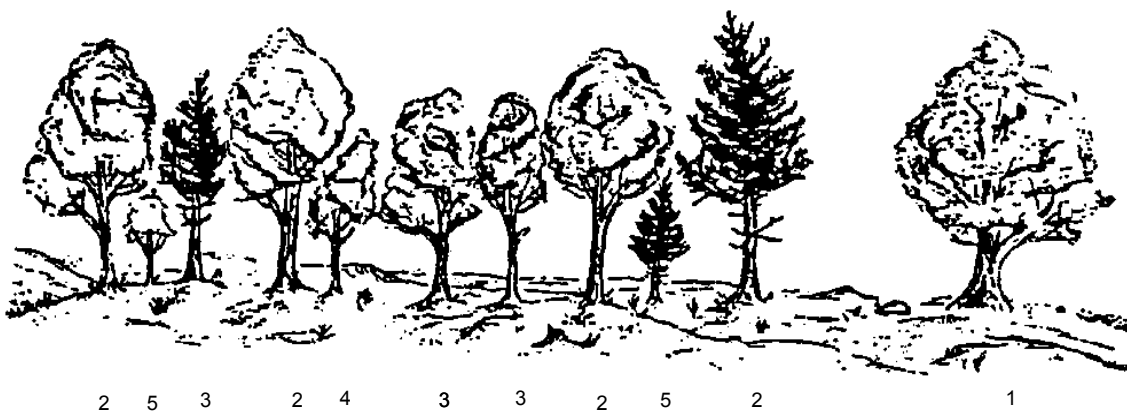

Figure 7-23: Examples of CROWN CLASS by code numbers.

Crown classifications are easily applied in even-aged stands. Classifications are more difficult to assign in uneven-aged stands or in plots where more than one age class is present. In these situations, classify the tree based on its immediate environment. In other words, base your classification on how much light the tree's crown is receiving, not its position in the canopy. This data item is used to predict tree growth. The intermediate and overtopped crown classes are meant to include trees seriously affected by direct competition with adjacent trees.

For example, a young, vigorous tree that is considerably shorter than other trees in the stand-but that is not overtopped by other trees and that receives full light from above and partly from the side-is classified as dominant. The same principle applies to two-storied stands: understory trees should only be assigned subordinate crown classes if they are adjacent to overtopping trees. In plots with scattered residual overstory trees over younger trees, a considerable portion of the understory trees will be classified as dominant or codominant.

When collect:	All live tally trees $\geq$ 1.0 inches DBH/DRC		
Field width:	1 digits		
Tolerance:	No errors		
Values:	Code	Crown class	Definition
	1	Open grown	Trees with crowns that receive full light from above and from all sides throughout most of its life, particularly during its early developmental period.
	2	Dominant	Trees with crown extending above the general level of the crown canopy and receiving full light from above and partly from the sides. These trees are taller than the average trees in the stand and their crowns are well developed, but they could be somewhat crowded on the sides. Also, trees whose crowns have received full light from above and from all sides during early development and most of their life. Their crown form or shape appears to be free of influence from neighboring trees.
	3	Codominant	Trees with crowns at the general level of the crown canopy. Crowns receive full light from above but little direct sunlight penetrates their sides. Usually they have medium-sized crowns and are somewhat crowded from the sides. In stagnated stands, codominant trees have small-sized crowns and are crowded on the sides.
	4	Intermediate	These trees are shorter than dominants and codominants, but their crowns extend into the canopy of codominant and dominant trees. They receive little direct light from above and none from the sides. As a result, intermediate trees usually have small crowns and are very crowded from the sides.
	5	Overtopped	Trees with crowns entirely below the general level of the crown canopy that receive no direct sunlight either from above or the sides

## 7.9 TREE DAMAGE

Tree damage is characterized using three attributes: damage agent, location of damage, and severity of damage. Damage agents, their locations and severity codes are used to indicate the locations on a tree, the type of agents present, and to indicate each damage severity. **Class I Agents are coded first, followed by Class II Agents.** Class I insects, diseases, or physical injuries can seriously affect trees. Accounting for these agents helps provide for predicted outcomes for tree growth and survival, vegetative composition and stand structure. Class II agents can be important especially in local situations; recording their incidence, location, and severity provides valuable regional information. **Class II agents are recorded when present but only after all Class I agents.**

Agents, their locations and severity ratings are further grouped by broad category. Each category has a general agent and specific agents listed. Table 7-1 shows the Class I and Class II damage agents grouped by category, their agent codes, locations, and severity ratings. See Section 7.9.11 for dwarf mistletoe.

### DAMAGE DEFINITIONS

Damage Location: records the location on the tree of the damage agent. Locations include:

0. No damage found
1. Roots - Above ground up to 12" on bole

Annual Inventory 2007, Chapter 7: Live and Standing Dead Tree Tally

2. Bole - Main stem(s) starting at 12" above ground including forks up to a 4" top. (A fork is at least equal to 1/3 diameter of the main stem, and occurs at an angle <45° in relation to the main stem). For the purpose of damage woodland species will not have a "bole" location.
3. Branch - All other woody material. Primary branch(s) occur at an angle ≥45° in relation to the bole and are < 1/3 the diameter of the bole. For western woodland species (Appendix 9) there is no bole damage location; use only roots, branches, or foliage.
4. Foliage - All leaves, buds and shoots.

Damage Agent: There are 41 specific Damage Agent codes nested within 16 general damage CATEGORIES and an UNKNOWN category. A maximum of 2 damages can be recorded for any tree. The agents are divided into two classes based on their impact on the trees. Class I agents are the most important and are coded before any Class II agents regardless of location or severity (See Table 7-1). The general codes should be used if there is any question as to the identity of the specific damage agent. Use UNKNOWN only when the general damage can not be identified. An Unknown Damage Symptom must be coded whenever the Unknown Damage Agent is used; the unknown damage should be described in the TREE NOTES variable (Section 7.10.4).

Damage Severity: The Severity code describes the extent or intensity of the damage. Exception: White pine blister rust has two Damage Severity codes: A) % of area damaged and B) risk rating code.

Unknown Damage Type: This variable is only recorded for an UNKNOWN damage (Damage Agent 90), in addition to the Damage Location code (1, 2, 3, or 4), and Damage Severity rating (% of affected location). The Damage Symptom is coded in one of the following 6 categories:

1. Canker, gall: Cankers may be caused by various agents but are most often caused by fungi. The bark and cambium are killed, and this is followed by death of the underlying wood, although the causal agent may or may not penetrate the wood. This results in areas of dead tissue that become deeper and wider, or galling (including galls caused by rusts), on roots, bole, or branches. Due to the difficulty in distinguishing some abnormal swellings (e.g., burls) from classic galls and cankers, all are recorded as Damage Type 1. A canker may be: **Annual** (enlarges only once and does so within an interval briefer than the growth cycle of the tree, usually less than one year), **Diffuse** (enlarges without characteristic shape or noticeable callus formation at margins), or **Perennial** (enlarges during more than one year and often has a target appearance).
2. Open wounds: An opening or series of openings where bark has been removed or the inner wood has been exposed and no signs of advanced decay are present. Improper pruning wounds that cut into the wood of the main stem are coded as open wounds; those which leave the main stem wood intact are excluded.
3. Resinosis: The origin of areas of resin or gum (sap) exudation on branches and trunks.
4. Broken: This Damage Type includes: 1) Broken roots either from excavation or root sprung for any reason, such as excavated in a road cut or by animals; 2) Branches that are broken or dead. Dead or broken branches attached to the bole or crown stem outside the live crown area are not coded.
5. Damaged or discolored foliage: Insect feeding, shredded or distorted foliage, buds or shoots. This damage type also includes herbicide or frost-damaged foliage, buds or shoots.
6. Other: Use when no other explanation is appropriate. Specify in the TREE NOTES section.

Table 7-1. Damage Agents, Codes, and Severity Ratings in order of importance

**Class I Agents** (not in order of importance)

Category	Agent	Agent Code	Location	Severity
BARK BEETLES	General	01	1-Roots 2-Bole	1 - Successful current attack: foliage still green, boring dust, pitching 2 - Last year's successful attack: fading foliage (some green somewhere on crown), boring dust, pitching 3 - Top kill: top of tree dead (no green needles remaining, completely red with no or dead buds, or "gray" because the needles have fallen off); green needles on lower live portion of tree.

Annual Inventory 2007, Chapter 7: Live and Standing Dead Tree Tally

DEFOLIATORS	General	10	4-Foliage	<p>Note: Only code for defoliation if 10% or more of the foliage over the whole tree is damaged. Divide live crown into thirds (See figure 7-19) Rate each third separately based on the following classes:</p> <p>0 - No detectable defoliation                      1 - Up to 33% of foliage (old and new) affected                      2 - 34 to 66 % of foliage affected                      3 - 67 to 100% of foliage affected</p> <p>Obtain severity rating by adding ratings for each third. Record total (1 – 9)</p>
	Budworm	29		
ROOT DISEASE	General/other	60	1-Roots	<p>1 - Tally tree is within 30 feet of a tree or stump that has a root disease to which the tally tree is susceptible.</p> <p>2 - Tally tree with root disease signs/symptoms such as characteristic decay, stain, ectotrophic mycelia, mycelial fans, conks, excessive resin flow at the root collar. <b>No visible crown deterioration.</b></p> <p>3 - Tally tree with root disease signs/symptoms such as characteristic decay, stain, ectotrophic mycelia, mycelial fans, conks, excessive resin flow at the root collar, <b>AND Visible crown deterioration</b> such as thinning chlorotic foliage, reduced terminal growth, and/or stress cones.</p>
	Annosus	61		
	Armillaria	62		
	Black stain	63		
	Port-Orford-cedar root disease	66		
	Laminated root rot	65		
White Pine Blister Rust	White pine blister rust	36	2-Bole 3-Branches	<p>White pine blister rust has two severity ratings: A) percent of area damaged, and B) categorical risk rating.</p> <p>Severity A: Record percent of affected location: X % of bole circumference, (combine multiple affected locations if they occur <math>\leq</math> 3 vertical feet of each other on the bole), <b>OR</b> X % of branches (crown volume) affected.</p> <p>Severity B: 1 - Branch infections located more than 2.0 feet from tree bole                      2 - Branch infections located 0.5 to 2.0 ft from tree bole                      3 - Branch infection located within 0.5 ft of tree bole <b>OR</b> tree bole infection present</p>
Sudden Oak Death	Sudden oak death (CA Only)	31	2-Bole	<p>1 - Bleeding present on bole                      2 - Bleeding present on bole and adjacent mortality present                      3 - Laboratory confirmed Sudden Oak Death (NOT to be coded by field crew)</p> <p>Note: Anytime PNW Damaging Agent 31 is coded, a sample of the damage is required. Follow the instructions in Appendix A2.7 Sudden Oak Death (SOD) Syndrome.</p>
PITCH CANKER	Pitch canker (CA Only)	32	2-Bole 3-Branches	<p>1 - No bole canker present and there are less than 10 infected branch tips                      2 - No bole canker present and there are 10 or more infected branch tips                      3 - One or more bole cankers present and there are less than 10 infected branch tips                      4 - One or more bole cankers present and there are 10 or more infected branch tips</p>



Annual Inventory 2007, Chapter 7: Live and Standing Dead Tree Tally

BALSAM WOOLY ADELGID	Balsam woolly adelgid (WA/OR Only)	24	2-Bole 3-Branches	Record percent of affected location: X % of bole circumference, (combine multiple affected locations if they occur $\leq$ 3 vertical feet of each other on the bole), <b>OR</b> X % of branches (crown volume) affected.
----------------------	------------------------------------	----	----------------------	--------------------------------------------------------------------------------------------------------------------------------------------------------------------------------------------------------------------------------

**Class II Agents** (not in order of importance)

Category	Agent	Agent Code	Location	Severity
OTHER INSECTS (Some plantation insects in California may be highly important. Treat these as Class I Agents.)	General	20	2-Bole 3-Branches 4-Foliage	Record percent of affected location: X % of bole circumference, (combine multiple affected locations if they occur $\leq$ 3 vertical feet of each other on the bole), <b>OR</b> X % of branches (crown volume) affected, <b>OR</b> X % of foliage whose individual leaves or needles are damaged by more than 50 %.
STEM BRANCH CANKERS	General	40	2-Bole 3-Branches	Record percent of affected location: X % of bole circumference, (combine multiple affected locations if they occur $\leq$ 3 vertical feet of each other on the bole), <b>OR</b> X % of branches (crown volume) affected.
	Western gall rust	41		
STEM DECAYS	General	46	2-Bole	1 - One conk on the bole or present at ground level 2 - Two or more conks separated by <16 feet on bole 3 - Two or more conks separated by $\geq$ 16 feet on bole 4 - No conks. Visible decay in interior of bole. Do not include decay found only as a result of coring the tree.
	Red ring rot ( <i>Phellinus pini</i> )	47		
	Indian paint fungus ( <i>Echinodontium tinctorium</i> )	48		
	Velvet top fungus ( <i>Phaeolus schweinitzii</i> )	49		
	Brown cubical rot ( <i>Laetiporus sulfureus</i> ) (CA Only)	52		
FOLIAR PATHOGENS	General	55	3-Branches (brooming) 4-Foliage	Record percent of affected location: X % of branches (crown volume) affected. X % of foliage whose individual leaves or needles are damaged by more than 50 %.
	<i>Elytroderma</i> (only on PIPO)	57		
PARASITIC/ EPIPHYTIC PLANTS	Parasitic/Epiphytic Plants --Vines --Leafy Mistletoe on white fir (CA only), juniper, incense cedar, and oaks	54	2-Bole 3-Branches	1 -- < 50% of the total branches infected 2 -- $\geq$ 50% of crown involved. Any occurrence on the bole
ANIMAL AGENTS	General /unknown	70	1-Roots 2-Bole	Record percent of affected location: X % of roots affected, <b>OR</b> X % of bole circumference, (combine multiple affected locations if they occur $\leq$ 3 vertical feet of each other on the bole), <b>OR</b> X % of branches (crown volume) affected, <b>OR</b> X % of foliage whose individual leaves or needles are damaged by more than 50 %.
	Mountain beaver	71	3-Branches	
	Livestock	72	4-Foliage	
	Deer or elk	73		
	Porcupines	74		
	Pocket gophers, squirrels, mice, voles, rabbits, hares	75		
	Beaver	76		
	Bear	77		

Annual Inventory 2007, Chapter 7: Live and Standing Dead Tree Tally

	Human (not logging)	78		
WEATHER AGENTS	Windthrow or wind breakage	81	2-Bole 3-Branches 4-Foliage	Record percent of affected location: X % of bole circumference, (combine multiple affected locations if they occur $\leq$ 3 vertical feet of each other on the bole), <b>OR</b> X % of branches (crown volume) affected, <b>OR</b> X % of foliage whose individual leaves or needles are damaged by more than 50 %.
	Snow/ice bending or breakage	82		
	Lightning	87		
PHYSICAL INJURY	Logging damage	91	1-Roots 2-Bole 3-Branches 4-Foliage	Record percent of affected location: X % of roots affected, <b>OR</b> X % of bole circumference, (combine multiple affected locations if they occur $\leq$ 3 vertical feet of each other on the bole), <b>OR</b> X % of branches (crown volume) affected, <b>OR</b> X % of foliage whose individual leaves or needles are damaged by more than 50 %.
	Fire: basal scars or scorch	92		
PHYSICAL DEFECTS	Broken/missing top	96	2-Bole 3-Branches	Severity is not rated. Enter "0" for Damage Agents 96, 97, 98, and 99
	Dead top	97		
	Forks and Crooks (only if caused by old top out or dead top)	98		
	Checks or bole cracks	99		
SPECIAL AGENTS	Suppression	50	2-Bole	Severity is not rated. Enter "0" for Damage Agent 50 (Code this agent if tree is overtopped by other trees and will not live 10 more years, or will prevent a sapling from reaching 5.0 inches DBH/DRC)
	Excessively deformed sapling	51		Severity is not rated. Enter "0" for Damage Agent 51 (Code this agent on live trees (1.0-4.9 in DBH/DRC) that will never produce a minimum log. A minimum log for conifers is 16.0 feet long, and for hardwoods is 8.0 feet long.
UNKNOWN	Unknown	90	1-Roots 2-Bole 3-Branches 4-Foliage	Record percent of affected location: X % of roots affected, <b>OR</b> X % of bole circumference, (combine multiple affected locations if they occur $\leq$ 3 vertical feet of each other on the bole), <b>OR</b> X % of branches (crown volume) affected, <b>OR</b> X % of foliage whose individual leaves or needles are damaged by more than 50 %.

**IDENTIFYING AND RECORDING DAMAGE**

Record up to two different damages per tree. If more than two damaging agents are found on a tree, then code the two agents thought to have the most impact. The crew observes the entire tree from roots, bole, branches, to foliage (locations 1-4) and records the damage location. Woodland species (See Appendix 9 for a list of these species) have locations: roots, branches, and foliage (1, 3, and 4), but no bole location. Enter 0 in the damage location field when no damage is found.

If there is a known cause to any observed damage its location is recorded (location 1, 2, 3, or 4), followed by the specific agent (e.g. Armillaria root disease), location code, and severity. If the agent can be placed into only a general damage agent category (e.g. root disease) record the location, the general agent code and the corresponding damage severity. If there are two (or more) known causal agents the top two are recorded in order from most to least important (Class I > Class II; root agents > bole > branch > foliage).

Annual Inventory 2007, Chapter 7: Live and Standing Dead Tree Tally

If damage from an unknown cause is observed it is recorded as the first (and second, if there is more than one unknown damage) only if the specific or general damage agent can not be identified. The location (1-4) is noted, then the agent, Unknown (90), then the severity (based on the type of damage and location), and a description of the Unknown Damage Symptom. Finally, describe the unknown damage in the TREE NOTES variable (Section 7.10.4). The Unknown Damage Symptom is required only for unknown damages, and is used for descriptive purposes. It has no associated MQO.

Four examples of damage agents and how to record them:

(1) A typical unknown damage: A tree has an open wound on the bole which encompassed 30% of the circumference at the point of occurrence from an unknown cause (Recorded description in TREE NOTES).

Location	Agent	Severity A	Unknown Damage Symptom
2	90	30	2

Note: No damage sign or symptom is required for any general or specific causal agent.

(2) A tree with 1general damage: A tree is within 30 feet of another tree that has some kind of root disease.

Location	Agent	Severity A
1	60	1

(3) A tree with two damages, 1 general and 1 specific: An unknown bark beetle successfully attacked a tree bole in a previous year; and wind damaged 35 % of the branches in the tree.

Location	Agent	Severity A
2	01	2
3	81	35

(4) A tree with white pine blister rust damage in two locations: White pine blister rust has infected 25% of a running 3 foot section of the tree bole and 45% of the branches from 0.5 to 2.0 feet from the tree bole.

Location	Agent	Severity A	Severity B
2	36	25	3
3	36	45	2

**7.9.1 Damage Location 1 (PNW)**

Record the location on the tree where Damage Agent 1 is found. When multiple damages occur in the same location, record the higher priority damage (Class I) first. If the damages are coincident (e.g. a conk on a bole with bark beetle symptoms), record only the higher priority damage (bark beetles).

When collected:	All live tally trees ( $\geq 1.0$ inches DBH/DRC)		
Field width:	1 digit		
Tolerance:	+/- 1 location class		
Values:	Code	Loc	Description
	0		No damage found
	1	Roots	Above ground up to 12 inches on bole
	2	Bole	Main stem(s) starting at 12 inches above the ground, including forks up to a 4 inch top. (A fork is at least equal to 1/3 diameter of the bole, and occurs at an angle $<45$ degrees in relation to the bole. This is not a valid location code for woodland species; use only locations 1, 3, and 4.
	3	Branch	All other woody material. Primary branch(s) occur at an angle $\geq 45$ o in relation to the bole.
4	Foliage	All leaves, buds, and shoots	

**7.9.2 Damage Agent 1 (PNW)**

Damage Agent: a 2-digit code entered in two agent fields (Damage Agent 1 and Damage Agent 2). For all trees tallied live at last field visit, record no more than two Damage Agents.

When collected:	All live tally trees with Damage Location 1 > 0
Field width:	2 digits
Tolerance:	Agents detected and classified in correct category
Values:	01 to 91 See Table 7-1

### 7.9.3 Damage Severity 1A (PNW)

Damage Severity depends on the Damage Agent coded (See Table 7-1). Enter a 2-digit code indicating either percent of location damaged (01 – 99), or the appropriate class of damage (Values vary from 0 – 4 depending on the specific Damage Agent).

When collected:	All live tally trees with Damage Location 1 > 0
Field width:	2 digits
Tolerance:	+ / - 10%. No errors in classes
Values:	01 to 99 OR 0 to 4. Depends on Damage Agent (See Table 7-1)

### 7.9.4 Damage Severity 1B (PNW)

Damage Severity B is only coded when Damage Agent is white pine blister rust (36). Enter a 1-digit code indicating damage class (1 – 3).

When collected:	All live tally trees with Damage Location 1 > 0 and Damage Agent 1 = 36 (White pine blister rust)
Field width:	1 digit
Tolerance:	No errors in classes
Values:	Branch infections located more than 2.0 feet from tree bole Branch infections located 0.5 to 2.0 ft from tree bole Branch infection located within 0.5 ft of tree bole OR tree bole infection present

### 7.9.5 Unknown Damage Type 1 (PNW)

When UNKNOWN damage (90) is recorded, also describe the sign or symptom in one of 6 categories. See example 1 above.

When collected:	All live tally trees with Damage Location 1 > 0 and Damage Agent 1 = 90 (Unknown)
Field width:	1 digit
Tolerance:	No errors
Values:	1 canker/gall 2 open wound 3 resinosis 4 broken 5 damaged or discolored foliage 6 other

When more than one damage agent exists on a tally tree or a single damage agent exists in a second coded location, record the second damage information as above. Enter 0 for Damage Location 2 if a second damage agent is not recorded.

### 7.9.6 Damage Location 2 (PNW)

See 7.1.1 Damage Location 1.

### 7.9.7 Damage Agent 2 (PNW)

See 7.1.2 Damage Agent 1.

### 7.9.8 Damage Severity 2A (PNW)

See 7.1.3 Damage Severity 1A.

### 7.9.9 Damage Severity 2B (PNW)

See 7.1.4 Damage Severity 1B.

### 7.9.10 Unknown Damage Type 2 (PNW)

See 7.1.5 Unknown Damage Type 1.

**7.9.11 DWARF MISTLETOE CLASS (CORE OPTIONAL 5.26)**

Rate all live conifer species, except juniper species and incense cedar,  $\geq 1.0$  in diameter for dwarf mistletoe (*Arceuthobium* spp.) infection. Use the Hawksworth six-class rating system: divide the live crown into thirds, and rate each third using the following scale. (Figure 7-24):

Code	Mistletoe	Description
0	No visible infection	None
1	Light infection	< 50 percent of the total branches infected
2	Heavy infection	$\geq 50$ percent of the total branches infected

Sum the three individual ratings to obtain and record a total mistletoe class (0 to 6) for the tree.

**Example:** A conifer tree has no infection in top third of crown, light infection in the middle third, and has many brooms in the lower third.

The total score is:  $0 + 1 + 2 = 3$ ; the code is: "3"

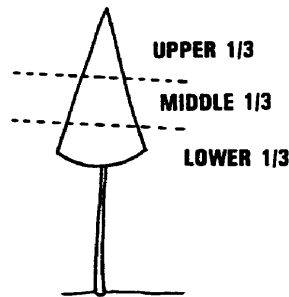

Figure 7-24: Example of the Hawksworth six-class rating system.

When collected:	All live conifer (except juniper) tally trees $\geq 1.0$ in DBH/DRC
Field width:	1 digit
Tolerance:	+/- 1 class
Values:	0 to 6: Conifer (except juniper and incense cedar) trees $\geq 1.0$ in DBH/DRC,

**7.9.12 ROTTEN/MISSING CULL (CORE 5.13)**

Record the percent rotten or missing cubic-foot cull to the nearest percent for all live tally trees greater than or equal to 5 inches DBH/DRC.

When estimating volume loss (tree cull), only consider the cull on the merchantable bole/portion of the tree, from a 1-foot stump to a 4-inch top. Do not include any cull estimate above ACTUAL LENGTH. For western woodland species, the merchantable portion is between the point of DRC measurement to a 1.5 inch DOB top.

Rotten and missing volume loss is often difficult to estimate. Refer to supplemental disease and insect pests field guides and local defect guidelines *below* as an aid in identifying damaging agents and their impact on volume loss. Use your best judgment and be alert to such defect indicators as the following:

- Cankers or fruiting bodies.
- Swollen or punky knots.
- Dull, hollow sound of bole (use regional standards).
- Large dead limbs, especially those with frayed ends.
- Sawdust around the base of the tree.

Record the reason for the ROTTEN/MISSING CULL by recording a PNW Damage Agent code when appropriate (Section 7.9). Note: it may not be possible to record a Damage Agent if two higher priority Damage Agents have already been recorded.

Annual Inventory 2007, Chapter 7: Live and Standing Dead Tree Tally

When collected:	All live tally trees $\geq$ 5.0 inches DBH/DRC
Field width:	2 digits
Tolerance:	+/- 10%
Values:	00 to 99

When estimating tree cull, first estimate and record the percent ROTTEN/MISSING CULL using the guidelines provided below (Table 7-2). When a portion of a tree includes both ROTTEN/MISSING and ROUGH CULL, include the estimated portion as ROTTEN/MISSING CULL only. ROUGH CULL and ROTTEN/MISSING CULL should never add to more than 100 percent.

If the tree is physically missing some of its volume (below ACTUAL HEIGHT), use the volume estimation tables (Table 7-3) below to estimate the percent that is missing. Broken tops occur above ACTUAL HEIGHT and are not included in ROTTEN/MISSING CULL (the volume of the broken top is obtained in the office by comparing ACTUAL vs. TOTAL HEIGHT). Use the following PNW-FIA regional guidelines to determine the PERCENT ROTTEN cull in the tree.

The following are indicators that bole rot exists:

- Open or closed trunk wound over 10 years old and in contact with ground.
- Open trunk wound with visible rot or a closed trunk wound >10 years old. To qualify, the wound must be either 10 ft long in lower half of bole or 16 ft long in top half of bole. For true fir and hemlock, the wound must be  $\geq$  5 ft long anywhere on bole.
- Tree is a conifer and has, in lower 2/3 of the bole, 2 or more crooks or forks which indicate past top out.
- Swollen or hollow butt.
- Large rotten knots or limb stubs.
- Conks

Table 7-2: Percent Rotten Cull guidelines

% Rotten Cull Guide	Indicators of this class
Bole is 75 % to 99 % rotten if one or more of these indicators are present	- <i>E. tinctorium</i> or <i>P. pini</i> conks present and spread along > 60% of bole - <i>E. tinctorium</i> or <i>P. pini</i> conks present and spread along >30% of bole and top missing - > 60% of bole rotten based on rot indicators above - 30 to 59 % of bole rotten and top out - <i>Oligoporus amarus</i> rot, conk or shot hole cup on incense cedar or <i>Fomitopsis officinalis</i> conk on douglas fir, pine, larch - Hardwood > 100 years old and any amount of rot or 2 or more conks
Bole is 40 % to 74 % rotten if one or more of these indicators are present	- <i>E. tinctorium</i> or <i>Phellinus cancriformans</i> present - <i>P. pini</i> conks spread along 30-59% of bole - 30-59% of bole rotten based on rot indicators above - Tree is a hardwood and one conk present
Bole is 10 % to 39 % rotten if one or more of these indicators are present	- none of above class indicators present (as noted in this table) - > 10% of bole rotten based on rot indicators above
Bole is less than 10 % rotten	- < 10% of bole rotten based on rot indicators above

Use Table 7-3 as a guideline for estimating the missing percent of the tree to cull. It shows the percent of volume in typical trees of varying Number of Logs and Heights. Use either the Tree Height in Logs (divide the length to a 4 inch top – diameter inside bark (DIB) – by 16) or the measured TOTAL LENGTH to estimate what percent of volume is estimated in each 16 ft log. Multiply each percent in that log section times the percent of rotten or missing volume. Then sum the values to get the total percent of the tree that is rotten or missing. Example: A 9-log tree (measured at 160 feet Total Length) has a missing section that is about 1/3 of both the second and third logs. From Table 7-3 you see the second log has about 18% of the volume in the tree, and the third log has about 16% of the volume in the tree. You calculate  $(0.18 * 0.33) + (0.16 * 0.33) = 0.06 + 0.05 = 0.11$  to estimate that the cull percent for the tree is about 11%.

Table 7-3: % tree cubic foot volume distribution by 16 foot log from tree total length or tree height in logs for a tree of average dimensions.

Avg Total Length	TREE HT in LOGS	LOG1	LOG2	LOG3	LOG4	LOG5	LOG6	LOG7	LOG8	LOG9	LOG10	LOG11	LOG12
28	1	100											
48	2	71	30										
64	3	54	32	14									
80	4	43	30	19	8								
96	5	36	27	20	12	5							
111	6	31	24	19	14	8	3						
127	7	28	22	18	14	10	6	2					
143	8	25	20	17	14	11	8	4	1				
158	9	24	18	16	13	11	8	6	3	1			
176	10	22	17	15	13	11	9	7	5	3	1		
194	11	20	15	14	12	11	9	7	6	4	2	1	
212	12	19	14	13	12	10	9	8	6	4	2	1	0

### 7.9.13 ROUGH CULL (CORE OPTIONAL 5.25)

For each live *Conifer* or *red alder* tally tree 5.0 inches DBH/DRC or larger, record the total percentage of **cubic-foot volume** that is cull due to sound dead material or tree form. Record to the nearest 1 percent. When estimating volume loss (tree cull), only consider the cull on the merchantable bole/portion of the tree, from a 1-foot stump to a 4-inch top. *When a portion of a tree includes both ROTTEN/MISSING and ROUGH CULL, do not include it in ROUGH CULL.*

For western woodland species, the merchantable portion is between the point of DRC measurements to a 1.5-inch DOB top, and rough cull includes only sound dead material.

Refer to Table 7-3 as an aid in determining cull volume for various damages such as crook, fork, sweep, pistol butt, etc. Small trees (5-9 inches for softwoods and 5-11 inches for *red alder*) that have poor form and are not expected to ever produce merchantable material should be coded 99% rough cull, *or the remainder of the bole after ROTTEN/MISSING CULL deductions have been recorded.*

**Code only when the ROUGH CULL covers 3.0 feet or more of the tree.**

When collected:	CORE OPTIONAL: All live <i>conifer</i> or <i>red alder</i> tally trees $\geq$ 5.0 inches DBH/DRC
Field width:	2 digits
Tolerance:	+/- 10%
Values:	00 to 99

### 7.9.14 Cavity presence (PNW)

Record a code to indicate wildlife use. A cavity must be able to be used by wildlife (birds, small mammals, large mammals, etc.) to be coded. If more than one cavity is present, record the size of the largest one.

When collected:	All live and standing dead tally trees $\geq$ 5.0 inches (TREE STATUS = 1 or 2).
Field width:	1 digit
Tolerance:	No errors
Values:	0 No cavity or den present 1 Cavity or den present < 6.0 inches 2 Cavity or den present $\geq$ 6.0 inches

## 7.10 MISCELLANEOUS LIVE TREE MEASURED VARIABLES

### 7.10.1 Remnant Tree (PNW)

A remnant tree is a tree left by previous management activity or catastrophic event that is significantly older than the surrounding vegetation. Remnant trees do not form a canopy layer and are usually isolated individuals or small clumps. Record a code that indicates whether or not the tree is a remnant.

When collected:	All live tally trees $\geq$ 5.0 inches DBH/DRC
Field width:	1 digit
Tolerance:	No errors
Values:	0 No 1 Yes

### 7.10.2 Hardwood Clump (PNW)

A 1-digit code indicating if a hardwood tally tree that is not a western woodland species is part of a clump. The clump is assigned a clump number, and the number is recorded for each hardwood tallied that is part of the clump. If a hardwood is not part of a clump, "0" is recorded for the tree. Clumps with tallied trees are numbered in consecutive order on a subplot starting with "1".

**Example:** Bigleaf maple trees in three different maple clumps are tallied on a subplot. Trees tallied that are in the first clump are coded "1" for hardwood clump. Trees tallied in the second clump are coded "2" for hardwood clump, and trees tallied in the third clump are coded "3" for hardwood clump.

A clump is defined as 3 or more live hardwood stems originating from a common point in the same root system, usually from a tree now dead or gone. Hardwood clumps typically arise from old stumps that are left from cutting or from natural mortality. Each fork of a forked tree counts as one stem if the fork is below DBH and must be entered on a separate line. Do not tally seedling-sized suckers that have sprouted from the base of a live, unsuppressed hardwood stem that is  $\geq$  5.0 inches DBH.

Clump data are used in adjusting stocking estimates; trees growing in clumps contribute less stocking than those growing as individuals.

Hardwood Clump is downloaded/printed for hardwoods sampled live at the previous inventory. At the current inventory update the code if the tree is still a live tally tree.

When collected:	All live hardwood tally trees (excluding western woodland species) $\geq$ 1.0 inches DBH
Field width:	1 digit
Tolerance:	No errors
Values:	0 to 9

### 7.10.3 Form Class (PNW)

Record for all live hardwood trees (and conifers in R5 national forests) tallied that are  $\geq$  5.0 inches DBH/DRC. Form class is used in calculating net tree volume. When estimating form class, only consider the merchantable bole/portion of the tree from a 1-foot stump to a 4-inch top. Western woodland species do not require a Form Class. A log is considered straight if a line drawn through the centers of both ends of the log does not pass outside the curve of the log.

When collected:	On all hardwoods (and conifers in R5 national forests) $\geq$ 5.0 inches DBH except western woodland species.	
Field width:	1 digit	
Tolerance:	No errors	
Values:	Code	Form class
	1	First 8 feet above stump is straight.
	2	First 8 feet above stump is NOT straight or forked; but must have at least one straight 8 foot log elsewhere in the tree.
	3	No 8 foot logs anywhere in tree now or in the future due to form. Includes the sea serpents, octopi, giant tumbleweeds, pretzels, cauliflowers, and various free form trees.



Stoppers are defects that result in a length deduction of a log and include forks, culled missing sections, and rot.

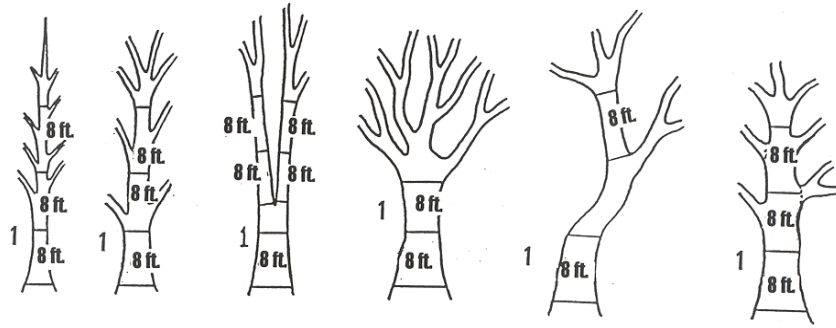

Various examples of form class 1.

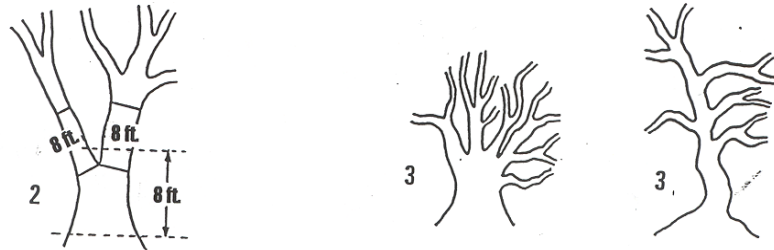

Example of a fork stopping an 8' section

Example of trees with no qualifying 8' section

Figure 7-25: Hardwood form class

### 7.10.4 TREE NOTES (CORE 5.27)

Record notes pertaining to an individual tree as called for to explain or describe another variable.

When collected:	All Trees
Field width:	Alphanumeric character field
Tolerance:	N/A
Values:	English language words, phrases and numbers

### 7.11 DEAD STANDING OR REMOVED

#### 7.11.1 CAUSE OF DEATH (CORE 5.21)

Remeasurement plots (SAMPLE KIND = 2) only: record a cause of death for all trees that have died or been cut since the previous survey. If cause of death cannot be reliably estimated, record unknown/not sure.

When collected:	All trees with PREVIOUS TREE STATUS = 1 and PRESENT TREE STATUS = 2 or 3 or PRESENT TREE STATUS = 2 and RECONCILE = 1, 2, or 3	
Field width:	2 digits	
Tolerance:	No errors	
Values:	Code	CAUSE OF DEATH
	10	Insect
	20	Disease
	30	Fire
	40	Animal
	50	Weather
	60	Vegetation (suppression, competition, vines/kudzu)
	70	Unknown/not sure/other- includes death from human activity not related to silvicultural or land clearing activity (accidental, random, etc.) Tree notes required.
	80	Silvicultural or land clearing activity (death caused by harvesting or other silvicultural activity, including girdling, chaining, etc., or to land clearing activity)

**7.11.2 MORTALITY YEAR (CORE OPTIONAL 5.20)**

Record the estimated year that remeasured trees died or were cut. For each remeasured tree that has died or been cut since the previous inventory, record the 4-digit year in which the tree died. Mortality year is also recorded for trees on land that has been converted to a nonforest land use, if it can be determined that a tree died before the land was converted.

When collected:	Plots where SAMPLE KIND = 2: all PREVIOUS TREE STATUS = 1 and PRESENT TREE STATUS = 2 or 3; or PRESENT TREE STATUS = 2 and RECONCILE = 1, 2, or 3
Field width:	4 digits
Tolerance:	+/- 1 year for remeasurement cycles of 5 years +/- 2 years for remeasurement cycles of > 5 years
Values:	1995 or higher

**7.11.3 Stump (PNW)**

Record a code to indicate if a standing dead tree record is a stump (its bole was severed by human mechanical activity). On most trees, evidence of cutting is distinct, on older trees use the presence of springboard notches, and the presence/condition of nearby stumps as guidelines. Cutting of the tree may have occurred while the tree was either live or dead. Note: To qualify as a standing dead tally record, the stump must meet minimum size criteria ( $\geq 5.0$  in diameter,  $\geq 4.5'$  tall) and lean  $< 45$  degrees.

When collected:	All trees with TREE STATUS = 2 and STANDING DEAD = 1 (yes)
Field width:	1 digit
Tolerance:	No errors
Values:	0 Not a stump 1 Is a stump 2 Is a stump with another tree growing out of it

**7.11.4 SNAG DECAY CLASS (CORE 5.23)**

Record for each standing dead tree, 5.0-inch in diameter and larger, indicating the trees stage of decay.

It is unlikely that decay class 5 will apply to a tally tree; by the time a dead tree has reached decay class 5, it will have toppled over or have become too short to qualify for tally.

When collected:	All standing dead tally trees $\geq 5.0$ in DBH/DRC						
Field width:	1 digit						
Tolerance:	+/- 1 class						
Values:	Characteristics of Douglas-fir snags by decay class <sup>1</sup>						
	Code	Limbs & Branches	Top	% Bark Remaining	Sapwood Presence	Sapwood Condition	Heartwood Condition
	1	All present	Pointed	100	Intact	Sound, incipient decay, hard, original color	Sound, hard, original color
	2	Few limbs, no fine branches	Broken	Variable	Sloughing	Advanced decay, fibrous, firm to soft, light brown	Sound at base, incipient decay in outer edge of upper bole, hard, light to red brown
	3	Limb stubs	Broken	Variable	Sloughing	Fibrous, soft, light to reddish brown	Incipient decay at base, advanced decay throughout upper bole, fibrous, hard to firm, reddish brown
	4	Few or no stubs	Broken	Variable	Sloughing	Cubical, soft, reddish to dark brown	Advanced decay at base, sloughing from upper bole, fibrous to cubical, soft, dark reddish brown

	5	None	Broken	Less than 20	Gone	Gone	Sloughing, cubical, soft, dark brown, OR fibrous, very soft, dark reddish brown, encased in hardened shell
--	---	------	--------	--------------	------	------	------------------------------------------------------------------------------------------------------------

1 Characteristics are for Douglas-fir. Snags for other species may vary somewhat; use this table as a guide.

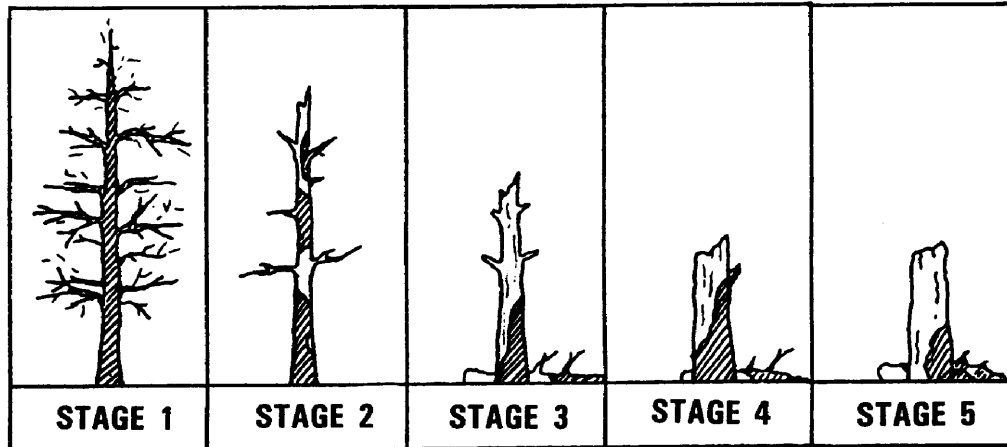

Figure 7-26: Douglas-fir decay class characteristics

### 7.11.5 Snag Reason for Disappearance (PNW)

Record a code to indicate the reason for disappearance of a tree previously tallied as dead.

When collected:	All trees with PREVIOUS TREE STATUS = 2 and PRESENT TREE STATUS = 0
Field width:	1 digit
Tolerance:	Correctly identify if tree is present or not
Values:	2 Fell over "naturally" (wind, decay, etc.) or no longer self-supported; still present. 3 Fell over "naturally;" removed from the site, or not discernible by crew. 4 Cut down or pushed over; still present. 5 Cut down or pushed over; removed from the site, or not discernible by crew. 6 DBH/DRC and/or height no longer meet minimum for tally (snag "shrank" to less than 5.0 inches DBH/DRC or less than 4.5 feet tall).

### 7.11.6 Utilization Class (PNW)

Record the code to identify cut trees that have been removed from the site.

Definitions of harvest use:

Harvested for industrial supply means the tree was harvested for industrial roundwood or chips. The tree was not used for firewood or for products manufactured and used by "do-it-yourselfers", often on the property of origin for improvements such as fences, buildings and bridges. The tree was marketed and transported from the property of origin to wood-using plant or export operation.

Harvested for firewood or local use means the tree was harvested for firewood, or for wood products manufactured and used locally by "do-it-yourselfers", often on the ownership of origin, for improvements such as fences, buildings and bridges. The tree was not marketed and transported to a wood-processing plant or export operation.

Harvested for incidental reasons means the tree was harvested (1) as an isolated removal in an otherwise undisturbed stand or (2) as part of a harvest activity in an adjacent stand condition that resulted in the removal of one or more tally trees.

When collected:	All TREE STATUS = 3
Field width:	1 digit
Tolerance:	No errors
Values:	0 - Not utilized - can still be found on the site 1 - Utilized – some portion of the tree cannot be found on site, assumed to have been removed 2 - Harvested for industrial supply 3 - Harvested for firewood or local use 4 - Harvested for incidental reasons

## 7.12 SPECIAL STUDIES

### **Special Study 2007a (Day Fire) Fire Effects and Recovery**

Fire Effects and Recovery data are collected on qualifying trees located on plots where Plot Attribute Special Study 2007a, in Section 3.3.18, =Y. See Field Instructions for the Annual Inventory of Washington, Oregon, and California 2007 SUPPLEMENT FOR: FIRE EFFECTS AND RECOVERY MEASUREMENTS.

### **Special Study 2002a Platform and Moss Abundance**

Platform and Moss Abundance data are collected on qualifying trees located on plots where Plot Attribute Special Study 2002a, in Section 3.3.17, =Y.

Selection of Viewing Position: Select a position, preferably on the uphill side of the tree that provides the clearest view of as much of the tree bole and crown area as possible to estimate platform and moss abundance. As an optional field aide to the inspection process, measure the azimuth and slope distance from the position at which measurements are made to the base of the tree being evaluated. Record the azimuth and slope distance, if collected, in the Tree Comments section for the tree.

The Azimuth/Distance (an optional field) for the tree viewing position selected is used to assist in the inspection process only. When recording viewing position, complete azimuth to the nearest degree and slope distance to the nearest foot. For example, 061/051 is equivalent to 61 degree azimuth. and 51 feet distance. Record in the Tree Comments field. If viewing position azimuth/distance is not recorded, the check plotter's determination of best viewing position will be utilized.

#### **7.12.1 Platform Abundance (PNW)**

Count the number of limbs that contain one or more platforms. Each limb with one or more platforms is counted only once, regardless of the number of platform structures on the limb. Limb counts from 1 to 9 shall be tallied as individuals (i.e. 1, 2, 3, etc.). A tree with 10 or greater limbs with one or more platforms shall be tallied as 10. Counts will be summarized into the groups: 0, 1-5, 6-9, >10.

A platform is a section or area of a live limb that is  $\geq 6.0$  inches diameter, located  $\geq 33.0$  feet above the ground up to the top of a live crown of a tree, and not positioned at more than a 45 degree angle from horizontal. This includes limb areas where the diameter has been enlarged by effects of insects, mistletoe, disease, physical injury, or the accumulation of moss.

When collected:	All live tally trees $\geq 20.0$ inches DBH on plots where Plot Attributes Special Study 2002a=Y
Field width:	2 digits
Tolerance:	No errors
Values:	0 to 10

#### **7.12.2 Moss Abundance (PNW)**

Estimate the percentage of the surface area on the horizontal surface or top of each limb covered by moss ONLY; do not include other epiphytes, such as lichens. From the same point used to estimate Platform Abundance (7.11.1), estimate moss coverage on the horizontal surface of all visible limbs in the lower two thirds of the live tree crown. Estimate the percent cover of moss on the top of each limb, then average across ALL limbs within the lower two thirds of the crown. Record the result for each tallied tree to the nearest percent from 0 to 99.

Moss is any of various green, nonvascular plants of the class Musci of the division Bryophyta that usually form a mat-like surface on a limb.

When collected:	All live tally trees $\geq$ 20.0 inches DBH on plots where Plot Attributes Special Study 2002a=Y and Platform Abundance > 0
Field width:	2 digits
Tolerance:	+/-20%
Values:	0 to 99

### 7.13 MORTALITY AND GROWTH ASSESSMENT FROM PREVIOUS OCCASION (PNW)

Harvest and mortality information are used in most reporting and research done by FIA, and are often of interest to others outside of the program. Harvest and mortality information is collected by revisiting the periodic plot design on plots that have been retained in the annual inventory, and accounting for the status of each tree (Except: 1) on Region 6 lands, 2) reserved lands outside of national forests, and 3) co-located P2/P3 plots when visited as P3 only plots). Note: Due to lengthening of the P3 measurement cycle from 5 to 10 years, all P3 plots in 2006 will be co-visited with P2 Annual Inventory plots. Specifically, these procedures are to be completed when the center of subplot 1 is in:

- California (All plots with field data pre-existing the Annual inventory. Except: DO NOT measure mortality and growth from the Periodic to the Annual inventory whenever the assessment has already been completed (e.g. Annual inventory remeasurement plots on R5 lands that were installed initially in 2001, 2002, or 2003 (Panels 8, 9, and 10)). NOTE: Most previously established R5 Periodic FIA plots have 5 subplots; only a few have 10 subplots. For these, mortality is assessed at all 10 subplots.),
- Oregon (off-National Forest plots. Mortality Assessment will NOT be done on R6 lands.),
- Washington (off-National Forest plots that were part of the 2000 Western Washington or 2001 Eastern Washington periodic inventory remeasurement) Only subplots that were remeasured in 2000 and 2001 will be assessed for mortality in Washington.

The ownership at subplot 1 at the previous inventory is used to determine if Mortality Assessment is completed. The field crew will visit all subplots established at the previous inventory to account for live trees that were measured and were  $\geq$  5.0 inches in diameter. Mortality includes snags, fallen, harvested, and culturally killed trees. In addition, on periodic subplots 1 and 2, crews will remeasure the DBH of live trees that were measured in the previous inventory.

Trees that were measured in the last inventory and are alive, but suffering from Sudden Oak Death symptoms, will also be tallied by this system.

Mortality data for all subplots are entered on a separate screen in the PDR. On subplots 1 and 2, some trees are tallied for both tree and mortality data. These include trees that are tallied as part of the normal collection of tree data on the new fixed radius plots. The measurement of DBH will need to be entered in both screens for these trees. The PDR will be able to transfer the DBH measurement made for tally trees from the tree tally screen to the mortality screen when appropriate (See example below).

The following attributes are to be recorded:

#### 7.13.1 Mortality Line # (PNW)

The data recorder will fill out this item.

#### 7.13.2 Mortality Tree Tag # (PNW)

Record the tree number that was put on the tree by the previous crew.

#### 7.13.3 Mortality Tree History (PNW)

Record a tree history for each tree

When collected:	All trees previously measured on periodic plots	
Field width:	2 digits	
Tolerance:	No errors	
Values:	Code	Tree History
	1	Live tree
	3	Culturally killed by humans. This does not include trees harvested.
	5	Mortality. Trees that die naturally or by a non-human cause.
	8	Harvested for use by humans.
	10	Tree on land that is access denied or hazardous

**7.13.4 Cause of Death / Damaging Agent (PNW)**

Record a cause of death (COD) for all dead trees (Tree History = 3, 5, 8) tallied. Record a code of "31" for live trees affected by Sudden Oak Death or all dead trees that were killed by Sudden Oak Death.

When collected:	All Tree History = 1 or 5	
Field width:	2 digits	
Tolerance:	No errors	
Values:	Code	CAUSE OF DEATH
	00	Not dead/damaged
	10	Insect
	20	Disease
	30	Fire
	31	Sudden Oak Death (Requires a sample. See Appendix A2.7)
	40	Animal
	50	Weather
	60	Vegetation (suppression, competition, vines/kudzu)
	70	Unknown/not sure/other- includes death from human activity not related to silvicultural or land clearing activity (accidental, random, etc.) Tree notes required.
80	Silvicultural or land clearing activity (death caused by harvesting or other silvicultural activity, including girdling, chaining, etc.)	

**7.13.5 Remeasured Diameter (PNW)**

This is a remeasurement of the DBH of trees tallied at the previous survey on subplots 1 and 2. The DBH downloaded from the previous inventory is shown in the mortality screen. Remeasure the diameter at the location of the previous crew's nail. If the diameter at the current inventory (current tally trees) is measured at a different location than the previous inventory, the diameter will be measured both at the previous location for the mortality assessment and at the new location for the current tree tally. If the diameter measurement location for the current inventory is unchanged, then only one DBH measurement will be made and this value can be transferred from the tally screen to the mortality screen. If the previous point of diameter measurement can not be found, set a new nail at the correct location (Section 7.6) and record Remeasured Diameter Check of 2 below.

When collected:	All live trees $\geq$ 5.0 in DBH/DRC assessed for mortality on periodic subplots 1 & 2
Field width:	4 digits (xxx.y)
Tolerance:	+/- 0.1 inch per 20.0 in increment of measured diameter. For example: a tree with a diameter of 41.0 in would have a tolerance of +/- 0.3 inch.
Values:	005.0 to 999.9

**7.13.6 Remeasured Diameter Check (PNW)**

Record this code to identify any irregularities in diameter measurement positions (i.e. abnormal swellings, diseases, damage, etc.) that may affect use of this tree in diameter growth/change analyses. If diameter is estimated because of moss/vine/obstruction etc., record an estimate of the diameter without the obstruction. If the previous point of diameter measurement can not be found on a live tree (i.e. nail fell out) record code 2.

When collected:	All live trees $\geq$ 5.0 in DBH/DRC assessed for mortality on periodic subplots 1 & 2	
Field width:	1 digit	
Tolerance:	No errors	
Values:	Code	Diameter check
	0	Diameter measured accurately
	1	Diameter estimated for reason other than moss or vines.
	2	Diameter measured at different location than previous measurement
	5	Diameter estimated because of moss.
	6	Diameter estimated because of vines.
	7	Diameter estimated (double nail diameter)

Annual Inventory 2007, Chapter 7: Live and Standing Dead Tree Tally

Examples:

The following examples show measurements under different scenarios for a tree that is both a tally tree in the current inventory and is also being assessed for mortality and growth. At the previous inventory the DBH was recorded as 12.3 inches.

SCENARIO	TREE SCREEN		MORTALITY SCREEN		
	Current Tally Diameter	Diameter Check	Previous Diameter	Remeasured Diameter	Remeasured Diameter Check
Tally tree diameter at the current inventory is measured at the same location as the previous inventory.	14.2	0	12.3	14.2	0
Tally tree diameter at the current inventory is measured at a different location than at the previous inventory.	14.2	2	12.3	14.4	0
Previous point of diameter measurement can not be found.	14.2	2	12.3	14.2	2





## 8 VEGETATION PROFILE

### Table of Contents

<b>8</b>	<b>VEGETATION PROFILE .....</b>	<b>157</b>
<b>8.1</b>	<b>VEGETATION PLOT DESIGN .....</b>	<b>159</b>
<b>8.2</b>	<b>SPECIES RECORDS .....</b>	<b>159</b>
8.2.1	Species Growth Habit (PNW) .....	160
8.2.2	Species (PNW).....	160
8.2.3	Species Height (PNW).....	161
8.2.4	Species Cover (PNW).....	162
8.2.5	Stage of Shrub Development (PNW).....	165
<b>8.3</b>	<b>LIFEFORM AND TOTAL VEGETATION RECORDS .....</b>	<b>165</b>
8.3.1	Percent Total Tree Seedling Cover (PNW).....	165
8.3.2	Percent Total Shrub Cover (PNW).....	165
8.3.3	Percent Total Forb Cover (PNW) .....	165
8.3.4	Percent Total Graminoid Cover (PNW) .....	165
8.3.5	Percent Bare Soil (PNW).....	165
8.3.6	Percent Total Vegetation Cover (PNW) .....	166
<b>8.4</b>	<b>COLLECTION AND IDENTIFICATION OF UNKNOWN PLANTS .....</b>	<b>166</b>
<b>8.5</b>	<b>INDICATOR AND WEED LISTS .....</b>	<b>166</b>
	R5 Weed List (PNW).....	166
	R6 Indicator List (PNW).....	166
<b>8.6</b>	<b>Literature Cited .....</b>	<b>166</b>



## Chapter 8: VEGETATION PROFILE

Information on the abundance, structure, and species composition of understory plant communities has many uses. The data are used to evaluate wildlife habitat suitability, forage availability, grazing potential, species richness and abundance, fire hazard, abundance of non-timber forest products, and potential site productivity. The data also support identification of plant community types (“associations”), which allows users to predict plot characteristics not actually measured by FIA. Accurately representing the species present on a site and their change in abundance in response to forest development, disturbance, or management is therefore important to a wide variety of users.

See Appendix 1 for special rules about nonforest and chaparral plots/condition classes on R5 and R6 NFS lands.

### 8.1 VEGETATION PLOT DESIGN

With the installation of the national FIA plot design on all lands, vegetation will be measured on each 24' radius subplot on which accessible forest-land condition classes make up 50% or more of the subplot. Vegetation on National Forest lands will be measured when accessible land conditions (i.e. forest and non-forest) make up 50% or more of the subplot. (Condition classes with a Condition class status of Non-census Water, Census Water, Denied Access, Hazardous, and Not-In-The-Sample are considered not accessible). It is important to measure the vegetation before plants are trampled in the course of installing the rest of the plot. Vegetation plots were collected in previous inventories at different locations, around the center of the old 5-point plots. On plots that are installed on previously-visited field grid points, species records on plot cards from the previous inventory may be useful for species identification.

Vegetation will be assessed over the entire subplot area, regardless of the presence of two or more condition classes or nonforest inclusions. If vegetation on non-accessible condition classes cannot be examined closely (e.g. hazardous or denied access conditions), estimate vegetation on those areas from the best vantage points available. All vegetation and plant parts that are or were alive during the current growing season is included in cover estimates (e.g. brown bracken fern in late summer is counted, live buds on vine maple in late fall are used to estimate crown).

### 8.2 SPECIES RECORDS

Individual records are entered for vascular plant species and species groups on each subplot. Mosses and lichens are not measured. Each record is identified by growth habit, species name, height, and cover. In addition, cover of some species is aggregated into four plant lifeform groups. The three most abundant species of each tree, shrub and forb lifeform group, and any additional species with  $\geq 3\%$  cover, are recorded individually. On R5 or R6 National Forest only, any additional species on the Indicator list or Weed list are also recorded by species regardless of abundance. Some species only require identification to the genus level and are listed on the Genus list. Any additional species within a lifeform that collectively have  $\geq 3\%$  cover, but individually have  $< 3\%$  cover, are recorded and overall cover and height estimated. The appropriate “lumped species code” is used for these species.

For tree species, only seedlings are included in the vegetation cover estimates (i.e.  $< 1.0$  in DBH/DRC and  $\geq 0.5$  ft in length (conifers) or  $\geq 1.0$  ft in length (hardwoods)). For graminoids, plants can be lumped into annual or perennial groups if they don't occur on the Indicator list or Weed list and their species, or genus, is not known.

Species are classified in two ways: by “growth habit” and by “lifeform”. Growth habit identifies the form and growth characteristics of species. A single species may occur in several different growth habits, depending on conditions. For example, the **growth habit** for dwarf Oregon grape (*Mahonia nervosa*, MANE2) can be classified as a shrub or a sub-shrub (PLANTS 2000). **Lifeform**, on the other hand, is a (somewhat arbitrary) assignment of each species into a single group. Continuing with the above example, MANE2 is always a “shrubs” – meaning the code is entered in the data recorder under the shrub profile in the Veg Menu. The code will be invalid if entered into any other profile. The plant species books produced by FIA identify which group each species belongs to.

Tree species are listed in Appendix 9, and for these species, cover is estimated only on those that are less than 1 inches DBH/DRC. All other species (non-trees) are recorded using cover estimates, regardless of their diameter.

**8.2.1 Species Growth Habit (PNW)**

Each individual species record must have a growth habit code recorded. If a species has more than one growth habit on the subplot, only record the predominate growth habit on the subplot for the species. Do not split species records on the sole basis of differences in growth habit. Species grouped into lifeforms do not get a growth habit code. Valid growth habit codes for the FIA inventory are derived from the PLANTS database (USDA, NRCS. 2000. The PLANTS database [<http://plants.usda.gov>]. National Plant Data Center, Baton Rouge, LA 70874-4490) and are listed below.

When collected:	All subplots where accessible forest-land condition classes $\geq$ 50% of the subplot			
Field width:	2 characters			
Tolerance:	No errors			
Values:	Growth Habit Code	Description	FIA plant lifeform group	PLANTS Definition (added text in italics)
	FB	Forb/herb	Forb	Vascular plant without significant woody tissue above or at the ground. Forbs and herbs may be annual, biennial, or perennial but always lack significant thickening by secondary woody growth and have perennating buds borne at or below the ground surface. Federal Geographic Data Committee (FGDC) definition includes graminoids, forbs, and ferns; in PLANTS, graminoids are separated.
	GR	Graminoid	Graminoid	Grass or grass-like plant, including grasses (Poaceae), sedges (Cyperaceae), rushes (Juncaceae), arrow-grasses (Juncaginaceae), and quillworts (Isoetes). An herb in the FGDC classification.
	SH	Shrub	Shrub	Perennial, multi-stemmed woody plant that is usually less than 4 to 5 meters or 13 to 16 feet in height. Shrubs typically have several stems arising from or near the ground, but may be taller than 5 meters or single-stemmed under certain environmental conditions. Includes succulents (e.g. cacti).
	SS	Subshrub	Shrub or Forb	Low-growing shrub usually under 0.5 m or 1.5 feet tall (never exceeding 1 meter or 3 feet tall) at maturity. A dwarf-shrub in the FGDC classification. Includes succulents (e.g. cacti).
	VI	Vine	Shrub	Twining/climbing plant with relatively long stems, can be woody or herbaceous. GDC classification considers woody vines to be shrubs and herbaceous vines to be herbs.
	TR	Tree	Tree or Shrub	Perennial, woody plant with a single stem (trunk), normally greater than 4 to 5 meters or 13 to 16 feet in height; under certain environmental conditions, some tree species may develop a multi-stemmed or short growth form (less than 4 meters or 13 feet in height).
	UN	Unknown		Growth form is unknown.

**8.2.2 Species (PNW)**

Each species record must have a species code recorded. Valid species codes are listed in the FIA plant guide, which is derived from the PLANTS database (USDA, NRCS. 2000. The PLANTS database [<http://plants.usda.gov/plants>]. National Plant Data Center, Baton Rouge, LA 70874-4490). If you cannot identify a species while in the field, collect a specimen for later identification (see Section 8.4). If the species of the plant cannot be identified, record the code for its genus if possible. If not, record one of the following generic codes:

Unknown Species Code	Life-form	Lumped Species Code
---	Trees	TREES
SHRUB1	Shrubs	SHRUBS
FORB1	Forbs (and ferns)	FORBS
AAGG1	Annual grasses	AAGGS
PPGG1	Perennial grasses	PAGGS

Annual Inventory 2007, Chapter 8: Vegetation Profile

If another species of the same life-form can not be identified, it is labeled with the life-form followed by the number 2 (SHRUB2, FORB2, etc.). Up to five unknowns of each life-form may be recorded. Note: unknown tree species is not an option (but a genus record using the correct PLANTS code is OK in rare instances).

Genus list: Some plants, when not present on the Indicator or Weed lists, require identification only to the genus level.

Group	Genus	PLANT Code
Graminoids	Carex	CAREX
	Juncus	JUNCU
Forbs	Allium	ALLIU
	Aster	ASTER
	Astragalus	ASTRA
	Castilleja	CASTI2
	Cirsium	CIRSI
	Erigeron	ERIGE2
	Lupinus	LUPIN
	Trifolium	TRIFO

A grouped record by plant life-form is entered when a group of tree, shrub, forb, annual grass, or perennial grass species, covers 3 or more percent on a vegetation plot but, as individual species, do not and are not on the National Forest Indicator list or the R5 Weed list. Example: 6 species of forbs are present: one species covers 10 percent, and the other 5 species each cover 1 percent. Four records are entered: one record each for the three most abundant species (the one at 10 percent plus the 2 at one percent that are the next most abundant) and a fourth generic FORBS record for the other 3 species which collectively cover 3 percent.

For NFS lands record Species (8.2.2), Species Height (8.2.3) and Species Cover (8.2.4) for any species encountered that are on the R5 Weed List in California or the R6 Indicator List in Washington and Oregon. See Section 8.5 and Appendix A1.6 B & C.

When collected:	All subplots where accessible forest-land condition classes $\geq$ 50% of the subplot
Field width:	
Tolerance:	No errors
Values:	See tables and PLANTS citation above

### 8.2.3 Species Height (PNW)

Record a 2-digit height for each line entry. The entry indicates the average total height above the ground at which a species occurs. If a species occurs at substantially different heights in a subplot (requirements listed below, plants can be grouped into two different height groups as long as the cover estimates of each are  $\geq$  3%. A species can be in more than one height by repeating the species code on an additional line. Heights are recorded to the nearest foot.

Guidelines for recognizing separate heights for a species:

- Graminoid:** Canopy heights must differ by at least 2 feet
- Forb:** Canopy layers must differ by at least 2 feet
- Shrub:** Canopy layers must differ by at least 4 feet
- Tree:** Seedling layers must differ by at least 4 feet

When collected:	All subplots where accessible forest-land condition classes $\geq$ 50% of the subplot
Field width:	2-digits
Tolerance:	Grass and forbs: $\pm$ 1 feet Shrubs and trees: $\pm$ 3 feet
Values:	1 to 99 (recorded to the nearest foot)

**8.2.4 Species Cover (PNW)**

Estimate the cover of each species record in its respective height group. Cover is estimated to the nearest 1% for each species, as the proportion of the fixed-radius plot regardless of condition class boundaries that would be obscured by all plants of the species if viewed from directly above. For each plant, cover is based on a vertically projected polygon described by the outline of the live foliage of each plant (or foliage that was live during the current growing season for senescing plants), and ignoring any normal spaces occurring between the leaves of a plant (Figure 8-1) (Daubenmire 1959). This best reflects the plant's above- and below-ground zone of dominance.

Base the percent cover estimate on the current year's growth present at the time of the plot visit. Include both living and dead material from the current year. If herbs or shrubs have already dried out, dropped leaves, or senesced, estimate the cover of foliage that was live **during the current growing season** (e.g. on plots done early in the year, do not estimate based on the previous growing season's growth). Do not include dead branches of shrubs and trees in the cover polygons. Do not adjust the percent for the time of year during which the visit was made (i.e. if the plants are immature and small because the plot is being completed early in the growing season).

Overlap of plants of the same species is ignored. Visually group plants in a species together into a percent cover. There will often be overlap of plants of different species. Therefore, your total cover for a subplot may exceed 100%. Species that are on the Indicator list or the Weed list and that cover less than 1% are recorded as 1%. (0% cover is only used for remeasurement, to indicate that a species is no longer present.)

Several approaches can be used to improve the accuracy and repeatability of plant cover estimates. Cover can be "added up" across a plot, keeping in mind that 3% cover on a 24' radius plot = 54 ft<sup>2</sup>, or a square that is 7.4 feet on a side (Table 8-1). Plants can be visually aggregated into multiple 1% cover squares to arrive at a total cover. For species of moderate cover, it may be easiest to estimate cover of each quadrant of the subplot separately and then add them together, or to imagine crowding all the plants into a portion of a plot and estimate the proportion of the plot that would be covered. The cover scatterplots in Figure 8-2 may also be useful in developing estimates.

Table 8-1: Area represented by different cover estimates, and length of a square with that area.

Subplot radius = 24 feet		
Subplot area = 1,809 ft <sup>2</sup>		
Cover	Area (ft <sup>2</sup> )	Length on a side (ft)
1%	18	4.3
3%	54	7.4
5%	90	9.5
10%	181	13.4
15%	271	16.5
20%	362	19.0
25%	452	21.3

When collected:	Recorded for all species
Field width:	2-digits
Tolerance:	Cover estimates should be within one class of actual cover, based on the cover classes: 1-5%, 6-10%, 11-20%, 21-40%, 41-60%, 61-80%, and 81-100%
Values:	0 to 100 (estimated to the nearest 1%)

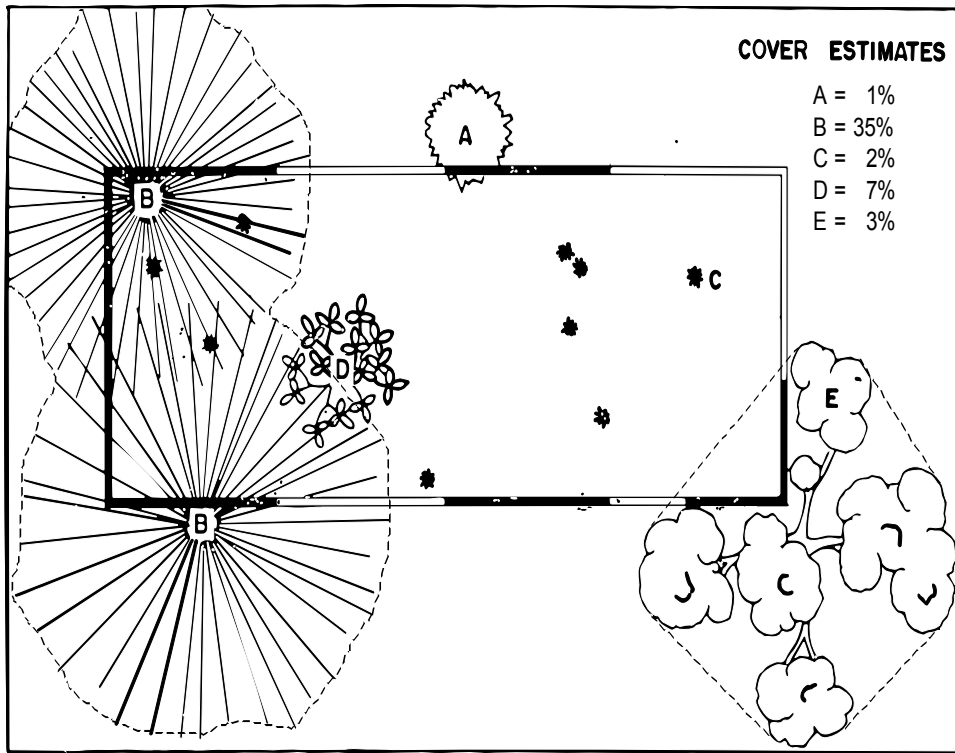

Figure 8-1: Illustration of cover method based on polygon outline of plants using a rectangular "Daubenmire plot". Notice that plant E has no foliage over the plot but its outline does cover a portion of the plot. Polygon outlines and cover estimates added to drawing scanned from Daubenmire (1959, Figure 8-2).

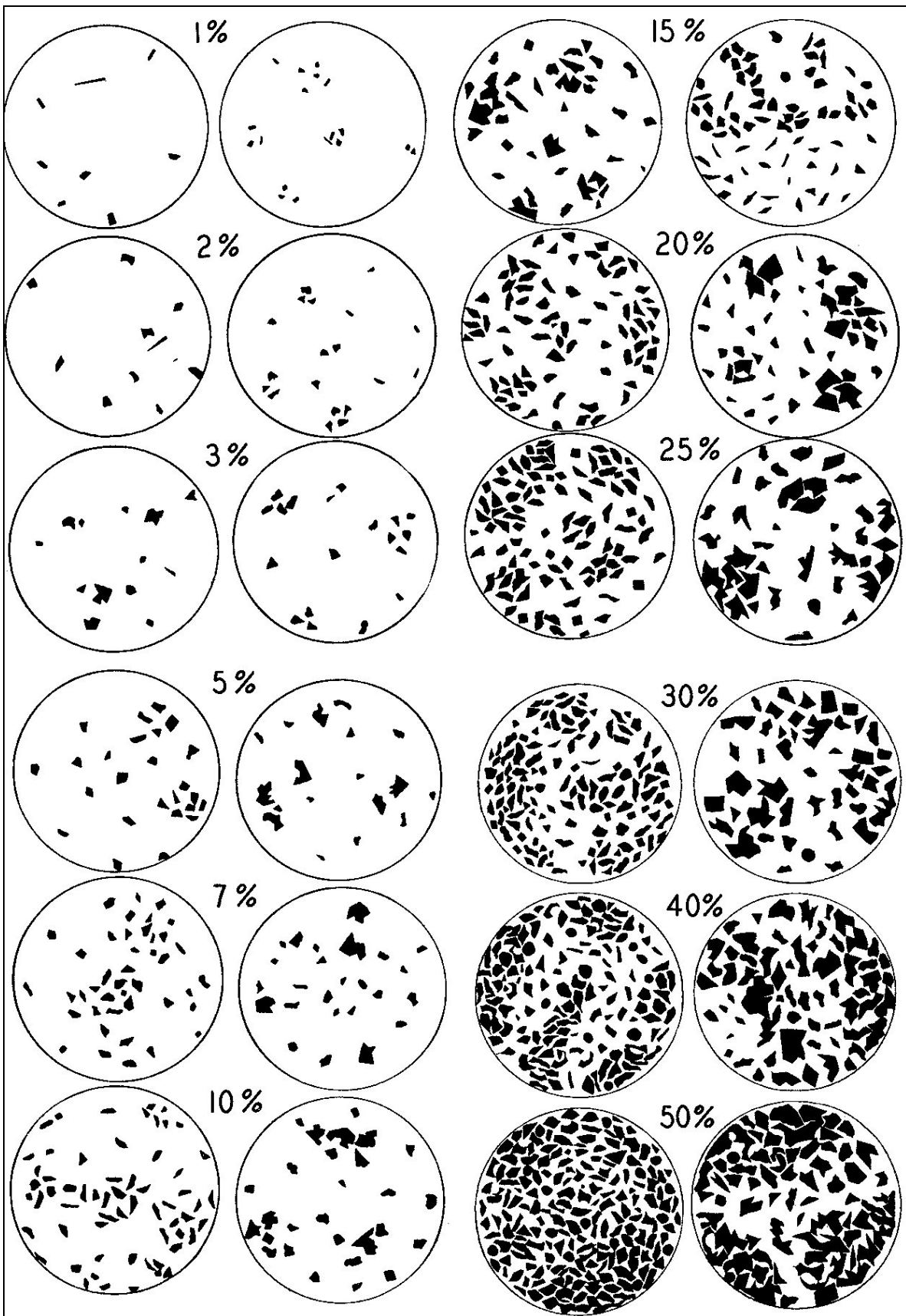

Figure 8-2: Reference scatterplots for cover estimation (from Terry and Chilingar 1955).



**8.2.5 Stage of Shrub Development (PNW)**

For each shrub lifeform species recorded on one or more vegetation plots, enter the code below that best describes the shrub's stage of development across all vegetation plots. Do not include standing dead shrubs—only those that have some living tissue. Of all the live and dead stems and branches attached to the living shrubs, estimate the proportion that are dead, and place it in one of the classes below.

When collected:	For each shrub lifeform species recorded on one or more vegetation plots	
Field width:	1 digit	
Tolerance:	No errors	
Values:	Code	Shrub Stage of Development
	1	Immature, no dead material (stems and branches) associated with the shrub record.
	2	Mature, 1-24 percent dead material associated with the shrub record.
	3	Over-mature, 25-49 percent dead material associated with shrub record.
	4	Decadent, 50 percent or more dead material associated with shrub record.

**8.3 LIFEFORM AND TOTAL VEGETATION RECORDS**

Individual records are entered for each lifeform and for all vascular plants, and cover estimated for each. Species are defined by lifeform, although some plants can be measured as trees or shrubs depending on their form (see Section 8.2). Record the percent of the vegetation for each lifeform being measured. Enter a record for each of the following lifeforms/cover categories even if there are no plants in that lifeform present (8.3.1 – 8.3.6).

Estimate the cover for each lifeform and for all vegetation on the subplot. Cover is estimated to the nearest 1% for each group, as the proportion of the fixed-radius plot, regardless of condition class boundaries, that would be obscured by all plants in the lifeform if viewed from directly above. Total percent cover for a plant lifeform group cannot exceed 100 percent. Total percent cover for a plant lifeform group cannot exceed the sum of percent cover recorded for all individual species records of that plant group (item 8.2.4). However, total percent cover for a plant group can be, and usually is, less than the sum of cover for all individual species within the group. This happens because of overlap between layers and species. If cover is greater than 0 but less than 1 percent, enter "01". If no plants of the lifeform are present, enter "0".

When collected:	For all vegetation measured
Field width:	2 digits
Tolerance:	Cover estimates should be within one class of actual cover, based on the cover classes: 1-5%, 6-10%, 11-20%, 21-40%, 41-60%, 61-80%, and 81-100%
Values:	0-100 %

**8.3.1 Percent Total Tree Seedling Cover (PNW)****8.3.2 Percent Total Shrub Cover (PNW)**

**Note:** for Special Study 2007a (Day Fire) also collect the percent of shrubs that have sprouted since the fire (See Supplemental for Fire Effects and Recovery - 4.1.1). Only include species which actually sprout.

**8.3.3 Percent Total Forb Cover (PNW)****8.3.4 Percent Total Graminoid Cover (PNW)****8.3.5 Percent Bare Soil (PNW)**

Record the percent of the evaluated area that is covered by bare soil. Bare soil is mineral material that, viewed from above, is not over-topped by grass, forbs, shrubs, or seedlings. It is also not covered by duff, litter, cowpies, woody debris, moss or other material. Sand, stones and bedrock are not considered bare soil. This data is used to help make estimates of erosion, range condition and disturbance. It therefore includes only areas of bare soil having no cover at all, or only the cover of crowns on trees  $\geq$  5.0 inches DBH

When collected:	
Field width:	2 digits
Tolerance:	+/- 20%
Values:	0-99 Record percent bare soil to the nearest 5 % using a 2-digit code. If the vegetation plot is entirely bare soil, record as "99". Record "01" for bare soil > 0 but < 3 %.

### 8.3.6 Percent Total Vegetation Cover (PNW)

Record the percent of the evaluated area that is covered by any of the components measured on the vegetation profile plot (tree seedlings, shrubs, forbs and grass). Estimate percent cover as the portion of the fixed-radius vegetation plot being evaluated, regardless of condition class boundaries that would be obscured by seedling/shrub/forb/grass species if viewed from directly above. Ignore crown overlap. Record total vegetation cover as "99". Percent total vegetation cover and percent bare soil combined cannot exceed 100 percent, and will likely be less due to the way each is defined and the inclusion of different elements.

When collected:	
Field width:	2 digits
Tolerance:	+/- 20%
Values:	0-99

## 8.4 COLLECTION AND IDENTIFICATION OF UNKNOWN PLANTS

To improve the quality of vegetation profile data, a formal procedure is followed to identify more of the unknown plant species that are tallied.

While on the plot, the crew should not spend an inordinate amount of time trying to identify an unknown plant. If the plant can be keyed out quickly using a plant guide, identification should be attempted. If the crew is confident the plot can be completed in one day, they can spend more time trying to identify unknown plants while on the plot. In most cases, though, it will be more effective to collect unknown plants for later identification. If the plant cannot be identified and qualifies for tally as a generic life-form record (shrub, forb, fern, grass), enter the record.

Gather as much of the complete plant as is feasible. Include roots, flowers, and seed-heads if possible. Write a brief description of the site from which the plant was collected, the plant community of which it was a member, and any other information, which may assist in identification.

Once back at the motel, try to identify the collected specimens the same day that the plot was visited. Use whatever plant guides are available. Other field team members who might be familiar with the species and/or are good at plant identification may be consulted. Twenty minutes is the recommended maximum amount of time that should be spent on one plant. If the specimen cannot be identified, contact the crew coordinator. If the same plant is collected several times and identification attempts are unsuccessful, the crew leader or crew coordinator may contact a botanist for identification.

If no attempt can be made to key out a plant the same day it is collected, the specimen should be placed in a plant press (one is in each vehicle). Do not leave the specimen in the plastic bag; specimens left bagged may mildew and mold.

If a plant is successfully identified, the vegetation profile data for that plot should be updated before transferring the plot data to the laptop computer.

## 8.5 INDICATOR AND WEED LISTS

### R5 Weed List (PNW)

Standard Phase 2: field crews should look for the plants identified specifically as forest "indicators" for only 10 minutes, coding all that they can in that amount of time. The "nonforest", "weed", and "sensitive" plant species can also be recorded by during standard Phase 2 inventory if crews recognize them, but are intended for inventory by specially-trained National Forest botanists. See Appendix A1.6B.

### R6 Indicator List (PNW)

The indicator lists only apply on R6 National Forest lands, and each list applies to a specific group of national forests. See Appendix A1.6C. **Note:** standard P2 crews **are** expected to record the "forest indicator" species from these lists; the "weed," "nonforest," and "sensitive" indicator plants may be recorded if they are able, but it is not required. Crews with specialized training and identification aids are used to inventory those species.

## 8.6 Literature Cited

Daubenmire, R. 1959. A canopy-coverage method of vegetational analysis. Northwest Science 33(1): 43-64.

## 9 SITE INDEX

### Table of Contents

<b>9</b>	<b>SITE INDEX</b> .....	<b>167</b>
<b>9.1</b>	<b>SITE TREES</b> .....	<b>169</b>
	GENERAL INSTRUCTIONS.....	169
	PREVIOUSLY VISITED PLOTS.....	170
	NEW PLOTS .....	170
<b>9.2</b>	<b>SELECTING SITE TREE SPECIES</b> .....	<b>171</b>
	HIERARCHY OF METHOD SELECTION: "HOW TO DECIDE METHOD" .....	171
	KING'S SELECTION METHOD .....	171
	PRIMARY SELECTION METHOD, CONIFERS .....	172
	PRIMARY SELECTION METHOD, HARDWOODS.....	173
	MIXED CONIFER SELECTION METHOD .....	173
	SITE DESCRIPTIONS .....	173
<b>9.3</b>	<b>SITE TREE DATA VARIABLES</b> .....	<b>174</b>
9.3.1	Site Tree Number (PNW) .....	174
9.3.2	SUBPLOT NUMBER (CORE OPTIONAL 7.2.7).....	174
9.3.3	CONDITION CLASS LIST (CORE 7.2.1).....	174
9.3.4	Tree Tag Number (PNW) .....	174
9.3.5	AZIMUTH (CORE OPTIONAL 7.2.8).....	175
9.3.6	HORIZONTAL DISTANCE (CORE OPTIONAL 7.2.9).....	175
9.3.7	SPECIES (CORE 7.2.2) .....	175
9.3.8	DIAMETER (CORE 7.2.3).....	175
9.3.9	SITE TREE LENGTH (CORE 7.2.4).....	175
9.3.10	TREE AGE AT DIAMETER (CORE 7.2.5).....	176
9.3.11	Site Tree Selection Method (PNW).....	176
9.3.12	Site Index (PNW).....	176
9.3.13	SITE TREE NOTES (CORE 7.2.6) .....	176
<b>9.4</b>	<b>SITE TREES: POST FIELD REVIEW</b> .....	<b>176</b>
<b>9.5</b>	<b>STOCKABILITY IN OREGON AND CALIFORNIA</b> .....	<b>176</b>
9.5.1	Stockability Indicators for Oregon (PNW) .....	176
9.5.2	Oregon Stockability Discount Factor (PNW) .....	177
9.5.3	Stockability Indicators for California (PNW).....	178



## Chapter 9: SITE INDEX

Site index, a simple numerical value based upon tree height at a specified age, is commonly used to evaluate the potential productivity of tree growth on a forest site. On sites where soil moisture is adequate and soils are not toxic to tree growth, site index correlates well with the maximum potential stand volume and number of trees a site can attain at stand maturity. However, on sites with droughty or toxic soils, or otherwise unsuitable conditions, these maximums are reduced to levels lower than would otherwise be expected. On these impaired sites, site index alone does not correlate well with potential productivity.

On these sites, an estimate of stand density index (SDI) is required to assess productivity adequately; stand density index is the maximum number of trees per acre a site will support when stand DBH is 10 inches (Reineke's stand density index) relative to the maximum expected number if the site were not impaired. An estimate of SDI for an impaired site can be compared with the stand density index expected on a similar, but unimpaired site to determine by how much to reduce estimates of potential productivity; the proportion of these two stand density indices is used to discount maximum potential stand density and tree growth (mean annual increment at culmination in a normal, fully stocked stand (MAI)).

SDI on a given site correlates well with the presence of specific combinations of key plant species, plant communities, and abiotic attributes. This information is collected as a part of the plant association data recorded in the condition class attributes chapter (Section 4.6.36). The plant association will allow us to estimate the maximum potential SDI possible on a condition class. This estimate is used to determine to what extent, if any, the potential productivity (MAI) estimated using the condition class's site index should be discounted.

### 9.1 SITE TREES

#### GENERAL INSTRUCTIONS

Select at least one site tree for each accessible forest land condition class (see below) where no previous site tree data exist. The absence of site tree data may occur because:

- This is the first visit to the site
- On the previous visit no suitable site tree could be found for the condition
- Since the last visit there has been a change in condition class that renders the previous data incompatible with the current conditions

If a site tree is needed; select tree from a species common to the condition class being sampled, based on the criteria listed below. Select trees off the subplot where possible. Use only trees that have remained in a dominant or co-dominant crown position throughout their entire life span. If possible, trees should be 5.0 inches in diameter, or larger, and at least 20 years old. Trees that are visibly damaged, trees with ring patterns that exhibit signs of suppression, and trees with rotten cores should be rejected. If there are no acceptable site trees, record that in the plot notes and leave this section blank.

An individual site tree may be used for more than one condition class where differences in conditions are not the result of differences in site productivity. For example, when different conditions are caused solely due to differences in reserve status, owner class, and/or disturbance-related differences in density (e.g., thinned vs. unthinned), a site tree may be used for more than one condition. When in doubt, do not use a site tree for more than one condition.

Select site trees based on the criteria listed below:

1. Only one site tree is required for juniper and oak condition classes.
2. PNW-FIA requires at least 3, and sometimes 5 or 10 site trees for all accessible forest land condition classes if they are available (though not all of the site trees need to be from the current inventory, and some site trees may be used for multiple condition classes).
3. An accessible forest land condition class with a ground land class (GLC) of 120, or "timberland", should have at least **three** representative site trees (and 5 or 10 if using King's method). If no suitable site trees are available from the condition class area, select trees from a nearby area with the same general aspect

## Annual Inventory 2007, Chapter 9: Site Index

and elevation. If three trees still can not be obtained, get as many as possible and explain in "Present Condition/Past Disturbance" on the PLOT RECORD.

4. If the forest land condition class is an "other forest" site (e.g. rocky, juniper, oak, unsuitable site, low site) only one site tree is required.
5. If the condition class is a conifer site select only conifer site trees. A conifer site is any timberland site not meeting the hardwood site definition below.
6. If the condition class is a hardwood site, select the dominant tree or trees for site. A hardwood site is timberland that is incapable of growing a manageable conifer stand. Examples include: cottonwood flats along streams, red alder stands on low, wet ground, and dry oak woodlands. If the condition class is a hardwood site, but there are a few conifers present, select the conifers for site index.
7. If the condition class meets the definition of Riparian Forest, choose conifers if it is a conifer site or they are available within a hardwood site. Choose hardwoods when conifers are not available. See the Primary Selection Method for species selection information.
8. If the plot area is not suitable for selecting site trees, then the field crew may select site trees off the plot area, as long as the site tree adequately represents the growing site in the plot area. The field crew must use their best judgment in determining how far off the plot is reasonable. The crew should pick the tree closest to the plot that represents the overall site of that condition class.
9. If there are multiple condition classes and no obvious differences in site productivity between condition classes, use the previously collected site trees and/or additional site trees from the current inventory for all forest land condition classes on the plot.
10. If differences in site productivity do exist among condition classes, use the previously collected site trees and/or additional site trees from the current inventory to meet the site tree requirements for each condition class.
11. The site index will be calculated in the data recorder using either 50 or 100 year site equations. The equation used will depend on both the site tree selection method used and the species the crew selects. With 50 year site equations, the site index should not vary by more than 20 between site trees unless the difference can be explained by actual site variation within the condition. With 100 year site equations, the site index should not vary by more than 30 unless the difference can be explained by actual site variation within the condition. When the site index falls outside the required range of 20 or 30, explain why in "Present Condition/Past Disturbance" on the PLOT RECORD
12. When extra trees have been collected that fall outside the required site index range of 20 or 30, it is up to the crew to decide whether to retain these in the data recorder or delete them. The crew should check that the data entered makes sense, and that the trees selected are appropriate (i.e. ages and heights were correctly entered and the trees are a good representation of the site potential). Trees that are retained that fall outside the range can give useful information for analysts, but a justification should be written on the plot card. Do not delete downloaded site tree records.

### **PREVIOUSLY VISITED PLOTS**

On previously visited plots, the prior site tree data will be reviewed and recommendations will be made for what the crew needs to collect. At previous inventories, site tree data were collected at the plot level and will usually correspond to the current condition class 1. Collect additional site trees for this condition class if instructed to do so on the plot sheet or by the PDR. Generally, additional site trees are needed when site index information is incomplete, absent, or unreliable. On plots with sufficient site data, the reviewer will recommend that only one tree per condition class is required by national FIA procedures. In the field, the crew should check whether the previous site trees represent the forest land within the condition class area. If they do not, the crew should collect, if available, additional site trees that support their claim and should document their case in "Present Condition/Past Disturbance" on the PLOT RECORD. Do not delete or change downloaded site tree records. To update one of these trees, enter it as new record.

### **NEW PLOTS**

On new plots, collect a set of 3, 5 or 10 site trees for each accessible forest land condition class that occurs on any part of the annular radius (58.9-foot fixed-radius).

If there are multiple condition classes on the plot, and there are no obvious differences in site productivity, only one set of site trees need to be collected to represent all conditions. This is done by listing in the data recorder all condition classes that each site tree represents. If there are multiple condition classes on the plot, and each condition class appears to have different site productivity, collect a set of site trees for each condition.

New plots include the following:

- Plots visited for the first time,
- Plots visited previously that can not be found (lost plot),
- Plots previously visited in Oregon or Washington consisting of one 16.95 or 17.0-meter (55.8 ft.) fixed-radius vegetation profile plot ( previous GLC is 41, 45 or 46) that is being replaced with a new 4-subplot plot, which has at least one mapped condition class that is accessible forest land.
- Plots previously classified as nonforest but have at least one mapped condition class that is accessible forest land at the current visit.

## 9.2 SELECTING SITE TREE SPECIES

Tree species should be the same for all site trees on a condition. There are exceptions to this rule:

- a) Douglas-fir and grand fir trees can be combined (Douglas-fir is preferred), and
- b) Noble fir and mountain hemlock trees can be combined (noble fir is preferred), and
- c) Western hemlock and Sitka spruce can be combined (western hemlock is preferred), and
- d) Mixed conifer sites in California.

When one species is preferred as in the exceptions a-c above, select the preferred species and mix species only as a last resort.

Douglas-fir is the preferred site species throughout the coastal Douglas-fir type in western Oregon, western Washington, and northwestern California. All Douglas-fir site trees on a plot should be selected with one method, either King's or Primary. On revisited plots with downloaded Douglas-fir site trees, use the selection method previously used unless an entire new set of trees is obtained.

### **HIERARCHY OF METHOD SELECTION: "HOW TO DECIDE METHOD"**

1. If adding to an existing set of site trees, use the same method used previously, if the method is known. It is rare that a new set of trees will be collected if trees had been collected before. These exceptions are: A stand that was mature, 200 years old, for example, and is now a young plantation; or when the species for the stand changes. If in doubt, get a new set of site trees, following the method that applies at the current visit.
2. Use King's method in the coastal (west of the Cascade Mountains) Douglas-fir type, if possible. Very specific rules apply in selecting site trees when using King's method; do not use King's method unless these rules can be satisfied.
3. For OR and WA: Always use the Primary method when King's cannot be met.
4. For CA:
  - a) Use King's if the criteria are met. If not, then go to "b."
  - b) Decide if the area is a Mixed conifer site. If yes, use the Mixed conifer method. If not, go to "c."
  - c) Use the Primary method.

### **KING'S SELECTION METHOD**

1. King's method is the preferred selection method for 1) Douglas-fir and grand fir and for 2) western hemlock and Sitka spruce (do not mix these two groups of species).
2. Use this method only if the overall stand is < 130 years old and below 3000 feet in elevation.
3. Within the area of the standard layout, locate an approximately circular area that is moderately or well-stocked by a group of 25 mainstand a) Douglas-fir and grand firs or b) western hemlock and Sitka spruce trees (do not mix these two groups of species) and is representative of the site being sampled. A very rough rule of thumb: this approximately circular area should not have a "diameter" greater than 120 to 130 feet. When determining the 25 trees, count only trees with normally-formed tops (no trees with forked tops or top out); do not include

## Annual Inventory 2007, Chapter 9: Site Index

understory trees that are both younger and shorter than the general crown canopy. If you believe the stocking does not perfectly match the definition for King's, but you can find 5 or 10 suitable site trees, then King's is preferred.

4. From the 25 trees in the clump, select the 5 trees with the largest DBH as site trees (the "1/5 rule") if the average breast height age of trees in the clump is >30 years. If the average age is < 30 years, go to step 5.
5. Sometimes only very young trees are available. Although site trees under 30 years breast-high age are undesirable, select site trees between 15 and 30 years old (age at breast age) if no others are available. Do not use trees less than 15 years old at breast height. Select from a clump of 50 mainstand Douglas-fir and grand firs or western hemlock and Sitka spruce trees (do not mix these two groups of species), taking 10 with largest DBH as site trees. Include only trees with normally formed tops (no trees with forked tops or top out); do not include understory trees that are both younger and shorter than the general crown canopy.
6. Any site tree with a clear history of suppression should be rejected, and the next largest tree selected IF it is suitable. However select a suppressed tree over a shorter, suppression-free tree of the same age.
7. Whether the crew gets 5 or 10 trees, the site index should be within 20.
8. If there are no suitable site trees selected within the plot area, select trees from a nearby group on the same general aspect and elevation, and note that the site trees were obtained off the plot in "Present Condition/Past Disturbance" on the PLOT RECORD.

### **PRIMARY SELECTION METHOD, CONIFERS**

This selection method was previously known as the McArdles' selection method, but now includes several different equations. Use this method if King's method can't be used in Oregon and Washington. In California, use this method if King's or Mixed Conifer methods can't be used.

1. Select three dominant trees of the same species representative of the plot area.
2. Site trees should be evenly distributed across the condition class area if possible.
3. Select trees that are and have been free from suppression for their entire lives. A tree that has been suppressed will have closely-space annual growth rings on all or part of its increment core. Be particularly careful when in residual stands from which the dominant trees have been harvested.
4. Select site trees that have their original tops and show no signs of previous top breakage such as crooks and forks.
5. Trees greater than 50 years old are desirable, but younger trees may be selected if none are available. Trees 60 to 120 years old are most desirable, but younger trees may be used if needed.
6. Do not use trees younger than 15 years old at breast height.
7. For this method, some of the species will be associated with 50 year site equations, and the site index should not vary by more than 20. Other species are associated with 100 year site equations and should not vary by more than 30. These "100 year species" are: Douglas-fir at high elevation (above 3,000 feet), noble fir, mountain hemlock, Coulter pine, ponderosa pine, western white pine, and lodgepole pine, or when using the mixed-conifer selection method.
8. If it is necessary to use true fir site trees, be very sure that they are not released understory trees. Never select true fir trees under 50 years old (breast height age). In Oregon and Washington, select a Pacific silver fir only as a last resort. Avoid Pacific silver fir in older stands due to likelihood of history of suppression. In California, choose red fir over white fir when possible, since white fir is frequently suppressed.
9. Other conifers that are a last resort include Pacific yew, Incense cedar, and western redcedar. If other conifers are available, do not use these species. If one must use Pacific yew, only bore one tree. If one must choose either Incense cedar or western redcedar as site trees, then bore three trees and try to keep the site index within 30. Do not bore any other cedar species unless they are the only option, then get one tree to fulfill the national requirement.



### **PRIMARY SELECTION METHOD, HARDWOODS**

1. Hardwoods are the last resort for site tree selection. When in a mixed hardwood and conifer stand, always choose the conifer. For example, when in a mixed black oak and Douglas-fir stand, select Douglas-fir site trees. When in a stand of mixed red or white alder and a conifer, choose the conifer.
2. When in a hardwood stand that is incapable of growing suitable conifers, choose one or three hardwood trees, depending on species.
3. Red alder and bigleaf maple are both being planted commercially and there are site indices developed for them. When in a stand of red alder with no suitable conifers present, select three red alder trees. If in a mixed stand of red alder and bigleaf maple and or white alder, choose three red alder trees. If in a stand of white alder, with no conifers available, choose three white alder trees for site. It would be an unusual situation to have to bore bigleaf maple for site trees. If one were in a stand of bigleaf maple with no suitable conifers or red alder present, then get three trees. For red alder, bigleaf maple, or white alder, the site index should fall within 20. Do not mix species.
4. Other hardwood species also have a site index developed and one should get one site tree if there are no suitable conifers present. These species are: black oak, blue oak, coast live oak, tanoak, and Pacific madrone. Do not select one black oak instead of three conifers. Always choose conifers from the stand if they are available.
5. For all other hardwood species, if no suitable conifers are present, select one tree to meet the national requirement. All Populus species, including black cottonwood, quaking aspen, balsam poplar and paper birch, if selected as a site tree to meet the national requirement, should be bored outside the plot area.

### **MIXED CONIFER SELECTION METHOD**

Use this method for the mixed conifer type in California ONLY: For this method, rules under "Primary Selection method" apply with the exceptions noted below. Use the descriptions of Ponderosa pine and mixed conifer types under "site descriptions" below when deciding whether to use this method. Note: if the area is within a ponderosa pine stand that does not meet the mixed conifer definition, ponderosa pine is the first choice for site trees. If there are no ponderosa pines suitable, then use Douglas-fir or white fir and follow these criteria as if it met the definition for a mixed conifer stand.

1. Select three dominant trees on a plot. They can be a mix of ponderosa pine, Douglas-fir, white fir, and red fir. If additional site trees are needed to get enough, sugar pine and Jeffrey pine can also be used. Do not use any other species when within this forest type.
2. Be aware that true firs are more shade-tolerant than pines and may have been subject to suppression. Be aware that overstory removal is sometimes used in this type, and remaining trees may have been subject to suppression.
3. Site index should fall within 30.
4. Use trees that are at least 50 years old whenever possible. Ideally, trees should be within 60 and 120 years old. Do not use trees that are less than 15 years old at breast height.

### **SITE DESCRIPTIONS**

The following descriptions of forest types can assist crews when trying to select the dominant species for a site.

- a) Coastal Douglas-fir Type-- Found in coastal counties in northwestern California, and western Oregon and Washington on the west slopes of the Coast Range and foothills west of the Cascades. It is often found in combination with redwood in California, forming more pure stands on the higher, drier slopes. Grand fir is another component of Douglas-fir-redwood and Douglas-fir stands, or this type is occasionally found in pure stands. Sitka spruce, red alder, western hemlock, and western red-cedar may also be found in the coastal plot. Species that could be used for site trees include Douglas-fir, grand fir, redwood, western hemlock, and Sitka spruce. Douglas-fir will usually be preferred. When in this type, red alder should be used only if the site is capable of growing hardwoods only.
- b) Ponderosa Pine Type-- Found in pure stands (80 percent or more of stand before cutting) with Jeffrey pine as an important associate in SW Oregon and California. On the west slopes of the Cascades and Sierras and east slopes of the Coast Range this type is found above the gray pine and oaks and below the mixed conifer. It

is found with minor stand components of oaks, and on better sites, sugar pine, Douglas-fir, white fir, and incense-cedar. However, these species combined never total more than 20 percent on the stand. When in the ponderosa pine type, ponderosa pine is the preferred site species. However, if necessary, the mixed-conifer selection method may be used.

- c) Red Fir Type-- Found above the mixed conifer type at elevations of approximately 6600 feet. Red fir is the dominant species with white fir present at the lower elevation range. At the upper elevation it borders a thin band of mountain hemlock found just below timberline. Both red and white fir can be used as site trees. However, be aware that white fir is particularly subject to suppression, and red fir will usually be preferred.
- d) Mixed Conifer Type-- Recognized for California ONLY. If the stand contains Douglas-fir, ponderosa pine, and white or red fir, and does not fit in one of the above three types, then this is a mixed conifer stand. A complex association of ponderosa pine, sugar pine, Douglas-fir, and white and red fir may predominate. Incense cedar is also a component, along with some hardwoods, but these species would not be selected for site trees. Generally, the conifer species are intermixed either as single trees or in small groups. Vertical mixing also is common with one to three species in the overstory and one or two species in the understory. Mixed conifer types grow on the east facing slopes of the Coast Range, and on the west facing and higher elevation east facing slopes of the Cascades and Sierra Nevada. This type also extends south into southern California. See the mixed-conifer selection method for selection of species.
- e) Lodgepole Pine Type-- Found generally at higher elevations in the Sierra Nevada. Lodgepole pine is the preferred site species.
- f) Mountain Hemlock Type-- Found at high elevations above the red fir type. Use other site trees if possible.
- g) Western White Pine-- Not a type, only found at higher elevations. Use other site trees if possible.
- h) Coulter Pine Type-- Found in the Central Coast area. Coulter pine may be used as a site species.

### 9.3 SITE TREE DATA VARIABLES

For each site tree record all of the following items:

#### 9.3.1 Site Tree Number (PNW)

Record a code indicating the assigned number for each site tree record on a plot. Numbers will be assigned before fieldwork to downloaded/printed site trees. The data recorder will automatically assign a number to each new site tree.

#### 9.3.2 SUBPLOT NUMBER (CORE OPTIONAL 7.2.7)

Record the subplot number to which the site tree is referenced.

Use the same procedures described in Section 5.5.1. Record a 2-digit code indicating the number of the subplot on which a site tree is on or near. Subplot numbers for site trees previously collected will be downloaded/printed if on file.

When collected:	All site trees
Field width:	1 digit
Tolerance:	No errors
Values:	1) Center subplot; 2) North subplot; 3) Southeast subplot; 4) Southwest subplot

#### 9.3.3 CONDITION CLASS LIST (CORE 7.2.1)

List all CONDITION CLASS NUMBERS that the site index data from this tree represent. Record for new site trees. Record for downloaded site trees, usually condition class 1.

When collected:	All site trees
Field width:	5 digits
Tolerance:	No errors
Values:	1 to 56789

#### 9.3.4 Tree Tag Number (PNW)

If a site tree is a trackable tree, and has a tree number tag, record the number. If a site tree is not a trackable tree, but has a tree tag number from a previous inventory, record the number. Otherwise leave blank.

When collected:	All site trees that are trackable trees, with a tree number tag
Field width:	3 digits
Tolerance:	No errors
Values:	Blank, 1 to 999

**9.3.5 AZIMUTH (CORE OPTIONAL 7.2.8)**

Record the AZIMUTH from the subplot center; sight the center of the base of each tree with a compass. Record AZIMUTH to the nearest degree. Use 360 for north.

Record an azimuth for new site trees. Record the azimuth even if the site tree is not within 58.9 feet of a subplot center.

When collected:	All site trees. All new site trees
Field width:	3 digits
Tolerance:	+/- 10 degrees
Values:	001 to 360

**9.3.6 HORIZONTAL DISTANCE (CORE OPTIONAL 7.2.9)**

Record the measured HORIZONTAL DISTANCE, to the nearest 0.1 ft, from the subplot center to the pith of the tree at the base.

When collected:	All site trees
Field width:	4 digits (xxx.y)
Tolerance:	+/- 5 ft
Values:	000.1 to 200.0 ( <i>When possible</i> )

**9.3.7 SPECIES (CORE 7.2.2)**

Use the same species codes described in Section 7.4.9.

When collected:	All site trees. (Species is downloaded for site trees previously collected. <u>Record for new site trees.</u> )
Field width:	4 digits
Tolerance:	No errors
Values:	See Appendix 9

**9.3.8 DIAMETER (CORE 7.2.3)**

Use the same procedures and tolerances described in Section 7.6

Diameter is downloaded for site trees previously collected. Record for new site trees.

When collected:	All site trees.
Field width:	4 digits (xxx.y)
Tolerance:	--Live trees +/- 0.1 inches per 20.0 in increment of measured diameter. For example, a tree with a diameter of 41.0 in would have a tolerance of +/- 0.3 inches
Values:	001.0 to 999.9

**9.3.9 SITE TREE LENGTH (CORE 7.2.4)**

With a clinometer or other approved instrument, measure the total length of the site tree from the ground to the top of the tree. Record to the nearest 1.0 foot. SITE TREE LENGTH must be measured; no estimates are permitted on site trees.

Downloaded for site trees previously collected. If updating a downloaded site tree, measure the tree's current height and enter it on the new (second) record for the tree (be sure also to enter a current age at BH on the new record).

When collected:	All site trees.
Field width:	3 digits
Tolerance:	+/- 5% of true length
Values:	005 to 999

### 9.3.10 TREE AGE AT DIAMETER (CORE 7.2.5)

Record the tree age as determined by an increment sample. Bore the tree at the point of diameter measurement (DBH/DRC) with an increment borer. Count the rings between the outside edge of the core and the pith. Do not add years to get total age.

Downloaded for site trees previously collected. If updating a downloaded site tree, determine the number of years elapsed since the tree was taken as a site tree, add this number to the downloaded age and enter the sum on the new (second) record for the tree (be sure also to measure and enter the current height on the new record).

When collected:	All site trees.
Field width:	3 digits
Tolerance:	+/- 5 years
Values:	001 to 999

### 9.3.11 Site Tree Selection Method (PNW)

This data item distinguishes between King's and Primary selection methods for relevant species. Not valid for mixed conifer types. A note should be added if the variable can not be collected.

When collected:	All site trees collected when Species (9.3.7) = 202, 17, 263, or 98
Field width:	1 digits
Tolerance:	No errors
Values:	K, P

### 9.3.12 Site Index (PNW)

Downloaded for site trees previously collected. If a downloaded tree is updated for BH. age and height, the data recorder will recalculate the tree's index. On a new site tree, the data recorder will calculate site index after the tree's species, height, BH age, and site index equation number are entered. If recording on paper, the index will be determined after the plot is entered electronically.

### 9.3.13 SITE TREE NOTES (CORE 7.2.6)

Record notes pertaining to an individual site tree.

When collected:	All site trees as necessary.
Field width:	alphanumeric character field
Tolerance:	
Values:	English language words, phrases and numbers

## 9.4 SITE TREES: POST FIELD REVIEW

Crew coordinators will review each plot that needs new or additional site trees. The coordinators will check to see that site tree data is complete, satisfies site tree instructions, and is written up as needed. Afterwards, the lead technician will review each plot for site trees and plot site index. Prior to the technician's review, no one should delete site trees that were downloaded or added at the previous occasion.

## 9.5 STOCKABILITY IN OREGON AND CALIFORNIA

### 9.5.1 Stockability Indicators for Oregon (PNW)

In Douglas, Jackson, and Josephine counties, some plots have forest land condition classes that are low site, and are incapable of attaining normal yield table levels of stocking. For such classes, potential productivity (mean annual increment at culmination) must be discounted; and the individual tree contribution to stocking must be increased to account for the lower stocking capacity. For each such plot, the presence of key indicators is required to determine the discount factor (See Section 4.6.38). In Douglas County, a discount factor is also assigned (see Section 9.5.2).

For plots, new or revisited, having one or more mapped accessible forest land condition classes, mark with an "x" each indicator plant that is found in these classes. On some plots previously visited, an "x" may already be present next to a plant. Do not delete this record. If an indicator was already marked but seems to be a clear error in species identification, then make a note on the plot card that explains why the species may be in error. Otherwise, do not remove pre-existing check marks, even if the indicator plant is presently dead. For any new indicators to be

Annual Inventory 2007, Chapter 9: Site Index

checked off at the current visit, trees and shrubs have to be alive to be used. Forbs and grasses (annual and perennial) have to be alive sometime in the current year, but can be senesced at the time the crew visits. An indicator, to be coded, does not have to be within the 58.9 ft radius of a subplot, but only within the greater area of the condition class. Record the CONDITION CLASS RECORD in "Stockability Indicator Set" in Section 4.6.38, a "1" (Set 1) for each accessible forest land condition class on the plot.

Usually, one set of indicators is sufficient on a plot. Occasionally, a forest condition class change is also a change in stocking limitations. If so, an additional set of indicators (Set 2) will be collected and each condition class will be assigned one or the other set on the CONDITION CLASS RECORD.

Do not code for the presence of indicators that are on nonforest land or on forest land other than accessible forest land. Do not code the presence of plants that occur in isolated microsites within the plot area, such as in small seeps or springs, or on an isolated rock outcrop.

Refer to the list of plant indicators for the appropriate county below when recording this information.

When collected:	All accessible forest land condition classes (CONDITION CLASS STATUS = 1) in Oregon when COUNTY = 19, 29, 33			
Field width:				
Tolerance:	No error in Indicator identification			
Values:	County	Scientific name	Common name	Code
	Jackson,	Abies grandis	grand fir	ABGR
		Josephine	Pinus jeffreyi	Jeffrey pine
	Quercus garryana		Oregon white oak	QUGA4
	Arctostaphylos viscida		whiteleaf manzanita	ARVI4
	Ceanothus cuneatus		wedgeleaf ceanothus	CECU
	Paxistima myrsinites		Oregon boxwood	PAMY
	Symphoricarpos spp.		snowberry	SYMPH
	Aira caryophyllea		hairgrass	AICA
	Douglas		Pinus jeffreyi	Jeffrey pine
		Quercus chrysolepis	canyon live oak	QUCH2
		Quercus garryana	Oregon white oak	QUGA4
		Aspidotis densa	serpentine pod fern	ASDE6
		Dryopteris arguta	coastal wood fern	DRAR3
		Antennaria spp.	pussytoes	ANTEN
		Eriophyllum lanatum	woolly sunflower	ERLA6
	Elymus elymoides	squirreltail	ELEL5	

**9.5.2 Oregon Stockability Discount Factor (PNW)**

For Douglas County plots in Oregon only: In addition to recording plant indicators, record the most appropriate stockability discount factor. If two sets of plant indicators are coded on a plot, assign a discount factor for each set. Use the following guidelines.

When collected:	All accessible forest land condition classes (CONDITION CLASS STATUS = 1) in Oregon when COUNTY = 19		
Field width:			
Tolerance:	No error in Indicator identification		
Values:	Indicators	Plant community	Stockability Discount Factor
	None		1.00
	Jeffrey pine and/or serpentine pod fern	Peridotite/serpentine; elevation is 915 meters or less	.27
	Pussytoes and/or woolly sunflower and/or squirreltail (if Jeffrey pine and/or serpentine pod fern present, use discount of 0.27; any others may be present without changing the factor)	Very xeric; non-peridotite/serpentine	.62

	Oregon white oak and/or coastal wood fern (canyon live oak may be present, but not Jeffrey pine, serpentine pod fern, everlasting, woolly sunflower, or squirreltail)	White oak; elevation is 1000 feet or less	.70
	Canyon live oak (there must not be other indicators present)	Canyon live oak	.86

**9.5.3 Stockability Indicators for California (PNW)**

The state of California has eight ecological units to which most counties in the state have been assigned. In order to estimate the stocking capacity of each plot area, separate stockability equations have been developed for each unit, except unit 8, which lacks an equation. The equations are based, in part, on the presence or absence of certain plants. The plant indicators required for each ecological unit are listed below. You will note that the presence of some plants indicates a dry site that limits stand density (-) while the presence of others indicates a moist site that enhances stand density (+), and that the degree of stocking limitation or enhancement varies from indicator to indicator.

Usually, a single list of plant indicators will be sufficient for each plot. Sometimes, however, plots with two or more timberland condition classes may include two or more sites with different stocking limitations (note: different condition classes do not automatically make for different stocking limitations). In this case, an additional set of indicators will be collected. The plot reviewer will record a note in "FIELD CHECK ITEM" on the plot card if he/she thinks that more than one set of indicators may be required. For each plot, two sets of plant indicators are possible.

Newly established plots. For newly established plots, the plot reviewer will record the plot's ecological unit on the plot card under "FIELD CHECK ITEM". Mark with an "x" any of the plant indicators found on the plot under Set 1. As above, if a condition class change is also a change in stocking limitation, create two plant indicator lists by marking the plant indicators associated with that condition class under Set 2. Record on the Condition Class Attributes the Stockability Indicator Set # for each condition class on the plot.

On some plots previously visited, an "x" may already be present next to a plant. Do not delete this record. If an indicator was already marked but seems to be a clear error in species identification, then make a note on the plot card that explains why the species may be in error. Otherwise, do not remove pre-existing check marks, even if the indicator plant is presently dead. For any new indicators to be checked off at the current visit, trees and shrubs have to be alive to be used. Forbs and grasses (annual and perennial) have to be alive sometime in the current year, but can be senesced at the time the crew visits.

**Ecological Unit 1**

Shasta and Trinity counties – Trees

ABMA	<i>Abies magnifica</i>	red fir, California red fir
PILA	<i>Pinus lambertiana</i>	sugar pine
PIPO	<i>Pinus ponderosa</i>	ponderosa pine
PSME	<i>Pseudotsuga menziesii</i>	Douglas-fir
QUGA4	<i>Quercus garryana</i>	Oregon white oak
QUKE	<i>Quercus kelloggii</i>	California black oak
QUWI2	<i>Quercus wislizeni</i>	interior live oak

Shasta and Trinity counties – Shrubs

CHSE11	<i>Chrysolepis sempervirens</i>	bush chinquapin
CEMOG	<i>Cercocarpus montanus var. glaber</i>	birchleaf mountain-mahogany
CECU	<i>Ceanothus cuneatus</i>	wedgeleaf ceanothus
CELE	<i>Ceanothus lemmonii</i>	Lemmon ceanothus
CELE3	<i>Cercocarpus ledifolius</i>	curlleaf mountain-mahogany
CEOR9	<i>Cercis orbiculata</i>	California redbud
CEPR	<i>Ceanothus prostratus</i>	mahala mat
PREM	<i>Prunus emarginata</i>	bitter cherry
QUGAB	<i>Quercus garryana v brewerii</i>	Brewer oak

Annual Inventory 2007, Chapter 9: Site Index

Shasta and Trinity counties – Forbs

ASARU	<i>Asarum sp. herbaceous</i>	wild ginger
CHUM	<i>Chimaphila umbellata</i>	prince's pine
PTAN2	<i>Pterospora andromedea</i>	pinedrops
PYPI2	<i>Pyrola picta</i>	white-veined pyrola
MAIAN	<i>Maianthemum spp</i>	false Solomon-seal
TRBOL	<i>Trientalis borealis spp. latifolia</i>	broadleaf starflower

**Ecological Unit 2**

Western Tehama, Glenn, Colusa, Sutter, Lake, Napa, and Yolo counties – Trees

PISA2	<i>Pinus sabiniana</i>	gray pine
QUGA4	<i>Quercus garryana</i>	Oregon white oak

Western Tehama, Glenn, Colusa, Sutter, Lake, Napa, and Yolo counties – Shrubs

ARCA5	<i>Arctostaphylos canescens</i>	hoary manzanita
ARMA	<i>Arctostaphylos manzanita</i>	big manzanita
ARVI4	<i>Arctostaphylos viscida</i>	whiteleaf manzanita
CECO	<i>Ceanothus cordulatus</i>	mountain whitethorn ceanothus
CEIN3	<i>Ceanothus integerrimus</i>	deerbrush
QUDU	<i>Quercus dumosa</i>	scrub Oak
QUGAB	<i>Quercus garryana var. brewerii</i>	Brewer oak
ROGY	<i>Rosa gymnocarpa</i>	wild rose

Western Tehama, Glenn, Colusa, Sutter, Lake, Napa, and Yolo counties – Forbs

PHSPO	<i>Phlox speciosa ssp. occidentalis</i>	phlox
-------	-----------------------------------------	-------

**Ecological Unit 3**

Modoc, Lassen, eastern Plumas, eastern Sierra, eastern Nevada, eastern Placer and eastern Eldorado – Trees

ABMA	<i>Abies magnifica</i>	red fir, California red fir
------	------------------------	-----------------------------

Modoc, Lassen, eastern Plumas, eastern Sierra, eastern Nevada, eastern Placer and eastern Eldorado – Shrubs

CEMOG	<i>Cercocarpus montanus var. glaber</i>	birchleaf mountain mahogany
CELE3	<i>Cercocarpus ledifolius</i>	curlleaf mountain mahogany
RICE	<i>Ribes cereum</i>	squaw currant
RIRO	<i>Ribes roezlii</i>	sierra gooseberry
SYMPH	<i>Symphoricarpos spp.</i>	snowberry

Modoc, Lassen, eastern Plumas, eastern Sierra, eastern Nevada, eastern Placer and eastern Eldorado – Forbs

ACMIO	<i>Achillea millefolium var. occidentalis</i>	western yarrow
AGHE2	<i>Agoseris heterophylla</i>	mountain dandelion
AGRE2	<i>Agoseris retrosa</i>	mountain dandelion
BALSA	<i>Balsamorhiza spp.</i>	balsam root
BRTE	<i>Bromus tectorum</i>	cheatgrass
CIUMU	<i>Cistanthe umbellatum var. umbellatum</i>	pussypaws
CHUM	<i>Chimaphila umbellata</i>	prince's pine
ERCA14	<i>Erysimum capitatum</i>	wallflower
LICI	<i>Linanthus ciliatus</i>	bristly-leaved linanthus
LINU3	<i>Linanthus nuttalli</i>	Nuttall's linanthus
LONU2	<i>Lomatium nudicaule</i>	hog-fennel
LODO2	<i>Lomatium donnellii</i>	hog-fennel
OSBE	<i>Osmorhiza berteroi</i>	sweet-cicely
POTEN	<i>Potentilla spp</i>	cinquefoil
PTAN2	<i>Pterospora andromedea</i>	pinedrops
PYPI2	<i>Pyrola picta</i>	white-veined pyrola
MAIAN	<i>Maianthemum spp.</i>	false Solomon-seal
ACHNA	<i>Achatherum spp.</i>	needlegrass

**Ecological Unit 4**

Western Sierra, western Nevada, Yuba, western Placer, and western El Dorado counties – Shrubs

ARVI4	<i>Arctostaphylos viscida</i>	whiteleaf manzanita
CECU	<i>Ceanothus cuneatus</i>	wedgeleaf ceanothus
RULE	<i>Rubus leucodermis</i>	western raspberry

Western Sierra, western Nevada, Yuba, western Placer, and western El Dorado counties – Forbs

GOOB2	<i>Goodyera oblongifolia</i>	rattlesnake plantain
POCO4	<i>Polygala cornuta</i>	milkwort
ELEL5	<i>Elymus elymoides</i>	bottlebrush squirreltail
VILO2	<i>Viola lobata</i>	violet

**Ecological Unit 5**

Amador, Calaveras, Tuolumne, Mariposa, Madera, Fresno, Tulare, Kern counties – Trees

PIMO3	<i>Pinus monticola</i>	western white pine
PISA2	<i>Pinus sabiniana</i>	gray pine
QUDO	<i>Quercus douglasii</i>	blue oak
UMCA	<i>Umbellularia californica</i>	California laurel-myrtle

Amador, Calaveras, Tuolumne, Mariposa, Madera, Fresno, Tulare, Kern counties – Shrubs

CEMOG	<i>Cercocarpus montanus var. glaber</i>	birchleaf mountain mahogany
CELE3	<i>Cercocarpus ledifolius</i>	curlleaf mountain mahogany
CECU	<i>Ceanothus cuneatus</i>	wedgeleaf ceanothus
GAFR	<i>Garrya fremontii</i>	garrya silk tassel
QUGAS	<i>Quercus garryana var. semota</i>	kaweah oak
RHIL	<i>Rhamnus ilicifolia</i>	redberry

Amador, Calaveras, Tuolumne, Mariposa, Madera, Fresno, Tulare, Kern counties – Forbs

ADBI	<i>Adenocaulon bicolor</i>	trail plant
CHME	<i>Chimaphila menziesii</i>	pipsissewa
CHRY9	<i>Chrysothamnus spp.</i>	rabbit-brush
CHUM	<i>Chimaphila umbellata</i>	prince's pine
DISPO	<i>Disporum spp.</i>	fairy bells
GOOB2	<i>Goodyera oblongifolia</i>	rattlesnake plantain
PESE2	<i>Pedicularis semibarbata</i>	indian warrior
PTAN2	<i>Pterospora andromedea</i>	pinedrops
PYPI2	<i>Pyrola picta</i>	white-veined pyrola
ELEL5	<i>Elymus elymoides</i>	bottlebrush squirreltail
MAIAN	<i>Maianthemum spp.</i>	false Solomon-seal
VILO2	<i>Viola lobata</i>	violet

**Ecological Unit 6**

Eastern Tehama, Butte, western Plumas counties – Trees

ABCO	<i>Abies concolor</i>	white fir
ABGR	<i>Abies grandis</i>	grand fir
ABMA	<i>Abies magnifica</i>	red fir, California red fir
QUGA4	<i>Quercus garryana</i>	Oregon white oak

Eastern Tehama, Butte, western Plumas counties – Shrubs

CEMOG	<i>Cercocarpus montanus var. glaber</i>	birchleaf mt. mahogany
CECU	<i>Ceanothus cuneatus</i>	wedgeleaf ceanothus
CELE	<i>Ceanothus lemmonii</i>	Lemmon ceanothus
CELE3	<i>Cercocarpus ledifolius</i>	curlleaf mountain mahogany
CEOR9	<i>Cercis orbiculata</i>	California redbud
CEPR	<i>Ceanothus prostratus</i>	mahala mat
PRSU2	<i>Prunus subcordata</i>	klamath plum



Annual Inventory 2007, Chapter 9: Site Index

Eastern Tehama, Butte, western Plumas counties – Forbs

BRTE	<i>Bromus tectorum</i>	cheatgrass
CHUM	<i>Chimaphila umbellata</i>	prince's pine
PYPI2	<i>Pyrola picta</i>	white-veined pyrola

**Ecological Unit 7**

Siskiyou County – Trees

ABMA	<i>Abies magnifica</i>	red fir, California red fir
ABSH	<i>Abies shastensis</i>	shasta red fir
JUOC	<i>Juniperus occidentalis</i>	western juniper
PICO	<i>Pinus contorta</i>	lodgepole pine
QUGA4	<i>Quercus garryana</i>	Oregon white oak
SALIX	<i>Salix spp.</i>	willow

Siskiyou County – Shrubs

ARVI4	<i>Arctostaphylos viscida</i>	whiteleaf manzanita
RHTR	<i>Rhus trilobata</i>	skunk bush
ARTR2	<i>Artemisia tridentata</i>	big sage brush

Siskiyou County – Forbs

AGROP2	<i>Agropyron spp.</i>	wheatgrass
PSSPS	<i>Pseudoroegneria spicata ssp. spicata</i>	bluebunch wheatgrass
ADBI	<i>Adenocaulon bicolor</i>	trail plant
CAAP4	<i>Castilleja applegatei</i>	indian paintbrush
CHRYS9	<i>Chrysothamnus spp.</i>	rabbit-brush
FESTU	<i>Festuca spp.</i>	fescue
LONU2	<i>Lomatium nudicaule</i>	hog-fennel
MAIAN	<i>Maianthemum spp.</i>	false Solomon-seal

**Ecological Unit 8**

(There are no stockability equations with plant indicators for Ecological Unit 8)

Includes north coast and part of the central coast survey units. Counties in these units are: Del Norte, Humboldt, Mendocino, Sonoma, Marin, San Francisco, San Mateo, Santa Cruz, Monterey, and Santa Clara.



## 10 GROUND COVER ON NFS LANDS

### Table of Contents

<b>10</b>	<b>GROUND COVER ON NFS LANDS.....</b>	<b>183</b>
<b>10.1</b>	<b>GROUND COVER MEASUREMENTS .....</b>	<b>185</b>
10.1.1	Subplot Number (PNW).....	185
10.1.2	Transect (PNW).....	185
10.1.3	Segment ID (PNW).....	185
10.1.4	Ground Cover Type (PNW).....	186
10.1.5	Cover (PNW).....	187



## Chapter 10: Ground Cover on NFS Lands

Information on the abundance of different ground cover types provides information on the hydrologic function of a site and its potential to erode. Because estimates of bare ground and rock cover need to be relatively precise, estimates are done on the plot transects, rather than on the subplot as a whole (as is done for vegetation cover). Two 10-foot long segments are located on each of the two transects, and cover estimated separately on each section.

On established field plots if the center of any subplot is in R6 or R5 National Forest, ground cover is measured on all accessible (forest and nonforest) condition classes on that subplot. If the transect crosses an ownership or other condition class boundary, record the change in condition class at the boundary point as part of Down Woody Debris transect segmenting procedures. If a portion of a transect falls into hazardous, census/noncensus water, Denied access, or Not in the sample area, record the change in condition class status at that point on the transect.

### 10.1 GROUND COVER MEASUREMENTS

#### 10.1.1 Subplot Number (PNW)

Record a 2-digit code indicating the subplot center from which the transect originates. Use the procedures described in Section 5.1.1.

#### 10.1.2 Transect (PNW)

Record a 3-digit code indicating the transect on which Ground Cover is being measured.

When collected:	All tally segments	
Field width:	3-digits	
Tolerance:	No errors	
Values:	<u>Code</u>	<u>Definition</u>
	030	Transect extends 30 degrees from subplot center
	150	Transect extends 150 degrees from subplot center
	270	Transect extends 270 degrees from subplot center

#### 10.1.3 Segment ID (PNW)

Starting at 4 feet slope distance from plot center, the 10 foot segments are numbered 1-2 out to the edge of the subplot. Record the appropriate segment number (1 or 2), based on the slope distance from point center as:

When collected:	All tally segments	
Field width:	1-digit	
Tolerance:	No errors	
Values:	<u>Segment</u>	<u>Slope Distance</u>
	1	4.0-14.0 feet
	2	14.0-24.0 feet

**10.1.4 Ground Cover Type (PNW)**

Record the appropriate ground cover code for cover types found on each transect segment. Select ground cover items that are visible when looking down for items in contact with the ground (e.g., a log suspended 1' above the ground over the transect does not count as ground cover). In order to get an accurate portrayal of ground cover; cover of basal portions of forbs, grass clumps, trees, and woody shrubs, plus any other non-vegetation cover must all add up to 100 percent for each segment along the transect. Select ground layers in the order presented, top to bottom. At times items will overlay each other (e.g., MOSS over ROCK). When this occurs the portions of each item that are viewed from above is what will be selected and measured.

When col:	All tally segments	
Field width:	1-digit	
Tolerance:	No errors	
Values:	Code	Ground Cover Type
	LITT	Leaf and needle litter, and duff not yet incorporated into the decomposed top humus layer.
	WOOD	Woody Material, Slash & Debris: Any woody material, small and large woody debris, regardless of depth. Includes stumps. Litter is not included.
	LICH	An organism generally recognized as a single plant that consists of a fungus and an alga or cyanobacterium living in a symbiotic association. This code does not apply to lichen growing on bare soil in dry rangeland conditions. For rangeland conditions see cryptogamic crusts.
	MOSS	Nonvascular, terrestrial green plant, including mosses, hornworts, and liverworts. Always herbaceous. This code does not apply to moss growing on bare soil in dry rangeland conditions. For rangeland conditions see cryptogamic crusts.
	BARE	Exposed Soil: Bare soil, composed of particles less than 1/8 inch in diameter, which is not covered by rock, cryptogams, or organic material. Does not include any part of a road (see definition for road).
	CRYP	Thin, biotically dominated ground or surface crusts on soil in dry rangeland conditions; e.g. cryptogamic crust (algae, lichen, mosses or cyanobacteria).
	ROCK	Relatively hard, naturally formed mineral or petrified matter greater than 1/8 inch in diameter appearing on the soil surface, as small to large fragments, or as relatively large bodies, cliffs, outcrops or peaks. Includes bedrock.
	BAVE	The basal area cover, at ground surface, of any plants occupying the ground surface area. Includes any trees, shrubs, basal grasses, and forbs (live, or senesced from the current year). Senesced = live during the current year's growing season, but now dead
	WATE	Water is coded where the water table is above the ground surface during the growing season, such as streams, bogs, swamps, marshes, and ponds.
	ROAD	Includes improved roads used to assign condition class, which are generally constructed using machinery, and is the area where the original topography has been disturbed by cutbanks and fill. Also includes unimproved trails impacted by regular use of motorized machines (e.g. motorcycles, jeeps, and ORV's). Non-motorized trails and unimproved traces, and roads created by occasional use for skidding logs are not included
	DEVP	Surface area occupied or covered by any man-made structure other than a road, such as a building, dam, parking lot, electronic site/structure.
	ASH	Residue after wood and other combustible material has been burned off.
	TEPH	All material formed by volcanic explosion or aerial expulsion from a volcanic vent, such as tephra, or pyroclastic material.
	PEIS	Surface area covered by ice and snow at the time of plot measurement, considered permanent.
	TRIS	Surface area covered by ice and snow at the time of plot measurement, considered transient.
NOIN	Non-inventoried condition classes: Census water, Hazardous, Access denied, or Not in the Sample	

**10.1.5 Cover (PNW)**

Estimate the percent cover of each item from one edge to the other as it is intersected by the transect section. Remember to view the ground layer in the absence of aerial vegetation for purposes of measurement. Record the accumulated cover for each ground item within a ten-foot section of the transect to the nearest 1% (0.1 foot on a 10 foot section equals 1% cover). Note: Within each section the accumulated covers for all ground items must equal 100%.

When collected:	All tally segments
Field width:	2-digits
Tolerance:	+/- 5% for each item on a segment
Values:	0 to 99





# APPENDICES

## TABLE OF CONTENTS

<b>APPENDIX 1</b>	<b>NATIONAL FOREST PLOTS SPECIAL RULES.....</b>	<b>A1</b>
A1.1	HECTARE PLOT ON NATIONAL FOREST LANDS .....	A1
	Mapping Hectare Condition Classes on R5 National Forest Lands.....	A1
	Mapping Hectare Condition classes on R6 National Forest Lands .....	A1
A1.2	NONFOREST CONDITION CLASS EXCEPTIONS ON NATIONAL FOREST LANDS.....	A1
A1.3	MONUMENTING WILDERNESS AREAS.....	A4
A1.4	GROUND COVER ON NFS LANDS .....	A4
A1.5	PREVIOUSLY USED REFERENCES, PROCEDURES, AND CODES .....	A4
	R1 (Idaho) and R4 (Nevada).....	A4
	A. Old RM Plot Layouts .....	A4
	R5 (CALIFORNIA).....	A5
	A. R5 National Forest and Ranger District Codes.....	A5
	B. R5 Periodic Survey Tree Type Measurement Codes (Used in R5 past data only).....	A7
	C. REGION 5 Periodic Survey plot vegetation profile information (Used in R5 past data only) .....	A8
	D. Prism Factors used on past R5 Survey plots: 20 or 40 BAF.....	A9
	E. R5 Past Survey Plot Designs .....	A10
	R6 (OREGON, WASHINGTON).....	A11
	A. R6 Past Survey Plot Designs (CVS).....	A11
A1.6	NATIONAL FOREST AND RANGER DISTRICT INFORMATION.....	A12
	REGION 4 .....	A12
	REGION 4 Nevada: National Forest and Ranger District Location Information .....	A12
	REGION 5 .....	A12
	REGION 5 California: National Forest and Ranger District Location Information .....	A12
	R5 National Forest Contacts for FIA (updated 2006 by K. Casey).....	A14
	REGION 6 .....	A15
	REGION 6 Oregon: National Forest and Ranger District Location Information .....	A15
	REGION 6 Washington: National Forest and Ranger District Location Information .....	A16
A1.7	REFERENCE TABLES FOR FIA PLOTS ON NATIONAL FOREST LANDS .....	A17
	A. R5 Survey Tree Species Codes and Current PNW-FIA Annual Tree Species Equivalent .....	A17
	B. R5 Weed List.....	A18
	C. R6 Plant Indicator and Weed Species Lists .....	A18
A1.8	CHAPARRAL SPECIAL RULES FOR R5 NATIONAL FOREST LANDS.....	A41
	A. Introduction to Chaparral .....	A41
	B. Chaparral Plot Installation and Layout Rules .....	A41
	C. Chaparral Procedures.....	A42
<b>APPENDIX 2</b>	<b>OUTSIDE NATIONAL FORESTS .....</b>	<b>A47</b>
A2.1	THE INVENTORY OF CALIFORNIA .....	A47
	California Background.....	A47
	History of Survey Occasion dates in California: .....	A47
	California Inventory Design.....	A47
	PNW past Occasion 3 Plot layout in California .....	A48
A2.2	THE INVENTORY IN OREGON AND WASHINGTON.....	A48
	Oregon/Washington Background.....	A48
	Oregon/Washington Inventory design.....	A48
	Oregon/Washington Previous plot layouts.....	A50
A2.3	PNW TREE HISTORY CODES AND DEFINITIONS FROM THE PAST PERIODIC INVENTORIES ...	A52
A2.4	FOREST HEALTH MONITORING PROGRAM .....	A52
	California Forest Health Monitoring Program .....	A52
	Oregon/Washington Forest Health Monitoring Program .....	A52
A2.5	ADDITIONAL SOURCES OF DOCUMENTATION.....	A53
	California .....	A53
	Oregon and Washington.....	A53
A2.6	MONUMENTING WILDERNESS AREAS.....	A53
	Monumenting within Wilderness Areas on BLM Lands.....	A53

Monumenting within National Park Service Wilderness Areas .....	A53
A2.7    SUDDEN OAK DEATH (SOD) SYNDROME ASSESSMENT IN CALIFORNIA.....	A54
<b>APPENDIX 3    PLANT ASSOCIATION AND COUNTY .....</b>	<b>A55</b>
A3.1    WASHINGTON COUNTY KEY.....	A55
A3.2    WASHINGTON PLANT ASSOCIATION GUIDES.....	A55
NW Washington.....	A55
SW Washington .....	A56
NE Washington.....	A56
A3.3    OREGON COUNTY KEY .....	A58
A3.4    OREGON PLANT ASSOCIATION GUIDES .....	A59
NW Oregon.....	A59
SW Oregon.....	A59
CE Oregon .....	A59
NE Oregon .....	A60
A3.5    CALIFORNIA.....	A65
A3.6    CALIFORNIA PLANT ASSOCIATION GUIDES .....	A65
<b>APPENDIX 4    PREVIOUS GROUND LAND CLASS .....</b>	<b>A67</b>
<b>APPENDIX 5    REFERENCE INFORMATION .....</b>	<b>A69</b>
A5.1    STATE CODES.....	A69
A5.2    COUNTY CODES AND DECLINATIONS .....	A69
California County Codes.....	A69
Oregon County Codes.....	A70
Washington County Codes.....	A71
Nevada County Codes.....	A71
Idaho County Codes.....	A72
A5.3    SLOPE CORRECTION TABLE.....	A72
A5.4    METRIC EQUIVALENTS AND AIDS .....	A73
<b>APPENDIX 6    COORDINATES (GPS) .....</b>	<b>A75</b>
A6.1    OVERVIEW.....	A75
A6.2    WHEN AND WHERE TO COLLECT READINGS .....	A75
A6.3    RECORDING GPS INFORMATION .....	A75
A6.4    GPS KEYPAD LAYOUT AND COMMANDS .....	A76
GPS Keypad Commands.....	A76
A6.5    GPS SETUP OPTIONS.....	A77
NAVIGATION SCREENS .....	A77
Setup Units.....	A77
Customizing Navigation Screens .....	A77
A6.6    OPERATING THE GPS ON PLOT .....	A78
A6.7    COLLECTING COORDINATES AWAY FROM PLOT CENTER.....	A80
A6.8    WAYPOINTS (ADVANCED GPS USE) .....	A80
A6.9    NAVIGATING WITH THE GPS (ADVANCED GPS USE).....	A81
A6.10   BATTERIES .....	A82
<b>APPENDIX 7    LASER 200 INSTRUCTIONS.....</b>	<b>A83</b>
A7.1    OVERVIEW.....	A83
A7.2    BASIC OPERATION.....	A83
A7.3    SETTINGS .....	A83
A7.4    FILTER AND REFLECTORS .....	A84
A7.5    DISTANCE AND % SLOPE.....	A84
A7.6    TREE HEIGHTS .....	A84
A7.7    GATES .....	A84
A7.8    CUMULATIVE DISTANCES .....	A85
<b>APPENDIX 8    FOREST TYPE CODES .....</b>	<b>A87</b>
<b>APPENDIX 9    TREE SPECIES LISTS.....</b>	<b>A91</b>
<b>APPENDIX 10   DISEASE KEYS.....</b>	<b>A99</b>

A10.1	ROOT DISEASE IDENTIFICATION AIDS:.....	A99
	General Root Disease Symptoms.....	A99
	Individual Disease Descriptions:.....	A99
	Listing of Disease-Tolerant Species by Root Disease:.....	A100
<b>APPENDIX 11 DETERMINATION OF STOCKING VALUES FOR LAND USE CLASSIFICATION.....</b>		<b>A101</b>
A11.1	STOCKING VALUES FOR ALL TALLIED TREES ON THE FOUR SUBPLOTS AND MICROPLOTS .....	A104
A11.2	STOCKING VALUES FOR ALL TREES TALLIED ON THE SUBPLOT ONLY .....	A105
A11.3	STOCKING VALUES FOR ALL TREES < 7 INCHES, OBSERVED ON THE FOUR SUBPLOTS ONLY .....	A106
A11.4	STOCKING VALUES FOR ALL TREES 5.0 INCHES AND GREATER OBSERVED ON THE FOUR SUBPLOTS ONLY ....	A107
A11.5	DBH OF THE LARGEST TALLY TREE IN THE CONDITION .....	A108
A11.6	STOCKING VALUES FOR ALL TREES 5.0 INCHES AND GREATER OBSERVED ON ONE ACRE.....	A109
A11.7	MINIMUM NUMBER OF TREES PER ACRE FOR FOREST LAND BASED ON LARGEST TALLY TREE .....	A110
<b>APPENDIX 12 CORRESPONDENCE AND CONTACT EXAMPLES.....</b>		<b>A111</b>
A12.1	HELLO LETTER/DATA CONFIDENTIALITY .....	A111
A12.2	INTERIM LOCATION CONFIDENTIALITY POLICY .....	A112
	Summary of FIA privacy (confidentiality) policy .....	A112
	Conversation scenarios.....	A112
	References.....	A114
A12.3	ACCESS TO EXACT COORDINATES FOR FIA PLOTS .....	A115
	ACCESS TO EXACT COORDINATES ON PUBLIC LAND .....	A115
	ACCESS TO EXACT COORDINATES ON PRIVATE AND TRIBAL LAND .....	A116
A12.4	CONFIDENTIALITY CERTIFICATION .....	A117
A12.5	SAMPLE MEMORANDUM OF UNDERSTANDING.....	A120
A12.6	NEW LEGISLATION ON PRIVACY FOR FIA DATA AND INFORMATION .....	A122
A12.7	LANDOWNER CONTACT LETTER .....	A127
A12.8	LIABILITY LETTER.....	A128
<b>APPENDIX 13 QUALITY ASSURANCE/QUALITY CONTROL.....</b>		<b>A129</b>
A13.1	CHECK PLOTS .....	A129
	Objectives: Check Plots are Performed for Several Purposes: .....	A129
	Check Plot Policies: The following policies for conducting check plots will be followed:.....	A129
	Types of Check Plots: .....	A129
	Check Plot Procedures: .....	A129
A13.2	2005 BLIND PLOT PROTOCOL .....	A129
	What are blind plots? .....	A129
	Blind Plot Selection .....	A130
	State Coordinator Protocols .....	A130
	Field Procedures.....	A131
<b>APPENDIX 14 GUIDELINES, TOLERANCE TABLES, PLOT FORMS .....</b>		<b>A133</b>
A14.1	TREE CODING GUIDE FOR RECONCILE .....	A133
A14.2	TOLERANCES.....	A136
A14.3	PLOT CARD .....	A137
A14.4	PLOT CARD WRITE-UP.....	A139
A14.5	PLOT ATTRIBUTE DATA FORM.....	A140
A14.6	CONDITION CLASS ATTRIBUTES DATA FORM.....	A141
A14.7	SUBPLOT ATTRIBUTE DATA FORM .....	A142
A14.8	MICRO-PLOT ATTRIBUTES DATA FORMS .....	A143
A14.9	SITE TREE DATA FORM.....	A144
A14.10	VEGETATION PROFILE AND SEEDLING COUNT DATA FORM .....	A145
	VEGETATION PROFILE and SEEDLING COUNT DATA FORM, CONTINUED .....	A146
A14.11	TRACKABLE TREE AND SNAG DATA FORM .....	A147
A14.12	WOODLAND STEM DIAMETER DATA FORM.....	A150
A14.13	DOWN WOODY MATERIAL DATA FORMS .....	A151
	COARSE WOODY MATERIAL DATA FORM .....	A151
	CWM TRANSECT SEGMENTS .....	A152
	RESIDUE PILES .....	A152
	FINE WOODY MATERIALS and DUFF, LITTER, FUELBED DEPTH DATA FORMS.....	A153
	DUFF, LITTER, & FUELBED DEPTHS.....	A153

GROUND COVER DATA FORM.....	A154
<b>APPENDIX 15 GLOSSARY .....</b>	<b>A155</b>
<b>APPENDIX 16 IMPORTANT PHONE NUMBERS.....</b>	<b>A159</b>
A16.1 PNW-FIA .....	A159
A16.2 CALIFORNIA .....	A161
A16.3 OREGON.....	A162
A16.4 WASHINGTON .....	A163
<b>APPENDIX 17 SUMMARY OF MANUAL CHANGES FROM 2006 .....</b>	<b>A165</b>
<b>APPENDIX 18 BLANK PAGE FOR NOTES .....</b>	<b>A169</b>

## APPENDIX 1 NATIONAL FOREST PLOTS SPECIAL RULES

### A1.1 HECTARE PLOT ON NATIONAL FOREST LANDS

A hectare plot (185.1 ft. fixed-radius plot from the center of subplot 1) is one hectare in size and encompasses the 4 annual inventory macroplots (Figure 1-1). Hectare plots are established to tally additional very large trees, and are installed when the center of subplot 1 is located on R6 land in Washington, Oregon, or California or on R5 and BLM land within the Northwest Forest Plan area in California. Hectare plots are installed when at least one accessible forest or nonforest condition exists on the plot. For remeasurement plots (SAMPLE KIND = 2), do not tally, map or otherwise remeasure on the hectare in 2007.

Note: hectare plots are NOT installed on R1 or R4 NFS lands.

#### Hectare Tree Definitions

In addition to normal tree tally rules, very large trees meeting the following criteria are sampled on the hectare plot.

1.  $\leq 185.1$  ft horizontal distance from subplot 1 to the center of the tree at its base
2. located in an accessible (forest or nonforest) condition class on R6 land and on R5 or BLM land within the NWFP.
3. DBH  $\geq 32.0$  in. ("east" side plots) or  $\geq 48.0$  in. ("west" side plot) See Appendix A5.2 for E/W designation.
4. standing tree (live or dead)

Hectare trees within a macroplot radius must be referenced to that macroplot center. Hectare tally trees that are not within a macroplot radius, but are in the hectare plot radius, are referenced to the closest subplot center. The electronic data recorder will determine, based on the active subplot and the azimuth entered, whether a tree falls within another macroplot. It will force the user to reference the tree from the appropriate subplot. It will also determine if the tree is outside of the 185.1 ft radius circle. To assure that the hectare trees are in/out of the plot, measure the horizontal distance of borderline trees from plot center. When no hectare trees are tallied on a given subplot, the data recorder program will query the user upon editing the tree screen, to confirm no hectare tally trees present on the subplot.

#### If a plot straddles a boundary between NFS and other ownership:

- Plot center is located on R5 or R6 land – establish and measure the hectare plot on NFS and non-NFS lands.
- Plot center is located off NFS – do not establish or measure the hectare portion of the plot.

#### Mapping Hectare Condition Classes on R5 National Forest Lands

Only additional accessible forest condition classes present within the 185.1 ft radius hectare plot that contain a hectare tally tree that can not be tied to an existing delineated condition class are mapped on Region 5 National Forest lands. Attributes for condition classes mapped on the hectare are the same as other delineated condition classes. Measured boundary values are entered into the electronic data recorder under Subplot Attributes, submenu: BOUNDARY MAPPING.

#### Mapping Hectare Condition classes on R6 National Forest Lands

Map all condition classes present within the 185.1 ft radius hectare plot on Region 6 National Forest lands. Attributes for condition classes mapped on the hectare are the same as other delineated condition classes. Measured boundary values are entered into the electronic data recorder under Subplot Attributes, submenu: BOUNDARY MAPPING.

### A1.2 NONFOREST CONDITION CLASS EXCEPTIONS ON NATIONAL FOREST LANDS

When plots are located on R5 and R6 NFS lands, nonforest conditions are tallied, mapped and measured as described in this section. Nonforest condition classes are not measured on R1 or R4 NFS land).

#### If a plot straddles a boundary between NFS and private land:

- If the center of subplot 1 is located on R5 or R6 National Forest land, measurements are taken in all accessible (forest and nonforest) condition classes on that plot (all 4 macroplots)

## Annual Inventory 2007, Appendix 1: National Forest Plots Special Rules

- If the center of subplot 1 is located on private land, do not collect the measurements below on nonforest conditions (measure the plot as if it were totally non-NFS ownership).

If the plot is a remeasurement plot (SAMPLE KIND = 2):

- Remeasure all accessible (forest and nonforest) conditions when PLOT STATUS = 1 (At least one accessible forest land condition present on plot).
- If no accessible forest conditions exist on the plot (PLOT STATUS = 2), do not remeasure the plot in 2007.

The following measurements are collected for accessible nonforest condition classes (CONDITION CLASS STATUS = 2) on R5 and R6 lands:

### **PLOT DATA (Chapter 3)**

#### 3.1 Time Spent Plot

All variables in this section are collected.

#### 3.2 Reference Point Attributes

All variables in this section are collected.

#### 3.3 Plot Attributes Downloaded to the PDR

All variables in this section are downloaded in the PDR.

#### 3.4 Plot Attributes Collected in the Field

All variables in this section are collected

LANDOWNER PLOT SUMMARY REQUEST – 0 for NFS lands

#### 3.5 Data Items Recorded on the Plot Card

The plot card must be filled out completely and correctly

### **CONDITION CLASS ATTRIBUTES (Chapter 4)**

#### 4.1 Determination of Condition Class - same

#### 4.2 Condition Class Status Definitions

2. Nonforest land is the only valid Condition Class Status for these conditions.

#### 4.3 Condition Class Attributes - same

#### 4.4 Determining Condition Class Status

All variables in this section are collected

CONDITION CLASS STATUS - Code 2 (Nonforest land)

#### 4.5 Delineating Condition Classes on Accessible Forest Land

RESERVE STATUS - collected  
OWNER GROUP - collected  
FOREST TYPE – not collected  
STAND SIZE CLASS - not collected  
REGENERATION STATUS - not collected  
TREE DENSITY - not collected

#### 4.6 Non-Delineating Variables for Accessible Forest Land

CURRENT GROUND LAND CLASS - not collected  
OWNER CLASS - collected  
PRIVATE OWNER INDUSTRIAL STATUS - not collected  
ARTIFICIAL REGENERATION SPECIES - not collected  
STAND AGE and 4.6.6 STAND STRUCTURE - not collected  
DISTURBANCE and TREATMENT (both current and historical) - not collected  
EVIDENCE OF STUMPS, 4.6.32 EVIDENCE OF FIRE - not collected

CONDITION CLASS - collected  
PHYSIOGRAPHIC CLASS - collected  
SOIL DEPTH - not collected  
STAND CONDITION/STAGE OF DEVELOPMENT – not collected  
PLANT ASSOCIATION - collected using the appropriate guide book  
MIXED CONIFER SITE – not collected  
STOCKABILITY INDICATOR SET NUMBER – not collected

#### 4.7 Non-Forest Lands

PRESENT NON-FOREST LAND USE - collected

### **SUBPLOT ATTRIBUTES (Chapter 5)**

#### 5.1 Subplot Identification

All variables in this section are collected in nonforest conditions

#### 5.2 Physiographic Class Information

All variables in this section are collected in nonforest conditions

#### 5.3 Water Information

All variables in this section are collected in nonforest conditions

#### 5.4 Microplot Attributes

All variables in this section are collected in nonforest conditions

#### 5.5 Boundary Reference Mapping:

All variables in this section are collected in nonforest conditions

BOUNDARY CHANGE - collected when Sample Kind = 2

#### 5.6 NonForest Inclusion (Mapping/Recording) - not collected

#### 5.7 Root Disease Mapping/Rating - collected

#### 5.8 Subplot Disturbance – not collected (collected ONLY with chaparral protocol (See Section A1.7))

### **DOWN WOODY MATERIALS (Chapter 6)**

All variables in this section are collected in nonforest conditions

### **LIVE AND STANDING DEAD TREE TALLY (Chapter 7)**

Use the rules in Section 7.1 Selecting Tally Trees to determine when to tally a tree that is present in a nonforest condition. All other tree measurements apply when tallying trees in nonforest conditions according to the procedures outlined in Chapter 7.

MORTALITY AND GROWTH ASSESSMENT FROM PREVIOUS OCCASION: collected on R5 land when SAMPLE KIND = 1. Do not collect on R6 land.

### **VEGETATION PROFILE (Chapter 8)**

#### 8.1 Vegetation Plot Design

Measure the Vegetation Profile on the 24-foot radius subplot in forest and nonforest conditions if greater than 50% of the subplot contains accessible forest/nonforest land.

#### 8.2 Species Records

All variables in this section are collected in nonforest conditions

#### 8.3 Lifeform and Total Vegetation Records: All variables in this section are collected in nonforest conditions

#### 8.4 Collection and Identification of Unknown Plants - collected

#### 8.5 Indicator and Weed Lists - collected

### **SITE INDEX (Chapter 9)**

All measurements in Chapter 9 are dropped from nonforest plots.

### **GROUND COVER ON NFS LANDS (Chapter 10):**

All variables in this chapter are collected in nonforest conditions

## **A1.3 MONUMENTING WILDERNESS AREAS**

1. Plot center (point #1) is monumented with a cedar stake and/or a rock cairn.
2. Subplot 1 is referenced from two permanent witness features (trees or rocks), no rounds or squares used. The microplot is not monumented with a metal pin.
3. The RP is not monumented.
4. Subplot 2-4 centers are monumented with a regular metal pin, rounds painted brown, black, or grey, and, where rocks available, rock cairns used to obscure these markers on the ground. Remember to make natural appearing cairns, to hide the monumentation.
5. All tally trees over 5" DBH are tagged with brown, black, or grey painted aluminum tree number tags and nails at the base, and at DBH. Mark tally saplings over 3" DBH with similarly painted nail at DBH.
6. Upon completion the crew prepares a very detailed plot diagram, showing RP's, other physical features, and a well defined route-to-plot narrative to facilitate relocation and to mitigate the lack of visual reference points normally used to reference plots.

## **A1.4 GROUND COVER ON NFS LANDS**

If the center of any subplot is in R6 or R5 National Forest, ground cover is measured on all accessible forest and nonforest condition classes on that subplot. Follow the instructions in Chapter 10.

## **A1.5 PREVIOUSLY USED REFERENCES, PROCEDURES, AND CODES**

### **R1 (Idaho) and R4 (Nevada)**

PNW field crews measure plots on R1 NFS land in Washington (Idaho Panhandle NF) and R4 NFS land in California (Toiyabe NF). Established Annual inventory plots (4-subplot footprint) on these forests were initially installed by crews from either PNW or RMRS Regions, using the protocol from their respective Region (Note: R1/R4 crews do not use declination). Determine whether the plot was installed using declination (check the azimuth from plot center to subplots 2, 3, and 4), and measure the plot and tally the trees using the protocol by which the plot was installed; do not move subplots. PNW crews will install new Annual inventory plots (SAMPLE KIND = 1) at the old periodic plot center (if the plot was visited at a previous inventory) and measure the plot using declination. Plots on these National Forests are only considered remeasurement plots (SAMPLE KIND = 2) when previous data are available (established by PNW crews) in the PDR.

### **A. Old RM Plot Layouts**

In the previous inventory, the Sampling Factor designated the plot layout and sampling system used. For plots with the Sampling Factor coded as a 20 or 40, a 5-point, 7-point, or 10-point variable radius timberland plot was established. On locations with the Sampling Factor coded as 01, 02, 05, 91, 92, or 95, a fixed-radius woodland plot was established.

#### **Variable-Radius Plots.**

The LC was designated as point 1 of 5, 7, or 10 points on the plot. Points 2 through 5, 7, or 10 were distributed around the PC, and within the condition of the PC, using a triangular grid pattern with 100-foot or 70-foot intervals (Figure A1-1).

In the previous inventory, when points 2 through 5, 7, or 10 fell into vegetation conditions different than the condition at the PC, those points were redistributed back into the PC condition. At each of the points, timber species 5.0-inches DBH and larger, and woodland species 3.0-inches DRC and larger, were tallied on a variable-radius main plot; a 20 or 40 basal area factor (BAF) angle gauge, depending on forest type, was used to select tally



trees. In addition, saplings were tallied or counted, and seedlings were counted, on a 1/300 acre fixed-radius microplot centered on the point stake.

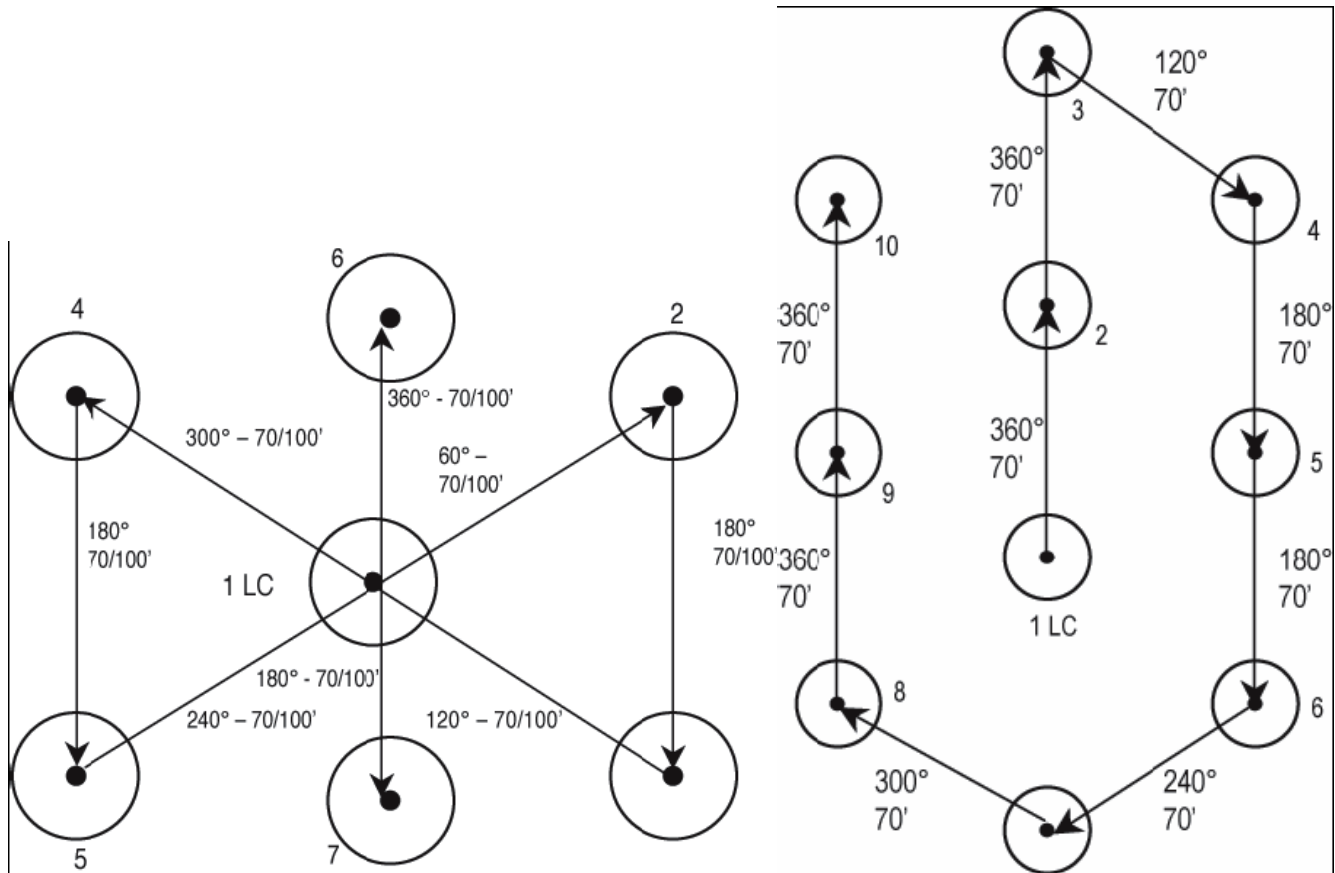

Figure A1-1. Previous variable-radius plot layouts.

Fixed-Radius Plots

In general, fixed-radius plots were used to sample locations consisting of woodland tree species; however, some inventories used fixed-radius plots to sample locations consisting of timber species. The LC was the center point of a fixed-radius circular plot.

R5 (CALIFORNIA)

A. R5 National Forest and Ranger District Codes

- Used to identify Plots on National Forest Lands (Used in R5 past data only)

<b>Code</b>	<b>Forest</b>	<b>Code</b>	<b>Forest</b>
1	Angeles	10	Six Rivers
2	Cleveland	11	Plumas
3	Eldorado	12	San Bernardino
4	Inyo	13	Sequoia
5	Klamath	14	Shasta-Trinity
6	Lassen	15	Sierra
7	Los Padres	16	Stanislaus
8	Mendocino	17	Tahoe
9	Modoc	19	Lake Tahoe Basin

Annual Inventory 2007, Appendix 1: National Forest Plots Special Rules

- Used to Identify Ranger District Codes (Used in R5 past data only):

<b>National Forest (Administered)</b>	<b>Ranger District</b>	<b>Ranger District Number</b>
Angeles	Los Angeles River	51
	San Gabriel	52
	Santa Clara/Mojave Rivers	53
Cleveland	Trabuco	52
	Palomar	53
	Descanso	54
Eldorado	Amador	51
	Georgetown	53
	Pacific	55
	Placerville	56
	Placerville Nursery & Forest Genetics Lab	57
Inyo	Mono Lake	51
	Mammoth	52
	White Mountain	53
	Mt. Whitney	54
Klamath	Oak Knoll	51
	Happy Camp	52
	Salmon River	54
	Scott River	55
	Gooseneck	57
	Ukonom	58
Lassen	Almanor	51
	Hat Creek	53
	Eagle Lake	58
Los Padres	Monterey	51
	Santa Lucia	53
	Santa Barbara	54
	Ojai	55
	Mt. Pinos	57
Mendocino	Corning	51
	Chico Tree Improvement	52
	Stonyford	53
	Upper Lake	54
	Covelo	56
Modoc	Warner Mt.	53
	Big Valley	54
	Devil's Garden	55
	Doublehead	56
Six Rivers	Gasquet	51
	Orleans	52
	Lower Trinity	53
	Mad River	54
	Humboldt Nursery	69
Plumas	Beckwourth	51
	Mount Hough	52
	Feather River	53
San Bernardino	Arrowhead	51
	Big Bear	52
	Cajon	53
	San Gorgonio	54
	San Jacinto	55
Sequoia	Hume Lake	51

Annual Inventory 2007, Appendix 1: National Forest Plots Special Rules

	Tule River	52
	Hotsprings	53
	Greenhorn	54
	Cannell Meadow	56
Shasta-Trinity	Yolla Bolla	51
	Hayfork	52
	Big Bar	54
	Weaverville	56
	Shasta Lake	58
	Mt. Shasta	59
	McCloud	61
Sierra	Mariposa	51
	Pineridge	53
	Kings River	54
	Minarets	55
	San Joaquin Exp.Ranger	56
Stanislaus	Mi-Wok	51
	Calaveras	52
	Summit	53
	Groveland	54
Tahoe	Downieville	53
	Foresthill	54
	Nevada City	55
	Sierraville	56
	Truckee	57
Lake Tahoe Basin	Lake Tahoe Basin	51

**B. R5 Periodic Survey Tree Type Measurement Codes (Used in R5 past data only)**

The type of record for each item that was measured or tallied on each subplot.

<b><u>Code</u></b>	<b><u>Record Type</u></b>
P	Prism tree record
M	Measured tree record for prism plot
N	Measured tree record for fixed area plot
S	Seedling record for fixed area plot
F	Fixed area plot tree/snag record
D	Down log record for fixed area plot
R	Root collar record for fixed area plot
X	Non-stockable plot

Type "S" records show the number of seedlings that exist on that point. This number would be "0" if no seedlings exist on the point and the area is capable of growing trees (does not qualify as non-stockable). If the point is non-stockable, an X was recorded.

Even if a point had no tree or down log records at all, as a minimum the point must have had either a null seedling record ("S" record with zero in the tree number field), or an "X" record. This assures that the point was counted in the statistics and not dropped.

Sample of R5 Survey Tree Data Sheet

Record Type	Subplot	R5 Plot #	Previous Date	Elevation
A 03 1	007 55 000 0000	111999 N - 5393 7 3 054 3 2		
D 1 001	125 31	L2 - 160 45		
D 1 002	125 31	L2 - 160 20		
D 1 003	125 13	L2 - 200 25		
D 1 004	125 31	L2 - 160 20		
D 1 005	125 31	L3 - 120 10		
S 1 000	10			
M 2 034	40 31 I 5 2 00 -	96 51 85 6 9		
P 2 035	40 11 D 3 0 00 -	192		
P 2 037	40 31 C 5 1 00 -	214		
P 2 038	40 31 I 5 3 00 -	120		
P 2 039	40 31 I 4 2 00 -	104		
P 2 040	40 51 S 4 0 00 -	63		
P 2 041	40 51 C 6 1 00 -	125		
S 2 010	10 51			
F 2 042	250 31 D 1 0 D4 -	400 25		
F 2 043	125 31 S 1 0 D3 -	60 20		
F 2 044	125 31 I 1 0 D3 -	100 15		
D 2 045	125 11	L3 - 100 15		

**C. REGION 5 Periodic Survey plot vegetation profile information (Used in R5 past data only)**

When seedlings and sapling size conifers and hardwood trees are collected in the tree samples on the Tree Plot Record, do not collect data on these species groups as part of the understory vegetation.

<u>Record Type:</u>	C	Conifer
	H	Hardwood
	B	Shrub (Brush)
	E	Herbaceous
	G	Grasses
	K	Special Features
	Z	Other

Point Number: Record the point number at which the information is being taken.

Plot Factor: Record the fixed plot code for the area being sampled. A 1/2 acre plot is usually used, and recorded as 500. Plot sizes other than 1/2 acre can be used where appropriate. Refer to Section 420, Field 4, Plot Factor for a complete list of plot factor codes.

Species: For each species group: conifer, hardwood, shrub (brush), herbaceous, and grasses, record the three most common species in order of prevalence.

Percent Cover: Record the percent cover on the plot. These should be recorded by cover classes

Height: Record the average height of the plants to the nearest foot for each species. Do not record the height of the ground cover component (herbaceous, grass, and other records)

Sample of R5 Survey Vegetation Data sheet

Forest	R5 Plot #	Previous Date	Elevation
V 03 1	007 55 000	0000 111999 N -	5393 7 3 054 3 2
B 01 000	0250 CEIN3	1 006 008	
B 01 000	0250 ARPA9	2 002 004	
B 01 000	0250 CECO2	2 004 004	
B 01 000	0250 RUPA2	2 007 001	
B 01 000	0250 SYMO	2 005 001	
B 01 000	0250 RIB	2 008 001	
B 01 000	0250 COST3	1 007 012	
E 01 000	0250 ADBI	- 001 001	
E 01 000	0250 UF	- 002 001	
E 01 000	0250 LUP2	- 002 001	
E 01 000	0250 SMST	- 001 001	
E 01 000	0250 CIR2	- 001 001	
E 01 000	0250 PTAQL	- 005 001	
E 01 000	0250 PYPI	- 001 001	
E 01 000	0250 LAT1	- 002 001	
E 01 000	0250 APO	- 001 001	
E 01 000	0250 HIE2	- 001 001	
E 01 000	0250 GAL3	- 002 001	
G 01 000	0250 UGA	- 001 000	
G 01 000	0250 UGP	- 002 000	
Z 01 000	0250 ROAD	- 025 000	
Z 01 000	0250 ROCK	- 010 000	

Record Type	Subplot	Plot Factor	Species	Percent Cover	Height
-------------	---------	-------------	---------	---------------	--------

**D. Prism Factors used on past R5 Survey plots: 20 or 40 BAF**

Limiting Distance tables for each factored prism of 20 and 40:

Limiting Distance = Factor X DBH;

BAF 20				BAF 40			
DBH	Dist in Feet	DBH	Dist in Feet	DBH	Dist in Feet	DBH	DIST in Feet
.01	.2	27	53.8	0.1	0.1	27	37.1
.2	.4	28	55.8	.2	.3	28	38.5
.3	.6	29	57.8	.3	.4	29	39.9
.4	.8	30	59.8	.4	.6	30	41.2
.5	1.0	31	61.8	.5	.7	31	42.6
.6	1.2	32	63.8	.6	.8	32	44.0
.7	1.4	33	65.8	.7	1.0	33	45.4
.8	1.6	34	67.8	.8	1.1	34	46.8
.9	1.8	35	69.8	.9	1.2	35	48.1
1	2.0	36	71.8	1	1.4	36	49.5
2	4.0	37	73.8	2	2.8	37	50.9
3	6.0	38	75.8	3	4.1	38	52.2
4	8.0	39	77.8	4	5.5	39	53.6
5	10.0	40	79.8	5	6.9	40	55.0
6	12.0	41	81.8	6	8.2	41	56.4
7	14.0	42	83.7	7	9.6	42	57.8
8	16.0	43	85.7	8	11.0	43	59.1

9	17.9	44	87.7	9	12.4	44	60.5
10	19.9	45	89.7	10	13.8	45	61.9
11	21.9	46	91.7	11	15.1	46	63.2
12	23.9	47	93.7	12	16.5	47	64.6
13	25.9	48	95.7	13	17.9	48	66.0
14	27.9	49	97.7	14	19.2	49	67.4
15	29.9	50	99.7	15	20.6	50	68.8
16	31.9	51	101.7	16	22.0	51	70.1
17	33.9	52	103.7	17	23.4	52	71.5
18	35.9	53	105.7	18	24.8	53	72.9
19	37.9	54	107.7	19	26.1	54	74.2
20	39.9	55	109.7	20	27.5	55	75.6
21	41.9	56	111.7	21	28.9	56	77.0
22	43.9	57	113.7	22	30.2	57	78.4
23	45.9	58	115.7	23	31.6	58	79.8
24	47.9	59	117.6	24	33.0	59	81.1
25	49.9	60	119.6	25	34.4	60	82.5
26	51.8			26	35.8		
Factor = 1.994				Factor = 1.375			

**E. R5 Past Survey Plot Designs**

**Various periodic R5 plot designs**

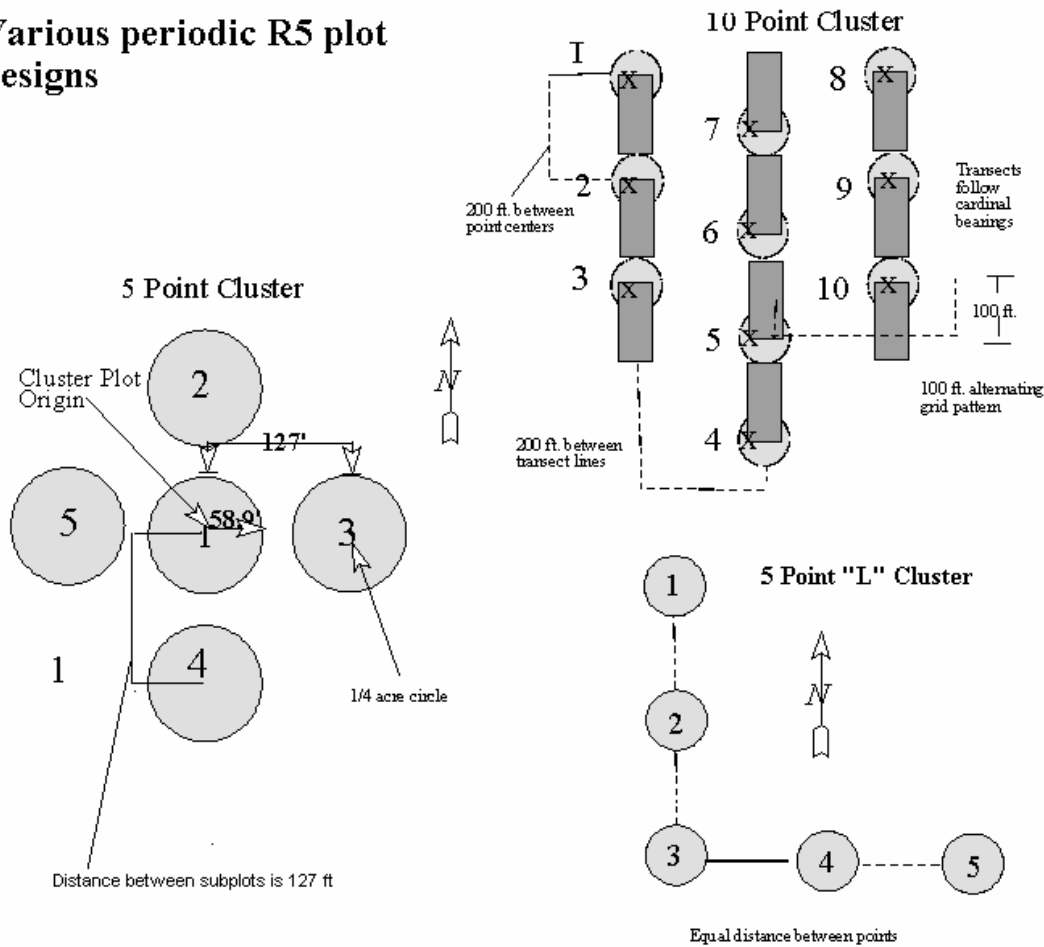

**Figure A1-2: R5 Past Plot Design**

Below are the various sampling radiuses that were used during the R5 Survey.

Plot Factor	Plot Size	Plot Dimensions
1000	1 acre (1.00)	
500	1/2 acre (.50)	66' X 330' rectangle
500	1/2 acre (.50)	83.3' radius circle
250	1/4 acre (.25)	66' X 165' rectangle
250	1/4 acre (.25)	33' X 330' rectangle
250	1/4 acre (.25)	58.9' radius circle
200	1/5 acre (.20)	52.7' radius circle
125	1/8 acre (.125)	33' X 165' rectangle
125	1/8 acre (.125)	41.6' radius circle
100	1/10 acre (.010)	37.2' radius circle
25	1/40 acre (.025)	18.6' radius circle
10	1/100 acre (.001)	11.8' radius circle

Note: Plot dimensions are in horizontal distances

**R6 (OREGON, WASHINGTON)**

**A. R6 Past Survey Plot Designs (CVS)**

Region 6 plots were installed using horizontal distances. Stake positions were located as shown in Figure A1-2. Stake position 1 represents the plot center. Stake positions 2 through 5 form an annular ring around stake position 1, each in a different cardinal direction and 133.9 feet distance from stake position 1.

Traverse offsets may have been used to navigate around obstructions and one or more of the stake positions may not have been installed if 1) A stake position is not on National Forest land, or 2) A stake position on National Forest land is not accessible by foot travel.

Stake positions were marked by a stake with an aluminum nail on the top of the stake to define the center of each circular subplot and the beginning of each planar subplot. A 10-inch length by 3/8th inch diameter piece of rebar was placed in the ground next to the stake unless a stake position falls on a road or trail.

Stake Position Reference: Stake positions are referenced by three items, including non-tally references in some cases. All references used to identify the stake position are monumented with a 3" by 3" aluminum tag (Figure A1-3). Each reference tag includes the following information: Reference type (SPR), PSU Number, Azimuth (from the stake position to the reference) and Distance (direct slope distance between the nail in the stake and the head of the nail affixing the aluminum number tag to each tally tree, or to the bottom nail of the aluminum reference tag on non-tally references). The aluminum tag is attached to each reference between ground level and 12 inches above ground level with two nails, and facing the stake position. Two orange tags are also attached to the stake position reference tree at DBH or eye level, one facing the plot stake and the other facing 180 degrees from the plot.

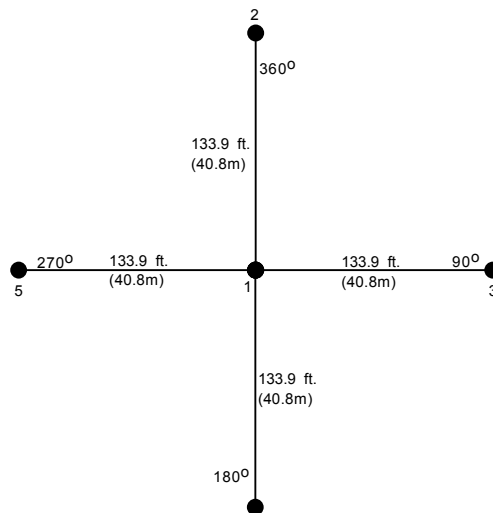

Figure A1-3: Locating stake positions 1-5 (Distance and cardinal directions from stake position 1)

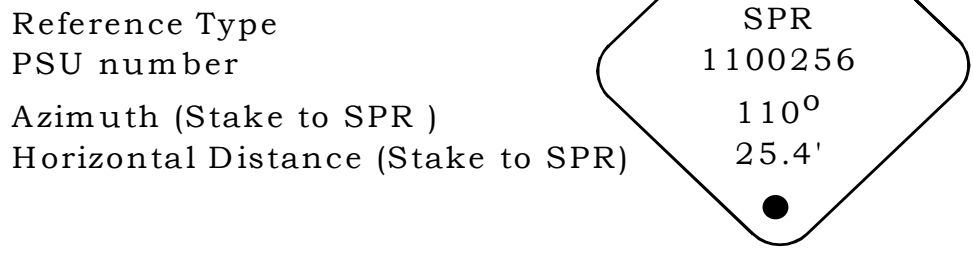

Figure A1-4: Stake Position Reference (SPR) tag.

## A1.6 NATIONAL FOREST AND RANGER DISTRICT INFORMATION

### REGION 4

#### REGION 4 Nevada: National Forest and Ranger District Location Information

<b>Humboldt Toiyabe National Forest SO...</b> Sparks	775-331-6444
Bridgeport,...Bridgeport	760-932-7070
Carson,...Carson City	775-882-2766

### REGION 5

#### REGION 5 California: National Forest and Ranger District Location Information

USDA Forest Service, Regional Office, R-5... Vallejo 707-562-8737

**Angeles National Forest SO...** Arcadia 626-574-1613  
 Los Angeles River, ... San Fernando 818-899-1900  
 San Gabriel River, ... Glendora 626-335-1251  
 Santa Clara/Mojave Rivers, ... Saugus 661-296-9710  
 Chilao Visitor Center,...La Canada 626-796-5541  
 Mt. Baldy Visitor Center,...Mt. Baldy 909-982-2829  
 Clear Creek Info Center,...La Canada 626-821-6764  
 Big Pines Info Center,...Wrightwood 760-249-3504

**Cleveland National Forest SO...** Rancho Bernardo 858-673-6180  
 Descanso, ... Alpine 619-445-6235  
 Palomar, ... Ramona 760-788-0250  
 Trabuco... Corona 909-736-1811

**Eldorado National Forest SO...** Placerville 530-622-5061  
 Amador, ... Pioneer 530-333-4312  
 Georgetown, ...Georgetown 209-295-4251  
 Pacific, ... Pollock Pines 530-644-2349  
 Placerville, ... Camino 530-644-2324

**Inyo National Forest SO...** Bishop 760-873-2400  
 Lee Vining,...Lee Vining 760-647-3044  
 Mammoth,... Mammoth Lakes 760-924-5500  
 White Mountain,... Bishop 760-873-2500  
 Mt. Whitney,... Lone Pine 760-876-6200  
 Interagency Visitor Center,... Lone Pine 760-876-6222  
 Mono Basin Scenic Visitor Center,... Lee Vining 760-873-2408



Annual Inventory 2007, Appendix 1: National Forest Plots Special Rules

Ancient Bristlecone Pine Forest Visitor Center	760-873-2500
<b>Klamath National Forest SO...Yreka</b>	530-842-6131
Happy Camp,... Happy Camp	530-493-2243
Goosenest,... Macdoel	530-398-4391
Ukonom,... Orleans	530-627-3291
Salmon River & Scott River, ... Fort Jones	530-468-5351
<b>Lake Tahoe Basin Management Unit ...South Lake Tahoe</b>	530-543-4036
<b>Lassen National Forest SO... Susanville</b>	530-257-2151
Almanor, ... Chester	530-258-2141
Eagle Lake, ... Susanville	530-257-4188
Hat Creek, ... Fall River Mills	530-336-5521
<b>Los Padres National Forest SO... Goleta</b>	805-968-6640
Monterey,... King City	831-385-5434
Mt. Pinos,...Frazier Park,	661-245-3731
Ojai... Ojai	805-646-4348
Santa Barbara,... Santa Barbara	805-967-3481
Santa Lucia,... Santa Maria	805-925-9538
<b>Mendocino National Forest SO... Willows</b>	530-934-3316
Covelo, ... Covelo	707-983-6118
Grindstone, ... Willows	530-934-3316
Stonyford, ...Stonyford	530-963-3128
Upper Lake, ... Upper Lake	707-275-2361
Genetic Resource & Conservation Center,... Chico	530-895-1176
Paskenta Work Center,... Paskenta	530-833-5544
Elk Creek Work Center,... Elk Creek	530-968-5329
<b>Modoc National Forest SO... Alturas</b>	530-233-5811
Warner Mountain, ... Cedarville	530-279-6116
Big Valley, ... Adin	530-299-3215
Devil's Garden, ... Alturas	530-233-5811
Doublehead, ... Tulelake	530-667-2246
<b>Plumas National Forest SO... Quincy</b>	530-283-2050
Beckwourth, ... Blairsden	530-836-2575
Feather River, ... Oroville	530-534-6500
Mt. Hough, ... Quincy	530-283-0555
<b>San Bernardino National Forest SO... San Bernardino</b>	909-382-2600
Big Bear, ... Fawnskin	909-866-3437
San Bernardino Work Center,...Lytle Creek	909-887-2576
San Jacinto, ... Idyllwild	909-382-2921
Arrowhead, ...Skyforest	909-382-2782
Mill Creek, ... Mentone	909-794-1123
Front Country,...Fontana	
<b>Sequoia National Forest SO... Porterville</b>	559-784-1500
Hume Lake, ... Dunlap	559-338-2251
Tule River/Hot Springs, ... Springville	559-539-2607
Greenhorn, ... Lake Isabella	760-379-5646
Cannell Meadow, ... Kernville	760-376-3781
Hot Springs,... California Hot Springs	661-548-6503
Bakersfield Visitor Center,... Bakersfield	661-391-6088

Annual Inventory 2007, Appendix 1: National Forest Plots Special Rules

<b>Shasta-Trinity National Forest SO...Redding</b>	530 226-2500
Yolla Bolla, ...Plantina	530-352-4211
Big Bar, ...Big Bar	530 623-6106
Hayfork, ... Hayfork	530-628-5227
Shasta Lake, ...Shasta Lake City	530-275-1587
Mt. Shasta, ...Mt. Shasta	530 926-4511
McCloud, ...McCloud	530-964-2184
Weaverville, ...Weaverville	530-623-2121
<b>Sierra National Forest SO... Clovis</b>	559-297-0706
Bass Lake, ...North Fork	559-877-2218
High Sierra, ...Prather	559-855-5355
<b>Six Rivers National Forest SO... Eureka</b>	707-442-1721
Smith River NRA, ...Gasquet	707-457-3131
Orleans, ... Orleans	530-627-3291
Lower Trinity, ... Willow Creek	530-629-2118
Mad River, ... Mad River	707-574-6233
<b>Stanislaus National Forest SO... Sonora</b>	209-532-3671
Calaveras, ... Hathaway Pines	209-795-1381
Groveland, ... Groveland	209-962-7825
Mi-Wok, ... Mi-Wuk Village	209-586-3234
Summit, ... Pinecrest	209-965-3434
<b>Tahoe National Forest SO... Nevada City</b>	530-265-4531
North Yuba, ...Camptonville	530-288-3231
American River, ...Foresthill	530-367-2226
Nevada City, ... Nevada City	530-265-4531
Sierraville, ... Sierraville	530-994-3401
Truckee, ... Truckee	530-587-3558
Big Bend Visitor Center, ... Soda Springs	530-426-3609

**R5 National Forest Contacts for FIA (updated 2006 by K. Casey)**

FOREST#	FOREST#	FOREST	CONTACT NAME	PHONE#	E-MAIL
1	501	Angeles	Clem Lagrosa	626-574-5256	clagrosa@fs.fed.us
2	502	Cleveland	Bernice Bigelow	858-674-2919	bbigelow@fs.fed.us
3	503	Eldorado	Mike Grimm	530-647-5382	mgrimm@fs.fed.us
4	504	Inyo	Tom Higley	760-647-3032	thigley@fs.fed.us
5	505	Klamath	Dan Blessing	530-398-5790	dblessing@fs.fed.us
6	506	Lassen	Dave Evans	530-252-6681	devans01@fs.fed.us
7	507	Los Padres	Jim Turner	805-961-5752	jmturner@fs.fed.us
8	508	Mendocino	Nancy Mulligan	530-934-1149	nmulligan@fs.fed.us
9	509	Modoc	Bill Schoeppach	530-233-8736	bschoeppach@fs.fed.us
10	510	Six Rivers	Roy Bergstrom	707-441-3553	rbergstrom@fs.fed.us
11	511	Plumas	Paul Stancheff	530-283-7843	pstancheff@fs.fed.us
12	512	San Bernardino	Mary Najera	909-382-2720	mnajera@fs.fed.us
13	513	Sequoia	Paul Miller	559-784-1500 x1151	psmiller@fs.fed.us
14	514	Shasta-Trinity	Robert Ramirez	530-226-2434	rramirez@fs.fed.us
15	515	Sierra	Mark Smith	559-297-0706 x4952	msmith04@fs.fed.us
16	516	Stanislaus	John Schmechel	209-532-3671 x329	jschmechel@fs.fed.us
17	517	Tahoe	Jerry Westfall	530-478-6297	jwestfall@fs.fed.us

Annual Inventory 2007, Appendix 1: National Forest Plots Special Rules

19	519	LTBMU	Scott Parsons	530-543-2687	sparsons@fs.fed.us
n/a	n/a	Region 5 RSL	Kevin Casey	916-640-1252	kcasey@fs.fed.us

**REGION 6**

**REGION 6 Oregon: National Forest and Ranger District Location Information**

USDA Forest Service, Regional Office, R-6... Portland

**Deschutes National Forest ... Leslie Weldon**, 1645 Highway 20 East, Bend, OR 97701  
Bend/Ft. Rock 1230 NE 3rd St. Suite A-262, Bend, OR 97701, 541-383-4000  
Crescent 136471 Hwy 97 North, PO Box 208, Crescent, OR 97733, 541-433-3200  
Sisters Hwy 20 & Pine St., PO Box 249, Sisters, OR 97759, 541-549-7700

**Fremont-Winema National Forests** 1301 South G Street, Lakeview, OR 97630, 541-947-2151 (Lakeview); 541-883-6714 (Klamath Falls)  
Bly 61100 Hwy. 140 East, PO Box 25, Bly, OR 97622, 541-353-2427  
Chemult 110500 Hwy. 97 North, PO Box 150, Chemult, OR 97731, 541-365-7001  
Chiloquin 38500 Highway 97 South, Chiloquin, OR 97624, 541-783-4001  
Klamath 1936 California Avenue, Klamath Falls, OR 97601, 541-885-3400  
Lakeview 18049 Hwy. 395, Lakeview, OR 97630, 541-947-3334  
Paisley 303 Hwy. 31, PO Box 67, Paisley, OR 97636, 541-943-3114  
Silver Lake 65600 Hwy 31, PO Box 129, Silver Lake, OR 97638, 541-576-2107

**Malheur National Forest** 431 Patterson Bridge Rd, PO Box 909, John Day, OR 97845, 541-575-3000;  
Blue Mountain PO Box 909, 431 Patterson Bridge Rd, John Day, OR 97845, 541-575-3000  
Emigrant Creek 265 Highway 20 South, Hines, OR 97738, 541-573-4300  
Prairie City 327 SW Front, PO Box 337, Prairie City, OR 97869, 541-820-3800

**Mt. Hood National Forest** 16400 Champion Way, Sandy, OR 97055, 503-668-1700  
Barlow 780 NE Court, Dufur, OR 97021, 541-467-2291  
Clackamas River 595 NW Industrial Way, Estacada, OR 97023, 503-630-6861  
Hood River 6780 Hwy 35, Mt.Hood-Parkdale, OR 97031, 541-352-6002  
Zigzag 70220 East Hwy. 26, Zigzag, OR 97049, 503-622-3191

**Ochoco National Forest** 3160 NE 3rd Street, Prineville, OR 97754-0490, 541-416-6500;  
Crooked River National Grassland 813 SW Hwy 97, Madras, OR 97741, 541-475-9272,  
Lookout Mountain 3160 NE 3rd St., PO Box 490, Prineville, OR 97754-0490, 541-416-6500,  
Paulina 7803 Beaver Creek Rd, Paulina, OR 97751-9706, 541-477-6900

**Rogue River-Siskiyou National Forest ... Scott Conroy**, Federal Building, 333 W. 8th Street, Box 520, Medford, OR 97501-0209, 541-858-2200  
Applegate 6941 Upper Applegate Rd, Jacksonville, OR 97530, 541-899-3800  
Ashland 645 Washington St., Ashland, OR 97520, 541-552-2900  
Butte Falls 800 Laurel St, PO Box 227, Butte Falls, OR 97522, 541-865-2700  
Chetco 555 5th Street, Brookings, OR 97415, 541-412-6000  
Galice 200 NE Greenfield Rd., Grants Pass, OR 97526, 541-471-6500  
Gold Beach 1225 South Ellensburg, PO Box 7, Gold Beach, OR 97444, 541-247-3600  
Illinois Valley 26568 Redwood Hwy, Cave Junction, OR 97523, 541-592-4000  
Powers Powers, OR 97466, 541-439-6200  
Prospect 47201 Hwy 62, Prospect, OR 97536, 541-560-3400

**Siuslaw National Forest** 4077 Research Way, PO Box 1148, Corvallis, OR 97339, 541-750-7000  
Hebo 31525 Hwy 22/PO Box 324, Hebo, OR 97122, 503-392-3161  
South Zone Ranger District 541-902-8526  
Waldport Office 1049 SW Pacific Hwy, PO Box 400, Waldport, OR 97394, 541-563-3211  
Florence Office 4480 Hwy 101, Bldg G - Florence, OR 97439, 541-902-8526

Annual Inventory 2007, Appendix 1: National Forest Plots Special Rules

Oregon Dunes NRA Office 855 Hwy 101, Reedsport, OR 97467, 541-271-3611

**Umatilla National Forest** 2517 SW Hailey Ave., Pendleton, OR 97801, 541-278-3716

Heppner 117 S. Main St., Heppner, OR 97836, 541-676-9187

North Fork John Day PO Box 158, Ukiah, OR 97880, 541-427-3231

Pomeroy 71 West Main St., Pomeroy, WA 99347, 509-843-1891

Walla Walla 1415 West Rose, Walla Walla, WA 99362, 509-522-6290

**Umpqua National Forest** 2900 NW Stewart Parkway, Roseburg, OR 97470, 541-672-6601

Cottage Grove 78405 Cedar Park Rd., Cottage Grove, OR 97424, 541-767-5001

Diamond Lake 2020 Toketee Ranger Sta. Rd, Idleyld Park, OR 97447, 541-498-2531

North Umpqua 18782 N. Umpqua Hwy, Glide, OR 97443, 541-496-3532

Tiller 27812 Tiller Trail Hwy, Tiller, OR 97484, 541-825-3201

**Wallowa-Whitman National Forest** 1550 Dewey Ave., PO Box 907, Baker City, OR 97814, 541-523-6391

Eagle Cap 88401 Hwy 82, Enterprise, OR 97828, 541-426-4978

La Grande 3502 Hwy. 30, La Grande, OR 97850, 541-963-7186

Wallowa Valley 88401 Hwy 82, Enterprise, OR 97828, 541-426-4978

Whitman Unit 541-426-4476

Baker Office: 3165 10th Street, Baker City, OR 97814, 541-523-4476

Pine Office: 38470 Pine Town Lane, Halfway, OR 97834, 541-742-7511

Unity Office: 214 Main Street, Unity, OR 97884, 541-446-3351

Hells Canyon NRA 88401 Hwy 82, Enterprise, OR 97828, 541-426-4978

**Willamette National Forest ... Dallas Emch**, 211 East 7th Ave., PO Box 10607, Eugene, OR 97440-2607, 541-225-6300; Fax: 541-225-6223; TDD: 541-465-6323

Detroit HC-73, Box 320, Mill City, OR 97360, 503-854-3366

Middle Fork 46375 Hwy 58, Westfir, OR 97492, 541-782-2283

McKenzie River 57600 McKenzie Hwy, McKenzie Bridge, OR 97413, 541-822-3381

Sweet Home 3225 Hwy. 20, Sweet Home, OR 97386, 541-367-5168

**REGION 6 Washington: National Forest and Ranger District Location Information**

**Colville National Forest** 765 S. Main, Colville, WA 99114, 509-684-7000

Three Rivers 255 West 11th, Kettle Falls, WA 99141, 509-738-7700

Newport 315 N. Warren, Newport, WA 99156, 509-447-7300

Republic 180 N. Jefferson, Republic, WA 99166, 509-775-7400

Sullivan Lake 12641 Sullivan Lake Rd, Metaline Falls, WA 99153, 509-446-7500

**Gifford Pinchot National Forest** 10600 NE 51st Circle, Vancouver, WA 98682, 360-891-5000

Cowlitz Valley 10024 US Hwy 12, Randle, WA 98377-9105, 360-497-1100

Mt. Adams 2455 Hwy 141, Trout Lake, WA 98650-9046, 509-395-3400

Mount St. Helens National Volcanic Monument 42218 NE Yale Bridge Rd, Amboy, WA 98601-9715, 360-449-7800

**Mt. Baker-Snoqualmie National Forest** 21905 64th Avenue West, Mountlake Terrace, WA 98043, 425-775-9702

Mt. Baker 810 State. Rt. 20, Sedro Woolley, WA 98284, 360-856-5700

Skykomish 74920 NE Stevens Pass Hwy, PO Box 305, Skykomish, WA 98288, 360-677-2414

Snoqualmie 42404 SE North Bend Way, North Bend, WA 98045, 425-888-1421

Snoqualmie - Enumclaw Office 450 Roosevelt Ave E., Enumclaw, WA 98022, 360-825-6585

**Okanogan and Wenatchee National Forests** 215 Melody Lane, Wenatchee, WA 98801-5933, 509-664-9200;

Okanogan Valley Office ... 1240 South Second Ave, Okanogan, WA 98840-9723, 509-826-3275;

Chelan 428 W. Woodin Ave., Chelan, WA 98816, 509-682-2576

Cle Elum 803 W. 2nd St., Cle Elum, WA 98922, 509-852-1100

Entiat 2108 Entiat Way, PO Box 476, Entiat, WA 98822, 509-784-1511

Leavenworth 600 Sherbourne, Leavenworth, WA 98826, 509-548-6977 x200

Methow Valley 24W. Chewuch Road, Winthrop, WA 98862, 509-996-4003

Naches 10237 Highway 12, Naches, WA 98937, 509-653-1400

Tonasket 1 West Winesap, Tonasket, WA 98855, 509-486-2186

**Olympic National Forest** 1835 Black Lake Blvd SW, Olympia, WA 98512-5623, 360-956-2301  
Hood Canal Ranger District (Quilcene Office) 295142 Hwy 101 S, PO Box 280, Quilcene, WA 98376, 360-765-2200  
Pacific Ranger District (Forks Office) 437 Tillicum Lane, Forks, WA 98331, 360-374-6522  
Pacific Ranger District (Quinalt Office) 353 South Shore Rd, PO Box 9, Quinalt, WA 98575, 360-288-2525

## A1.7 REFERENCE TABLES FOR FIA PLOTS ON NATIONAL FOREST LANDS

### A. R5 Survey Tree Species Codes and Current PNW-FIA Annual Tree Species Equivalent

R5 Code	Species	Scientific name	PNW Code
1	Douglas-fir	<i>Pseudotsuga menziesii</i>	202
2	Bigcone Douglas-fir	<i>Pseudotsuga macrocarpa</i>	201
5	Redwood	<i>Sequoia sempervirens</i>	211
6	Giant sequoia	<i>Sequoiadendron giganteum</i>	212
11	Ponderosa pine	<i>Pinus ponderosa</i>	122
12	Jeffrey pine	<i>Pinus jeffreyi</i>	116
13	Sugar pine	<i>Pinus lambertiana</i>	117
14	Western White Pine	<i>Pinus monticola</i>	119
15	Lodgepole pine	<i>Pinus contorta</i>	108
19	Washoe pine	<i>Pinus washoensis</i>	137
21	Coulter pine	<i>Pinus coulteri</i>	109
22	Monterey pine	<i>Pinus radiata</i>	124
23	Gray pine (Digger pine)	<i>Pinus sabiniana</i>	127
24	Knobcone pine	<i>Pinus attenuata</i>	103
25	Bishop pine	<i>Pinus muricata</i>	120
26	Whitebark pine	<i>Pinus albicaulis</i>	101
27	Singleleaf pinyon	<i>Pinus monophylla</i>	133
28	Bristlecone pine	<i>Pinus aristata</i>	102
29	Limber pine	<i>Pinus flexilis</i>	113
30	Foxtail pine	<i>Pinus balfouriana</i>	104
31	White fir	<i>Abies concolor</i>	15
32	Red fir	<i>Abies magnifica</i>	20
33	Grand fir	<i>Abies grandis</i>	17
34	Bristlecone fir	<i>Abies bracketeata</i>	14
35	Noble fir	<i>Abies procera</i>	22
37	Subalpine fir	<i>Abies lasiocarpa</i>	19
39	Pacific silver fir	<i>Abies amabilis</i>	11
42	Sitka spruce	<i>Picea sitchensis</i>	98
45	Baker cypress	<i>Cupressus bakeri ssp. bakeri</i>	50
46	Brewer spruce	<i>Picea breweriana</i>	92
47	Mountain hemlock	<i>Tsuga mertensiana</i>	264
48	Western hemlock	<i>Tsuga heterophylla</i>	263
51	Incense-cedar	<i>Calocedrus decurrens (Libocedrus decurrens)</i>	81
52	Alaska yellow cedar	<i>Chamaecyparis nootkatensis</i>	42
53	Port-Orford-cedar	<i>Chamaecyparis lawsoniana</i>	41
54	Western red-cedar	<i>Thuja plicata</i>	242
57	Monterey cypress	<i>Cupressus macrocarpa</i>	54
58	Tecate cypress	<i>Cupressus forbesii</i>	53
59	MacNab cypress	<i>Cupressus macnabiana</i>	50
61	California-nutmeg	<i>Torreya californica</i>	251
62	Pacific yew	<i>Taxus brevifolia</i>	231
63	Western juniper	<i>Juniperus occidentalis</i>	64
64	Cypress	<i>Cupressus sp.</i>	50
65	Utah juniper	<i>Juniperus osteosperma</i>	65
66	California juniper	<i>Juniperus californica</i>	62
68	Other conifers		
70	California buckeye	<i>Aesculus californica</i>	333

Annual Inventory 2007, Appendix 1: National Forest Plots Special Rules

R5 Code	Species	Scientific name	PNW Code
71	Red alder	<i>Alnus oregona (rubra)</i>	351
72	Ash	<i>Fraxinus sp.</i>	540
73	Aspen	<i>Populus tremuloides</i>	746
74	White alder	<i>Alnus rhombifolia</i>	352
75	Black cottonwood	<i>Populus trichocarpa</i>	747
76	Bigleaf maple	<i>Acer macrophyllum</i>	312
77	Tree of Heaven	<i>Ailanthus altissima</i>	341
78	Fremont cottonwood	<i>Populus fremontii</i>	748
79	Engelmann oak	<i>Quercus engelmannii</i>	811
80	Unknown oak sp.	<i>Quercus sp.</i>	999
81	California black oak	<i>Quercus kelloggii</i>	818
82	Coast live oak	<i>Quercus agrifolia</i>	801
83	California white (Valley) oak	<i>Quercus lobata</i>	821
84	Canyon live oak	<i>Quercus chrysolepis</i>	805
85	Interior live oak	<i>Quercus wislizenii</i>	839
86	Oregon white oak	<i>Quercus garryana</i>	815
87	Tanoak	<i>Lithocarpus densiflorus</i>	631
88	Blue oak	<i>Quercus douglassii</i>	807
89	Willow sp.	<i>Salix sp.</i>	920
90	Walnut sp.	<i>Juglans sp.</i>	600
91	California-laurel	<i>Umbellularia californica</i>	981
92	California boxelder	<i>Acer negundo californicum</i>	313
93	Giant chinquapin	<i>Castanopsis chrysophylla</i>	431
94	Madrone	<i>Arbutus menziesii</i>	361
95	Pacific dogwood	<i>Cornus nuttallii</i>	492
96	Sycamore	<i>Platanus racemosa</i>	730
97	Eucalyptus sp.	<i>Eucalyptus sp.</i>	510
98	Other hardwoods		

**B. R5 Weed List**

To be coded on R5 National Forest lands only.

CODE	PLANTS Species	R5 species	Common
CANU4	<i>Carduus nutans</i>	<i>Carduus nutans</i>	Musk Thistle
CEDI3	<i>Centaurea diffusa</i>	<i>Centauria diffusa</i>	Diffuse Knapweed
CESO3	<i>Centaurea solstitialis</i>	<i>Centauria solstitialis</i>	Yellowstar thistle
CEBI2	<i>Centaurea bieberstinii</i>	<i>Centauria maculosa</i>	Spotted Knapweed
CHJU	<i>Chondrilla juncea</i>	<i>Chondrilla juncea</i>	Rush Skeleton Weed
CIAR4	<i>Cirsium arvense</i>	<i>Cirsium arvense</i>	Canada Thistle
EUES	<i>Euphorbia esula</i>	<i>Euphorbia esula</i>	leafy spurge
EUOB4	<i>Euphorbia oblongata</i>	<i>Euphorbia oblongata</i>	oblong spurge
GEMO2	<i>Genista monspessulana</i>	<i>Genista monspessulana</i>	French Broom
HYPE	<i>Hypericum perforatum</i>	<i>Hypericum perforatum</i>	Klamath Weed
TACA8	<i>Taeniatherum caput-medusae</i>	<i>Taeniatherum caputmedusa</i>	medusa head

**C. R6 Plant Indicator and Weed Species Lists**

Standard Phase 2: field crews only need to look for the plants identified specifically as forest “indicators” for 10 minutes, coding all that they can in that amount of time. After this amount of time, the field crew only needs to code species that occur on the subplot in > 3% cover. The “nonforest”, “weed”, and “sensitive” plant species can also be recorded during standard Phase 2 inventory if crews recognize them, but are intended for inventory by specially-trained National Forest botanists.

Species are listed in four categories of “use”:

Annual Inventory 2007, Appendix 1: National Forest Plots Special Rules

1. **indi**: indicator species for forested plant associations-recorded only when 50% or more of a subplot is in a forested condition class,
2. **nfor**: indicator species for nonforest plant associations (either completed or in development)-recorded only when 50% or more of a subplot is in a nonforest condition class,
3. **weed**: noxious or invasive plants of special interest-recorded on all conditions, and
4. **sens**: usually rare species that are believed to be sensitive to management-recorded on all conditions.

Most National Forests have produced illustrated guides to identify these forest indicator (“indi”) species and distinguish them from related species; they are listed below for each ecological zone. Some species are defined as “trees” by FIA, are sampled using normal tree tally procedures, and are included on the list as reference only because they appear as “shrubs” in the R6 guides. The “R6 old species” names and codes are those found in the Plant Association Guides for the respective forests. Within each zone’s list, species are grouped first by use, and secondarily by PLANTS species name.

**NW Oregon**

**Mt. Hood, Siuslaw, and Willamette National Forests**

ID Guide: Halverson, Nancy M. 1986. Major Indicator Shrubs and Herbs on National Forests of Western Oregon and Southwestern Washington. USDA Forest Service, Pacific Northwest Region R6-TM-229-1986.

PLANTS	PLANTS species	use	form	R6code	R6 old species	common name
CHCHC4	<i>Chrysolepis chrysophylla</i> <i>va. chrysophylla</i>	indi	tree	CACH	<i>Castanopsis chrysophylla</i>	Golden Chinquapin
ACCI	<i>Acer circinatum</i>	indi	shrub	ACCI	<i>Acer circinatum</i>	Vine maple
AMAL2	<i>Amelanchier alnifolia</i>	indi	shrub	AMAL	<i>Amelanchier alnifolia</i>	Saskatoon Serviceberry
ARNE	<i>Arctostaphylos nevadensis</i>	indi	shrub	ARNE	<i>Arctostaphylos nevadensis</i>	pinemat manzanita
ARUV	<i>Arctostaphylos uva-ursi</i>	indi	shrub	ARUV	<i>Arctostaphylos uva-ursi</i>	Bearberry, Kinnikinnick
CHUM	<i>Chimaphila umbellata</i>	indi	shrub	CHUM	<i>Chimaphila umbellata</i>	pipsissewa
COCO6	<i>Corylus cornuta</i>	indi	shrub	COCO2	<i>Corylus cornuta</i>	California Hazel
HODI	<i>Holodiscus discolor</i>	indi	shrub	HODI	<i>Holodiscus discolor</i>	oceanspray
JUCO6	<i>Juniperus communis</i>	indi	shrub	JUCO4	<i>Juniperus communis</i>	common juniper
GASH	<i>Gaultheria shallon</i>	indi	shrub	GASH	<i>Gaultheria shallon</i>	salal
MAAQ2	<i>Mahonia aquifolium</i>	indi	shrub	BEAQ	<i>Berberis aquifolium</i>	Tall Oregon Grape
MANE2	<i>Mahonia nervosa</i>	indi	shrub	BENE	<i>Berberis nervosa</i>	Oregon Grape
MEFE	<i>Menziesia ferruginea</i>	indi	shrub	MEFE	<i>Menziesia ferruginea</i>	fool's huckleberry
OPHO	<i>Oplopanax horridus</i>	indi	shrub	OPHO	<i>Oplopanax horridus</i>	devil's club
PHEM	<i>Phyllodoce empetrifomis</i>	indi	shrub	PHEM	<i>Phyllodoce empetrifomis</i>	pink mountain-heath
PUTR2	<i>Purshia tridentata</i>	indi	shrub	PUTR	<i>Purshia tridentata</i>	bitterbrush
RHAL2	<i>Rhododendron albiflorum</i>	indi	shrub	RHAL	<i>Rhododendron albiflorum</i>	cascades azalea
RHMA3	<i>Rhododendron macrophyllum</i>	indi	shrub	RHMA	<i>Rhododendron macrophyllum</i>	Pacific rhododendron
RUPA	<i>Rubus parviflorus</i>	indi	shrub	RUPA	<i>Rubus parviflorus</i>	Thimbleberry
RUSP	<i>Rubus spectabilis</i>	indi	shrub	RUSP	<i>Rubus spectabilis</i>	salmonberry
RUUR	<i>Rubus ursinus</i>	indi	shrub	RUUR	<i>Rubus ursinus</i>	Pacific blackberry
SYAL	<i>Symphoricarpos albus</i>	indi	shrub	SYAL	<i>Symphoricarpos albus</i>	Common snowberry
SYHE	<i>Symphoricarpos hesperius</i>	indi	shrub	SYMO	<i>Symphoricarpos mollis</i>	Trailing Snowberry
TODI	<i>Toxicodendron diversilobum</i>	indi	shrub	RHDI	<i>Rhus diversiloba</i>	poison oak
VADE	<i>Vaccinium deliciosum</i>	indi	shrub	VADE	<i>Vaccinium deliciosum</i>	delicious blueberry
VAME	<i>Vaccinium membranaceum</i>	indi	shrub	VAME	<i>Vaccinium membranaceum</i>	big huckleberry
VAOV	<i>Vaccinium ovalifolium</i>	indi	shrub	VAAL	<i>Vaccinium alaskense</i>	Alaska huckleberry

## Annual Inventory 2007, Appendix 1: National Forest Plots Special Rules

PLANTS	PLANTS species	use	form	R6code	R6 old species	common name
VAOV	<i>Vaccinium ovalifolium</i>	indi	shrub	VAOV	<i>Vaccinium ovalifolium</i>	oval-leaf huckleberry
VAOV2	<i>Vaccinium ovatum</i>	indi	shrub	VAOV2	<i>Vaccinium ovatum</i>	evergreen huckleberry
WHMO	<i>Whipplea modesta</i>	indi	shrub	WHMO	<i>Whipplea modesta</i>	whipplevine
ACTR	<i>Achlys triphylla</i>	indi	forb	ACTR	<i>Achlys triphylla</i>	Vanilla Leaf
ACRU2	<i>Actaea rubra</i>	indi	forb	ACRU	<i>Actaea rubra</i>	baneberry
ADBI	<i>Adenocaulon bicolor</i>	indi	forb	ADBI	<i>Adenocaulon bicolor</i>	trail plant
ADAL	<i>Adiantum aleuticum</i>	indi	forb	ADPE	<i>Adiantum pedatum</i>	maidenhair fern
ASCA2	<i>Asarum caudatum</i>	indi	forb	ASCA3	<i>Asarum caudatum</i>	wild ginger
ATFI	<i>Athyrium filix-femina</i>	indi	forb	ATFI	<i>Athyrium filix-femina</i>	common lady fern
BASA3	<i>Balsamorhiza sagittata</i>	indi	forb	BASA	<i>Balsamorhiza sagittata</i>	Arrow leaf Balsamroot
BLSP	<i>Blechnum spicant</i>	indi	forb	BLSP	<i>Blechnum spicant</i>	deer fern
CLDO2	<i>Clinopodium douglasii</i>	indi	forb	SADO	<i>Satureja douglasii</i>	yerba buena
CLUN2	<i>Clintonia uniflora</i>	indi	forb	CLUN	<i>Clintonia uniflora</i>	queen's cup beadlilly
COCA13	<i>Cornus Canadensis</i>	indi	forb	COCA	<i>Cornus canadensis</i>	bunchberry
DRCA11	<i>Dryopteris carthusiana</i>	indi	forb	DRAU2	<i>Dryopteris austriaca</i>	shield-fern
ERMO8	<i>Erythronium montanum</i>	indi	forb	ERMO	<i>Erythronium montanum</i>	avalanche lily/giant fawn
EULEL2	<i>Eucephalus ledophyllus</i> var. <i>ledophyllus</i>	indi	forb	ASLE2	<i>Aster ledophyllus</i>	Cascades aster
FRAGA	<i>Fragaria sp.</i>	indi	forb	FRAGA	<i>Fragaria sp.</i>	strawberry species
FRVE	<i>Fragaria vesca</i>	indi	forb	FRVE	<i>Fragaria vesca</i>	woodland strawberry
HIAL2	<i>Hieracium albiflorum</i>	indi	forb	HIAL	<i>Hieracium albiflorum</i>	White Hawkweed
LAPO3	<i>Lathyrus polyphyllus</i>	indi	forb	LAPO	<i>Lathyrus polyphyllus</i>	leafy pea vine
LIBO3	<i>Linnaea borealis</i>	indi	forb	LIBO2	<i>Linnaea borealis</i>	twinline
LYAM3	<i>Lysichiton americanus</i>	indi	forb	LYAM	<i>Lysichiton americanum</i>	skunk cabbage
MADI2	<i>Maianthemum dilatatum</i>	indi	forb	MADI2	<i>Maianthemum dilatatum</i>	false lily of the vally
MARA7	<i>Maianthemum racemosum</i>	indi	forb	SMRA	<i>Smilacina racemosa</i>	False Solomon's Seal
MAST4	<i>Maianthemum stellatum</i>	indi	forb	SMST	<i>Smilacina stellata</i>	Starry Solomon's Seal
MOMA3	<i>Moehringia macrophylla</i>	indi	forb	ARMA3	<i>Arenaria macrophylla</i>	Big leaf Sandwort
OSBE	<i>Osmorhiza berteroi</i>	indi	forb	OSCH	<i>Osmorhiza chilensis</i>	Sweet Cicely
OXOR	<i>Oxalis oregana</i>	indi	forb	OXOR	<i>Oxalis oregana</i>	Oregon oxalis
POPU3	<i>Polemonium pulcherrimum</i>	indi	forb	POPU	<i>Polemonium pulcherrimum</i>	Jacob's ladder
PODA	<i>Polygonum davisiae</i>	indi	forb	PONE4	<i>Polygonum newberryi</i>	Newberry's fleece flower
POMU	<i>Polystichum munitum</i>	indi	forb	POMU	<i>Polystichum munitum</i>	western sword fern
STME	<i>Stachys mexicana</i>	indi	forb	STME2	<i>Stachys mexicana</i>	Mexican hedge nettle
STLAC	<i>Streptopus lanceolatus</i> var. <i>curvipes</i>	indi	forb	STRO	<i>Streptopus roseus</i>	Rosy twisted stalk
SYRE	<i>Synthyris reniformis</i>	indi	forb	SYRE	<i>Synthyris reniformis</i>	Snow queen
TITR	<i>Tiarella trifoliata</i>	indi	forb	TITR	<i>Tiarella trifoliata</i>	Three leaf foamflower
TRBOL	<i>Trientalis borealis</i> ssp. <i>Latifolia</i>	indi	forb	TRLA2	<i>Trientalis latifolia</i>	Western Starflower
VAHE	<i>Vancouveria hexandra</i>	indi	forb	VAHE	<i>Vancouveria hexandra</i>	white inside-out-flower
XETE	<i>Xerophyllum tenax</i>	indi	forb	XETE	<i>Xerophyllum tenax</i>	Beargrass
CAGE2	<i>Carex geyeri</i>	indi	grami	CAGE	<i>Carex geyeri</i>	elk sedge
FEOC	<i>Festuca occidentalis</i>	indi	grami	FEOC	<i>Festuca occidentalis</i>	Western Fescue
FEVI	<i>Festuca viridula</i>	indi	grami	FEVI	<i>Festuca viridula</i>	green fescue
LUZUL	<i>Luzula sp.</i>	indi	grami	LUZUL	<i>Luzula sp.</i>	woodrush



**SW Oregon****Rogue River, Siskiyou, and Umpqua National Forests**

ID Guide: Seda, Anita, Thomas Atzet, and David Wheeler. 1989 (updated 1997). Key Species for Plant Associations on the Rogue River, Siskiyou, and Umpqua National Forests. USDA Forest Service, Pacific Northwest Region R6-NR-ECOL-TP-026-97.

PLANTS	PLANTS species	use	form	R6code	R6 old species	common_name
CHCHC4	<i>Chrysolepis chrysophylla</i> <i>var. chrysophylla</i>	indi	tree	CACH	<i>Castanopsis chrysophylla</i>	Golden Chinquapin
LIDEE	<i>Lithocarpus densiflora</i> <i>var. echinoides</i>	indi	tree	LIDEE	<i>Lithocarpus densiflora echinoides</i>	tanoak (shrub form)
ACCI	<i>Acer circinatum</i>	indi	shrub	ACCI	<i>Acer circinatum</i>	Vine maple
ACGLD4	<i>Acer glabrum</i> <i>var. Douglasii</i>	indi	shrub	ACGLD	<i>Acer glabrum</i> <i>var. Douglasii</i>	Douglas maple
ARCA5	<i>Arctostaphylos canescens</i>	indi	shrub	ARCA5	<i>Arctostaphylos canescens</i>	hoary manzanita
ARCO3	<i>Arctostaphylos columbiana</i>	indi	shrub	ARCO3	<i>Arctostaphylos columbiana</i>	hairy manzanita
ARNE	<i>Arctostaphylos nevadensis</i>	indi	shrub	ARNE	<i>Arctostaphylos nevadensis</i>	pinemat manzanita
ARPA6	<i>Arctostaphylos patula</i>	indi	shrub	ARPA	<i>Arctostaphylos patula</i>	Greenleaf Manzanita
ARCTO3	<i>Arctostaphylos</i> <i>spp.</i>	indi	shrub	ARCTO	<i>Arctostaphylos</i> <i>spp.</i>	Arctostaphylos spp.
ARVI4	<i>Arctostaphylos viscida</i>	indi	shrub	ARVI	<i>Arctostaphylos viscida</i>	whiteleaf manzanita
CECU	<i>Ceanothus cuneatus</i>	indi	shrub	CECU	<i>Ceanothus cuneatus</i>	buckbrush
CEIN3	<i>Ceanothus integerrimus</i>	indi	shrub	CEIN	<i>Ceanothus intergerrimus</i>	deerbrush
CEPR	<i>Ceanothus prostratus</i>	indi	shrub	CEPR	<i>Ceanothus prostratus</i>	Squawcarpet
CEPU	<i>Ceanothus pumilus</i>	indi	shrub	CEPU	<i>Ceanothus pumilus</i>	dwarf ceanothus
CETH	<i>Ceanothus thyrsiflorus</i>	indi	shrub	CETH	<i>Ceanothus thyrsiflorus</i>	blue blossom ceanothus
CEVE	<i>Ceanothus velutinus</i>	indi	shrub	CEVE	<i>Ceanothus velutinus</i>	Snowbrush Ceanothus
CHME	<i>Chimaphila menziesii</i>	indi	shrub	CHME	<i>Chimaphila menziesii</i>	little prince's-pine
CHUM	<i>Chimaphila umbellata</i>	indi	shrub	CHUM	<i>Chimaphila umbellata</i>	pipsissewa
COCOC	<i>Corylus cornuta</i> <i>var. californica</i>	indi	shrub	COCOC	<i>Corylus cornuta californica</i>	California hazel
FRCA12	<i>Frangula californica</i>	indi	shrub	RHCA	<i>Rhamnus californica</i>	coffeeberry
FRPU7	<i>Frangula purshiana</i>	indi	shrub	RHPU	<i>Rhamnus purshiana</i>	cascara
GABU2	<i>Garrya buxifolia</i>	indi	shrub	GABU	<i>Garrya buxifolia</i>	box-leaved silk-tassel
GAOV2	<i>Gaultheria ovatifolia</i>	indi	shrub	GAOV	<i>Gaultheria ovatifolia</i>	slender salal
GASH	<i>Gaultheria shallon</i>	indi	shrub	GASH	<i>Gaultheria shallon</i>	salal
HODI	<i>Holodiscus discolor</i>	indi	shrub	HODI	<i>Holodiscus discolor</i>	oceanspray
LEDA	<i>Leucothoe davisiae</i>	indi	shrub	LEDA	<i>Leucothoe davisiae</i>	Sierra-laurel
LOHI2	<i>Lonicera hispidula</i>	indi	shrub	LOHI	<i>Lonicera hispidula</i>	hairy honeysuckle
MAAQ2	<i>Mahonia aquifolium</i>	indi	shrub	BEPI	<i>Berberis piperiana</i>	Piper's Oregongrape
MANE2	<i>Mahonia nervosa</i>	indi	shrub	BENE	<i>Berberis nervosa</i>	Oregon Grape
MARE11	<i>Mahonia repens</i>	indi	shrub	BERE	<i>Berberis repens</i>	Creeping Oregon Grape
PAMY	<i>Paxistima myrsinites</i>	indi	shrub	PAMY	<i>Pachistima myrsinites</i>	Oregon Boxwood
QUSA2	<i>Quercus sadleriana</i>	indi	shrub	QUSA	<i>Quercus sadleriana</i>	Sadler oak
QUVA	<i>Quercus vaccinifolia</i>	indi	shrub	QUVA	<i>Quercus vaccinifolia</i>	huckleberry oak
RHMA3	<i>Rhododendron macrophyllum</i>	indi	shrub	RHMA	<i>Rhododendron macrophyllum</i>	Pacific rhododendron
RHOC	<i>Rhododendron occidentale</i>	indi	shrub	RHOC	<i>Rhododendron occidentale</i>	western azalea
RIBI	<i>Ribes binominatum</i>	indi	shrub	RIBI	<i>Ribes binominatum</i>	Siskiyou gooseberry

## Annual Inventory 2007, Appendix 1: National Forest Plots Special Rules

PLANTS	PLANTS species	use	form	R6code	R6 old species	common_name
RICE	<i>Ribes cereum</i>	indi	shrub	RICE	<i>Ribes cereum</i>	Squaw Current
RICR	<i>Ribes cruentum</i>	indi	shrub	RICR	<i>Ribes cruentum</i>	shinyleaf gooseberry
RILA	<i>Ribes lacustre</i>	indi	shrub	RILA	<i>Ribes lacustre</i>	Prickly currant
RILO	<i>Ribes lobbii</i>	indi	shrub	RILO	<i>Ribes lobbii</i>	gummy gooseberry
RIMA2	<i>Ribes marshallii</i>	indi	shrub	RIMA	<i>Ribes marshallii</i>	Applegate gooseberry
RISA	<i>Ribes sanguineum</i>	indi	shrub	RISA	<i>Ribes sanguineum</i>	red currant
RIVI3	<i>Ribes viscosissimum</i>	indi	shrub	RIVI	<i>Ribes viscosissimum</i>	Sticky Currant
ROGY	<i>Rosa gymnocarpa</i>	indi	shrub	ROGY	<i>Rosa gymnocarpa</i>	Baldhip Rose
RULA2	<i>Rubus lasiococcus</i>	indi	shrub	RULA	<i>Rubus lasiococcus</i>	dwarf bramble
RUNI2	<i>Rubus nivalis</i>	indi	shrub	RUNI	<i>Rubus nivalis</i>	snow bramble
RUSP	<i>Rubus spectabilis</i>	indi	shrub	RUSP	<i>Rubus spectabilis</i>	salmonberry
RUUR	<i>Rubus ursinus</i>	indi	shrub	RUUR	<i>Rubus ursinus</i>	Pacific blackberry
SYHE	<i>Symphoricarpos hesperius</i>	indi	shrub	SYMO	<i>Symphoricarpos mollis</i>	Trailing Snowberry
TODI	<i>Toxicodendron diversilobum</i>	indi	shrub	RHDI	<i>Rhus diversiloba</i>	poison oak
VAME	<i>Vaccinium membranaceum</i>	indi	shrub	VAME	<i>Vaccinium membranaceum</i>	big huckleberry
VAOV2	<i>Vaccinium ovatum</i>	indi	shrub	VAOV2	<i>Vaccinium ovatum</i>	evergreen huckleberry
VAPA	<i>Vaccinium parvifolium</i>	indi	shrub	VAPA	<i>Vaccinium parvifolium</i>	red huckleberry
VASC	<i>Vaccinium scoparium</i>	indi	shrub	VASC	<i>Vaccinium scoparium</i>	grouse huckleberry
WHMO	<i>Whipplea modesta</i>	indi	shrub	WHMO	<i>Whipplea modesta</i>	whipplevine
ACMI2	<i>Achillea millefolium</i>	indi	forb	ACMI	<i>Achillea millefolium</i>	Western Yarrow
ACTR	<i>Achlys triphylla</i>	indi	forb	ACTR	<i>Achlys triphylla</i>	Vanilla Leaf
ACRU2	<i>Actaea rubra</i>	indi	forb	ACRU	<i>Actaea rubra</i>	baneberry
ADBI	<i>Adenocaulon bicolor</i>	indi	forb	ADBI	<i>Adenocaulon bicolor</i>	trail plant
ANDE3	<i>Anemone deltoidea</i>	indi	forb	ANDE	<i>Anemone deltoidea</i>	threeleaf anemone
APAN2	<i>Apocynum androsaemifolium</i>	indi	forb	APAN	<i>Apocynum androsaemifolium</i>	spreading dogbane
ARCO9	<i>Arnica cordifolia</i>	indi	forb	ARCO	<i>Arnica cordifolia</i>	heart-leaf arnica
ARLA8	<i>Arnica latifolia</i>	indi	forb	ARLA	<i>Arnica latifolia</i>	Broadleaf Arnica
ASDE6	<i>Aspidotis densa</i>	indi	forb	ASDE	<i>Aspidotis densa</i>	rock fern
CLUN2	<i>Clintonia uniflora</i>	indi	forb	CLUN	<i>Clintonia uniflora</i>	queen's cup beadlilly
CYGR	<i>Cynoglossum grande</i>	indi	forb	CYGR	<i>Cynoglossum grande</i>	Pacific hound's-tongue
DIHOO	<i>Disporum hookeri</i> var. <i>oreganum</i>	indi	forb	DIHOO	<i>Disporum hookeri</i> <i>oreganum</i>	Oregon fairybell
EQAR	<i>Equisetum arvense</i>	indi	forb	EQAR	<i>Equisetum arvense</i>	Common horsetail
ERUM	<i>Eriogonum umbellatum</i>	indi	forb	ERUM	<i>Eriogonum umbellatum</i>	sulphurflower
FRVEB2	<i>Fragaria vesca</i> ssp. <i>bracteata</i>	indi	forb	FRVEB	<i>Fragaria vesca</i> <i>bracteata</i>	woods strawberry
GAAM2	<i>Galium ambiguum</i>	indi	forb	GAAM	<i>Galium ambiguum</i>	obscure bedstraw
GAAP2	<i>Galium aparine</i>	indi	forb	GAAP	<i>Galium aparine</i>	catchweed bedstraw
GAOR	<i>Galium oreganum</i>	indi	forb	GAOR	<i>Galium oreganum</i>	Oregon bedstraw
GATR3	<i>Galium triflorum</i>	indi	forb	GATR	<i>Galium triflorum</i>	Sweetscented bedstraw
GOOB2	<i>Goodyera oblongifolia</i>	indi	forb	GOOB	<i>Goodyera oblongifolia</i>	Western Rattlesnake-Plantain
HIAL2	<i>Hieracium albiflorum</i>	indi	forb	HIAL	<i>Hieracium albiflorum</i>	White Hawkweed
LIBOL2	<i>Linnaea borealis</i> ssp. <i>longiflora</i>	indi	forb	LIBOL	<i>Linnaea borealis</i> <i>longiflora</i>	western twinflower
MAMA	<i>Madia madioides</i>	indi	forb	MAMA	<i>Madia madioides</i>	woodland tarweed
MARA7	<i>Maianthemum racemosum</i>	indi	forb	SMRA	<i>Smilacina racemosa</i>	False Solomn's Seal
MAST4	<i>Maianthemum stellatum</i>	indi	forb	SMST	<i>Smilacina stellata</i>	Starry Solomn's Seal

## Annual Inventory 2007, Appendix 1: National Forest Plots Special Rules

PLANTS	PLANTS species	use	form	R6code	R6 old species	common_name
MESU	<i>Melica subulata</i>	indi	grami	MESU	<i>Melica subulata</i>	Alaska oniongrass
MITR4	<i>Mitella trifida</i>	indi	forb	MITR2	<i>Mitella trifida</i>	three-tooth mitrewort
MOOD	<i>Monardella odoratissima</i>	indi	forb	MOOD	<i>Monardella odoratissima</i>	mountain balm
ORSE	<i>Orthilia secunda</i>	indi	forb	PYSE	<i>Pyrola secunda</i>	Sidebells Pyrola
OSBE	<i>Osmorhiza berteroi</i>	indi	forb	OSCH	<i>Osmorhiza chilensis</i>	Sweet Cicely
OSPU	<i>Osmorhiza purpurea</i>	indi	forb	OSPU	<i>Osmorhiza purpurea</i>	purple sweet-root
OXOR	<i>Oxalis oregana</i>	indi	forb	OXOR	<i>Oxalis oregana</i>	Oregon oxalis
POPU3	<i>Polemonium pulcherrimum</i>	indi	forb	POPU	<i>Polemonium pulcherrimum</i>	Jacob's ladder
POMU	<i>Polystichum munitum</i>	indi	forb	POMU	<i>Polystichum munitum</i>	western swordfern
PTAQ	<i>Pteridium aquilinum</i>	indi	forb	PTAQ	<i>Pteridium aquilinum</i>	bracken fern
PYAS	<i>Pyrola asarifolia</i>	indi	forb	PYAS	<i>Pyrola asarifolia</i>	alpine pyrola
PYDE	<i>Pyrola dentata</i>	indi	forb	PYDE	<i>Pyrola dentata</i>	toothleaf pyrola
PYPI2	<i>Pyrola picta</i>	indi	forb	PYPI	<i>Pyrola picta</i>	whitevein pyrola
CYEC	<i>Cynosurus echinatus</i>	indi	grami	CYEC	<i>Cynosurus echinatus</i>	hedgehog dogtail
FEID	<i>Festuca idahoensis</i>	indi	grami	FEID	<i>Festuca idahoensis</i>	idaho fescue
FESTU	<i>Festuca sp.</i>	indi	grami	FESTU	<i>Festuca spp.</i>	fescue species
CYSC4	<i>Cytisus scoparius</i>	weed	shrub	CYSC	<i>Cytisus scoparius</i>	Scotch broom
GEMO2	<i>Genista monspessulana</i>	weed	shrub	CYMO3	<i>Cytisus monspessulanas</i>	French broom
SPJU2	<i>Spartium junceum</i>	weed	shrub	SPJU?	<i>Spartium junceum</i>	Spanish broom
ULEU	<i>Ulex europaeus</i>	weed	shrub	ULEU	<i>Ulex europaeus</i>	Gorse
ACNO4	<i>Acaena novae-zelandica</i>	weed	forb	ACAN?	<i>Acaena anserinifolia</i>	Biddy-biddy
ACRE3	<i>Acroptilon repens</i>	weed	forb	CERE	<i>Centaurea repens</i>	Russian knapweed
CANU4	<i>Carduus nutans</i>	weed	forb	CANU5	<i>Carduus nutans</i>	Musk thistle
CAPY2	<i>Carduus pycnocephalus</i>	weed	forb	CAPY3	<i>Carduus pycnocephalus</i>	Italian thistle
CALA20	<i>Carthamus lanatus</i>	weed	forb	CALA?	<i>Carthamus lanatus</i>	Woolly distaff thistle
CEBI2	<i>Centaurea biebersteinii</i>	weed	forb	CEMA	<i>Centaurea maculosa</i>	Spotted knapweed
CEDET	<i>Centaurea debeauxii ssp. thuilleri</i>	weed	forb	CEPR?	<i>Centaurea pratensis</i>	Meadow knapweed
CEDI3	<i>Centaurea diffusa</i>	weed	forb	CEDI	<i>Centaurea diffusa</i>	Diffuse knapweed
CEME2	<i>Centaurea melitensis</i>	weed	forb	CEME	<i>Centaurea melitensis</i>	Malta starthistle
CESO3	<i>Centaurea solstitialis</i>	weed	forb	CESO	<i>Centaurea solstitialis</i>	Yellow starthistle
CETR8	<i>Centaurea triumfetti</i>	weed	forb	CEVI?	<i>Centaurea virgata</i>	Squarrose knapweed
CHJU	<i>Chondrilla juncea</i>	weed	forb	CHJU	<i>Chondrilla juncea</i>	Rush skeletonweed
CIAR4	<i>Cirsium arvense</i>	weed	forb	CIAR	<i>Cirsium arvense</i>	Canada thistle
CIVU	<i>Cirsium vulgare</i>	weed	forb	CIVU	<i>Cirsium vulgare</i>	Bull thistle
COAR4	<i>Convolvulus arvensis</i>	weed	forb	COAR2	<i>Convolvulus arvensis</i>	Field bindweed
CYOF	<i>Cynoglossum officinale</i>	weed	forb	CYOF	<i>Cynoglossum officinale</i>	Houndstongue
HYPE	<i>Hypericum perforatum</i>	weed	forb	HYPE	<i>Hypericum perforatum</i>	St. Johnswort
ISTI	<i>Isatis tinctoria</i>	weed	forb	ISTI	<i>Isatis tinctoria</i>	Dyers woad
LIDA	<i>Linaria dalmatica</i>	weed	forb	LIDA	<i>Linaria dalmatica</i>	Dalmation toadflax
LIVU2	<i>Linaria vulgaris</i>	weed	forb	LIVU2	<i>Linaria vulgaris</i>	Yellow toadflax
LYSA2	<i>Lythrum salicaria</i>	weed	forb	LYSA	<i>Lythrum salicaria</i>	Purple loosestrife
POSA4	<i>Polygonum sachalinense</i>	weed	forb	POSA2	<i>Polygonum sachalinense</i>	Giant knotweed
SEJA	<i>Senecio jacobaea</i>	weed	forb	SEJA	<i>Senecio jacobaea</i>	Tansy ragwort
SIMA3	<i>Silybum marianum</i>	weed	forb	SIMA3	<i>Silybum marianum</i>	Milk thistle
TRTE	<i>Tribulus terrestris</i>	weed	forb	TRTE	<i>Tribulus terrestris</i>	Puncturevine
CORTA	<i>Cortaderia spp.</i>	weed	grami	CORTA?	<i>Cortaderia spp.</i>	Pampas grasses
CYES3	<i>Cyperus esculentus</i>	weed	grami	CYES	<i>Cyperus esculentus</i>	Yellow nutsedge

## Annual Inventory 2007, Appendix 1: National Forest Plots Special Rules

PLANTS	PLANTS species	use	form	R6code	R6 old species	common_name
ELRE4	<i>Elymus repens</i>	weed	grami	AGRE	<i>Agropyron repens</i>	Quackgrass
TACA8	<i>Taeniatherum caput-medusae</i>	weed	grami	TACA2	<i>Taeniatherum caput-medusae</i>	Medusahead rye

**Central Oregon****Deschutes, Fremont, Ochoco, and Winema National Forests, and the Crooked River National Grassland.**

ID Guide: Hopkins, William, and Robert Rawlings. 1988 (revised version). Major Indicator Shrubs and Herbs on National Forests of Eastern Oregon. USDA Forest Service, Pacific Northwest Region R6-TM-190-1985.

PLANTS	PLANTS species	use	form	R6code	R6 old species	common_name
CHCHC4	<i>Chrysolepis chrysophylla</i> va. <i>chrysophylla</i>	indi	tree	CACH	<i>Castanopsis chrysophylla</i>	Golden Chinquapin
CONU4	<i>Cornus nuttallii</i>	indi	tree	CONU	<i>Cornus nuttallii</i>	Pacific dogwood
CELE3	<i>Cercocarpus ledifolius</i>	indi	tree	CELE	<i>Cercocarpus ledifolius</i>	curlleaf mountain mahogany
ACCI	<i>Acer circinatum</i>	indi	shrub	ACCI	<i>Acer circinatum</i>	Vine maple
ACGLD4	<i>Acer glabrum</i> var. <i>Douglasii</i>	indi	shrub	ACGLD	<i>Acer glabrum</i> var. <i>Douglasii</i>	Douglas maple
AMAL2	<i>Amelanchier alnifolia</i>	indi	shrub	AMALA	<i>Amelanchier alnifolia</i>	Saskatoon Serviceberry
ARNE	<i>Arctostaphylos nevadensis</i>	indi	shrub	ARNE	<i>Arctostaphylos nevadensis</i>	pinemat manzanita
ARPA6	<i>Arctostaphylos patula</i>	indi	shrub	ARPA	<i>Arctostaphylos patula</i>	Greenleaf Manzanita
ARUV	<i>Arctostaphylos uva-ursi</i>	indi	shrub	ARUV	<i>Arctostaphylos uva-ursi</i>	Bearberry, Kinnikinnick
ARAR8	<i>Artemisia arbuscula</i>	indi	shrub	ARAR	<i>Artemisia arbuscula</i>	low sagebrush
ARRI2	<i>Artemisia rigida</i>	indi	shrub	ARRI	<i>Artemisia rigida</i>	stiff sagebrush
ARTR2	<i>Artemisia tridentata</i>	indi	shrub	ARTR	<i>Artemisia tridentata</i>	Big Sagebrush
ARTRV	<i>Artemisia tridentata</i> ssp. <i>vaseyana</i>	indi	shrub	ARTRV	<i>Artemisia tridentata vaseyana</i>	mountain big sagebrush
CEPR	<i>Ceanothus prostratus</i>	indi	shrub	CEPR	<i>Ceanothus prostratus</i>	Squawcarpet
CEVE	<i>Ceanothus velutinus</i>	indi	shrub	CEVE	<i>Ceanothus velutinus</i>	Snowbrush Ceanothus
CHUM	<i>Chimaphila umbellata</i>	indi	shrub	CHUM	<i>Chimaphila umbellata</i>	pipsissewa
COCO6	<i>Corylus cornuta</i>	indi	shrub	COCO2	<i>Corylus cornuta</i>	California Hazel
HODI	<i>Holodiscus discolor</i>	indi	shrub	HODI	<i>Holodiscus discolor</i>	oceanspray
LOCA6	<i>Lonicera caerulea</i>	indi	shrub	LOCA3	<i>Lonicera caerulea</i>	Fly Honeysuckle
LOCO5	<i>Lonicera conjugialis</i>	indi	shrub	LOCO	<i>Lonicera conjugialis</i>	Purpleflower Honeysuckle
LOIN5	<i>Lonicera involucrata</i>	indi	shrub	LOIN	<i>Lonicera involucrata</i>	Bearberry Honeysuckle
MAAQ2	<i>Mahonia aquifolium</i>	indi	shrub	BEAQ	<i>Berberis aquifolium</i>	Tall Oregon Grape
MANE2	<i>Mahonia nervosa</i>	indi	shrub	BENE	<i>Berberis nervosa</i>	Oregon Grape
MARE11	<i>Mahonia repens</i>	indi	shrub	BERE	<i>Berberis repens</i>	Creeping Oregon Grape
PAMY	<i>Paxistima myrsinites</i>	indi	shrub	PAMY	<i>Pachistima myrsinites</i>	Oregon Boxwood
PHMA5	<i>Physocarpus malvaceus</i>	indi	shrub	PHMA	<i>Physocarpus malvaceus</i>	ninebark
PUTR2	<i>Purshia tridentata</i>	indi	shrub	PUTR	<i>Purshia tridentata</i>	bitterbrush
RICE	<i>Ribes cereum</i>	indi	shrub	RICE	<i>Ribes cereum</i>	Squaw Current
RILA	<i>Ribes lacustre</i>	indi	shrub	RILA	<i>Ribes lacustre</i>	Prickly currant
RIVI3	<i>Ribes viscosissimum</i>	indi	shrub	RIVI	<i>Ribes viscosissimum</i>	Sticky Currant
ROGY	<i>Rosa gymnocarpa</i>	indi	shrub	ROGY	<i>Rosa gymnocarpa</i>	Baldhip Rose
RUPA	<i>Rubus parviflorus</i>	indi	shrub	RUPA	<i>Rubus parviflorus</i>	Thimbleberry
SASC	<i>Salix scouleriana</i>	indi	shrub	SASC	<i>Salix scouleriana</i>	Scouler's Willow
SPBE2	<i>Spiraea betulifolia</i>	indi	shrub	SPBE	<i>Spiraea betulifolia</i>	birchleaf spirea
SPDOM	<i>Spiraea douglasii</i> var.	indi	shrub	SPDOM	<i>Spiraea douglasii</i>	Menzies Spirea

## Annual Inventory 2007, Appendix 1: National Forest Plots Special Rules

PLANTS	PLANTS species	use	form	R6code	R6 old species	common_name
	<i>menzensii</i>				<i>menzensii</i>	
SYAL	<i>Symphoricarpos albus</i>	indi	shrub	SYAL	<i>Symphoricarpos albus</i>	Common snowberry
SYHE	<i>Symphoricarpos hesperius</i>	indi	shrub	SYMO	<i>Symphoricarpos mollis</i>	Trailing Snowberry
VACA13	<i>Vaccinium caespitosum</i>	indi	shrub	VACA	<i>Vaccinium caespitosum</i>	Dwarf Huckleberry
VAME	<i>Vaccinium membranaceum</i>	indi	shrub	VAME	<i>Vaccinium membranaceum</i>	big huckleberry
VASC	<i>Vaccinium scoparium</i>	indi	shrub	VASC	<i>Vaccinium scoparium</i>	grouse huckleberry
VAUL	<i>Vaccinium uliginosum</i>	indi	shrub	VAOC2	<i>Vaccinium occidentale</i>	Bog blueberry
ACMI2	<i>Achillea millefolium</i>	indi	forb	ACMI	<i>Achillea millefolium</i>	Western Yarrow
ACTR	<i>Achlys triphylla</i>	indi	forb	ACTR	<i>Achlys triphylla</i>	Vanilla Leaf
ANOR	<i>Anemone oregana</i>	indi	forb	ANOR	<i>Anemone oregana</i>	Oregon Anemone
ANPI	<i>Anemone piperi</i>	indi	forb	ANPI	<i>Anemone piperi</i>	Piper's Anemone
ARKI	<i>Arenaria kingii</i>	indi	forb	ARKI	<i>Arenaria kingii</i>	King's Sandwort
ARCO9	<i>Arnica cordifolia</i>	indi	forb	ARCO	<i>Arnica cordifolia</i>	heart-leaf arnica
ARLA8	<i>Arnica latifolia</i>	indi	forb	ARLA	<i>Arnica latifolia</i>	Broadleaf Arnica
BASA3	<i>Balsamorhiza sagittata</i>	indi	forb	BASA	<i>Balsamorhiza sagittata</i>	Arrowleaf Balsamroot
CIVU	<i>Cirsium vulgare</i>	indi	forb	CIVU	<i>Cirsium vulgare</i>	bull thistle
CLUN2	<i>Clintonia uniflora</i>	indi	forb	CLUN	<i>Clintonia uniflora</i>	queen's cup beadleilly
DITR2	<i>Disporum trachycarpum</i>	indi	forb	DITR	<i>Disporum tracycarpum</i>	fairy bells
EUCO36	<i>Eurybia conspicua</i>	indi	forb	ASCO	<i>Aster conspicuus</i>	Showy Aster
FRVI	<i>Fragaria virginiana</i>	indi	forb	FRVI	<i>Fragaria virginiana</i>	Strawberry
GOOB2	<i>Goodyera oblongifolia</i>	indi	forb	GOOB	<i>Goodyera oblongifolia</i>	Western Rattlesnake-Plantain
HABL3	<i>Haplopappus bloomeri</i>	indi	forb	HABL	<i>Haplopappus bloomeri</i>	Rabbitbrush Goldenweed
HIAL2	<i>Hieracium albiflorum</i>	indi	forb	HIAL	<i>Hieracium albiflorum</i>	White Hawkweed
HICY	<i>Hieracium cynoglossoides</i>	indi	forb	HIAL2	<i>Hieracium albertinum</i>	Western Hawkweed
LALA3	<i>Lathyrus lanszwertii</i>	indi	forb	LALA2	<i>Lathyrus lanszwertii</i>	Thick-Leaved Peavine
LINUN	<i>Linanthus nuttallii</i> ssp. <i>nuttallii</i>	indi	forb	LINU	<i>Linanthastrum nuttallii</i>	Linanthastrum
LIBO3	<i>Linnaea borealis</i>	indi	forb	LIBO2	<i>Linnaea borealis</i>	twinflower
LUAL3	<i>Lupinus albicaulis</i>	indi	forb	LUAL	<i>Lupinus albicaulis</i>	Pine Lupine
LUAR3	<i>Lupinus argenteus</i>	indi	forb	LUAR3	<i>Lupinus argenteus</i>	Silvery Lupine
LUCA	<i>Lupinus caudatus</i>	indi	forb	LUCA	<i>Lupinus caudatus</i>	Tailcup Lupine
MARA7	<i>Maianthemum racemosum</i>	indi	forb	SMRA	<i>Smilacina racemosa</i>	False Solomn's Seal
MAST4	<i>Maianthemum stellatum</i>	indi	forb	SMST	<i>Smilacina stellata</i>	Starry Solomn's Seal
MIST3	<i>Mitella stauropetala</i>	indi	forb	MIST2	<i>Mitella stauropetala</i>	Side-Flowered Mitrewort
MOMA3	<i>Moehringia macrophylla</i>	indi	forb	ARMA3	<i>Arenaria macrophylla</i>	Bigleaf Sandwort
ORSE	<i>Orthilia secunda</i>	indi	forb	PYSE	<i>Pyrola secunda</i>	Sidebells Pyrola
OSBE	<i>Osmorhiza berteroi</i>	indi	forb	OSCH	<i>Osmorhiza chilensis</i>	Sweet Cicely
PEEU	<i>Penstemon euglaucus</i>	indi	forb	PEEU	<i>Penstemon euglaucus</i>	Glaucus Penstemon
PELA7	<i>Penstemon laetus</i>	indi	forb	PELA	<i>Penstemon laetus</i>	Gay Penstemon
POPU3	<i>Polemonium pulcherrimum</i>	indi	forb	POPU	<i>Polemonium pulcherrimum</i>	Jacob's ladder
PSJA2	<i>Pseudostellaria jamesiana</i>	indi	forb	STJA	<i>Stellaria jamesiana</i>	Tuber Starwort
PTAQ	<i>Pteridium aquilinum</i>	indi	forb	PTAQ	<i>Pteridium aquilinum</i>	bracken fern
THOC	<i>Thalictrum occidentale</i>	indi	forb	THOC	<i>Thalictrum occidentale</i>	Western Meadowrue
TRBOL	<i>Trientalis borealis</i> ssp. <i>latifolia</i>	indi	forb	TRLA2	<i>Trientalis latifolia</i>	Western Starflower

## Annual Inventory 2007, Appendix 1: National Forest Plots Special Rules

PLANTS	PLANTS species	use	form	R6code	R6 old species	common_name
WYAM	<i>Wyethia amplexicaulis</i>	indi	forb	WYAM	<i>Wyethia amplexicaulis</i>	Mules Ear Wyethia
WYHE2	<i>Wyethia helianthoides</i>	indi	forb	WYHE	<i>Wyethia helianthoides</i>	White-Head Wyethia
WYMO	<i>Wyethia mollis</i>	indi	forb	WYMO	<i>Wyethia mollis</i>	Woolly Wyethia
XETE	<i>Xerophyllum tenax</i>	indi	forb	XETE	<i>Xerophyllum tenax</i>	Beargrass
ACOCO	<i>Achnatherum occidentale</i> <i>ssp. occidentale</i>	indi	grami	STOC	<i>Stipa occidentalis</i>	western needlegrass
BRCA5	<i>Bromus carinatus</i>	indi	grami	BRCA	<i>Bromus carinatus</i>	California Brome
BRTE	<i>Bromus tectorum</i>	indi	grami	BRTE	<i>Bromus tectorum</i>	Cheatgrass
BRVU	<i>Bromus vulgaris</i>	indi	grami	BRVU	<i>Bromus vulgaris</i>	columbia brome
CARU	<i>Calamagrostis rubescens</i>	indi	grami	CARU	<i>Calamagrostis rubescens</i>	pinegrass
CAST13	<i>Calamagrostis stricta</i> ssp. <i>inexpansa</i>	indi	grami	CAIN	<i>Calamagrostis</i> <i>inexpansa</i>	Northern Reedgrass
CACO11	<i>Carex concinnoides</i>	indi	grami	CACO	<i>Carex concinnoides</i>	Northwestern Sedge
CAGE2	<i>Carex geyeri</i>	indi	grami	CAGE	<i>Carex geyeri</i>	elk sedge
CANE2	<i>Carex nebrascensis</i>	indi	grami	CANE	<i>Carex nebraskensis</i>	Nebraska sedge
CAPEV	<i>Carex pensylvanica</i> var. <i>vespertina</i>	indi	grami	CAPE5	<i>Carex pensylvanica</i>	Long-Stolon Sedge
CARO5	<i>Carex rossii</i>	indi	grami	CARO	<i>Carex rossii</i>	ross' sedge
ELELE	<i>Elymus elymoides</i> ssp. <i>elymoides</i>	indi	grami	SIHY	<i>Sitanion hystrix</i>	Bottlebrush Squirreltail
ELGL	<i>Elymus glaucus</i>	indi	grami	ELGL	<i>Elymus glaucus</i>	Blue wildrye
FEID	<i>Festuca idahoensis</i>	indi	grami	FEID	<i>Festuca idahoensis</i>	idaho fescue
FEOC	<i>Festuca occidentalis</i>	indi	grami	FEOC	<i>Festuca occidentalis</i>	Western Fescue
PONE2	<i>Poa nervosa</i>	indi	grami	PONE	<i>Poa nervosa</i>	Wheeler's Bluegrass
POSE	<i>Poa secunda</i>	indi	grami	POSA3	<i>Poa sandbergii</i>	Sandberg's Bluegrass
LUHI4	<i>Luzula hitchcocki</i>	indi	grami	LUHI	<i>Luzula hitchcocki</i>	Smooth Woodrush
LUMUM2	<i>Luzula multiflora</i> ssp. <i>multiflora</i> var. <i>multiflora</i>	indi	grami	LUCAM	<i>Luzula campestris</i> <i>multiflora</i>	Common Woodrush
PSSPS	<i>Pseudoroegneria spicata</i> <i>ssp. spicata</i>	indi	grami	AGSP	<i>Agropyron spicatum</i>	bluebunch wheatgrass
ACRE3	<i>Acroptilon repens</i>	weed	forb	CERE	<i>Centaurea repens</i>	Russian Knapweed
CANU4	<i>Carduus nutans</i>	weed	forb	CANU	<i>Carduus nutans</i>	musk thistle
CEBI2	<i>Centaurea biebersteinii</i>	weed	forb	CEMA	<i>Centaurea maculosa</i>	spotted knapweed
CESO3	<i>Centaurea solstitialis</i>	weed	forb	CESO	<i>Centaurea solstitialis</i>	yellow starthistle
CEDI3	<i>Centurea diffusa</i>	weed	forb	CEDI	<i>Centurea diffusa</i>	diffuse knapweed
CIAR4	<i>Cirsium arvense</i>	weed	forb	CIAR	<i>Cirsium arvense</i>	canada thistle
EUES	<i>Euphorbia esula</i>	weed	forb	EUES	<i>Euphorbia esula</i>	leafy spurge
HYPE	<i>Hypericum perforatum</i>	weed	forb	HYPE	<i>Hypericum perforatum</i>	common st. john's wort
ISTI	<i>Isatis tinctoria</i>	weed	forb	ISTI	<i>Isatis tinctoria</i>	Dyers Woad
LIDA	<i>Linaria dalmatica</i>	weed	forb	LIDA	<i>Linaria dalmatica</i>	dalmation toadflax
ONAC	<i>Onopordum acanthium</i>	weed	forb	ONAC	<i>Onopordum acanthium</i>	scotch thistle
SAAE	<i>Salvia aethiopis</i>	weed	forb	SAAE	<i>Salvia aethiopis</i>	mediterranean sage
SEJA	<i>Senecio jacobaea</i>	weed	forb	SEJA	<i>Senecio jacobaea</i>	fansy ragwort
TACA8	<i>Taeniatherum caput-</i> <i>medusae</i>	weed	grami	TACA	<i>Taeniatherum caput-</i> <i>medusae</i>	medusa head

**NE Oregon****Malheur, Umatilla, and Wallowa-Whitman National Forests.**

Note: only record those species that apply to the appropriate vegetation series for the plot (e.g. ABLA2 or PIPO). Record any weed found on the plot.

ID Guide: Johnson, Charles Grier Jr. 1993. Common Plants of the Inland Pacific Northwest, Malheur, Umatilla, Wallowa-Whitman National Forests. USDA Forest Service, Pacific Northwest Region R6-ERW-TP051-93.

PLANTS	PLANTS species	use	form	R6code	R6 old species	common_name
ACGLD4	<i>Acer glabrum</i> var. <i>Douglasii</i>	ABGR	tree	ACGL	<i>Acer glabrum</i> var. <i>Douglasii</i>	Douglas maple
CELE3	<i>Cercocarpus ledifolius</i>	JUOC	tree	CELE	<i>Cercocarpus ledifolius</i>	curlleaf mountain mahogany
TABR2	<i>Taxus brevifolia</i>	ABGR	tree	TABR	<i>Taxus brevifolia</i>	western yew
ALVIS	<i>Alnus viridis</i> ssp. <i>sinuata</i>	ABGR	shrub	ALSI	<i>Alnus sinuata</i>	sitka alder
ARNE	<i>Arctostaphylos nevadensis</i>	ABGR	shrub	ARNE	<i>Arctostaphylos nevadensis</i>	pinemat manzanita
ARAR8	<i>Artemisia arbuscula</i>	JUOC	shrub	ARAR	<i>Artemisia arbuscula</i>	low sagebrush
ARRI2	<i>Artemisia rigida</i>	JUOC	shrub	ARRI	<i>Artemisia rigida</i>	stiff sagebrush
ARTRV	<i>Artemisia tridentata</i> ssp. <i>vaseyana</i>	JUOC	shrub	ARTRV	<i>Artemisia tridentata vaseyana</i>	mountain big sagebrush
HODI	<i>Holodiscus discolor</i>	PSME	shrub	HODI	<i>Holodiscus discolor</i>	oceanspray
MEFE	<i>Menziesia ferruginea</i>	ABLA2	shrub	MEFE	<i>Menziesia ferruginea</i>	fool's huckleberry
PERA4	<i>Peraphyllum ramosissimum</i>	PIPO	shrub	PERA3	<i>Peraphyllum ramosissimum</i>	squaw apple
PHEM	<i>Phyllodoce empetriformis</i>	ABLA2	shrub	PHEM	<i>Phyllodoce empetriformis</i>	pink mountain-heath
PHMA5	<i>Physocarpus malvaceus</i>	PSME	shrub	PHMA	<i>Physocarpus malvaceus</i>	ninebark
PUTR2	<i>Purshia tridentata</i>	JUOC	shrub	PUTR	<i>Purshia tridentata</i>	bitterbrush
RHAL2	<i>Rhododendron albiflorum</i>	ABLA2	shrub	RHAL	<i>Rhododendron albiflorum</i>	cascades azalea
RHGL	<i>Rhus glabra</i>	PIPO	shrub	RHGL	<i>Rhus glabra</i>	smooth sumac
SPBE2	<i>Spiraea betulifolia</i>	ABGR	shrub	SPBE	<i>Spiraea betulifolia</i>	birchleaf spirea
SYAL	<i>Symphoricarpos albus</i>	PSME	shrub	SYAL	<i>Symphoricarpos albus</i>	Common snowberry
SYOR2	<i>Symphoricarpos oreophilus</i>	PSME	shrub	SYOR	<i>Symphoricarpos oreophilus</i>	mountain snowberry
VAME	<i>Vaccinium membranaceum</i>	ABLA2	shrub	VAME	<i>Vaccinium membranaceum</i>	big huckleberry
VASC	<i>Vaccinium scoparium</i>	ABLA2	shrub	VASC	<i>Vaccinium scoparium</i>	grouse huckleberry
ADBI	<i>Adenocaulon bicolor</i>	ABGR	forb	ADBI	<i>Adenocaulon bicolor</i>	trail plant
ARCO9	<i>Arnica cordifolia</i>	ABGR	forb	ARCO	<i>Arnica cordifolia</i>	heart-leaf arnica
ASCA2	<i>Asarum caudatum</i>	ABGR	forb	ASCA3	<i>Asarum caudatum</i>	wild ginger
CLUN2	<i>Clintonia uniflora</i>	ABGR	forb	CLUN	<i>Clintonia uniflora</i>	queen's cup beadlilly
COOC2	<i>Coptis occidentalis</i>	ABGR	forb	COOC2	<i>Coptis occidentalis</i>	goldthread
COCA13	<i>Cornus canadensis</i>	ABGR	forb	COCA	<i>Cornus canadensis</i>	bunchberry
DITR2	<i>Disporum trachycarpum</i>	ABGR	forb	DITR	<i>Disporum trachycarpum</i>	fairy bells
GYDR	<i>Gymnocarpium dryopteris</i>	ABGR	forb	GYDR	<i>Gymnocarpium dryopteris</i>	oak fern
LIBO3	<i>Linnaea borealis</i>	ABGR	forb	LIBO2	<i>Linnaea borealis</i>	twinflower
POMU	<i>Polystichum munitum</i>	ABGR	forb	POMU	<i>Polystichum munitum</i>	western swordfern
POPU3	<i>Polemonium pulcherrimum</i>	ABLA2	forb	POPU	<i>Polemonium pulcherrimum</i>	Jacob's ladder
POPH	<i>Polygonum phytolaccaefolium</i>	ABLA2	forb	POPH	<i>Polygonum phytolaccaefolium</i>	pokeweed fleecflower

## Annual Inventory 2007, Appendix 1: National Forest Plots Special Rules

PLANTS	PLANTS species	use	form	R6code	R6 old species	common_name
PTAQ	<i>Pteridium aquilinum</i>	ABGR	forb	PTAQ	<i>Pteridium aquilinum</i>	bracken fern
SETR	<i>Senecio triangularis</i>	ABLA2	forb	SETR	<i>Senecio triangularis</i>	arrowleaf groundsel
STAM2	<i>Streptopus amplexifolius</i>	ABLA2	forb	STAM	<i>Streptopus amplexifolius</i>	twisted stalk
TITRU	<i>Tiarella trifoliata</i> var. <i>unifoliata</i>	ABGR	forb	TITRU	<i>Tiarella trifoliata</i> <i>unifoliata</i>	coolwort foamflower
TRCA	<i>Trautvetteria caroliniensis</i>	ABGR	forb	TRCA3	<i>Trautvetteria caroliniensis</i>	false bugbane
VASI	<i>Valeriana sitchensis</i>	ABLA2	forb	VASI	<i>Valeriana sitchensis</i>	sitka valerian
JUDR	<i>Juncus drummondii</i>	ABLA2	grami	JUDR	<i>Juncus drummondii</i>	drummond rush
ACOCO	<i>Achnatherum occidentale</i> ssp. <i>occidentale</i>	ABLA2	grami	STOC	<i>Stipa occidentalis</i>	western needlegrass
BRVU	<i>Bromus vulgaris</i>	ABGR	grami	BRVU	<i>Bromus vulgaris</i>	columbia brome
CARU	<i>Calamagrostis rubescens</i>	ABGR	grami	CARU	<i>Calamagrostis rubescens</i>	pinegrass
CAGE2	<i>Carex geyeri</i>	ABGR	grami	CAGE	<i>Carex geyeri</i>	elk sedge
CARO5	<i>Carex rossii</i>	ABGR	grami	CARO	<i>Carex rossii</i>	ross' sedge
FEID	<i>Festuca idahoensis</i>	PIPO	grami	FEID	<i>Festuca idahoensis</i>	idaho fescue
POSE	<i>Poa secunda</i>	JUOC	grami	POSA	<i>Poa sandbergii</i>	Sandberg's Bluegrass
POWH2	<i>Poa wheeleri</i>	PIPO	grami	PONEW	<i>Poa nervosa wheeleri</i>	wheeler's bluegrass
PSSPS	<i>Pseudoroegneria spicata</i> ssp. <i>spicata</i>	PIPO	grami	AGSP	<i>Agropyron spicatum</i>	bluebunch wheatgrass
CYSC4	<i>Cytisus scoparius</i>	weed	shrub	CYSC4	<i>Cytisus scoparius</i>	broom, Scotch
ACRE3	<i>Acroptilon repens</i>	weed	forb	ACRE3	<i>Acroptilon repens</i>	russian knapweed
CADR	<i>Cardaria draba</i>	weed	forb	CADR2	<i>Cardaria draba</i>	white top (hoary cress)
CANU4	<i>Carduus nutans</i>	weed	forb	CANU4	<i>Carduus nutans</i>	musk thistle
CEBI2	<i>Centaurea biebersteinii</i>	weed	forb	CEMA	<i>Centaurea maculosa</i>	spotted knapweed
CESO3	<i>Centaurea solstitialis</i>	weed	forb	CESO	<i>Centaurea solstitialis</i>	yellow starthistle
CEDI3	<i>Centurea diffusa</i>	weed	forb	CEDI	<i>Centurea diffusa</i>	diffuse knapweed
CHJU	<i>Chondrilla juncea</i>	weed	forb	CHJU	<i>Chondrilla juncea</i>	rush skeletonweed
CIDO	<i>Cicuta douglasii</i>	weed	forb	CIDO	<i>Cicuta douglasii</i>	water hemlock
CIAR4	<i>Cirsium arvense</i>	weed	forb	CIAR	<i>Cirsium arvense</i>	canada thistle
CIVU	<i>Cirsium vulgare</i>	weed	forb	CIVU	<i>Cirsium vulgare</i>	bull thistle
COMA2	<i>Conium maculatum</i>	weed	forb	COMA2	<i>Conium maculatum</i>	poison hemlock
CYOF	<i>Cynoglossum officinale</i>	weed	forb	CYOF	<i>Cynoglossum officinale</i>	hound's tongue
DIFU2	<i>Dipsacus sylvestris</i>	weed	forb	DISY	<i>Dipsacus sylvestris</i>	teasel
EUES	<i>Euphorbia esula</i>	weed	forb	EUES	<i>Euphorbia esula</i>	leafy spurge
HEPU5	<i>Hemizonia pungens</i>	weed	forb	HEPU2	<i>Hemizonia pungens</i>	spikeweed
HYNI	<i>Hyoscyamus niger</i>	weed	forb	HYNI	<i>Hyoscyamus niger</i>	black henbane
HYPE	<i>Hypericum perforatum</i>	weed	forb	HYPE	<i>Hypericum perforatum</i>	common st. john's wort
LELA2	<i>Lepidium latifolium</i>	weed	forb	LELA	<i>Lepidium latifolium</i>	perennial pepperweed
LIDA	<i>Linaria dalmatica</i>	weed	forb	LIDA	<i>Linaria dalmatica</i>	dalmation toadflax
LIVU2	<i>Linaria vulgaris</i>	weed	forb	LIVU	<i>Linaria vulgaris</i>	yellow toadflax
LYSA2	<i>Lythrum salicaria</i>	weed	forb	LYSA	<i>Lythrum salicaria</i>	purple loosestrife
ONAC	<i>Onopordum acanthium</i>	weed	forb	ONAC	<i>Onopordum acanthium</i>	scotch thistle
PORE5	<i>Potentilla recta</i>	weed	forb	PORE5	<i>Potentilla recta</i>	cinquefoil, sulfur
SAAE	<i>Salvia aethiopsis</i>	weed	forb	SAAE2	<i>Salvia aethiopsis</i>	mediterranean sage
SAOF4	<i>Saponaria officinallis</i>	weed	forb	SAOF2	<i>Saponaria officinallis</i>	bouncing bet, soapwort
SEJA	<i>Senecio jacobaea</i>	weed	forb	SEJA	<i>Senecio jacobaea</i>	tansy ragwort
TAVU	<i>Tanacetum vulgare</i>	weed	forb	TAVU	<i>Tanacetum vulgare</i>	common tansy
TRTE	<i>Tribulus terrestris</i>	weed	forb	TRTR	<i>Tribulus terrestris</i>	puncturevine
ZIVE	<i>Zigadenus venenosus</i>	weed	forb	ZIVE	<i>Zigadenus venenosus</i>	meadow deathcamus



## Annual Inventory 2007, Appendix 1: National Forest Plots Special Rules

PLANTS	PLANTS species	use	form	R6code	R6 old species	common_name
THIN6	<i>Thinopyrum intermedium</i>	weed	grami	AGIN2	<i>Agropyron intermedium</i>	intermediate wheatgrass
THIN6	<i>Thinopyrum intermedium</i>	weed	grami	AGTR2	<i>Agropyron trichophorum</i>	pubescent wheatgrass
DAGL	<i>Dactylis glomerata</i>	weed	grami	DAGL	<i>Dactylis glomerata</i>	orchard grass
LOLIU	<i>Lolium spp</i>	weed	grami	LOLIU	<i>Lolium spp</i>	ryegrass
PHPR3	<i>Phleum pratense</i>	weed	grami	PHPR	<i>Phleum pratense</i>	timothy
TACA8	<i>Taeniatherum caput-medusae</i>	weed	grami	TACA	<i>Taeniatherum caput-medusae</i>	medusa head
ACGLD4	<i>Acer glabrum var. Douglasii</i>	nfor	tree	ACGLD	<i>Acer glabrum var. Douglasii</i>	Douglas maple
CELE3	<i>Cercocarpus ledifolius</i>	nfor	tree	CELE	<i>Cercocarpus ledifolius</i>	curleaf mountain mahogany
ALVIS	<i>Alnus viridis ssp. sinuata</i>	nfor	shrub	ALSI	<i>Alnus sinuata</i>	sitka alder
AMAL2	<i>Amelanchier alnifolia</i>	nfor	shrub	AMAL	<i>Amelanchier alnifolia</i>	Saskatoon Serviceberry
ARAR8	<i>Artemisia arbuscula</i>	nfor	shrub	ARAR	<i>Artemisia arbuscula</i>	low sagebrush
ARRI2	<i>Artemisia rigida</i>	nfor	shrub	ARRI	<i>Artemisia rigida</i>	stiff sagebrush
ARTRV	<i>Artemisia tridentata ssp. vaseyana</i>	nfor	shrub	ARTRV	<i>Artemisia tridentata vaseyana</i>	mountain big sagebrush
CEVE	<i>Ceanothus velutinus</i>	nfor	shrub	CEVE	<i>Ceanothus velutinus</i>	Snowbrush Ceanothus
CELAR	<i>Celtis laevigata var. reticulata</i>	nfor	shrub	CERE2	<i>Celtis reticulata</i>	Netleaf Hackberry
GLSPA	<i>Glossopetalon spinescens var. aridium</i>	nfor	shrub	GLNE	<i>Glossopetalon nevadense</i>	Snake River Green-Bush
HODI	<i>Holodiscus discolor</i>	nfor	shrub	HODI	<i>Holodiscus discolor</i>	oceanspray
PERA4	<i>Peraphyllum ramosissimum</i>	nfor	shrub	PERA3	<i>Peraphyllum ramosissimum</i>	squaw apple
PHLE4	<i>Philadelphus lewisii</i>	nfor	shrub	PHLE4	<i>Philadelphus lewisii</i>	Lewis' Mock Orange
PHMA5	<i>Physocarpus malvaceus</i>	nfor	shrub	PHMA	<i>Physocarpus malvaceus</i>	ninebark
PRUNU	<i>Prunus spp</i>	nfor	shrub	PRUNUS	<i>Prunus spp</i>	Cherry Or Choke Cherry
PUTR2	<i>Purshia tridentata</i>	nfor	shrub	PUTR	<i>Purshia tridentata</i>	bitterbrush
RHGL	<i>Rhus glabra</i>	nfor	shrub	RHGL	<i>Rhus glabra</i>	smooth sumac
ROSA5	<i>Rosa spp.</i>	nfor	shrub	ROSA	<i>Rosa spp.</i>	Rose
SYAL	<i>Symphoricarpos albus</i>	nfor	shrub	SYAL	<i>Symphoricarpos albus</i>	Common snowberry
SYOR2	<i>Symphoricarpos oreophilus</i>	nfor	shrub	SYOR	<i>Symphoricarpos oreophilus</i>	mountain snowberry
ASCU5	<i>Astragalus cusickii</i>	nfor	forb	ASCU4	<i>Astragalus cusickii</i>	Cusick's Milkvetch
ASIN5	<i>Astragalus inflexus</i>	nfor	forb	ASIN2	<i>Astragalus inflexus</i>	Hairy Milkvetch
BAIN	<i>Balsamorhiza incana</i>	nfor	forb	BAIN	<i>Balsamorhiza incana</i>	Hoary Balsmroot
BASA3	<i>Balsamorhiza sagittata</i>	nfor	forb	BASA	<i>Balsamorhiza sagittata</i>	Arrowleaf Balsamroot
CACU2	<i>Camassia cusickii</i>	nfor	forb	CACU	<i>Camassia cusickii</i>	Cusick's Camas
ERCH4	<i>Erigeron chrysopsidis</i>	nfor	forb	ERCH	<i>Erigeron chrysopsidis</i>	Dwarf Yellow Fleabane
ERPU2	<i>Erigeron pumilus</i>	nfor	forb	ERPU	<i>Erigeron pumilus</i>	Shaggy Fleabane
ERDO	<i>Eriogonum douglasii</i>	nfor	forb	ERDO	<i>Eriogonum douglasii</i>	Douglas' Buckwheat
ERFL4	<i>Eriogonum flavum</i>	nfor	forb	ERFL	<i>Eriogonum flavum</i>	Golden Buckwheat
ERHE2	<i>Eriogonum heracleoides</i>	nfor	forb	ERHE	<i>Eriogonum heracleoides</i>	Creamy Or Wyeth's Buckwheat
ERMI4	<i>Eriogonum microthecum</i>	nfor	forb	ERMI	<i>Eriogonum microthecum</i>	Slender Buckwheat
ERST4	<i>Eriogonum strictum</i>	nfor	forb	ERST2	<i>Eriogonum strictum</i>	Strict Buckwheat
ERUMM	<i>Eriogonum umbellatum var. majus</i>	nfor	forb	ERUMS	<i>Eriogonum umbellatum subalpinum</i>	Sulfur Buckwheat

## Annual Inventory 2007, Appendix 1: National Forest Plots Special Rules

PLANTS	PLANTS species	use	form	R6code	R6 old species	common_name
FRAL2	<i>Frasera albicaulis</i>	nfor	forb	FRAL2	<i>Frasera albicaulis</i>	White Stemmed Frasera
GETR	<i>Geum triflorum</i>	nfor	forb	GETR	<i>Geum triflorum</i>	Red Avens, Old Man's Whiskers
HICY	<i>Hieracium cynoglossoides</i>	nfor	forb	HIAL2	<i>Hieracium albertinum</i>	Western Hawkweed
LECOW	<i>Lewisia columbiana</i> var. <i>wallowaensis</i>	nfor	forb	LECOW	<i>Lewisia columbiana wallowaensis</i>	Wallowa Lewisia
LOCO4	<i>Lomatium cous</i>	nfor	forb	LOCO2	<i>Lomatium cous</i>	Cous Biscuit-Root
LOMA3	<i>Lomatium macrocarpum</i>	nfor	forb	LOMA	<i>Lomatium macrocarpum</i>	Large Fruited Lomatium
LUCA	<i>Lupinus caudatus</i>	nfor	forb	LUCA	<i>Lupinus caudatus</i>	Tailcup Lupine
LUARL5	<i>Lupinus argenteus</i> ssp. <i>argenteus</i> var. <i>laxiflorus</i>	nfor	forb	LULA2	<i>Lupinus laxiflorus</i>	Spurred Lupine
LUSE4	<i>Lupinus sericeus</i>	nfor	forb	LUSE	<i>Lupinus sericeus</i>	Silky lupine
OECA10	<i>Oenothera caespitosa</i>	nfor	forb	OECA2	<i>Oenothera caespitosa</i>	Desert Evening Primrose
OPPO	<i>Opuntia polyacantha</i>	nfor	forb	OPPO	<i>Opuntia polyacantha</i>	Plains Prickly Pear
PEEL4	<i>Penstemon elegantulus</i>	nfor	forb	PEEL	<i>Penstemon elegantulus</i>	Lovely Penstemon
PEGL5	<i>Penstemon globosus</i>	nfor	forb	PEGL4	<i>Penstemon globosus</i>	Globe Penstemon
PETR6	<i>Penstemon triphyllus</i>	nfor	forb	PETR	<i>Penstemon triphyllus</i>	Whorled Penstemon
DAOR2	<i>Dalea ornata</i>	nfor	forb	PEOR4	<i>Petalostemon ornatus</i>	Western Prairie-Clover
PHCO10	<i>Phlox colubrina</i>	nfor	forb	PHCO2	<i>Phlox colubrina</i>	Snake River Phlox
PHOR2	<i>Physaria oregana</i>	nfor	forb	PHOR	<i>Physaria oregana</i>	Oregon Twinpod
POPH	<i>Polygonum phytolaccaefolium</i>	nfor	forb	POPH	<i>Polygonum phytolaccaefolium</i>	pokeweed fleecflower
SCAN3	<i>Scutellaria angustifolia</i>	nfor	forb	SCAN	<i>Scutellaria angustifolia</i>	Narrowleaf Skullcap
SELA	<i>Sedum lanceolatum</i>	nfor	forb	SELA2	<i>Sedum lanceolatum</i>	Lanceleaved Stonecrop
TRMA3	<i>Trifolium macrocephalum</i>	nfor	forb	TRMA	<i>Trifolium macrocephalum</i>	Bighead Clover
ACOCO	<i>Achnatherum occidentale</i> ssp. <i>occidentale</i>	nfor	grami	STOC	<i>Stipa occidentalis</i>	Western Needlegrass
ARPUL	<i>Aristida purpurea longiseta</i>	nfor	grami	ARLO3	<i>Aristida longiseta</i>	Fendler (Red) Threawn
BRCA5	<i>Bromus carinatus</i>	nfor	grami	BRCA	<i>Bromus carinatus</i>	California Brome
CAGE2	<i>Carex geyeri</i>	nfor	grami	CAGE	<i>Carex geyeri</i>	elk sedge
CAHO5	<i>Carex hoodii</i>	nfor	grami	CAHO	<i>Carex hoodii</i>	Hood's Sedge
CAPE7	<i>Carex petasata</i>	nfor	grami	CAPE	<i>Carex petasata</i>	Liddon's Sedge
DAIN	<i>Danthonia intermedia</i>	nfor	grami	DAIN	<i>Danthonia intermedia</i>	Timber Oatgrass
DAUN	<i>Danthonia unispicata</i>	nfor	grami	DAUN	<i>Danthonia unispicata</i>	One-Spike Oatgrass
ELELE	<i>Elymus elymoides</i> ssp. <i>elymoides</i>	nfor	grami	SIHY	<i>Sitanian hystrix</i>	Bottlebrush Squirreltail
LECI4	<i>Leymus cinereus</i>	nfor	grami	ELCI2	<i>Elymus cinereus</i>	Giant Wildrye
FEID	<i>Festuca idahoensis</i>	nfor	grami	FEID	<i>Festuca idahoensis</i>	idaho fescue
FEVI	<i>Festuca viridula</i>	nfor	grami	FEVI	<i>Festuca viridula</i>	green fescue
JUPA	<i>Juncus parryi</i>	nfor	grami	JUPA	<i>Juncus parryi</i>	Parry's rush
KOMA	<i>Koeleria macrantha</i>	nfor	grami	KOCR	<i>Koeleria cristata</i>	Prairie Junegrass
POWH2	<i>Poa wheeleri</i>	nfor	grami	PONEW	<i>Poa nervosa wheeleri</i>	wheeler's bluegrass
POPR	<i>Poa pratensis</i>	nfor	grami	POPR	<i>Poa pratensis</i>	Kentucky bluegrass
POSE	<i>Poa secunda</i>	nfor	grami	POSA	<i>Poa sandbergii</i>	Sandberg's Bluegrass
PSSPS	<i>Pseudoroegneria spicata</i> ssp. <i>spicata</i>	nfor	grami	AGSP	<i>Agropyron spicatum</i>	bluebunch wheatgrass
SPCR	<i>Sporobolus cryptandrus</i>	nfor	grami	SPCR	<i>Sporobolus cryptandrus</i>	Sand Dropseed

**NW Washington****Mt. Baker-Snoqualmie (605), Olympic (609) National Forests.**

ID Guide: Leshner, Robin D., and Jan A. Henderson. 1992. Indicator Species of Forested Plant Associations on National Forests of Northwestern Washington. USDA Forest Service, Pacific Northwest Region R6-MBS-TP-041-1992.

PLANTS	PLANTS species	Use	form	R6code	R6 old species	common_name
ACCI	<i>Acer circinatum</i>	indi	shrub	ACCI	<i>Acer circinatum</i>	Vine maple
ARUV	<i>Arctostaphylos uva-ursi</i>	indi	shrub	ARUV	<i>Arctostaphylos uva-ursi</i>	Bearberry, Kinnikinnick
CHME	<i>Chimaphila menziesii</i>	indi	shrub	CHME	<i>Chimaphila menziesii</i>	little prince's-pine
CHUM	<i>Chimaphila umbellata</i>	indi	shrub	CHUM	<i>Chimaphila umbellata</i>	pipsissewa
CLPY3	<i>Cladothamnus pyroliflorus</i>	indi	shrub	CLPY	<i>Cladothamnus pyrolaeiflorus</i>	copperbrush
FRPU7	<i>Frangula purshiana</i>	indi	shrub	RHPU	<i>Rhamnus purshiana</i>	cascara
GASH	<i>Gaultheria shallon</i>	indi	shrub	GASH	<i>Gaultheria shallon</i>	salal
HODI	<i>Holodiscus discolor</i>	indi	shrub	HODI	<i>Holodiscus discolor</i>	oceanspray
JUCO6	<i>Juniperus communis</i>	indi	shrub	JUCO4	<i>Juniperus communis</i>	common juniper
LOHI2	<i>Lonicera hispidula</i>	indi	shrub	LOHI	<i>Lonicera hispidula</i>	hairy honeysuckle
MANE2	<i>Mahonia nervosa</i>	indi	shrub	BENE	<i>Berberis nervosa</i>	Oregon Grape
OPHO	<i>Oplopanax horridus</i>	indi	shrub	OPHO	<i>Oplopanax horridus</i>	devil's club
PAMY	<i>Paxistima myrsinites</i>	indi	shrub	PAMY	<i>Pachistima myrsinites</i>	Oregon Boxwood
PHEM	<i>Phyllodoce empetriformis</i>	indi	shrub	PHEM	<i>Phyllodoce empetriformis</i>	pink mountain-heath
RHAL2	<i>Rhododendron albiflorum</i>	indi	shrub	RHAL	<i>Rhododendron albiflorum</i>	cascades azalea
RHMA3	<i>Rhododendron macrophyllum</i>	indi	shrub	RHMA	<i>Rhododendron macrophyllum</i>	Pacific rhododendron
RIBR	<i>Ribes bracteosum</i>	indi	shrub	RIBR	<i>Ribes bracteosum</i>	stink currant
ROGY	<i>Rosa gymnocarpa</i>	indi	shrub	ROGY	<i>Rosa gymnocarpa</i>	Baldhip Rose
RULA2	<i>Rubus lasiococcus</i>	indi	shrub	RULA	<i>Rubus lasiococcus</i>	dwarf bramble
RUPE	<i>Rubus pedatus</i>	indi	shrub	RUPE	<i>Rubus pedatus</i>	Five-leaved bramble
RUSP	<i>Rubus spectabilis</i>	indi	shrub	RUSP	<i>Rubus spectabilis</i>	salmonberry
SARA2	<i>Sambucus racemosa</i>	indi	shrub	SARA	<i>Sambucus racemosa</i>	red elderberry
SOSI2	<i>Sorbus sitchensis</i>	indi	shrub	SOSI	<i>Sorbus sitchensis</i>	Sitka mountain-ash
SYAL	<i>Symphoricarpos albus</i>	indi	shrub	SYAL	<i>Symphoricarpos albus</i>	Common snowberry
VADE	<i>Vaccinium deliciosum</i>	indi	shrub	VADE	<i>Vaccinium deliciosum</i>	delicious blueberry
VAME	<i>Vaccinium membranaceum</i>	indi	shrub	VAME	<i>Vaccinium membranaceum</i>	big huckleberry
VAOV	<i>Vaccinium ovalifolium</i>	indi	shrub	VAAL	<i>Vaccinium alaskense</i>	Alaska huckleberry
VAOV	<i>Vaccinium ovalifolium</i>	indi	shrub	VAOV	<i>Vaccinium ovalifolium</i>	oval-leaf huckleberry
VAOV2	<i>Vaccinium ovatum</i>	indi	shrub	VAOV2	<i>Vaccinium ovatum</i>	evergreen huckleberry
VAPA	<i>Vaccinium parvifolium</i>	indi	shrub	VAPA	<i>Vaccinium parvifolium</i>	red huckleberry
ACTR	<i>Achlys triphylla</i>	Indi	forb	ACTR	<i>Achlys triphylla</i>	Vanilla Leaf
ATFI	<i>Athyrium filix-femina</i>	Indi	forb	ATFI	<i>Athyrium filix-femina</i>	common ladyfern
BLSP	<i>Blechnum spicant</i>	indi	forb	BLSP	<i>Blechnum spicant</i>	deer fern
CALEH2	<i>Caltha leptosepala</i> ssp. <i>howellii</i>	indi	forb	CABI	<i>Caltha biflora</i>	two-flowered marsh-marigold
CASC7	<i>Campanula scouleri</i>	indi	forb	CASC2	<i>Campanula scouleri</i>	Scouler's harebell
CIAL	<i>Circaea alpina</i>	indi	forb	CIAL	<i>Circaea alpina</i>	enchanter's nightshade
CLSI2	<i>Claytonia sibirica</i>	indi	forb	MOSI	<i>Claytonia sibirica</i>	miner's lettuce
CLUN2	<i>Clintonia uniflora</i>	indi	forb	CLUN	<i>Clintonia uniflora</i>	queen's cup beadlelily
COME4	<i>Corallorhiza mertensiana</i>	indi	forb	COME	<i>Corallorhiza mertensiana</i>	western coralroot
COCA13	<i>Cornus canadensis</i>	indi	forb	COCA	<i>Cornus canadensis</i>	bunchberry

## Annual Inventory 2007, Appendix 1: National Forest Plots Special Rules

PLANTS	PLANTS species	Use	form	R6code	R6 old species	common_name
DRCA11	<i>Dryopteris carthusiana</i>	indi	forb	DRAU2	<i>Dryopteris campyloptera</i>	shield-fern
ERMO8	<i>Erythronium montanum</i>	indi	forb	ERMO	<i>Erythronium montanum</i>	avalanche lily/giant faw
GATR3	<i>Galium triflorum</i>	indi	forb	GATR	<i>Galium triflorum</i>	Sweetscented bedstraw
GOOB2	<i>Goodyera oblongifolia</i>	indi	forb	GOOB	<i>Goodyera oblongifolia</i>	Western Rattlesnake-Plantain
GYDR	<i>Gymnocarpium dryopteris</i>	indi	forb	GYDR	<i>Gymnocarpium dryopteris</i>	oak fern
LIBO3	<i>Linnaea borealis</i>	indi	forb	LIBO2	<i>Linnaea borealis</i>	twinflower
LULA4	<i>Lupinus latifolius</i>	indi	forb	LULA	<i>Lupinus latifolius</i>	Broadleaf lupine
LYAM3	<i>Lysichiton americanus</i>	indi	forb	LYAM	<i>Lysichiton americanum</i>	skunk cabbage
MADI2	<i>Maianthemum dilatatum</i>	indi	forb	MADI2	<i>Maianthemum dilatatum</i>	false lily of the vally
MAST4	<i>Maianthemum stellatum</i>	indi	forb	SMST	<i>Smilacina stellata</i>	Starry Solomn's Seal
MOMA3	<i>Moehringia macrophylla</i>	Indi	forb	ARMA3	<i>Arenaria macrophylla</i>	Bigleaf Sandwort
PYSEORS E	<i>OrthiliaPyrola secunda</i>	indi	forb	PYSE	<i>Pyrola secunda</i>	Sidebells Pyrola
OXOR	<i>Oxalis oregana</i>	indi	forb	OXOR	<i>Oxalis oregana</i>	Oregon oxalis
POMU	<i>Polystichum munitum</i>	indi	forb	POMU	<i>Polystichum munitum</i>	western swordfern
STLAC	<i>Streptopus lanceolatus</i> <i>var. curvipes</i>	indi	forb	STRO	<i>Streptopus roseus</i>	Rosy twistedstalk
STST3	<i>Streptopus streptopoides</i>	indi	forb	STST	<i>Streptopus streptopoides</i>	kruhsea twisted-stalk
TITR	<i>Tiarella trifoliata</i>	indi	forb	TITR	<i>Tiarella trifoliata</i>	threelf leaf foamflower
TITRU	<i>Tiarella trifoliata</i> <i>var.</i> <i>unifoliata</i>	indi	forb	TIUN	<i>Tiarella unifoliata</i>	Coolwort foamflower
TRBOL	<i>Trientalis borealis</i> <i>ssp.</i> <i>latifolia</i>	indi	forb	TRLA2	<i>Trientalis latifolia</i>	Western Starflower
VASI	<i>Valeriana sitchensis</i>	indi	forb	VASI	<i>Valeriana sitchensis</i>	sitka valerian
VAHE	<i>Vancouveria hexandra</i>	indi	forb	VAHE	<i>Vancouveria hexandra</i>	white inside-out-flower
XETE	<i>Xerophyllum tenax</i>	indi	forb	XETE	<i>Xerophyllum tenax</i>	Beargrass
FEOC	<i>Festuca occidentalis</i>	indi	Grami	FEOC	<i>Festuca occidentalis</i>	Western Fescue
ALVIS	<i>Alnus viridis</i> <i>ssp. sinuata</i>	nfor	shrub	ALSI	<i>Alnus sinuata</i>	sitka alder
ARUV	<i>Arctostaphylos uva-ursi</i>	nfor	shrub	ARUV	<i>Arctostaphylos uva-ursi</i>	Bearberry, Kinnikinnick
CAME7	<i>Cassiope mertensiana</i>	nfor	shrub	CAME	<i>Cassiope mertensiana</i>	western moss heather
CLPY3	<i>Cladothamnus pyroliflorus</i>	nfor	shrub	CLPY	<i>Cladothamnus pyrolaefflorus</i>	copperbrush
COSES	<i>Cornus sericia</i> <i>ssp.</i> <i>sericia</i>	nfor	shrub	COST	<i>Cornus stolonifera</i>	Red-osier dogwood
DAFL3	<i>Dasiphora floribunda</i>	nfor	shrub	POFR	<i>Potentilla fruticosa</i>	shrubby cinquefoil
EMNI	<i>Empetrum nigrum</i>	nfor	shrub	EMNI	<i>Empetrum nigrum</i>	black crowberry
JUCO6	<i>Juniperus communis</i>	nfor	shrub	JUCO4	<i>Juniperus communis</i>	common juniper
KAMI	<i>Kalmia microphylla</i>	nfor	shrub	KAMI	<i>Kalmia microphylla</i>	alpine laurel
KAMI	<i>Kalmia microphylla</i>	nfor	shrub	KAOC	<i>Kalmia occidentalis</i>	alpine laurel
PHEM	<i>Phyllodoce empetriformis</i>	nfor	shrub	PHEM	<i>Phyllodoce empetriformis</i>	pink mountain-heath
PHGL6	<i>Phyllodoce glanduliflora</i>	nfor	shrub	PHGL	<i>Phyllodoce glanduliflora</i>	tellow mountain-heath
RIBR	<i>Ribes bracteosum</i>	nfor	shrub	RIBR	<i>Ribes bracteosum</i>	stink currant
RUSP	<i>Rubus spectabilis</i>	nfor	shrub	RUSP	<i>Rubus spectabilis</i>	salmonberry
SABA3	<i>Salix barclayi</i>	nfor	shrub	SABA3	<i>Salix barclayi</i>	Barclay's willow
SACA6	<i>Salix cascadiensis</i>	nfor	shrub	SACA6	<i>Salix cascadiensis</i>	Cascade willow
SACO2	<i>Salix commutata</i>	nfor	shrub	SACO2	<i>Salix commutata</i>	Undergreen willow
SANI8	<i>Salix nivalis</i>	nfor	shrub	SANI	<i>Salix nivalis</i>	snow willow

## Annual Inventory 2007, Appendix 1: National Forest Plots Special Rules

PLANTS	PLANTS species	Use	form	R6code	R6 old species	common_name
SASI2	<i>Salix sitchensis</i>	nfor	shrub	SASI2	<i>Salix sitchensis</i>	Sitka willow
SPDO	<i>Spiraea douglasii</i>	nfor	shrub	SPDO	<i>Spiraea douglasii</i>	Douglas spiraea
SPSPS	<i>Spiraea splendens</i> var. <i>splendens</i>	nfor	shrub	SPDE	<i>Spiraea densiflora</i>	rose meadowsweet
VADE	<i>Vaccinium deliciosum</i>	nfor	shrub	VADE	<i>Vaccinium deliciosum</i>	delicious blueberry
CALEH2	<i>Caltha leptosepala</i> ssp. <i>howellii</i>	nfor	forb	CABI	<i>Caltha biflora</i>	two-flowered marsh-marigold
CAPA26	<i>Castilleja parviflora</i>	nfor	forb	CAPA3	<i>Castilleja parviflora</i>	mountain paintbrush
CARU9	<i>Castilleja rupicola</i>	nfor	forb	CARU4	<i>Castilleja rupicola</i>	cliff paintbrush
CHLA13	<i>Chamerion latifolium</i>	nfor	forb	EPLA	<i>Epilobium latifolium</i>	dwarf fireweed
DOJE	<i>Dodecatheon jeffreyi</i>	nfor	forb	DOJE	<i>Dodecatheon jeffreyi</i>	Sierra shootingstar
DOPU	<i>Dodecatheon pulchellum</i>	nfor	forb	DOPU2	<i>Dodecatheon pulchellum</i>	darkthroat shootingstar
EPAN4	<i>Epilobium anagallidifolium</i>	nfor	forb	EPAL	<i>Epilobium alpinum</i>	pimpernel willowherb
EQAR	<i>Equisetum arvense</i>	nfor	forb	EQAR	<i>Equisetum arvense</i>	Common horsetail
EQFL	<i>Equisetum fluviatile</i>	nfor	forb	EQFL	<i>Equisetum fluviatile</i>	water horsetail
EQHY	<i>Equisetum hyemale</i>	nfor	forb	EQHY	<i>Equisetum hyemale</i>	scouringbrush horsetail
ERPE3	<i>Erigeron peregrinus</i>	nfor	forb	ERPE	<i>Erigeron peregrinus</i>	subalpine fleabane
HEMA80	<i>Heracleum maximum</i>	nfor	forb	HELA	<i>Heracleum lanatum</i>	common cowparsnip
LEPY	<i>Leptarrhena pyrolifolia</i>	nfor	forb	LEPY2	<i>Leptarrhena pyrolifolia</i>	fireleaf leptarrhena
LOMA5	<i>Lomatium martindalei</i>	nfor	forb	LOMA2	<i>Lomatium martindalei</i>	Cascade desertparsley
LUPE	<i>Luetkea pectinata</i>	nfor	forb	LUPE	<i>Luetkea pectinata</i>	partridgefoot
LULA4	<i>Lupinus latifolius</i>	nfor	forb	LULA	<i>Lupinus latifolius</i>	Broadleaf lupine
METR3	<i>Menyanthes trifoliata</i>	nfor	forb	METR	<i>Menyanthes trifoliata</i>	buckbean
MILE2	<i>Mimulus lewisii</i>	nfor	forb	MILE	<i>Mimulus lewisii</i>	purple monkeyflower
NULUP	<i>Nuphar lutea</i> ssp. <i>polysepala</i>	nfor	forb	NUPO	<i>Nuphar polysepala</i>	Rocky Mountain pondlily
PEGR2	<i>Pedicularis groenlandica</i>	nfor	forb	PEGR	<i>Pedicularis groenlandica</i>	Elephanthead
PEDA2	<i>Penstemon davidsonii</i>	nfor	forb	PEDA	<i>Penstemon davidsonii</i>	Davidson's penstemon
PHDI3	<i>Phlox diffusa</i>	nfor	forb	PHDI	<i>Phlox diffusa</i>	spreading phlox
POBI6	<i>Polygonum bistortoides</i>	nfor	forb	POBI	<i>Polygonum bistortoides</i>	American bistort
POFL3	<i>Potentilla flabellifolia</i>	nfor	forb	POFL2	<i>Potentilla flabellifolia</i>	high mountain cinquefoil
RAES	<i>Ranunculus eschscholtzii</i>	nfor	forb	RAES	<i>Ranunculus eschscholtzii</i>	Eschsholtz's buttercup
SABR6	<i>Saxifraga bronchialis</i>	nfor	forb	SABR	<i>Saxifraga bronchialis</i>	yellowdot saxifrage
SATO2	<i>Saxifraga tolmiei</i>	nfor	forb	SATO	<i>Saxifraga tolmiei</i>	Tolmie's saxifrage
SIAC	<i>Silene acaulis</i>	nfor	forb	SIAC	<i>Silene acaulis</i>	moss campion
VASI	<i>Valeriana sitchensis</i>	nfor	forb	VASI	<i>Valeriana sitchensis</i>	sitka valerian
VEVI	<i>Veratrum viride</i>	nfor	forb	VEVI	<i>Veratrum viride</i>	American false hellebore
VIPA4	<i>Viola palustris</i>	nfor	forb	VIPA2	<i>Viola palustris</i>	marsh violet
XETE	<i>Xerophyllum tenax</i>	nfor	forb	XETE	<i>Xerophyllum tenax</i>	Beargrass
CACA4	<i>Calamagrostis canadensis</i>	nfor	grami	CACA	<i>Calamagrostis canadensis</i>	Bluejoint reedgrass
CAIN11	<i>Carex interior</i>	nfor	grami	CAIN5	<i>Carex interior</i>	inland sedge
CALE8	<i>Carex lenticularis</i>	nfor	grami	CALE5	<i>Carex lenticularis</i>	lakeshore sedge
CANI2	<i>Carex nigricans</i>	nfor	grami	CANI2	<i>Carex nigricans</i>	Black alpine sedge
CASP5	<i>Carex spectabilis</i>	nfor	grami	CASP	<i>Carex spectabilis</i>	showy sedge
ERAN6	<i>Eriophorum angustifolium</i>	nfor	grami	ERPO2	<i>Eriophorum polystachion</i>	many-spiked cotton-grass
FEOV	<i>Festuca ovina</i>	nfor	grami	FEOV	<i>Festuca ovina</i>	sheep fescue

## Annual Inventory 2007, Appendix 1: National Forest Plots Special Rules

PLANTS	PLANTS species	Use	form	R6code	R6 old species	common_name
FEVI	<i>Festuca viridula</i>	nfor	grami	FEVI	<i>Festuca viridula</i>	green fescue
JUDR	<i>Juncus drummondii</i>	nfor	grami	JUDR	<i>Juncus drummondii</i>	drummond rush
JUPA	<i>Juncus parryi</i>	nfor	grami	JUPA	<i>Juncus parryi</i>	Parry's rush
LUPI2	<i>Luzula piperi</i>	nfor	grami	HEGL	<i>Luzula piperi</i>	Piper's woodrush
SCMI2	<i>Scirpus microcarpus</i>	nfor	grami	SCMI	<i>Scirpus microcarpus</i>	Small-fruit bulrush
SPAN2	<i>Sparganium angustifolium</i>	nfor	grami	SPAN	<i>Sparganium angustifolium</i>	narrowleaf burr-reed
BOTRY	<i>Botrychium spp.</i>	sens	forb	BOSPP	<i>Botrychium spp.</i>	grageferns (Genus)
COAS	<i>Coptis asplenifolia</i>	sens	forb	COAS	<i>Coptis asplenifolia</i>	spleen-leaved goldthread
ERRE5	<i>Erythronium revolutum</i>	sens	forb	ERRE	<i>Erythronium revolutum</i>	pink fawn lily
GAKA	<i>Galium kamtschaticum</i>	sens	forb	GAKA	<i>Galium kamtschaticum</i>	boreal bedstraw
PLFI2	<i>Pleuricospora fimbriolata</i>	sens	forb	PLFI2	<i>Pleuricospora fimbriolata</i>	fringed pinesap
CYSC4	<i>Cytisus scoparius</i>	weed	shrub	CYSC4	<i>Cytisus scoparius</i>	broom, Scotch
CEBI2	<i>Centaurea bieberstinii</i>	weed	forb	CEMA	<i>Centaurea maculosa</i>	spotted knapweed
CEDET	<i>Centaurea debeauxii ssp. thuillieri</i>	weed	forb	CENI3	<i>Centaurea jacea x nigra</i>	knapweed, meadow
CEJA	<i>Centaurea jacea</i>	weed	forb	CEJA	<i>Centaurea jacea</i>	brown knapweed
CENI3	<i>Centaurea nigrescens</i>	weed	forb	CENI4	<i>Centaurea nigrescens</i>	vochin knapweed
CESO3	<i>Centaurea solstitialis</i>	weed	forb	CESO	<i>Centaurea solstitialis</i>	yellow starthistle
CEDI3	<i>Centurea diffusa</i>	weed	forb	CEDI	<i>Centurea diffusa</i>	diffuse knapweed
CHLE80	<i>Chrysanthemum leucanthemum</i>	weed	forb	CHLE2	<i>Chrysanthemum leucanthemum</i>	daisy, oxeye
CIAR4	<i>Cirsium arvense</i>	weed	forb	CIAR	<i>Cirsium arvense</i>	canada thistle
CIVU	<i>Cirsium vulgare</i>	weed	forb	CIVU	<i>Cirsium vulgare</i>	bull thistle
DACA6	<i>Daucus carota</i>	weed	forb	DACA4	<i>Daucus carota</i>	wild carrot
GERO	<i>Geranium robertianum</i>	weed	forb	GERO	<i>Geranium robertianum</i>	herb-Robert
HIAU	<i>Hieracium aurantiacum</i>	weed	forb	HIAU	<i>Hieracium aurantiacum</i>	hawkweed, orange
HICA10	<i>Hieracium caespitosum</i>	weed	forb	HICA	<i>Hieracium caespitosum</i>	yellow hawkweed
HYPE	<i>Hypericum perforatum</i>	weed	forb	HYPE	<i>Hypericum perforatum</i>	common st. john's wort
HYRA3	<i>Hypochaeris radicata</i>	weed	forb	HYRA	<i>Hypochaeris radicata</i>	catsear, spotted
LELA2	<i>Lepidium latifolium</i>	weed	forb	LELA	<i>Lepidium latifolium</i>	perennial pepperweed
LIDAD	<i>Linaria dalmatica ssp. dalmatica</i>	weed	forb	LIGED	<i>Linaria genistifolia dalmatian</i>	dalmatian toadflax
LIVU2	<i>Linaria vulgaris</i>	weed	forb	LIVU2	<i>Linaria vulgaris</i>	yellow toadflax
LYSA2	<i>Lythrum salicaria</i>	weed	forb	LYSA	<i>Lythrum salicaria</i>	purple loosestrife
POCU6	<i>Polygonum cuspidatum</i>	weed	forb	POCU2	<i>Polygonum cuspidatum</i>	Japanese knotweed
PORE5	<i>Potentilla recta</i>	weed	forb	PORE	<i>Potentilla recta</i>	cinquefoil, sulfur
SEJA	<i>Senecio jacobaea</i>	weed	forb	SEJA	<i>Senecio jacobaea</i>	tansy ragwort
SOAR2	<i>Sonchus arvensis</i>	weed	forb	SOAR	<i>Sonchus arvensis</i>	perennial sowthistle
TAVU	<i>Tanacetum vulgare</i>	weed	forb	TAVU	<i>Tanacetum vulgare</i>	common tansy
VETH	<i>Verbascum thapsus</i>	weed	forb	VETH	<i>Verbascum thapsus</i>	mullein, common
CYES3	<i>Cyperus esculentus</i>	weed	grami	CYES	<i>Cyperus esculentus</i>	yellow nutsedge
PHAR3	<i>Phalaris arundinacea</i>	weed	grami	PHAR	<i>Phalaris arundinacea</i>	reed canarygrass

**SW Washington****Gifford Pinchot (603) National Forest.**

ID Guide: Halverson, Nancy M. 1986. Major Indicator Shrubs and Herbs on National Forests of Western Oregon and Southwestern Washington. USDA Forest Service, Pacific Northwest Region R6-TM-229-1986.

PLANTS	PLANTS species	use	form	R6code	R6 old species	common_name
ACCI	<i>Acer circinatum</i>	indi	shrub	ACCI	<i>Acer circinatum</i>	Vine maple
AMAL2	<i>Amelanchier alnifolia</i>	indi	shrub	AMAL	<i>Amelanchier alnifolia</i>	Saskatoon Serviceberry
ARNE	<i>Arctostaphylos nevadensis</i>	indi	shrub	ARNE	<i>Arctostaphylos nevadensis</i>	pinemat manzanita
ARUV	<i>Arctostaphylos uva-ursi</i>	indi	shrub	ARUV	<i>Arctostaphylos uva-ursi</i>	Bearberry, Kinnikinnick
CHUM	<i>Chimaphila umbellate</i>	indi	shrub	CHUM	<i>Chimaphila umbellate</i>	pipsissewa
COCO6	<i>Corylus cornuta</i>	indi	shrub	COCO2	<i>Corylus cornuta</i>	California Hazel
GASH	<i>Gaultheria shallon</i>	indi	shrub	GASH	<i>Gaultheria shallon</i>	salal
HODI	<i>Holodiscus discolor</i>	indi	shrub	HODI	<i>Holodiscus discolor</i>	oceanspray
JUCO6	<i>Juniperus communis</i>	indi	shrub	JUCO4	<i>Juniperus communis</i>	common juniper
LOHI2	<i>Lonicera hispidula</i>	indi	shrub	LOHI	<i>Lonicera hispidula</i>	hairy honeysuckle
MAAQ2	<i>Mahonia aquifolium</i>	indi	shrub	BEAQ	<i>Berberis aquifolium</i>	Tall Oregon Grape
MANE2	<i>Mahonia nervosa</i>	indi	shrub	BENE	<i>Berberis nervosa</i>	Oregon Grape
MEFE	<i>Menziesia ferruginea</i>	indi	shrub	MEFE	<i>Menziesia ferruginea</i>	fool's huckleberry
OPHO	<i>Oplopanax horridus</i>	indi	shrub	OPHO	<i>Oplopanax horridus</i>	devil's club
PAMY	<i>Paxistima myrsinites</i>	indi	shrub	PAMY	<i>Pachistima myrsinites</i>	Oregon Boxwood
PHEM	<i>Phyllodoce empetrifomis</i>	indi	shrub	PHEM	<i>Phyllodoce empetrifomis</i>	pink mountain-heath
RHAL2	<i>Rhododendron albiflorum</i>	indi	shrub	RHAL	<i>Rhododendron albiflorum</i>	cascades azalea
RHMA3	<i>Rhododendron macrophyllum</i>	indi	shrub	RHMA	<i>Rhododendron macrophyllum</i>	Pacific rhododendron
ROGY	<i>Rosa gymnocarpa</i>	indi	shrub	ROGY	<i>Rosa gymnocarpa</i>	Baldhip Rose
RULA2	<i>Rubus lasiococcus</i>	indi	shrub	RULA	<i>Rubus lasiococcus</i>	dwarf bramble
RUPA	<i>Rubus parviflorus</i>	indi	shrub	RUPA	<i>Rubus parviflorus</i>	Thimbleberry
RUPE	<i>Rubus pedatus</i>	indi	shrub	RUPE	<i>Rubus pedatus</i>	Five-leaved bramble
RUSP	<i>Rubus spectabilis</i>	indi	shrub	RUSP	<i>Rubus spectabilis</i>	salmonberry
RUUR	<i>Rubus ursinus</i>	indi	shrub	RUUR	<i>Rubus ursinus</i>	Pacific blackberry
SYHE	<i>Symphoricarpos hesperius</i>	indi	shrub	SYMO	<i>Symphoricarpos mollis</i>	Trailing Snowberry
VADE	<i>Vaccinium deliciosum</i>	indi	shrub	VADE	<i>Vaccinium deliciosum</i>	delicious blueberry
VAME	<i>Vaccinium membranaceum</i>	indi	shrub	VAME	<i>Vaccinium membranaceum</i>	big huckleberry
VAOV	<i>Vaccinium ovalifolium</i>	indi	shrub	VAAL	<i>Vaccinium alaskense</i>	Alaska huckleberry
VAOV	<i>Vaccinium ovalifolium</i>	indi	shrub	VAOV	<i>Vaccinium ovalifolium</i>	oval-leaf huckleberry
VAOV2	<i>Vaccinium ovatum</i>	indi	shrub	VAOV2	<i>Vaccinium ovatum</i>	evergreen huckleberry
VAPA	<i>Vaccinium parvifolium</i>	indi	shrub	VAPA	<i>Vaccinium parvifolium</i>	red huckleberry
VASC	<i>Vaccinium scoparium</i>	indi	shrub	VASC	<i>Vaccinium scoparium</i>	grouse huckleberry
WHMO	<i>Whipplea modesta</i>	indi	shrub	WHMO	<i>Whipplea modesta</i>	whipplevine
ACTR	<i>Achlys triphylla</i>	indi	forb	ACTR	<i>Achlys triphylla</i>	Vanilla Leaf
ADAL	<i>Adiantum aleuticum</i>	indi	forb	ADPE	<i>Adiantum pedatum</i>	maidenhair fern
ADBI	<i>Adenocaulon bicolor</i>	indi	forb	ADBI	<i>Adenocaulon bicolor</i>	trail plant
ANDE3	<i>Anemone deltoidea</i>	indi	forb	ANDE	<i>Anemone deltoidea</i>	threeleaf anemone
ARLA8	<i>Arnica latifolia</i>	indi	forb	ARLA	<i>Arnica latifolia</i>	Broadleaf Arnica
ASCA2	<i>Asarum caudatum</i>	indi	forb	ASCA3	<i>Asarum caudatum</i>	wild ginger
ATFI	<i>Athyrium filix-femina</i>	indi	forb	ATFI	<i>Athyrium filix-femina</i>	common ladyfern

## Annual Inventory 2007, Appendix 1: National Forest Plots Special Rules

BLSP	<i>Blechnum spicant</i>	indi	forb	BLSP	<i>Blechnum spicant</i>	deer fern
CLSI2	<i>Claytonia sibirica</i>	indi	forb	MOSI	<i>Claytonia sibirica</i>	miner's lettuce
CLUN2	<i>Clintonia uniflora</i>	indi	forb	CLUN	<i>Clintonia uniflora</i>	queen's cup beadlilly
COCA13	<i>Cornus canadensis</i>	indi	forb	COCA	<i>Cornus canadensis</i>	bunchberry
DIHO3	<i>Disporum hookeri</i>	indi	forb	DIHO	<i>Disporum hookeri</i>	Hooker fairybells
DRCA11	<i>Dryopteris carthusiana</i>	indi	forb	DRAU2	<i>Dryopteris campyloptera</i>	shield-fern
ERMO8	<i>Erythronium montanum</i>	indi	forb	ERMO	<i>Erythronium montanum</i>	avalanche lily/giant faw
EULEL2	<i>Eucephalus ledophyllus</i> var. <i>ledophyllus</i>	indi	forb	ASLE2	<i>Aster ledophyllus</i>	Cascades aster
FRVE	<i>Fragaria vesca</i>	indi	forb	FRVE	<i>Fragaria vesca</i>	woodland strawberry
GATR3	<i>Galium triflorum</i>	indi	forb	GATR	<i>Galium triflorum</i>	Sweetscented bedstraw
GYDR	<i>Gymnocarpium dryopteris</i>	indi	forb	GYDR	<i>Gymnocarpium dryopteris</i>	oak fern
HIAL2	<i>Hieracium albiflorum</i>	indi	forb	HIAL	<i>Hieracium albiflorum</i>	White Hawkweed
IRTE	<i>Iris tenax</i> Dougl. ex Lindl	indi	forb	IRTE	<i>Iris tenax</i>	Oregon Iris
LAPO3	<i>Lathyrus polyphyllus</i>	indi	forb	LAPO	<i>Lathyrus polyphyllus</i>	leafy pea vine
LIBO3	<i>Linnaea borealis</i>	indi	forb	LIBO2	<i>Linnaea borealis</i>	twinflower
LULA4	<i>Lupinus latifolius</i>	indi	forb	LULA	<i>Lupinus latifolius</i>	Broadleaf lupine
LYAM3	<i>Lysichiton americanus</i>	indi	forb	LYAM	<i>Lysichiton americanum</i>	skunk cabbage
MADI2	<i>Maianthemum dilatatum</i>	indi	forb	MADI2	<i>Maianthemum dilatatum</i>	false lily of the vally
MARA7	<i>Maianthemum racemosum</i>	indi	forb	SMRA	<i>Smilacina racemosa</i>	False Solomn's Seal
MAST4	<i>Maianthemum stellatum</i>	indi	forb	SMST	<i>Smilacina stellata</i>	Starry Solomn's Seal
MIBR6	<i>Mitella breweri</i>	indi	forb	MIBR	<i>Mitella breweri</i>	Brewer's miterwort
MOMA3	<i>Moehringia macrophylla</i>	indi	forb	ARMA3	<i>Arenaria macrophylla</i>	Bigleaf Sandwort
OXOR	<i>Oxalis oregana</i>	indi	forb	OXOR	<i>Oxalis oregana</i>	Oregon oxalis
PODA	<i>Polygonum davisiae</i>	indi	forb	PONE4	<i>Polygonum newberryi</i>	Newberry's fleecflower
POMU	<i>Polystichum munitum</i>	indi	forb	POMU	<i>Polystichum munitum</i>	western swordfern
PTAQ	<i>Pteridium aquilinum</i>	indi	forb	PTAQ	<i>Pteridium aquilinum</i>	bracken fern
PYSE	<i>Pyrola secunda</i>	indi	forb	PYSE	<i>Pyrola secunda</i>	Sidebells Pyrola
SAME7	<i>Saxifraga mertensiana</i>	indi	forb	SAME3	<i>Saxifraga mertensiana</i>	Merten's saxifrage
STLAC	<i>Streptopus lanceolatus</i> var. <i>curvipes</i>	indi	forb	STRO	<i>Streptopus roseus</i>	Rosy twistedstalk
STME	<i>Stachys mexicana</i>	indi	forb	STME2	<i>Stachys mexicana</i>	Mexican hedgenettle
SYRE	<i>Synthyris reniformis</i>	indi	forb	SYRE	<i>Synthyris reniformis</i>	snowqueen
TITRU	<i>Tiarella trifoliata</i> var. <i>unifoliata</i>	indi	forb	TITRU	<i>Tiarella trifoliata</i> <i>unifoliata</i>	coolwort foamflower
TRBOL	<i>Trientalis borealis</i> ssp. <i>latifolia</i>	indi	forb	TRLA2	<i>Trientalis latifolia</i>	Western Starflower
TROV2	<i>Trillium ovatum</i>	indi	forb	TROV	<i>Trillium ovatum</i>	White trillium
VAHE	<i>Vancouveria hexandra</i>	indi	forb	VAHE	<i>Vancouveria hexandra</i>	white inside-out-flower
VASI	<i>Valeriana sitchensis</i>	indi	forb	VASI	<i>Valeriana sitchensis</i>	sitka valerian
VIGL	<i>Viola glabella</i>	indi	forb	VIGL	<i>Viola glabella</i>	stream violet
XETE	<i>Xerophyllum tenax</i>	indi	forb	XETE	<i>Xerophyllum tenax</i>	Beargrass
CAGE2	<i>Carex geyeri</i>	indi	grami	CAGE	<i>Carex geyeri</i>	elk sedge
CARU	<i>Calamagrostis rubescens</i>	indi	grami	CARU	<i>Calamagrostis rubescens</i>	pinegrass
FEID	<i>Festuca idahoensis</i>	indi	grami	FEID	<i>Festuca idahoensis</i>	idaho fescue
FEOC	<i>Festuca occidentalis</i>	indi	grami	FEOC	<i>Festuca occidentalis</i>	Western Fescue
FEVI	<i>Festuca viridula</i>	indi	grami	FEVI	<i>Festuca viridula</i>	green fescue



Annual Inventory 2007, Appendix 1: National Forest Plots Special Rules

LUHI4	<i>Luzula hitchcocki</i>	indi	grami	LUHI	<i>Luzula hitchcocki</i>	Smooth Woodrush
CYSC4	<i>Cytisus scoparius</i>	weed	shrub	CYSC	<i>Cytisus scoparius</i>	broom, Scotch
CEBI2	<i>Centaurea biebersteinii</i>	weed	forb	CEMA	<i>Centaurea maculosa</i>	spotted knapweed
CEDET	<i>Centaurea debeauxii</i> ssp. <i>thuillieri</i>	weed	forb	CENI3	<i>Centaurea jacea x nigra</i>	knapweed, meadow
CEDI3	<i>Centurea diffusa</i>	weed	forb	CEDI	<i>Centurea diffusa</i>	diffuse knapweed
CEJA	<i>Centaurea jacea</i>	weed	forb	CEJA	<i>Centaurea jacea</i>	brown knapweed
CENI3	<i>Centaurea nigrescens</i>	weed	forb	CENI4	<i>Centaurea nigrescens</i>	vochin knapweed
CESO3	<i>Centaurea solstitialis</i>	weed	forb	CESO	<i>Centaurea solstitialis</i>	yellow starthistle
CHLE80	<i>Chrysanthemum leucanthemum</i>	weed	forb	CHLE2	<i>Chrysanthemum leucanthemum</i>	daisy, oxeye
CIAR4	<i>Cirsium arvense</i>	weed	forb	CIAR	<i>Cirsium arvense</i>	canada thistle
CIVU	<i>Cirsium vulgare</i>	weed	forb	CIVU	<i>Cirsium vulgare</i>	bull thistle
DACA6	<i>Daucus carota</i>	weed	forb	DACA4	<i>Daucus carota</i>	wild carrot
GERO	<i>Geranium robertianum</i>	weed	forb	GERO	<i>Geranium robertianum</i>	herb-Robert
HIAU	<i>Hieracium aurantiacum</i>	weed	forb	HIAU	<i>Hieracium aurantiacum</i>	hawkweed, orange
HICA10	<i>Hieracium caespitosum</i>	weed	forb	HICA	<i>Hieracium caespitosum</i>	yellow hawkweed
HYPE	<i>Hypericum perforatum</i>	weed	forb	HYPE	<i>Hypericum perforatum</i>	common st. john's wort
HYRA3	<i>Hypochaeris radicata</i>	weed	forb	HYRA	<i>Hypochaeris radicata</i>	catsear, spotted
LELA2	<i>Lepidium latifolium</i>	weed	forb	LELA	<i>Lepidium latifolium</i>	perennial pepperweed
LIDAD	<i>Linaria dalmatica</i> ssp. <i>dalmatica</i>	weed	forb	LIGED	<i>Linaria genistifolia dalmatian</i>	dalmatian toadflax
LIVU2	<i>Linaria vulgaris</i>	weed	forb	LIVU2	<i>Linaria vulgaris</i>	yellow toadflax
LYSA2	<i>Lythrum salicaria</i>	weed	forb	LYSA	<i>Lythrum salicaria</i>	purple loosestrife
POCU6	<i>Polygonum cuspidatum</i>	weed	forb	POCU2	<i>Polygonum cuspidatum</i>	Japanese knotweed
PORE5	<i>Potentilla recta</i>	weed	forb	PORE	<i>Potentilla recta</i>	cinquefoil, sulfur
SEJA	<i>Senecio jacobaea</i>	weed	forb	SEJA	<i>Senecio jacobaea</i>	tansy ragwort
SOAR2	<i>Sonchus arvensis</i>	weed	forb	SOAR	<i>Sonchus arvensis</i>	perennial sowthistle
TAVU	<i>Tanacetum vulgare</i>	weed	forb	TAVU	<i>Tanacetum vulgare</i>	common tansy
VETH	<i>Verbascum thapsus</i>	weed	forb	VETH	<i>Verbascum thapsus</i>	mullein, common
CYES3	<i>Cyperus esculentus</i>	weed	grami	CYES	<i>Cyperus esculentus</i>	yellow nutsedge
PHAR3	<i>Phalaris arundinacea</i>	weed	grami	PHAR	<i>Phalaris arundinacea</i>	reed canarygrass

**NE Washington**

**Colville (621), Okanogan (608), Wenatchee (617) National Forests.**

ID Guide: Williams, Clinton K., and Terry R. Lillybridge. 1987. Major Indicator Shrubs and Herbs on National Forests of Eastern Washington, USDA Forest Service, Pacific Northwest Region R6-TM-TP-304-87

PLANTS	PLANTS species	use	form	R6code	R6 old species	common_name
ACGLD4	<i>Acer glabrum</i> var. <i>Douglasii</i>	indi	tree	ACGLD	<i>Acer glabrum</i> var. <i>Douglasii</i>	Douglas maple
TABR2	<i>Taxus brevifolia</i>	indi	tree	TABR	<i>Taxus brevifolia</i>	western yew
ACCI	<i>Acer circinatum</i>	indi	shrub	ACCI	<i>Acer circinatum</i>	Vine maple
ALVIS	<i>Alnus viridis</i> ssp. <i>sinuata</i>	indi	shrub	ALSI	<i>Alnus sinuate</i>	sitka alder
AMAL2	<i>Amelanchier alnifolia</i>	indi	shrub	AMAL	<i>Amelanchier alnifolia</i>	Saskatoon Serviceberry
ARNE	<i>Arctostaphylos nevadensis</i>	indi	shrub	ARNE	<i>Arctostaphylos nevadensis</i>	pinemat manzanita
ARUV	<i>Arctostaphylos uva-ursi</i>	indi	shrub	ARUV	<i>Arctostaphylos uva-ursi</i>	Bearberry, Kinnikinnick
ARTRV	<i>Artemisia tridentata</i> ssp. <i>vaseyana</i>	indi	shrub	ARTRV	<i>Artemisia tridentata vaseyana</i>	mountain big sagebrush
MAAQ2	<i>Mahonia aquifolium</i>	indi	shrub	BEAQ	<i>Berberis aquifolium</i>	Tall Oregon Grape
MANE2	<i>Mahonia nervosa</i>	indi	shrub	BENE	<i>Berberis nervosa</i>	Oregon Grape

## Annual Inventory 2007, Appendix 1: National Forest Plots Special Rules

PLANTS	PLANTS species	use	form	R6code	R6 old species	common_name
CESA	<i>Ceanothus sanguineus</i>	indi	shrub	CESA	<i>Ceanothus sanguineus</i>	Redstem ceanothus
CEVE	<i>Ceanothus velutinus</i>	indi	shrub	CEVE	<i>Ceanothus velutinus</i>	Snowbrush Ceanothus
CHUMO	<i>Chimaphila umbellata</i> <i>ssp. occidentalis</i>	indi	shrub	CHUMO	<i>Chimaphila umbellata</i> <i>var. occidentalis</i>	Western prince's pine
COSES	<i>Cornus sericia</i> <i>ssp. sericia</i>	indi	shrub	COST	<i>Cornus stolonifera</i>	Red-osier dogwood
GAOV2	<i>Gaultheria ovatifolia</i>	indi	shrub	GAOV	<i>Gaultheria ovatifolia</i>	slender salal
HODI	<i>Holodiscus discolor</i>	indi	shrub	HODI	<i>Holodiscus discolor</i>	oceanspray
LEGL	<i>Ledum glandulosum</i>	indi	shrub	LEGL	<i>Ledum glandulosum</i>	Western ledum
LOUT2	<i>Lonicera utahensis</i>	indi	shrub	LOUT2	<i>Lonicera utahensis</i>	Utah honeysuckle
MEFE	<i>Menziesia ferruginea</i>	indi	shrub	MEFE	<i>Menziesia ferruginea</i>	fool's huckleberry
OPHO	<i>Oplopanax horridus</i>	indi	shrub	OPHO	<i>Oplopanax horridus</i>	devil's club
PAMY	<i>Paxistima myrsinites</i>	indi	shrub	PAMY	<i>Pachistima myrsinites</i>	Oregon Boxwood
PHEM	<i>Phyllodoce empetriformis</i>	indi	shrub	PHEM	<i>Phyllodoce empetriformis</i>	pink mountain-heath
PHMA5	<i>Physocarpus malvaceus</i>	indi	shrub	PHMA	<i>Physocarpus malvaceus</i>	ninebark
PUTR2	<i>Purshia tridentata</i>	indi	shrub	PUTR	<i>Purshia tridentata</i>	bitterbrush
RHAL2	<i>Rhododendron albiflorum</i>	indi	shrub	RHAL	<i>Rhododendron albiflorum</i>	cascades azalea
RICE	<i>Ribes cereum</i>	indi	shrub	RICE	<i>Ribes cereum</i>	Squaw Current
RILA	<i>Ribes lacustre</i>	indi	shrub	RILA	<i>Ribes lacustre</i>	Prickly currant
RIVI3	<i>Ribes viscosissimum</i>	indi	shrub	RIVI	<i>Ribes viscosissimum</i>	Sticky Currant
ROGY	<i>Rosa gymnocarpa</i>	indi	shrub	ROGY	<i>Rosa gymnocarpa</i>	Baldhip Rose
ROSA5	<i>Rosa</i> <i>spp.</i>	indi	shrub	ROSA	<i>Rosa</i> <i>spp.</i>	Rose
RULA2	<i>Rubus lasiococcus</i>	indi	shrub	RULA	<i>Rubus lasiococcus</i>	dwarf bramble
RUPA	<i>Rubus parviflorus</i>	indi	shrub	RUPA	<i>Rubus parviflorus</i>	Thimbleberry
RUPE	<i>Rubus pedatus</i>	indi	shrub	RUPE	<i>Rubus pedatus</i>	Five-leaved bramble
SASC	<i>Salix scouleriana</i>	indi	shrub	SASC	<i>Salix scouleriana</i>	Scouler's Willow
SHCA	<i>Shepherdia canadensis</i>	indi	shrub	SHCA	<i>Shepherdia canadensis</i>	Russet buffaloberry
SOSC2	<i>Sorbus scopulina</i>	indi	shrub	SOSC2	<i>Sorbus scopulina</i>	Mountain ash
SPBEL	<i>Spiraea betulifolia</i> <i>var. lucida</i>	indi	shrub	SPBEL	<i>Spiraea betulifolia</i> <i>var. lucida</i>	Shiny-leaf spirea
SYAL	<i>Symphoricarpos albus</i>	indi	shrub	SYAL	<i>Symphoricarpos albus</i>	Common snowberry
SYHE	<i>Symphoricarpos hesperius</i>	indi	shrub	SYMOH	<i>Symphoricarpos mollis</i> <i>var. hesperius</i>	Creeping snowberry
SYOR2	<i>Symphoricarpos oreophilus</i>	indi	shrub	SYOR	<i>Symphoricarpos oreophilus</i>	mountain snowberry
VAOV	<i>Vaccinium ovalifolium</i>	indi	shrub	VAAL	<i>Vaccinium alaskense</i>	Alaska huckleberry
VACA13	<i>Vaccinium caespitosum</i>	indi	shrub	VACA	<i>Vaccinium caespitosum</i>	Dwarf Huckleberry
VADE	<i>Vaccinium deliciosum</i>	indi	shrub	VADE	<i>Vaccinium deliciosum</i>	delicious blueberry
VAME	<i>Vaccinium membranaceum</i>	indi	shrub	VAME	<i>Vaccinium membranaceum</i>	big huckleberry
VAMY2	<i>Vaccinium myrtillus</i>	indi	shrub	VAMY	<i>Vaccinium myrtillus</i>	Low huckleberry
VAOV	<i>Vaccinium ovalifolium</i>	indi	shrub	VAOV	<i>Vaccinium ovalifolium</i>	oval-leaf huckleberry
VAPA	<i>Vaccinium parvifolium</i>	indi	shrub	VAPA	<i>Vaccinium parvifolium</i>	red huckleberry
VASC	<i>Vaccinium scoparium</i>	indi	shrub	VASC	<i>Vaccinium scoparium</i>	grouse huckleberry

## Annual Inventory 2007, Appendix 1: National Forest Plots Special Rules

PLANTS	PLANTS species	use	form	R6code	R6 old species	common_name
MOMA3	<i>Moehringia macrophylla</i>	indi	forb	ARMA3	<i>Arenaria macrophylla</i>	Bigleaf Sandwort
ARCO9	<i>Arnica cordifolia</i>	indi	forb	ARCO	<i>Arnica cordifolia</i>	heart-leaf arnica
ARLA8	<i>Arnica latifolia</i>	indi	forb	ARLA	<i>Arnica latifolia</i>	Broadleaf Arnica
ASCA2	<i>Asarum caudatum</i>	indi	forb	ASCA3	<i>Asarum caudatum</i>	wild ginger
ASDE6	<i>Aspidotis densa</i>	indi	forb	ASDE	<i>Aspidotis densa</i>	rock fern
ATFI	<i>Athyrium filix-femina</i>	indi	forb	ATFI	<i>Athyrium filix-femina</i>	common ladyfern
BASA3	<i>Balsamorhiza sagittata</i>	indi	forb	BASA	<i>Balsamorhiza sagittata</i>	Arrowleaf Balsamroot
CLUN2	<i>Clintonia uniflora</i>	indi	forb	CLUN	<i>Clintonia uniflora</i>	queen's cup beadleilly
COCA13	<i>Cornus canadensis</i>	indi	forb	COCA	<i>Cornus canadensis</i>	bunchberry
DIHO3	<i>Disporum hookeri</i>	indi	forb	DIHO	<i>Disporum hookeri</i>	Hooker fairybells
DITR2	<i>Disporum trachycarpum</i>	indi	forb	DITR	<i>Disporum tracycarpum</i>	fairy bells
EQAR	<i>Equisetum arvense</i>	indi	forb	EQAR	<i>Equisetum arvense</i>	Common horsetail
GATR3	<i>Galium triflorum</i>	indi	forb	GATR	<i>Galium triflorum</i>	Sweetscented bedstraw
GYDR	<i>Gymnocarpium dryopteris</i>	indi	forb	GYDR	<i>Gymnocarpium dryopteris</i>	oak fern
HAL2	<i>Hieracium albiflorum</i>	indi	forb	HAL	<i>Hieracium albiflorum</i>	White Hawkweed
LAPA5	<i>Lathyrus pauciflorus</i>	indi	forb	LAPA3	<i>Lathyrus pauciflorus</i>	Few-flowered peavine
LIBOL2	<i>Linnaea borealis</i> ssp. <i>longiflora</i>	indi	forb	LIBOL	<i>Linnaea borealis longiflora</i>	western twinflower
CANA5	<i>Cacaliopsis nardosima</i>	indi	forb	LUNA2	<i>Luina nardosima</i>	silvercrown
LULA4	<i>Lupinus latifolius</i>	indi	forb	LULA	<i>Lupinus latifolius</i>	Broadleaf lupine
LUSE4	<i>Lupinus sericeus</i>	indi	forb	LUSE	<i>Lupinus sericeus</i>	Silky lupine
OSBE	<i>Osmorhiza berteroi</i>	indi	forb	OSCH	<i>Osmorhiza chilensis</i>	Sweet Cicely
PEBR	<i>Pedicularis bracteosa</i>	indi	forb	PEBR	<i>Pedicularis bracteosa</i>	Bracted pedicularis
PERA	<i>Pedicularis racemosa</i>	indi	forb	PERA	<i>Pedicularis racemosa</i>	Sickletop pedicularis
POMU	<i>Polystichum munitum</i>	indi	forb	POMU	<i>Polystichum munitum</i>	western swordfern
PTAQ	<i>Pteridium aquilinum</i>	indi	forb	PTAQ	<i>Pteridium aquilinum</i>	bracken fern
PYAS	<i>Pyrola asarifolia</i>	indi	forb	PYAS	<i>Pyrola asarifolia</i>	alpine pyrola
ORSE	<i>Orthilia secunda</i>	indi	forb	PYSE	<i>Pyrola secunda</i>	Sidebells Pyrola
SETR	<i>Senecio triangularis</i>	indi	forb	SETR	<i>Senecio triangularis</i>	arrowleaf groundsel
MARA7	<i>Maianthemum racemosum</i>	indi	forb	SMRA	<i>Smilacina racemosa</i>	False Solomn's Seal
MAST4	<i>Maianthemum stellatum</i>	indi	forb	SMST	<i>Smilacina stellata</i>	Starry Solomn's Seal
STAM2	<i>Streptopus amplexifolius</i>	indi	forb	STAM	<i>Streptopus amplexifolius</i>	twisted stalk
STLAC	<i>Streptopus lanceolatus</i> var. <i>curvipes</i>	indi	forb	STRO	<i>Streptopus roseus</i>	Rosy twistedstalk
THOC	<i>Thalictrum occidentale</i>	indi	forb	THOC	<i>Thalictrum occidentale</i>	Western Meadowrue
TITRU	<i>Tiarella trifoliata</i> var. <i>unifoliata</i>	indi	forb	TIUN	<i>Tiarella unifoliata</i>	Coolwort foamflower
TRCA	<i>Trautvetteria caroliniensis</i>	indi	forb	TRCA3	<i>Trautvetteria caroliniensis</i>	false bugbane
TRBOL	<i>Trientalis borealis</i> ssp. <i>latifolia</i>	indi	forb	TRLA2	<i>Trientalis latifolia</i>	Western Starflower
TROV2	<i>Trillium ovatum</i>	indi	forb	TROV	<i>Trillium ovatum</i>	White trillium
VASI	<i>Valeriana sitchensis</i>	indi	forb	VASI	<i>Valeriana sitchensis</i>	sitka valerian
VEVI	<i>Veratrum viride</i>	indi	forb	VEVI	<i>Veratrum viride</i>	American false hellebore
VIGL	<i>Viola glabella</i>	indi	forb	VIGL	<i>Viola glabella</i>	stream violet
VIOR	<i>Viola orbiculata</i>	indi	forb	VIOR2	<i>Viola orbiculata</i>	round-leaved violet
VIPU4	<i>Viola purpurea</i>	indi	forb	VIPU	<i>Viola purpurea</i>	Goosefoot violet
XETE	<i>Xerophyllum tenax</i>	indi	forb	XETE	<i>Xerophyllum tenax</i>	Beargrass

## Annual Inventory 2007, Appendix 1: National Forest Plots Special Rules

PLANTS	PLANTS species	use	form	R6code	R6 old species	common_name
PSSPS	<i>Pseudoroegneria spicata</i> <i>ssp. spicata</i>	indi	grami	AGSP	<i>Agropyron spicatum</i>	bluebunch wheatgrass
CARU	<i>Calamagrostis rubescens</i>	indi	grami	CARU	<i>Calamagrostis rubescens</i>	pinegrass
CACO11	<i>Carex concinnoides</i>	indi	grami	CACO	<i>Carex concinnoides</i>	Northwestern Sedge
CAGE2	<i>Carex geyeri</i>	indi	grami	CAGE	<i>Carex geyeri</i>	elk sedge
CARO5	<i>Carex rossii</i>	indi	grami	CARO	<i>Carex rossii</i>	ross' sedge
FEID	<i>Festuca idahoensis</i>	indi	grami	FEID	<i>Festuca idahoensis</i>	idaho fescue
FEOC	<i>Festuca occidentalis</i>	indi	grami	FEOC	<i>Festuca occidentalis</i>	Western Fescue
LUHI4	<i>Luzula hitchcocki</i>	indi	grami	LUHI	<i>Luzula hitchcocki</i>	Smooth Woodrush
CYSC4	<i>Cytisus scoparius</i>	weed	shrub	CYSC	<i>Cytisus scoparius</i>	broom, Scotch
ANAR16	<i>Anchusa arvensis</i>	weed	forb	ANOF	<i>Anchusa arvensis</i>	bugloss, annual
CADR	<i>Cardaria draba</i>	weed	forb	CADR	<i>Cardaria draba</i>	white top (hoary cress)
CAAC	<i>Carduus acanthoides</i>	weed	forb	CAAC	<i>Carduus acanthoides</i>	thistle, plumeless
CANU4	<i>Carduus nutans</i>	weed	forb	CANU5	<i>Carduus nutans</i>	musk thistle
CECA2	<i>Centaurea calcitrapa</i>	weed	forb	CECA	<i>Centaurea calcitrapa</i>	starthistle, purple
CEDET	<i>Centaurea debeauxii</i> ssp. <i>thuillieri</i>	weed	forb	CENIJ	<i>Centaurea jacea</i> x <i>nigra</i>	knapweed, meadow
CEBI2	<i>Centaurea biebersteinii</i>	weed	forb	CEMA	<i>Centaurea maculosa</i>	spotted knapweed
ACRE3	<i>Acroptilon repens</i>	weed	forb	CERE	<i>Centaurea repens</i>	Russian Knapweed
CESO3	<i>Centaurea solstitialis</i>	weed	forb	CESO	<i>Centaurea solstitialis</i>	yellow starthistle
CEDI3	<i>Centurea diffusa</i>	weed	forb	CEDI	<i>Centurea diffusa</i>	diffuse knapweed
CHJU	<i>Chondrilla juncea</i>	weed	forb	CHJU	<i>Chondrilla juncea</i>	rush skeletonweed
CHLE80	<i>Chrysanthemum leucanthemum</i>	weed	forb	CHLE2	<i>Chrysanthemum leucanthemum</i>	daisy, oxeye
CIAR4	<i>Cirsium arvense</i>	weed	forb	CIAR	<i>Cirsium arvense</i>	canada thistle
CIVU	<i>Cirsium vulgare</i>	weed	forb	CIVU	<i>Cirsium vulgare</i>	bull thistle
CRVU2	<i>Crupina vulgaris</i>	weed	forb	CRVU	<i>Crupina vulgaris</i>	crupina, common
CYOF	<i>Cynoglossum officinale</i>	weed	forb	CYOF	<i>Cynoglossum officinale</i>	hound's tongue
ECVU	<i>Echium vulgare</i>	weed	forb	ECVU	<i>Echium vulgare</i>	blueweed
EUES	<i>Euphorbia esula</i>	weed	forb	EUES	<i>Euphorbia esula</i>	leafy spurge
HIAU	<i>Hieracium aurantiacum</i>	weed	forb	HIAU	<i>Hieracium aurantiacum</i>	hawkweed, orange
HIPR	<i>Hieracium pratense</i>	weed	forb	HIPR	<i>Hieracium pratense</i>	hawkweed, yellow
HYPE	<i>Hypericum perforatum</i>	weed	forb	HYPE	<i>Hypericum perforatum</i>	common st. john's wort
HYRA3	<i>Hypochaeris radicata</i>	weed	forb	HYRA	<i>Hypochaeris radicata</i>	catsear, spotted
ISTI	<i>Isatis tinctoria</i>	weed	forb	ISTI	<i>Isatis tinctoria</i>	Dyers Woad
LELA2	<i>Lepidium latifolium</i>	weed	forb	LELA	<i>Lepidium latifolium</i>	perennial pepperweed
LIDAD	<i>Linaria dalmatica</i> ssp. <i>dalmatica</i>	weed	forb	LIGEN	<i>Linaria genistifolia</i> <i>dalmatian</i>	dalmatian toadflax
LIVU2	<i>Linaria vulgaris</i>	weed	forb	LIVU	<i>Linaria vulgaris</i>	yellow toadflax
LYSA2	<i>Lythrum salicaria</i>	weed	forb	LYSA	<i>Lythrum salicaria</i>	purple loosestrife
MINY	<i>Mirabilis nyctaginea</i>	weed	forb	MINY	<i>Mirabilis nyctaginea</i>	four o'clock, wild
MYSP2	<i>Myriophyllum spicatum</i>	weed	forb	MYSP2	<i>Myriophyllum spicatum</i>	Eurasian water-milfoil
ONAC	<i>Onopordum acanthium</i>	weed	forb	ONAC	<i>Onopordum acanthium</i>	scotch thistle
PORE5	<i>Potentilla recta</i>	weed	forb	PORE	<i>Potentilla recta</i>	cinquefoil, sulfur
SAPR2	<i>Salvia pratensis</i>	weed	forb	SAPR	<i>Salvia pratensis</i>	Meadow clary (sage)
SEJA	<i>Senecio jacobaea</i>	weed	forb	SEJA	<i>Senecio jacobaea</i>	tansy ragwort
TAVU	<i>Tanacetum vulgare</i>	weed	forb	TAVU	<i>Tanacetum vulgare</i>	common tansy
VETH	<i>Verbascum thapsus</i>	weed	forb	VETH	<i>Verbascum thapsus</i>	mullein, common

PLANTS	PLANTS species	use	form	R6code	R6 old species	common_name
AECY	<i>Aegilops cylindrica</i>	weed	grami	AECY	<i>Aegilops cylindrica</i>	goatgrass, jointed
CELO3	<i>Cenchrus longispinus</i>	weed	grami	CELO	<i>Cenchrus longispinus</i>	sandbur, longspine

## A1.8 CHAPARRAL SPECIAL RULES FOR R5 NATIONAL FOREST LANDS

### A. Introduction to Chaparral

Chaparral is a specific Non-forest Land Use class that defines areas comprised of shrubs and tree species in shrub form. **They are measured on all R5 National Forest lands only.**

A Chaparral condition is considered Non Forest land by definition in the FIA National Core Field Guide. It is however only inventoried on R5 National Forest System lands. If any portion of a 58.9 ft radius annular plot contains an Accessible Forest Land condition, Chaparral protocol is not used; the plot is installed using the standard procedures described in the chapters of this field guide. If no Accessible Forest Land is present, and a Chaparral condition class is present within one or more annular plots, use the procedures below to install the plot. These instructions detail the differences between standard plot installation procedures and those used for Chaparral plots.

For Non-Forest chaparral conditions, stocking determination will change from a stem count (used for Accessible Forest Land) to a percent crown cover of shrub species. The condition must have a minimum of 10% crown cover of chaparral shrub species to be classified as a chaparral condition. When determining stocking, evaluate the 24-foot radius subplots. The most common chaparral species are shrub forms of *Quercus*, *Arctostaphylos*, *Adenostoma*, *Ceanothus*, *Cercocarpus*, *Garrya* and *Baccharis*. Areas in which the predominate cover is *Artemesia*, *Purshia*, *Gutierrezia*, *Opuntia*, or semi-desert species are Rangeland, not Chaparral conditions.

Sometimes trees on the National FIA Tree Species List exhibit shrub form. Some of these will have separate botanical names that include a variation within the species. Other tree species will exhibit shrub form only on specific sites (like areas repeatedly burned by wildfires) and will never attain tree status by FIA definitions. To be considered a shrub, a tree species must: exhibit shrub form across the entire condition, they must be less than 5.0 inches DBH/DRC, **they must NOT make up 10% stem stocking** within the condition area being evaluated. If all the individuals of a particular tree species are exhibiting shrub form across the entire condition, or can be identified as a shrub variation of that tree species, then code them as shrubs in a chaparral condition. Make this determination early because it affects whether to install the plot as Chaparral or Accessible Forest Land. If any portion of one of the four 58.9 ft macroplots contains an Accessible Forest Land condition class, the following Chaparral procedures do not apply and the plot is installed as a forested plot using the procedures detailed in this manual.

If an area currently has less than 10% cover of chaparral species, but was either stocked in the past or has the potential to be stocked in the future with chaparral species, consider the area as a chaparral condition. Examples are lands that currently have little or no vegetation due to recent fires, mudslides or other disturbances that have affected the plot area. Plots previously stocked with tree species are not chaparral by nature, and the procedures for installing plots on Accessible Forest Land should be followed. (Be sure these areas are not a land use change to chaparral i.e. from frequent disturbance by fire).

If there is no Accessible Forest Land present on any of the four 58.9 ft radius macroplots, and a Chaparral condition class is present, use the Chaparral procedures below to install and collect measurements on that plot. These instructions detail the differences between standard protocol and those used for Chaparral plots. The following measurements are taken on Chaparral conditions on Region 5 NFS lands: Tree measurements (for trees  $\geq 5.0$  inches on the 24.0 foot radius,  $\geq 24.0$  inches on the 58.9 foot radius, and hectare trees in the Northwest Forest Plan area only), Plot Attributes, Condition Class Attributes (limited variables), Subplot Attributes (limited variables), Vegetation Profile (with additional variables and guidelines for Species Growth Habit, Species Height and Stage of Shrub Development), and Ground Cover. **DO NOT** collect any measurements on the Microplot, Down Woody Materials on any transects, or Site Trees.

### B. Chaparral Plot Installation and Layout Rules

Chaparral uses the same plot layout as a standard FIA plot. Collect all measurements on the 24-foot radius only (with the exception of tree measurements when applicable). Locating and referencing chaparral plots follow the same basic rules as outlined in Chapter 2 with exceptions to monumentation on Subplots 2 - 4 (described below).

If the plot falls within wilderness boundaries do not use rounds, squares or flagging and cover the cedar stake and subplot center pins with a rock cairn.

Reference Subplot 1 by installing a cedar stake at plot center with a yellow round nailed to the top, pinprick the exact location on the aerial photos and identify two reference trees monumenting them with aluminum squares. If no suitable reference trees are available use shrubs, rock cairns or other objects/landmarks in the area and make a comment about the object used in Tree Notes (Section 7.10.4). Describe these on the plot card stating azimuth and slope distance.

On subplots 2-4, subplot centers will not be referenced. These are floating points defined by a pin in the ground with a yellow round face up marking subplot center. Tie flagging to the pin and also above the pin location for ease of reference on subplot and to facilitate relocation for check cruising purposes.

### **C. Chaparral Procedures**

#### **PLOT DATA (Chapter 3)**

##### 3.1 Time Spent Plot - collected

##### 3.2 Reference Point

- RP SPECIES - collected
- RP DIAMETER - collected
- RP AZIMUTH - collected
- RP DISTANCE - collected
- RP AZ/DIST TO SUBPLOT CENTER # - collected

##### 3.3 Plot Attributes Downloaded to the PDR

All variables in this section are downloaded in the PDR. Special Studies do not apply to chaparral conditions.

##### 3.4 Plot Attributes Collected in the Field

- NFS PLOT NUMBER - collected
- PLOT STATUS - collected
  - \*\*\*Code 2 is the only valid code for chaparral conditions
- PLOT NONSAMPLED REASON - not collected in chaparral conditions
- SUBPLOTS EXAMINED - collected
- SAMPLE KIND - collected
- PNW PLOT KIND - dropped from chaparral survey
- PREVIOUS PLOT NUMBER - collected when Sample Kind = 3
- CREW TYPE - collected
- QA STATUS - collected (at the initial start up of plot files)
- CREW LEADER - collected
- CREW MEMBER 1 THRU 5 - collected
- MONTH - collected
- DAY - collected
- YEAR - collected
- LANDOWNER PLOT SUMMARY REQUEST - dropped from chaparral survey
- OWNER NAME/ADDRESS UPDATE - collected
- TOPOGRAPHIC POSITION - dropped from chaparral survey
- HORIZONTAL DISTANCE TO IMPROVED ROAD - dropped from chaparral survey
- WATER ON PLOT - dropped from chaparral survey

#### **GPS Coordinates**

- GPS UNIT TYPE - collected
- GPS SERIAL NUMBER - collected when GPS Unit Type > 0
- GPS DATUM - collected when GPS Unit Type > 0
- COORDINATE SYSTEM - collected when GPS Unit Type > 0
- UTM ZONE - collected when Coordinate System = 2
- EASTING (X) UTM - collected when Coordinate System = 2
- NORTHING (Y) UTM - collected when Coordinate System = 2

## Annual Inventory 2007, Appendix 1: National Forest Plots Special Rules

GPS ELEVATION - collected when GPS Unit Type = 1, 2 or 4  
GPS ERROR - collected when GPS Unit Type = 1 or 2  
NUMBER OF READINGS - collected when GPS Unit Type = 1 or 2  
GPS FILENAME - collected GPS Unit Type = 3, State = 06 (CA) and Crew Type = 3  
**Correction for "Offset" Location**  
AZIMUTH TO PLOT CENTER - collected when GPS Unit Type = 2, 3 or 4  
DISTANCE TO PLOT CENTER - collected when GPS Unit Type = 2, 3 or 4

### 3.5 Data Items Recorded on the Plot Card

**The plot card must be filled out completely and correctly (See instructions in Appendix 14.4).**

## **CONDITION CLASS ATTRIBUTES (Chapter 4)**

### 4.1 Determination of Condition Class - same

### 4.2 Condition Class Status Definitions

2. Non-forest land is the only valid Condition Class Status for Chaparral conditions.

### 4.3 Condition Class Attributes

Refer to the following for those attributes collected on Chaparral conditions.

### 4.4 Determining Condition Class Status

CONDITION CLASS NUMBER - collected  
CONDITION CLASS STATUS - collected  
\*\*\*Code 2 (Non-forest land) is the only valid code for Chaparral conditions  
CONDITION NONSAMPLED REASON - not valid for Chaparral conditions only

### 4.5 Delineating Condition Classes on Accessible Forest Land

RESERVE STATUS - collected  
OWNER GROUP - collected  
FOREST TYPE – not collected in non-forest condition  
STAND SIZE CLASS - not collected in non-forest condition  
REGENERATION STATUS - not collected in non-forest condition  
TREE DENSITY - Dropped from chaparral survey

### 4.6 Non-Delineating Variables for Accessible Forest Land

CURRENT GROUND LAND CLASS - Dropped from chaparral survey  
OWNER CLASS - collected  
PRIVATE OWNER INDUSTRIAL STATUS, 4.6.4 ARTIFICIAL REGENERATION SPECIES,  
STAND AGE and 4.6.6 STAND STRUCTURE - Dropped from chaparral survey  
DISTURBANCE and TREATMENT (both current and historical) - collected  
\*\*\* Make sure to code any fire disturbance even if it is under the 25% "significant threshold"  
limit for the condition. For all other Disturbances, the "significant threshold" damage is still  
25% of the soil surface or understory vegetation.  
EVIDENCE OF STUMPS, 4.6.32 EVIDENCE OF FIRE, 4.6.33 CONDITION CLASS  
PHYSIOGRAPHIC CLASS and 4.6.34 SOIL DEPTH - collected  
STAND CONDITION/STAGE OF DEVELOPMENT - collected  
\*\*\*Code 0 is the only valid code for chaparral conditions  
PLANT ASSOCIATION - collected using the appropriate guide book  
MIXED CONIFER SITE - Dropped from chaparral survey  
STOCKABILITY INDICATOR SET NUMBER - Dropped from chaparral survey

### 4.7 Non-Forest Lands

PRESENT NON-FOREST LAND USE - collected  
\*\*\*Code 45 is the only valid code for chaparral conditions

## **SUBPLOT ATTRIBUTES (Chapter 5)**

### 5.1 Subplot Identification

## Annual Inventory 2007, Appendix 1: National Forest Plots Special Rules

SUBPLOT NUMBER - collected

SUBPLOT/MACROPLOT STATUS - collected

\*\*\*Subplot Status 2 is the only valid code for chaparral conditions

SUBPLOT/MACROPLOT NONSAMPLED REASON - Not coded on chaparral conditions

SUBPLOT CENTER CONDITION - collected

### 5.2 Physiographic Class Information

SUBPLOT ASPECT - dropped from chaparral survey

SUBPLOT SLOPE - dropped from chaparral survey

MACROPLOT PHYSIOGRAPHIC CLASS - dropped from chaparral survey

### 5.3 Water information

WATER ON SUBPLOT - dropped from chaparral survey

WATER PROXIMITY - dropped from chaparral survey

SNOW/WATER DEPTH - dropped from chaparral survey

### 5.4 Microplot Attributes

MICROPLOT CENTER CONDITION - collected

MICROPLOT SEEDLING COUNT - dropped from chaparral survey

FUEL LOADING - dropped from chaparral survey

### 5.5 Boundary Reference Mapping

SUBPLOT NUMBER – collected

PLOT TYPE – collected

CONTRASTING CONDITION – collected

LEFT AZIMUTH – collected

CORNER AZIMUTH – collected

CORNER DISTANCE – collected

RIGHT AZIMUTH - collected

SUBPLOT/MACROPLOT CONDITION LIST - not in chaparral survey

BOUNDARY CHANGE - collected when Sample Kind = 2

\*\*\*Complete Boundary Reference mapping for the following: between different Non-forest Land Use classes on the 24.0-foot radius only, Owner Group changes on the macroplot and only map on the hectare boundary on R5 National Forest Lands within the Northwest Forest Plan area that contain a hectare tally tree within Accessible Forest Land. Note: This does not change the chaparral condition to Accessible Forest Land.

### 5.6 Non-Forest Inclusions: Mapping and Recording

NON-FOREST INCLUSIONS: MAPPING AND RECORDING - Dropped from chaparral survey

### 5.7 Root Disease Mapping/Rating

ROOT DISEASE MAPPING - Dropped from chaparral survey

ROOT DISEASE SEVERITY RATING - Dropped from chaparral survey

### 5.8 Subplot Disturbance

BURN ASSESSMENT – collected

MECHANICAL MANAGEMENT ASSESSMENT - collected

## **DOWN WOODY MATERIALS (Chapter 6)**

All measurements in Chapter 6 are dropped from the chaparral survey.

## **LIVE AND STANDING DEAD TREE TALLY (Chapter 7)**

Use the rules in Section 7.1 Selecting Tally Trees to determine when to tally a tree that is present in a chaparral condition. All other tree measurements apply when tallying trees in chaparral conditions according to the procedures outlined in Chapter 7.

## **VEGETATION PROFILE (Chapter 8)**

### 8.1 Vegetation Plot Design



Measure the Vegetation Profile on the 24-foot radius subplot in chaparral conditions.

## 8.2 Species Records

SPECIES GROWTH HABIT - collected

In chaparral conditions **saplings** as well as seedlings are included in the tree growth habit and recorded under the tree lifeform category.

SPECIES - collected

R5 Weed List - record any species, regardless of percent cover, found on the list in Section A1.6B

SPECIES HEIGHT - collected

If there is a four-foot canopy height difference between seedlings and saplings of a particular species and each has  $\geq 3\%$  cover on the subplot, separate them into different layers (same rules for Tree in Section 8.2.3).

SPECIES COVER - collected

STAGE OF SHRUB DEVELOPMENT - collected (with additional variable)

Codes 1-4 are the same

**Code 5 Dead, 100 percent dead material**

## 8.3 Lifeform and Total Vegetation Records

LIFEFORM – collected

LIFEFORM COVER - collected

PERCENT BARE SOIL - collected

PERCENT TOTAL VEGETATION COVER - collected

8.4 Collection and Identification of Unknown Plants - use the procedures described in this section

8.5 R6 Indicator and Weed Lists - not valid on chaparral plots

## **SITE INDEX (Chapter 9)**

All measurements in Chapter 9 are dropped from the chaparral survey.

## **GROUND COVER ON NFS LANDS (Chapter 10)**

### 10.1 Ground Cover Measurements

SUBPLOT NUMBER - collected on all subplots in a chaparral condition

TRANSECT - collected on required transects for subplot

SEGMENT ID - collected on both segments

GROUND COVER TYPE - collected

PERCENT COVER - collected



## APPENDIX 2 OUTSIDE NATIONAL FORESTS

### A2.1 THE INVENTORY OF CALIFORNIA

#### **California Background.**

In California, PNW-FIA collects data on all lands, across all ownerships, including National Forests and reserved areas such as State and National Parks. The State has been divided into six inventory units: North Coast, North Interior, Sacramento, Central Coast, San Joaquin, and Southern. The annual inventory of California represents the fourth measurement of plots established by PNW Research Station. California plots were previously measured in 1965-1972, Occasion 1; 1981-1984, Occasion 2; and in 1991-1994, Occasion 3. The current Annual Inventory effort is Occasion 4, 2001 till 2011.

At Occasion 1, plots were selected from a .85 mile primary sample grid using Stratified Random sampling. This method utilized several different scale photos and selected plots outside of National Forests lands and all reserved (Municipal, State, and National Parks) lands. The actual plot was of a 10-point configuration that did not utilize mapping to show different condition classes. Only Timberland plots were established and measured on the ground outside of all reserved land areas.

At Occasion 2, a more standardized 3.4 mile base grid was used in plot selection, with woodlands plot only being established using a 6.8 mile grid resulting in every 4th woodland plot being measured. At this time, some plots from the Soil Conservation Service (currently the National Resource Conservation Service, NRCS) were incorporated in to the selection process thus augmenting the selection process. The plot design varied between a 5 point design for new installed plots to a 3 point design for remeasured plots from Occasion 1.

At Occasion 3, further refinement of the plots selection process continued. The field plot grid was spaced again at 3.4 mile intervals, but little augmentation was applied in selecting plot off grids as in Occasion 2. Limited juniper plots were sampled, and the oak woodland plots were again established but only every second plot using the 3.4 grid was measured (this is called the 11k grid as seen on Occasion 3 plot cards). Although the field grid used at this Occasion was established in 1981, about half of the plots are at locations established before 1981 inherited from previous Occasions detailed above.

#### **History of Survey Occasion dates in California:**

Occasion 1 1965-1972  
Occasion 2 1981-1984  
Occasion 3 1991-1994  
Occasion 4 2001-2011

#### **California Inventory Design**

The California Annual Inventory design is based on a double sample for stratification as described by Cochran (1977, p. 327-335), but differing from Cochran's description in that both primary and second phases are permanent, systematic grids of photo and field plots, therefore not strictly allocated proportionally by stratum. The primary plots (Phase 1) are on a 0.85 mile (1.37 kilometer) PI grid that was established on base maps and transferred to aerial photos used in the Periodic Surveys of Occasion's 1, 2, and 3. This Phase 1 grid is further sub-sampled by a secondary field grid (Phase 2) in which the plots are laid out with 1 field plot per 6,000 acres. This provides an average of one Phase 2 or FIA field grid location for every 13 Phase 1 photo plots. The Phase 1--the photo grid--is used to stratify inventoried area by land class and degree of urbanization, and where forest land is stratified by forest condition. The stratification reduces overall variance, resulting in more precise estimates of forest area and volume statistics. Data collected on the Phase 2 field plots are used to adjust area estimates developed from classification of the Phase 1 grid and to obtain comprehensive information about forest conditions that is of known precision (MQO's and tolerances for every variable that has data collected). During the periodic survey, large areas of continuous non-forest lands--the "non-forest zone" were not sampled with field plots. Areas such as extensive agricultural lands, urban areas,

hard chaparral, and desert were not sampled due to the vastness of these areas, and also the fact that change in these areas happened over such a long time that the current sampling methods were ill suited in these areas. It was also not a goal to track resource data in non-forested areas, since the surveys were geared toward forested resources only.

### PNW past Occasion 3 Plot layout in California

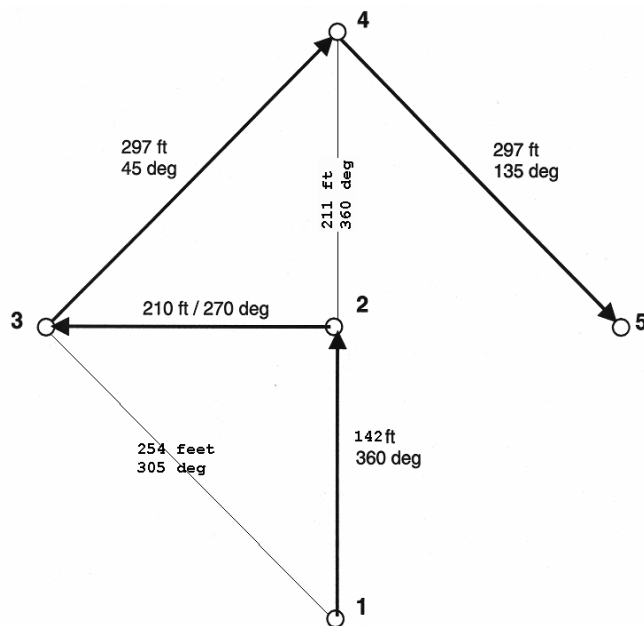

Figure A2-1: PNW past occasion 3 plot layout in California

## A2.2 THE INVENTORY IN OREGON AND WASHINGTON

### Oregon/Washington Background

In the late 1950s, PNW-FIA generated a grid of field locations across all lands in Washington and Oregon. This was done on USGS map or other available map coverage. To generate the grid on these maps, a point was selected randomly, and from this point grid lines were mapped out on cardinal directions every 3.4 miles. The intersections of these east-west and north-south lines on the maps became the basis for locating field plots on the ground in all PNW-FIA inventories since the late 1950s. In some cases, the grid was drawn county by county, and errors caused gaps or concentrations in the grid where the lines did not match up along county boundaries.

### Oregon/Washington Inventory design

FIA publishes information on area by forest land and owner classes and by degree of urbanization; land use change; timber volume, growth, mortality, and removals; potential forest productivity; opportunities for silvicultural treatment. The annual inventory design is based on a double sample for stratification as described by Cochran (1977, p. 327-335), but differing from Cochran's description in that both primary and second phases are permanent, systematic grids of photo and field plots and therefore, not strictly allocated proportionally by stratum. The primary plots are on a 0.85 mile (1.37 kilometer) grid that was established on

base maps and transferred to aerial photos. The primary grid is subsampled by the secondary field grid. The field plot grid is laid out with 1 field plot per 6,000 acres, providing an average of one secondary field grid location for every 13 primary photo plots. The primary phase--the photo grid--is used to stratify inventoried area by land class and degree of urbanization, and, where forest land, by forest condition. The stratification reduces overall variance, resulting in more precise estimates of forest area and volume statistics. Data collected on the field plots are used to adjust area estimates developed from classification of the primary grid and to obtain comprehensive information about forest conditions that is of known precision.

### Washington

- All Occasions  
See the previous plot layout diagrams on following pages.

### Oregon

- Occasion 1  
All Oregon counties were assigned to one of five administrative units, the Southwest unit, West-Central, Northwest, Central, or the Blue Mountain unit. Plots were established in 1961-1962 (Southwest, West-Central, and Northwest), 1964 (Central) and 1969 (Blue Mountains) using a 10-subplot, 1-acre plot. The counties and their units are listed in Appendix A5.2.
- Occasion 2  
At Occasion 2 the 1-acre, 10-subplot plots were remeasured in Douglas County in 1973, the Southwest unit in 1974, the West-Central in 1975, and the Northwest in 1976. In 1977 a new 5-subplot, 10-acre plot was established in the Central unit, and 3 of the 10 original subplots were remeasured. The Blue Mountain unit was measured in 1977 with a "walk-through" inventory that classified trees as living, mortality or cut, and which updated the seedling, sapling and tree tally.
- Occasion 3  
In 1984-1986 the new 5-subplot, 10-acre plot design was established in western Oregon, and 3 of the previous 10 subplots were remeasured. About 99 hardwood plot areas were projected at this time with models in western Oregon. In Central Oregon 1/6 of the 5-subplot, 7.5-acre plots were remeasured in 1986. In 1987 the remaining 5/6 of these plots were surveyed with the "walkthrough" method described above. Also in 1987, the 5-subplot, 7.5-acre plot design was established in the Blue Mountains, while 3 of the previous 10 subplots were remeasured. In eastern Oregon at this time, about 57 5-subplot, 10-acre juniper plots were established for the Oregon juniper inventory.
- Occasion 4  
At Occasion 4 the 5-subplot, 7.5-acre plot design was used for remeasurement and new data in western Oregon in 1995-1997, and for eastern Oregon timberland plots in 1998 and 1999. In 1999 approximately 600 juniper plots were established in eastern Oregon using the 4-subplot, 24.0 foot fixed-radius plot design.
- Occasion 5  
The 2004 field visit cycle in Oregon is sometimes referred to as Occasion 5. This terminology is fading now that we are beginning to install annual inventory plots across all states, in order to avoid confusion with other states' occasions. Prior to the Occasion 5 inventory an intensified grid of 6000 acre hexagons were laid down across the state and nation. Within each hexagon one field location was selected. All previously measured phase 3 locations were retained. Most of the phase 2 locations were retained. Approximately 30% of the hexagons had a new plot location assigned.

### **Oregon/Washington Previous plot layouts**

Usually, the 5-subplot plots installed at Occasions 2 and 3 were laid out in the standard pattern diagrammed in Figure A2.2. However, subplots were installed at positions off of the standard pattern in order to keep all 5 subplots entirely within the same forest land class and stand condition (broad forest type and stand size); i.e., subplots were never split between forest and nonforest land or between different stand condition classes.

The location of subplots that were not on the standard pattern was determined one of two ways:

1. A substitute subplot location (a "substituted subplot") was adopted if the center of the standard subplot location was in different forest land class or forest condition than was present at the field grid location.
2. If the subplot center was in the same forest land class and forest condition class as the field grid location but was within 58.9 ft. of a different land class or forest condition class, the standard subplot center was moved (a "moved subplot") until 58.9 ft. inside the same forest land class and forest condition present at the field grid location.

At Occasion 3, a single fixed-radius plot (16.95, or 17.0-meter radius) for sampling the vegetation profile was installed at field grid locations that fell in forest land classified as other forest-rocky, chaparral, or unsuitable site (GLCs 41, 45, 46) or were at locations that ordinarily required a 5-subplot plot but were too hazardous (cliffs etc.) to allow its installation.

At Occasion 4 the 5-subplot plots installed at all western Oregon and all eastern Oregon timberland locations is diagrammed below. All subplots are laid out in their standard location across condition classes to collect data about the current status of forest resources.

The 1999 Eastern Oregon juniper inventory used the same plot layout as the Annual inventory.

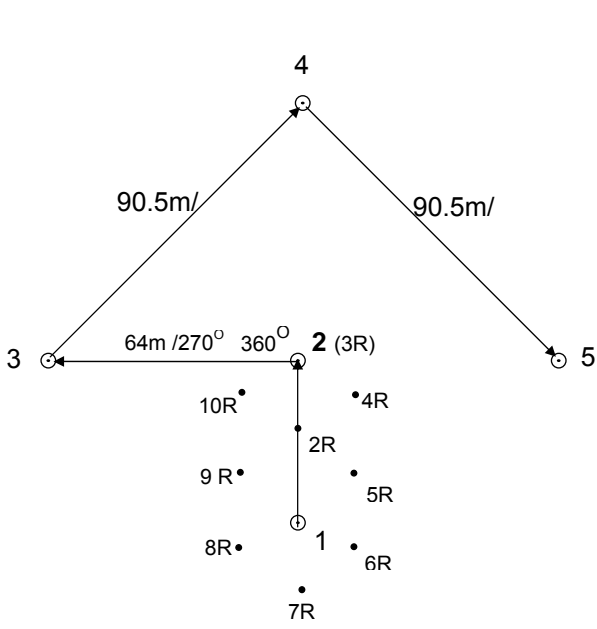

Blue Mountain Unit, Oc3  
 Oc4 (no R-points included)  
 Puget Unit, Oc1  
 Olympic Unit, Oc1  
 Point 1 to 2 = 42.6m (140 ft)

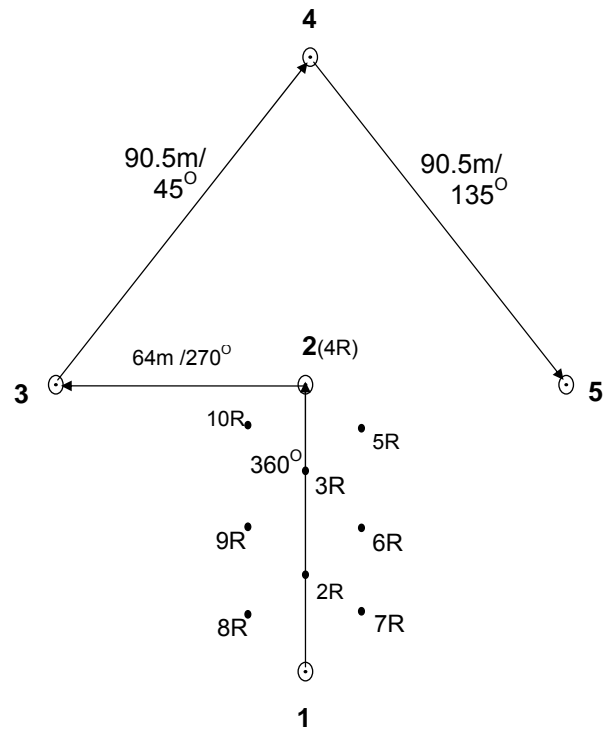

Central Oregon, Oc2 Oc3 &  
 Oc4 (no R-points included)  
 Point 1 to 2 = 64m (210 ft)

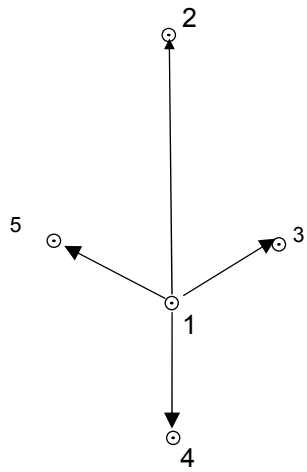

Eastern WA Unit Oc2 & Oc3 & Oc4

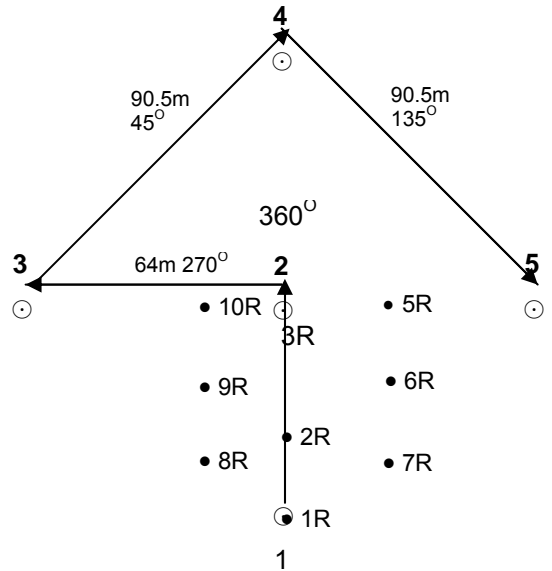

Western Oregon, Oc3  
 Oc4 (no R-points included)  
 Southwestern WA Unit, Oc2 & Oc3  
 Point 1 to 2 = 55m (180 ft)

Figure A2-2: Previous plot layouts in Oregon and Washington.

## A2.3 PNW TREE HISTORY CODES AND DEFINITIONS FROM THE PAST PERIODIC INVENTORIES

First code 1-5 and indicates the condition class that the tree is located in. The second digit indicates the tree history (TH) needed for all trees.

Cond Class	TH	Tree History	Description
1-5	0	No tally	Enter a line with TH 0 for subplots that do not have any live tally trees (TH 1,2,4,6). Enter a line for nonforest subplots and GLC 44 subplots, which are not on the 11K grid.
1	1	Remeasured	Tree tallied live at OCC2 and still live at OCC3.
1	2	New: re-constructed	Live tree in condition class 1 tallied for the first time at OCC 3.
2-5	2	New: not re-constructed	Live tree in condition class 2-5 at OCC 3.
1	3	Culturally-killed	Culturally-killed tree that was live at OCC 2. Tree was not harvested. It can be a stump, standing, or felled. Include trees killed in logging but not felled. Not tallied on N# subplots.
1	4	OCC3 Ingrowth	Tree tallied live at OCC 3 on 10.8 feet fixed radius plot which was not alive at OCC 2 or was < 1 inch at OCC 2. Not tallied on N# subplots.
1	5	Mortality	Tree tallied or reconstructed as live at OCC 2 but now dead. Death was natural and not due to human activity. Include partially uprooted windthrows leaning more than 45 degrees. If the dead tree qualifies as a snag, record snag information on a separate line with the same 5-digit line # and a TH 7. Not tallied on N# subplots.
1	6	Missed tree	Live tree on a remeasured subplot, which should have been tallied at OCC 2. Or a tally tree on the 10.89 feet fixed radius which was > 1 inch DBH at OCC 2 but did not qualify for tally at OCC 2. Requires reconstruction. Not tallied on N# subplots.
1-5	7	Snag	A standing dead tree which is > 9 inches DBH and > 6.6 feet tall at OCC 3. On remeasured subplots: Leave as TH 7 a snag tallied at OCC 2 but gone at OCC 3; leave as TH 7 a snag tallied at OCC 2 but <9 inches DBH or < 6.6 feet tall at OCC 3. Do not tally snags on remeasured subplots which have "grown in" since OCC 2 and died, but tally missed snags..
1	8	Harvested	A tree tallied or reconstructed as live and > 5 inches DBH at OCC2 which has been harvested for industrial supply, firewood, local use or incidental reasons. Not tallied on N# subplots.
1-5	9	Reference	Reference only.

## A2.4 FOREST HEALTH MONITORING PROGRAM

### California Forest Health Monitoring Program

Since 1992, Forest Health Monitoring plots now called Phase 3 (P3) plots have been established on a subset of FIA Phase 2 (P2) plots across all lands in California. One tenth of these plots (approximately 100 to 110 plots) are measured each year, with around 40 to 50 of these plots being forested and field measured. These P3 plots utilize the same plot design as the P2 plots, with the same base information collected as outlined in the national core FIA field manual. In addition, a lichen survey, erosion assessment, ground and soils samples, and crown ratings for health monitoring purposes are evaluated on each P3 plot.

### Oregon/Washington Forest Health Monitoring Program

In 1997, forest health monitoring plots now called Phase 3 (P3) plots, were installed at the grid locations on 207 forested plots in Oregon and 144 plots in Washington. Each year crews will measure about 58 plots in Oregon and about 52 in Washington on a 5-year cycle, resulting in an eventual total of approximately 250 and 200 plots respectively. On P3 plots, tree, vegetation, lichens, ozone, and soils data are collected. P3 plots use the same 4-subplot, 24.0 foot fixed-radius design which will be installed by PNW-FIA crews in the Oc5



inventory. If the FHM plot center is correctly located on these plots, the 4 subplots will be used in the PNW-FIA inventory. Copies of P3 tree tally cards will be in the plot packet.

## **A2.5 ADDITIONAL SOURCES OF DOCUMENTATION**

More information on the procedures detailed above is available from the following documents, on file at the PNW-FIA Lab in Portland, Oregon:

### **California**

1. *Field instructions for the inventory of California --1965/72, 1981-1984.*
2. *California PI manual for 1981-84.*
3. *California PI manual for 1991-94.*
4. *California inventory techniques manual and study plan.*
6. *Complete documentation for the inventory of California, 1991-1994.*
7. *Field Instructions for the Annual Inventory of Oregon and California, 2002*
8. *Forest Inventory and Analysis National Core Field Guide: Phase 2 Version 1.4 February 2000*
9. *Forest Inventory and Analysis National Core Field Guide: Phase 2 Version 1.5 2001*
10. *Forest Inventory and Analysis National Core Field Guide: Phase 2 Version 1.6 2002*
11. *Forest Inventory and Analysis National Core Field Guide: Version 2.0 2004*
12. *Forest Inventory and Analysis National Core Field Guide: Version 3.0 2006*
13. *Region 5 FIA Users Guide, 2000.*

### **Oregon and Washington**

1. *Forest Survey Field Instructions; Oregon and Washington – 1961-62.*
2. *Manual of Field Instructions for Forest Survey and Timber Management Inventories; Oregon and Washington – 1964.*
3. *Field Instructions for Integrated Forest Survey and Timber Management Inventories in Oregon, Washington, and California – 1969.*
4. *Forest Survey Field Instructions for Oregon, Washington, and California – 1973.*
5. *Forest Survey Field Instructions for Southwest Oregon – 1974.*
6. *Forest Survey Field Instructions for West Central Oregon – 1975.*
7. *Forest Survey Field Instructions for Northwest Oregon – 1976.*
8. *Forest Survey Field Instructions for Eastern Oregon – 1977.*
9. *Field Instructions for the Inventory Clatsop & Columbia counties, Western Oregon – 1984.*
10. *Field Instructions for the Inventory of Western Oregon – 1985-86.*
11. *Field Instructions for the Inventory of Eastern Oregon – 1986-87.*
12. *Field Instructions for the Inventory of Western Oregon – 1995-97.*
13. *Field instructions for the Inventory of Eastern Oregon – 1998.*

## **A2.6 MONUMENTING WILDERNESS AREAS**

### **Monumenting within Wilderness Areas on BLM Lands**

1. Plot origin (point #1) is monumented with a cedar stake and or a rock cairn.
2. N1 is referenced to two permanent features (trees or rocks), no circles or squares used.
3. Biodegradable paper flagging is hung at plot origin to facilitate inspection and at end of transect lines.
4. Subplots 2-4 are monumented with a regular metal pin, rounds painted brown, and rock cairns used to obscure these markers on the ground. Reference trees do not get rounds at any time. Remember to not make huge cairns, for this will defeat the purpose of hiding the monumentation.
5. Trees over 5" DBH are tagged with brown painted aluminum tree number tags and nails.
6. DBH is witnessed with brown painted aluminum nails only.

Crews prepares detailed plot diagram, showing RP's, and other physical features to facilitate relocation, as well as well defined route-to-plot to mitigate lack of markers used to reference plots at eye level.

### **Monumenting within National Park Service Wilderness Areas**

See the collections permit for the specific National Park, or the approved procedures worked out between PNW-FIA and the individual Park unit for instructions on how to monument plots in Wilderness areas. All

agreements are based upon the MOU between the Pacific Western Region of the National Park Service and PNW-FIA. If no such special procedures for monumentation are prescribed, check with your state coordinator. The axiom of “better to ask forgiveness rather than permission” has no place in field procedures.

## A2.7 SUDDEN OAK DEATH (SOD) SYNDROME ASSESSMENT IN CALIFORNIA

Any time PNW Damaging Agent 31 is coded, a sample of the damage is required.

Example:

+/- leafspots on known hosts- bay laurel (*Umbellularia californica*), rhododendron (*Rhododendron* spp.), toyon (*Heteromeles arbutifolia*), big leaf maple (*Acer macrophyllum*), Buckeye (*Aesculus californica*).

+/- bleeding- Surveyor needs to check bole of coast live oak (*Quercus agrifolia*), California Black Oak (*Quercus kelloggii*), and tanoak (*Lithocarpus densiflorus*) for bleeding.

If symptoms are found, a sample should be taken as follows:

Leafspots – Collect symptomatic leafspots, 30 leaves total. If more than one host, can be a mix (i.e. 10 bay leaves). Bay is the preferred host for isolation, so if it is present, select 10 leaves. If more than one bay tree is present with symptoms, collect samples from each bay tree with leafspots. Samples should strive to include all hosts with leafspots. Clip the twigs with the leaves attached and send the entire branch tip since this keeps specimens fresher longer.

Bleeding – Samples of oozing sap is no longer collected, but can be used as an indicator to collect leaves.

Leaves should be double bagged and labeled with location information (hex, county, date of collection, crew). A clean dry paper towel should be inserted in the bag with the leaves to absorb excess moisture. Crew will mail the sample in to the Rizzo Lab at UC Davis (address below). The material should be kept as cool as possible after collection has occurred. Mailing labels and containers will be supplied for each crew.

A PDR collection slip should be filled out.

Owner name slot	“Private” or “Public”
Address	leave blank due to confidentiality rules within FIA
Collector	“PNW-FIA”
Quarantine Origin	County name of where specimen was collected
Destination	Davis
Host collected	species name of sample
Remarks section	what checking for, and what is being submitted, on leaf samples
Send Report to	503-808-2020 attn: Bob Rhoads
Upper left corner	Township, Range, and Section

Mail all samples collected to: kamaram@ucdavis.edu

UC Davis  
Dept. of Plant Pathology  
ONE Shields Ave  
Davis, CA 95616

Each crew will call ahead or email John that they intend to ship samples to him. His phone is (530)-754-9894 in the lab, email **kamaram@ucdavis.edu**.

**Note:** It is imperative that field gear and boots be disinfected using bleach, Lysol®, or 70+ % alcohol after working in confirmed or suspected SOD areas. The underside of vehicles must be washed daily if off-pavement travel has occurred in SOD areas and before leaving any county where SOD is known to occur (Humboldt, Mendocino, Lake, Napa, Sonoma, Solano, Marin, San Francisco, Contra Costa, Alameda, San Mateo, Santa Clara, Santa Cruz, and Monterey counties in 2006).

## APPENDIX 3 PLANT ASSOCIATION AND COUNTY

The following list identifies which plant association key to use for each plot to determine Condition Class Attribute Section 4.6.36. The plant association guide to use will be downloaded on the data recorder.

### A3.1 WASHINGTON COUNTY KEY

- Asotin Co. (3) - south of Grande Ronde River- Wallowa-Snake Key
- Asotin Co. (3) - north of Grande Ronde River- Blue Mountain Key
- Columbia Co. (13) - all- Blue Mtn Key
- Cowlitz Co. (15) - west of I5: Olympic Key; east of I5: Gifford-Pinchot keys
- Ferry Co. (19) North of the Colville reservation: Colville NF key; south of the Colville reservation's north border: Colville Res. key
- Garfield Co. (23) - all- Blue Mtn Key
- Klickitat Co. (39) - on National Forest: Gifford-Pinchot keys; east of National Forest: Wenatchee key
- Lewis Co. (41) - west of I5: Olympic Key; east of I5: Gifford-Pinchot keys
- Lincoln Co. (43) - North-east section: Spokane reservation key
- Okanagon Co. (47) - west of the Okanogan River: Wenatchee key; east of Okanogan River and north of the Colville reservation: Colville NF key; east of Okanogan River and south of the Colville reservation's north border: Colville Res. key
- Skagit Co. (57) - east of North Cascades National Park: Wenatchee key; otherwise: Mt. Baker-Snoqualmie key
- Spokane Co. (63) - NO KEY AVAILABLE
- Stevens Co. (65) - North of the Spokane reservation: Colville NF key; south of the Spokane reservation's north border: Spokane Res. key
- Thurston Co. (67) - west of I5: Olympic Key; east of I5: Gifford-Pinchot keys
- Walla Walla Co. (71) - all- Blue Mtn Key
- Whatcom Co. (73) - east of North Cascades National Park: Wenatchee key; otherwise: Mt. Baker-Snoqualmie key
- Yakima Co. (77) - on National Forest: Gifford-Pinchot keys; east of National Forest: Wenatchee key; Yakama reservation and north of Yakama reservation: Wenatchee key

### A3.2 WASHINGTON PLANT ASSOCIATION GUIDES

#### NW Washington

\* National Forests: Mt. Baker-Snoqualmie (605), Olympic (609)

\* Off national forests: see map in Appendix

#### \* Association Guides:

Mt. Baker-Snoqualmie: Henderson, Jan A., David H. Peter, Robin D. Leshner and David C. Shaw. 1992. Forested Plant Associations Of The Mt. Baker-Snoqualmie National Forest. USDA Forest Service, Pacific Northwest Region R6-ECOL-TP-028-91.

Olympic: Henderson, Jan A., David H. Peter, Robin D. Leshner and David C. Shaw. 1989. Forested Plant Associations Of The Olympic National Forest. USDA Forest Service, Pacific Northwest Region R6-ECOL-001-88.

Non-forest: Hall, Frederick C. 1998. Pacific Northwest ecoclass codes for seral and potential natural communities. USDA Forest Service, Pacific Northwest Research Station, General technical report PNW-GTR-418. Appendix 1.

\* Indicator Plant ID Guides:

Leshner, Robin D., and Jan A. Henderson. 1992. Indicator Species of Forested Plant Associations on National Forests of Northwestern Washington. USDA Forest Service, Pacific Northwest Region R6-MBS-TP-041-1992.

Non-forest, weed, or sensitive plants: No Guide. Use Hitchcock, C.L., and A. Cronquist. 1973. Flora of the Pacific Northwest. University of Washington Press, Seattle, WA. or Pojar, J., and A. MacKinnon. 1994. Plants of the Pacific Northwest Coast. Lone Pine Publishing, Vancouver, BC.

**SW Washington**

\* National Forest: Gifford Pinchot (603)

\* Off national forests: see map in Appendix 2

\* Association Guides:

ABAM Zone: Brockway, Dale G., Christopher Topik, Miles A. Hemstrom, and William H. Emmingham. 1983. Plant Association and Management Guide for the Pacific Silver Fir Zone, Gifford Pinchot National Forest. USDA Forest Service, Pacific Northwest Region R6-Ecol-130a-1983.

TSME Zone: Diaz, Nancy M., C. Tom High, T. Kim Mellen, Diane E. Smith, and Christopher Topik. 1997. Plant Association and Management Guide for the Mountain Hemlock Zone, Gifford Pinchot and Mt. Hood National Forests. USDA Forest Service, Pacific Northwest Region R6-MTH-GP-TP-08-95.

TSHE Zone: Topik, Christopher, Nancy M. Halverson, and Dale G. Brockway. 1986. Plant Association and Management Guide for the Western Hemlock Zone, Gifford Pinchot National Forest. USDA Forest Service, Pacific Northwest Region R6-ECOL-230A-1986.

ABGR Zone: Topik, Christopher. Plant Association and Management Guide for the Grand Fir Zone Gifford Pinchot National Forest. USDA Forest Service, Pacific Northwest Region R6-Ecol-TP-006-88.

\* Indicator Plant ID Guides:

Halverson, Nancy M. 1986. Major Indicator Shrubs and Herbs on National Forests of Western Oregon and Southwestern Washington. USDA Forest Service, Pacific Northwest Region R6-TM-229-1986.

**NE Washington**

\* National Forests: Colville (621), Okanogan (608), Wenatchee (617)

\* Off national forests: see map in Appendix 2.

\* Association Guides:

Colville N.F. and Okanogan N.F. "east of the Okanogan River": Williams, Clinton K., Terry R. Lillybridge, and Bradley G. Smith. 1995. Forested Plant Associations of the Colville National Forest. USDA Forest Service, Pacific Northwest Research Station PNW-GTR-360.

Wenatchee NF and Okanogan NF "west of Okanogan River": Lillybridge, Terry R., Bernard L. Kovalchik, Clinton K. Williams, and Bradley G. Smith. 1995. Field Guide for Forested Plant Associations of the Wenatchee National Forest. USDA Forest Service, Pacific Northwest Research Station PNW-GTR-359.

\* Indicator Plant ID Guides:

Williams, Clinton K., and Terry R. Lillybridge. 1987. Major Indicator Shrubs and Herbs on National Forests of Eastern Washington, USDA Forest Service, Pacific Northwest Region R6-TM-TP-304-87.

Weeds: Smith-Kuebel, Cyndy, and Terry R. Lillybridge. Sensitive Plants and Noxious Weeds of the Wenatchee National Forest. USDA Forest Service, Wenatchee National Forest R6-WEN-93-014.

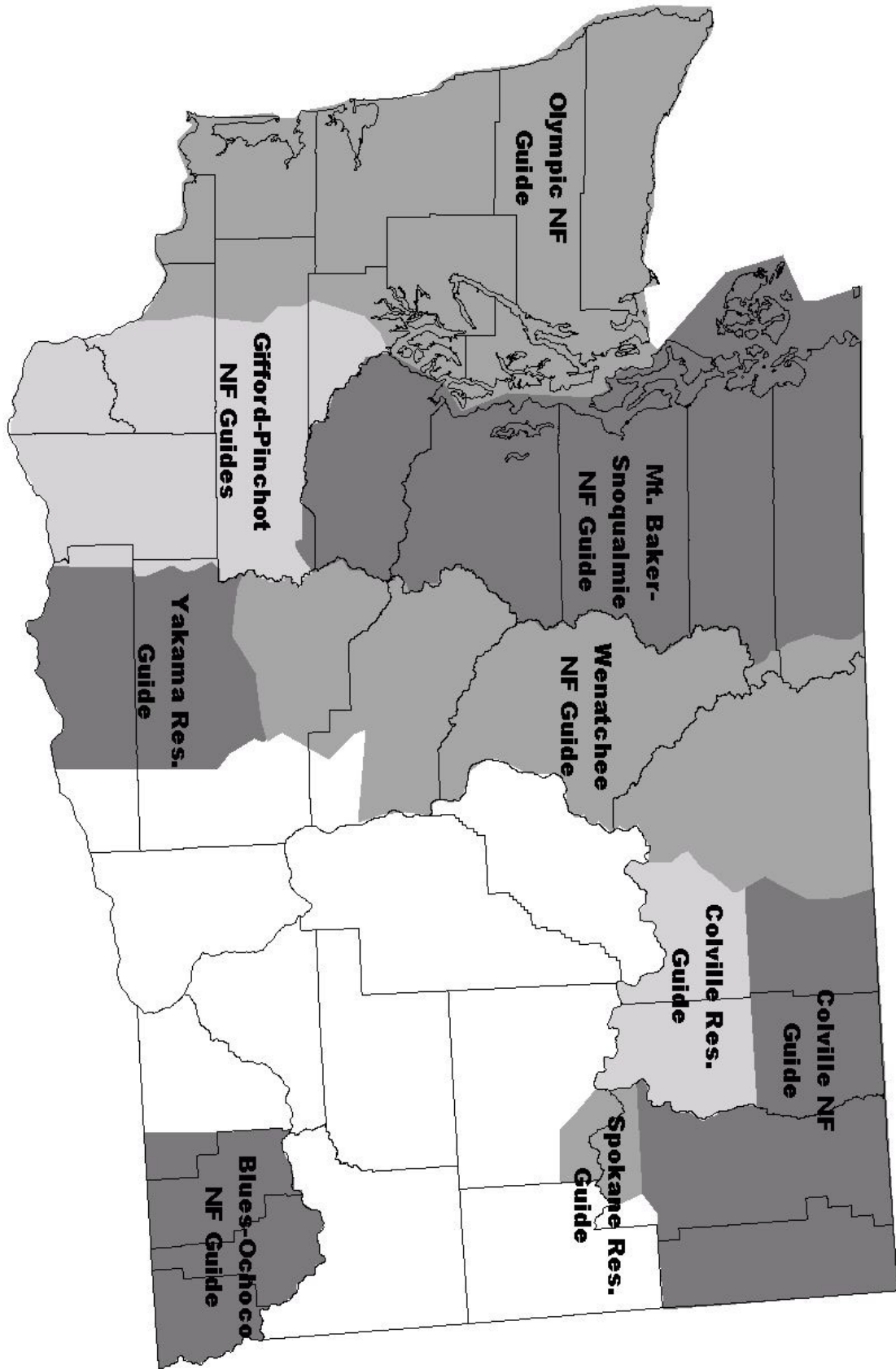

### **A3.3 OREGON COUNTY KEY**

Baker Co.- see map on following pages.

north and east of US 80- Wallowa-Snake Key

south and west of US 80- Blue Mtn Key

Crook Co.- all- Blue Mtn Key

Deschutes Co.- see map on following pages.

west of US 97 and south of US 20- Pumice Zone Key

Gilliam Co.- no Key available

Grant Co.- all- Blue Mtn Key

Harney Co.- north of US 20- Blue Mtn Key

Jefferson Co.- see map on following pages.

timberlands on the Warm Springs Reservation- Warm Springs Key

south of Warm Springs Reservation and west from east ½ of Range 11E- Pumice Zone Key

east of Range 14E- Blue Mtn Key

east ½ of Range 11E east thru Range 14E- Crooked River Grasslands Key

Klamath Co.- see map on following pages.

south to south end of Crater Lake NP, south thru north ½ of Township 35S, east to Range 14E- Pumice Zone Key

from CA border north to the Sprague River, including south ½ of Township 35S, east to Range 12E, Klamath and S Chiloquin Key

including Range 14 E east- Fremont Key

Lake Co.- see map on following pages.

south to Township 33S, east to Range 15E - Pumice Zone Key

from CA border north, west to Range 14E- Fremont Key

Malhuer Co.- no Key available

Morrow Co.- see map on following pages.

south of Township 2S- Blue Mtn Key

Sherman Co.- no Key available

Umatilla Co.- all- Blue Mtn Key

Union Co.- see map on following pages.

east of US 80 and the Grande Ronde River- Wallowa-Snake Key

west of US 80 and the Grande Ronde River- Blue Mtn Key

Wallowa Co.- see map on following pages.

east of the Grande Ronde River- Wallowa-Snake Key

west of the Grande Ronde River- Blue Mtn Key

Wasco Co.- see map on following pages.

timberlands on the Warm Springs Reservation- Warm Springs Key

north of Warm Springs Reservation- generally above 3000 feet- Silver Fir Zone Key

north of Warm Springs Reservation- generally below 3000 feet- Ponderosa-Doug-fir-grand Fir Key

### **A3.4 OREGON PLANT ASSOCIATION GUIDES**

#### **NW Oregon**

\* National Forests: Mt. Hood (606), Siuslaw (612), Willamette (618)

\* Off national forests: see maps in this Appendix

#### **Association Guides:**

Mt. Hood, westside: McCain, Cindy; Diaz, Nancy. 2002. Field guide to the forested plant associations of the westside central Cascades of northwest Oregon. USDA Forest Service, Pacific Northwest Region R6-NR-ECOL-TP-02-02

Mt. Hood, eastside TSHE: Halverson, Nancy M., Christopher Topik, and Robert Van Vickle. 1986. Plant Association and Management Guide for the Western Hemlock Zone, Mt. Hood National Forest. USDA Forest Service, Pacific Northwest Region R6-ECOL-232A-1986.

Mt. Hood, eastside PIPO, PSME, ABGR: Topik, Christopher, Nancy M. Halverson, and Tom High. 1988. Plant Association and Management Guide for the Ponderosa Pine, Douglas-fir, and Grand Fir Zones, Mt. Hood National Forest. USDA Forest Service, Pacific Northwest Region R6-ECOL-TP-004-88.

Siuslaw, not Oregon Dunes: McCain, Cindy; Diaz, Nancy. 2002. Field guide to the forested plant associations of the northern Oregon Coast Range. USDA Forest Service, Pacific Northwest Region R6-NR-ECOL-TP-03-02

Siuslaw, Oregon Dunes NRA: Christy, John A., James S. Kagan, and Alfred M. Wiedemann. 1986. Plant Associations of the Oregon Dunes National Recreation Area. USDA Forest Service, Pacific Northwest Region R6-NR-ECOL-TP-09-98.

#### **Indicator Plant ID Guides:**

Halverson, Nancy M. 1986. Major Indicator Shrubs and Herbs on National Forests of Western Oregon and Southwestern Washington. USDA Forest Service, Pacific Northwest Region R6-TM-229-1986.

#### **SW Oregon**

\* National Forests: Rogue River (610), Siskiyou (611), Umpqua (615)

\* Off national forests: see maps

#### **Association Guides:**

Atzet, Thomas, Diane E. White, Lisa A. McCrimmon, Patricia A. Martinez, Paula Reid Fong, and Vince D. Randall. 1996. Field Guide to the Forested Plant Associations of Southwestern Oregon. USDA Forest Service, Pacific Northwest Region, Technical Paper R6-NR-ECOL-TP-17-96.

#### **Indicator ID Guides:**

Seda, Anita, Thomas Atzet, and David Wheeler. 1989 (updated 1997). Key Species for Plant Associations on the Rogue River, Siskiyou, and Umpqua National Forests. USDA Forest Service, Pacific Northwest Region R6-NR-ECOL-TP-026-97.

#### **CE Oregon**

\* National Forests: Deschutes (601), Fremont (602), Ochoco (607), Winema (620), Crooked River (650)

\* Off national forests: see maps

#### **Association Guides:**

Deschutes, Winema (part), and Fremont (part): Volland, Leonard A. 1988 (latest revision). Plant Associations of the Central Oregon Pumice Zone. USDA Forest Service, Pacific Northwest Region R6-ECOL-104-1982.

Winema (part): Hopkins, William. 1979. Plant Associations of South Chiloquin and Klamath Ranger Districts - Winema National Forest. USDA Forest Service, Pacific Northwest Region R6-Ecol-79-004.

Fremont (part): Hopkins, William. 1979. Plant Associations of the Fremont National Forest. USDA Forest Service, Pacific Northwest Region R6-ECOL-79-004.

Annual Inventory 2007, Appendix 3: Plant Association and County

Ochoco: Johnson, Charles Jr., and Rodrick Clausnitzer. 1992. Plant Associations of the Blue and Ochoco Mountains. USDA Forest Service, Pacific Northwest Region R6-ERW-TP-036-92.

Crooked River grasslands and PIPO (Ochoco): Hopkins, William, and Bernard Kovalchik. 1983. Plant Associations of the Crooked River National Grasslands, Ochoco National Forest. USDA Forest Service, Pacific Northwest Region R6-ECOL-133-1983

RIPARIAN, all forests: Kovalchik, Bernard. 1987. Riparian Zone Associations-Deschutes, Ochoco, Fremont, and Winema National Forests. USDA Forest Service, Pacific Northwest Region R6-ECOL-TP-279-87.

\* Indicator Plant ID Guides:

uplands: Hopkins, William, and Robert Rawlings. 1988 (revised version). Major Indicator Shrubs and Herbs on National Forests of Eastern Oregon. USDA Forest Service, Pacific Northwest Region R6-TM-190-1985.

riparian: Kovalchik, Bernard L., William E. Hopkins, and Steven J. Brunfeld. 1988. Major Indicator Shrubs and Herbs in Riparian Zones on National Forests of Central Oregon. USDA Forest Service, Pacific Northwest Region R6-ECOL-TP-005-88.

noxious and sensitive: Hopkins, William E., and Stuart Garrett. 1990. Sensitive Plant - Animal and Noxious Weeds Guide for Deschutes, Fremont, Ochoco and Winema National Forests - Area IV. USDA Forest Service, Pacific Northwest Region R6-DES-TP-017-90.

**NE Oregon**

\* National Forests: Malheur (604), Umatilla (614), Wallowa-Whitman (616)

\* Off national forests: see maps

\* Association Guides:

Wallowa-Whitman NF (Wallowa Valley, Hells Canyon NRA, Eagle Cap, Pine, and eastern portion of La Grande Districts): Johnson, Charles G. Jr., Steven A. Simon, 1987. Plant Associations of the Wallowa-Snake Province, Wallowa-Whitman National Forest. USDA Forest Service, Pacific Northwest Region R6-ECOL-TP-255B-86.

Malheur NF, Umatilla NF, and Wallowa-Whitman NF (Unity, Baker, and western portion of La Grande Districts): Johnson, Charles Grier Jr., Rodrick R. Clausnitzer, 1992. Plant Associations of the Blue and Ochoco Mountains, Wallowa-Whitman National Forest. USDA Forest Service, Pacific Northwest Region R6-ERW-TP-036-92.

\* Indicator Plant ID Guides:

Johnson, Charles Grier Jr. 1993. Common Plants of the Inland Pacific Northwest, Malheur, Umatilla, Wallowa-Whitman National Forests. USDA Forest Service, Pacific Northwest Region R6-ERW-TP051-93.



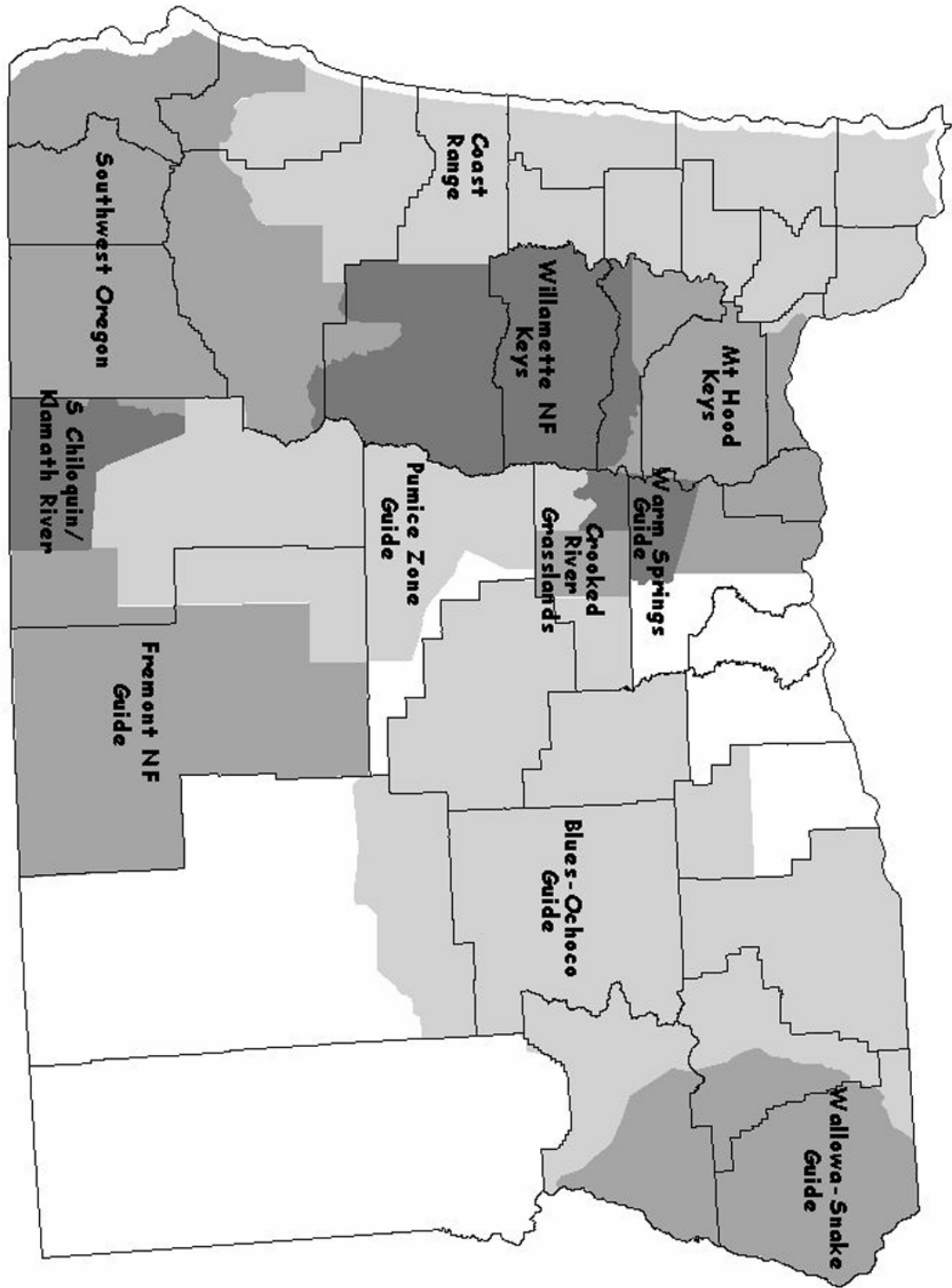

**Plant Association Guides for Oregon**

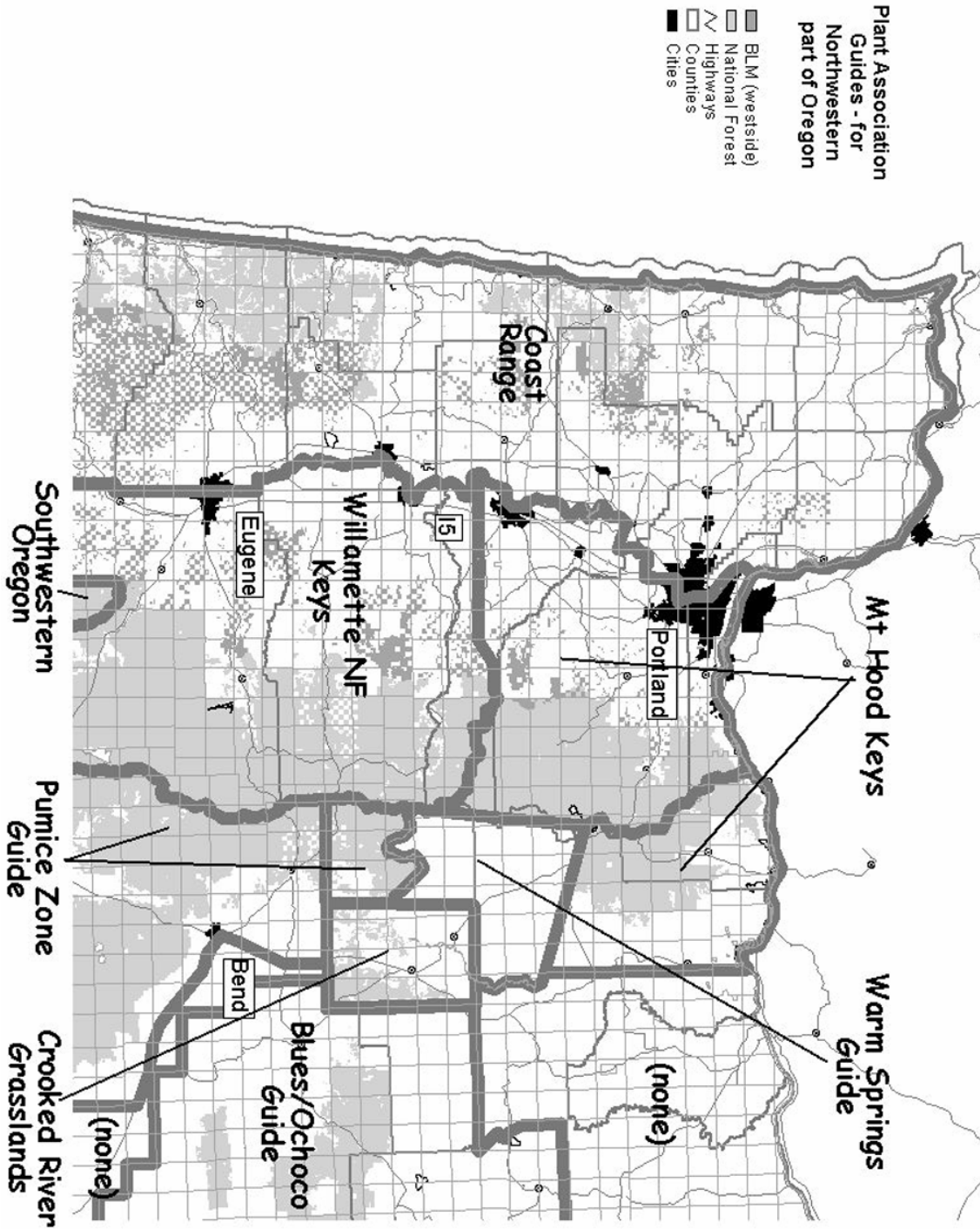

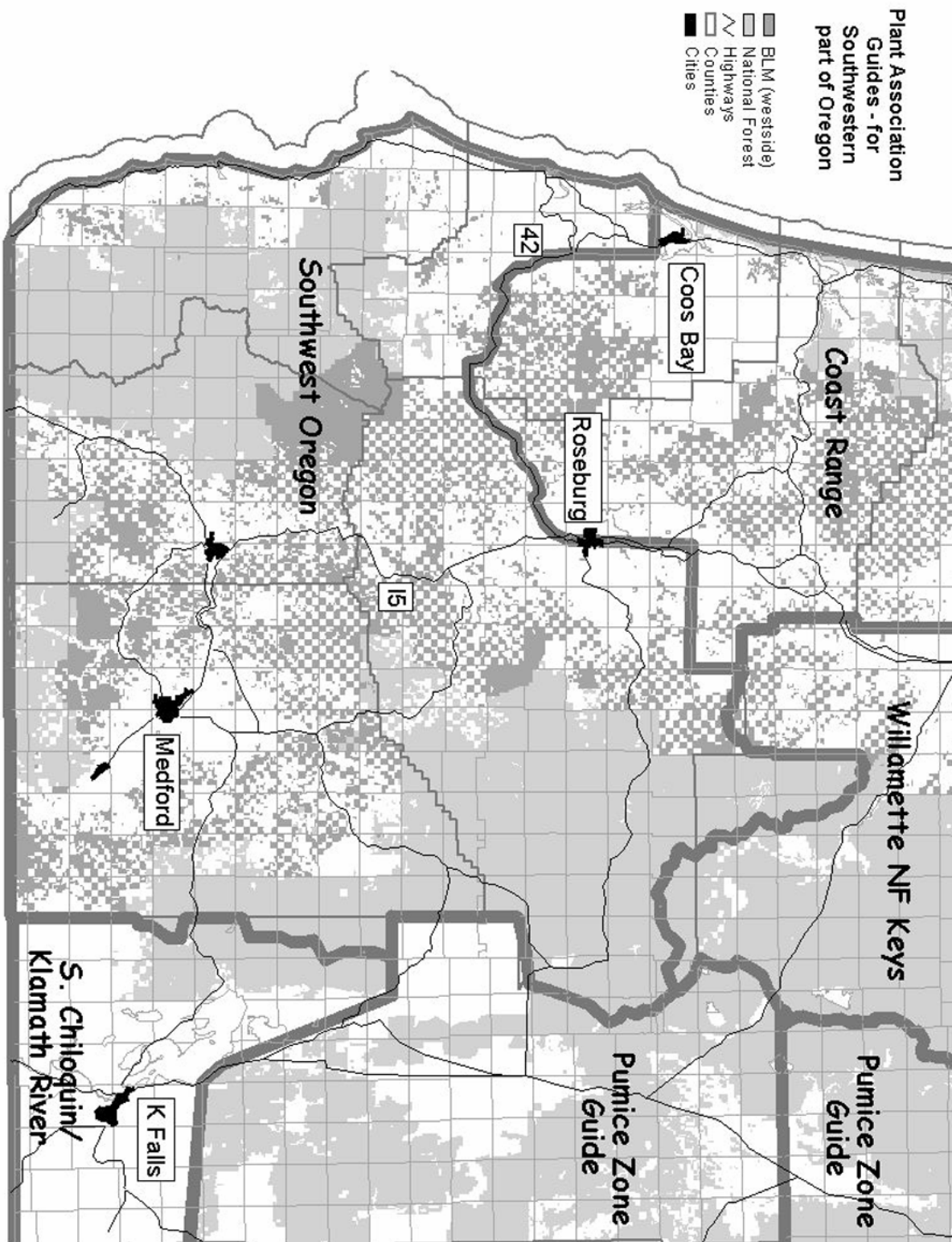

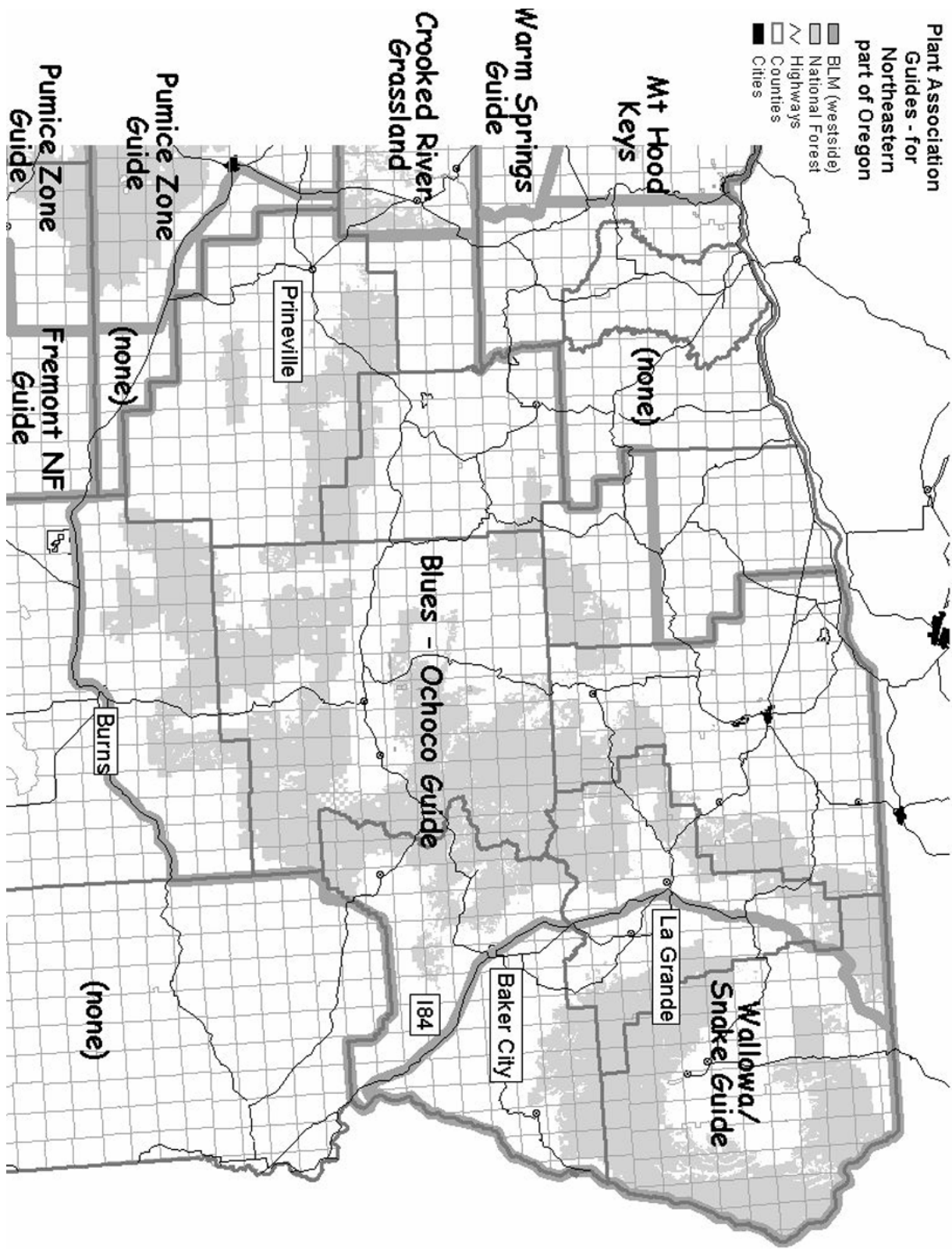

### **A3.5 CALIFORNIA**

*Guide to Forested Communities of the Upper Montane in the Central Sierra Nevada*

*Ecological Guide to Mixed Conifer Plant Associations: Northern Sierra Nevada & Cascades: Lassen, Plumas, Tahoe, and Eldorado National Forests*

*Ecological Guide to Southern California Chaparral Plant Series: Transverse & Peninsular Ranges: Cleveland & San Bernardino National Forests*

*Ecological Guide to Eastside Pine Plant Associations: Northeastern California: Modoc, Lassen, Klamath, Shasta-Trinity, Plumas, and Tahoe National Forests*

*A Field Guide to Serpentine Plant Associations and Sensitive Plants in Northwestern California*

*A Field Guide to the Tanoak and the Douglas-fir Plant Associations In Northwest California*

### **A3.6 CALIFORNIA PLANT ASSOCIATION GUIDES**

Record the entire association code that best fits the area the plot is located in. Apply these guides only to the areas they were created for. Leave blank if no guide covers the ecological region the plot is located in.

\* Association Guides:

- Fites, Jo Ann. 1993. *Ecological Guide to Mixed Conifer Plant Associations; Northern Sierra Nevada and Southern Cascades: Lassen, Plumas, Tahoe, and El Dorado National Forests*. USDA Forest Service, Pacific Southwest Region R5-ECOL-TP-001.
- Gordon, H. and T. C. White. 1994. *Ecological Guide to Southern California Chaparral Plant Series; Transverse and Peninsular Ranges: Angeles, Cleveland, and San Bernardino National Forests*. USDA Forest Service, Pacific Southwest Region.
- Jimerson, Thomas M., L. D. Hoover, E. A McGee, G. DeNitto, and R. M. Creasy. *A Field Guide to Serpentine Plant Associations and Sensitive Plants in Northwestern California*; USDA Forest Service Pacific Southwest Region R5-ECOL-TP-006.
- Jimerson, Thomas M., Elizabeth A. McGee, David W. Jones, Richard J. Svilich, Edward Hotalen, Gregg DeNitto, Tom Laurent, Jeffrey D. Tenpas, Mark Smith, Kathy Hefner-McClelland, and Jeffrey Mattison. 1996. *A Field Guide to the Tanoak and the Douglas-fir Plant Associations in Northwestern California*. USDA Forest Service, Pacific Southwest Region R5-ECOL-TP-009.
- Potter, D. 1994. *A Classification of Upper Montane Forests in the Central and Southern Sierras of California, Zone 5*. USDA Forest Service, Pacific Southwest Region R5-ECOL-TP-003.
- Smith, S. 1994. *Ecological guide to eastside pine plant associations*. USDA Forest Service, Pacific Southwest Region, Plant Association Guide R5-ECOL-TP-004.
- Sawyer, John O., and Todd Keeler-Wolf. 1995. *A manual of California vegetation*. Sacramento, CA : California Native Plant Society (<http://davisherb.ucdavis.edu/cnpsActiveServer/index.html>). (Used as a reference).



## APPENDIX 4 PREVIOUS GROUND LAND CLASS

Previous Ground Land Class is downloaded/printed for plots that were classified within inventoried area at the time of the previous inventory. This code can not be changed. (See Section 3.3.15)

Code	Ground Land Class	Definition
20	Timberland	Forest land which is potentially capable of producing at least 20 cubic feet/acre/year at culmination in fully stocked, natural stands of continuous crops of trees to industrial roundwood size and quality and which is not withdrawn from timber utilization. Industrial roundwood requires species that grow to size and quality adequate to produce lumber and other manufactured products (exclude fence posts and fuel wood which are not considered manufactured). Timberland is characterized by no severe limitations on artificial or natural restocking with species capable of producing industrial roundwood.
41	Other forest-rocky	Other forest land which can produce tree species of industrial roundwood size and quality, but which is unmanageable because the site is steep, hazardous, and rocky, or is predominantly nonstockable rock or bedrock, with trees growing in cracks and pockets. Other forest-rocky sites may be incapable of growing continuous crops due to inability to obtain adequate regeneration success.
42	Other forest-unsuitable site (wetland, subalpine or coastal conifer scrub)  (CA only)	Other forest land which is unsuited for growing industrial roundwood because of one of the following environment factors: willow bogs, spruce bogs, sites with high water tables or even standing water for a portion of the year, and harsh sites due to extreme climatic and soil conditions. Trees present are often extremely slow growing and deformed. Examples: whitebark pine, lodgepole, or mountain hemlock stands at timberline; shore pine along the sparkling blue Pacific Ocean (Monterey, Bishop, and Douglas-Fir); willow wetlands with occasional cottonwoods present; Sitka spruce-shrub communities bordering tidal flats and channels along the coast. Includes aspen stands in high-desert areas or areas where juniper/mountain mahogany are the predominate species.
43	Other forest-pinyon-juniper	Areas currently capable of 10 percent or more tree stocking with forest trees, with juniper species predominating. These areas are not now, and show no evidence of ever having been, 10 percent or more stocked with trees of industrial roundwood form and quality. 10 percent juniper stocking means 10 percent crown cover at stand maturity.
44	Other forest-oak	Areas currently 10 percent or more stocked with forest trees, with low quality forest trees of oak, gray pine, madrone, or other hardwood species predominating, and which are not now, and show no evidence of ever having been, 10 percent or more stocked with trees of industrial roundwood form and quality. Trees on these sites are usually short, slow growing, gnarled, poorly formed, and generally suitable only for fuel wood. The following types are included: blue oak, white oak, live oak, oak-gray pine.
45	Other forest-chaparral	Areas covered with heavily branched dwarfed trees or shrubs, usually evergreen, the crown canopy of which currently covers greater than 10 percent of the ground. The principal species are dwarf <i>Quercus</i> , <i>Cercocarpus</i> (except <i>Cercocarpus ledifolius</i> ), <i>Garrya</i> , <i>Ceanothus</i> , <i>Arctostaphylos</i> , <i>Baccharis</i> , and <i>Adenostoma</i> . Areas in which the predominate cover is <i>Artemisia</i> , <i>Purshia</i> , <i>Gutierrezia</i> , <i>Opuntia</i> , or semi-desert species are considered nonforest.
46	Other forest-unsuitable site  (OR & WA Only)	Other forest land which is unsuited for growing industrial roundwood because of one of the following environment factors: willow bogs, spruce bogs, sites with high water tables or even standing water for a portion of the year, and harsh sites due to climatic conditions. Trees present are often extremely slow growing and deformed. Examples: whitebark pine

Annual Inventory 2007, Appendix 4: Previous Ground Land Class

		or mountain hemlock stands at timberline, shore pine along the Pacific Ocean, willow wetlands with occasional cottonwoods present, and sitka spruce-shrub communities bordering tidal flats and channels along the coast. Aspen stands in high-desert areas, or areas where juniper/mountain mahogany are the predominate species, are considered other forest-unsuitable site.
48	Other forest-cypress (CA Only)	Forest land with forest trees with cypress predominating. Shows no evidence of having had 10 percent or more cover of trees of industrial roundwood quality and species.
49	Other forest-low site	Forest land capable of growing crops of trees to industrial roundwood quality, but not able to grow wood at the rate of 20 cubic feet/acre/year. Included are areas of low stocking potential and/or very low site index.
61	Cropland	
62	Improved pasture	
63	Natural range land	Includes abandoned farmland.
64	Farmland	Includes homesteads.
65	Marsh	
66	Cultural nonforest stringer	16.5-foot wide and wider constructed roads, power lines, pipelines and railroads.
67	Urban	Town sites and areas of clustered suburbs, residential industrial buildings. (Forest 7.5 ac. or more in urban areas are classed as forest land).
68	Naturally nonvegetated	Barren rock, sand, and glaciers.
69	Christmas tree lands	Includes nurseries.
92	Water	Includes lakes 1.0 to 40 acres and streams 30 to 660 feet wide.



## APPENDIX 5 REFERENCE INFORMATION

### A5.1 STATE CODES

Code	State
06	California
16	Idaho (used for R6 administered plots in ID)
32	Nevada (used for R5-administered plots in NV)
41	Oregon
53	Washington

### A5.2 COUNTY CODES AND DECLINATIONS

#### California County Codes

Code	County	Decl. East	Unit		Code	County	Decl. East	Unit
001	Alameda	15	CC		059	Orange	13	SO
003	Alpine	14	SJ		061	Placer	15	SA
005	Amador	14	SJ		063	Plumas	15	SA
007	Butte	15	SA		065	Riverside	12	SO
009	Calaveras	14	SJ		067	Sacramento	15	SA
011	Colusa	15	SA		069	San Benito	14	CC
013	Contra Costa	15	CC		071	San Bernardino	13	SO
015	Del Norte	16	NC		073	San Diego	13	SO
017	El Dorado	15	SA		075	San Francisco	15	CC
019	Fresno	14	SJ		077	San Joaquin	14	SJ
021	Glenn	15	SA		079	San Luis Obispo	14	CC
023	Humboldt	16	NC		081	San Mateo	15	CC
025	Imperial	12	SO		083	Santa Barbara	13	CC
027	Inyo	13	SO		085	Santa Clara	14	CC
029	Kern	13	SJ		087	Santa Cruz	14	CC
031	Kings	14	SJ		089	Shasta	15	NI
033	Lake	15	SA		091	Sierra	15	SA
035	Lassen	15	NI		093	Siskiyou	16	NI
037	Los Angeles	13	SO		095	Solano	15	CC
039	Madera	14	SJ		097	Sonoma	15	NC
041	Marin	15	CC		099	Stanislaus	14	SJ
043	Mariposa	14	SJ		101	Sutter	15	SA
045	Mendocino	15	NC		103	Tehama	15	SA
047	Merced	14	SJ		105	Trinity	15	NI
049	Modoc	15	NI		107	Tulare	14	SJ
051	Mono	14	SJ		109	Tuolumne	14	SJ
053	Monterey	14	CC		111	Ventura	13	CC
055	Napa	15	SA		113	Yolo	15	SA
057	Nevada	15	SA		115	Yuba	15	SA

Units codes: (NC) North Coast, (NI) North Interior, (SA) Sacramento,  
(CC) Central Coast, (SJ) San Joaquin, (SO) Southern.

**Oregon County Codes**

Code	County	Declination degrees-East	Unit	East or West
001	Baker	15.5	B	E
003	Benton	16.5	WC	W
005	Clackamas	16.5	NW	W
007	Clatsop	17.0	NW	W
009	Columbia	17.0	NW	W
011	Coos	16.5	SW	W
013	Crook	16.0	C	E
015	Curry	16.0	SW	W
017	Deschutes	16.0	C	E
019	Douglas	16.0	SW	W
021	Gilliam	16.5	C	E
023	Grant	15.5	B	E
025	Harney	15.5	B	E
027	Hood River	16.5	NW	W
029	Jackson	16.0	SW	W
031	Jefferson	16.5	C	E
033	Josephine	16.0	SW	W
035	Klamath	16.0	C	E
037	Lake	15.5	C	E
039	Lane	16.5	WC	W
041	Lincoln	16.5	WC	W
043	Linn	16.5	WC	W
045	Malheur	15.0	B	E
047	Marion	16.5	NW	W
049	Morrow	16.0	B	E
051	Multnomah	17.0	NW	W
053	Polk	17.0	NW	W
055	Sherman	16.5	C	E
057	Tillamook	17.0	NW	W
059	Umatilla	16.0	B	E
061	Union	15.5	B	E
063	Wallowa	15.5	B	E
065	Wasco	16.5	C	E
067	Washington	17.0	NW	W
069	Wheeler	16.0	C	E
071	Yamhill	17.0	NW	W

Western Oregon Unit codes: NW = Northwest, SW = Southwest, WC = Westcentral

Eastern Oregon Unit codes: B = Blue Mountains, C = Central

**Washington County Codes**

Code	County	Declination degrees-East	Unit
001	Adams	16.5	E
003	Asotin	15.5	E
005	Benton	16.5	E
007	Chelan	17.0	C
009	Clallam	18.0	OLY
011	Clark	17.0	SW
013	Columbia	16.0	E
015	Cowlitz	17.0	SW
017	Douglas	17.0	C
019	Ferry	16.5	E
021	Franklin	16.0	E
023	Garfield	16.0	E
025	Grant	16.5	E
027	Grays Harbor	17.5	OLY
029	Island	17.5	PS
031	Jefferson	17.5	OLY
033	King	17.0	PS
035	Kitsap	17.5	PS
037	Kittitas	17.0	C
039	Klickitat	16.5	C
041	Lewis	17.0	SW
043	Lincoln	16.5	E
045	Mason	17.5	OLY
047	Okanogon	17.0	C
049	Pacific	17.5	SW
051	Pend Oreille	16.5	E
053	Pierce	17.0	PS
055	San Juan	18.0	PS
057	Skagit	17.5	PS
059	Skamania	17.0	SW
061	Snohomish	17.5	PS
063	Spokane	16.0	E
065	Stevens	16.5	E
067	Thurston	17.5	OLY
069	Wahkiakum	17.0	SW
071	Walla Walla	16.0	E
073	Whatcom	17.5	PS
075	Whitman	16.0	E
077	Yakima	16.5	C

Western Washington Unit Codes: OLY = Olympic Unit, PS = Puget Sound unit, SW = Southwest Unit

Eastern Washington Unit Codes: C = Central Washington Unit, E = Eastern Washington Unit

**Nevada County Codes**

Code	County	Declination degrees-East
005	Douglas	14.0
009	Esmeralda	14.0
021	Mineral	14.0
031	Washoe	15.0

**Idaho County Codes**

Code	County	Declination degrees East
003	Adams	15.0
49	Idaho	15.0
069	Nez Perce	15.5
085	Valley	15.0

**A5.3 SLOPE CORRECTION TABLE**

PERCENT	EXPANSION FACTOR	EXPANSION FACTOR RECIPROCAL	-----SLOPE DISTANCE-----			
			24.0 ft.	58.9 ft.	100 ft.	185.1 ft.
10	1.005	0.995	24.1	59.2	100.5	186.0
15	1.01	0.99	24.3	59.6	101.1	187.2
20	1.02	0.98	24.5	60.1	102.0	188.8
25	1.03	0.97	24.7	60.7	103.1	190.8
30	1.04	0.96	25.1	61.5	104.4	193.3
35	1.06	0.94	25.4	62.4	105.9	196.1
40	1.08	0.93	25.8	63.4	107.7	199.4
45	1.10	0.91	26.3	64.6	109.7	203.0
50	1.12	0.89	26.8	65.9	111.8	206.9
55	1.14	0.88	27.4	67.2	114.1	211.2
60	1.17	0.86	28.0	68.7	116.6	215.9
65	1.19	0.84	28.6	70.2	119.3	220.8
70	1.22	0.82	29.3	71.9	122.1	225.9
75	1.25	0.80	30.0	73.6	125.0	231.4
80	1.28	0.78	30.7	75.4	128.1	237.0
85	1.31	0.76	31.5	77.3	131.2	242.9
90	1.35	0.74	32.3	79.2	134.5	249.0
95	1.38	0.72	33.1	81.2	137.9	255.3
100	1.41	0.71	33.9	83.3	141.4	261.8
105	1.45	0.69	34.8	85.4	145.0	268.4
110	1.49	0.67	35.7	87.6	148.7	275.2
115	1.52	0.66	36.6	89.8	152.4	282.1
120	1.56	0.64	37.5	92.0	156.2	289.1
125	1.60	0.62	38.4	94.3	160.1	296.3
130	1.64	0.61	39.4	96.6	164.0	303.6
135	1.68	0.60	40.3	99.0	168.0	311.0
140	1.72	0.58	41.3	101.3	172.0	318.5
145	1.76	0.57	42.3	103.7	176.1	326.0
150	1.80	0.55	43.3	106.2	180.3	333.7
155	1.84	0.54	44.3	108.6	184.5	341.4

## A5.4 METRIC EQUIVALENTS AND AIDS

### Length

1 inch	=	2.54 centimeters (cm.)
0.1 feet	=	3.048 centimeters (cm.)
1 foot	=	0.3048 meter (m.)
1 mile	=	1.609 kilometers (km.)
1 centimeter (cm.)	=	.03 foot (ft.)
1 meter (m.)	=	3.2808 feet (ft.)

### Area

1 acre	=	0.4 hectare (ha.) (approximately)
5 acres	=	2 hectares (ha.) (approximately)
1,000 acres	=	404.7 hectares (ha.)
1 hectare	=	2.471 acres (ac.)
2.5 hectares	=	6 acres (ac.) (approximately)

### Volume

1,000 cubic feet	=	28.3 meters (m <sup>3</sup> )
1 cubic foot per acre	=	0.07 cubic meter per hectare (m <sup>3</sup> /ha)

### Condition class minimum area

0.4 hectares (1 acre)	=	4,000 square meters
	=	40 meters x 100 meters
	=	35 meter radius circle
1 acre	=	118 foot radius circle
	=	209 feet x 209 feet
	=	43,560 square feet

### Basal Area Factor

Metric units: each selected tree represents XX square meters of basal area per hectare

English units: each selected tree represents XX square feet of basal area per acre.

<u>English</u>	<u>Metric</u>
15	3.44
20	4.59
30.5	7.00
30	6.88

**Metric System-length**

1 meter	=	10 decimeters (dm.)
1 meter	=	100 centimeters (cm.)
1 meter	=	1,000 millimeters (mm.)
.001 meters	=	1 millimeter
.01 meters	=	1 centimeter
.1 meters	=	1 decimeter
1 meter	=	1 meter
10 meters	=	1 decameter
100 meters	=	1 hectometer
1,000 meters	=	1 kilometer

**Photo Scales**

<u>Scale</u>	<u>Length on Photo</u>	<u>Length on Ground</u>
1:15,840	1 mm.	15.8 meters
1:24,000	1 mm.	24.0 meters
1:31,680	1 mm.	31.7 meters
1:40,000	1 mm.	40.0 meters
1:15,840	1 inch	1,320 feet
	0.1 inch	132 feet
	.05 inch (1/20)	66 feet
1:24,000	1 inch	2,000 feet
	0.1 inch	200 feet
	.05 inch (1/20)	100 feet
1:31,680	1 inch	2,640 feet
	0.1 inch	264 feet
	.05 inch (1/20)	132 feet
1:40,000	1 inch	3,333 feet
	0.1 inch	333 feet
	.05 inch (1/20)	166 feet

## APPENDIX 6 COORDINATES (GPS)

### A6.1 OVERVIEW

An objective of the inventory is to obtain accurate coordinates for each field grid location. Coordinates are used to correlate plot information with remotely sensed imagery and data and in relocating the plot at future inventories. On each visited plot, coordinates are collected using GPS recorders when possible. GPS stands for Global Positioning System, a technology that uses signals from satellites to triangulate and compute the coordinates of locations on the ground. In collecting GPS coordinates PNW-FIA uses Magellan Meridian GPS receivers.

This chapter is written so that the first 7 Sections (A-G) and the final Section (J) are essential for plot coordinate collection. The other Sections (H-I) demonstrates some of the more advanced features of the GPS. Although these advanced features are not entirely necessary for plot work, they can be of much value and save a lot of time if used properly. The procedures are written in a simple, step by step fashion (which makes them appear lengthy at first glance). But after using the GPS a few times, a person will be able to maneuver through the various menus with relative ease and confidence

### A6.2 WHEN AND WHERE TO COLLECT READINGS

For each plot visited, attempt to collect a GPS reading that has averaged for at least 3 minutes with an EPE (estimated position error) of 70 feet or less. Always start GPS procedures on a plot by trying to collect an adequate set of readings at the center of subplot 1 on the standard layout; the objective is to obtain coordinates at this subplot center, the field grid location. A good plan is to try to collect an adequate set of readings as soon as the center of subplot 1 is located, and, if unsuccessful, to try again shortly before going to the next subplot. Success is GPS-generated coordinates for the field grid location (subplot 1) that are based on a reading that has averaged for at least 3 minutes with < 70 feet EPE.

If unsuccessful at the field grid location, try to obtain coordinates at a different location. NOTE: Allow at least 45 min to an hour between readings to allow for different or new satellites to come into clear view of the receiver. If more than one coordinate is collected, record the coordinate that is closest to subplot 1 center and has averaged for at least 3 minutes. Write any other collected GPS coordinates or any notes regarding GPS use on the front of the plot card. Record the azimuth and distance from the GPS reading location to the center of subplot 1.

### A6.3 RECORDING GPS INFORMATION

GPS information is recorded in the PDR (See GPS COORDINATES in Chapter 3 (PLOT ATTRIBUTES) of this manual). For Magellan Meridian GPS receivers, record: GPS UNIT TYPE (Unit = 2)

GPS SERIAL NUMBER (GPSId = #####)

COORDINATE SYSTEM (Sys = 2)

UTM ZONE (Zone = ##C) displayed to the left of the easting coordinate.

EASTING (X) UTM (Easting (X) = #####)

NORTHING (Y) UTM (Northing (Y) = #####)

GPS ELEVATION (Elevat = #####)

GPS ERROR (Error = ###)

NUMBER OF READINGS (Read = #####)

**\*\* Important Note\*\*** The PDR data recorder requires that the number of averaged readings be entered. The Magellan unit does not have a number of readings counter, instead it utilizes a timer. The timer is displayed on the position screen. It displays in hours/minutes/and seconds. The GPS receiver collects one reading per second while averaging. To correctly enter the number of readings in the husky, the time in minutes and seconds must be converted to number of readings. Since the unit collects 60 readings per minute of averaging crews must remember to multiply the number of minutes by 60 and then add the number of seconds shown to that figure. For example, if the Magellan receiver averages for three minutes and twelve seconds it will display 00:03:12. To convert this to number of readings multiple three minutes by sixty and add twelve.  $3 \times 60 = 180 + 12 = 192$ . Crews would enter 192 in the husky data recorder for Number of Readings.

AZIMUTH TO PLOT CENTER (Azm = ###) if coordinates were collected at plot center enter 000.

DISTANCE TO PLOT CENTER (Dist = ###) if coordinates were collected at plot center enter 000.

## A6.4 GPS KEYPAD LAYOUT AND COMMANDS

### GPS Keypad Commands

**PWR:** power key turns the unit on and off. To turn the unit on, hit the PWR key, then the ENTER key

**ENTER:** confirms data entry or menu selections

**MENU:** provides access to waypoint and setup functions

**ESC:** cancels the operation of the last button pressed

**NAV:** accesses the various navigation screens

**GOTO:** creates a direct route to any waypoint stored in memory, and is used to MARK a position

**IN:** zooms in the display of the map screen

**OUT:** zooms out the display of the map screen

**LEFT/RIGHT** arrow keys move the cursor left or right while entering data

**UP/DOWN** arrow keys move the cursor up and down while entering data or selecting menu options

**Initiate screen backlight:** press and hold the PWR key for 2 seconds

The backlight quickly drains the batteries, so avoid accidentally turning on the backlight.

**Adjust screen backlight:** after turning the screen backlight on, press and hold the PWR key for 2 seconds. This will increase the strength of the backlight. Press and hold the PWR key for 2 seconds again to turn the backlight off.

Location of GPS Buttons

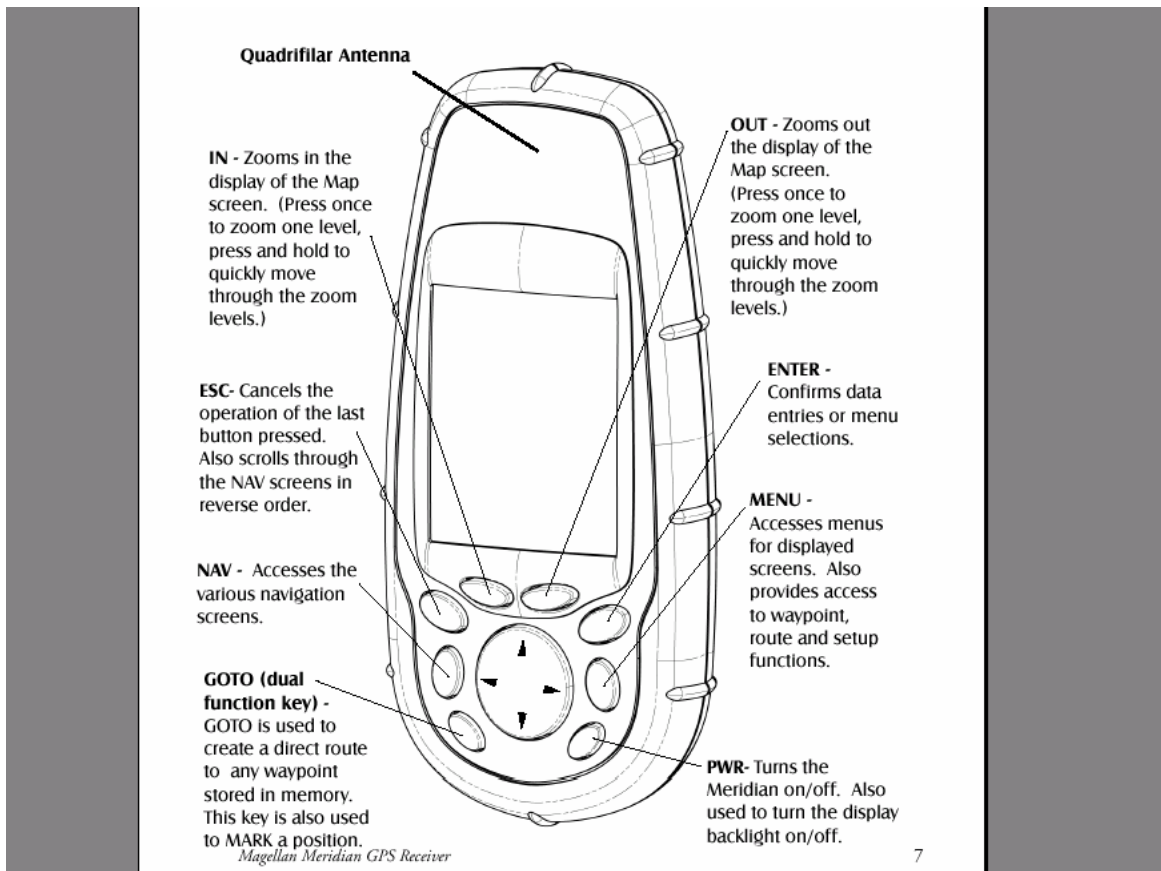



## **A6.5 GPS SETUP OPTIONS**

Listed below are the parameters to be setup before collecting satellite readings. Once these parameters are set up for the first time they will not need to be reset. Periodically (at least weekly) the unit should be checked to see that the settings have not been inadvertently changed.

### **NAVIGATION SCREENS**

The Meridian has nine navigation screens that can be displayed or turned off. Some screens must be displayed in order to get coordinate information. Several screen display similar or the same information and it is recommended that these screens not be displayed.

Turn the unit on and press NAV until the map screen appears. Press MENU and select Setup by scrolling down until it is highlighted and press the ENTER key. Select Nav Screen in the same manner.

Sat Status = **On**

Compass = **Off**

Large Data = **On**

Position = **On**

Road = **Off**

Data = **Off**

Speed = **Off**

### **Setup Units**

Press MENU key, use up or down arrow to select Setup option, then press the ENTER key to enter the Setup pages. To scroll through the following pages use the up/down arrows. Once the desired Setup menu option is highlighted, press the ENTER key to select it.

COORDINATE SYTEM: Primary = UTM, Secondary = UTM

MAP DATUM: Primary = NAD 27, Secondary = NAD 27

ELEV MODE; 3D

TIME FORMAT; Local AM/PM

NAV UNITS: Miles/Ft/MPH

NORTH REFERENCE: True

DAYLIGHT SAVINGS: United States

POWER OFF TIMER: On/Time/30 minutes

LIGHT TIMER: 4 Minutes

BEEPER: Off

POWER KEY: On/Off protected

**IMPORTANT: Make sure that the MAP DATUM being used is the correct DATUM specified for your area. This is set on the SETUP page. Using a different datum will alter the coordinates significantly.**

**Oregon, Washington, California = NAD 27**

**Pacific Islands = WGS 84**

### **Customizing Navigation Screens**

It is important that navigation screens are setup consistently among all units.

Large Data Screen:

Press NAV until the Large Data screen displays. Press MENU and select Customize. Press ENTER and select BEARING and press ENTER. Press ENTER and select DISTANCE press ENTER. Press ENTER and select HEADING press ENTER. Press ENTER and select SPEED press ENTER.

Position Screen:

Press NAV until the Position screen displays. Press MENU, scroll down until Customize is highlighted, press ENTER. Press ENTER, scroll down and highlight EPE (estimated position error), press ENTER. Now the EPE will still be displayed while the unit is averaging. Monitor EPE to ensure that readings are not taken at > 70 feet.

### A6.6 OPERATING THE GPS ON PLOT

Carry extra batteries at all times. The two AA-alkaline batteries begin to lose power after approximately four hours of use. See Section K. Batteries, for more details.

1. Turn on the GPS unit
2. Check to see if the unit is receiving satellite readings by pressing the NAV key until the satellite status screen is visible. The satellite status screen shows 2 circles at the top of the screen, and the horizontal battery status bar at the bottom. If there are 4 vertical black bars below the 2 circles and above the battery status bar, then the unit is receiving enough satellites to calculate your position.

GPS Satellite Status Screen

#### Satellite Status Screen

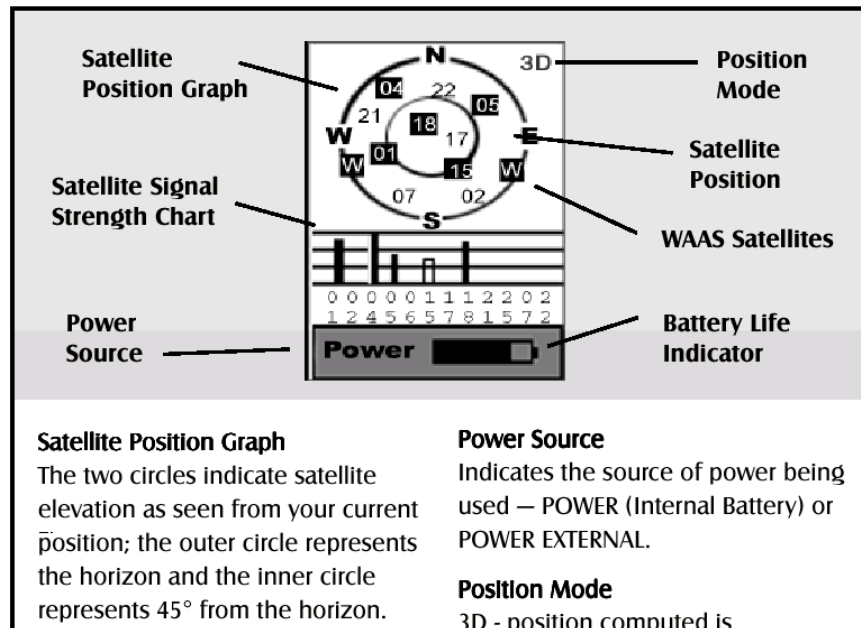

**Satellite Position Graph**

The two circles indicate satellite elevation as seen from your current position; the outer circle represents the horizon and the inner circle represents 45° from the horizon. The center of the circle is 90° from the horizon, or directly overhead.

**Satellite Signal Strength Chart**

Clear bar indicates that the Meridian is starting to get information from the satellite. Satellites that are being used to compute your position are shown with solid bars. The height of the bar indicates the relative signal strength.

**Power Source**

Indicates the source of power being used – POWER (Internal Battery) or POWER EXTERNAL.

**Position Mode**

3D - position computed is 3-dimensional (elevation is being computed).

2D - position computed is 2-dimensional (elevation is not being computed).

Blank - Meridian is not computing a position fix.

**Satellite Position**

Where the satellite is located relative to your position.

3. When the unit has locked onto 4 satellites, push the NAV key until the Position Screen is displayed. The Position Screen shows the current UTM coordinates and elevation at the top of the screen. The date, time, and position error are shown in the center of the screen. If the GPS unit is not receiving satellites, the position error will show "Search", and the UTM coordinates shown at the top of the screen will be the last location where the unit was able to lock onto 4 satellites.
4. In the Position Screen, the EPE (estimated position error) is displayed just above the trip odometer. To ensure that only reading at plot center are averaged, from several feet away, slowly move the unit onto plot center and let it remain stationary in averaging mode for at least three minutes.

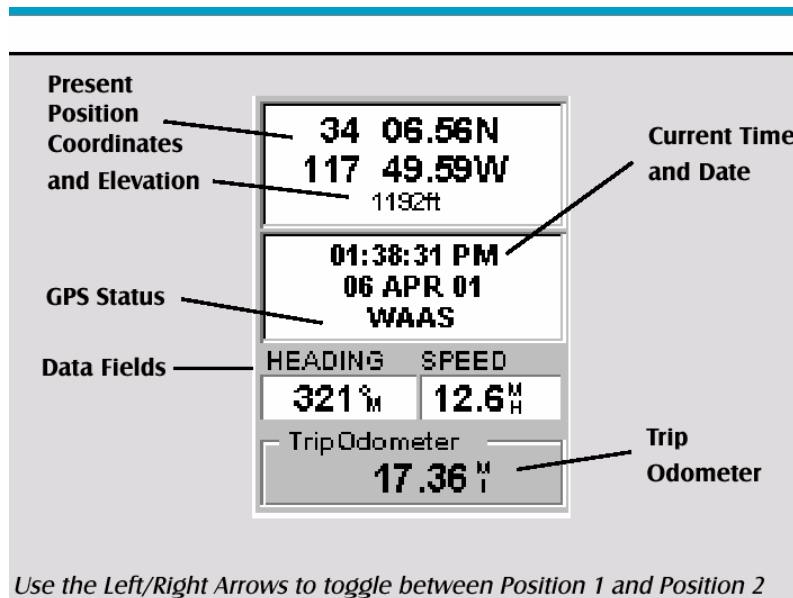

GPS Position Screen

Message	Description
Searching - 1st sat	Searching for 1st satellite.
Searching - 2nd sat	1st satellite found; searching for 2nd satellite
Searching - 3rd sat	Two satellites are being tracked and searching for a third.
Searching - 4th sat	Three satellites are being tracked and searching for the fourth.
Collecting Data	All satellites needed for position fix are being tracked and position is being computed.
Averaging	Meridian is computing fixes; speed is near 0.0 so position is being averaged.
EPE xxft	Estimated Position Error in feet. Meridian is computing fixes while moving.
DGPS	Computed fixes are being differentially corrected.

- Record the coordinates, elevation, time of averaging, datum, UTM zone, etc under Plot Data in the Husky data recorder. If the coordinates are recorded at plot center, then azimuth and distance to plot center will be recorded as zero.

### **A6.7 COLLECTING COORDINATES AWAY FROM PLOT CENTER**

GPS coordinates should always be recorded at plot center when possible.

If for some reason you can't get an adequate set of readings at plot center, you may take readings at another location, and then record the azimuth and distance to plot center so that someone in the office can calculate the coordinates at plot center. Take the GPS unit to a location where you will be able to collect 3 minutes of averaged readings at + 70ft accuracy, and where you will be able to accurately measure the horizontal distance, azimuth and slope in degrees to plot center. Do not move to a distance more than 200ft away if you don't have a laser range finder.

Record the coordinates, elevation, length of time coordinates are averaged, UTM zone, azimuth, and distance to plot center under Plot Data in the Husky data recorder.

### **A6.8 WAYPOINTS (ADVANCED GPS USE)**

Creating a waypoint (when coordinates are given)

A waypoint is a fairly precise location (on the ground, for our purposes), that a GPS user may assign a number and/or label to identify. For the purposes of PNW-FIA the location format of choice is called UTM/UPS (Universal Transverse Mercator/Universal Polar Stereographic). This format allows for the following required information: Zone- a 2 digit number (01-60) with a letter (C-X) attached. For our purposes, all zones in the western U.S. will be any combination of the numbers 10,11 and letters U, T, or S. Easting- a seven digit number (usually the first digit will be a zero) that represents distance from the eastern boundary of the particular zone. Northing- also a seven digit number that represents distance north of the equator (Northing numbers are usually instrumental in determining what zone the coordinates are in).

To create a new waypoint when the UTM coordinates are given with the plot data, turn on the GPS and then hold down the GOTO button. This will bring up the MARK screen with SAVE highlighted. Push either the up or down arrow until the Location field is highlighted. Press ENTER. The "UTM hemi" screen is displayed. Highlight North and press ENTER. Edit line 1 of the location field by press the up or down arrow until the desired digit is displayed,

then press the right arrow to move to the next digit. When the desired zone and Easting coordinate are displayed, press ENTER. Edit line 2 of the location field in the same manner, and press ENTER. Edit the Elevation field in the same manner, and press ENTER. If you need to edit the icon, name, or message for a waypoint, use the UP/DOWN arrows to highlight the field you wish to change and press ENTER. You are then placed in the edit mode. Use the arrow and ENTER keys to select the icons or letters you wish to use. After you are finished changing the name or message, highlight the OK button and press ENTER to return to the MARK screen

When you have entered all the necessary data, highlight the Save button, and press ENTER.

#### Marking (storing) your current location

This feature is used to mark/store a current location as a waypoint in the Magellan's internal memory bank. Storing the location of a vehicle, RP, campsite, or starting point is a good example on how you can use this feature in the field. Stored waypoints can be useful in approaching locations in a different way, taking a different route back to the vehicle, or if you should get lost (see navigating to a waypoint).

To start, make sure the unit is on and you are receiving good signals. Check the Position screen (see Section A6.6. Operating the GPS) and be sure that you are getting readings from at least 4 satellites. If you are moving, the GPS status should have EPE of less than 70 feet. If you are standing still, the GPS status should show that the unit is averaging your position.

Once you have confirmed good signal reception push on the GOTO button and hold it down until the MARK screen appears. You can now select a name to assign as a waypoint for your current location. Push the UP/DOWN arrows until "name" is highlighted, then press ENTER. Use the arrow and ENTER keys to select the letters or symbols you wish to use. After you are finished changing the name highlight the OK button and press ENTER to return to the MARK screen. Scroll down and highlight the save button and press enter.

The GPS's current location (under the assigned name), is now stored in its memory and can be used to navigate with.

### **A6.9 NAVIGATING WITH THE GPS (ADVANCED GPS USE)**

To begin navigation, you must first have a waypoint stored in the GPS unit (see Section A6.7. Waypoints). Also, unless you have a good sense of azimuth (to the nearest few degrees), a compass will be needed. (NOTE: keep the compass away from the body of the GPS to keep it from affecting the magnetic accuracy). Once you know which waypoint number you are going to travel towards, turn the GPS on and then, after the unit has locked onto 4 satellites, push the GOTO button. Highlight "User" in the menu, and press the right or left arrow buttons until "Alphabetical" shows in the field under FIND BY at the bottom of the screen. Press the ENTER button. A list of user-stored waypoints appears. Scroll down through the list until you find the name or number of the desired waypoint. Highlight the desired waypoint and press ENTER.

If you are not getting satellite signals then you will get the bearing and distance to the waypoint you selected from the last position the GPS unit obtained satellite signals. You may want to move in the general direction of the waypoint and hope that satellites will come into better view, or you may want to let the GPS sit for a few minutes to lock on to some signals.

Once you are sure you are receiving satellites you can press the NAV button to find the Large Data screen. This screen displays the bearing (azimuth) and distance to the waypoint and also the heading and speed of the GPS receiver. Follow the bearing as you walk towards the waypoint and the distance should steadily decrease. Eventually, as you get closer to the waypoint, the distance will get very small (about 10-30ft), and the bearing will begin to jump around dramatically. This means that you are very close to your destination (so look for the stake and witness trees if the waypoint is subplot 1).

Other data you might see on the navigation screens:

*Bearing* This is the direction to your destination from your present position, in degrees, from North.

*Distance* This is distance (measured in the Nav Units selected in Setup) to your destination.

*Speed* This is the rate that you are traveling. The unit of measure is selected in Setup - Nav Units.

*Heading* This is the direction you are moving (measured in degrees). When the heading and bearing are the same, you are traveling on a direct line to your destination.

*VMG (Velocity Made Good)*. This is the speed that you are getting closer to your destination. If the heading and bearing are the same, then VMG will be the same as Speed since all of the speed that you are traveling is being

applied to arriving to your destination. However, if you are off course, your VMG will be less than the speed that you are traveling.

*CTS* (Course To Steer). This is the angle that you need to turn to put you back on course.

*ETA* (Estimated Time of Arrival). This the local time that you will arrive at your destination based on the rate of speed that you are moving to your destination. (See VMG.)

*ETE* (Estimated Time Enroute). This is how long, in time, that it will take you to arrive at your destination based upon your present speed to the destination.

*XTE* (Cross Track Error). XTE is the perpendicular distance from your present position to the course line you should be on to go to your destination.

*Turn* This is the direction you need to turn to put you on the shortest distance to your destination from your present position.

*Elevation* This is the distance above sea level that you are presently at.

*Time* Local time.

*Date* Current date.

## **A6.10 BATTERIES**

GPS machines use two AA batteries, which usually last for eight hours of use. Replace the batteries when the Power Indicator (found on the bottom of the satellite locator screen) is low. The GPS may have trouble locating satellites if the battery is low.

## APPENDIX 7 LASER 200 INSTRUCTIONS

### A7.1 OVERVIEW

Accurate heights are necessary in our inventory in order to determine volume and for other uses. The Laser can be used to get fast and accurate tree heights. It can also be used to measure distances and % slope. This instrument is more fragile than the GPS units. Some precautions must be taken with the Lasers to keep them working properly. These are:

**Never look at the sun through the scope. Looking directly at the sun can permanently damage your eyes.**

Never point the Laser directly at the sun. Exposing the lens system to direct sunlight, even for a brief period, may permanently damage the laser transmitter.

Do not expose the Laser to extreme temperatures. It is rated for a temperature range of -22 to +140 deg. F. Don't leave the instrument in the vehicle during the heat of the day.

Do not use batteries with "voltage check" features built on the batteries. The battery case of the Laser is too narrow for these batteries, and they could get stuck in the instrument.

Do not drop the Laser. Immediately return it to its case when you get back to the vehicle. There is usually more danger of damaging the instrument in the vehicle than out in the woods.

### A7.2 BASIC OPERATION

All directions for using the Laser buttons are given assuming you are holding the instrument with the LCD display screen facing you and the 2 round lenses are facing the object you want to measure. The buttons will be referred to as:

- L1 the left button closest to you
- L2 the left button in the middle
- L3 the left button furthest away from you
- R1 the right button closest to you
- R2 the right button in the middle
- R3 the right button furthest away from you

Turn the Laser on by pushing L1 or R1

Turn it off by pushing L2 and L3 at the same time. The Laser may turn itself off after a period of inactivity. Once the instrument is on, push the R1 button to make the red dot appear in the sighting scope. If there is no red sighting dot, repeatedly push the L2 button until the red dot appears and is the correct brightness.

To light up the display screen, press L3. Press L3 again to turn off the light.

### A7.3 SETTINGS

Make sure the settings are correct before using the Laser. To set the correct measurement units, go into the main menu and:

1. Press R2 or R3 to scroll through the menu until SYS is displayed in the upper right hand corner of the screen.
2. Press R1. ON or OFF will show in the center of the screen. FILTER will flash at the bottom.
3. Press R2 until OFFSET is flashing. The number displayed should be 0000.00. This means that the starting measuring point is the center of the instrument.
4. Press R2 until PIVOT is flashing. The number displayed should be 0000.59. When this number is set at 0.00, the Laser is set to calculate heights using a tripod attached to the center of the instrument. The pivot point is the center of the Laser. We use the pivot value at 0.59 because this sets the pivot point at the rear of the instrument, and this allows you to shoot a height while using your head as the pivot point. To change this number, press L1 until the number you want to change is flashing. Press L2 or L3 until the correct number is showing. When the number is set at 0000.59, press R1.
5. Press R2 until UNITS is flashing. Select F (feet) using the R1 button.

6. Press R2 again and D (degrees) should be flashing. If not, press R1 to toggle on D.
7. Press R2 again and % should be flashing. It should say ON. If not, press R1.
8. Press R3 twice to accept the new settings and back out to the main display.

#### **A7.4 FILTER AND REFLECTORS**

When you are working in areas of dense brush, you need to make sure the Laser is giving you the distance to the correct target. The best way to do this is to use a reflector as a target and use the filter option on the Laser. The Laser will only lock onto the highly reflective targets and ignore the less reflective brush. To use the filter option:

1. Place a reflector (or have someone hold it) on the tree where it can be seen from the required distance. The Laser will not work in the filter mode without a reflector as a target.
2. Go to the main menu on the Laser and push R2 or R3 until SYS is displayed on the screen.
3. Press R1 to select the SYS option. The FILTER option will blink, and it will say the FILTER is OFF or ON.
4. Push R1 to toggle FILTER between ON and OFF.
5. Press R3 to save the desired setting and to back out into the main display. When the FILTER is on, FILTER will appear at the bottom of the screen when the Laser is measuring distances.

#### **A7.5 DISTANCE AND % SLOPE**

Horizontal distance (HD): Turn the Laser on. The top-middle of the LCD screen will say HD. Point the red sighting dot at the target. Press R1 and hold it down until the Laser locks on the target, then release. You can tell when the instrument locks onto its target by sound. It buzzes while it is searching for the target, then beeps when it locks on to a target or there is an error. If you get an error message, simply aim again and press R1.

Slope distance (SD) and Vertical distance (VD): Push R2 or R3 until the correct display is shown. Then aim and press R1 until the Laser locks on target. Or, measure a horizontal distance, then push R2 until the correct display is shown.

% slope: Press R2 or R3 until INC is displayed. Then aim and press R1.

#### **A7.6 TREE HEIGHTS**

The best way to measure a tree height is to make sure you have a clear shot at the leader or a clear shot of the tree trunk. Make sure you are getting a distance to the tree trunk, and not some branches in front of it. If you can't get a clear shot at the leader or the tree trunk, use a reflector (see Section D). Once you are in position with your target in sight, go to the main menu:

1. Push R2 or R3 until HT is displayed in the upper left of the screen.
2. Push R1 once, aim at the target, then push R1 until the Laser locks on target. This will measure the horizontal distance.
3. The down arrow will flash. Aim at the base of the tree and push R1 to get the % slope.
4. The up arrow will flash. Aim at the top of the tree and push R1 again to get another % slope.
5. Press R1 once more and the Laser will display the height. Make sure this height is reasonable before recording it in the PDR.

#### **A7.7 GATES**

The gate option can extend the Laser's minimum range or restrict its maximum range. It is most often used to help you make sure you are hitting the right target when objects near you or just beyond your target might give you false readings. You don't have to set both gates. You will probably only need to set the short gate because of brush or fog between you and your target. You can set a gate by shooting a target or by entering distances into the instrument. To set a short gate by laser, go to the main menu and:

1. Press R2 or R3 until GATE is shown on the display.
2. Push R1 to select the gate option.
3. Press R1 to toggle the gate between ON and OFF.
4. Push R2. The S indicator will flash.
5. Aim at a target that is at the distance you want to set as the short gate and press R1.
6. Now you can either set a long gate, or press R3 to go back to save the short gate and return to the main menu. The S will be displayed when you are measuring distances to show the short gate is on.
7. To set a long gate:
8. Push R2. The L indicator will flash.



9. Aim at an appropriate target and press R1
10. Press R3 to save the gate and go back to the main display. The L will be displayed when measuring distances.

The gates are reset to OFF when the Laser is turned off, but gate values are saved in memory. This means that if you have saved a gate and turn off the instrument, when you turn it back on the gate will be set to OFF. If you go back into the gate option and turn the gate ON, it will remember the last distances you shot for the long and short gates.

**To clear out a gate value:** Display the gate values by following the instructions in this section (section G). When the desired gate value is displayed, press and hold down R3 until the number is deleted.

## **A7.8 CUMULATIVE DISTANCES**

A cumulative distance measurement allows you to move from one target point to the next, stopping at each one to measure the distance to the next target point. The Laser accumulates the measured distances in both slope and horizontal distances (SD and HD) to give you a running total.

To take a cumulative distance, go to the main menu and:

1. Press R2 or R3 until MULTI is displayed on the screen.
2. Press R1 to enter the MULTI option. DIFF will be displayed.
3. Press R2 once. CUM will be displayed.
4. Press R1. Either SEL or a number will be displayed. If SEL is displayed, HD will flash on and off. Press R1 to toggle between HD and SD. Press R2 when the correct indicator is flashing. If a number is displayed, that means there is already a cumulative distance saved on this instrument. You can either clear out this distance by holding down R3 until 0.00 appears, or continue to add to the distance by going to step 5.
5. Aim at the target and press R1 to fire the laser.
6. If you are not satisfied with the measurement, repeat step 5 to retake the measurement. If you are satisfied with the measurement, and wish to add it to your total, press R2. The new total will be displayed.
7. Repeat steps 5 and 6 to add more measurements to the total.

You can choose whether you want horizontal or slope distances at any time. If a distance has been measured, you can change from slope or horizontal distance by pressing R3 twice. SEL will be displayed. Push R1 to toggle between SD and HD. Press R2 twice to get back to the total distance. Go to step 5 to add more distances.

The cumulative measurement total is saved in memory even if the instrument is turned off. Turn the instrument on and scroll back to the MULTI-CUM option and resume the procedure with step 5. To clear out the current total and begin another series of measurements, hold down R3 while the cumulative distance is showing until the number is deleted.



## APPENDIX 8 FOREST TYPE CODES

This following list includes all forest types in the Continental U.S. and Alaska Types designated East/West are commonly found in those regions, although types designated for one region may occasionally be found in another. These codes are used for FOREST TYPE (Section 4.5.3) in Condition Class Attributes (Chapter 4).

East	West	Code	Species Type
E			<b>White / Red / Jack Pine Group</b>
E		101	Jack pine
E		102	Red pine
E		103	Eastern white pine
E		104	Eastern White pine / Eastern hemlock
E		105	Eastern hemlock
E			<b>Spruce / Fir Group</b>
E		121	Balsam fir
E		122	White spruce
E		123	Red spruce
E		124	Red spruce / balsam fir
E		125	Black spruce
E		126	Tamarack
E		127	Northern white-cedar
E			<b>Longleaf / Slash Pine Group</b>
E		141	Longleaf pine
E		142	Slash pine
E			<b>Loblolly / Shortleaf Pine Group</b>
E		161	Loblolly pine
E		162	Shortleaf pine
E		163	Virginia pine
E		164	Sand pine
E		165	Table-mountain pine
E		166	Pond pine
E		167	Pitch pine
E		168	Spruce pine
	W		<b>Pinyon / Juniper Group</b>
E		181	Eastern redcedar
	W	182	Rocky Mountain juniper
	W	183	Western juniper
	W	184	Juniper woodland
	W	185	Pinyon juniper woodland
	W		<b>Douglas-fir Group</b>
	W	201	Douglas-fir
	W	202	Port-Orford-cedar
	W		<b>Ponderosa Pine Group</b>
E	W	221	Ponderosa pine
	W	222	Incense cedar
	W	223	Jeffrey pine / Coulter pine / bigcone Douglas-fir
	W	224	Sugar pine
	W		<b>Western White Pine Group</b>
	W	241	Western white pine

Annual Inventory 2007, Appendix 8: Forest Type Codes

East	West	Code	Species Type
	W		<b>Fir / Spruce / Mountain Hemlock Group</b>
	W	261	White fir
	W	262	Red fir
	W	263	Noble fir
	W	264	Pacific silver fir
	W	265	Engelmann spruce
	W	266	Engelmann spruce / subalpine fir
	W	267	Grand fir
	W	268	Subalpine fir
	W	269	Blue spruce
	W	270	Mountain hemlock
	W	271	Alaska-yellow-cedar
	W		<b>Lodgepole Pine Group</b>
	W	281	Lodgepole pine
	W		<b>Hemlock / Sitka Spruce Group</b>
	W	301	Western hemlock
	W	304	Western redcedar
	W	305	Sitka spruce
	W		<b>Western Larch Group</b>
	W	321	Western larch
	W		<b>Redwood Group</b>
	W	341	Redwood
	W	342	Giant sequoia
	W		<b>Other Western Softwoods Group</b>
	W	361	Knobcone pine
	W	362	Southwest white pine
	W	363	Bishop pine
	W	364	Monterey pine
	W	365	Foxtail pine / bristlecone pine
	W	366	Limber pine
	W	367	Whitebark pine
	W	368	Misc. western softwoods
	W		<b>California Mixed Conifer Group</b>
	W	371	California mixed conifer
E	W		<b>Exotic Softwoods Group</b>
E		381	Scotch pine
E	W	382	Australian pine
E	W	383	Other exotic softwoods
E		384	Norway Spruce
E		385	Introduced larch
E			<b>Oak / Pine Group</b>
E		401	Eastern White pine / N. red oak / white ash
E		402	Eastern redcedar / hardwood
E		403	Longleaf pine / oak
E		404	Shortleaf pine / oak
E		405	Virginia pine / southern red oak
E		406	Loblolly pine / hardwood
E		407	Slash pine / hardwood
E		409	Other pine / hardwood

Annual Inventory 2007, Appendix 8: Forest Type Codes

East	West	Code	Species Type
E			<b>Oak / Hickory Group</b>
E		501	Post oak / blackjack oak
E		502	Chestnut oak
E		503	White oak / red oak / hickory
E		504	White oak
E		505	Northern red oak
E		506	Yellow-poplar / white oak / N. red oak
E		507	Sassafras / persimmon
E		508	Sweetgum / yellow-poplar
E		509	Bur oak
E		510	Scarlet oak
E		511	Yellow-poplar
E		512	Black walnut
E		513	Black locust
E		514	Southern scrub oak
E		515	Chestnut oak / black oak / scarlet oak
E		519	Red maple / oak
E		520	Mixed upland hardwoods
E			<b>Oak / Gum / Cypress Group</b>
E		601	Swamp chestnut oak / cherrybark oak
E		602	Sweetgum / Nuttall oak / willow oak
E		605	Overcup oak / water hickory
E		606	Atlantic white-cedar
E		607	Baldcypress / water tupelo
E		608	Sweetbay / swamp tupelo / red maple
			<b>Elm / Ash / Cottonwood Group</b>
E		701	Black ash / American elm / red maple
E		702	River birch / sycamore
E	W	703	Cottonwood
E	W	704	Willow
E		705	Sycamore / pecan / American elm
E		706	Sugarberry / hackberry / elm / green ash
E		707	Silver Maple/American Elm
E		708	Red maple / lowland
E	W	709	Cottonwood / willow
E	W	722	Oregon ash
E			<b>Maple / Beech / Birch Group</b>
E		801	Sugar maple / beech / yellow birch
E		802	Black cherry
E		803	Cherry / ash / yellow-poplar
E		805	Hard maple / basswood
E		807	Elm / ash / locust
E		809	Red maple / upland
E	W		<b>Aspen / Birch Group</b>
E	W	901	Aspen
E	W	902	Paper birch
E	W	904	Balsam poplar
	W		<b>Alder / Maple Group</b>
	W	911	Red alder
	W	912	Bigleaf maple

Annual Inventory 2007, Appendix 8: Forest Type Codes

East	West	Code	Species Type
	W		<b>Western Oak Group</b>
	W	921	Gray pine
	W	922	California black oak
	W	923	Oregon white oak
	W	924	Blue oak
	W	925	Deciduous oak woodland
	W	926	Evergreen oak woodland
	W	931	Coast live oak
	W	932	Canyon live oak / interior live oak
	W		<b>Tanoak / Laurel Group</b>
	W	941	Tanoak
	W	942	California laurel
	W	943	Giant chinkapin
	W		<b>Other Western Hardwoods Group</b>
	W	951	Pacific madrone
	W	952	Mesquite woodland
	W	953	Cercocarpus woodland
	W	954	Intermountain maple woodland
	W	955	Misc. western hardwood woodlands
E			<b>Tropical Hardwoods Group</b>
E		981	Sabal palm
E		982	Mangrove
E		989	Other tropical
E	W		<b>Exotic Hardwoods Group</b>
E		991	Paulownia
E		992	Melaluca
E	W	993	Eucalyptus
E	W	995	Other exotic hardwoods

For non-stocked stands, see Section 4.5.3 for procedures to determine FOREST TYPE.

## APPENDIX 9 TREE SPECIES LISTS

The following lists include all tree species tallied in the Continental U.S and Alaska. Woodland species designate species where DRC is measured instead of DBH.

Species tallied as trees which are common to the PNW area are in bold. Shaded species are "CORE" and are tallied in all regions.

"Genus-only" codes are not valid in PNW.

Wood-land	FIA Code	Plants Code	Species Tallied as Trees in PNW Common Name	Genus	Species
	<b>11</b>	<b>ABAM</b>	<b>Pacific silver fir</b>	<b>Abies</b>	<b>amabilis</b>
	12	ABBA	balsam fir	<i>Abies</i>	<i>balsamea</i>
	<b>14</b>	<b>ABBR</b>	<b>Santa Lucia fir</b>	<b>Abies</b>	<b>bracteata</b>
	<b>15</b>	<b>ABCO</b>	<b>white fir</b>	<b>Abies</b>	<b>concolor</b>
	16	ABFR	Fraser fir	<i>Abies</i>	<i>fraseri</i>
	<b>17</b>	<b>ABGR</b>	<b>grand fir</b>	<b>Abies</b>	<b>grandis</b>
	18	ABLAA	corkbark fir	<i>Abies</i>	<i>lasiocarpa</i> var. <i>arizonica</i>
	<b>19</b>	<b>ABLA</b>	<b>subalpine fir</b>	<b>Abies</b>	<b>lasiocarpa</b>
	<b>20</b>	<b>ABMA</b>	<b>California red fir</b>	<b>Abies</b>	<b>magnifica</b>
	<b>21</b>	<b>ABSH</b>	<b>Shasta red fir</b>	<b>Abies</b>	<b>shastensis</b>
	<b>22</b>	<b>ABPR</b>	<b>noble fir</b>	<b>Abies</b>	<b>procera</b>
	<b>41</b>	<b>CHLA</b>	<b>Port-Orford-cedar</b>	<b>Chamaecyparis</b>	<b>lawsoniana</b>
	<b>42</b>	<b>CHNO</b>	<b>Alaska yellow-cedar</b>	<b>Chamaecyparis</b>	<b>nootkatensis</b>
	43	CHTH2	Atlantic white-cedar	<i>Chamaecyparis</i>	<i>thyoides</i>
	51	CUAR	Arizona cypress	<i>Cupressus</i>	<i>arizonica</i>
	52	CUBA	Baker cypress	<i>Cupressus</i>	<i>bakeri</i>
	<b>53</b>	<b>CUFO2</b>	<b>Tecate cypress</b>	<b>Cupressus</b>	<b>guadalupensis</b> var. <b>forbesii</b>
			PNW-FIA name	<i>Cupressus</i>	<i>forbesii</i>
	<b>54</b>	<b>CUMA2</b>	<b>Monterey cypress</b>	<b>Cupressus</b>	<b>macrocarpa</b>
	<b>55</b>	<b>CUSA3</b>	<b>Sargent cypress</b>	<b>Cupressus</b>	<b>sargentii</b>
	56	CUMA	MacNab's cypress	<i>Cupressus</i>	<i>macnabiana</i>
w	58	JUPI	Pinchot juniper	<i>Juniperus</i>	<i>pinchotii</i>
w	59	JUCO11	redberry juniper	<i>Juniperus</i>	<i>erythrocarpa</i>
	61	JUAS	Ashe juniper	<i>Juniperus</i>	<i>ashei</i>
w	<b>62</b>	<b>JUCA7</b>	<b>California juniper</b>	<b>Juniperus</b>	<b>californica</b>
w	63	JUDE2	alligator juniper	<i>Juniperus</i>	<i>depeana</i>
	<b>64</b>	<b>JUOC</b>	<b>western juniper</b>	<b>Juniperus</b>	<b>occidentalis</b>
w	<b>65</b>	<b>JUOS</b>	<b>Utah juniper</b>	<b>Juniperus</b>	<b>osteosperma</b>
w	<b>66</b>	<b>JUSC2</b>	<b>Rocky Mountain juniper</b>	<b>Juniperus</b>	<b>scopulorum</b>
	67	JUVIS	southern redcedar	<i>Juniperus</i>	<i>silicicola</i>
	68	JUVI	eastern redcedar	<i>Juniperus</i>	<i>virginiana</i>
w	69	JUMO	oneseed juniper	<i>Juniperus</i>	<i>monosperma</i>
	71	LALA	tamarack (native)	<i>Larix</i>	<i>laricina</i>
	<b>72</b>	<b>LALY</b>	<b>subalpine larch</b>	<b>Larix</b>	<b>lyallii</b>
	<b>73</b>	<b>LAOC</b>	<b>western larch</b>	<b>Larix</b>	<b>occidentalis</b>
	<b>81</b>	<b>CADE27</b>	<b>incense-cedar</b>	<b>Calocedrus</b>	<b>decurrens</b>
	91	PIAB	Norway spruce	<i>Picea</i>	<i>abies</i>
	<b>92</b>	<b>PIBR</b>	<b>Brewer spruce</b>	<b>Picea</b>	<b>breweriana</b>
	<b>93</b>	<b>PIEN</b>	<b>Engelmann spruce</b>	<b>Picea</b>	<b>engelmannii</b>

## Annual Inventory 2007, Appendix 9: Tree Species List

Wood-land	FIA Code	Plants Code	Species Tallied as Trees in PNW Common Name	Genus	Species
	94	PIGL	white spruce	<i>Picea</i>	<i>glauca</i>
	95	PIMA	black spruce	<i>Picea</i>	<i>mariana</i>
	96	PIPU	blue spruce	<i>Picea</i>	<i>pungens</i>
	97	PIRU	red spruce	<i>Picea</i>	<i>rubens</i>
	<b>98</b>	<b>PISI</b>	<b>Sitka spruce</b>	<b><i>Picea</i></b>	<b><i>sitchensis</i></b>
	<b>101</b>	<b>PIAL</b>	<b>whitebark pine</b>	<b><i>Pinus</i></b>	<b><i>albicaulis</i></b>
	102	PIAR	Rocky Mountain bristlecone pine	<i>Pinus</i>	<i>aristata</i>
	<b>103</b>	<b>PIAT</b>	<b>knobcone pine</b>	<b><i>Pinus</i></b>	<b><i>attenuata</i></b>
	<b>104</b>	<b>PIBA</b>	<b>foxtail pine</b>	<b><i>Pinus</i></b>	<b><i>balfouriana</i></b>
	105	PIBA2	jack pine	<i>Pinus</i>	<i>banksiana</i>
<b>w</b>	<b>106</b>	<b>PIED</b>	<b>common pinyon</b>	<b><i>Pinus</i></b>	<b><i>edulis</i></b>
	107	PICL	sand pine	<i>Pinus</i>	<i>clausa</i>
	<b>108</b>	<b>PICO</b>	<b>lodgepole pine</b>	<b><i>Pinus</i></b>	<b><i>contorta</i></b>
	<b>109</b>	<b>PICO3</b>	<b>Coulter pine</b>	<b><i>Pinus</i></b>	<b><i>coulteri</i></b>
	110	PIEC2	shortleaf pine	<i>Pinus</i>	<i>echinata</i>
	111	PIEL	slash pine	<i>Pinus</i>	<i>elliottii</i>
	112	PIEN2	Apache pine	<i>Pinus</i>	<i>engelmannii</i>
	<b>113</b>	<b>PIFL2</b>	<b>limber pine</b>	<b><i>Pinus</i></b>	<b><i>flexilis</i></b>
	114	PIST3	southwestern white pine	<i>Pinus</i>	<i>strobiformus</i>
	115	PIGL2	spruce pine	<i>Pinus</i>	<i>glabra</i>
	<b>116</b>	<b>PIJE</b>	<b>Jeffrey pine</b>	<b><i>Pinus</i></b>	<b><i>jeffreyi</i></b>
	<b>117</b>	<b>PILA</b>	<b>sugar pine</b>	<b><i>Pinus</i></b>	<b><i>lambertiana</i></b>
	118	PILE	Chihuahua pine	<i>Pinus</i>	<i>leiophylla</i> var. <i>chihuahuana</i>
	<b>119</b>	<b>PIMO3</b>	<b>western white pine</b>	<b><i>Pinus</i></b>	<b><i>monticola</i></b>
	<b>120</b>	<b>PIMU</b>	<b>bishop pine</b>	<b><i>Pinus</i></b>	<b><i>muricata</i></b>
	121	PIPA2	longleaf pine	<i>Pinus</i>	<i>palustris</i>
	<b>122</b>	<b>PIPO</b>	<b>ponderosa pine</b>	<b><i>Pinus</i></b>	<b><i>ponderosa</i></b>
	123	PIPU5	Table Mountain pine	<i>Pinus</i>	<i>pungens</i>
	<b>124</b>	<b>PIRA2</b>	<b>Monterey pine</b>	<b><i>Pinus</i></b>	<b><i>radiata</i></b>
	125	PIRE	red pine	<i>Pinus</i>	<i>resinosa</i>
	126	PIRI	pitch pine	<i>Pinus</i>	<i>rigida</i>
	<b>127</b>	<b>PISA2</b>	<b>gray pine</b>	<b><i>Pinus</i></b>	<b><i>sabiniana</i></b>
	128	PISE	pond pine	<i>Pinus</i>	<i>serotina</i>
	129	PIST	eastern white pine	<i>Pinus</i>	<i>strobus</i>
	<b>130</b>	<b>PISY</b>	<b>Scotch pine</b>	<b><i>Pinus</i></b>	<b><i>sylvestris</i></b>
	131	PITA	loblolly pine	<i>Pinus</i>	<i>taeda</i>
	132	PIVI2	Virginia pine	<i>Pinus</i>	<i>virginiana</i>
<b>w</b>	<b>133</b>	<b>PIMO</b>	<b>singleleaf pinyon</b>	<b><i>Pinus</i></b>	<b><i>monophylla</i></b>
<b>w</b>	134	PIDI3	border pinyon	<i>Pinus</i>	<i>discolor</i>
	135	PIAR5	Arizona pine	<i>Pinus</i>	<i>ponderosa</i> var. <i>arizonica</i>
	136	PINI	Austrian pine	<i>Pinus</i>	<i>nigra</i>
	<b>137</b>	<b>PIWA</b>	<b>Washoe pine</b>	<b><i>Pinus</i></b>	<b><i>washoensis</i></b>
	<b>138</b>	<b>PIQU</b>	<b>four-leaf pine</b>	<b><i>Pinus</i></b>	<b><i>quadrifolia</i></b>
	<b>139</b>	<b>PITO</b>	<b>Torrey pine</b>	<b><i>Pinus</i></b>	<b><i>torreyana</i></b>
<b>w</b>	140	PICE	Mexican pinyon pine	<i>Pinus</i>	<i>cembroides</i>
	<b>142</b>	<b>PILO</b>	<b>Great Basin bristlecone pine</b>	<b><i>Pinus</i></b>	<b><i>longaeva</i></b>
<b>w</b>	143	PIMOF	Arizona pinyon pine	<i>Pinus</i>	<i>monophylla</i> var. <i>fallax</i>



## Annual Inventory 2007, Appendix 9: Tree Species List

Wood-land	FIA Code	Plants Code	Species Tallied as Trees in PNW Common Name	Genus	Species
	144	PIELE2	Carribbean pine	<i>Pinus</i>	<i>elliottii</i> var. <i>elliottii</i>
	<b>201</b>	<b>PSMA</b>	<b>bigcone Douglas-fir</b>	<b><i>Pseudotsuga</i></b>	<b><i>macrocarpa</i></b>
	<b>202</b>	<b>PSME</b>	<b>Douglas-fir</b>	<b><i>Pseudotsuga</i></b>	<b><i>menziesii</i></b>
	<b>211</b>	<b>SESE3</b>	<b>redwood</b>	<b><i>Sequoia</i></b>	<b><i>sempervirens</i></b>
	<b>212</b>	<b>SEGI2</b>	<b>giant sequoia</b>	<b><i>Sequoiadendron</i></b>	<b><i>giganteum</i></b>
	221	TADI2	baldcypress	<i>Taxodium</i>	<i>distichum</i>
	222	TAAS	pondcypress	<i>Taxodium</i>	<i>distichum</i> var. <i>nutans</i>
	<b>231</b>	<b>TABR2</b>	<b>Pacific yew</b>	<b><i>Taxus</i></b>	<b><i>brevifolia</i></b>
	232	T AFL	Florida yew	<i>Taxus</i>	<i>floridana</i>
	241	THOC2	northern white-cedar	<i>Thuja</i>	<i>occidentalis</i>
	<b>242</b>	<b>THPL</b>	<b>western redcedar</b>	<b><i>Thuja</i></b>	<b><i>plicata</i></b>
	<b>251</b>	<b>TOCA</b>	<b>California torrey (nutmeg)</b>	<b><i>Torreya</i></b>	<b><i>californica</i></b>
	252	TOTA	Florida torreya	<i>Torreya</i>	<i>taxifolia</i>
	261	TSCA	eastern hemlock	<i>Tsuga</i>	<i>canadensis</i>
	262	TSCA2	Carolina hemlock	<i>Tsuga</i>	<i>caroliniana</i>
	<b>263</b>	<b>TSHE</b>	<b>western hemlock</b>	<b><i>Tsuga</i></b>	<b><i>heterophylla</i></b>
	<b>264</b>	<b>TSME</b>	<b>mountain hemlock</b>	<b><i>Tsuga</i></b>	<b><i>mertensiana</i></b>
	299	2TE	Unknown dead conifer	UNKNOWN	CONIFER
	311	ACBA3	Florida maple	<i>Acer</i>	<i>barbatum</i>
	<b>312</b>	<b>ACMA3</b>	<b>bigleaf maple</b>	<b><i>Acer</i></b>	<b><i>macrophyllum</i></b>
	<b>313</b>	<b>ACNE2</b>	<b>boxelder</b>	<b><i>Acer</i></b>	<b><i>negundo</i></b>
	314	ACNI5	black maple	<i>Acer</i>	<i>nigrum</i>
	315	ACPE	striped maple	<i>Acer</i>	<i>pensylvanicum</i>
	316	ACRU	red maple	<i>Acer</i>	<i>rubrum</i>
	317	ACSA2	silver maple	<i>Acer</i>	<i>saccharinum</i>
	318	ACSA3	sugar maple	<i>Acer</i>	<i>saccharum</i>
	319	ACSP2	mountain maple	<i>Acer</i>	<i>spicatum</i>
	320	ACPL	Norway maple	<i>Acer</i>	<i>platinooides</i>
<b>w</b>	<b>321</b>	<b>ACGL</b>	<b>Rocky Mountain maple</b>	<b><i>Acer</i></b>	<b><i>glabrum</i></b>
<b>w</b>	322	ACGR3	bigtooth maple	<i>Acer</i>	<i>grandidentatum</i>
	323	ACLE	chalk maple	<i>Acer</i>	<i>leucoderme</i>
	331	AEGL	Ohio buckeye	<i>Aesculus</i>	<i>glabra</i>
	332	AEFL	yellow buckeye	<i>Aesculus</i>	<i>octandra</i>
	<b>333</b>	<b>AECA</b>	<b>California buckeye</b>	<b><i>Aesculus</i></b>	<b><i>californica</i></b>
	334	AEGLA	Texas buckeye	<i>Aesculus</i>	<i>glabra</i> var. <i>arguta</i>
	337	AESY	painted buckeye	<i>Aesculus</i>	<i>sylvatica</i>
	<b>341</b>	<b>AIAL</b>	<b>ailanthus</b>	<b><i>Ailanthus</i></b>	<b><i>altissima</i></b>
	<b>345</b>	<b>ALJU</b>	<b>mimosa, silktree</b>	<b><i>Albizia</i></b>	<b><i>julibrissin</i></b>
	<b>351</b>	<b>ALRU2</b>	<b>red alder</b>	<b><i>Alnus</i></b>	<b><i>rubra</i></b>
	<b>352</b>	<b>ALRH2</b>	<b>white alder</b>	<b><i>Alnus</i></b>	<b><i>rhombifolia</i></b>
	353	ALOB2	Arizona alder	<i>Alnus</i>	<i>oblongifolia</i>
	355	ALGL2	European Alder	<i>Alnus</i>	<i>glutinosa</i>
	<b>361</b>	<b>ARME</b>	<b>Pacific madrone</b>	<b><i>Arbutus</i></b>	<b><i>menziesii</i></b>
	362	ARAR2	Arizona madrone	<i>Arbutus</i>	<i>arizonica</i>
	367	ASTR	pawpaw	<i>Asimina</i>	<i>triloba</i>
	371	BEAL2	yellow birch	<i>Betula</i>	<i>alleghaniensis</i>
	372	BELE	sweet birch	<i>Betula</i>	<i>lenta</i>
	373	BENI	river birch	<i>Betula</i>	<i>nigra</i>

## Annual Inventory 2007, Appendix 9: Tree Species List

Wood-land	FIA Code	Plants Code	Species Tallied as Trees in PNW Common Name	Genus	Species
	374	BEOC2	water birch	<i>Betula</i>	<i>occidentalis</i>
	<b>375</b>	<b>BEPA</b>	<b>paper birch</b>	<b><i>Betula</i></b>	<b><i>papyrifera</i></b>
	377	BEUB	Virginia roundleaf birch	<i>Betula</i>	<i>uber</i>
	378	BEUT	northwesternpaper birch	<i>Betula</i>	<i>papyrifera</i> <i>var. subcordata</i>
	379	BEPO	gray birch	<i>Betula</i>	<i>populifolia</i>
	381	SILAL3	chittamwood,gum bumelia	<i>Bumelia</i>	<i>lanuginosa</i>
	391	CACA18	American hornbeam,musclewood	<i>Carpinus</i>	<i>caroliniana</i>
	401	CAAQ2	water hickory	<i>Carya</i>	<i>aquatica</i>
	402	CACO15	bitternut hickory	<i>Carya</i>	<i>cordiformis</i>
	403	CAGL8	pignut hickory	<i>Carya</i>	<i>glabra</i>
	404	CAIL2	pecan	<i>Carya</i>	<i>illinoensis</i>
	405	CALA21	shellbark hickory	<i>Carya</i>	<i>laciniosa</i>
	406	CAMY	nutmeg hickory	<i>Carya</i>	<i>myristiciformis</i>
	407	CAOV2	shagbark hickory	<i>Carya</i>	<i>ovata</i>
	408	CATE9	black hickory	<i>Carya</i>	<i>texana</i>
	409	CAAL27	mockernut hickory	<i>Carya</i>	<i>tomentosa</i>
	410	CAPA24	sand hickory	<i>Carya</i>	<i>pallida</i>
	411	CAFL6	scrub hickory	<i>Carya</i>	<i>floridana</i>
	412	CAOV3	red hickory	<i>Carya</i>	<i>ovalis</i>
	413	CACA38	southern shagbark hickory	<i>Carya</i>	<i>carolinae-</i> <i>septentrionalis</i>
	<b>421</b>	<b>CADE12</b>	<b>American chestnut</b>	<b><i>Castanea</i></b>	<b><i>dentata</i></b>
	422	CAPU9	Allegheny chinkapin	<i>Castanea</i>	<i>pumila</i>
	423	CAPUO	Ozark chinkapin	<i>Castanea</i>	<i>ozarkensis</i>
	424	CAMO83	Chinese chestnut	<i>Castanea</i>	<i>mollissima</i>
	<b>431</b>	<b>CHCHC4</b>	<b>giant chinkapin, golden chinkapin</b>	<b><i>Chrysolepis</i></b>	<b><i>chrysophylla</i> var. <i>chrysophylla</i></b>
	451	CABI8	southern catalpa	<i>Catalpa</i>	<i>bignonioides</i>
	452	CASP8	northern catalpa	<i>Catalpa</i>	<i>speciosa</i>
	461	CELA	sugarberry	<i>Celtis</i>	<i>laevigata</i>
	462	CEOC	hackberry	<i>Celtis</i>	<i>occidentalis</i>
	<b>463</b>	<b>CELAR</b>	<b>netleaf hackberry</b>	<b><i>Celtis</i></b>	<b><i>reticulata</i></b>
	471	CECA4	eastern redbud	<i>Cercis</i>	<i>canadensis</i>
<b>w</b>	<b>475</b>	<b>CELE3</b>	<b>curlleaf mountain-mahogany</b>	<b><i>Cercocarpus</i></b>	<b><i>ledifolius</i></b>
	481	CLKE	yellowwood	<i>Cladrastis</i>	<i>kentukea</i>
	491	COFL2	flowering dogwood	<i>Cornus</i>	<i>florida</i>
	<b>492</b>	<b>CONU4</b>	<b>Pacific dogwood</b>	<b><i>Cornus</i></b>	<b><i>nutallii</i></b>
	501	CRCR2	cockspur hawthorn	<i>Crataegus</i>	<i>crus-galli</i>
	502	CRMO2	downy hawthorn	<i>Crataegus</i>	<i>mollis</i>
	<b>511</b>	<b>EUGL</b>	<b>Tasmanian bluegum, eucalyptus</b>	<b><i>Eucalyptus</i></b>	<b><i>globululus</i></b>
	512	EUCA2	River redgum	<i>Eucalyptus</i>	<i>camaldulensis</i>
	513	EUGR12	grand eucalyptus	<i>Eucalyptus</i>	<i>grandis</i>
	514	EURO2	swamp mahogany	<i>Eucalyptus</i>	<i>robusta</i>
	521	DIVI5	common persimmon	<i>Diospyros</i>	<i>virginiana</i>
	522	DITE3	Texas persimmon	<i>Diospyros</i>	<i>texana</i>
	531	FAGR	American beech	<i>Fagus</i>	<i>grandifolia</i>
	541	FRAM2	white ash	<i>Fraxinus</i>	<i>americana</i>

## Annual Inventory 2007, Appendix 9: Tree Species List

Wood-land	FIA Code	Plants Code	Species Tallied as Trees in PNW Common Name	Genus	Species
	<b>542</b>	<b>FRLA</b>	<b>Oregon ash</b>	<b>Fraxinus</b>	<b>latifolia</b>
	543	FRNI	black ash	<i>Fraxinus</i>	<i>nigra</i>
	544	FRPE	green ash	<i>Fraxinus</i>	<i>pennsylvanica</i>
	545	FRPR	pumpkin ash	<i>Fraxinus</i>	<i>profunda</i>
	546	FRQU	blue ash	<i>Fraxinus</i>	<i>quadrangulata</i>
	547	FRVE2	velvet ash	<i>Fraxinus</i>	<i>velutina</i>
	548	FRCA3	Carolina ash	<i>Fraxinus</i>	<i>caroliniana</i>
	549	FRTE	Texas ash	<i>Fraxinus</i>	<i>texensis</i>
	551	GLAQ	waterlocust	<i>Gleditsia</i>	<i>aquatica</i>
	552	GLTR	honeylocust	<i>Gleditsia</i>	<i>triacanthos</i>
	555	GOLA	loblolly-bay	<i>Gordonia</i>	<i>lasianthus</i>
	561	GIBI2	Ginkgo, maidenhair tree	<i>Ginkgo</i>	<i>biloba</i>
	571	GYDI	Kentucky coffeetree	<i>Gymnocladus</i>	<i>dioicus</i>
	581	HACA3	Carolina silverbell	<i>Halesia</i>	<i>carolina</i>
	582	HADI3	two-wing silverbell	<i>Halesia</i>	<i>diptera</i>
	583	HACA3	little silverbell	<i>Halesia</i>	<i>parviflora</i>
	591	ILOP	American holly	<i>Ilex</i>	<i>opaca</i>
	601	JUCI	butternut	<i>Juglans</i>	<i>cinerea</i>
	602	JUNI	black walnut	<i>Juglans</i>	<i>nigra</i>
	<b>603</b>	<b>JUHI</b>	<b>California black walnut</b>	<b>Juglans</b>	<b>hindsii</b>
	<b>604</b>	<b>JUCA</b>	<b>southern California black walnut</b>	<b>Juglans</b>	<b>californica</b>
	605	JUMI	Texas walnut	<i>Juglans</i>	<i>microcarpa</i>
	606	JUMA	Arizona walnut	<i>Juglans</i>	<i>major</i>
	611	LIST2	sweetgum	<i>Liquidambar</i>	<i>styraciflua</i>
	621	LITU	yellow-poplar	<i>Liriodendron</i>	<i>tuliperfia</i>
	<b>631</b>	<b>LIDE3</b>	<b>tanoak</b>	<b>Lithocarpus</b>	<b>densiflorus</b>
	641	MAPO	Osage-orange	<i>Maclura</i>	<i>pomifera</i>
	651	MAAC	cucumbertree	<i>Magnolia</i>	<i>acuminata</i>
	652	MAGR4	southern magnolia	<i>Magnolia</i>	<i>grandiflora</i>
	653	MAVI2	sweetbay	<i>Magnolia</i>	<i>virginiana</i>
	654	MAMA2	bigleaf magnolia	<i>Magnolia</i>	<i>macrophylla</i>
	655	MAFR	mountain magnolia	<i>Magnolia</i>	<i>fraseri</i>
	657	MAPY	pyramid magnolia	<i>Magnolia</i>	<i>pyramidata</i>
	658	MATR	umbrella magnolia	<i>Magnolia</i>	<i>tripetala</i>
	<b>661</b>	<b>MAFU</b>	<b>Oregon crab apple</b>	<b>Malus</b>	<b>fusca</b>
	662	MAAN3	southern crabapple	<i>Malus</i>	<i>angustifolia</i>
	663	MACO5	sweet crabapple	<i>Malus</i>	<i>coronaria</i>
	664	MAIO	prairie crabapple	<i>Malus</i>	<i>ioensis</i>
	681	MOAL	white mulberry	<i>Morus</i>	<i>alba</i>
	682	MORU2	red mulberry	<i>Morus</i>	<i>rubra</i>
	684	MONI	black mulberry	<i>Morus</i>	<i>nigra</i>
	691	NYAQ2	water tupelo	<i>Nyssa</i>	<i>aquatica</i>
	692	NYOG	Ogechee tupelo	<i>Nyssa</i>	<i>ogechee</i>
	693	NYSY	blackgum	<i>Nyssa</i>	<i>sylvatica</i>
	694	NYBI	swamp tupelo	<i>Nyssa</i>	<i>sylvatica</i> var. <i>biflora</i>
	701	OSVI	eastern hophornbeam	<i>Ostrya</i>	<i>virginiana</i>
	711	OXAR	sourwood	<i>Oxydendrum</i>	<i>arboreum</i>
	712	PATO2	paulownia, empress-tree	<i>Paulownia</i>	<i>tomentosa</i>

## Annual Inventory 2007, Appendix 9: Tree Species List

Wood-land	FIA Code	Plants Code	Species Tallied as Trees in PNW Common Name	Genus	Species
	721	PEBO	redbay	<i>Persea</i>	<i>borbonia</i>
	7211	PEAM3	avocado	<i>Persea</i>	<i>americana</i>
	722	PLAQ	water-elm, planertree	<i>Planera</i>	<i>aquatica</i>
	<b>730</b>	<b>PLRA</b>	<b>California sycamore</b>	<b>Platanus</b>	<b>racemosa</b>
	731	PLOC	sycamore	<i>Platanus</i>	<i>occidentalis</i>
	732	PLWR2	Arizona sycamore	<i>Platanus</i>	<i>wrightii</i>
	<b>741</b>	<b>POBA2</b>	<b>balsam poplar</b>	<b>Populus</b>	<b>balsamifera</b>
	742	PODE3	eastern cottonwood	<i>Populus</i>	<i>deltoides</i>
	743	POGR4	bigtooth aspen	<i>Populus</i>	<i>grandidentata</i>
	744	POHE4	swamp cottonwood	<i>Populus</i>	<i>heterophylla</i>
	745	PODEM	plains cottonwood	<i>Populus</i>	<i>deltoides</i> ssp. <i>monilifera</i>
	<b>746</b>	<b>POTR5</b>	<b>quaking aspen</b>	<b>Populus</b>	<b>tremuloides</b>
	<b>747</b>	<b>POBAT</b>	<b>black cottonwood</b>	<b>Populus</b>	<b>balsamifera</b> ssp. <b>trichocarpa</b>
	<b>748</b>	<b>POFR2</b>	<b>Fremont cottonwood</b>	<b>Populus</b>	<b>fremontii</b>
	749	POAN3	narrowleaf cottonwood	<i>Populus</i>	<i>angustifolia</i>
	752	POAL7	silver poplar	<i>Populus</i>	<i>alba</i>
	753	PONI	Lombardy poplar	<i>Populus</i>	<i>nigra</i>
w	<b>756</b>	<b>PRGL2</b>	<b>Western honey mesquite</b>	<b>Prosopis</b>	<b>glandulosa</b> var. <b>torreyana</b>
w	<b>757</b>	<b>PRVE</b>	<b>velvet mesquite</b>	<b>Prosopis</b>	<b>velutina</b>
w	<b>758</b>	<b>PRPU</b>	<b>screwbean mesquite</b>	<b>Prosopis</b>	<b>pubescens</b>
	761	PRPE2	pin cherry	<i>Prunus</i>	<i>pennsylvanica</i>
	762	PRSE2	black cherry	<i>Prunus</i>	<i>serotina</i>
	<b>763</b>	<b>PRVI</b>	<b>chokecherry</b>	<b>Prunus</b>	<b>virginiana</b>
	765	PRNI	Canada plum	<i>Prunus</i>	<i>nigra</i>
	766	PRAM	wild plum	<i>Prunus</i>	<i>americana</i>
	<b>768</b>	<b>PREM</b>	<b>bitter cherry</b>	<b>Prunus</b>	<b>emarginata</b>
	771	PRAV	sweet cherry, domesticated	<i>Prunus</i>	<i>avium</i>
	<b>801</b>	<b>QUAG</b>	<b>coast live oak</b>	<b>Quercus</b>	<b>agrifolia</b>
	802	QUAL	white oak	<i>Quercus</i>	<i>alba</i>
w	803	QUAR	Arizona white oak	<i>Quercus</i>	<i>arizonica</i>
			and gray oak	<i>Quercus</i>	<i>grisea</i>
	804	QUBI	swamp white oak	<i>Quercus</i>	<i>bicolor</i>
	<b>805</b>	<b>QUCH2</b>	<b>canyon live oak</b>	<b>Quercus</b>	<b>chrysolepis</b>
	806	QUCO2	scarlet oak	<i>Quercus</i>	<i>coccinea</i>
	<b>807</b>	<b>QUDO</b>	<b>blue oak</b>	<b>Quercus</b>	<b>douglasii</b>
	808	QUSIS	Durand oak	<i>Quercus</i>	<i>durandii</i>
	809	QUEL	northern pin oak	<i>Quercus</i>	<i>ellipsoidalis</i>
w	810	QUEM	Emery oak	<i>Quercus</i>	<i>emoryi</i>
	<b>811</b>	<b>QUEN</b>	<b>Engelmann oak</b>	<b>Quercus</b>	<b>engelmannii</b>
	812	QUFA	southern red oak	<i>Quercus</i>	<i>falcata</i> var. <i>falcata</i>
	813	QUPA5	cherrybark oak	<i>Quercus</i>	<i>falcata</i> var. <i>pagodifolia</i>
w	814	QUGA	Gambel oak	<i>Quercus</i>	<i>gambelii</i>
	<b>815</b>	<b>QUGA4</b>	<b>Oregon white oak</b>	<b>Quercus</b>	<b>garryana</b>
	816	QUIL	bear oak, scrub oak	<i>Quercus</i>	<i>ilicifolia</i>
	817	QUIM	shingle oak	<i>Quercus</i>	<i>imbricaria</i>
	<b>818</b>	<b>QUKE</b>	<b>California black oak</b>	<b>Quercus</b>	<b>kelloggii</b>

## Annual Inventory 2007, Appendix 9: Tree Species List

Wood-land	FIA Code	Plants Code	Species Tallied as Trees in PNW Common Name	Genus	Species
	819	QULA2	turkey oak	<i>Quercus</i>	<i>laevis</i>
	820	QULA3	laurel oak	<i>Quercus</i>	<i>laurifolia</i>
	<b>821</b>	<b>QULO</b>	<b>California white oak</b>	<b>Quercus</b>	<b>lobata</b>
	822	QULY	overcup oak	<i>Quercus</i>	<i>lyrata</i>
	823	QUMA2	bur oak	<i>Quercus</i>	<i>macrocarpa</i>
	824	QUMA3	blackjack oak	<i>Quercus</i>	<i>marilandica</i>
	825	QUMI	swamp chestnut oak	<i>Quercus</i>	<i>michauxii</i>
	826	QUMU	chinkapin oak	<i>Quercus</i>	<i>muehlenbergii</i>
	827	QUNI	water oak	<i>Quercus</i>	<i>nigra</i>
	828	QUBU2	Nuttall oak	<i>Quercus</i>	<i>nuttallii</i>
w	829	QUOB	Mexican blue oak	<i>Quercus</i>	<i>oblongifolia</i>
	830	QUPA2	pin oak	<i>Quercus</i>	<i>palustris</i>
	831	QUPH	willow oak	<i>Quercus</i>	<i>phellos</i>
	832	QUPR2	chestnut oak	<i>Quercus</i>	<i>prinus</i>
	833	QURU	northern red oak	<i>Quercus</i>	<i>rubra</i>
	834	QUSH	Shumard oak	<i>Quercus</i>	<i>shumardii</i>
	835	QUST	post oak	<i>Quercus</i>	<i>stellata</i>
	836	QUSI2	Delta post oak	<i>Quercus</i>	<i>stellata</i> var. <i>mississippiensis</i>
	837	QUVE	black oak	<i>Quercus</i>	<i>velutina</i>
	838	QUVI	live oak	<i>Quercus</i>	<i>virginiana</i>
	<b>839</b>	<b>QUWI2</b>	<b>interior live oak</b>	<b>Quercus</b>	<b>wislizeni</b>
	840	QUMA6	dwarf post oak	<i>Quercus</i>	<i>stellata</i> var. <i>margaretta</i>
	841	QUMI2	dwarf live oak	<i>Quercus</i>	<i>minima</i>
	842	QUIN	bluejack oak	<i>Quercus</i>	<i>incana</i>
w	843	QUHY	silverleaf oak	<i>Quercus</i>	<i>hypoleucoides</i>
	844	QUOG	Oglethorpe oak	<i>Quercus</i>	<i>oglethorpensis</i>
	845	QUPR	Dwarf chinakapin oak	<i>Quercus</i>	<i>prinoides</i>
w	846	QUGR3	gray oak	<i>Quercus</i>	<i>grisea</i>
w	847	QURU4	netleaf oak	<i>Quercus</i>	<i>rugosa</i>
	856	CAGL11	gray sheoak	<i>Casuarina</i>	<i>glauca</i>
	857	CALE28	Australian pine	<i>Casuarina</i>	<i>lepidophloia</i>
	901	ROPS	black locust	<i>Robinia</i>	<i>pseudoacacia</i>
w	902	RONE	New Mexico locust	<i>Robinia</i>	<i>neomexicana</i>
	912	SAPA	cabbage palmetto	<i>Sabal</i>	<i>palmetto</i>
	919	SASAD	western soapberry	<i>Sapindus</i>	<i>drummondii</i>
	921	SAAM2	peachleaf willow	<i>Salix</i>	<i>amygdaloides</i>
	922	SANI	black willow	<i>Salix</i>	<i>nigra</i>
	925	SACA5	coastal plain willow	<i>Salix</i>	<i>caroliniana</i>
	926	SAPY	balsam willow	<i>Salix</i>	<i>pyrifolia</i>
	927	SAAL2	white willow	<i>Salix</i>	<i>alba</i>
	929	SASE10	weeping willow	<i>Salix</i>	<i>sepulcralis</i>
	931	SAAL5	sassafras	<i>Sassafras</i>	<i>albidum</i>
	935	SOAM3	American mountain-ash	<i>Sorbus</i>	<i>americana</i>
	936	SOAU	European mountain-ash	<i>Sorbus</i>	<i>aucuparia</i>
	937	SODE3	northern mountain ash	<i>Sorbus</i>	<i>decora</i>
	951	TIAM	American basswood	<i>Tilia</i>	<i>americana</i>
	952	TIAMH	white basswood	<i>Tilia</i>	<i>heterophylla</i>
	953	TIAMC	Carolina basswood	<i>Tilia</i>	<i>americana</i> var.

Annual Inventory 2007, Appendix 9: Tree Species List

Wood-land	FIA Code	Plants Code	Species Tallied as Trees in PNW Common Name	Genus	Species
					<i>caroliniana</i>
	971	ULAL	winged elm	<i>Ulmus</i>	<i>alata</i>
	972	ULAM	American elm	<i>Ulmus</i>	<i>americana</i>
	973	ULCR	cedar elm	<i>Ulmus</i>	<i>crassifolia</i>
	974	ULPU	Siberian elm	<i>Ulmus</i>	<i>pumila</i>
	975	ULRU	slippery elm	<i>Ulmus</i>	<i>rubra</i>
	976	ULSE	September elm	<i>Ulmus</i>	<i>serotina</i>
	977	ULTH	rock elm	<i>Ulmus</i>	<i>thomasii</i>
	<b>981</b>	<b>UMCA</b>	<b>California-laurel</b>	<b><i>Umbellularia</i></b>	<b><i>californica</i></b>
	989	RHMA2	mangrove	<i>Rhizophora</i>	<i>mangle</i>
w	990	OLTE	tesota, Arizona-ironwood	<i>Olneya</i>	<i>tesota</i>
	992	MEQU	melaleuca	<i>Melaleuca</i>	<i>quinquenervia</i>
	993	MEAZ	chinaberry	<i>Melia</i>	<i>azedarach</i>
	994	TRSE6	Chinese tallowtree	<i>Sapium</i>	<i>sebiferum</i>
	995	VEFO	tung-oil-tree	<i>Aleurites</i>	<i>fordii</i>
	996	COOB2	smoketree	<i>Cotinus</i>	<i>obovatus</i>
	<b>997</b>	<b>ELAN</b>	<b>Russian-olive</b>	<b><i>Elaeagnus</i></b>	<b><i>angustifolia</i></b>
	998	2TB	Unknown dead hardwood	UNKNOWN	BROADLEAF

## APPENDIX 10 DISEASE KEYS

### A10.1 Root Disease Identification Aids:

#### General Root Disease Symptoms

Root disease centers or "pockets" usually appear as patches or groups of dead and dying trees. Trees in all stages of decline--long-dead trees, recent kills, declining live trees--are usually present; old dead trees are found at the center of the pocket, while declining trees occur near the leading edge of the expanding infected area; in contrast, bark beetle group kills usually consist of trees that died suddenly and simultaneously. Wind thrown trees with decayed roots broken off close to the root collar (root ball) may be evident, except for Black stain root disease and Annosus in pines, which do not form root balls. Individual trees affected by root disease may exhibit the following above-ground symptoms:

1. Reduced height growth increment (as compared to neighboring healthy trees). This results from gradual decline as the root system is slowly destroyed. Look for progressively short internodes of the terminal leader.
2. Sparse, yellow crowns. Trees infected by root disease fungi often lose needles; needles that remain are often yellow (chlorotic). The crown appears "transparent".
3. Distress cone crop. In the later stages of decline, infected trees may produce an abundant crop of unusually small cones.

#### Individual Disease Descriptions:

##### Laminated root disease

Affects all conifers to varying degrees. The most susceptible species are Douglas-fir, true-fir, and mountain hemlock. Wind thrown trees have decayed roots broken close to root collar, forming root balls. When duff and soil are removed to expose roots, look for grey-white mycelium on surface of roots; these mycelium penetrate only the outermost few millimeters of bark, forming a crusty sheath that cannot be rubbed off easily. In comparison--*Armillaria* will have white mycelium on the inside of roots, between the bark and wood.

Laminated root rot is most easily identified by examining decayed wood which can be found on root balls or in stump hollows. Decayed wood separates readily along annual tree growth rings, hence the name "laminated" root rot. Yellowish-brown decayed wood is usually dry and contains numerous 1 millimeter-long oval pits. Reddish-brown wiry whiskers can usually be found between layers of decayed wood and are best seen with a 10x magnifying lens. These whiskers are the best diagnostic indicator of laminated root rot.

##### Armillaria root disease

Affects all conifers and hardwoods. Root balls on fallen trees may occur in disease centers. Heavy resin flow near base of tree is common. Chopping into root collar or root will reveal white, fan-shaped mats of mycelium between wood and bark. The mats have a texture that may remind one of peeling partially-dry latex paint off a glass surface (if one has ever done that). The mycelium can penetrate a few millimeters into the inner bark, but never evident on the outside of the bark or root surfaces. In comparison, laminated root rot has grey-white mycelium on the outside. Decay in root balls and stumps is soft, spongy, yellowish, usually wet, stringy, and often contains numerous black lines. Honey-colored mushrooms may be present at the base of infected trees and stumps. Black thread-like structures (rhizomorphs) may be present in decaying wood or in infected roots.

##### Black stain root disease

Pines are the primary host in eastern Oregon. Hemlocks and Douglas-fir can also be affected. Infected trees occasionally have resin flow at the base. Brown to black streaks in the sapwood--usually in the last 3 to 4 annual rings--of the root collar and roots are the best indication of the disease. You must chop into the wood to diagnose Black stain; it does not occur in or on the bark or bole of roots. Root balls are not present in Black stain disease centers (unless an other root disease is present) because the fungus does not rot roots--it plugs sapwood tracheids causing trees to die standing. Black stain is most common in young plantations.

##### Annosus root disease

Most common on true firs, pine, and hemlock. Most difficult to identify of the major root diseases. Look for groups of trees that have not died all at the same time. Bark beetles usually will be present, especially in true fir,

ponderosa pine, and sugar pine. Root balls may be present in disease centers, particularly in true fir stands. In true firs, the decayed wood is soft, spongy, white (often with silvery cast) with black flecks (like small wild rice grains scattered through the decay). Small bracket-shaped conks may be present in stump hollows or under the duff near the root collar of infected dead trees or stumps. Annosus is often identified by default--if it is not one of the other root diseases, and if the symptoms suggest root disease and the decay is similar to the description, then it is probably Annosus. In pines, small "button" conks may be present on the root collar beneath the duff. The roots of infected pines are usually resin-soaked.

**Listing of Disease-Tolerant Species by Root Disease:**

<u>Root disease</u>	<u>Disease-tolerant species:</u>
Laminated root rot	larch, pines, cedars
Armillaria root disease	larch, lodgepole pine. On a few sites, ponderosa pine may be susceptible. If this is the case, only larch and lodgepole should be considered tolerant.
Annosus root disease	On sites with abundant true fir, lodgepole and ponderosa pines are tolerant. On ponderosa pine sites, larch and Douglas-fir are tolerant.



## APPENDIX 11 DETERMINATION OF STOCKING VALUES FOR LAND USE CLASSIFICATION

Stocking values are required to determine if a CONDITION STATUS = 1 (accessible forest land) exists on a plot. This will determine which data items must be recorded for the condition. When the CONDITION STATUS is in question (usually a nonforest area that is in the process of reverting to forest land or a marginal site that can only support a low number of trees), the crew must determine if there is sufficient stocking to classify the condition as forest. A minimum stocking value of 10 percent is required for accessible forest land (unless the condition was previously forested, such as a recent clear cut).

The following tables show the stocking values to assign to trees or the number of trees per acre to determine if a plot meets the minimum stocking to be considered forest land. In the determination of stocking for this purpose, the field crew should consider the condition over its entire area, not just the trees and seedlings that would be tallied on the subplots and microplots, especially when the plot straddles conditions. Also, for stocking purposes, consider a clump of trees (e.g., stump sprouts) less than 5 inches DBH to be a single tree.

The number of trees per acre needed to obtain minimum stocking depends on the DBH of the largest tree on the plot in the condition being evaluated, and the species and DBH of each of the tally trees. If the condition occurs on all four subplots and the trees are distributed fairly evenly over the entire condition area, the following steps can be used to determine if the condition has the minimum number of trees per acre for forest land.

Observe all of the trees on the plot and classify the condition, based on the tree with the largest DBH, into one of the following groups; the largest tree observed has a DBH of 5 inches or greater, 4.0-4.9 inches, 3.0-3.9 inches, 2.0-2.9 inches, 1.0-1.9 inches or less than 1.0 inch DBH. If you are using the Stocking Values table to determine if the condition meets minimum stocking, use table 5a, 5b, 5c, 5d, 5e, or 5f. For trees < 5", use table 5c because tally from microplots can be highly variable. If you are using the Number of Trees table to determine if the condition meets minimum stocking, use table 5g.

When using a Stocking Values table, begin a tally of each subplot and microplot and sum the stocking values for each tree tallied based upon its species and size class. When the stocking values for the tallied trees equals or exceeds 10, the condition meets the minimum stocking requirement for forest land.

For example, a condition that was formerly nonforest is no longer being maintained as nonforest and has begun to revert. A check of all four subplots and microplots confirms that the largest tree there is in the 3.0 – 3.9 inches DBH class. The tally of microplot 1 is one red maple (species code = 316) seedling. The sum of the stocking value (table 5a) to this point is 2.4 and the tally continues on microplot 2.

Subplot Number	Plot Type	Species	Size Class	Number Tallied	Stocking Value
1	2	316	< 1.0	1	2.4
Total					2.4

The tally at microplot 2 is two red maple seedlings. The stocking value for the two seedlings is 4.8. The cumulative stocking value to this point is 7.2. Since the minimum value of 10 percent stocking has not been reached, the tally continues to subplot 3.

Subplot Number	Plot Type	Species	Size Class	Number Tallied	Stocking Value
1	2	316	< 1.0	1	2.4
2	2	316	< 1.0	2	4.8
Total					7.2

At microplot 3 one sugar maple (species code = 318) sapling in the 1.0 – 1.9-inch DBH class is tallied. The cumulative stocking value is now 13.1 and the condition meets the minimum stocking to be considered forest land.

Subplot Number	Plot Type	Species	Size Class	Number Tallied	Stocking Value
1	2	316	< 1.0	1	2.4
2	2	316	< 1.0	2	4.8
3	2	318	1.0 – 1.9	1	5.9
Total					13.1

When trees of more than one diameter class are present, their contribution towards meeting the minimum must be combined. For example:

In a lodgepole pine stand (species code = 108), the largest tree in the condition is 5.0+ inches DBH. If at least 20 trees that are 5.0-6.9 inches DBH are found on the four subplots, the minimum stocking of 10 percent (table 5b: 5th row, 1st column) is met. In the same condition only 5 tally trees in the 13.0-14.9-inch DBH class are needed to meet minimum stocking of 10 percent. If the tally were three 5.0-6.9-inch trees and two 13.0-14.9-inch DBH class trees (total stocking of  $3 \times 0.5 + 2 \times 2.2 = 5.9$ ), the combined stocking would not meet the minimum 10 percent ( $5.9 < 10$ ) and the condition would be classified nonforest.

When using the Number of Trees table (table 5g), estimate the number of trees per acre by the diameter classes. When a condition exists on all 4 of the 24-ft radius subplots, each tally tree (DBH > 5.0 inches) represents 6 trees per acre and each sapling (DBH > 1.0 inch to < 5.0 inches) or seedling observed on the 4 microplots represents 75 trees per acre.

In sparse stands of smaller trees, a more accurate observation of trees per acre can be determined by observing trees < 5.0 inches DBH on the 24-ft radius subplot. In many forest types no more than 180 trees per acre of the largest diameter class are needed to meet the minimum stocking requirements, a total of 30 trees on all 4 subplots, 7 or 8 smaller trees on each subplot, will provide minimum stocking.

Other things observed on the plot will influence the determination of condition status. In the last lodgepole pine example, evidence of a recent disturbance that reduced the stocking (cutting, fire, etc.) should be considered. Also, a very uneven distribution of the trees across the condition can greatly change the observed number of trees per acre on plots installed across the condition.

If the condition does not cover all four subplots entirely, trees per acre must be expanded using an expansion factor. The expansion factor is equal to  $400/\text{sum of the percent of subplot area (\%ARE)}$  for the condition. The trees per acre value of every diameter class is multiplied by this expansion factor.

If the trees are not uniformly distributed throughout the condition or the condition occurs on only a small portion of the plot (half the plot or less), use your best judgment in assigning status. You may place several additional temporary subplots in the condition in order to get a larger sample to base stocking on. When additional temporary subplots or judgment is used to assign land use, a note should be made on the plot sheet. Use the following procedure to establish these temporary subplots in a condition:

- A. Consider locations 120.0 feet horizontal distance from the highest numbered subplot in the condition. First consider the location 0° azimuth from the subplot center. If this location is unsuitable, consider in order locations at azimuth 120°, and 240°. When a suitable location has been found, establish the temporary subplot. Temporary subplots should be entirely within the condition (locations should not be within 24.0 feet of a mapped boundary).
- B. If Step A fails to yield a suitable subplot location, repeat Step A at each of the next highest-numbered regular subplots in the condition.

C. If Steps A and B have been exhausted and a suitable temporary subplot still has not been found, repeat Step A at each temporary subplot in turn, beginning with the first temporary subplot that was established.

If more than one temporary subplot is to be established, repeat Steps A and B to establish the second lowest- numbered temporary subplot next, and continue in order until you have enough temporary subplots established in the condition to get a good, representative estimate of stocking. The general rule for establishing temporary subplots is:

- Install the lowest temporary subplot off the highest established subplot, until all the established subplots have been exhausted.
- Then establish the lowest temporary subplot yet to be established off the lowest one already established (lowest off highest, then lowest off lowest).

If there is a transition zone between two conditions use your best judgment to be sure that trees tallied in the transition zone do not have too much weight in the assignment of a land use.

**A11.1 Stocking values for all tallied trees on the four subplots and microplots**

	DBH of the largest tally tree in the condition																				
	5.0+						4.0-4.9					3.0-3.9				2.0-2.9			1.0-1.9		Seedling
	DBH of tally tree						DBH of tally tree					DBH of tally tree				DBH of tally tree			DBH of tally tree		Seedling
Species	5.0-6.9	4.0-4.9	3.0-3.9	2.0-2.9	1.0-1.9	Seed-ling	4.0-4.9	3.0-3.9	2.0-2.9	1.0-1.9	Seed-ling	3.0-3.9	2.0-2.9	1.0-1.9	Seed-ling	2.0-2.9	1.0-1.9	Seed-ling	1.0-1.9	Seedling	Seedling
19, 93	0.7	6.9	5.2	4.0	2.6	1.2	7.9	6.2	4.6	3.0	1.4	7.6	5.7	3.7	1.8	7.4	4.9	2.3	7.2	3.5	7.0
72, 73	0.6	5.6	4.3	3.3	2.1	1.0	6.4	5.1	3.8	2.5	1.1	6.3	4.6	3.0	1.4	6.1	4.0	1.9	5.9	2.9	5.7
130, 299	1.0	9.1	6.9	5.3	3.4	1.6	10.4	8.3	6.1	4.0	1.9	10.1	7.5	4.9	2.3	9.9	6.5	3.1	9.6	4.7	9.3
108	0.5	5.0	3.7	2.9	1.9	0.8	5.7	4.5	3.3	2.2	1.0	5.5	4.1	2.7	1.3	5.4	3.5	1.7	5.2	2.5	5.1
103, 104, 119	0.4	4.2	3.1	2.4	1.6	0.7	4.7	3.8	2.8	1.8	0.8	4.6	3.4	2.2	1.1	4.5	2.9	1.4	4.4	2.1	4.2
53, 54, 55, 62, 64, 65, 66, 101, 102, 106, 109, 113, 116, 117, 120, 122, 124, 127, 133, 137, 138, 139, 321, 475, 756, 757, 758, 811	0.5	5.0	3.8	2.9	1.9	0.9	5.7	4.6	3.4	2.2	1.0	5.6	4.1	2.7	1.3	5.4	3.6	1.7	5.3	2.6	5.1
15, 201, 202, 511	0.7	6.8	5.1	4.0	2.6	1.2	7.7	6.2	4.6	3.0	1.4	7.5	5.6	3.7	1.7	7.3	4.8	2.3	7.1	3.5	6.9
11, 14, 17, 20, 21, 22, 41, 42, 81, 92, 98, 231, 242, 251, 263, 264	0.5	4.8	3.6	2.8	1.8	0.8	5.4	4.3	3.2	2.1	1.0	5.3	3.9	2.6	1.2	5.1	3.4	1.6	5.0	2.4	4.8
211, 212	0.4	3.8	2.9	2.2	1.4	0.6	4.3	3.4	2.5	1.7	0.8	4.2	3.1	2.0	1.0	4.1	2.7	1.3	4.0	1.9	3.8
312, 341, 421, 631, 763, 768, 821, 997, 999	1.0	9.6	7.2	5.6	3.6	1.6	10.9	8.7	6.4	4.2	2.0	10.6	7.9	5.2	2.4	10.3	6.8	3.3	10.0	4.9	9.8
351, 352, 492	1.3	11.7	8.8	6.8	4.4	2.0	13.3	10.6	7.9	5.1	2.4	13.0	9.6	6.3	3.0	12.6	8.3	4.0	12.3	5.9	11.9
333	1.2	10.9	8.2	6.3	4.1	1.8	12.4	9.8	7.3	4.8	2.2	12.1	9.0	5.9	2.8	11.7	7.7	3.7	11.4	5.5	11.1
375	1.1	10.5	7.9	6.1	4.0	1.8	12.0	9.5	7.1	4.6	2.1	11.6	8.7	5.7	2.7	11.3	7.4	3.6	11.0	5.3	10.7
361, 431, 661, 801, 805, 807, 815, 818, 839, 981	1.2	11.6	8.8	6.8	4.4	2.0	13.2	10.5	7.8	5.1	2.4	12.9	9.6	6.3	3.0	12.5	8.2	3.9	12.2	5.9	11.8
603, 604	1.4	12.7	9.6	7.4	4.8	2.2	14.5	11.5	8.5	5.6	2.6	14.1	10.5	6.9	3.2	13.7	9.0	4.3	13.3	6.5	12.9
741, 746	1.2	10.9	8.3	6.4	4.1	1.9	12.5	9.9	7.3	4.8	2.2	12.1	9.0	5.9	2.8	11.8	7.8	3.7	11.5	5.6	11.1
540, 542	1.0	9.3	7.0	5.4	3.5	1.6	10.6	8.4	6.3	4.1	1.9	10.3	7.7	5.0	2.4	10.0	6.6	3.2	9.8	4.7	9.5
313, 345, 463, 730, 747, 748	1.2	10.8	8.1	6.3	4.1	1.8	12.3	9.8	7.2	4.7	2.2	12.0	8.9	5.8	2.7	11.6	7.6	3.7	11.3	5.5	11.0

**A11.2 Stocking values for all trees tallied on the subplot only**

<b>Species</b>	<b>5.0-6.9</b>	<b>7.0-8.9</b>	<b>9.0-10.9</b>	<b>11.0-12.9</b>	<b>13.0-14.9</b>	<b>15.0-16.9</b>	<b>17.0-18.9</b>	<b>19.0-20.9</b>	<b>21.0-22.9</b>	<b>23.0-24.9</b>	<b>25.0-26.9</b>	<b>27.0-28.9</b>	<b>29.0+</b>
19, 93	0.7	1.1	1.6	2.1	2.6	3.2	3.8	4.4	5.1	5.8	6.5	7.2	8.0
72, 73	0.6	1.0	1.5	2.0	2.6	3.3	4.0	4.9	5.7	6.7	7.6	8.7	9.8
130, 299	1.0	1.5	2.2	3.0	3.8	4.7	5.6	6.6	7.7	8.9	10.1	11.4	12.7
108	0.5	0.9	1.3	1.7	2.2	2.8	3.4	4.1	4.8	5.6	6.4	7.3	8.2
103, 104, 119	0.4	0.7	1.1	1.5	1.9	2.4	3.0	3.6	4.2	4.9	5.6	6.4	7.2
53, 54, 55, 62, 64, 65, 66, 101, 102, 106, 109, 113, 116, 117, 120, 122, 124, 127, 133, 137, 138, 139, 321, 475, 756, 757, 758, 811	0.5	1.0	1.5	2.2	2.9	3.8	4.9	6.0	7.3	8.6	10.1	11.8	13.5
15, 201, 202, 511	0.7	1.1	1.6	2.1	2.7	3.3	4.0	4.7	5.4	6.2	7.0	7.8	8.7
11, 14, 17, 20, 21, 22, 41, 42, 81, 92, 98, 231, 242, 251, 263, 264	0.5	0.8	1.2	1.6	2.1	2.6	3.2	3.8	4.5	5.2	5.9	6.7	7.5
211, 212	0.4	0.7	1.0	1.3	1.7	2.1	2.6	3.1	3.6	4.2	4.8	5.4	6.1
312, 341, 421, 631, 763, 768, 821, 997, 999	1.0	1.6	2.2	3.0	3.8	4.6	5.5	6.5	7.5	8.6	9.7	10.9	12.1
351, 352, 492	1.3	1.9	2.6	3.3	4.1	5.0	5.9	6.8	7.8	8.9	9.9	11.0	12.1
333	1.2	2.0	3.0	4.2	5.6	7.2	9.0	11.0	13.1	15.4	17.8	20.5	23.3
375	1.1	1.9	3.0	4.2	5.6	7.2	9.0	11.0	13.1	15.5	18.0	20.7	23.6
361, 431, 661, 801, 805, 807, 815, 818, 839, 981	1.2	2.0	2.9	3.9	5.0	6.2	7.5	8.9	10.4	11.9	13.6	15.3	17.2
603, 604	1.4	2.1	2.9	3.9	4.9	5.9	7.1	8.3	9.6	10.9	12.3	13.7	15.2
741, 746	1.2	1.8	2.5	3.2	4.0	4.9	5.8	6.8	7.8	8.9	10.0	11.1	12.3
540, 542	1.0	1.4	1.8	2.2	2.6	3.0	3.5	3.9	4.3	4.8	5.2	5.7	6.2
313, 345, 463, 730, 747, 748	1.2	2.0	3.0	4.2	5.6	7.2	8.9	10.9	13.0	15.2	17.7	20.3	23.1

**A11.3 Stocking values for all trees < 7 inches, observed on the four subplots only**

Species	DBH of the largest tally tree in the condition																				
	5.0+						4.0-4.9					3.0-3.9				2.0-2.9			1.0-1.9		Seedling
	DBH of tally tree						DBH of tally tree					DBH of tally tree				DBH of tally tree			DBH of tally tree		Seedling
	5.0-6.9	4.0-4.9	3.0-3.9	2.0-2.9	1.0-1.9	Seed-ling	4.0-4.9	3.0-3.9	2.0-2.9	1.0-1.9	Seed-ling	3.0-3.9	2.0-2.9	1.0-1.9	Seed-ling	2.0-2.9	1.0-1.9	Seed-ling	1.0-1.9	Seedling	Seedling
19, 93	0.74	0.55	0.42	0.32	0.21	0.09	0.63	0.50	0.37	0.24	0.11	0.61	0.45	0.30	0.14	0.59	0.39	0.19	0.58	0.28	0.56
72, 73	0.60	0.45	0.34	0.26	0.17	0.08	0.51	0.41	0.30	0.20	0.09	0.50	0.37	0.24	0.11	0.49	0.32	0.15	0.47	0.23	0.46
130, 299	0.98	0.73	0.55	0.43	0.28	0.12	0.83	0.66	0.49	0.32	0.15	0.81	0.60	0.39	0.19	0.79	0.52	0.25	0.77	0.37	0.74
108	0.53	0.40	0.30	0.23	0.15	0.07	0.45	0.36	0.27	0.17	0.08	0.44	0.33	0.21	0.10	0.43	0.28	0.13	0.42	0.20	0.40
103, 104, 119	0.45	0.33	0.25	0.19	0.13	0.06	0.38	0.30	0.22	0.15	0.07	0.37	0.27	0.18	0.08	0.36	0.24	0.11	0.35	0.17	0.34
53, 54, 55, 62, 64, 65, 66, 101, 102, 106, 109, 113, 116, 117, 120, 122, 124, 127, 133, 137, 138, 139, 321, 475, 756, 757, 758, 811	0.54	0.40	0.30	0.24	0.15	0.07	0.46	0.36	0.27	0.18	0.08	0.45	0.33	0.22	0.10	0.43	0.29	0.14	0.42	0.20	0.41
15, 201, 202, 511	0.73	0.54	0.41	0.32	0.20	0.09	0.62	0.49	0.36	0.24	0.11	0.60	0.45	0.29	0.14	0.59	0.39	0.18	0.57	0.28	0.55
11, 14, 17, 20, 21, 22, 41, 42, 81, 92, 98, 231, 242, 251, 263, 264	0.51	0.38	0.29	0.22	0.14	0.06	0.43	0.34	0.26	0.17	0.08	0.42	0.31	0.21	0.10	0.41	0.27	0.13	0.40	0.19	0.39
211, 212	0.41	0.30	0.23	0.18	0.11	0.05	0.34	0.27	0.20	0.13	0.06	0.34	0.25	0.16	0.08	0.33	0.21	0.10	0.32	0.15	0.31
312, 341, 421, 631, 763, 768, 821, 997, 999	1.03	0.77	0.58	0.45	0.29	0.13	0.87	0.69	0.52	0.34	0.16	0.85	0.63	0.41	0.20	0.83	0.54	0.26	0.80	0.39	0.78
351, 352, 492	1.25	0.93	0.71	0.55	0.35	0.16	1.07	0.85	0.63	0.41	0.19	1.04	0.77	0.50	0.24	1.01	0.66	0.32	0.98	0.48	0.95
333	1.17	0.87	0.66	0.51	0.33	0.15	0.99	0.79	0.58	0.38	0.18	0.96	0.72	0.47	0.22	0.94	0.62	0.30	0.91	0.44	0.89
375	1.13	0.84	0.63	0.49	0.32	0.14	0.96	0.76	0.56	0.37	0.17	0.93	0.69	0.45	0.21	0.91	0.60	0.28	0.88	0.43	0.85
361, 431, 661, 801, 805, 807, 815, 818, 839, 981	1.25	0.93	0.70	0.54	0.35	0.16	1.06	0.84	0.62	0.41	0.19	1.03	0.77	0.50	0.24	1.00	0.66	0.32	0.97	0.47	0.95
603, 604	1.36	1.01	0.77	0.59	0.38	0.17	1.16	0.92	0.68	0.44	0.21	1.13	0.84	0.55	0.26	1.10	0.72	0.34	1.07	0.52	1.03
741, 746	1.17	0.87	0.66	0.51	0.33	0.15	1.00	0.79	0.59	0.38	0.18	0.97	0.72	0.47	0.22	0.94	0.62	0.30	0.92	0.45	0.89
540, 542	1.00	0.74	0.56	0.43	0.28	0.13	0.85	0.67	0.50	0.33	0.15	0.83	0.61	0.40	0.19	0.80	0.53	0.25	0.78	0.38	0.76
313, 345, 463, 730, 747, 748	1.16	0.86	0.65	0.50	0.32	0.15	0.98	0.78	0.58	0.38	0.18	0.96	0.71	0.47	0.22	0.93	0.61	0.29	0.90	0.44	0.88

**A11.4 Stocking values for all trees 5.0 inches and greater observed on the four subplots only**

<b>Species</b>	<b>5.0-6.9</b>	<b>7.0-8.9</b>	<b>9.0-10.9</b>	<b>11.0-12.9</b>	<b>13.0-14.9</b>	<b>15.0-16.9</b>	<b>17.0-18.9</b>	<b>19.0-20.9</b>	<b>21.0-22.9</b>	<b>23.0-24.9</b>	<b>25.0-26.9</b>	<b>27.0-28.9</b>	<b>29.0+</b>
19, 93	0.7	1.1	1.6	2.1	2.6	3.2	3.8	4.4	5.1	5.8	6.5	7.2	8.0
72, 73	0.6	1.0	1.5	2.0	2.6	3.3	4.0	4.9	5.7	6.7	7.6	8.7	9.8
130, 299	1.0	1.5	2.2	3.0	3.8	4.7	5.6	6.6	7.7	8.9	10.1	11.4	12.7
108	0.5	0.9	1.3	1.7	2.2	2.8	3.4	4.1	4.8	5.6	6.4	7.3	8.2
103, 104, 119	0.4	0.7	1.1	1.5	1.9	2.4	3.0	3.6	4.2	4.9	5.6	6.4	7.2
53, 54, 55, 62, 64, 65, 66, 101, 102, 106, 109, 113, 116, 117, 120, 122, 124, 127, 133, 137, 138, 139, 321, 475, 756, 757, 758, 811	0.5	1.0	1.5	2.2	2.9	3.8	4.9	6.0	7.3	8.6	10.1	11.8	13.5
15, 201, 202, 511	0.7	1.1	1.6	2.1	2.7	3.3	4.0	4.7	5.4	6.2	7.0	7.8	8.7
11, 14, 17, 20, 21, 22, 41, 42, 81, 92, 98, 231, 242, 251, 263, 264	0.5	0.8	1.2	1.6	2.1	2.6	3.2	3.8	4.5	5.2	5.9	6.7	7.5
211, 212	0.4	0.7	1.0	1.3	1.7	2.1	2.6	3.1	3.6	4.2	4.8	5.4	6.1
312, 341, 421, 631, 763, 768, 821, 997, 999	1.0	1.6	2.2	3.0	3.8	4.6	5.5	6.5	7.5	8.6	9.7	10.9	12.1
351, 352, 492	1.3	1.9	2.6	3.3	4.1	5.0	5.9	6.8	7.8	8.9	9.9	11.0	12.1
333	1.2	2.0	3.0	4.2	5.6	7.2	9.0	11.0	13.1	15.4	17.8	20.5	23.3
375	1.1	1.9	3.0	4.2	5.6	7.2	9.0	11.0	13.1	15.5	18.0	20.7	23.6
361, 431, 661, 801, 805, 807, 815, 818, 839, 981	1.2	2.0	2.9	3.9	5.0	6.2	7.5	8.9	10.4	11.9	13.6	15.3	17.2
603, 604	1.4	2.1	2.9	3.9	4.9	5.9	7.1	8.3	9.6	10.9	12.3	13.7	15.2
741, 746	1.2	1.8	2.5	3.2	4.0	4.9	5.8	6.8	7.8	8.9	10.0	11.1	12.3
540, 542	1.0	1.4	1.8	2.2	2.6	3.0	3.5	3.9	4.3	4.8	5.2	5.7	6.2
313, 345, 463, 730, 747, 748	1.2	2.0	3.0	4.2	5.6	7.2	8.9	10.9	13.0	15.2	17.7	20.3	23.1

### A11.5 DBH of the largest tally tree in the condition

Table 5e.																					
	5.0+						4.0-4.9					3.0-3.9				2.0-2.9			1.0-1.9		Seedling
	DBH of tally tree						DBH of tally tree					DBH of tally tree				DBH of tally tree			DBH of tally tree		
Species	5.0-6.9	4.0-4.9	3.0-3.9	2.0-2.9	1.0-1.9	Seedling	4.0-4.9	3.0-3.9	2.0-2.9	1.0-1.9	Seedling	3.0-3.9	2.0-2.9	1.0-1.9	Seedling	2.0-2.9	1.0-1.9	Seedling	1.0-1.9	Seedling	Seedling
19, 93	0.12	0.092	0.069	0.054	0.035	0.016	0.105	0.083	0.062	0.040	0.019	0.102	0.076	0.050	0.023	0.099	0.065	0.031	0.096	0.047	0.094
72, 73	0.10	0.075	0.057	0.044	0.028	0.013	0.086	0.068	0.050	0.033	0.015	0.083	0.062	0.041	0.019	0.081	0.053	0.025	0.079	0.038	0.076
130, 299	0.16	0.122	0.092	0.071	0.046	0.021	0.139	0.110	0.082	0.053	0.025	0.135	0.100	0.066	0.031	0.131	0.086	0.041	0.128	0.062	0.124
108	0.09	0.066	0.050	0.039	0.025	0.011	0.075	0.060	0.044	0.029	0.013	0.073	0.055	0.036	0.017	0.071	0.047	0.022	0.069	0.034	0.067
103, 104, 119	0.07	0.055	0.042	0.032	0.021	0.009	0.063	0.050	0.037	0.024	0.011	0.062	0.046	0.030	0.014	0.060	0.039	0.019	0.058	0.028	0.056
53, 54, 55, 62, 64, 65, 66, 101, 102, 106, 109, 113, 116, 117, 120, 122, 124, 127, 133, 137, 138, 139, 321, 475, 756, 757, 758, 811	0.09	0.067	0.051	0.039	0.025	0.011	0.077	0.061	0.045	0.029	0.014	0.074	0.055	0.036	0.017	0.072	0.048	0.023	0.070	0.034	0.068
15, 201, 202, 511	0.12	0.090	0.068	0.053	0.034	0.015	0.103	0.082	0.061	0.040	0.018	0.100	0.075	0.049	0.023	0.098	0.064	0.031	0.095	0.046	0.092
11, 14, 17, 20, 21, 22, 41, 42, 81, 92, 98, 231, 242, 251, 263, 264	0.09	0.063	0.048	0.037	0.024	0.011	0.072	0.057	0.043	0.028	0.013	0.070	0.052	0.034	0.016	0.068	0.045	0.022	0.067	0.032	0.065
211, 212	0.07	0.050	0.038	0.029	0.019	0.009	0.057	0.046	0.034	0.022	0.010	0.056	0.042	0.027	0.013	0.054	0.036	0.017	0.053	0.026	0.051
312, 341, 421, 424, 631, 763, 768, 821, 997, 999	0.17	0.128	0.097	0.075	0.048	0.022	0.146	0.116	0.086	0.056	0.026	0.142	0.105	0.069	0.033	0.138	0.091	0.043	0.134	0.065	0.130
351, 352, 492	0.21	0.156	0.118	0.091	0.059	0.026	0.178	0.141	0.105	0.068	0.032	0.173	0.128	0.084	0.040	0.168	0.111	0.053	0.163	0.079	0.159
333	0.19	0.145	0.110	0.085	0.055	0.025	0.165	0.131	0.097	0.063	0.030	0.161	0.120	0.078	0.037	0.156	0.103	0.049	0.152	0.074	0.148
375	0.19	0.140	0.106	0.082	0.053	0.024	0.160	0.127	0.094	0.061	0.028	0.155	0.115	0.076	0.036	0.151	0.099	0.047	0.147	0.071	0.142
361, 431, 661, 801, 805, 807, 815, 818, 839, 981	0.21	0.155	0.117	0.090	0.058	0.026	0.176	0.140	0.104	0.068	0.032	0.172	0.128	0.084	0.039	0.167	0.110	0.053	0.162	0.079	0.158
603, 604	0.23	0.169	0.128	0.099	0.064	0.029	0.193	0.153	0.114	0.074	0.034	0.188	0.140	0.091	0.043	0.183	0.120	0.057	0.178	0.086	0.172
741, 746	0.20	0.146	0.110	0.085	0.055	0.025	0.166	0.132	0.098	0.064	0.030	0.162	0.120	0.079	0.037	0.157	0.103	0.049	0.153	0.074	0.148
540, 542	0.17	0.124	0.094	0.072	0.047	0.021	0.141	0.112	0.083	0.054	0.025	0.138	0.102	0.067	0.032	0.134	0.088	0.042	0.130	0.063	0.126
313, 345, 463, 730, 747, 748	0.19	0.143	0.109	0.084	0.054	0.024	0.164	0.130	0.097	0.063	0.029	0.159	0.118	0.078	0.037	0.155	0.102	0.049	0.151	0.073	0.146



**A11.6 Stocking values for all trees 5.0 inches and greater observed on one acre**

<b>Species</b>	<b>5.0-6.9</b>	<b>7.0-8.9</b>	<b>9.0-10.9</b>	<b>11.0-12.9</b>	<b>13.0-14.9</b>	<b>15.0-16.9</b>	<b>17.0-18.9</b>	<b>19.0-20.9</b>	<b>21.0-22.9</b>	<b>23.0-24.9</b>	<b>25.0-26.9</b>	<b>27.0-28.9</b>	<b>29.0+</b>
19, 93	0.12	0.19	0.26	0.34	0.43	0.53	0.63	0.73	0.84	0.96	1.08	1.20	1.33
72, 73	0.10	0.17	0.24	0.33	0.44	0.55	0.67	0.81	0.95	1.11	1.27	1.45	1.63
130, 299	0.16	0.26	0.37	0.49	0.63	0.78	0.94	1.11	1.29	1.48	1.68	1.89	2.11
108	0.09	0.14	0.21	0.29	0.37	0.47	0.57	0.69	0.81	0.94	1.07	1.22	1.37
103, 104, 119	0.07	0.12	0.18	0.25	0.32	0.41	0.50	0.60	0.70	0.82	0.94	1.07	1.20
53, 54, 55, 62, 64, 65, 66, 101, 102, 106, 109, 113, 116, 117, 120, 122, 124, 127, 133, 137, 138, 139, 321, 475, 756, 757, 758, 811	0.09	0.16	0.25	0.36	0.49	0.64	0.81	1.00	1.21	1.44	1.69	1.96	2.25
15, 201, 202, 511	0.12	0.19	0.27	0.35	0.45	0.55	0.66	0.78	0.90	1.03	1.16	1.30	1.45
11, 14, 17, 20, 21, 22, 41, 42, 81, 92, 98, 231, 242, 251, 263, 264	0.09	0.14	0.20	0.27	0.35	0.44	0.53	0.64	0.75	0.86	0.98	1.11	1.25
211, 212	0.07	0.11	0.16	0.22	0.28	0.35	0.43	0.51	0.60	0.69	0.79	0.90	1.01
312, 341, 421, 631, 768, 821, 997, 999	0.17	0.27	0.37	0.49	0.63	0.77	0.92	1.08	1.25	1.43	1.62	1.81	2.01
351, 352, 492	0.21	0.31	0.43	0.56	0.69	0.83	0.98	1.14	1.31	1.48	1.65	1.83	2.02
333	0.19	0.33	0.50	0.71	0.94	1.21	1.50	1.83	2.18	2.56	2.97	3.41	3.88
375	0.19	0.32	0.49	0.70	0.93	1.20	1.50	1.83	2.19	2.58	3.00	3.45	3.93
361, 431, 661, 801, 805, 807, 815, 818, 839, 981	0.21	0.33	0.48	0.64	0.83	1.03	1.24	1.48	1.73	1.99	2.27	2.56	2.86
603, 604	0.23	0.35	0.49	0.64	0.81	0.99	1.18	1.38	1.60	1.82	2.05	2.29	2.54
741, 746	0.20	0.30	0.41	0.54	0.67	0.82	0.97	1.13	1.30	1.48	1.66	1.85	2.05
540, 542	0.17	0.23	0.30	0.36	0.43	0.50	0.58	0.65	0.72	0.80	0.87	0.95	1.03
313, 345, 463, 730, 747, 748	0.19	0.33	0.50	0.70	0.93	1.19	1.49	1.81	2.16	2.54	2.95	3.38	3.85

**A11.7 Minimum number of trees per acre for forest land based on largest tally tree**

Species	DBH of largest tally tree																	
	Seed-ling	1.0-1.9	2.0-2.9	3.0-3.9	4.0-4.9	5.0-6.9	7.0-8.9	9.0-10.9	11.0-12.9	13.0-14.9	15.0-16.9	17.0-18.9	19.0-20.9	21.0-22.9	23.0-24.9	25.0-26.9	27.0-28.9	29.0+
19, 93	106.9	103.8	100.9	98.1	95.5	81.2	53.0	38.1	29.1	23.2	19.0	16.0	13.7	11.9	10.4	9.3	8.3	7.5
72, 73	130.8	127.0	123.4	120.0	116.8	99.3	60.3	41.0	29.9	22.9	18.2	14.8	12.4	10.5	9.0	7.9	6.9	6.1
130, 299	80.6	78.3	76.1	74.0	72.0	61.2	38.7	27.2	20.3	15.9	12.9	10.7	9.0	7.8	6.8	5.9	5.3	4.7
108	148.4	144.1	140.0	136.2	132.6	112.7	69.1	47.3	34.7	26.7	21.3	17.4	14.6	12.4	10.7	9.3	8.2	7.3
103, 104, 119	177.2	172.0	167.2	162.6	158.2	134.5	81.8	55.6	40.5	31.1	24.7	20.1	16.8	14.2	12.2	10.6	9.4	8.3
53, 54, 55, 62, 64, 65, 66, 101, 102, 106, 109, 113, 116, 117, 120, 122, 124, 127, 133, 137, 138, 139, 321, 475, 756, 757, 758, 811	146.4	142.1	138.1	134.3	130.7	111.1	62.5	40.0	27.8	20.4	15.6	12.3	10.0	8.3	6.9	5.9	5.1	4.4
15, 201, 202, 511	108.5	105.3	102.4	99.6	96.9	82.4	52.9	37.5	28.3	22.3	18.2	15.2	12.9	11.1	9.7	8.6	7.7	6.9
11, 14, 17, 20, 21, 22, 41, 42, 81, 92, 98, 231, 242, 251, 263, 264	154.8	150.3	146.1	142.0	138.2	117.5	72.7	50.1	36.9	28.5	22.8	18.8	15.7	13.4	11.6	10.2	9.0	8.0
211, 212	195.0	189.3	184.0	178.9	174.1	148.0	91.3	62.7	46.2	35.7	28.5	23.4	19.6	16.7	14.4	12.6	11.1	9.9
312, 341, 421, 631, 763, 768, 821, 997, 999	76.9	74.6	72.5	70.5	68.7	58.4	37.6	26.7	20.2	16.0	13.0	10.9	9.2	8.0	7.0	6.2	5.5	5.0
351, 352, 492	63.0	61.2	59.5	57.8	56.3	47.8	31.9	23.3	18.0	14.5	12.0	10.2	8.8	7.7	6.8	6.1	5.5	4.9
333	67.8	65.8	63.9	62.2	60.5	51.4	30.1	19.9	14.2	10.6	8.3	6.7	5.5	4.6	3.9	3.4	2.9	2.6
375	70.2	68.1	66.2	64.4	62.7	53.3	30.9	20.3	14.4	10.7	8.3	6.7	5.5	4.6	3.9	3.3	2.9	2.5
361, 431, 661, 801, 805, 807, 815, 818, 839, 981	63.5	61.6	59.9	58.2	56.7	48.2	30.1	20.9	15.6	12.1	9.7	8.0	6.8	5.8	5.0	4.4	3.9	3.5
603, 604	58.0	56.3	54.7	53.2	51.8	44.0	28.6	20.5	15.6	12.3	10.1	8.5	7.2	6.3	5.5	4.9	4.4	3.9
741, 746	67.4	65.4	63.6	61.8	60.2	51.2	33.6	24.3	18.6	14.8	12.2	10.3	8.8	7.7	6.8	6.0	5.4	4.9
540, 542	79.2	76.9	74.7	72.6	70.7	60.1	43.4	33.7	27.5	23.1	19.8	17.4	15.4	13.8	12.5	11.5	10.5	9.8
313, 345, 463, 730, 747, 748	68.4	66.4	64.5	62.7	61.0	51.9	30.4	20.1	14.3	10.7	8.4	6.7	5.5	4.6	3.9	3.4	3.0	2.6

## APPENDIX 12 CORRESPONDENCE AND CONTACT EXAMPLES

### A12.1 HELLO LETTER/DATA CONFIDENTIALITY

<b>United States</b>	<b>Forest</b>	<b>Pacific</b>	<b>Forestry Sciences Laboratory</b>
<b>Department of</b>	<b>Service</b>	<b>Northwest</b>	<b>P.O. Box 3890</b>
<b>Agriculture</b>		<b>Research</b>	<b>Portland, Oregon 97208</b>
		<b>Station</b>	<b>(503) 808-2000</b>

---

File Code: 4810

Date: Summer 2006

To Whom It May Concern:

Hello, we are researchers from the USDA Forest Service, Pacific Northwest Research Station. We are obtaining information on the forest resources of the Pacific Northwest from measurements taken on a large number of randomly located sample plots on forestland. We are visiting one of these plots in this general vicinity today.

We locate each plot from a sample selected on an aerial photograph. While at the site we record information pertaining to the type of terrain; tree species, heights, and diameters; insect and disease damage; mortality and regeneration; and the amount and kind of understory vegetation. Many of our field plots were first established in the early 1960's and have been revisited on a 10-year cycle.

With the measurements we take, analysts will develop basic information about the amount, condition, and change in the area's forest resource. Published reports contain data on forest land area and ownership, timber volume, forest growth, mortality and cut, potential productivity, and opportunities for silvicultural treatment.

If you are interested in learning more about our research plans, or care to see publications from previous inventories similar to this one, please contact Otha Terry at (503) 808-2044 or Bob Rhoads at (503) 808-2022 by telephone or by writing to:

Portland Forestry Sciences Laboratory  
Forest Inventory and Analysis Program  
P. O. Box 3890  
Portland, OR 97208-3890

Sincerely,

BOB RHOADS  
Team Leader  
Forest Inventory and Analysis

## **A12.2 INTERIM LOCATION CONFIDENTIALITY POLICY**

The "Interim Privacy Policy-8/2000" from the Washington FIA Office, describes in detail the confidentiality policy as it applies to all owners. This policy, along with the law as it is written are both provided following this document.

The purpose of this document is to aid field crews in applying the policy and following the law in discussions with landowners. It will provide: a listing of what information we can and cannot provide based on our privacy policy, conversation scenarios showing tactics crews can use with landowners who are requesting location information, how to get directions to the plot without disclosing confidential plot coordinates, what the exception to the law is and why, and finally, what to do when all your attempts seem to fail but you think the owner might still grant access. Contacts and references are provided at the end.

### **Summary of FIA privacy (confidentiality) policy**

Location information we CAN provide to the landowner:

- USGS quad the plot falls on.
  - Landmarks near the plot, but not within one mile of the plot.
  - Township, Range, and Section ("legal") the plot falls within. For example, "Township 10 South, Range 5 East, Section 16."
  - Owner's tax parcel number. Used only when the owner questions whether they own the property.
- Location information we CANNOT provide:
- UTM coordinates, whether derived from a map or from the field GPS reading, also known as the "northing" and the "easting."
  - The Quarter Section of the above TRS legal the plot falls within. For Example, "NESW, or, Northeast Quarter of the Southwest Section."
  - Latitude and Longitude.
  - Giving the photo (or a copy of the photo) with the pinprick for them to keep or copy.
  - Giving the USGS quad (or a copy of the USGS quad) with plot location marked for them to keep or copy.

### **Conversation scenarios**

Occasionally, a landowner insists on detailed location information beyond what we are permitted to disclose. Crews need clear direction in how to proceed in a conversation when they have to deny the owner's request but still try to gain access to their land. Here are several hypothetical scenarios that demonstrate the policy in action. Suggested crew responses are provided as guides. The scenarios begin after the crew introduces themselves and requests access.

#### **Scenario 1**

Landowner (L): small woodlot owner: "Where are you working?"

Crew (C): "The plot is a couple miles up Windy Road and south of Burnt Hill."

L: "OK, good luck."

#### **Scenario 2**

L: Forester for Small Forest Industries: "Where is your research plot located?"

C: "We're several miles up road 452."

L: "If you tell me the legal description, I can tell you the best way to get there and if there are any gates."

C: "It is located in Township...Range... Section..."

L: "Ok, there is one gate on that road but it'll be locked after 6pm. Will you be out of there by then?"

<As far as one can gain access without having to say "I am not allowed to give you that information" the smoother the conversation will be. The immediate landowner response to denying them information is nearly always alarm, defensiveness, and distrust. Fortunately, most people don't want or need a detailed account of the location. The more general you can be about the location and satisfy the landowner without having to give any further explanations or justifications, then the least likely you are to raise a negative response>

### **Scenario 3**

L: A scientist who spends her spare time exploring wilderness areas. Upon hearing a vague location response, she says, "That's fine, but I'd like to know exactly where it is. A GPS reading even would be nice."

C: "Because of confidentiality laws, I am unable to give you the plot's GPS reading or, UTM coordinates. I know it sounds strange because it is your land, but the law applies to everyone. It was written to protect landowners from data being used against them. I can't give you that information, but I also can't give the EPA or any group that information. This policy attempts to be fair in protecting your privacy."

L: "Laws, huh... Well, I guess it's OK. Can I go with the crew and get my own GPS reading?"

C: "Sure."

<Crews should not initially encourage or offer landowners the option of going with the crew either to obtain their own GPS reading or as an escort. This is used as a last resort when it is clear the landowner won't grant access otherwise. In the cases where the landowner wants to accompany the crew because they are just curious about the work we're doing, rather than the location of the work, emphasize to the landowner the importance of the plot area being treated exactly the same as they would treat the rest of their property. See scenario four, below>

### **Scenario 4**

L: District manager for a large forest industry: "We need your plot coordinates for our records."

C: "I can't provide that information because of confidentiality laws that apply to everyone. The laws protect landowners from information we gather being used against them."

L: "I'm not sure we can grant access without that information. Let me check into it, then get back to you."

C: "I can give TRS, would that be enough? Another reason we don't give coordinates, is that some owners manage the plots differently from the rest of their land once they know where they are, and we don't want that to happen. Since we track changes over time, if there are islands of plots with mature trees surrounded by clearcuts, for example, this means the data has become biased and is now unreliable."

### **Scenario 5**

L: National Forest employee who is not an FIA National Forest regional inventory coordinator. "Where are your plots located in this forest? I want to send a crew along to see how the plots are measured. I am also interested in using the data for analysis."

C: "We cannot permit your crews or other personnel to accompany us to the plot, unless they are contract crews specifically hired to collect FIA data on that plot. This is regulated through a Memorandum of Understanding (MOU) between the FIA program and the National Forest system."

L: "So, you're telling me that even though this is public property, that even federal employees can't have access to the plots or the data? I have a legitimate interest in where these plots are located. Besides, I thought the Freedom Of Information Act was created to allow access to public information."

C: "There is an exemption from the Freedom Of Information Act concerning FIA plot locations. If you believe you have a legitimate need for location information and raw data for analysis, then you will need to contact your National Forest regional FIA coordinator. If you want to visit the plot, you will need to contact our program manager."

<See contacts section>

### **Scenario 6 (data request)**

L: "I am interested in receiving plot data."

C: "No problem. I'll send your request to the office."

<The crew will then enter into the husky program that the owner has requested data. This is all that needs to be done. Otha Terry will obtain the information when the plots are electronically sent to the office. He will then use a program that will summarize the data, and send it to the landowner. However, this data will not include the plot coordinates>

### **How to get directions**

You're trying to get to a plot and you know the landowner often knows the best route in. One could say "The plot is up Mountain Pass Road about 6 miles. Are there any access restrictions?" Or if it is a forester for a timber company, one could give the TRS, which should be enough for him or her to recommend a route. Aerial photos usually provide the crew enough near-plot access information.

### **Exception to the law**

As mentioned in scenario five above, there is a Memorandum of Understanding (MOU) between the FIA program and the National Forest system for obtaining detailed location information. The MOU only covers the National Forest employees that are directly involved in FIA work. Regional inventory coordinators are the official National Forest staff that is given exact plot locations that they may use to give to contract crews and for data analysis.

### **The last resort**

When an owner simply doesn't understand the privacy laws and expresses a desire for more information before they might grant access, then the crew can offer a copy of the law to mail to the owner, and/or give the state coordinator's name and number for the landowner to contact for a more authoritative response.

### **Contacts**

There are a couple of special circumstances where a referral to specific FIA contacts is appropriate. This will be a very rare occurrence, and is not to be used for the majority of landowner questions that can be handled by the crews, state coordinators and assistant state coordinators.

For plot location and data requests from federal land managers who are not directly involved in FIA work already, they can contact our program manager, Sue Willits at 503-808-2066.

For FIA plot locations and data requests from National Forest personnel who are not directly involved in FIA, they can contact their FIA regional coordinator. For Region 5 (California), contact Ralph Warbington at 916-454-0809. For Region 6 (Oregon and Washington), contact Jim Alegria at 503-808-6090.

If National Forest personnel (who are not directly involved in FIA) want to visit an FIA plot, they will need to contact our program manager, Sue Willits at 503-808-2066.

For GIS-specific plot information (generally requested by large landowners like large timber companies) the contact is Dale Weyermann at 503-808-2042.

### **References**

Public Law 99-198 [H.R. 2100]; December 23 1985. Privacy Amendment: H.R.3423 Department of the Interior and Related Agencies Appropriations Act, 2000 (November 17, 1999). Electronic mail: "New Legislation on Privacy for FIA Data and Information."

USDA Forest Service, FIA. "Confidentiality of FIA Sample Locations." FIA Fact Sheet Series. 2001.

USDA Forest Service, Washington Office. "Access to Exact Coordinates for FIA Plots-Interim Privacy Policy." 2000.

Weyermann, Dale. Personal Communication. 2002.

Willits, Susan A. Personal Communication. 2002.

## **A12.3 Access to Exact Coordinates for FIA Plots**

### **Final Interim Privacy Policy**

**August 2000**

**BACKGROUND.** Present FIA policy (Federal Register / Vol. 54, No. 203 / Monday, October 23, 1989) calls for public release of coordinates rounded to the nearest 100 seconds (approx. 1 mile). This is currently available publicly for most data collected between 1995 and 1999 (e.g. in the eastwide database) and is sufficient for most users. However, some users may need access to more precise coordinates to reference FIA plot data to some other high-precision data layer, e.g. satellite imagery, DEM, or other modeled output.

#### **FIA sample locations are kept confidential for three primary reasons:**

1. **Protect landowners.** Our access to plots is only possible with landowner permission. Landowners are concerned about protecting their privacy, as well as the nuisance factor of having strangers on their property. Historically, we have promised landowners absolute confidentiality of their data - that is, there would be no way associate individual plot data with specific locations (and owners) on the ground. The new legislation now requires this. We also keep visits to a minimum of 1 or 2 times (including QA plots) every 5-10 years.
2. **Protect the integrity of the plots.** All plot visits involve risk of impacting the elements of the plot (e.g. cutting or damaging trees, compacting soils, trampling vegetation). This could result in biased estimates if our permanent plot system becomes unrepresentative of the sample population of interest (all US lands). Since we have no control over access to sample locations, the best way to protect the locations is to keep them confidential.
3. **Protect the reputation of the FIA program for providing unbiased information.** If plot locations are commonly known, specifically by land managers, there may be accusations that land managers are manipulating the results of the inventory by management practices, e.g. by not harvesting forest contained on sample plots.

Recent legislation has increased the emphasis on protecting the privacy of our plot locations beyond this earlier policy. In order to continue to serve our clients and partners, we must develop an interim policy that reflects the intent of the new legislation while we craft a more formal policy. We propose the following interim rules for access to FIA plot locations:

1. **ACCESS BY INTERNAL FIA STAFF.** Access to exact locations are granted to FIA program staff only to the extent that they need to know the location in order to perform their work. 'FIA program staff' refers to duly authorized agents of the FIA program including federal employees in FIA and FHM units, State partners, universities, or contractors who are actively involved in implementing the FIA program. Access to exact coordinates is only for the purpose of performing work in direct support of the FIA program, such as field data collection or analysis.
2. **ACCESS BY EXTERNAL USERS.** 'External users' are all users of FIA data who are not directly involved in accomplishing the FIA mission, including federal research staff, state agencies, universities, and other users. FIA will treat all external requests for exact coordinate information in a consistent fashion. FIA will continue to release approximate plot coordinates rounded to the nearest 100 seconds of latitude and longitude. This amounts to approximately plus or minus 1 mile., and is sufficient for many spatial applications. However, access by external users to exact coordinates differs for private land and public land.

#### **ACCESS TO EXACT COORDINATES ON PUBLIC LAND.**

**FIA may release coordinates for plots on public lands to the Agency responsible for managing the land or to other cooperators during the interim policy period. This interim policy is intended to maximize the usefulness of the information on public land and thus maximize benefits to the taxpayers supporting the program. This would only be done under terms of a formal written agreement involving at a minimum the affected FIA unit(s), the affected public land management officers, and the cooperator.** Land managers must agree to avoid treating the plot areas any differently than areas without plots to avoid sample bias. Managers will also be requested not to make this information generally public. Managers must understand that if these terms are violated, the plots may have to be abandoned and the data record severed.

The terms of agreement should at a minimum do the following:

- a) Refer to a written study plan describing the nature of the research, where and why the exact coordinates are needed, and how the data will be used.
- b) Set a definite sunset date after which time all coordinates are purged from cooperator paper and electronic files.
- c) State that no plot visits will occur without FIA permission, and that there will be no destructive sampling on plot. Plots must not be impacted by cooperators.
- d) Guarantee that there will be no subsequent sharing or release of coordinates by the cooperator.
- e) Guarantee that the appropriate FIA unit(s) receive credit in all resulting pubs for the grant of data.
- f) Provide for periodic reporting on the status of the research, including where the coordinates are currently located and who has access.

#### **ACCESS TO EXACT COORDINATES ON PRIVATE AND TRIBAL LAND**

FIA does not release exact coordinates for private or tribal land, under any circumstances during the interim policy period. This is the only practical way to protect the privacy interests of private landowners. Failure to protect privacy will result in an increase in lands where access to collect data is denied.

For cases where users can demonstrate a true need for greater precision in plot locations, FIA should offer an alternative to release of plot coordinates. FIA can create in-house capability to collaborate with researchers. Coordinates can be used in the FIA office, by FIA staff or visiting colleagues, on FIA equipment. Research results, derived layers (but not exact coordinates) can leave the office when done. Advantage is that it allows research to proceed, increases use of FIA information and products, and does not compromise data security. It creates a way in which both FIA and user interests can be satisfied.



## A12.4 Confidentiality Certification

### CONFIDENTIALITY CERTIFICATION AND REQUEST FOR ACCESS TO UNPUBLISHED FOREST INVENTORY AND ANALYSIS (FIA) SAMPLE SITE LOCATION DATA AGREEMENT

Version 1.01

30 April 2004

USDA Forest Service

PNW Research Station

Forest Inventory and Analysis Program

P.O. Box 3890

Portland, OR 97208

**This agreement is intended to cover the following individuals and organizations, and is to be completed and signed anew for each research project that makes use of FIA Sample Site Location Data:**

1. Employees of the FIA Program who, while located physically off-premises of the Portland or Anchorage Labs of the PNW Research Station, work with sample site location data or derivative products from which sample locations and/or landowner identities could be recovered by a motivated individual.
2. Researchers who collaborate with employees of the FIA Program and who are given use of derivative products from which sample locations and/or landowner identities could be recovered by a motivated individual.

Non-FIA employees requiring access to sample site location data (i.e., plot coordinates) are required to complete and receive PNW-FIA Program Manager approval of a memorandum of understanding covering such access prior to receiving such data.

#### **A. CERTIFICATION AND RESTRICTIONS ON USE OF FOREST INVENTORY AND ANALYSIS SAMPLE SITE LOCATION DATA**

The specific conditions of this agreement are:

1. All individual sample site location data are confidential. No copies of reports or computer files or data sets containing these sample site locations can be made or published. Also, summaries that could possibly reveal the location and/or identity of an FIA sample site may not be published nor made public to anyone not covered by this agreement.
2. These data will be used for "statistical, analytical and research purposes" only, and for purposes that enhance the Forest Inventory and Analysis Program.
3. Dissemination or sharing of 1) the FIA provided sample sites, 2) layers derived from the FIA provided sample sites which could be used to identify owners or reconstruct coordinates, or 3) FIA data aggregated in such a way that plot attributes could be linked to owners or used to reconstruct coordinates, with persons other than those who are directly associated with the project for which the data were obtained and who have completed the CONFIDENTIALITY CERTIFICATION AND REQUEST FOR ACCESS TO UNPUBLISHED FOREST INVENTORY AND ANALYSIS (FIA) SAMPLE SITE LOCATION DATA agreement is strictly prohibited.
4. A courtesy briefing of any report using sample site location data will be given to the Program Manager, PNW Forest Inventory and Analysis Program, prior to publication.
5. Following publication of the research utilizing FIA Sample Site Locations, these location data will be returned to the PNW-FIA Program and any and all copies of this data (e.g., including on removable hard disks and backup tapes) will be destroyed at that time.
6. Confidential data, including sample site locations and any derived layers from which sample site locations could be recovered, will only be stored and used on a computer with security restrictions on file access which include password protection and the absence of a connection to wide area networks other than the firewall-protected Forest Service network.

7. Any questions regarding access to unpublished data, propriety of reports or analysis shall be referred to the Program Manager, Forest Inventory and Analysis Program, PNW Research Station, USDA-Forest Service for appropriate response.

In addition to the above conditions, I have been provided a copy of the Food Security Act Of 1985, Public Law 99-198 [H.R. 2100], December 23, 1985, Confidentiality Of Information, sec. 1770, as amended by H.R.3423 on November 17, 1999.

If approval is granted, all employees and/or sub-agents who will have access to FIA SAMPLE SITE LOCATION datasets will be required to sign a notarized or witnessed copy of the CONFIDENTIALITY CERTIFICATION AND REQUEST FOR ACCESS TO UNPUBLISHED FOREST INVENTORY AND ANALYSIS (FIA) SAMPLE SITE LOCATION DATA agreement. This signature certifies compliance with the laws and regulations listed in the agreement regarding confidentiality and other restrictions limiting the use of FIA datasets to the purpose(s) stated in section B: "Forest Inventory and Analysis (FIA) Data Request Overview"

I certify that I have read the above-mentioned conditions and regulations this \_\_\_ day of \_\_\_\_\_, 2005, and agree to these conditions concerning the use of unpublished FIA data provided by the PNW-FIA Program in response to my request.

(Signature)

(Type or print name)

(Agency/Organization)

(City and State)

Witnessed by: \_\_\_\_\_ Date: \_\_\_\_\_

## **B. FOREST INVENTORY AND ANALYSIS (FIA) DATA REQUEST OVERVIEW**

Specify sample site data needed (include dates of coverage if applicable):

- 1) Plot locations, written directions to plots, and descriptions of plots as needed to facilitate field visitation. This includes geographic coordinates (latitude/longitude, or UTM coordinates) as well all Public Land Survey legal descriptions below the Section level.
- 2) Name, address, and any other identifying information of the owner of record for each plot to be visited.

The following use will be made of these data:

- 1) FIA crews and authorized contractors will use plot locations and descriptions to navigate to each plot in the safest and most efficient manner.
- 2) FIA crews and authorized contractors will use owner information as needed to obtain or verify permission to visit plots, or to contact the owner for access information (road conditions, existence of locked gates, acquiring a key or lock code, etc).
- 3) All location and owner information will be returned to the FIA program office in Portland upon completion of the field season or the termination of the contract. All location and owner information outside the Portland FIA office will be removed from all computers, databases and written records at that time.

Attach other appropriate project information, including:

1. Timing of proposed project
2. Methods of analysis or statistical techniques to be used
3. Levels of reliability required.
4. Level of interpretation planned.
5. Where the data set will reside or be used and security provisions for the computer on which it will reside (i.e., not connected to any non-Forest Service network, not shared with anyone who has not signed this certification).
6. Organizational units and/or sub-agents who will have access to the data.

**C. FOREST INVENTORY AND ANALYSIS DATA RELEASE AUTHORIZATION**

(reference section A, "Certification and restrictions on use of Forest Inventory and Analysis sample site location data", and section B, "Forest Inventory And Analysis [FIA] data request overview")

Approved \_\_\_\_

Disapproved \_\_\_\_ for the following reasons (if applicable):

(Signature of PNW-FIA Program Manager)

(Date)

MOU-xx

## **A12.5 Sample Memorandum of Understanding**

### **Between**

Name of FIA partner/cooperator here

### **and**

Name of Research Station here

### **UNITED STATES DEPARTMENT OF AGRICULTURE - FOREST SERVICE**

This Memorandum of Understanding (MOU) is made and entered into by and between the Name of FIA partner/cooperator here, a public agency, hereinafter referred to as the Shortened name of FIA partner/cooperator here and the United States Department of Agriculture, Forest Service, Name of Research Station here, hereinafter referred to as the Forest Service.

#### **I. PURPOSE:** (amend as necessary)

The Forest Service collects renewable forest resources information across the [geographic area of interest here], and maintains these data in geospatial databases that can be linked to individual land owners. This raises privacy issues concerning the release of personal information that the landowner may consider proprietary or confidential. New legislation regarding FIA data redefines rules for disclosure of plot locations under Section 1770(d) of the Food Security Act of 1985 (7 U.S.C. 2276(d)) and supercedes the previous release policy found in Forest Resource Inventory Statistics guidance in Federal Register / Vol. 54, No. 203 / Monday, October 23, 1989 / Notices 43189-90.

This agreement document serves as an interim policy and outlines the conditions under which the Forest Service will release plot locations to partners/cooperators who are actively engaged in implementing or forwarding the Forest Service mission through work or research, and the protections imposed to insure continued privacy and confidentiality of the personal information released.

#### **II. STATEMENT OF MUTUAL BENEFITS AND INTERESTS:** (amend as necessary)

Both the Forest Service and the partner/collaborator conduct and have a mutual interest in research pertaining to the renewable forest resources of the [geographic area of interest]. The Forest Service is conducting research to ascertain the extent, status, and changes in the forests in this region as part of its annual Forest Inventory and Analysis (FIA) effort. The partner/collaborator has an interest in obtaining timely, relevant, and accurate research results that are delivered as efficiently as possible. The partner/collaborator has the resources, facilities, and expertise to more efficiently [gather resource information on FIA plots, test the feasibility of a new remote sensing technique to speed phase 1 area estimates, employ new remote sensing techniques in forest resource analyses, etc. etc]. In order to take full advantage of the mutual benefits that a collaborative partnership could offer to FIA, the partner/cooperator, and their respective publics, the FIA plot locations will have to be released to the partner/cooperator. Given that the Forest Service does not want to release any data that might be considered privileged or proprietary by any individual or corporate landowner; that the Forest Service does not want the release of such data to restrict access to the plots in the future; that the Forest Service does not want the release of such data to cause plots to be treated differently than they would have otherwise been treated, which would bias our results; and that the Forest Service does not want the release of such data to damage the credibility and reputation of the FIA program, both parties agree to share plot location information for the benefit of all with the following stipulations:

#### **III. THE Partner/cooperator AGREES to:**

1. not disclose the plot locations to any other party,
2. not use the plot locations for purposes other than those in this agreement,
3. not visit the actual sites of the plot locations,
4. not contact, bother, or otherwise infringe upon the landowners of the plot locations,
5. not conduct destructive or intrusive sampling (soil extraction, plant removal, trampling, etc) within the bounds of the Forest Service plot (see attached plot diagram),
6. not alter what would be normal business operations/forest management activities on the sites of the plot locations,
7. not disclose the forest inventory data for an individual private or corporate landowner,
8. not use the forest inventory data for regulatory actions against the landowner,
9. allow the Forest Service review study plans and reports resulting from the use of plot locations and their associated forest inventory data,

- 10. give the Forest Service credit (written/oral acknowledgements, authorships, etc) as the source of the forest inventory data used,
- 11. allow the Forest Service to use the final product/results in other applications and locations,
- 12. delete, purge, or otherwise destroy all hardcopy and electronic files containing the plot locations, and to return all plot navigational aids (plot sheets, photos, etc) to the Forest Service at the expiration of this agreement or termination/completion of work.

**IV. THE FOREST SERVICE AGREES to:** (amend as necessary)

- 1. provide the location (coordinates) of the necessary FIA plots,
- 2. provide the plot sheets, photos, and other navigational aids necessary to establish or recover the FIA plots,
- 3. provide the data collected by the Forest Service on these plots in electronic form,
- 4. provide assistance in understanding, using, and interpreting the data provided.

**V. IT IS MUTUALLY AGREED AND UNDERSTOOD BY AND BETWEEN THE SAID PARTIES THAT:**

- 1. Violation. Any act by the partner/cooperator and/or their assigns that violates any of the provisions of plot location access, use, and disclosure describe above will be subject to penalties pursuant to the provisions of the FOOD SECURITY ACT OF 1985 (PL 99-198, December 23, 1985)
- 2. Termination. Either party(s), in writing, may terminate the instrument in whole, or in part, at any time before the date of expiration.
- 3. Participation in Similar Activities. This instrument in no way restricts the Forest Service or the Cooperator(s) from participating in similar activities with other public or private agencies, organizations, and individuals.
- 4. Restriction for Delegates. Pursuant to Section 22, Title 41, United States Code, no member of, or Delegate to, Congress shall be admitted to any share or part of this instrument, or any benefits that may arise therefrom.
- 5. Completion Date. This instrument is executed as of the last date shown below and expires on Enter date or expiration, at which time it will be subject to review, renewal, or expiration.
- 6. Principal Contacts. The principal contacts for this instrument are:

\_\_\_\_\_  
**Name, address, etc. for**  
**Research Station contact**

\_\_\_\_\_  
**Name, address, etc. for**  
**FIA cooperator**

- 7. Non-Fund Obligating Document. This instrument is neither a fiscal nor a funds obligation document. Any endeavor involving reimbursement or contribution of funds between the parties to this instrument will be handled in accordance with applicable laws, regulations, and procedures including those for Government procurement and printing. Such endeavors will be outlined in separate agreements that shall be made in writing by representatives of the parties and shall be independently authorized by appropriate statutory authority. This instrument does not provide such authority. Specifically, this instrument does not establish authority for noncompetitive award to the cooperator of any contract or other agreement. Any contract or agreement for training or other services must fully comply with all applicable requirements for competition.
- 8. Modification. Modifications within the scope of this instrument shall be made by the issuance of a bilaterally executed modification prior to any changes being performed.

IN WITNESS WHEREOF, the parties hereto have executed this MOU as of the last written date below.

\_\_\_\_\_  
**Station Director**                      **Date**

\_\_\_\_\_  
**Regional or State Forester**                      **Date**

\_\_\_\_\_  
**Partner/cooperator**                      **Date**

## **A12.6 New Legislation on privacy for FIA data and information**

### **1. Privacy Amendment: H.R.3423 Department of the Interior and Related Agencies Appropriations Act, 2000 (November 17, 1999)**

#### TITLE III--GENERAL PROVISIONS

SEC. 348. Section 1770(d) of the Food Security Act of 1985 (7 U.S.C. 2276(d)) is amended by redesignating paragraph (10) as paragraph (11) and by inserting after paragraph (9) the following new paragraph: "(10) section 3(e) of the Forest and Rangeland Renewable Resources Research Act of 1978 (16 U.S.C. 1642(e));"

### **2. The Law which was amended:**

FOOD SECURITY ACT OF 1985

PUBLIC LAW 99-198 [H.R. 2100]; December 23, 1985

#### CONFIDENTIALITY OF INFORMATION

##### SEC. 1770.

(a) In the case of information furnished under a provision of law referred to in subsection (d), neither the Secretary of Agriculture, any other officer or employee of the Department of Agriculture or agency thereof, nor any other person may-

(1) use such information for a purpose other than the development or reporting of aggregate data in a manner such that the identity of the person who supplied such information is not discernible and is not material to the intended uses of such information; or

(2) disclose such information to the public, unless such information has been transformed into a statistical or aggregate form that does not allow the identification of the person who supplied particular information.

(b) (I) In carrying out a provision of law referred to in subsection (d), no department, agency, officer, or employee of the Federal Government, other than the Secretary of Agriculture, shall require to furnish a copy of statistical information provided a person to the Department of Agriculture.

(2) A copy of such information-

(A) shall be immune from mandatory disclosure of any type, including legal process; and

(B) shall not, without the consent of such person, be admitted as evidence or used for any purpose in any action, suit, or other judicial or administrative proceeding.

(c) Any person who shall publish, cause to be published, or otherwise publicly release information collected pursuant to a provision of law referred to in subsection (d), in any manner or for any purpose prohibited in section (a), shall be fined not more than \$10,000 or imprisoned for not more than 1 year, or both.

(d) For purposes of this section, a provision of law referred to in this subsection means-

(1) the first section of the Act entitled "An Act authorizing the Secretary of Agriculture to collect and publish statistics of the grade and staple length of cotton", approved March 3, 1927 (7 U.S.C. 471) (commonly referred to as the "Cotton Statistics and Estimates Act");

(2) the first section of the Act entitled "An Act to provide for the collection and publication of statistics of tobacco by the Department of Agriculture", approved January 14, 1929 (7 U.S.C. 501);

(3) the first section of the Act entitled "An Act to provide for the collection and publication of statistics of peanuts by the Department of Agriculture", approved June 24, 1936 (7 U.S.C. 951);

(4) section 203(g) of the Agricultural Marketing Act of 1946 (7 U.S.C. 1622(g));

(5) section 526(a) of the Revised Statutes (7 U.S.C. 2204(a));

(6) the Act entitled "An Act providing for the publication of statistics relating to spirits of turpentine and resin", approved August 15, 1935 (7 U.S.C. 2248);

(7) section 42 of title 13, United States Code;

(8) section 4 of the Act entitled "An Act to establish the Department of Commerce and Labor", approved February 14, 1903 (15 U.S.C. 1516);

(9) section 2 of the joint resolution entitled "Joint resolution relating to the publication of economic and social statistics for Americans of Spanish origin or descent", approved June 16, 1976 (15 U.S.C. 1516a).

(10) section 3(e) of the Forest and Rangeland Renewable Resources Research Act of 1978 (16 U.S.C. 1642(e));or

**3. What the amendment applies to:**

FOREST AND RANGELAND RENEWABLE RESOURCES RESEARCH ACT  
Act of June 30, 1978 (P.L. 95-307, 92 Stat. 353, as amended 16 U.S.C. 1642(e))

RESEARCH AUTHORIZATION

SEC. 3(e) Forest Inventory and Analysis.—

(1) Program required.--In compliance with other applicable provisions of law, the Secretary shall establish a program to inventory and analyze, in a timely manner, public and private forests and their resources in the United States.

(2) Annual state inventory.—

(A) In general.--Not later than the end of each full fiscal year beginning after the date of enactment of this subsection, the Secretary shall prepare for each State, in cooperation with the State forester for the State, an inventory of forests and their resources in the State.

(B) Sample plots.--For purposes of preparing the inventory for a State, the Secretary shall measure annually 20 percent of all sample plots that are included in the inventory program for that State.

(C) Compilation of inventory.--On completion of the inventory for a year, the Secretary shall make available to the public a compilation of all data collected for that year from measurements of sample plots as well as any analysis made of the samples.

(3) 5 -year reports.--Not more often than every 5 full fiscal years after the date of enactment of this subsection, the Secretary shall prepare, publish, and make available to the public a report, prepared in cooperation with State foresters, that—

(A) contains a description of each State inventory of forests and their resources, incorporating all sample plot measurements conducted during the 5 years covered by the report;

(B) displays and analyzes on a nationwide basis the results of the annual reports required by paragraph (2); and

(C) contains an analysis of forest health conditions and trends over the previous 2 decades, with an emphasis on such conditions and trends during the period subsequent to the immediately preceding report under this paragraph.

(4) National standards and definitions.--To ensure uniform and consistent data collection for all forest land that is publicly or privately owned and for each State, the Secretary shall develop, in consultation with State foresters and Federal land management agencies not under the jurisdiction of the Secretary, and publish national standards and definitions to be applied in inventorying and analyzing forests and their resources under this subsection. The standards shall include a core set of variables to be measured on all sample plots under paragraph (2) and a standard set of tables to be included in the reports under paragraph (3).

(5) Protection for private property rights.--The Secretary shall obtain authorization from property owners prior to collecting data from sample plots located on private property pursuant to paragraphs (2) and (3).

(6) Strategic plan.--Not later than 180 days after the date of enactment of this subsection, the Secretary shall prepare and submit to Congress a strategic plan to implement and carry out this subsection, including the annual updates required by paragraph (2) and the reports required by paragraph (3), that shall describe in detail—

(A) the financial resources required to implement and carry out this subsection, including the identification of any resources required in excess of the amounts provided for forest inventorying and analysis in recent appropriations Acts;

(B) the personnel necessary to implement and carry out this subsection, including any personnel in addition to personnel currently performing inventorying and analysis functions;

(C) the organization and procedures necessary to implement and carry out this subsection, including proposed coordination with Federal land management agencies and State foresters;

(D) the schedules for annual sample plot measurements in each State inventory required by paragraph (2) within the first 5-year interval after the date of enactment of this subsection;

(E) the core set of variables to be measured in each sample plot under paragraph (2) and the standard set of tables to be used in each State and national report under paragraph (3); and

(F) the process for employing, in coordination with the Secretary of Energy and the Administrator of the National Aeronautics and Space Administration, remote sensing, global positioning systems, and other advanced technologies to carry out this subsection, and the subsequent use of the technologies.

#### **4. The Statute – applicable US Code:**

Ch. 55 DEPARTMENT OF AGRICULTURE

U.S.C. 7 § 2276

§ 2276. Confidentiality of information

(a) Authorized disclosure

In the case of information furnished under a provision of law referred to in subsection (d) of this section, neither the secretary of Agriculture, any other officer or employee of the Department of Agriculture or agency thereof, nor any other person may-

(1) use such information for a purpose other than the development or reporting of aggregate data in a manner such that the identity of the person who supplied such information is not discernible and is not material to the intended uses of such information; or

(2) disclose such information to the public, unless such information has been transformed into a statistical or aggregate form that does not allow the identification of the person who supplied particular information.

(b) Duty of Secretary; immunity from disclosure; necessary consent

In carrying out a provision of law referred to in subsection (d) of this section, no department, agency, officer, or employee of the Federal Government, other than the Secretary of Agriculture shall require a person to furnish a copy of statistical information provided to the Department of Agriculture.

(2) A copy of such information-

(A) shall be immune from mandatory disclosure of any type, including legal process; and

(B) shall not, without the consent of such person, be admitted as evidence or used for any purpose in any action, suit, or other judicial or administrative proceeding.

(c) Violations; penalties

Any person who shall publish, cause to be published, or otherwise publicly release information collected pursuant to a provision of law referred to in subsection (d) of this section, in any manner or for any purpose prohibited in section 1 (a) of this section, shall be or fined not more than \$10,000 or imprisoned for not more than 1 year, or both.

(d) Specific provisions for collection of information

For purposes of this section, a provision of law referred to in this subsection means-

(1) the first section of the Act entitled "An Act authorizing the Secretary of Agriculture to collect and publish statistics of the grade and staple length of cotton", approved March 3, 1927 (7 U.S.C. 471) (commonly referred to as the "Cotton Statistics and Estimates Act");

(2) the first section of the Act entitled "An Act to provide for the collection and publication of statistics of tobacco by the Department of Agriculture", approved January 14, 1929 (7 U.S. C. 501);

(3) the first section of the Act entitled "An Act to provide for the collection and publication of statistics of peanuts by the Department of Agriculture", approved June 24, 1936 (7 U.S.C. 95 1);

(4) section 203(g) of the Agricultural Marketing Act of 1946 (7 U.S.C. 1622(g));

(5) section 526(a) of the Revised Statutes (7 U.S.C. 2204(a)); (6) the Act entitled "An Act providing for the publication of statistics relating to spirits of turpentine and resin", approved August 15, 1935 (7 U.S.C. 2248);

(7) section 42 of Title 13;

(8) section 4 of the Act entitled "An Act to establish the Department of Commerce and Labor", approved February 14, 1903 (15 U.S.C. 1516);

(9) section 2 of the joint resolution entitled "Joint resolution relating to the publication of economic and social statistics for Americans of Spanish origin or descent", approved June 16, 1976 (15 U.S.C. 1516a); or



(10) section 3(e) of the Forest and Rangeland Renewable Resources Research Act of 1978 (16 U.S.C. 1642(e)); (Pub.L. 99-198, Title XVII, § 1770, Dec. 23, 1985, 99 Stat. 1657.)

1 So in original. Probably should be "subsection".

**5. Previously published policy on data release:**

Federal Register / Vol. 54, No. 203 / Monday, October 23, 1989 / Notices 43189-90

Forest Resource Inventory Statistics

AGENCY: Forest Service, USDA.

ACTION: Notice; uniform data and coding proposal.

SUMMARY: The Forest Service is proposing to improve the usefulness of its forest resource inventory information by making data available to the public in a uniform format for the entire Eastern United States. The new format would include detailed ownership codes and sample plot coordinates. This change will provide improved public access to current forest resource data collected by four research facilities in the East and improved capabilities for making comparative analyses. Public review is invited

DATE: Comments must be received in writing by December 1, 1989.

ADDRESSES: Send written comments or requests for the draft format and coding publication to F. Dale Robertson, Chief (1500)- Forest Service, USDA, P.O. Box 96090, Washington, DC 20090-6090

Comments are available for inspection in the office of Forest Inventory, Economics, and Recreation Research, 14th and Independence Avenue, SW. room 4105 between the hours of 8 a.m. and 4 p.m. Monday through Friday. To facilitate entrance into building, visitors are encouraged to call ahead (447-2747).

**FOR FURTHER INFORMATION CONTACT:**

Richard A Birdsey, Forest Inventory, Economics, and Recreation Research Staff, 202-382-9341.

SUPPLEMENTARY INFORMATION: Through its Research organization, the Forest Service conducts continuing Statewide inventories of the Nation's forest resources to ascertain trends in the extent, condition, ownership, quantity, and quality of the forest resources. These statistics and subsequent analyses are released as unit, state, regional, and national resource bulletins and forest resource reports. The statistical reports are based on data collected at sample locations across the United States. Access to original data is available to the public on data tapes or through direct electronic links to data files after the State statistical report has been transmitted for publication.

In the past, data collected at different Experiment Stations have been made available in different formats and systems. For this reason, multiregional analyses were difficult. Four Forest Service Experiment Stations, whose territories encompass the eastern United States (all states east of and including North Dakota, South Dakota, Nebraska, Kansas, Oklahoma, and Texas), have proposed a uniform format and coding system for providing data to requesters. This would allow requesters to perform their own statistical analyses for several States or geographic regions within two or more States inventoried by different Experiment Stations.

The proposed new format includes coding of ownership categories for sample plots on forest lands. Ownership categories include National Forest, Bureau of Land Management, Indian Lands, Other Federal Agencies, State, County and Municipal, Forest Industry, Farmer, Farmer Leased, Other Private-Corporate, Other Private- Individual, Other Private-Corporate Leased, and Other Private-Individual Leased. The new format also includes latitude and longitude coordinates for sample plots with an accuracy of plus or minus 100 seconds (approximately one mile).

If the new format is adopted, it would be used as new State inventories are completed, and the agency would plan to expand this service nationwide as technology and resources permit. A draft publication containing complete details of the proposed formats and coding, and information about how to obtain the data, is available for review upon request.

Dated: October 13, 1989.

George M. Leonard,

Associate Chief

[FR Doc. 89-24929 Filed 10-20-89; 8:45 am]

Last Modified: 3/26/2001

## A12.7 LANDOWNER CONTACT LETTER

United States                      Forest                      Pacific                      Forestry Sciences Laboratory  
 Department of                      Service                      Northwest                      P.O. Box 3890  
 Agriculture                                      Research                      Portland, Oregon 97208  
 \_\_\_\_\_ Station                      (503) 808-2000 \_\_\_\_\_

File Code: 4810

Date:

\_\_\_\_\_

\_\_\_\_\_

\_\_\_\_\_

\_\_\_\_\_

Dear <Salutation>:

The Pacific Northwest Research Station in Portland, Oregon, is continuing to collect basic information of forest resources in the State of \_\_\_\_\_. Forest Inventory and Analysis (FIA) Program participates in a national effort to evaluate the status and condition of our Nation's forest ecosystems. Data is collected on FIA field plots, so that we can determine the amount, condition and trends of \_\_\_\_\_'s forested resources. The data will also provide information to detect and understand changes in local and regional forest health.

A grid of permanent plots was established in the 1960's and these plots have been re-measured on a 10-year cycle. Recently, our program has undergone changes, affecting how the inventory will be conducted. Starting this year a percentage of the FIA plots in \_\_\_\_\_ will be sampled across the state each year on a 5 and 10-year cycle. Our records indicate that one of these field plots occurs on property, which you own. The legal location is: Township, Range, and Section.

We would like your permission to access your land to measure the trees and other vegetation on this plot. Our measurements will not affect any ongoing or planned management practices or activities for this particular site. The data are not identified with your name or property, nor is the legal location disclosed. Data collected on your property are combined with that from other areas and counties in \_\_\_\_\_ to provide information about resource conditions in the State of \_\_\_\_\_. Collected data are summarized, analyzed, and published in statistical and analytical reports for the United States, for \_\_\_\_\_ alone, and for various geographic areas within \_\_\_\_\_ and are available to the public.

Our field staff will visit your area between April 30th and October 1st. We have enclosed a postcard for your response. Please return it so that the crews can contact you before visiting the plot. Please indicate on the response card of any access problems, such as locked gates, or special conditions that you may require of us when working on your land. If you have any questions regarding the Forest Inventory and Analysis Program, please contact Otha Terry at (503)-808-2044, or Bob Rhoads at (503)-808-2022.

We will be happy to share the resource information we gather from your property, should you be interested. Thank you again for your cooperation in this study. Your participation is greatly appreciated.

Sincerely,

Field Crew  
 Forest inventory and Analysis / US Forest Service

Enclosure



## APPENDIX 13 QUALITY ASSURANCE/QUALITY CONTROL

### A13.1 Check Plots

#### **Objectives: Check Plots are Performed for Several Purposes:**

1. To assess the accuracy of collected data;
2. To ensure that documented field plot instructions and accuracy standards are uniformly understood and consistently followed;
3. To assess the ability of individual crew members.
4. To measure the variability of the field data.

#### **Check Plot Policies: The following policies for conducting check plots will be followed:**

1. Inspectors will attempt to “hot check” each person within the first two weeks of field work.
2. Check plots will continue during the entire season; each crew is checked multiple times throughout the field season.
3. All check plot items count equally for each person who did the plot.
4. Cold check files do not replace production plot data.

#### **Types of Check Plots:**

**Hot Check** - an informal inspection done as part of the training process. The inspector is present on the plot with the trainee and provides immediate feedback regarding data quality. Data errors are corrected. Hot checks can be done on test plots or production plots.

**Cold Check** - a formal or informal inspection done either as part of the training process, or as part of an ongoing QC program. The inspector checks completed work after a crew has turned it in. Cold checks are done on production plots only.

**Blind Check** - a formal inspection done without crew data on hand; a full re-installation of the plot for the purpose of obtaining a measure of data variability. The two data sets are maintained separately. Data errors are NOT corrected. Blind checks are done on production plots only.

#### **Check Plot Procedures:**

1. In the field, the check plotter checks all tree classifications and measurements. The check plotter or one of the crew members who originally did the plot makes all of the tree measurements during the check plot visit. These check measurements are compared to the original measurements recorded on the data recorder hardcopy. Items that do not meet accuracy standards are rechecked. Final decisions on accuracy rest with the check plotter. Errors are circled in red on the original tally sheet, and the correct value written near the circle.
2. Completing the check plot form. Field plot items on the check plot form are organized into categories based on what the items are related to. Each category is given a percentage rating based on the amount of items correct. The grading procedures give weights differently to items depending on the item's importance.

### A13.2 2005 BLIND PLOT PROTOCOL

#### **What are blind plots?**

Blind plots are plots where a second crew revisits a plot during the same season and takes a second set of measurements, but they don't have data from the initial visit of that year. It is important to remember that BLIND PLOTS ARE NOT CHECK PLOTS. They are not used to evaluate an individual's or crew's work; that is the purpose of hot and cold checks. Even if data from the two visits are different, it is not know which are correct.

Collecting a second, almost-independent set of measurements through the blind plot protocols provides an estimate of natural measurement variation. Every measurement or estimate is variable and blind plots will help quantify that variation. Such variation is expected and should not make people feel they are being judged on their

blind plot performance. From the office point-of-view, one set of data is no better than another. There is no way to tell which measurement is closer to the “true” value. Crew-people’s names are not used except to check that the same person didn’t participate in both visits.

Measurement variations stem from many sources, and can be constant or variable in nature. Constant measurement variations lead to biases within the data, while variable ones produce random variations. For example, a bias would be introduced if a tape broke, was tied back together, but continued to be read as if several tenths were not taken up by the knot. All measurements past the knot would be off by a constant amount. Random variation might occur if a person tipped the laser/clinometer to the side while measuring heights. This would inhibit accurate measurement of slope, and the calculated height would vary depending on how the laser/clinometer was operated each time.

The more carefully measurements are taken, the less chance of significant variation between measurements. But blind plots, as used in the PNW, require that no extra care be taken. In order for the blind plots to be useful, they should reflect reality. If a measurement is normally estimated or taken quickly on standard production plots, it should be done the same on the blind plot.

When you are the second crew on a blind plot (if you’re on the first visit you should not know that it is going to be a blind plot later), it is vital that you adopt the mindset that blind plots are not a check on your abilities. This is emphatically NOT a competition to see which crew collected the “best” data, because there are no “best” data in this case. No-one is right and no-one is wrong. Differences in measurements, estimates, condition class calls, etc are perfectly normal.

Data from blind plots will be used to determine range and magnitude of measurement variation for all variables. This is valuable to researchers who incorporate FIA data into their studies. The blind plot data will also be useful in measuring the sensitivity of various office-calculated values to measurement variation. Further uses of these data will be to test whether current measurement tolerances are appropriate and to determine measurement repeatability. In addition to finding the range and the most likely measurement variation magnitude, blind plot data will be used to answer many other questions, such as: Is a large-diameter tree more likely to have a larger measurement variation than a small-diameter tree?

With some exceptions (listed later) blind plots should be representative of the population of plots: they should span the range of difficulty, conditions, locations, time-of-year, etc. This allows us to apply inferences resulting from analysis of the blind plots to all plots.

### **Blind Plot Selection**

At least 15 blind plots will be randomly selected from Phase II plots per state per year by the QA Coordinator. Blind plots are randomly selected from all the Phase II plots in the current year’s panel that are going to the field. When a Co-visited plot is selected, P3 variables are measured.

**Contracted plots** will be included in the 15 randomly selected plots. The number of contracted blind plots will thus vary, but will be a proportion roughly equal to the proportion of contracted plots. To ensure more care is not taken with first visits, whenever possible the contractor should not be aware of the plot numbers before the first visit. Contractor crews should be provided with copies of the current blind plot protocols. There should be a mix of contractor/contractor and contractor/FIA blind plots.

Blind plots should be re-measured as soon as possible after the first crew’s visit. This helps avoid confounding measurement variation with variation from external influences such as harvest, fire, or seasonal change in vegetation cover.

### **State Coordinator Protocols**

The State Coordinators implement the re-measurement of blind plots from the list provided by the QA Coordinator. This includes appropriate crew assignments and scheduling assuring that re-measurement crews exclude individuals with knowledge of calls made on the first visit. Information from the first visit should be removed from the plot jacket and the directions to the plot should be copied to a new plot card.

The first crew should not know this is going to be a blind plot. Further assure that no members of the first crew go out on the second crew. Make sure the blind crew sees as little of the first crew’s work as possible. The blind crew should be unaware of the existence of more than one condition class, or if such knowledge cannot be avoided, at least unaware of the first crew’s location of the condition boundaries. The blind crew should not be able to see mortality information from the first crew.

Remind crews that with PNW blind plots, there is no “wrong” and no “right” value. Variation exists, and blind plots are there to assess it with no impact on any individual or crew. There should be no concern with proving who is “correct” on the part of either crew. The coordinator/field leader will not use blind plot data to attempt to assess the accuracy of any individual or crew. Doing so would undermine the idea that there will be no repercussions and would not be valid.

- The blind crew should not include any members of the first crew or anyone who might have detailed knowledge of the calls made on the first visit – that includes someone who edited it. QA personnel may go on a blind plot provided they encountered no detailed information about the plot this year. Data collected by QA personnel will not be treated any differently than those from a production crew.
- Blind crews should never have the first crew’s data or printout. Old plot records are OK; the first crew had these too.

**Copy Directions.** The blind crew should not come into contact with information from the first crew. The state coordinator should provide an entirely new plot card in which directions to the plot have been copied from the first crew’s plot card. The less the blind crew sees of the plot card, the less opportunity for influence.

### **Field Procedures**

**Measure Plot.** The blind plot crew makes an entirely new plot card, complete with mapping. Directions don’t have to be filled in, since they were copied. Remember to code the plot as a blind plot in the PDR by selecting the “blind” option (6) in the plot attribute prompt that appears after the hex number for a plot is entered.

Established **plot, subplot, and microplot centers** should be used, even if the blind crew does not agree with their location. Why: even though it would be useful to determine how measurements taken at different subplot locations would alter figures reported in research publications, specific data are currently needed on measurement variation for the same trees and vegetative cover for the same area.

Take **site trees** if needed – they do not have to be the same trees used by the first crew.

Take all measurements just as if the plot were being done for the first time this year. The following 3 exceptions apply:

1. The blind plot crew should not **monument** their measurements – no diameter nails, no tree number or reference tags, etc. Do not install reference-only trees. **Do not change any existing monumentation.** Because only data from the first visit will be used to compile the official inventory statistics, removing or adding tree numbers, or moving dbh nails, could greatly confuse crews at the next inventory cycle.
2. On N1 & N2, **diameter** should be taken at the point the blind plot crew thinks correct, ignoring the nail; on N3 & N4, measure diameter at nails left by previous crew. Why: there are two measurements involved with diameter – measuring 4.5’ from the base, and measuring around the tree. There can be variation in both of these. Measuring at the nail on N3 & N4 will give an estimate of one; and on N1 & N2 it will allow us to estimate the combined effects. For each tree on N1 & N2, please make a note in the tree comment field whenever diameter is measured more than 2 inches above or below the nail. Why: this will allow those trees where there was little difference in diameter measurement position to be pooled with trees where diameter was taken at the nail, if necessary.
3. On N1 & N2, place **transects** where you think they should go. On N3 & N4, use indications of where the previous transect was run (flagging at end of transect, etc) to duplicate the first crew’s transect position. Why: trying to duplicate transect positioning on 2 points might give a comparison of measurement repeatability unconfounded by transect placement with the variation caused by a different transect placement.

Trees should be bored for **age** and **growth** estimates when required by the field procedures. The previous core should not be used, because using the same core is simply a counting exercise and is not independent.

Understory **vegetation** cover should be estimated for existing vegetation only. This will confound estimation variation with trampling/time effects. If it is apparent that trampling/seasonal changes have occurred, please make a note on the plotcard for each point and rank it for each lifeform category as: low ( $\leq 25\%$  apparently altered by trampling, senescence, or growth), medium (26-50%), or high ( $> 50\%$ ).

Tree **mortality** is a rare but important event. Every effort should be made to obtain an independent assessment of mortality on the second visit. If mortality information is written on the old tree printout or tree data are written on the head of the diameter nail, the blind plot crew should not look at it to avoid biases.

**Edit and FTP Plot.** Edit and FTP the plot to the office as usual. The filename will have a B suffix versus the P suffix for a regular production plot because the blind plot code was entered into the PDR.

Remember not to change any data from either visit based on information you may have on the other. To avoid problems, the two sets of data should never be compared in the field.



## APPENDIX 14 GUIDELINES, TOLERANCE TABLES, PLOT FORMS

### A14.1 Tree Coding Guide for RECONCILE

Previous Measurement	Present Measurement	PREVIOUS TREE STATUS	PRESENT TREE STATUS	RECONCILE	Standing Dead	CAUSE OF DEATH
SAMPLE KIND 1 or 3						
	Live 1.0+DBH/DRC		1			
	Dead 5.0+ DBH/DRC		2			
SAMPLE KIND 2 (Remeasure)						
Live 5.0+ DBH/DRC	Live 5.0+ DBH/DRC	1	1			
Live 1.0-4.9 DBH/DRC on microplot	Live 5.0+ DBH	1	1			
Live 1.0-4.9 DBH/DRC on microplot	Live 1.0-4.9 DBH/DRC on microplot	1	1			
Live 5.0+ DBH/DRC	Live but shrank < 5.0 and on microplot	1	1			
Live 1 inch +	Live but land no longer qualifies as forest	1	1			
Live 5.0+ DBH/DRC	Standing dead 5.0+	1	2		1	10-80
Live 5.0+ DBH/DRC	Down dead 5.0+	1	2		0	10-80
Live 1.0-4.9 DBH/DRC on microplot	Dead 1.0-4.9 DBH/DRC	1	2		0	10-80
Live 1.0-4.9 DBH/DRC on microplot	Dead 5.0+ (standing or down)	1	2		0 or 1	10-80
Live 1.0+ DBH/DRC	Cruiser unable to locate tree due to a weather (including geologic, such as landslide) or fire event & assume tree is down dead or you can see tree and it is dead and off the plot	1	2		0	30 or 50
Live 1.0+ DBH/DRC	Cut and left in the woods	1	2		0	80
Live 1 inch +	Dead and land no longer qualifies as forest (land clearing or conversion to nonforest land use)	1	2		0 or 1	10-80
Live 1.0+ DBH/DRC	Tree removed (cut and hauled away)	1	3			80
Live 1 inch +	Gone (cut and removed?) and land no longer qualifies as forest	1	3			80

Previous Measurement	Present Measurement	PREVIOUS TREE STATUS	PRESENT TREE STATUS	RECONCILE	Standing Dead	CAUSE OF DEATH
Dead 5.0+ DBH/DRC	Dead standing 5.0 DBH/DRC	2	2		1	
Dead 5.0+ DBH/DRC	Dead down 5.0+	2	2		0	
Dead 5.0+ DBH/DRC	Dead DBH/DRC < 5.0	2	2		0	
Dead 5.0+ DBH/DRC	Cruiser is unable to locate tree due to a weather (including geologic) or fire event & assume it is down dead	2	2		0	
Dead 5.0+ DBH/DRC	Tree removed (cut and hauled away)	2	3			
Live 5.0+ DBH/DRC	Tree shrank <5.0 and NOT on microplot	1	0	5		
Live 1.0-4.9 DBH/DRC	Tree shrank <1.0	1	0	5		
Live 1.0-4.9 DBH/DRC	Live 1.0-4.9 DBH/DRC, shouldn't have been tallied—beyond 6.8—cruiser error	1	0	7		
Live 5.0+ DBH/DRC	Live 5.0+ DBH/DRC, shouldn't have been tallied –beyond 24.0—cruiser error	1	0	7		
Live 1.0+ DBH/DRC	No longer a tally species	1	0	8		
Live 1.0+ DBH/DRC	Tree moved off plot due to a geologic (i.e., slight earth movement) or weather event (i.e., hurricane) and you can still see it (Live before, live now)	1	0	6		
Live 1 inch +	Nonsampled area now	1	0	9		
Dead 5.0+ DBH/DRC	No longer a tally species	2	0	8		
Dead 5.0 DBH/DRC	Tree moved off plot due to a geologic (i.e., small earth movement) or weather event (i.e., hurricane) and you can still see the tree	2	0	6		
Dead 5 inch +	Nonsampled area now	2	0	9		
Missed live	Live 1.0+ DBH/DRC	-	1	3		
< 5.0 live	5.0+ DBH/DRC live (not on the microplot)	-	1	1		
< 1.0 live	1.0-4.9 DBH/DRC live	-	1	1		
< 1.0 live	5.0+ DBH/DRC live (on the microplot) (Through growth)	-	1	2		

Annual Inventory 2007, Appendix 14: Guidelines, Tolerance Tables, Plot Forms

Previous Measurement	Present Measurement	PREVIOUS TREE STATUS	PRESENT TREE STATUS	RECONCILE	Standing Dead	CAUSE OF DEATH
Nonsampled area before	Live 1 inch +	-	1	3		
Nonforest before	Forest now, Live 1 inch+	-	1	1		
Missed dead	Dead 5.0+ DBH/DRC	-	2	4	1	
Missed live	Dead 5.0+ DBH/DRC	-	2	3	1	10-80
< 5.0 live	5.0+ DBH/DRC dead (very rare)	-	2	1	0 or 1	10-80
Nonsampled area before	Standing Dead 5 inch+	-	2	3 or 4		
Nonforest before	Forest now, Standing Dead 5 inch+	-	2	1		

## A14.2 Tolerances

**PLOTTING LEVEL**

Sample Kind	no errors
Crew Type	no errors
QA Status	no errors
Cruiser Names	no errors
Month	no errors
Day	no errors
Year	no errors
Data Request	no errors
Trails or Roads	no errors
Straight line distance to improved road	no errors
Road access	no errors
Public use Restriction	no errors
Recreation Use	no errors
GPS unit type	no errors
Coordinate System	no errors
UTM zone	no errors
Easting UTM	+/- 140 feet
Northing UTM	+/- 140 feet
GPS Elevation	+/- 280 feet
GPS error	no errors
No. Readings	no errors
Azimuth to PC	+/- 3 degrees
Distance to PC	+/- 6.0 feet
RP Species	no errors
RP Diameter	+/- 10%
RP Azimuth	+/- 4 degrees
RP Distance	+/- 5%
RP azimuth/distance to Subplot #	no errors
Plot Card Data Items	no errors

**CONDITION LEVEL**

Condition Class Num	no errors
Condition Status	no errors
Reserve Status	no errors
Owner Group	no errors
Forest type	no errors
Stand Size Class	no errors
Regeneration Status	no errors
Tree Density	no errors
Current GLC	no errors
Owner Class	no errors
Private Owner Indus Status	no errors
Artificial Regeneration Species	no errors
Stand Age	+/-10%
Stand Structure	no errors
Disturbance 1	no errors
Disturbance Year 1	+/- 1 or 2 yrs
Disturbance 2	no errors
Disturbance Year 2	+/- 1 or 2 yrs
Disturbance 3	no errors
Disturbance Year 3	+/- 1 or 2 yrs
Hist Dist 1	no errors
Hist Dist Year 1	+/- 10 years
Hist Dist 2	no errors
Hist Dist Year 2	+/- 10 years
Hist Dist 3	no errors
Hist Dist Year 3	+/- 10 years
Treatment 1	no errors
Treatment year 1	no errors
Treatment 2	no errors
Treatment year 2	+/- 1 year
Treatment 3	no errors
Treatment year 3	+/- 1 year
Hist Treatment 1	no errors
Hist Treatment yr 1	+/- 1 year
Hist Treatment 2	no errors
Hist Treatment yr 2	+/- 1 year
Hist Treatment 3	no errors
Hist Treatment yr 3	+/- 1 year
Stumps Present	no errors
Evidence of Fire	no errors
Condition Class Aspect	+/- 20 deg
Condition Class % Slope	+/- 20 %
Condition Class Topo Position:	
1 class for code 3, 4, 5	
no errors for others	
CC Physio Class	no errors
Soil Depth	no errors
Stand Condition	no errors
Plant Association	no errors
Stockability Indicator Set	no errors
Present Non-forest Land Use	no errors

**SUBPLOT LEVEL**

Subplot Number	no errors
Sub Center Condition	no errors
Micro Center Condition	no errors
Subplot Aspect	+/- 10 deg
Subplot Slope	+/- 10 deg
Subplot Topo Position:	1 class for 3, 4, 5
no error for others	
Physio Class	no errors
Water on Subplot	no errors
Water Proximity	+/- 10%

Snow/Water Depth	+/- 0.5 ft
<b>MAPPING</b>	
Plot type	no errors
Contrast Condition	no errors
Left Azimuth	+/- 10 degrees
Right Azimuth	+/- 10 degrees
Corner Azimuth	+/- 10 degrees
Corner Distance	+/- 1.0 foot
Root Disease Map	+/- 15 %
Root Disease Severity Rating	+/- 1 class

**SITE INDEX**

Subplot #	no errors
CC List	no errors
Tree #	no errors
Azimuth	+/- 10 degrees
Horizontal Distance	+/- 5.0 feet
Species	no errors
Diameter Live Trees & Dead Trees	
w/Decay Class 1, 2	0.1 in per 20.0 "of dbh
Site Tree Length	+/- 5%
Tree Age @ DBH	+/- 5 yrs
Site Tree notes	no errors when pres

**SEEDLING COUNT (Micro Plot: 6.8 foot radius)**

Sub Number	no errors
Condition Class #	no errors
Species	no errors
Seedling Count	no errors

**VEGETATION PROFILE (24.0 foot radius)**

<b>Species Growth Habit</b>		<b>no errors</b>
Species		no errors
Species Height:	Grass/Forbs	+/- 1.0 foot
Shrub/Trees		+/- 3.0 feet
Species Cover		w/in 1 class of actual cover
Shrub Stage Dev		no error
Life Form		no error
Life Form Cover		w/in 1 class of actual cover
% Bare Soil		+/-20%
% Total Vegetation Cover		+/-20%

**SNAG DATA**

Subplot Number	no errors
CC Number	no errors
Tree Status	no errors
Lean Angle	no errors
Species	no errors
Azimuth	+/- 10 degrees
Reference Azimuth	+/- 4 degrees
Horizontal Distance:	Micro Plot
Sub Plot	+/- 1.0 foot
Annular	+/- 3.0 feet
Slope Distance	+/- 0.2 foot
Old Tree #	no errors
New Tree #	no errors
Diameter (DBH):	
All Live Trees & Dead Trees	
w/Decay Class 1,2:	0.1" / 20.0" of dbh
Dead Trees w/Decay Class 3, 4, 5:	+/- 1.0" / 20.0" of dbh
Diameter (DRC)	+/- 0.2 inch
Diameter Check	no errors
10 Year Increment	+/- 1/20" / inch
5 Year Increment	+/- 1/20" / inch
Tree Age (measured)	+/- 10%
Tree Age (estimated)	+/- 20%
Tree Age (extrapolated)	+/- 40%
5 Year Ht Growth:	Depends on height of tree
<15 ft	+/- 1.0 foot
15-35	+/- 1.0 foot
36-50	+/- 2.0 feet
>50ft	+/- 3.0 feet
Actual Length <60ft	+/- 5% True
>60f	+/- 10% True
Total Length	+/- 10% True Length
Length Method	no errors
Compacted Crown Ratio	+/- 10%
Crown Class	no errors
Remnant Tree	no errors
Mistletoe Class	+/- 1 class
Rough Cull	+/- 10%
Rotten/Missing Cull	+/- 10%
Platform Abundance	no errors
Moss Abundance	+/- 20%
Hardwood Clump	no errors
Form Class	no errors
Cavity Presence	no errors
Damaging Agent	Correct Category
Damaging Severity: Agents detected	
w/3 or less	no errors
w/4 or more	+/- 1 code

Damage Location	+/- 1 class
Damage Type	no errors
Damage Severity	no errors
Cause of Death	no errors
Stump	no errors
Snag Decay Class	+/- 1 class
Snag Reason for Disappearance	no errors
Utilization Class	no errors
<b>FUEL LOADING ON MICRO PLOT (6.8 foot radius)</b>	
Subplot Number	no errors
Live Shrubs % Cover	+/- 1 class
Dead Shrubs % Cover	+/- 1 class
Live Herbs % Cover	+/- 1 class
Dead Herbs % Cover	+/- 1 class
Litter % Cover	+/- 1 class
Live Shrubs Height	+/- 0.5 foot
Dead Shrubs Height	+/- 0.5 foot
Live Herbs Height	+/- 0.2 foot
Dead Herbs Height	+/- 0.2 foot
<b>TRANSECTS (30°, 150°, 270°)</b>	
Subplot Number	no errors
Transect: for code	no errors
for azimuth	+/- 2 degrees
Condition Class	no errors
Beginning Distance	+/- 1.0 foot
Ending Distance	+/- 1.0 foot
Slope Percent	+/- 10%
<b>COURSE WOODY MATERIAL</b>	
Subplot Number	no errors
Transect	no errors
CWM Slope Distance	+/- 1.0 foot
Species	no errors
Diameter at point of intersection:	
is piece tallied	no errors
pieces <20 in	+/- 0.2 in
pieces >20 in	+/- 10%
Diameter at Small End: pieces <20 in	+/- 0.2 in
pieces >20 in	+/- 10%
Diameter at Large End: pieces <20 in	+/- 0.2 in
pieces >20 in	+/- 10%
Total Length: Decay Class 1-4	+/- 10%
Decay Class 5	+/- 20%
Decay Class	+/- 1 class
Orientation on Slope	no errors
Is the Piece Hollow?	no errors
% of Log Charred by Fire	+/- 1 class
CWM History	no errors
<b>FINE WOODY MATERIAL</b>	
Subplot Number	no errors
Condition Class	no errors
Count of Pieces: (0.1 - 0.25)	0-50
+/- 20% of entire Plot	51-100
+/- 25% of entire Plot	100 plus
+/- 50% of entire Plot	
Count of Pieces (0.25 - 1.0)	+/- 20%
Count of Pieces (1.0 - 3.0)	+/- 20%
Reason for High Count	no errors
Residue Pile on Transect?	no errors
<b>DUFF, LITTER &amp; FUEL BED DEPTS (@ 24.0 feet)</b>	
Subplot Number	no errors
Transect	no errors
Duff & Litter Combined Depth	+/- 0.2 foot
% of Depth that is Litter -1	+/- 20%
Depth of Fuel bed -1	+/- 20%
Duff and Litter Combined Depth	+/- 0.2 foot
% of Depth that is Litter - 2	+/- 20%
Depth of Fuel bed - 2	+/- 20%
Depth and Litter Sample Taken at 1	no errors
Depth and Litter Sample Taken at 2	no errors
RESIDUE PILES (anywhere on 58.9 foot radius)	
Subplot Number	no errors
Condition Class	no errors
Pile Azimuth	+/- 10 degrees
Shape	no errors
Length 1	+/- 10%
Length 2	+/- 10%
Width 1	+/- 10%
Width 2	+/- 10%
Height 1	+/- 10%
Height 2	+/- 10%
Pile Density	+/- 20%
<b>GROUND COVER (NFL only)</b>	
Subplot Number	no errors
Transect ID	no errors
Segment ID	no errors
Ground Cover Type	no errors
Cover	+/- 5%
<b>TALLY TREES</b>	
Seedling Tally	see manual (see manual run)
<b>Trees (&lt;1")</b>	<b>no errors</b>



185.1 FT RADIUS CIRCLE

Total number of dots = 4281

One dot = 0.02% of 185.1 ft radius circle

Calculate: % of plot Area =  $\frac{\# \text{ of counted dots}}{42.81}$

Dot interval = 5 feet

Circles = 6.8, 24, 40, 58.9, 185.1 feet

58.9 FT RADIUS CIRCLE

Total number of dots = 437

One dot = 0.23% of 58.9 ft radius circle

Calculate: % of plot Area =  $\frac{\# \text{ of counted dots}}{4.37}$

24FT RADIUS CIRCLE

Total number of dots = 69

One dot = 1.45% of 24 ft radius circle

Calculate: % of plot Area =  $\frac{\# \text{ of counted dots}}{0.69}$

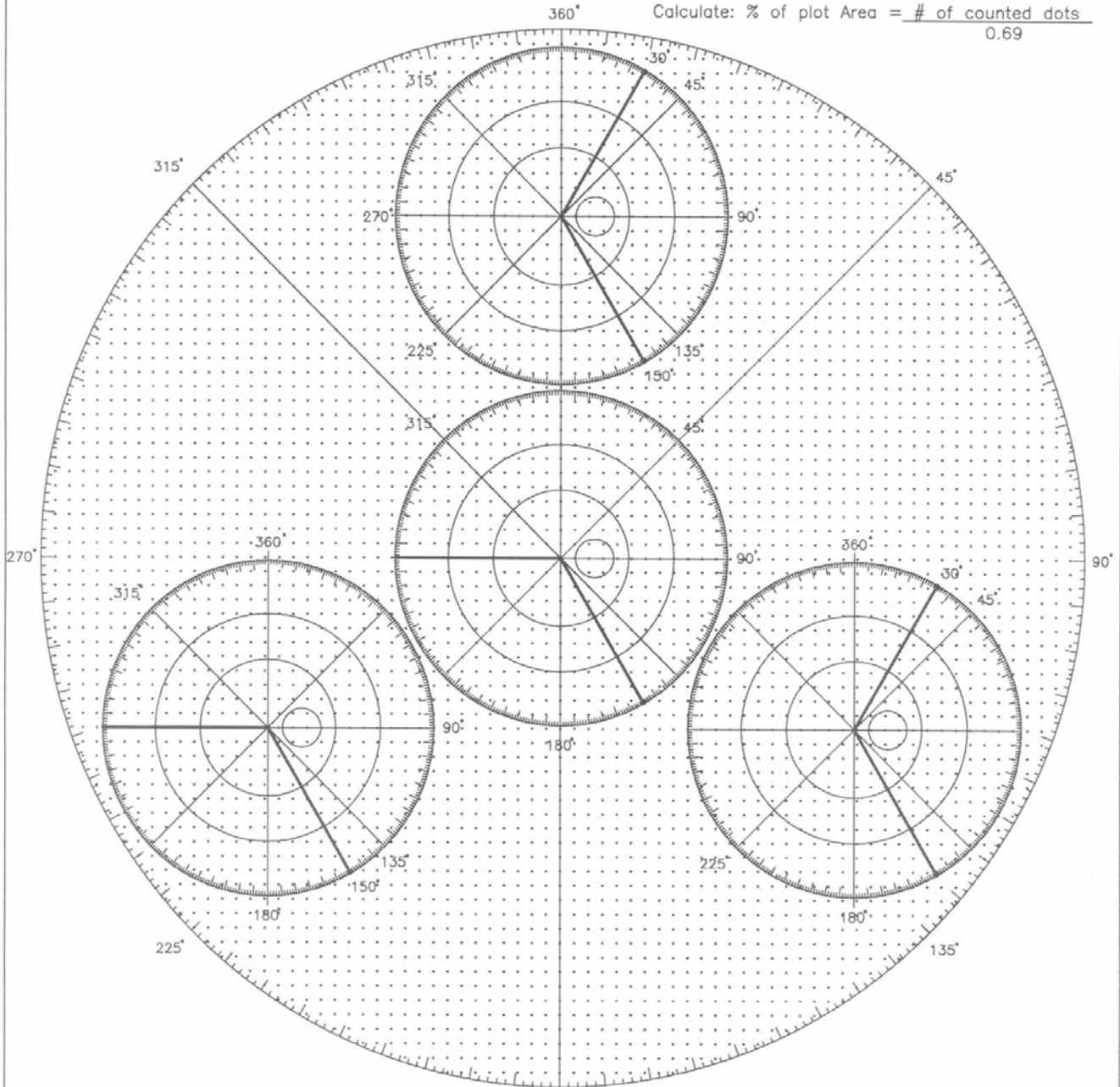

SUBPLOT #	1			2			3			4		
RADIUS	CC	24'	58.9'	CC	24'	58.9'	CC	24'	58.9'	CC	24'	58.9'
NON FOREST INCLUSION MAP												
NON FOREST INCLUSION MAP												
ROOT DISEASE MAP	X			X			X			X		
ROOT DISEASE MAP	X			X			X			X		

Leaf updated 1-30-2002

## A14.4 Plot Card Write-Up

A Plot Card Write-up provides relevant information about the plot to land owners, analysts, crew supervisors, and crew leaders. Analyst look primarily for major changes that have occurred since the previous inventory – especially changes related to Condition Class, and any anomaly in the data to be explained in writing. Crew supervisors and crew leaders review the previous plot write-up to determine level of difficulty and to anticipate access problems.

A. The plot card write-up should observe the following guidelines:

- Writing must clear and legible
- Transfer relevant information inadvertently handwritten on the Plot Jacket
- Describe tree species, stand structure, damages etc. rather than write codes
- Plot Cards are **public documents**, being scanned to electronic files. They are copied and mailed to the landowner upon request. Exclude unprofessional comments from this document.

B. The Present Condition Past Disturbance section should provide documentation for the following issues in order of priority:

### Condition Class changes

- Forest / Non-Forest (one of the most important changes to document)
- Ground Land Class
- Boundaries

### Condition Class Description

- Even if the change seem obvious from the mapping (CC1= non-forest/road)

### Reserved status

- Include name of the specific park, wilderness, monument, etc.

### Ownership change

- Land swap, purchased by park, incorrect data, etc.

### Access denial

- Written / verbal contact with owner / manager

### Inability to install any portion of the plot

- Human or environment related

### Past treatments

- From greatest impact to least impact on the site.

### Stand description

- Age; Size; Species of trees; Recent disturbance; any insect or disease issues.

### Collecting insufficient site trees

- Hazards; Age; Damages

### Hazards

- Human; Environment

### Species: trees, shrubs, forbs

- Use English or Latin names, not codes - codes change over the years

### Previous plot mortality assessment

- Disturbances / treatments affecting subplots 3, 4, or 5

### A14.5 PLOT ATTRIBUTE DATA FORM

HEX # \_\_\_\_\_ Date \_\_\_\_/\_\_\_\_/\_\_\_\_

State	..
County	...
NFS Plot Number	.....
Topographic Position	.
Plot Status	.
Plot Non-Sampled Reason	..
Sample Kind	.
PNW Plot Kind	
Horizontal Distance to Road	
Crew Leader	.....
Crew Name 1	.....
Crew Name 2	.....
Crew Name 3	.....
Crew Name 4	.....
Crew Name 5	.....
P2 / P3 Plot	.
Mortality Sub-Plots Measured	.
Date - Month	..
Date - Day	..
Date -Year	..
Crew Type	.
Special Study 2002A (Platform / Moss)	.
Landowner Data Request	.
Owner Name / Address Update	.
GPS Unit Type	2
GPS Serial #	.....
Coordinate System	2
UTM Zone	...
Easting (X) UTM	.....
Northing (Y) UTM	.....
# of Readings	...
GPS Error	...
GPS Elevation	.....
Offset Azimuth to Plot Center	...
Offset Distance to Plot Center	...
RP Species	...
RP Diameter	...
Azimuth to Sub-Plot	...
Slope Distance to Sub-Plot	...
Sub-Plot #	.



### A14.6 CONDITION CLASS ATTRIBUTES DATA FORM

HEX # \_\_\_\_\_

Date \_\_\_\_/\_\_\_\_/\_\_\_\_

Condition Class Number	1	2	3	4	5	6
Condition Class Status	.	.	.	.	.	.
Condition Non-Sampled Reason	..	..	..	..	..	..
Owner Group	..	..	..	..	..	..
Forest Type	...	...	...	...	...	...
Stand Size Class	.	.	.	.	.	.
Regeneration Status	.	.	.	.	.	.
Tree Density	.	.	.	.	.	.
Ground Land Class: Current	...	...	...	...	...	...
Owner Class	...	...	...	...	...	...
Private Owner Industrial Status	.	.	.	.	.	.
Artificial Regeneration Species	...	...	...	...	...	...
Stand Age	...	...	...	...	...	...
Stand Structure	.	.	.	.	.	.
<b>Disturbance 1</b>	..	..	..	..	..	..
Disturbance 1: Year	....	....	....	....	....	....
Disturbance 2	..	..	..	..	..	..
Disturbance 2: Year	....	....	....	....	....	....
Disturbance 3	..	..	..	..	..	..
Disturbance 3: Year	....	....	....	....	....	....
<b>Treatment 1</b>	..	..	..	..	..	..
Treatment 1: Year	....	....	....	....	....	....
Treatment 2	..	..	..	..	..	..
Treatment 2: Year	....	....	....	....	....	....
Treatment 3	..	..	..	..	..	..
Treatment 3: Year	....	....	....	....	....	....
Stumps Present	.	.	.	.	.	.
Fire Evidence	.	.	.	.	.	.
CC Physiographic Class	..	..	..	..	..	..
Soil Depth	.	.	.	.	.	.
Stand Condition	.	.	.	.	.	.
Mixed Conifer Site (CA only)	.	.	.	.	.	.
Stockability Indicator Set (OR & CA only)	.	.	.	.	.	.
Present Non-Forest Land Use						
Historical Disturbance 1	..	..	..	..	..	..
Historical Disturbance 1: Year	....	....	....	....	....	....
Historical Disturbance 2	..	..	..	..	..	..
Historical Disturbance 2: Year	....	....	....	....	....	....
Historical Disturbance 3	.	.	.	.	.	.
Historical Disturbance 3: Year	....	....	....	....	....	....
Historical Treatment: 1	.	.	.	.	.	.
Historical Treatment 1: Year	....	....	....	....	....	....
Historical Treatment 2	.	.	.	.	.	.
Historical Treatment 2: Year	....	....	....	....	....	....
Historical Treatment 3	.	.	.	.	.	.
Historical Treatment 3: Year	....	....	....	....	....	....
Plant Association Code	.....	.....	.....	.....	.....	.....

**A14.7 SUBPLOT ATTRIBUTE DATA FORM**

HEX # \_\_\_\_\_

Date \_\_\_\_/\_\_\_\_/\_\_\_\_

Sub-Plot #	N-1	N-2	N-3	N-4
Sub-Plot Center Condition	.	.	.	.
Micro-Plot Center Condition	.	.	.	.
Subplot / Macroplot Status	.	.	.	.
Sub-Plot Non-Sampled Reason	.	.	.	.
Aspect	...	...	...	...
Slope	...	...	...	...
Physiographic Class	..	..	..	..
Water Class	.	.	.	.
Water Proximity	...	...	...	...
Snow / Water Depth	..	..	..	..
Root Disease Severity Rating	.	.	.	.
% Non-Forest Inclusion (24.0' / 58.9')	./..	./..	./..	./..
Root Disease Code	..	..	..	..
% Root Disease (58.9')	..	..	..	..
Burn Assessment	.	.	.	.
Mechanical Management	.	.	.	.
Boundary #1	XXXXX	XXXXX	XXXXX	XXXXX
Plot Type	.	.	.	.
Contrasting Condition	.	.	.	.
Left Azimuth	...	...	...	...
Right Azimuth	...	...	...	...
Corner Azimuth	...	...	...	...
Corner Distance	...	...	...	...
Boundary Change	.	.	.	.
Boundary #2	XXXXX	XXXXX	XXXXX	XXXXX
Plot Type	.	.	.	.
Contrasting Condition	.	.	.	.
Left Azimuth	...	...	...	...
Right Azimuth	...	...	...	...
Corner Azimuth	...	...	...	...
Corner Distance	...	...	...	...
Boundary Change	.	.	.	.
Boundary #3	XXXXX	XXXXX	XXXXX	XXXXX
Plot Type	.	.	.	.
Contrasting Condition	.	.	.	.
Left Azimuth	...	...	...	...
Right Azimuth	...	...	...	...
Corner Azimuth	...	...	...	...
Corner Distance	...	...	...	...
Boundary Change	.	.	.	.
Boundary #4	XXXXX	XXXXX	XXXXX	XXXXX
Plot Type	.	.	.	.
Contrasting Condition	.	.	.	.
Left Azimuth	...	...	...	...
Right Azimuth	...	...	...	...
Corner Azimuth	...	...	...	...
Corner Distance	...	...	...	...
Boundary Change	.	.	.	.
Boundary #5	XXXXX	XXXXX	XXXXX	XXXXX
Plot Type	.	.	.	.
Contrasting Condition	.	.	.	.
Left Azimuth	...	...	...	...
Right Azimuth	...	...	...	...
Corner Azimuth	...	...	...	...
Corner Distance	...	...	...	...
Boundary Change	.	.	.	.

### A14.8 MICRO-PLOT ATTRIBUTES DATA FORMS

HEX # \_\_\_\_\_

Date \_\_\_\_/\_\_\_\_/\_\_\_\_

#### Micro-Plot: Tree Seedling Count [6.8 foot radius]

Species	Tree Seedling Count							
	CC#	N-1	CC#	N-2	CC#	N-3	CC#	N-4
...	.	...	.	...	.	...	.	...
...	.	...	.	...	.	...	.	...
...	.	...	.	...	.	...	.	...
...	.	...	.	...	.	...	.	...
...	.	...	.	...	.	...	.	...
...	.	...	.	...	.	...	.	...
...	.	...	.	...	.	...	.	...
...	.	...	.	...	.	...	.	...
...	.	...	.	...	.	...	.	...
...	.	...	.	...	.	...	.	...
...	.	...	.	...	.	...	.	...
...	.	...	.	...	.	...	.	...
...	.	...	.	...	.	...	.	...
...	.	...	.	...	.	...	.	...
...	.	...	.	...	.	...	.	...
...	.	...	.	...	.	...	.	...

#### Micro-Plot: Fuel-Loading [6.8 foot radius]

Sub-Plot	% Live Shrub	Height: Live Shrub	% Dead Shrub	Height: Dead Shrub	% Live Herb	Height: Live Herb	% Dead Herb	Height: Dead Herb	% Litter
N-1	..	...	..	...	..	..	..	..	..
N-2	..	...	..	...	..	..	..	..	..
N-3	..	...	..	...	..	..	..	..	..
N-4	..	...	..	...	..	..	..	..	..



















**CWM TRANSECT SEGMENTS**

[calculate total slope distance]

Sub-Plot	Transect Azimuth	Condition Class #	Beginning Distance	Ending Distance	Slope %
<b>N-1</b>	30 (P3 only)	.	...	...	..
N-1	<b>150</b>	.	...	...	..
N-1	270	.	...	...	..
<b>N-2</b>	30	.	...	...	..
N-2	<b>150</b>	.	...	...	..
N-2	270 (P3 only)	.	...	...	..
<b>N-3</b>	30	.	...	...	..
N-3	<b>150</b>	.	...	...	..
N-3	270 (P3 only)	.	...	...	..
<b>N-4</b>	30 (P3 only)	.	...	...	..
N-4	<b>150</b>	.	...	...	..
N-4	270	.	...	...	..

**RESIDUE PILES**

[anywhere on sub-plot 58.9 feet horizontal radius]

Sub-Plot	Condition Class #	Pile Azimuth	Shape	Length: 1 (ft)	Length: 2 (ft)	Width: 1 (ft)	Width: 2 (ft)	Height: 1 (ft)	Height: 2 (ft)	Pile Density	Pile Distance
.	.	::	.	::	::	::	::	::	::	::	::
.	.	::	.	::	::	::	::	::	::	::	::
.	.	::	.	::	::	::	::	::	::	::	::
.	.	::	.	::	::	::	::	::	::	::	::
.	.	::	.	::	::	::	::	::	::	::	::
.	.	::	.	::	::	::	::	::	::	::	::
.	.	::	.	::	::	::	::	::	::	::	::

**FINE WOODY MATERIALS and DUFF, LITTER, FUELBED DEPTH DATA FORMS**

HEX # \_\_\_\_\_

Date \_\_\_\_/\_\_\_\_/\_\_\_\_

FINE WOODY MATERIAL COUNT [all sub-plots - 150 degree transect only: slope distance]

Sub-Plot	Condition Class	Residue Pile?	Small:(0.1"- 0.25") [14.0'-20.0']	Medium:(0.25 - 0.9") [14.0'-20.0']	Large:(1.0" - 2.99") [14.0'- 24.0']	Reason for High Count
N-1	.	.	...	...	...	.
N-2	.	.	...	...	...	.
N-3	.	.	...	...	...	.
N-4	.	.	...	...	...	.

**DUFF, LITTER, & FUELBED DEPTHS**

[all sub-plots - all transects @ 24.0 feet: slope distance]

Sub-Plot	Transect Azimuth	Sampled	Duff Depth (0.1 inch)	Litter Depth (0.1 inch)	Fuel Bed Depth (0.1 foot)
<b>N-1</b>	30 (P3 only)	.	...	...	...
N-1	<b>150</b>	.	...	...	...
N-1	270	.	...	...	...
<b>N-2</b>	30	.	...	...	...
N-2	<b>150</b>	.	...	...	...
N-2	270 (P3 only)	.	...	...	...
<b>N-3</b>	30	.	...	...	...
N-3	<b>150</b>	.	...	...	...
N-3	270 (P3 only)	.	...	...	...
<b>N-4</b>	30 (P3 only)	.	...	...	...
N-4	<b>150</b>	.	...	...	...
N-4	270	.	...	...	...



## APPENDIX 15 GLOSSARY

**Accessible Forest Land** – Land that is within sampled area (the population of interest), is accessible and can safely be visited, and meets at least one of the two following criteria:

- (a) the condition is at least 10-percent stocked by trees (Appendix 3) of any size or has been at least 10-percent stocked in the past. Additionally, the condition is not subject to nonforest use(s) that prevent normal tree regeneration and succession such as regular mowing, grazing, or recreation activities, or
- b) in several western woodland types where stocking cannot be determined, and the condition has at least 5 percent crown cover by trees of any size, or has had at least 5 percent cover in the past. Additionally, the condition is not subject to nonforest use that prevent normal regeneration and succession such as regular mowing, grazing, or recreation activities.

**ACTUAL LENGTH** – For trees with broken or missing tops. The actual length of the tree is recorded to the nearest 1.0 foot from ground level to the highest remaining portion of the tree still present and attached to the bole. If the top is intact, this item may be omitted. Forked trees should be treated the same as unforked trees.

**Agricultural Land** – Land managed for crops, pasture, or other agricultural use. Evidence includes geometric field and road patterns, fencing, and the traces produced by livestock or mechanized equipment. The area must be at least 1.0 acre in size and 120.0 feet wide at the point of occurrence.

**Annular plot** – a circular ring with a beginning radius of 24.0 feet from subplot center and an ending radius of 58.9 feet.

**ARTIFICIAL REGENERATION SPECIES** – Indicates the predominant species that is planted or seeded in an artificially regenerated condition.

**Blind check** – a re-installation done by a qualified inspection crew without production crew data on hand; a full re-installation of the plot for the purpose of obtaining a measure of data quality. The two data sets are maintained separately. Discrepancies between the two sets of data are not reconciled. Blind checks are done on production plots only.

**Bole** – The main stem of a tree, extending from one foot above the ground to the point on the tree where DOB reaches 4 inches

**Boundary** – The intersection of two or more conditions on a subplot or microplot. Each boundary is described by recording the azimuth and horizontal distance from the subplot or microplot center to the left and right points of where the boundary intersects the perimeter of the subplot or microplot. An azimuth and distance to a corner point may also be described, if one exists. If multiple boundaries exist at a subplot, they are recorded in the order of their occurrence on the subplot, starting from north and proceeding around the compass.

**Census Water** – Rivers and streams that are more than 200 feet wide and bodies of water that are greater than 4.5 acres in size.

**Certification plot** – a plot installed by a certification candidate. It may be a training plot or a production plot. The candidate working alone installs the plot.

**Clump** – three or more live hardwood stems originating from a common root system; includes forks below DBH, but not seedling-sized sprouts or suckers.

**Cold check** – an inspection done either as part of the training process, or as part of the ongoing QC program. Normally the installation crew is not present at the time of inspection. The inspector has the completed data in-hand at the time of inspection. The inspection can include the whole plot or a subset of the plot. Discrepancies between the two sets of data may be reconciled. Cold checks are done on production plots only.

**CONDITION CLASS** – The combination of discrete landscape and forest attributes that identify and define different strata on the plot. Examples of such attributes include condition class status, forest type, stand origin, stand size, owner group, reserve status and stand density.

**Cropland** – Land under cultivation within the past 24 months, including orchards and land in soil improving crops, but excluding land cultivated in developing improved pasture.

**CROWN CLASS** – A classification of trees based on dominance in relation to adjacent trees within the stand as indicated by crown development and the amount of sunlight received from above and sides.

**Cull** – Portions of a tree that are unusable for industrial wood products because of rot, form, or other defect.

**Diameter at Breast Height (DBH)** – The diameter of the bole of a tree at breast height (4.5 feet above the ground), measured outside of the bark.

**Diameter at Root Collar (DRC)** – The diameter of a tree measured at the ground line or stem root collar, measured outside of the bark.

**Diameter Outside Bark (DOB)** – A diameter that may be taken at various points on a tree, or log, **outside** of the bark. Diameter Outside Bark is often estimated.

**Federal Information Processing Standard (FIPS)** – A unique code identifying U.S. States and counties (or units in Alaska).

**Forest Industry Land** – Land owned by companies or individuals that operate wood-using plants.

**Forest Trees** – Plants having a well-developed, woody stem and usually more than 12 feet in height at maturity.

**FOREST TYPE** – A classification of forest land based upon the trees or tree communities that constitute the majority of stocking on the site.

**GPS** – Global Positioning System. Information from this system is collected and used to determine the latitude and longitude of each plot.

**Hardwoods** – Dicotyledonous trees, usually broad-leaved and deciduous.

**Hot check** – an inspection normally done as part of the training process. The inspector is present on the plot with the trainee and provides immediate feedback regarding data quality. Data errors are corrected. Hot checks can be done on training plots or production plots.

**Idle Farmland** -- Former cropland or pasture that has not been tended within the last 2 years and that has less than 10 percent stocking with live trees.

**Improved Pasture** -- Land that is currently maintained and used for grazing. Evidence of maintenance, besides the degree of grazing, includes condition of fencing, presence of stock ponds, periodic brush removal, seeding, irrigation, or mowing.

**Inclusion** – An area that would generally would be recognized as a separate condition, except that it is not large enough to qualify. For example, a ½ acre pond within a forested stand.

**Industrial Wood** – All roundwood products, except firewood.

**Inspection crew** – a crew of qualified QC/QA individuals whose primary responsibility is the training, certification and inspection of production crews.

**Land Area** – As defined by the Bureau of the Census: The area of dry land and land temporarily or partially covered by water such as marshes, swamps, and river flood plains (omitting tidal flats below mean tide); streams, sloughs, estuaries and canals less than 200 feet in width, and ponds less than 4.5 acres in area.

**Macroplot** – A circular, fixed area plot with a radius of 58.9 feet. Macroplots may be used for sampling relatively rare events.

**Maintained Road** – Any road, hard topped or other surfaces, that is plowed or graded periodically and capable of use by a large vehicle. Rights-of-way that are cut or treated to limit herbaceous growth are included in this area.

**Marsh** – Low, wet areas characterized by heavy growth of weeds and grasses and an absence of trees.

**Measurement Quality Objective (MQO)** – Describes the acceptable tolerance for each data element. MQOs consist of two parts: a statement of the tolerance and a percentage of time when the collected data are required to be within tolerance.

**Merchantable Top** – The point on the bole of trees above which merchantable material cannot be produced. Merchantable top is 1.5 inches for western woodland species and 4.0 inches for all other species.

**Microplot** – A circular, fixed-radius plot with a radius of 6.8 feet that is used to sample trees less than 5.0 inches at DBH, as well as other vegetation.

**National Forest Land** – Federal lands which have been legally designated as National Forests or purchase units, and other lands under the administration of the Forest Service, including experimental areas and Bankhead-Jones Title III lands.



**Native American (Indian) Land** – Tribal lands held in fee, or trust, by the Federal government but administered for Indian tribal groups and Indian trust allotments. This land is considered “Private Lands”, Owner Group 40.

**Non-census Water** – Bodies of water from 1 to 4.5 acres in size and water courses from 30 feet to 200 feet in width.

**Nonforest Land** -- Land that does not support, or has never supported, forests, and lands formerly forested where use for timber management is precluded by development for other uses. Includes areas used for crops, improved pasture, residential areas, city parks, improved roads of any width and adjoining rights-of-way, power line clearings of any width, and noncensus water. If intermingled in forest areas, unimproved roads and nonforest strips must be more than 120.0 feet wide, and clearings, etc., more than one acre in size, to qualify as nonforest land.

**Nonstockable** – Areas of forest land that are not capable of supporting trees because of the presence of rock, water, etc.

**Other Federal Lands** – Federal land other than National Forests. These include lands administered by the USDI Bureau of Land Management, USDI National Park Service, USDI Fish and Wildlife Service, Department of Defense, Department of Energy, Army Corps of Engineers, and military bases.

**OWNER CLASS** -- A variable that classifies land into fine categories of ownership.

**OWNER GROUP** – A variable that classifies land into broad categories of ownership; Forest Service, Other Federal Agency, State and Local Government, and Private. Differing categories of Owner Group on a plot require different conditions.

**Phase 1 (P1)** – FIA activities done as part of remote-sensing and/or aerial photography.

**Phase 2 (P2)** – FIA activities done on the network of ground plots formerly known as FIA plots.

**Phase 3 (P3)** – FIA activities done on a subset of Phase 2 plots formerly known as Forest Health Monitoring plots. Additional ecological indicator information is collected from Phase 3 plots.

**Plot** – A cluster of four subplots that samples approximately 1/6 acre. The subplots are established so that subplot 1 is centered within the sample and the centers of subplots 2, 3, and 4 are located 120.0 feet from the center of subplot 1 at azimuths of 360, 120, and 240 degrees, respectively. Each subplot has an associated microplot and macroplot.

**PRIVATE OWNER INDUSTRIAL STATUS** – Indicates whether Private land owners own and operate a wood processing plant.

**Production crew** – a crew containing at least one certified individual. The crew is involved in routine installation of plots.

**Production plot** – a plot that belongs to the 6000-acre grid database. It may also be used for training purposes.

**REGENERATION STATUS** – A stand descriptor that indicates whether a stand has been naturally or artificially regenerated.

**Reserved Land** – Land that is withdrawn from timber utilization by a public agency or by law.

**RESERVE STATUS** – An indication of whether the land in a condition has been reserved.

**Saplings** – Live trees 1.0 to 4.9 inches DBH.

**Seedlings** – Live trees less than 1.0 DBH that are at least one foot tall.

**Site Index** – the height of a particular tree species on a given site at a specified age as determined by equation.

**Softwoods** – Coniferous trees, usually evergreen having needles or scale-like leaves.

**STAND AGE** – A stand descriptor that indicates the average age of the live trees not overtopped in the predominant stand size-class of a condition.

**STAND DENSITY** – A stand descriptor that indicates the relative tree density of a condition class. The classification is based on the number of stems/unit area, basal area, tree cover, or stocking of all live trees in the condition which are not overtopped, compared to any previously defined condition class tree density.

**STAND SIZE** – A stand descriptor that indicates which size-class of trees that are not overtopped constitutes the majority of stocking in the stand.

**State, County and Municipal Lands** – Lands owned by states, counties, and local public agencies or municipalities, or lands leased to these government units for 50 years or more.

**Stocking** – The relative degree of occupancy land by trees, measured as basal area or the number of trees in a stand by size or age and spacing, compared to the basal area or number of trees required to fully utilize the growth potential of the land; that is, the stocking standard.

**Subplot** – A circular, fixed-area plot with a radius of 24.0 feet. Each subplot represents  $\frac{1}{4}$  of the fixed plot sample unit.

**TOTAL LENGTH** – The total length of the tree, recorded to the nearest 1.0 foot from ground level to the tip of the apical meristem. For trees growing on a slope, measure on the uphill side of the tree. If the tree has a broken or missing top, the total length is estimated to what the length would be if there were no missing or broken top. Forked trees should be treated the same as unforked trees

**Training plot** – a plot established for training or certification purposes only. It does NOT belong to the 6000-acre grid database.

**Transition Zone** – An area where a distinct boundary between two or more different conditions cannot be determined.

## APPENDIX 16    IMPORTANT PHONE NUMBERS

### A16.1    PNW-FIA

	Office	Cell	Fax
PFSL front desk	503-808-2000		503-808-2020
Tammy Verhunc - AO / Accident Reporting	503-808-2032		503-808-2020
Doreen Kangas - Time	503-808-2021		503-808-2020
Carol Melvin - Travel	503-808-3135		503-808-2020
Cheryl Holt - Purchasing	503-808-2011		503-808-2020
Soorya Bateman - Mail / Leave/ FedEx	503-808-2009		503-808-2020
AMT - cell (from Data Collection cell phones)		503-708-8420	
AMT - cell (from Data Collection cell phones), possible backup		503-708-8421	
Bob Rhoads - FIA Data Collection Team Leader	503-808-2022	503-539-8811	503-808-2020
Nicole Amato - QA Coordinator	503-808-3131	503-704-9031	503-808-2020
Sarah Butler - Pacific Islands Field Coordinator	503-808-2083	503-539-9897	503-808-2020
Marc LaPine - OR/WA Field Coordinator	503-808-3126	503-704-1410	503-808-2020
Melissa Patterson - Data Collection	503-808-2087		503-808-2020
Sue Willits - FIA Program Manager	503-808-2066		503-808-2020
Scott Rash – California Field Coordinator	503-808-2081	503-539-8672	503-808-2020
Perry Colclasure - Data Manager / plot location	503-808-2054		
Chuck Veneklase - Data Recorder Programmer	503-808-2045		
Frank Neo - Data Recorder Programmer	503-808-2080		
Dale Weyermann - GIS	503-808-2042		
Ron Wanek - Programmer	503-808-2048		
Human Resources			
Patti Magallanez - HR Manager	360-891-5231		360-891-5235
Albuquerque Service Center	<a href="http://fsweb.r3.fs.fed.us/asc/bfm/">http://fsweb.r3.fs.fed.us/asc/bfm/</a>		
Vehicles			
John Gilmore - FS (WCF) Fleet Manager, Mt. Hood NF	503-668-1774		503-668-1423
Dave Hintz - GSA, Vancouver, WA	360-696-7603		360-696-7502
GSA Maintenance Center (all GSA repairs/service)	888-622-6344		
Voice Mail			
to check voice mail	800-327-4706	ext#, password#	
to call someone in the office		get into mailbox (above): 0*, ext#	
<b>Daily departure/return check</b>	<b>877-295-4271</b>	<b>Additional #'s:</b>	<b>503-295-0743</b>
EUSC Help Desk - Computer Assistance (24 Hour)	888-426-3872	<b>503-295-4277</b>	<b>503-295-0748</b>
Cell Phone unlock code	4801		
Lotus Notes mail	entra6a.fs.fed.us/webmail.nsf		

Annual Inventory 2007, Appendix 16: Important Phone Numbers

Office Address	Portland Forestry Sciences Lab 620 SW Main St, Suite 400 Portland, OR 97205	
Insects/Disease		
Karen Ripley - Entomologist (WA Dept of Nat. Resources)	360-902-1691	
Andy Eglitis - Entomologist (OR, Deschutes NF)	541-383-5701	
Ellen Goheen - Pathologist (OR, Fremont NF)	541-858-6126	
Alan Kanaskie - Pathologist (OR Dept of Forestry)	503-945-7397	
Dave Overhulser - Entomologist (OR Dept of Forestry)	503-945-7396	
Susan Frankel - Pathologist (CA)	707-562-8917	
John Kliejunas - Pathologist (CA)	707-562-8914	
Pete Angwin - Entomologist (CA, Shasta-Trinity NF)	530-242-2336	
Dave Schultz - Entomologist (CA, Shasta-Trinity NF)	530-242-2335	
Bill Woodruff - Pathologist (CA, Lassen NF)	530-252-6680	
Sheri Smith - Entomologist (CA, Lassen NF)	530-252-6667	
	209-532-3671	
John Pronos - Pathologist (CA, Stanislaus NF)	x242	
	209-532-3671	
John Wenz - Entomologist (CA, Stanislaus NF)	x323	
James Allison - Pathologist (CA, San Bernardino NF)	909-884-6634	
	x3132	
Laura Merrill - Entomologist (CA, San Bernardino NF)	909-680-1582	
Region 6 National Forest Systems Contacts		
Scott Beyer - Deschutes, Winema, Ochoco, Fremont	541-383-5519	
Jeff Reis - Mt Hood, Siuslaw, Willamette	503-668-1718	
Dolly Robison - Umatilla, Wallowa Whitman, Malheur	541-278-6471	
Dell Needham - Olympic, GP, Mt Baker Snoqualmie	425-744-3271	
Betsy Peterson - Okanogan, Colville, Wenatche	509-826-3773	
Jack Fetterman - RO	503-808-2908	
Region 5 National Forest System/Remote Sensing Lab		
Kevin Casey - R5, RSL	916-640-1252	530-305-6446
Kama Kennedy - R5, RSL	916 640-1253	

A16.2 California

**24 Hour Emergency Sherriff Dispatch Numbers by County**



<b>Mariposa</b> 209-966-3614	<b>Santa Barbara</b> 805-683-2724
<b>Mendocino</b> 707-463-40865	<b>Santa Clara</b> 408-299-2505
<b>Merced</b> 209-385-7445	<b>Santa Cruz</b> 831-471-1121
<b>Modoc</b> 530-233-4416	<b>Shasta</b> 530-245-6025
<b>Mono</b> 760-932-7549	<b>Sierra</b> 530-289-3700
<b>Monterey</b> 831-755-4451	<b>Siskiyou</b> 530-841-2900
<b>Napa</b> 707-253-4451	<b>Solano</b> 707-421-7090
<b>Nevada</b> 530-265-1172	<b>Sonoma</b> 701-565-2121
<b>Orange</b> 714-647-7000	<b>Stanislaus</b> 209-552-2468
<b>Placer</b> 530-886-5375	<b>Sutter</b> 530-822-7307

**Alameda**  
510-667-7721  
**Alpine**  
530-694-2231  
**Amador**  
209-223-6500  
**Butte**  
530-538-7322  
**Calaveras**  
209-754-6500  
**Colusa**  
530-458-0200  
**Contra Costa**  
925-646-2441  
**Del Norte**  
707-464-4191 opt 0  
**El Dorado**  
530-621-6600

**Fresno**  
559-488-3111  
**Glenn**  
530-934-6431  
**Humboldt**  
707-445-7251  
**Imperial**  
760-339-6311  
**Inyo**  
760-878-0383  
**Kern**  
661-861-3110  
**Kings**  
559-584-9276  
**Lake**  
707-263-2331  
**Lassen**  
530-257-6121  
**Los Angeles**  
Crescent Valley 818-248-3464  
Altadena 626-798-1131  
Lancaster 661-948-8466

**Madera**  
559-675-7770  
**Marin**  
415-499-7233  
**Plumas**  
530-283-6300  
**Riverside**  
951-776-1099  
1800-950-2444  
**Sacramento**  
916-874-5111  
**San Benito**  
831-636-4102  
831-636-4103  
**San Bernardino**  
909-387-8313  
**San Diego**  
858-565-5200  
**San Francisco**  
415-558-2411  
**San Joaquin**  
209-468-4400  
**San Luis Obispo**  
805-781-4550  
**San Mateo**  
650-363-4000  
**Tehama**  
530-529-7900  
**Trinity**  
530-623-8128  
**Tulare**  
559-733-6218  
**Tuolumne**  
209-533-5815  
**Ventura**  
850-654-2311 opt 1  
**Yolo**  
530-666-8920  
**Yuba**  
530-749-7777

A16.3 Oregon

**24 Hour Emergency Sherriff Dispatch Numbers by County**

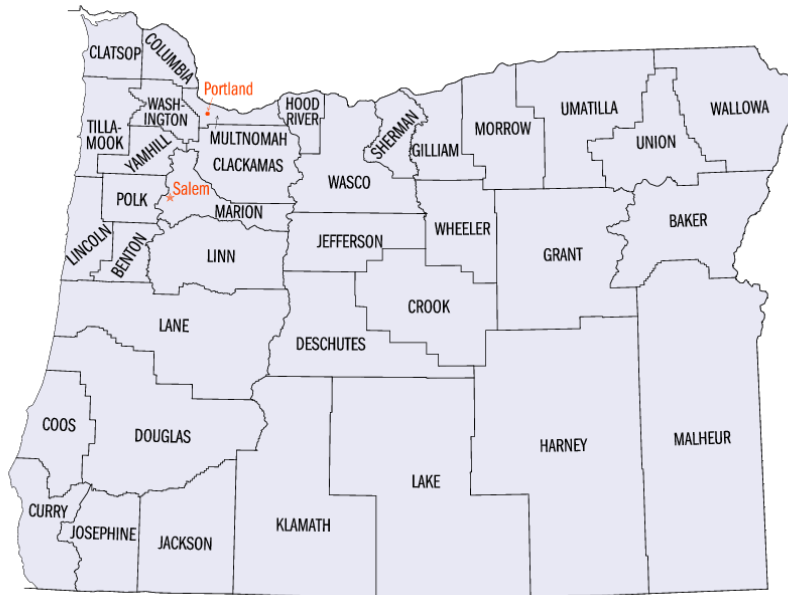

<b>Baker</b> 541-523-6415	<b>Douglas</b> 541-440-4471	<b>Lake</b> 541-947-2504	<b>Sherman</b> 541-384-2080
<b>Benton</b> 541-766-6911	<b>Gilliam</b> 541-384-2080	<b>Lane</b> 541-681-4141	<b>Tillamook</b> 503-842-3442
<b>Clackamas</b> 503-655-8911	<b>Grant</b> 541-575-0030	<b>Lincoln</b> 541-265-4231	<b>Umatilla</b> 541-966-3651
<b>Clatsop</b> 503-325-2061	<b>Harney</b> 541-573-6028	<b>Linn</b> 541-967-3911	<b>Union</b> 541-963-1017
<b>Columbia</b> 503-397-1521	<b>Hood River</b> 541-386-2711	<b>Malheur</b> 541-473-5124	<b>Wallowa</b> 541-426-3131
<b>Coos</b> 541-396-2106	<b>Jackson</b> 541-776-7206 or 7207	<b>Marion</b> 503-588-5032 1800-606-4460	<b>Wasco</b> 541-296-5454
<b>Crook</b> 541-416-0854	<b>Jefferson</b> 541-475-2201	<b>Morrow</b> 541-676-5317	<b>Washington</b> 503-629-0111
<b>Curry</b> 541-247-3242	<b>Josephine</b> 541-479-3311	<b>Multnomah</b> 503-823-3333	<b>Wheeler</b> 541-384-2080
<b>Deschutes</b> 541-388-0170	<b>Klamath</b> 541-884-6849	<b>Polk</b> 503-585-8910	<b>Yamhill</b> 503-434-6500

A16.4 Washington

**24 Hour Emergency Sherriff Dispatch Numbers by County**



<b>Adams</b> 509-659-1122	<b>Franklin</b> 509-545-3510	<b>Lewis</b> 360-740-1105	<b>Snohomish</b> 425-407-3970
<b>Asotin</b> 509-758-2331	<b>Garfield</b> 509-843-3494	<b>Lincoln</b> 509-725-3501	<b>Spokane</b> 509-456-2233 (24hr crime check line)
<b>Benton</b> 509-628-0333	<b>Grant</b> 509-762-1160	<b>Mason</b> 360-427-9670 x226	<b>Stevens</b> 509-684-2555
<b>Chelan</b> 509-663-9911	<b>Grays Harbor</b> 360-533-8765	<b>Okanogan</b> 509-422-7232	<b>Thurston</b> 360-704-2740
<b>Clallam</b> 360-417-2459	<b>Island</b> 360-679-9567	<b>Pacific</b> 360-875-9397	<b>Wahkiakum</b> 360-795-3242
<b>Clark</b> 360-696-4461	<b>Jefferson</b> 360-385-3831 opt 1	<b>Pend Oreille</b> 509-447-3151 opt 0	<b>Walla Walla</b> 509-527-1960 or 3265
<b>Columbia</b> 509-382-2518 or 1100	<b>King</b> 206-296-3311	<b>Pierce</b> 253-798-4721 opt 1	<b>Whatcom</b> 360-676-6912
<b>Cowlitz</b> 360-577-3090	<b>Kitsap</b> 360-478-0011	<b>San Juan</b> 360-378-4151	<b>Whitman</b> 509-332-2521
<b>Douglas</b> 509-663-9911	<b>Kittitas</b> 509-925-8534	<b>Skagit</b> 360-428-3211	<b>Yakima</b> 509-574-2500
<b>Ferry</b> 509-775-3132 or 3136	<b>Klickitat</b> 509-773-4547	<b>Skamania</b> 509-427-9490	





## APPENDIX 17 SUMMARY OF MANUAL CHANGES FROM 2006

Chapter 2: LOCATING AND LAYING OUT STANDARD PLOTS	
Section 2.1	Corrected name and email: Karen Waddell, kwaddell@fs.fed.us
Section 2.2	Clarification of REPLACEMENT PLOTS (LOST PLOTS): Added "The following instructions apply to Annual inventory remeasurement plots (3.4.5 SAMPLE KIND = 3)"
Section 2.3	Add: "Include the POR species and DBH and direction to the RP."
Chapter 3: PLOT DATA	
Section 3.1	Clarified Time Spent Plot (3.1.1, 3.1.2, 3.1.3): Added text to define hours recorded.
Section 3.3	Modified 3.3.11 MACRO PLOT BREAKPOINT DIAMETER: Added new item 3.3.16 Ecological Unit: Documented PDR downloaded variable Added new item 3.3.18 Day Fire reference to Special Studies. Renumbered subsequent items in this section. Deleted in 3.3.19 (old 3.3.17) Previous UTM Zone: Deleted PLGR instructions for determining UTM Zone.
Section 3.4	Clarified 3.4.1 NSF Plot Number: Added statement about checking PDR number when downloaded. Rearranged "When collected" information. Modified 3.4.5 SAMPLE KIND Code 1: from "No 4-subplot FIA (P2) plot..." to "no 4-subplot FIA (P2 or P3) plot ..." Modified 3.4.6 PNW Plot Kind: Corrected V from 1 AND 2 to 1 OR 2. For Code 2, added R4, deleted "forest health." Modified format 3.4.8 CREW TYPE: 3 is not a CORE value; removed gray fill. Correction 3.4.26 GPS ELEVATION & 3.4.27 GPS ERROR: Replaced "COORDINATE SYSTEM" with "GPS UNIT TYPE."
Chapter 4: CONDITION CLASS	
Section 4.5	Added to 4.5.2 OWNER GROUP: Added CORE OPTIONAL non-forest condition classes to "When Collected."
Section 4.6	Added to 4.6.2 OWNER CLASS: Added CORE OPTIONAL non-forest condition classes to "When Collected." Clarified 4.6.7 DISTURBANCE 1: Defined "initial forest plot establishment" and "remeasured plots" with reference to the Annual Inventory. Added note to code 00 for no disturbance Clarified 4.6.13 Historical Disturbance 1: Defined "initial forest plot establishment" and "remeasured plots" with reference to the Annual Inventory. Added note to code 00 for no Historical Disturbance Clarified 4.6.19 TREATMENT 1: Defined "initial forest plot establishment" and "remeasured plots" with reference to the Annual Inventory. Correction 4.6.36 Plant Association: Corrected to collected ONLY in California on NSF land.
Chapter 5: SUBPLOT ATTRIBUTES	
Section 5.4	Modified: 5.4.1 MICRO PLOT CENTER CONDITION: Modified When Collected to include CONDITION CLASS STATUS = 1, 2, 3 (deleted 7).
Section 5.7	Clarified/Corrected 5.7.1 Root Disease Mapping and Recording: Added to When Collected "also measured on NFS nonforest plots." Values modified from "1 to 99" to "0 to 99"
Section 5.8	Corrected 5.8 SUBPLOT DISTURBANCE: Deleted "Note: R5 chaparral plots will not be measured in 2006."
Chapter 6: DOWN WOODY MATERIAL	
Section 6.3	Corrected 6.3 TRANSECT LINE SEGMENTING: Deleted "followed by zeros in the remaining fields" for consistency with PDR.
Section 6.4	Corrected figure locations. Exchanged Figures 6-7 and 6-8. Modified 6.4.5 Species: Specified 3-digit species code

	Modified 6.4.10 Hollow: Removed Codes 0, 1 to be consistent with PDR
Section 6.5	Moved and renumbered 6.5.7 Residue Pile on Transect, a decision variable, to 6.5.3 and renumbered subsequent variables in the section.
Chapter 7: LIVE AND STANDING DEAD TREE TALLY	
Section 7.1	Modified Hectare definition to include on ALL R6 NFS land when SAMPLE KIND = 1.
Section 7.4	Modified 7.4.1 Tree Number: Changed variable name to Tree Tag Number. Added to Values: (100 to 999 in California)
	Modified 7.4.2 Previous Tree Number: Changed variable name to Previous Tree Tag Number.
	Moved 7.11.3 STANDING DEAD, a decision variable, to 7.4.7. Renumbered subsequent variables in section
	Clarified 7.4.9 SPECIES: Added "SPECIES is a 4-digit code; PNW uses only 3 digits. If PEAM3 (7211 Avocado) is encountered, code as 721 and add a tree note." Changed Field width to 3 digits.
Section 7.6	Clarified 7.6.7 CURRENT NUMBER OF STEMS: Added "live or standing dead" to qualifier.
Section 7.7	Clarified 7.7.1 10-Year Increment: Added note "Do not collect for trees bared for age at a previous visit." Added to When collected: "at the current visit."
	Modified 7.7.3 5-Year Height Growth: Modified When Collected to exclude western woodland species, as well as suppressed trees, Pacific yew, hemlocks, and hardwoods.
	Added variable 7.7.5 Tree Age Method (PNW): This is an existing PDR variable that was previously not documented in the Field Manual.
	Clarified 7.7.9 Previous Length: Renamed "Previous Actual Length." Changed wording to read "This is the tree height (Actual Length) ....." Deleted "Any change made to this field signifies an error at the time of the previous inventory."
Section 7.9	Modified: 7.9 Defoliators Severity: Added "Note: Only code for defoliation if 10% or more of the foliage over the whole tree is damaged." Added leafy mistletoe to Parasitic/Epiphytic Plants (Agent Code = 54) Added note to Sudden Oak Death: "A sample is required...."
	Modify 7.9.11 MISTLETOE CLASS: Renamed item DWARF MISTLETOE CLASS Remove reference to leafy mistletoe; makes protocol consistent with CORE variable.
	Modified 7.9.12 Rotten/Missing Cull: Updated/corrected guidelines.
Section 7.10	Modified 7.10.2 Hardwood Clump: Removed reference to western woodland trees.
Section 7.11	Moved old 7.11.3 STANDING DEAD, a decision variable, to 7.4.7. Renumbered subsequent variables in section
	Clarified 7.11.3 (old 7.11.4) Stump: Added to When Collected "and STANDING DEAD = 1 (yes)"
Section 7.12	Added 7.12.2 Special Study 2007a (Day Fire) fire Effects and Recovery: Added tree tally instructions.
Section 7.13	Modified 7.13.1 Line #: Changed item name to "Mortality Line #"
	Modified 7.13.2 Tree #: Changed item name to "Mortality Tree Tag #"
	Modified 7.13.3 Tree History: Changed item name to "Mortality Tree History"
	Corrected 7.13.4 Cause of Death: Modified When Collected to "All Tree History = 1 or 5 Added code 00 (Not dead/damaged) Added "Requires a sample when 31 (Sudden Oak Death) is coded"
Chapter 8: VEGETATION PROFILE	
Section 8.2	Modified 8.2.2 Species: Moved information about R5 and R6 weed and indicator lists to Section 8.5.
	Modified 8.2.4 Species Cover: Changed Values from 1 to 100 to 0 to 100
Section 8.3	Modified 8.3 LIFEFORM AND TOTAL VEGETATION RECORDS: Modified to list and number each individual data item (8.3.1 – 8.3.6).
	Added to 8.3.2 Percent Shrub Cover: Added note about additional data item to collect for Special Study 2007a (Day Fire).
Section 8.5	Modified 8.5 R6 INDICATOR AND WEED LIST: Renamed section R5 AND R6

INDICATOR AND WEED LISTS. Moved information from Section 8.2.2 SPECIES.	
Chapter 9: SITE INDEX	
Section 9.3	Added new item 9.3.11 Site Tree Selection Method: Documents PDR variable. Following items in section renumbered.
	Renamed 9.3.4 Tree Number: Renamed Tree Tag Number
	Added 9.3.6 to Values: "When possible" after 200' limit.
APPENDICES	
APPENDIX 1	
Sections A1.1 – A1.5	Modified/added text to correct errors and update to 2007 plots
APPENDIX 2	
Section A2.7	Inserted text – cleanup in SOD counties.
APPENDIX 3 –PLANT ASSOCIATIONS AND COUNTY:	
Section A3.6	Replaced California Plant Association guides with full citations
APPENDIX 5	
Section A5.2	Updated declinations
APPENDIX 16	
	Updated phone numbers
APPENDIX 17 – SUMMARY OF MANUAL CHANGES FROM 2006	
	Updated



**APPENDIX 18 BLANK PAGE FOR NOTES**

BLANK PAGE FOR NOTES

BLANK PAGE FOR NOTES

