

FIELD INSTRUCTIONS
FOR THE ANNUAL INVENTORY OF
WASHINGTON, OREGON, AND CALIFORNIA
2004



Forest Inventory and Analysis Program
Pacific Northwest Research Station
USDA Forest Service

FIELD INSTRUCTIONS
FOR THE ANNUAL INVENTORY OF
WASHINGTON, OREGON, AND CALIFORNIA
2004

Based on Version 2.0 of the National Core Procedures Manual

TABLE OF CONTENTS

I.	INTRODUCTION	1	white
II.	LOCATING THE PLOT	5	blue
III.	PLOT LAYOUT AND REFERENCING	11	green
IV.	PLOT ATTRIBUTES	21	grey
V.	SUBPLOT ATTRIBUTES	39	yellow
VI.	CONDITION CLASS ATTRIBUTES	63	gold
VII.	SITE INDEX	97	purple
VIII.	VEGETATION PROFILE	113	pink
IX.	TRACKABLE TREE AND SNAG SELECTION	147	white
X.	TRACKABLE TREE AND SNAG DATA	153	brown
XI.	NATIONAL TREE DAMAGE	183	brown
XII.	DOWN WOODY MATERIALS	187	grey
XIII.	GROUND COVER ON NFS LANDS	213	gold
XIV.	COORDINATES (GPS)	219	yellow
XV.	LASER 200 INSTRUCTIONS	229	salmon
XVI.	APPENDICES	235	green/white

Annual Inventory 2004
TABLE OF CONTENTS

TABLE OF CONTENTS

I. INTRODUCTION	1
A. Purposes of this manual	3
B. Organization of this manual	3
Products	3
Research topics	3
II. LOCATING THE PLOT	5
A. Landowner contact	7
Permission	7
Recording conversations with landowners	7
Data requests	7
B. Locating the plot on the ground in California, Oregon, and Washington	7
Revisited plots	7
Colocated plots	7
Plots not previously visited	7
Locating previously measured plots	7
Locating new plots	8
Colocated P2 and P3 plots in OR and WA	8
C. Plots with active logging	9
D. Denied access plots	9
E. Plot location tolerance	9
III. PLOT LAYOUT AND REFERENCING	11
A. Plot layout at the current annual inventory	13
Standard 4-subplot plot diagram	13
B. Census water, Denied access, Hazardous, and Not in the sample areas	14
C. Recognition of condition classes	14
D. Subplot numbering	14
Install N# subplots	14
E. Referencing the plot	14
1. Referencing a plot visited previously	14
2. Referencing a lost plot	15
3. Referencing plots not visited previously	15
4. An exception	15
5. Referencing an entirely nonforest plot off national forests	15
6. Referencing an entirely nonforest plot on national forests	16
7. The reference point (RP)	16
8. Referencing the plot center monument	17
9. Referencing the microplot	17
10. Route to RP	17
F. Referencing the other subplots on the standard layout	17
1. Mark subplot center	17
2. Select witness trees	17
3. Tag the witness trees	18
G. Recording witness tree data (all subplots on the standard layout)	18
1. If a tally tree or stump	18
2. If not a tally tree	18
H. Plot layout and referencing MQO	18
IV. PLOT ATTRIBUTES	21
Item 1--STATE	23
Item 2--COUNTY	23
Item 3--HEX NUMBER	25

Annual Inventory 2004
 TABLE OF CONTENTS

Item 4--NFS plot number	25
Item 5--Old PNW-FIA plot number	26
Item 6--PLOT STATUS	26
Item 7--SAMPLE KIND	26
Item 8--CORE FIELD GUIDE VERSION #.....	27
Item 9--PNW data recorder program version #.....	27
Item 10--DECLINATION.....	27
Item 11--Elevation	27
Item 12--Precipitation	27
Item 13--Hydrologic unit code	27
Item 14--Special study 2002a	28
Item 15--Special Study 2004a	28
Item 16--Special study 2004b	28
Item 17--Hectare plot?.....	28
Item 18--CREW TYPE.....	28
Item 19--QA STATUS.....	28
Item 20--Crew Leader	29
Item 21 thru 25--Crew member 1 thru 5.....	29
DATE OF INVENTORY.....	29
Item 26--MONTH	29
Item 27--DAY	30
Item 28--YEAR	30
Item 29--Date of previous inventory	30
Item 30--Remeasurement period	30
Item 31--Previous ground land class.....	30
Item 32--Landowner plot summary request	31
Item 33--Owner name/address update	32
Item 34--Topographic position	32
Item 35--STRAIGHT LINE DISTANCE TO IMPROVED ROAD.....	33
GPS COORDINATES.....	33
GPS UNIT SETTINGS, DATUM, and COORDINATE SYSTEM.....	33
COLLECTING READINGS.....	33
Item 36--GPS UNIT TYPE.....	34
Item 37--GPS SERIAL NUMBER	34
Item 38--COORDINATE SYSTEM	34
Item 39--UTM ZONE	34
Item 40--EASTING (X) UTM.....	34
Item 41--NORTHING (Y) UTM	35
Item 42--GPS ELEVATION	35
Item 43--GPS ERROR.....	35
Item 44--NUMBER OF READINGS.....	35
Item 45--GPS FILENAME (CORE OPTIONAL)	35
CORRECTION FOR "OFFSET" LOCATION	36
Item 46--AZIMUTH TO PLOT CENTER.....	36
Item 47--DISTANCE TO PLOT CENTER.....	36
Downloaded plot coordinates	36
Item 48--Previous UTM zone	36
Item 49--Previous Easting (X) UTM	36
Item 50--Previous Northing (Y) UTM.....	36
Item 51--Previous coordinates method	36
Reference point (RP) data items	37
Item 52--RP species	37
Item 53--RP diameter	37
Item 54--RP azimuth.....	37
Item 55--RP distance.....	37
Item 56--RP az/dist to subplot #	37
Item 57--Plot card data items	37
Cruiser names	37
RP description	37

Annual Inventory 2004
TABLE OF CONTENTS

Plot write up	37
V. SUBPLOT ATTRIBUTES	39
A. Subplot identification.....	41
Item 1--SUBPLOT NUMBER	41
Item 2 SUBPLOT/ANNULAR PLOT STATUS.....	41
Item 3 ANNULAR PLOT NONSAMPLED REASON	41
Item 4--SUBPLOT CENTER CONDITION.....	42
Item 5--MICROPLOT CENTER CONDITION	42
B. Physioclass information	42
Item 6--SUBPLOT ASPECT.....	42
Item 7--SUBPLOT SLOPE	43
Item 8— <i>Annular Plot</i> PHYSIOGRAPHIC CLASS	43
C. Water information	43
Item 9--WATER ON <i>SUBPLOT</i>	43
Item 10--Water proximity	45
Item 11--SNOW/WATER DEPTH	45
D. BOUNDARY REFERENCES	45
BOUNDARY DATA	46
Item 12--SUBPLOT NUMBER	46
Item 13--PLOT TYPE	46
Item 14--CONTRASTING CONDITION	47
Item 15--LEFT AZIMUTH	47
Item 16--CORNER AZIMUTH	47
Item 17--CORNER DISTANCE	47
Item 18--RIGHT AZIMUTH.....	47
Hectare plot mapping	48
Region 6 hectare plot mapping	48
Region 5 hectare plot mapping	48
Boundary mapping examples.....	48
E. Non-forest inclusions	49
1. General instructions	49
2. Downloaded estimates of non-forest inclusions.....	50
3. Estimating and recording non-forest inclusion area percentages by condition class	51
F. Root disease mapping/rating	51
1. General instructions	51
2. Downloaded estimates of root disease	52
3. Mapping root diseases	52
Western OR, Western WA, and CA (North Coast only).....	52
Eastern OR, and Eastern WA, and CA (except the North Coast).....	53
4. Guide for identifying root diseases.....	54
5. Estimating and recording root disease area percentages by condition class	54
Item 19--Root disease severity rating	54
G. SEEDLING COUNT	55
SEEDLING COUNT DATA ITEMS.....	55
Item 1--SUBPLOT NUMBER.....	55
Item 2--CONDITION CLASS NUMBER	55
Item 3--SPECIES.....	55
Item 4--SEEDLING COUNT	56
H. Mortality Assessment	56
Item 1--Line #	56
Item 2--Tree #.....	56
Item 3--Tree history	56
Item 4--Cause of Death / Damaging Agent	57
I. Subplot disturbance	57
Item 1--Burn assesment.....	57
Item 2--Mechanical management assesment	57
J. Special Study 2004a	57
Item 1--Stream Number.....	59

Annual Inventory 2004
 TABLE OF CONTENTS

Item 2--Lake?	59
Subplot Measurements	59
Item 3--Distance to stream	59
Item 4--Azimuth to Stream	59
Item 5--Slope to Stream	60
Cross Section Measurements	60
Item 6--Active Width	60
Item 7--Active Width Maximum Depth	61
Item 8--Canopy Cover	61
Lower-most Cross Section Measurements	61
Item 9--Perennial/Seasonal	61
Item 10--Slope	62
Item 11--Dominant Channel Bed Type	62
VI. CONDITION CLASS ATTRIBUTES	63
Item 1--CONDITION CLASS NUMBER	65
CONDITION CLASS STATUS	65
Item 2--CONDITION CLASS STATUS	65
Instructions for determining condition classes differing in condition class status:	66
Condition class status definitions:	68
1. Accessible forest land	68
2. Nonforest land	70
3. Noncensus water	71
4. Census water	71
Item 3--CONDITION NONSAMPLED REASON	71
CONDITION CLASS DEFINING (DELINEATION) VARIABLES for accessible forest land:	72
Item 4--RESERVED STATUS	75
Item 5 --OWNER GROUP	75
Item 6--FOREST TYPE	75
Item 7--STAND SIZE CLASS	76
Item 8--REGENERATION STATUS	77
Item 9--TREE DENSITY	77
NON-DELINEATING (ANCILLARY) VARIABLES for accessible forest land	78
Item 10--Current Ground Land Class (GLC)	78
Item 11--OWNER CLASS	79
Item 12--PRIVATE OWNER INDUSTRIAL STATUS	80
Item 13--ARTIFICIAL REGENERATION SPECIES	81
Item 14--STAND AGE	81
Item 15--Stand structure	82
Item 16--DISTURBANCE 1	83
Item 17--DISTURBANCE YEAR 1	84
Item 18--DISTURBANCE 2	84
Item 19--DISTURBANCE YEAR 2	84
Item 20--DISTURBANCE 3	84
Item 21--DISTURBANCE YEAR 3	84
Item 22--Historical disturbance 1	84
Item 23--Historical disturbance year 1	84
Item 24--Historical disturbance 2	84
Item 25--Historical disturbance year 2	84
Item 26--Historical disturbance 3	85
Item 27--Historical disturbance year 3	85
Item 28--TREATMENT 1	85
Item 29--TREATMENT YEAR 1	86
Item 30--TREATMENT 2	86
Item 31--TREATMENT YEAR 2	86
Item 32--TREATMENT 3	86
Item 33--TREATMENT YEAR 3	87
Item 34--Historical treatment 1	87
Item 35--Historical treatment year 1	87

Annual Inventory 2004
TABLE OF CONTENTS

Item 36--Historical treatment 2	87
Item 37--Historical treatment year 2	87
Item 38--Historical treatment 3	87
Item 39--Historical treatment year 3	87
Item 40--Stumps present	87
Item 41--Evidence of fire	87
Item 42-- <i>CONDITION CLASS</i> <i>PHYSIOGRAPHIC CLASS</i>	88
Item 43--Soil depth	88
Item 44--Stand condition	88
Item 45--Plant association	89
Washington Plant Association Guides:	90
Oregon Plant Association Guides:	91
California Plant Association Guides:	93
Item 46--Mixed conifer site	93
Item 47--Stockability indicator set	93
Mapping (condition class defining) variables for nonforest land conditions:	94
Determining condition classes within nonforest land:	94
Item 48-- <i>PRESENT NONFOREST LAND USE</i>	94
VII. SITE INDEX	97
A. Introduction	99
B. Site trees	99
General instructions	99
Previously visited plots	100
New plots	100
C. Selecting site tree species	101
General instructions	101
Hierarchy of method selection "How to Decide Method"	101
King's selection method	101
Primary selection method, Conifers	102
Mixed conifer selection method	103
Site Descriptions	103
D. Site tree data variables	104
Item 1--Site tree number (#)	104
Item 2--SUBPLOT NUMBER (SUB PL)	104
Item 3--CONDITION CLASS LIST (CC)	104
Item 4--Tree number (TRN)	104
Item 5--AZIMUTH (AZ)	105
Item 6--HORIZONTAL DISTANCE	105
Item 7--SPECIES (SPC)	105
Item 8--DIAMETER (DIAM)	105
Item 9--SITE TREE LENGTH (HT)	105
Item 10--TREE AGE AT DIAMETER (BH AGE)	105
Item 11--Site Index (SI)	106
Item 12--SITE TREE NOTES	106
E. Site trees: post-field review	106
F. Stockability Indicators for Oregon	106
G. Oregon Stockability discount factor	107
H. Stockability indicators for California	108
Ecological Unit 1	108
Ecological Unit 2	109
Ecological Unit 3	109
Ecological Unit 4	110
Ecological Unit 5	110
Ecological Unit 6	110
Ecological Unit 7	111
Ecological Unit 8	111
VIII. VEGETATION PROFILE	113

Annual Inventory 2004
 TABLE OF CONTENTS

A. Vegetation plot design	115
B. Species records	115
Is it a tree or a shrub?	115
1. Species Growth habit	116
2. Species	116
R5 Weed list	117
3. Species Height	118
4. Species Cover	118
5. Stage of shrub development	121
C. Lifeform and total vegetation records	121
1. Lifeform	121
2. Lifeform cover	121
3. Percent bare soil	121
4. Percent total vegetation cover	122
D. Collection and identification of unknown plants	122
E. R6 indicator and weed lists	122
1. NW Oregon	123
2. SW Oregon	124
3. Central Oregon	128
4. NE Oregon	131
5. NW Washington	136
6. SW Washington	140
7. NE Washington	143
F. Literature cited	146
IX. TRACKABLE TREE AND SNAG SELECTION	147
A. Introduction	149
B. Determining if a tree/sapling/seedling is selected on a fixed-radius plot	149
C. Trackable tree and snag selection	149
D. Seedling requirements	150
E. Tree and snag selection MQO	151
X. TRACKABLE TREE AND SNAG DATA	153
Data recording	155
Item 1--Line number (LINE #)	155
Item 2--TREE RECORD NUMBER	155
Item 3--SUBPLOT NUMBER (Sub Pl)	155
Item 4--CONDITION CLASS NUMBER (Cc)	155
Item 5--PRESENT TREE STATUS (STAT)	156
Item 6--SPECIES (SPC)	157
Item 7--AZIMUTH (AZM)	157
Item 8--HORIZONTAL DISTANCE (HDIST)	157
Item 9--Slope distance (SDIST)	158
Item 10--Previous tree number (OLD TRN)	158
Item 11--Tree number (TRN)	158
Item 12--DIAMETER (DIAM)	158
DIAMETER AT BREAST HEIGHT (DBH)	159
DIAMETER AT ROOT COLLAR (DRC)	163
Item 13--DIAMETER CHECK (CHK)	164
Item 14--10-Year increment (10-YR INC)	164
Item 15--5-Year increment (INC 5-YR)	165
Item 16--Tree age (AGE)	165
Item 17--5-Year height growth (5-YR HT)	167
Item 18--ACTUAL LENGTH (ACT)	167
Item 19--TOTAL LENGTH (TOT)	167
Item 20--LENGTH METHOD (METH)	168
Item 21--COMPACTED CROWN RATIO (CR)	168
Item 22--CROWN CLASS (C)	169
Item 23--Remnant tree	170

Annual Inventory 2004
 TABLE OF CONTENTS

Item 24--MISTLETOE CLASS (M)	170
Item 25--ROUGH CULL (RUF)	171
Item 26--ROTTEN/MISSING CULL (ROT)	172
Item 27--Platform abundance (PLAT)	173
Item 28--Moss abundance (MOSS)	174
Item 29--Hardwood clump (CL)	174
Item 30--Form class (FORM)	174
Item 31--Cavity presence (USE)	175
Items 32 through 37--PNW Damaging agent/severity (Agt, S)	175
Items 38 through 43--TREE DAMAGE (Dam, Loc, Sev)	179
Item 44--CAUSE OF DEATH (COD)	179
Item 45--Stump (STUMP)	179
Item 46--SNAG DECAY CLASS (DECAY)	180
Item 47--Snag reason for disappearance (DIS)	181
Item 48--UTILIZATION CLASS (UTL)	181
Item 49--TREE NOTES (NOTE)	182
XI. NATIONAL TREE DAMAGE	183
XII. DOWN WOODY MATERIALS	187
A. Introduction	189
B. Definition of down woody materials	189
C. Locating and establishing line transects	190
D. Transect line segmenting	191
Item 1--SUBPLOT NUMBER	192
Item 2--TRANSECT	192
Item 3--CONDITION CLASS NUMBER	192
Item 4--BEGINNING DISTANCE	192
Item 5--ENDING DISTANCE	193
Item 6--SLOPE PERCENT	193
E. Sampling Methods for coarse woody debris (CWD)	193
F. Marking CWD	196
G. Recording procedures for CWD	196
Item 1--SUBPLOT NUMBER	196
Item 2--TRANSECT	196
Item 3--CWD SLOPE DISTANCE	196
Item 4--CWD DECAY CLASS	197
Item 5--SPECIES	197
Item 6--DIAMETER AT POINT OF INTERSECTION	199
Item 7--DIAMETER AT THE SMALL END	199
Item 8--DIAMETER AT THE LARGE END	199
Item 9--CWD TOTAL LENGTH	199
Item 10--HOLLOW	200
Item 11--Percent of log charred by fire (CHARR)	200
Item 12--CWD history	201
H. Sampling methods for fine woody debris (FWD)	201
Item 1--SUBPLOT NUMBER	202
Item 2--CONDITION CLASS NUMBER	202
Item 3--SMALL FWD COUNT	202
Item 4--MEDIUM FWD COUNT	202
Item 5--LARGE FWD COUNT	203
Item 6--HIGH COUNT REASON	203
Item 7--RESIDUE PILE ON TRANSECT	203
I. Duff, litter, and fuelbed depth measurements	203
Item 1--SUBPLOT NUMBER	205
Item 2--TRANSECT	205
Item 3--DUFF, LITTER, AND FUELBED SAMPLE	205
Item 4--DUFF DEPTH	205
Item 5--LITTER DEPTH	205

Annual Inventory 2004
 TABLE OF CONTENTS

Item 6--FUELBED DEPTH	206
J. Fuel loading on the Microplot	206
Item 1--SUBPLOT NUMBER	207
Item 2--LIVE SHRUB PERCENT COVER	207
Item 3--LIVE SHRUB HEIGHT	207
Item 4--DEAD SHRUBS PERCENT COVER	207
Item 5--DEAD SHRUBS HEIGHT	208
Item 6--LIVE HERBS PERCENT COVER	208
Item 7--LIVE HERBS HEIGHT	208
Item 8--DEAD HERBS PERCENT COVER	208
Item 9--DEAD HERBS HEIGHT	209
Item 10--LITTER PERCENT COVER	209
K. Sampling residue piles.....	209
Selection instructions	209
Item 1--SUBPLOT NUMBER	210
Item 2--CONDITION CLASS	210
Item 3--PILE AZIMUTH	210
Item 4--SHAPE	210
Item 5--PILE LENGTH 1.....	211
Item 6--PILE LENGTH 2.....	211
Item 7--PILE WIDTH 1	211
Item 8--PILE WIDTH 2	211
Item 9--PILE HEIGHT 1.....	211
Item 10--PILE HEIGHT 2.....	211
Item 11--PILE DENSITY.....	212
Item 12--Horizontal Distance to Pile	212
XIII. GROUND COVER ON NFS LANDS	213
Ground cover measurements	215
Item 1--Subplot number (SUB PL)	215
Item 2--Transect (T)	215
Item 3--Segment ID	215
Item 4--Ground cover type	215
Item 5--Cover	216
XIV. COORDINATES (GPS).....	219
A. Overview	221
B. When and where to collect readings	221
C. Recording GPS information.....	221
D. GPS keypad layout and commands	221
GPS keypad commands.....	222
E. GPS setup options.....	223
F. Operating the GPS on plot.....	223
G. Collecting coordinates away from plot center	225
H. Waypoints (Advanced GPS use).....	226
Creating a waypoint (when coordinates are given).....	226
Marking (storing) your current location.....	226
I. Navigating with the PLGR (Advanced GPS use).....	226
K. Batteries.....	227
XV. LASER 200 INSTRUCTIONS	229
A. Overview	231
B. Basic operation	231
C. Settings.....	231
D. Filter and Reflectors	232
E. Distances and % slope	232
F. Tree heights	232
G. Gates	232

Annual Inventory 2004
 TABLE OF CONTENTS

H. Cumulative distances	233
XVI. APPENDICES	235
APPENDIX 1 -- R6 NATIONAL FOREST PLOTS - SPECIAL RULES.....	237
A. Hectare plot	237
B. Plot installation on nonforest condition classes	237
C. Ground Cover on NFS lands	237
D. Previous R6 rules for plot installation ('Old' R6 plot).....	237
Primary Sample Unit Establishment.....	237
PSU Location ('Old' R6 plot)	237
Stake Position Installation ('Old' R6 plot).....	238
Stake Position Reference (SPR) ('Old' R6 plot).....	239
Orange Tags ('Old' R6 plot)	240
Subplot Layout ('Old' R6 plot)	240
APPENDIX 2 -- R6 OFF-NATIONAL FORESTS	241
A. Background: plot layout at previous Washington and Oregon inventories.....	241
Inventory design	241
Washington	241
All Occasions.....	241
Oregon.....	241
Occasion 1.....	241
Occasion 2.....	241
Occasion 3.....	241
Occasion 4.....	242
Occasion 5.....	242
Forest Health Monitoring Program	242
B. Products.....	242
C. Research topics.....	242
D. Previous plot layouts	242
E. Additional sources of documentation.....	245
F. Oregon plot completion.....	245
APPENDIX 3 -- R5 NATIONAL FOREST PLOTS - SPECIAL RULES.....	247
A. Hectare plot	247
B. Plot installation on nonforest condition classes	247
C. Ground cover on NFS lands	247
D. Mortality assessment.....	247
E. Monumenting within wilderness areas in Region 5	247
F. R5 Chaparral Procedures	248
G. R5 National Forest and Ranger District location information	250
H. Region 5 National Forest Contacts for FIA.....	253
I. Previously used procedures and codes in the R5 survey.....	253
R5 National Forest and Ranger District Codes.....	253
R5 Past Plot Design	255
Region 5 FIA Program Species Codes and the current PNW equivalent.....	257
R5 Tree Type Measurement Codes.....	258
Previous R5 plot measurement process. (Sequencing and methodology).....	258
APPENDIX 4 -- R5 OFF NATIONAL FORESTS	263
A. The Inventory of California.....	263
Background.	263
Inventory Design	263
Forest Health Monitoring Program	263
Additional sources of inventory documentation.	263
History of Survey in CA, all Occasions:.....	264
B. PNW Past Occasion Plot layout	264

Annual Inventory 2004
TABLE OF CONTENTS

C. PNW Tree History Codes and definitions from the previous inventory (Oc3).....	264
D. Sudden Oak Death (SOD) Syndrome	265
APPENDIX 5 -- SLOPE CORRECTION TABLE.....	267
APPENDIX 6 -- DETERMINATION OF STOCKING VALUES FOR LAND USE CLASSIFICATION.....	269
APPENDIX 7 -- TREE SPECIES LISTS	279
APPENDIX 8 -- FOREST TYPE CODES	287
APPENDIX 9 -- COUNTY and PLANT ASSOCIATION KEY	291
Washington	291
Oregon	293
California	298
APPENDIX 10 -- METRIC EQUIVALENTS AND AIDS	299
APPENDIX 11 -- HELLO LETTER/DATA CONFIDENTIALITY	301
APPENDIX 12 -- INTERIM LOCATION CONFIDENTIALITY POLICY.....	303
Summary of FIA privacy (confidentiality) policy	303
Final Interim Privacy Policy	306
Confidentiality Certification.....	308
Sample Memorandum of Understanding	311
New Legislation on privacy for FIA data and information	313
APPENDIX 13 -- LANDOWNER CONTACT LETTER.....	317
APPENDIX 14 -- LIABILITY LETTER	319
APPENDIX 15 -- GLOSSARY.....	321
APPENDIX 16 -- CHECK PLOTS.....	323
APPENDIX 17 -- INSECT AND DISEASE KEYS	325
APPENDIX 18 -- TREE VOLUME TABLES.....	327
APPENDIX 19 -- SAMPLE PLOT FORMS.....	329
APPENDIX 20 -- INDEX	345
APPENDIX 21 -- IMPORTANT PHONE NUMBERS	347
APPENDIX 22-- SUMMARY OF MANUAL CHANGES FROM 2003.....	349
APPENDIX 23 -- BLANK PAGE FOR NOTES	353

Annual Inventory 2004
TABLE OF CONTENTS

Annual Inventory 2004
TABLE OF CONTENTS

I. INTRODUCTION

TABLE OF CONTENTS

I. INTRODUCTION	1
A. Purposes of this manual	3
B. Organization of this manual	3
Products	3
Research topics.....	3

I. INTRODUCTION

This manual documents the field procedures by the Forest Inventory and Analysis Program (FIA) in the 2004 annual inventory of Oregon, Washington, and California.

FIA, a program within the Pacific Northwest Research Station (PNW), USDA Forest Service, is one of five Forest Inventory and Analysis work units across the United States. PNW-FIA is responsible for inventorying the forest resources of Alaska, California, Hawaii, Oregon, and Washington.

A. Purposes of this manual

This manual serves two purposes, to:

- instruct field personnel in how to locate and measure field plots in the 2004 annual inventory of Oregon, Washington and California.
- document the field procedures, methods, and codes used in the inventory.

B. Organization of this manual

This manual is structured primarily for use by field personnel. Each chapter corresponds either to a separate function that must be performed in locating and measuring a field plot, or to a particular aspect of data recording that must be completed.

The procedures in this manual are ordered to coincide as much as possible with the order in which field data items are collected and entered into the field data recorder. Some procedures and codes are repeated in multiple chapters of the manual to minimize the need to refer to additional chapters while collecting data in the standard order.

This manual incorporates the field data collection procedures of the Forest Inventory and Analysis National Core Field Guide. Instructions in shaded text, and data items in all capital letters describe data items or field procedures that are a part of that guide. Several of those items are still under development, or have unresolved issues at the time of this printing. Temporary regional adjustments are noted in *italic font* within the shaded text. Portions of this manual which are not shaded are regional variables or procedures which supplement the national core data.

Background information about past inventories in Oregon, California, Region 6 National Forests, and Region 5 National Forests can be found in respective sections in the appendices.

Information that is infrequently used or that is included only for documentation is in the appendices at the end of this manual. A glossary and an index are provided for quick reference.

Products

PNW-FIA provides information needed by resource planners, policy analysts, and others involved in forest resource decision-making. Data collected in PNW-FIA inventories is summarized, interpreted, analyzed, and published in statistical and analytical reports of national, state, and subregional scope. PNW-FIA publishes information on area by forestland and owner classes and by degree of urbanization; land use change; timber volume, growth, mortality, and removals; potential forest productivity; opportunities for silvicultural treatment; and kind and area of wildlife habitats. PNW-FIA also provides data to answer questions about forest resources.

Research topics

The data collected in these inventories represent a wealth of information for both applied and basic questions concerning forest ecosystems. Topics include: the distribution of plant species and their relationship to environment, the incidence of insects and disease in relation to forest type and condition, changes in forest structure in productivity due to disturbance, and improved prediction of forest growth and development on different sites and in response to management.

II. LOCATING THE PLOT

TABLE OF CONTENTS

II. LOCATING THE PLOT	5
A. Landowner contact	7
Permission	7
Recording conversations with landowners	7
Data requests	7
B. Locating the plot on the ground in California, Oregon, and Washington	7
Revisited plots	7
Colocated plots	7
Plots not previously visited	7
Locating previously measured plots	7
Locating new plots	8
Colocated P2 and P3 plots in OR and WA	8
C. Plots with active logging	9
D. Denied access plots	9
E. Plot location tolerance	9

II. LOCATING THE PLOT

A. Landowner contact

Permission

Written or verbal landowner permission must be obtained before a plot is visited. This responsibility lies with the field coordinator who may delegate contacting the landowner to the field crew.

In preparing for the field season, PNW-FIA sent each non-industrial private landowner with a plot on their land a letter that asked permission to visit and measure the plot. If the owner responded, a postcard with their response is in the plot jacket. Owners of large land areas--primarily private timber companies and public agencies--are contacted individually; access information for these plots will be provided by the crew coordinator or will be included in the plot jacket.

Recording conversations with landowners

Include a record of each conversation with a plot landowner on the Ownership Contact form. While not a part of the official plot record, this information will document that permission was obtained, assist in accessing the area for check-plots, and possibly aid the field crew during a future inventory.

Ask landowners if they can confirm the dates of any disturbance (usually harvesting) on the plot since the previous visit; record this date on the Plot Attribute Record. Record any special circumstances about plot accessibility--such as locked gates or washed-out roads on the Plot Record.

Data requests

Plot specific data is released only to the legal owner of the plot area. Requests for photocopies of the field data sheets, summarized plot data, and for copies of future publications based on information collected in this inventory should be noted in Item 32 of the Plot Attribute section of the field data. Copies of the plotcard cannot be given to landowners because it can reveal confidential plot location information. Current plot data will generally be sent to the owner after the field season is completed and plots are returned to the office. If the landowner desires, the crew may provide photocopies of plot data immediately after collection.

Any additional data requests should be referred to the client request person in the Portland office:

Otha Terry	phone: (503) 808-2044
Portland Forestry Sciences Lab	email: oterry@fs.fed.us
P.O. Box 3890	
Portland, OR 97208	

B. Locating the plot on the ground in California, Oregon, and Washington

Revisited plots

The plot location is pinpricked and circled on the old photos. The plot number is marked in the upper right-hand corner on the front of the old photo, and on the backside near the circled pinprick. The plot number is also marked on the upper right-hand corner of the new (un-pinpricked) photos. For plots visited previously, the previous plot cards have a section "Route to RP" which may provide information useful for locating the plot.

Colocated plots

A subsample of field plots have been visited by Forest Health Monitoring (P3) crews. These plots were established using the 4-subplot design and will have detailed current information on finding the plot, and will usually have GPS coordinates downloaded/printed in the Plot Attribute record. See the section on WA and OR colocated plots below.

Plots not previously visited

These plots will have new aerial photos with the field grid location pinpricked on them. Some plots may also have coordinates obtained by digitizing USGS topographic maps or by some other means.

Locating previously measured plots

When revisiting established plots, use both new and old photos to proceed to the plot area. It is often easier to use the new photos to arrive at the general location and the photos from previous inventories to find the exact location of the plot. It is generally easier to locate an established plot by heading directly to the plot rather than to the Reference Point (RP). The reason: the RP is a single tree with a couple of tags, whereas within the plot area are several to many trees with reference tags, tree numbers and/or diameter nails; in short, more "signs" to detect. In

searching out the plot, you may find a tagged/numbered tree on one of the subplots--use the plot cards from previous visits to determine which subplot you are on.

The RP tree has square aluminum tags on two sides of the tree at 6 feet above ground line, and one square aluminum tag below stump height facing towards the field grid location. If needed, travel notes, remarks, and a description of the RP trees can be found on the front of the previous plot cards and on the back of the previous photos. Before beginning the traverse from the RP to the plot, check the photos to see if the azimuth and distance seem reasonable. Some photos will be marked with a point-of-departure (POD). They are usually near a road and indicate how the crew arrived at the plot area.

If you have difficulty finding an established plot, follow these steps:

1. Return to the last known point on your route into the plot. Plan a route to the pinpricked field grid location; divide the route into stages with an identifiable physical feature at the end of each stage that you can identify on the photos and can find and confirm on the ground. Proceed stage by stage, never embarking on the next stage until you know without a doubt that you have identified the endpoint of the previous stage. The endpoint on the last stage is the pinpricked location with its witnessed trees.
2. If you tracked your way into the plot area but you don't find any signs of the plot, look for stream confluences, ridges, openings, groups of large trees, old skid roads, large snags etc. on the ground, to reconfirm without a doubt that you are at the pinpricked location.
3. Still no plot? Try to locate the area that previous crews might have been when they thought they were at the pinpricked location. Check the previous plot card for information such as:
 - a) Remarks that provide insight on plot location. For example: "Point center moved back 20 feet on same azimuth to agree with photo pinprick."
 - b) Stand type and size of trees. If the plot is in large sawtimber stand of fir, the crew would know they were off if they were in a poletimber stand of pine.
 - c) The size and species of the RP and subplot 1 witness trees.
 - d) Direction of travel from the RP--it could be 180 degrees off.
 - e) Any other indicator such as slope and aspect.

Locating new plots

1. New plots should all have the field grid location pinpricked on photos (either new photos or older occasion photos) prior to a field visit. If new NAPP photos have not been pinpricked, transfer the pinprick from prior occasion photos in the field. Plot jackets may also contain a USGS quad map printout showing the approximate plot location to aid in photo use. Some plots may also contain a digital orthophoto printout, which can be used as an aid in plot center location. Locate the plot using photo navigation to locate the pinpricked location in the field. GPS units may be used as aids to reach plot vicinity, but photos should be used to establish plot center and confirm location. When you reach the point you believe to be the pinpricked location, carefully check the pinpricked field grid location on the new photos against the surrounding terrain and pattern of tree crowns and vegetation to confirm that the pinpricked location on the photo and your location on the ground are the exact same spot. The pinprick on the photo is always the first choice in determining plot center location. If the pinprick differs from the location shown on the USGS quad printout or the coordinates, assume that the photo pinprick is the correct field grid location and install the plot in this location. If location on the photo and the USGS quad printout differ substantially (i.e. more than several hundred feet) contact Perry Colclasure (Data Coordinator) to determine reason for the discrepancy (phone # in back of manual).
2. Locating a plot with an RP and baseline: You may encounter a plot that is difficult to locate using photo interpretation. In this case you may establish a baseline on the photos to determine true photo azimuth and scale. Once the baseline is established:
 - a) Select, tag, pinprick, and record a RP, preferably within 500 feet of the plot. (See page 14).
 - b) On the photos, draw a straight line between the RP and pinpricked location.
 - c) Determine the azimuth and distance from the RP to the referenced subplot.
 - d) Measure out the calculated azimuth and distance to the referenced subplot. Locate the field grid location, which is the center of subplot 1 on the standard layout to begin the plot. If a new plot, carefully check the photos against the surrounding terrain and vegetation to make sure you are actually at the field grid location pinpricked on the new photo.

Colocated P2 and P3 plots in OR and WA

Annual Inventory 2004
LOCATING THE PLOT

Special instructions for the installation of Annual Inventory design plot center/subplots at locations where the previous P2 plot and the previous P3 plot were established at different ground locations.

Subplot 1:

The subplot 1 (plot) center established at the P2 field visit (for both FIA and NFS plots) predates the P3 plot center and is assumed to be the 'true' plot center location. If the P3 plot center is within 10 feet of this 'true' location, the Annual Inventory (current field visit) plot center will be installed at the P3 plot center (ie. 'move' the P2 location to the P3 location).

On non-NFS plots, remove whichever set of stake and monumenting is no longer used as plot center.

On NFS plots, even if the P3 location is used, always leave the original P2 stake and monumenting because that P2 plot may be remeasured in the future (to close out the old inventory).

Subplots 2 - 4:

In most cases, P2 subplots 2 - 4 have not been established yet on the Annual plot design (4-point fixed radius layout). Use the subplot centers established by the P3 crews if they are within 10 feet of their correct location (based on the P3 plot center being used at this inventory). Generally the current crew will not chain out to subplots 2-4 but will just pace there and install it at the same previous location. If the current crew suspects that the subplot is incorrectly located, they can accurately chain out the Distance and Az. If the established subplot is within 10 feet of the correct location, reuse it. Otherwise install the subplot at the 'new' correct location.

Mislocated Plot:

If a P3 plot was installed at an incorrect location, ie. at the wrong plot or PI point, install the Annual Inventory plot at the correct FIA or NFS plot center.

Special case 1: Eastern Oregon juniper plots have already been established on the 4-point plot design. On these plots follow rules above for subplots 1-4.

Special case 2: If the P3 plot was installed centered on the wrong P2 subplot (ie P3 subplot 1 is located at P2 subplot 2-5), ignore the old P3 plot and install a new one at the correct grid location. If any previously measured trees are encountered on the new P3 plot record the previous tree/line number.

C. Plots with active logging

If the plot area is being logged (timber is being felled, bucked, or yarded) or is unsafe to visit because of active logging, DO NOT ESTABLISH THE PLOT. Note on the plot jacket the status of the logging operation and return the plot to the supervisor. The supervisor will hold the plot until later in the season, when the status of the logging operation will be checked again to see if the plot can be completed.

D. Denied access plots

If access is denied to the field grid location or a portion of a plot, see "Denied Access plots" on pages 14 and 72.

E. Plot location tolerance

See PLOT LAYOUT AND REFERENCING CHAPTER

III. PLOT LAYOUT AND REFERENCING

TABLE OF CONTENTS

III. PLOT LAYOUT AND REFERENCING	11
A. Plot layout at the current annual inventory	13
Standard 4-subplot plot diagram	13
B. Census water, Denied access, Hazardous, and Not in the sample areas	14
C. Recognition of condition classes	14
D. Subplot numbering	14
Install N# subplots	14
E. Referencing the plot	14
1. Referencing a plot visited previously	14
2. Referencing a lost plot	15
3. Referencing plots not visited previously	15
4. An exception	15
5. Referencing an entirely nonforest plot off national forests	15
6. Referencing an entirely nonforest plot on national forests	16
7. The reference point (RP)	16
8. Referencing the plot center monument	17
9. Referencing the microplot	17
10. Route to RP	17
F. Referencing the other subplots on the standard layout	17
1. Mark subplot center	17
2. Select witness trees	17
3. Tag the witness trees	18
G. Recording witness tree data (all subplots on the standard layout)	18
1. If a tally tree or stump	18
2. If not a tally tree	18
H. Plot layout and referencing MQO	18

III. PLOT LAYOUT AND REFERENCING

A. Plot layout at the current annual inventory

In the current annual inventory the 4 subplots are laid out in the pattern below across condition classes. Subplots are never "substituted" or "moved" in order to keep the entire subplot within a condition class.

See Appendices 1 & 3 for special rules about nonforest plots/condition classes on R5 and R6 NFS lands.

Standard 4-subplot plot diagram

PNW Forest Inventory and Analysis Year 2004 Phase II plot design

Distance between subplot points: 120'
 Distance from point to microplot center: 12.0'
 Overall plot footprint ~2.5 ac

KEY

	6.8' radius microplot: seedlings + saplings
	24.0' radius subplot: all trees (≥5")
	58.9' radius annular plot: large trees (≥24 or 30")
	185.1' radius hectare plot: large trees (>32 or 48")
	Woody debris/ground cover transects

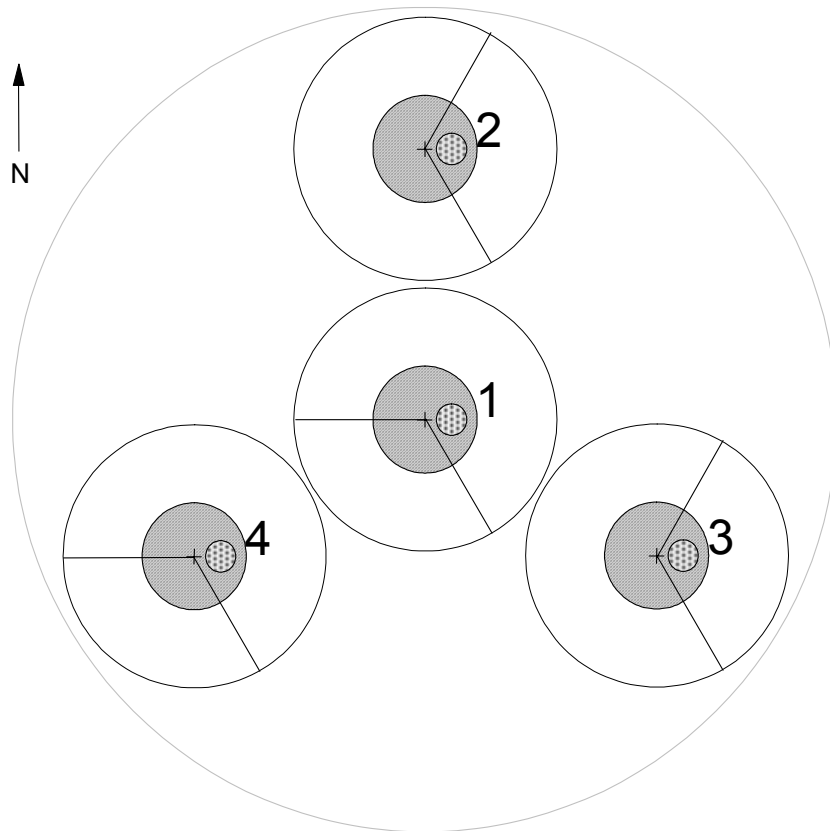

From	To	Horizontal Distance	Azimuth
Subplot 1	Subplot 2	120.0 ft.	360
Subplot 1	Subplot 3	120.0 ft.	120
Subplot 1	Subplot 4	120.0 ft.	240
Subplot 2	Subplot 3	207.8 ft.	150
Subplot 2	Subplot 4	207.8 ft.	210
Subplot 3	Subplot 4	207.8 ft.	270

B. Census water, Denied access, Hazardous, and Not in the sample areas

At the current inventory for all subplots (including subplot 1 - plot center)

1. If a subplot center **can** be physically occupied, then any Census water, Denied access, Hazardous, or Not in the sample areas are mapped as separate condition classes. Measurements are taken only in any accessible forest land condition classes.
2. If a subplot center **can not** be physically occupied (i.e. Census water, Denied access, or Hazardous) the subplot will not be installed or referenced. The entire subplot is classified as the subplot center condition, even though a portion of it may be in another condition class. Other subplots are installed using normal procedures. If subplot 1 cannot be occupied, use a photo template, GPS, or estimate of Az/Dist to locate the other subplots.

See mapping Condition class status on page 66 for further instructions.

C. Recognition of condition classes

Plot area recognized as within inventoried area is divided into condition classes. The area within each subplot's radius is mapped by condition class. Condition classes are first defined by differences in condition class status. Some of these condition classes may be further subdivided by other attributes. The condition class in which the field grid location lies (the center of subplot 1) is always condition class 1.

Condition classes are determined in three steps:

1. Plot area is divided into condition classes based on differences in condition class status.
2. Accessible forest land condition classes are further divided by differences in 6 mapping variables.
3. Nonforest land condition classes are further divided, in some cases, by differences in nonforest land use.

See the Condition Class Attributes chapter on page 65 for complete instructions.

D. Subplot numbering

Install N# subplots

Install the four subplots in the configuration described above. The subplots are labeled N# (N1, N2, N3, and N4) subplots. Other first digit codes (C, or #) may be valid for other inventories.

All condition classes present on the annular (within the 58.9 ft. fixed-radius) are mapped on the subplot diagram. On accessible forest land condition classes, trees, snags, saplings, seedlings are measured. Understory vegetation and down woody material are measured on accessible forest land condition classes in Oregon, Washington, and California. This data is not measured or collected in any other type of mapped condition classes (**except on R5 & R6 lands where this data IS collected on nonforest condition classes**).

E. Referencing the plot

1. Referencing a plot visited previously

Find the location of the plot pinpricked on field photos at last visit. This previously pinpricked location is the field grid location for the plot. It was monumented at last visit with a cedar or plastic stake in the ground. This plot center monumentation was referenced last visit by an RP and two nearby witness trees. Both the RP and witness trees were marked distinctively with square and round tags. If a previously established plot cannot be found, refer to "Referencing a lost plot" in this section.

The species of the old RP, it's d.b.h. (to the nearest centimeter on PNW FIA plots), the azimuth from RP to the plot center monument, and the slope distance (in meters on old PNW FIA plots) from RP to the plot center were recorded on the plot card and aerial photo used at the last visit. Similar data were recorded for the nearby trees referencing the plot center monument except azimuth was recorded from the plot center to the tree, and distance was recorded to the nearest centimeter on old PNW FIA plots. Data downloaded to the Husky computer at the current inventory will be converted to English units. Apply this data in relocating the (pinpricked) location of the old plot center monument.

On some plots, the previous RP referenced a subplot center other than Subplot 1, the pinpricked location; on these plots, the plot center monument was still installed at the pinpricked location.

Once the location of the field grid location (old plot center monument) is known, do the following steps:

PLOT LAYOUT AND REFERENCING

- a) Install a new cedar or plastic stake at the field grid location. Check to see that "An exception" on page 15 does not apply.
- b) Reference the stake to two nearby trees; see "Referencing the plot center monument" on page 17.
- c) Reference the new stake to an RP; see "The reference point (RP)" on page 16.
- d) Determine and pinprick the location of the field grid location on the new photos using photo interpretation. Circle the pinprick on the back of the photo and write "PC" (plot center) and the plot number near the circle.
- e) Determine and pinprick the ground location of the RP on the new photos using photo interpretation. Circle the pinprick on the back of the photo and write "RP" near the circle.

2. Referencing a lost plot

In the event the previously established plot is not relocated, check all available information in order to reconcile the location of the plot. Previous plot access information (Route to RP and RP Information) should correlate with the original photo pinprick. If these two plot references do not correlate to the same location, search at least a 200 foot radius around the ground location of the photo pinprick, and a 200 foot radius around the ground location of where the RP to plot traverse ended. If the plot is not found within the search areas, treat it like a plot not visited previously.

3. Referencing plots not visited previously

See the instructions on page 8 to establish the plot location.

Do the following steps:

- a) Find this pinpricked field grid location on the ground. (The location will become the center of subplot 1 on the standard layout).
- b) Install a cedar or plastic stake at this location on the ground. Check to see that "An exception" on page 15 does not apply.
- c) If using a cedar stake, use an aluminum nail to attach a round tag (yellow-side up) on to the top of the stake.
- d) Reference the new stake to two nearby trees; see "Referencing the cedar stake" on page 17.
- e) Reference the new stake to an RP; see "The reference point (RP)" on page 16.
- f) Circle the pinprick in red pen on the back of the photo and write "PC" (plot center) and the plot number near the circle.
- g) Determine and pinprick the ground location of the RP on the new photos using photo interpretation. Circle the pinprick in red pen on the back of the photo and write "RP" near the circle.

4. An exception

The plot center monument is not placed at the field grid location if the 58.9-foot fixed-radius plot at subplot 1 on the standard layout is entirely nonforest land and either of the following situations occurs:

- a) The center of subplot 1 is too hazardous to visit (examples: subplot center 1 is in the middle of a pond, or the middle of a freeway, or on the side of a cliff) **OR**
- b) Placing the plot center monument at the center of subplot 1 is very apt to irritate a landowner (example: subplot center 1 is in the middle of someone's front lawn).

If the exception applies, reference the center of the lowest-numbered subplot on the standard layout that has a forestland condition class present within its 58.9-foot fixed-radius plot.

Specifically, do the following steps:

- a) Place a cedar or plastic stake at the center of this subplot,
- b) Reference the new stake to two nearby trees; see "Referencing the plot center monument" on page 17.
- c) Reference the new stake to an RP; see "The reference point (RP)" on this page.
- d) If a revisited plot, determine and pinprick the location of the field grid location on the new photos using photo interpretation. On all plots: use a photo marking pen to circle the pinprick on the back of the photo and write "PC" (plot center) and the plot number near the circle.
- e) Determine and pinprick the ground location of the RP on the new photos using photo interpretation. Circle the pinprick in red pen on the back of the photo and write "RP to subplot (insert number)" near the circle (Example: "RP to subplot 3").

Keep in mind that the field grid location in this case, is not at the location of the plot center monument. The field grid location is always the center of subplot 1 on the standard layout regardless of whether it is referenced or not.

5. Referencing an entirely nonforest plot off national forests

Plots that are entirely nonforest and are field visited need to be referenced when stocking subplots are established.

Do the following steps:

PLOT LAYOUT AND REFERENCING

- a) Find this pinpricked field grid location on the ground. (The location will become the center of subplot 1 on the standard layout).
- b) Install a cedar or plastic stake at this location on the ground.
- c) If using a cedar stake, use an aluminum nail to attach a round tag (yellow-side up) on to the top of the stake.
- d) Reference the new stake to two nearby trees or other objects; see "Referencing the plot center monument" on page 17.
- e) Reference the new stake to an RP; see "The reference point (RP)" on page 16.
- f) Circle the pinprick in red pen on the back of the photo and write "PC" (plot center) and the plot number near the circle.
- g) Determine and pinprick the ground location of the RP on the new photos using photo interpretation. Circle the pinprick in red pen on the back of the photo and write "RP" near the circle.
- h) The other 3 subplots do not need to be referenced if the entire plot is nonforest.

6. Referencing an entirely nonforest plot on national forests

Plot that are entirely nonforest and are field visited need to be referenced.

Do the following steps:

- a) Find this pinpricked field grid location on the ground. (The location will become the center of subplot 1 on the standard layout).
- b) Install a cedar or plastic stake at this location on the ground.
- c) If using a cedar stake, use an aluminum nail to attach a round tag (yellow-side up) on to the top of the stake.
- d) Reference the new stake to two nearby trees or other objects; see "Referencing the plot center monument" on page 17.
- e) Reference the new stake to an RP; see "The reference point (RP)" on page 16.
- f) Circle the pinprick in red pen on the back of the photo and write "PC" (plot center) and the plot number near the circle.
- g) Determine and pinprick the ground location of the RP on the new photos using photo interpretation. Circle the pinprick in red pen on the back of the photo and write "RP" near the circle.
- h) The other 3 subplots do not need to be referenced if the entire plot is nonforest.

7. The reference point (RP)

The RP references the cedar or plastic stake. It is an object (usually a tree) that is prominent, apt to be present at next visit and easily located on the ground. Do not reference a subplot other than the one with the plot center monument just because that subplot is closer to the RP. Reference the other subplot only when there is a significant obstacle or other obstruction between the RP and Subplot 1, but not between the RP and the other subplot chosen.

Selecting an RP: The RP should be distinctive on both the ground and on the new photos. You may reuse the previous RP tree if it is suitable. If the old RP tree is dead, missing, or difficult to identify on the ground or plot photo, select a new RP (but leave the tags on the old RP). If possible, it should be a tree that is not likely to die or be cut before the next inventory. You may select a snag or other object for an RP (i.e., a distinctive fence post, building corner, telephone pole, etc.). If you utilize such an RP, describe it on the plot photo and in "Location Description" on the Plot Record Card.

Tag the RP: Mark the RP tree with new or reused tags. Nail aluminum square tags on two or more sides of the RP tree, 6 feet above ground line, facing directions you expect future crews to approach the RP. Also nail an aluminum square tag on the RP tree below stump height, on the side of the tree facing the plot center monument. When attaching a tag, drive the nail into the tree only enough to anchor the nail firmly into the wood; and always leave at least 2 inches of nail exposed. If the RP is a building, rock, or other item that can/should not be tagged, make a note in the "Location Description" that it is not tagged.

Pinprick the RP location: Pinprick the ground location of the RP on the new photos UNLESS the RP pinprick would obscure another pinprick. Circle the RP pinprick on the back of the photo and write "RP" and the plot number near the circle (but do not obscure any pinpricks).

Record RP data: Record the species of the RP, it's d.b.h./d.r.c. to the nearest inch, azimuth FROM RP to cedar or plastic stake, and slope distance measured to the nearest foot from the square tag at the base of the RP to the cedar or plastic stake. Record this on the back of the aerial photo, under "Plot Reference" on the Plot Record Card, and in the Plot Attributes section of the plot data.

PLOT LAYOUT AND REFERENCING

In "Location Description" on the Plot Record Card, record any information that would aid the next crew in relocating the plot. Describe prominent features present in the plot area that are unlikely to change in the next ten years; examples include details such as slope, aspect, topographic position, recognizable physiographic features (ie. streams, rock outcrops, benches), man-made features, and unusual or large trees. If any new roads have been built in the plot area since the date of the new field photos, sketch them on the photos if it will help the next crew to find the plot.

Example: "The RP is a large Douglas-fir (over 120 feet tall) in a draw that descends northeast from mainline logging road 1000. Subplot N1 is down slope from the RP and is just down slope and next to a large rock outcrop."

8. Referencing the plot center monument

To reference the cedar or plastic stake with nearby (witness) trees, **do the following steps:**

- a) Select two trees near the plot center monument that form, as closely as possible, a right angle with the stake. If the previous witness trees meet this criterion, reuse them. On a revisited plot, if you select a new witness tree, remove the square tags (if present) from the witness tree it is replacing to avoid confusing the next crew. Trees within 6 feet of the stake are preferable. If live trees are not available, use stumps or sound snags.
- b) Nail a square aluminum tag well below stump height (<0.5 foot above the ground) on each witness tree on the side facing the stake. If the trees are also numbered tally trees, attach the tree number tags with the same nails. When attaching a tag, drive the nail into the tree only enough to anchor the nail firmly into the wood; always leaving at least 2 inches of nail exposed.
- c) In two locations on each witness tree, nail a square aluminum tag 6 feet high facing likely approaches to the subplot.
- d) Record data about the witness trees; refer to "Recording witness tree data" in section G of this chapter.

9. Referencing the microplot

The center of each 6.8-foot microplot is located 12 feet from each subplot center at 90 degrees. Mark each microplot with a metal pin and round (white face up) at microplot center, and tie a piece of flagging to the pin.

10. Route to RP

Record a clear and concise narrative for the travel route to the RP in the space provided on the Plot Card.

Begin at a permanent starting point. The term "starting point" is somewhat ambiguous. Normally the starting point is an arterial or secondary road junction. In some cases (wilderness access) the starting point may be a trailhead, or the end of a local road. Whatever starting point is selected, it should be easily identifiable from the map, aerial photo (if there is photo coverage of the starting point), and on the ground.

The narrative for the Route to RP shall identify the mode of travel (driving, hiking, etc.), route traveled (include road and/or trail designation number), direction of travel (use cardinal directions), and the distance traveled on each segment.

When foot travel becomes the predominant means of accessing the RP and/or when the travel route is long or complex, install a Point of Reference (POR). A POR is a tree or object. Monument each point of reference using the same methods as monumenting an RP. When a point of reference occurs on the aerial photo, pinprick the base of the object and label it POR (on the photo back). Record the POR information (the same information required for an RP) on the front of the plotcard.

F. Referencing the other subplots on the standard layout

One subplot on the standard layout, usually subplot 1, is referenced adequately by the cedar or plastic stake and its nearby witness trees and RP. Other subplots on the standard layout that have forestland present somewhere on their 58.9-foot fixed-radius subplot also require referencing. Do the following steps:

1. Mark subplot center.

Mark subplot center with a metal pin and yellow round, and tie a piece of flagging to the pin.

2. Select witness trees.

Select 2 trees near the pin that form, as closely as possible, a right angle with the pin. Trees within 6 feet of the pin are preferred. If trees are not available, use stumps or sound snags. On subplots established previously, reuse the previous witness trees, or if there are better trees available, use new witness trees. Renew old witness tags as needed.

3. Tag the witness trees.

- a) If a tally tree: If the tree is a trackable (tally) tree that does not require a numbered tag, attach an aluminum round tag below stump height facing subplot center. When attaching a round tag, drive the nail into the tree only enough to anchor the nail firmly into the wood; always leave at least 2 inches of nail exposed.
- b) If a tree that is not a tally tree: Nail an aluminum round 6 feet above ground line facing the direction you expect future crews to approach the subplot, and nail one aluminum round below stump height facing the subplot center. If the witness is a live tree with a diameter 3.0 in. d.b.h./d.r.c. or larger, mark where diameter is measured with an aluminum nail; rules for marking diameter on page 158 apply. When attaching a round tag or marking d.b.h./d.r.c., drive the nail into the tree only enough to anchor the nail firmly into the wood; always leave at least 2 inches of nail exposed.
- c) If a stump: If the witness is a stump <4.5 ft tall, in addition to steps a and b, attach an additional aluminum round tag, yellow side up, to the top of the stump. If the stump is not a tally tree, record "stump" in the tree comment. When nailing tags to stumps, pound the nail in flush to the bole. Tags nailed to stumps stay attached longer if the bark is removed prior to nailing the tag in.
- d) If an other object: If the witness is a shrub, nail an aluminum round tag to the base of the shrub facing subplot center. If possible, nail an additional round higher up which faces the direction you expect future crews to approach the subplot. If the witness is another object, monument and tag as appropriate. In both cases record comments in the "tree remarks" section.

G. Recording witness tree data (all subplots on the standard layout)

Azimuth (subplot center to tree), slope distance to the head of the nail affixing the basal tag or tree number tag, species, and diameter are recorded for each witness tree, snag, or stump. NOTE: Witness tree distance is always slope distance from the subplot center to the head of the nail affixing the basal aluminum tag or tree number tag. This is a different measurement than the horizontal distance to the center of the tree collected for all tally trees.

1. If a tally tree or stump

If a witness tree, snag or stump is a trackable tree record, enter a "*" after it's TREE STATUS by entering a "V" on the Husky data recorder; the Husky will then insert an asterisk after the tree status to indicate the tally tree is a witness tree. In addition to the standard data items, the Husky will require that slope distance be recorded.

2. If not a tally tree

If the witness is not a tally tree or stump, enter a new record for the tree or stump; assign the record a TREE STATUS of 9, and record azimuth, slope distance to the head of the nail at basal tag (or to the front of a non-tagged object), species, and diameter (diameter for a stump is the average of two width measurements across the top of the stump).

H. Plot layout and referencing MQO

RP selection:

Tolerance: No error in selection criteria

RP data items:

Tolerance: See Reference point (RP) data items on page 37.

Aerial photograph:

Tolerance: Previous and current pinpricks in correct spot: +/- 1 mm.

Current plot center and RP labeled correctly: no errors

Plot location:

Tolerance: Remeasured plot: relocated

New plot: photos 1:12,000 scale or greater: located +/- 10.0 ft.

photos smaller than 1:12,000 scale +/- 30.0 ft.

Subplot location:

Tolerance: Remeasured subplot: +/- 0.5 ft. of previous location

New subplot: +/- 5.0 ft.

Annual Inventory 2004
PLOT LAYOUT AND REFERENCING

Subplot witness (tree) selection:
Tolerance: No error in selection criteria

Microplot location:
Tolerance: Remeasured microplot: +/- 0.1 ft. of previous location
New microplot: +/- 0.1 ft.

.

IV. PLOT ATTRIBUTES

TABLE OF CONTENTS

IV. PLOT ATTRIBUTES.....	21
Item 1--STATE.....	23
Item 2--COUNTY.....	23
Item 3--HEX NUMBER.....	25
Item 4--NFS plot number.....	25
Item 5--Old PNW-FIA plot number.....	26
Item 6--PLOT STATUS.....	26
Item 7--SAMPLE KIND.....	26
Item 8--CORE FIELD GUIDE VERSION #.....	27
Item 9--PNW data recorder program version #.....	27
Item 10--DECLINATION.....	27
Item 11--Elevation.....	27
Item 12--Precipitation.....	27
Item 13--Hydrologic unit code.....	27
Item 14--Special study 2002a.....	28
Item 15--Special Study 2004a.....	28
Item 16--Special study 2004b.....	28
Item 17--Hectare plot?.....	28
Item 18--CREW TYPE.....	28
Item 19--QA STATUS.....	28
Item 20--Crew Leader.....	29
Item 21 thru 25--Crew member 1 thru 5.....	29
DATE OF INVENTORY.....	29
Item 26--MONTH.....	29
Item 27--DAY.....	30
Item 28--YEAR.....	30
Item 29--Date of previous inventory.....	30
Item 30--Remeasurement period.....	30
Item 31--Previous ground land class.....	30
Item 32--Landowner plot summary request.....	31
Item 33--Owner name/address update.....	32
Item 34--Topographic position.....	32
Item 35--STRAIGHT LINE DISTANCE TO IMPROVED ROAD.....	33
GPS COORDINATES.....	33
GPS UNIT SETTINGS, DATUM, and COORDINATE SYSTEM.....	33
COLLECTING READINGS.....	33
Item 36--GPS UNIT TYPE.....	34
Item 37--GPS SERIAL NUMBER.....	34
Item 38--COORDINATE SYSTEM.....	34
Item 39--UTM ZONE.....	34
Item 40--EASTING (X) UTM.....	34
Item 41--NORTHING (Y) UTM.....	35
Item 42--GPS ELEVATION.....	35
Item 43--GPS ERROR.....	35
Item 44--NUMBER OF READINGS.....	35
Item 45--GPS FILENAME (CORE OPTIONAL).....	35
CORRECTION FOR "OFFSET" LOCATION.....	36
Item 46--AZIMUTH TO PLOT CENTER.....	36
Item 47--DISTANCE TO PLOT CENTER.....	36
Downloaded plot coordinates.....	36
Item 48--Previous UTM zone.....	36
Item 49--Previous Easting (X) UTM.....	36
Item 50--Previous Northing (Y) UTM.....	36

Annual Inventory 2004
PLOT ATTRIBUTES

Item 51--Previous coordinates method	36
Reference point (RP) data items	37
Item 52--RP species	37
Item 53--RP diameter	37
Item 54--RP azimuth.....	37
Item 55--RP distance.....	37
Item 56--RP az/dist to subplot #	37
Item 57--Plot card data items	37
Cruiser names	37
RP description	37
Plot write up.....	37

IV. PLOT ATTRIBUTES

Plot attributes record plot location and information about the field crew visit and landowner contact. This information aids future crews in plot relocation, sets up date and inventory cycle information in the data recorder, and makes it possible to analyze the relationship of plot data to other mapped data (i.e. rivers).

See Appendices 1 & 3 for special rules about nonforest plots/condition classes on R5 and R6 NFS lands.

Item 1--STATE

Record the unique FIPS (Federal Information Processing Standard) code identifying the State where the plot center is located.

Do not change the downloaded/printed code.

Code	State
06	California
16	Idaho (valid only for R6 administered plots in ID)
32	Nevada (valid only for R5-administered plots in NV)
41	Oregon
53	Washington

Item 2--COUNTY

Record the unique FIPS code identifying the county where the plot center is located.

Do not change the downloaded/printed code.

WASHINGTON COUNTY CODES:

Code	County	Declination degrees-East	Unit
001	Adams	17 ½	E
003	Asotin	16 ½	E
005	Benton	17 ½	E
007	Chelan	18	C
009	Clallam	19	OLY
011	Clark	17 1/2	SW
013	Columbia	17	E
015	Cowlitz	18	SW
017	Douglas	18	C
019	Ferry	18	E
021	Franklin	17	E
023	Garfield	17	E
025	Grant	17 ½	E
027	Grays Harbor	18 ½	OLY
029	Island	18 ½	PS
031	Jefferson	18 ½	OLY
033	King	18	PS
035	Kitsap	18 1/2	PS
037	Kittitas	18	C
039	Klickitat	17 ½	C
041	Lewis	18	SW
043	Lincoln	17 ½	E
045	Mason	18 ½	OLY
047	Okanogon	18	C
049	Pacific	18	SW
051	Pend Oreille	17 ½	E
053	Pierce	18	PS
055	San Juan	19	PS
057	Skagit	18 ½	PS
059	Skamania	17 ½	SW
061	Snohomish	18 ½	PS

Annual Inventory 2004
PLOT ATTRIBUTES

063	Spokane	17	E
065	Stevens	17 ½	E
067	Thurston	18	OLY
069	Wahkiakum	18	SW
071	Walla Walla	17	E
073	Whatcom	18 1/2	PS
075	Whitman	17	E
077	Yakima	17 ½	C

Western Washington Unit Codes: OLY = Olympic Unit, PS = Puget Sound unit, SW = Southwest unit
Eastern Washington Unit Codes: C = Central Washington Unit, E = Eastern Washington Unit

OREGON COUNTY CODES:

Code	County	Declination degrees-East	Unit	East or West
001	Baker	16 ½	B	E
003	Benton	17 ½	WC	W
005	Clackamas	17 ½	NW	W
007	Clatsop	18	NW	W
009	Columbia	18	NW	W
011	Coos	17	SW	W
013	Crook	17	C	E
015	Curry	17	SW	W
017	Deschutes	17	C	E
019	Douglas	17	SW	W
021	Gilliam	17	C	E
023	Grant	16 ½	B	E
025	Harney	16	B	E
027	Hood River	17 ½	NW	E
029	Jackson	16 ½	SW	W
031	Jefferson	17	C	E
033	Josephine	17	SW	W
035	Klamath	16 ½	C	E
037	Lake	16 ½	C	E
039	Lane	17	WC	W
041	Lincoln	17 ½	WC	W
043	Linn	17 ½	WC	W
045	Malheur	16	B	E
047	Marion	17 ½	NW	W
049	Morrow	17	B	E
051	Multnomah	17 ½	NW	W
053	Polk	17 ½	NW	W
055	Sherman	17	C	E
057	Tillamook	18	NW	W
059	Umatilla	17	B	E
061	Union	16 ½	B	E
063	Wallowa	16 ½	B	E
065	Wasco	17 ½	C	E
067	Washington	18	NW	W
069	Wheeler	17	C	E
071	Yamhill	17 ½	NW	W

Western Oregon Unit codes: NW = Northwest, SW = Southwest, WC = Westcentral
Eastern Oregon Unit codes: B = Blue Mountains, C = Central

CALIFORNIA COUNTY CODES:

Code	County	Decl. East	Unit		Code	County	Decl. East	Unit
001	Alameda	15	CC		059	Orange	14	SO
003	Alpine	15	SJ		061	Placer	16	SA
005	Amador	15	SJ		063	Plumas	16	SA
007	Butte	16	SA		065	Riverside	13	SO
009	Calaveras	15	SJ		067	Sacramento	15	SA
011	Colusa	16	SA		069	San Benito	15	CC

Annual Inventory 2004
PLOT ATTRIBUTES

013	Contra Costa	15	CC		071	San Bernardino	14	SO
015	Del Norte	17	NC		073	San Diego	13	SO
017	El Dorado	15	SA		075	San Francisco	15	CC
019	Fresno	15	SJ		077	San Joaquin	15	SJ
021	Glenn	16	SA		079	San Luis Obispo	15	CC
023	Humboldt	17	NC		081	San Mateo	15	CC
025	Imperial	13	SO		083	Santa Barbara	14	CC
027	Inyo	14	SO		085	Santa Clara	15	CC
029	Kern	14	SJ		087	Santa Cruz	15	CC
031	Kings	15	SJ		089	Shasta	16	NI
033	Lake	16	SA		091	Sierra	16	SA
035	Lassen	16	NI		093	Siskiyou	17	NI
037	Los Angeles	14	SO		095	Solano	16	CC
039	Madera	15	SJ		097	Sonoma	16	NC
041	Marin	15	CC		099	Stanislaus	15	SJ
043	Mariposa	15	SJ		101	Sutter	16	SA
045	Mendocino	16	NC		103	Tehama	16	SA
047	Merced	15	SJ		105	Trinity	16	NI
049	Modoc	16	NI		107	Tulare	14	SJ
051	Mono	15	SJ		109	Tuolumne	15	SJ
053	Monterey	15	CC		111	Ventura	14	CC
055	Napa	15	SA		113	Yolo	16	SA
057	Nevada	16	SA		115	Yuba	16	SA

Units codes: (NC) North Coast, (NI) North Interior, (SA) Sacramento,
(CC) Central Coast, (SJ) San Joaquin, (SO) Southern.

NEVADA COUNTY CODES:

Code	County	Declination degrees-East
005	Douglas	15
009	Esmeralda	14 ½
021	Mineral	14 ½
031	Washoe	16

IDAHO COUNTY CODES:

Code	County	Declination degrees East
49	Idaho	16
085	Valley	15 ½
003	Adams	16
069	Nez Perce	16 ½

Item 3--HEX NUMBER

Record the identification number for each plot, unique within a county.

This may be referred to as Hexagon Number on the plot jacket. The National Core procedures specify that Hex Number is a 4-digit variable. To keep the Hex Number unique within a state, PNW has numbered each Hex with a 5-digit number, the last 4 of which are unique within a county. Do not change the downloaded/printed code.

Field width: 5 digits

Values: 1 to 99999

Item 4--NFS plot number

Record the unique identification number for each R6 plot which is not assigned a HEX NUMBER. Used for intensification and other plots not on the PNW-FIA 6,000 acre grid.

Record for all R5 NFS plots, including those with a HEX NUMBER.

Annual Inventory 2004
PLOT ATTRIBUTES

When collected: When HEX NUMBER is not assigned and OWNER GROUP for Condition Class 1 = 10 and STATE = 41 (Oregon) or 53 (Washington), or when OWNER GROUP for Condition Class = 10 and STATE = 06 (California)

Field width: 5 digits when OWNER CLASS = a R5 National Forest

Field width: 7 digits when OWNER CLASS = a R6 National Forest

Values: 1 to 1,000,000

Item 5--Old PNW-FIA plot number

A 3-digit code identifying the plot number (if any) used for this location at previous inventories. This item is included as a reference. Do not change the downloaded/printed code.

Item 6--PLOT STATUS

Record the code that describes the sampling status of the plot.

When collected: All plots

Field width: 1 digit

Tolerance: No errors

MQO: At least 99% of the time

Values:

Code	Status	Status definition
1	Sampled	at least one accessible forest land condition present on plot or previously had at least one accessible forest land condition on plot
2	Sampled	no accessible forest land condition present on plot and no previously accessible forest land condition on plot
3	Nonsampled	

Item 7--SAMPLE KIND

Record the code that describes the kind of plot being installed.

Sample kind is printed/downloaded for the plot. Update if incorrect and note on the plot card in "Items for office attention".

Field width: 1 digit

Tolerance: No errors

Values:

Code	Sample Kind	Sample Kind Definition
1	Initial 4-subplot plot establishment	The initial establishment and sampling of a national design plot (FIA Field Guide versions 1.1 and higher). SAMPLE KIND 1 is assigned under the following circumstances: <ul style="list-style-type: none"> • Initial activation of a panel or subpanel • Reactivation of a panel or subpanel that was previously dropped • Resampling of established plots that were not sampled at the previous visit No 4-subplot FIA (P2) plot was previously established. <ul style="list-style-type: none"> • Initial activation of a panel or subpanel
2	Remeasurement	Remeasurement of a national design plot that was sampled at the previous inventory -- field-visited or remotely classified. Not valid for 2004 inventory.

3	Replacement plot	A replacement plot for a previously established plot. Assign SAMPLE KIND = 3 if a plot is installed at a location other than the previous location (i.e., plots that have been lost, moved, or otherwise replaced). Note that replacement plots require a separate plot file for the previous plot. Replaced plots are assigned PLOT STATUS = 3, SAMPLE KIND = 2, and the appropriate NONSAMPLED REASON code. The plot number for the replacement plot is assigned by NIMS. Not valid for 2004 inventory.
---	------------------	--

Item 8--CORE FIELD GUIDE VERSION #

Record the version number of the Forest Inventory and Analysis National Core Field Guide which was used to collect the data on this plot. This will be used to match collected data to the proper version of the field manual. Do not change the downloaded/printed code. The 2004 field guide version is 2.0.

Item 9--PNW data recorder program version #

A 3-digit field identifying the version number of the data recorder program used to collect data on the plot. In the format x.y.z. PNW data recorder program version # will start at 1.0.0 at the beginning of the field season. If minor modifications to the data recorder program are made in response to changes in field procedures or programming requirements, the z field will be changed to z+1. If more significant changes are made, the y field will be changed to y+1. The first field (x) will be changed only in the event of a major modification to the program. Field manuals are not reprinted during the season, but future printings would include any change(s) made to procedures. Do not change the data recorder generated code.

Values: x.y.z (starting at 1.0.0)

Item 10--DECLINATION

Record *in degrees* the azimuth correction used to adjust magnetic north to true north. All azimuths are assumed to be magnetic azimuths unless otherwise designated. This field carries a decimal place because the USGS corrections are provided to the nearest half degree. DECLINATION is defined as:
DECLINATION = (TRUE NORTH - MAGNETIC NORTH)

The declination used for each plot will be downloaded/printed, and is listed by county in the table on page 24. This adjustment is made in the field by setting the declination for the plot as "**East Declination**" on the compass. Do not change the downloaded/printed code.

Values: -016.0 to -018.0 (Oregon)
-016.5 to -018.5 (Washington)
-013.0 to -018.0 (California)
-015.5 to -016.5 (Idaho)
-14.5.0 to -16.0 (Nevada)

Item 11--Elevation

A 5-digit code downloaded/printed for the plot if recorded in a previous inventory. This item shows the elevation to the nearest 5-feet on the plot as obtained from a USGS topographic map. Do not change the downloaded/printed code. Leave this item blank if no code was downloaded/printed.

Item 12--Precipitation

A 3-digit code downloaded/printed for the plot if recorded in a previous inventory. This item shows average annual precipitation in inches on the plot. Do not change the downloaded/printed code. Leave this item blank if no code was downloaded/printed.

Item 13--Hydrologic unit code

A 12-digit code printed/downloaded for the plot. This item identifies the watershed in which the field grid point is located. Do not change the printed/downloaded code. Leave this item blank if no code was printed/downloaded.

Item 14--Special study 2002a

A 1-digit code downloaded/printed for the plot. This item identifies whether or not the plot area is within the sample area for Special Study 2002a, which varies from 0 to roughly 50 miles from the coast, and if qualifying trees on this plot are sampled for Platform and Moss Abundance (see page 173). Do not change the downloaded/printed code, but notify the state coordinator if you believe it is incorrect.

Code	Definition
Y	Qualifying trees are sampled for Platform and Moss Abundance
N	Trees are not sampled for Platform and Moss Abundance

Item 15--Special Study 2004a

All P2 plots in Oregon that are not on NFS lands will be sampled for riparian areas. Additional stream data items and attributes will be collected for plots when STATE = 53 (Oregon) and OWNER GROUP = 20, 30 or 40 (Other Federal, State and Local Government, and Private). The data recorder will prompt for this data after STATE and OWNER GROUP are recorded.

Item 16--Special study 2004b

A 1-digit code which identifies whether or not the plot area is within the B & B Fire boundary. This item is downloaded/printed for PNW-FIA plots on the 6,000 acre grid. Do not change the downloaded/printed code. Enter the appropriate code for plots without downloaded plot files (i.e. R6 CVS plots).

When this item = Y, additional Tree Data variables are collected on the R6 remeasurement ("old") plot, additional ground cover variables are collected on the microplots, and more intensive understory vegetation measurements (P2+) are taken.

Code	Definition
Y	Plot is within the B & B Fire boundary
N	Plot is not within the B & B Fire boundary

Item 17--Hectare plot?

A 2-digit code indicating if the hectare plot is sampled for large trees, and if so, what size tree is included in that sampling (> 32" or > 48" diameter). This item is downloaded for plots in California (including R6 lands in CA). In Washington and Oregon it will be calculated once the County and Owner group are recorded. In either case do not change the downloaded/calculated code.

Values: No, 32, 48

Item 18--CREW TYPE

Record the code to specify what type of crew is measuring the plot.

When collected: All plots

Field width: 1 digit

Tolerance: No errors

Values:

Code	Crew type
1	Standard <i>Forest Service</i> field crew
2	QA crew (any QA crew member present collecting data, <i>regardless of plot QA Status</i>)
3	<i>Standard Contractor field crew</i>

Item 19--QA STATUS

Electronic data files are automatically named by the data recorder using the HEX NUMBER and File Name Code. Electronic data files for plots with QA STATUS 2 to 6 are save as separate files so that the original standard production plot data is preserved and can be used for quality control and statistical analysis.

When collected: All plots

Field width: 1 digit

Annual Inventory 2004
PLOT ATTRIBUTES

Tolerance: No errors

Values:

File Name Code	Code	Visit type
P	1	Standard production plot
C	2	Cold check
R	3	Reference plot (off grid)
T	4	Training/practice plot (off grid)
D	5	Botched plot file (disregard during data processing)
B	6	Blind check
H	7	Production plot (hot check)

Cold check - an informal inspection done either as part of the training process, or as part of ongoing QC program. The inspector checks completed work after a crew has turned it in. Data errors are corrected (in a separate, updated plot data file).

Blind check - a formal inspection done without crew data on hand; a full re-installation of the plot for the purpose of obtaining a measure of data quality. The two data sets are maintained separately. Data errors are NOT corrected. Blind checks are done on production plots only.

Hot check - an informal inspection. Usually done as a part of the training process. The inspector is present on the plot with the crew and provides immediate feedback regarding data quality. Data errors are corrected in the plot file as the crew completes its work.

Item 20—Crew Leader

Enter the first initial and last name of the crew leader on the plot.

When collected: All plots

Field width: 1 name of up to 12 characters

Tolerance: No errors

Values: 1 name of up to 12 characters

Item 21 thru 25—Crew member 1 thru 5

Enter the first initial and last name of up to five additional crew members taking measurements on the plot.

When collected: All plots

Field width: 5 names of up to 12 characters

Tolerance: No errors

Values: 5 names of up to 12 characters

DATE OF INVENTORY

Record the month, day, and year that the current plot visit was completed as follows:

Item 26--MONTH

Record the month that the plot was completed.

When collected: All plots

Field width: 2 digits

Tolerance: No errors

Values:

Month	Code	Month	Code	Month	Code
January	01	May	05	September	09
February	02	June	06	October	10
March	03	July	07	November	11
April	04	August	08	December	12

Item 27--DAY

Record the day of the month that the plot was completed.

When collected: All plots
Field width: 2 digits
Tolerance: No errors
Values: 01 to 31

Item 28--YEAR

Record the year that the plot was completed.

When collected: All plots
Field width: 4 digits
Tolerance: No errors
Values: 2004

Item 29--Date of previous inventory

4-digit code downloaded/printed if a date was assigned for the plot at the previous inventory. It indicates the month and year of the previous inventory. Do not change the downloaded/printed date.

Item 30--Remeasurement period

During the Annual Inventory 2004 the remeasurement period (the number of years of growth counted on trees bared for radial growth) is 5 and 10 years on all plots. The increment period may be different at future inventories. Do not change the downloaded/printed code.

Item 31--Previous ground land class

A 2-digit code is downloaded/printed for plots that were classified within inventoried area at the time of the previous inventory. Do not change the downloaded/printed GLC code.

Code	Ground Land Class	Definition
20	Timberland	Forest land which is potentially capable of producing at least 20 cubic feet/acre/year at culmination in fully stocked, natural stands of continuous crops of trees to industrial roundwood size and quality and which is not withdrawn from timber utilization. Industrial roundwood requires species that grow to size and quality adequate to produce lumber and other manufactured products (exclude fence posts and fuel wood which are not considered manufactured). Timberland is characterized by no severe limitations on artificial or natural restocking with species capable of producing industrial roundwood.
41	Other forest-rocky	Other forest land which can produce tree species of industrial roundwood size and quality, but which is unmanageable because the site is steep, hazardous, and rocky, or is predominantly nonstockable rock or bedrock, with trees growing in cracks and pockets. Other forest-rocky sites may be incapable of growing continuous crops due to inability to obtain adequate regeneration success.
42	Other forest-unsuitable site (wetland, subalpine or coastal conifer scrub) (CA only)	Other forest land which is unsuited for growing industrial roundwood because of one of the following environment factors: willow bogs, spruce bogs, sites with high water tables or even standing water for a portion of the year, and harsh sites due to extreme climatic and soil conditions. Trees present are often extremely slow growing and deformed. Examples: whitebark pine, lodgepole, or mountain hemlock stands at timberline; shore pine along the sparkling blue Pacific Ocean (Monterey, Bishop, and Sitka Douglas-Fir); willow wetlands with occasional cottonwoods present; Sitka spruce-shrub communities bordering tidal flats and channels along the coast. Includes aspen stands in high-desert areas or areas where juniper/mountain mahogany are the predominate species.
43	Other forest-pinyon-juniper	Areas currently capable of 10 percent or more tree stocking with forest trees, with juniper species predominating. These areas are not now, and

Annual Inventory 2004
PLOT ATTRIBUTES

		show no evidence of ever having been, 10 percent or more stocked with trees of industrial roundwood form and quality. 10 percent juniper stocking means 10 percent crown cover at stand maturity.
44	Other forest-oak	Areas currently 10 percent or more stocked with forest trees, with low quality forest trees of oak, gray pine, madrone, or other hardwood species predominating, and which are not now, and show no evidence of ever having been, 10 percent or more stocked with trees of industrial roundwood form and quality. Trees on these sites are usually short, slow growing, gnarled, poorly formed, and generally suitable only for fuel wood. The following types are included: blue oak, white oak, live oak, oak-gray pine.
45	Other forest-chaparral	Areas covered with heavily branched dwarfed trees or shrubs, usually evergreen, the crown canopy of which currently covers greater than 10 percent of the ground. The principal species are dwarf <u>Quercus</u> , <u>Cercocarpus</u> (except <u>Cercocarpus ledifolius</u>), <u>Garrya</u> , <u>Ceanothus</u> , <u>Arctostaphylos</u> , <u>Baccharis</u> , and <u>Adenostoma</u> . Areas in which the predominate cover is <u>Artemisia</u> , <u>Purshia</u> , <u>Gutierrezia</u> , <u>Opuntia</u> , or semi-desert species are considered nonforest.
46	Other forest-unsuitable site (OR & WA Only)	Other forest land which is unsuited for growing industrial roundwood because of one of the following environment factors: willow bogs, spruce bogs, sites with high water tables or even standing water for a portion of the year, and harsh sites due to climatic conditions. Trees present are often extremely slow growing and deformed. Examples: whitebark pine or mountain hemlock stands at timberline, shore pine along the Pacific Ocean, willow wetlands with occasional cottonwoods present, and sitka spruce-shrub communities bordering tidal flats and channels along the coast. Aspen stands in high-desert areas or areas where juniper/mountain mahogany are the predominate species are considered other forest-unsuitable site.
48	Other forest-cypress (CA Only)	Forest land with forest trees with cypress predominating. Shows no evidence of having had 10 percent or more cover of trees of industrial roundwood quality and species.
49	Other forest-low site	Forest land capable of growing crops of trees to industrial roundwood quality, but not able to grow wood at the rate of 20 cubic feet/acre/year. Included are areas of low stocking potential and/or very low site index.
61	Cropland	
62	Improved pasture	
63	Natural range land	Includes abandoned farmland.
64	Farmland	Includes homesteads.
65	Marsh	
66	Cultural nonforest stringer	16.5-foot wide and wider constructed roads, power lines, pipelines and railroads.
67	Urban	Town sites and areas of clustered suburbs, residential industrial buildings. (Forest 7.5 ac. or more in urban areas are classed as forest land).
68	Naturally nonvegetated	Barren rock, sand, and glaciers.
69	Christmas tree lands	Includes nurseries.
92	Water	Includes lakes 1.0 to 40 acres and streams 30 to 660 feet wide.

Item 32--Landowner plot summary request

1-digit code which indicates if a landowner of the plot area requests a summary of the data collected on their land. If a plot summary is requested by the owner of subplot 1, verify that that the printed name/address is correct (see following data item). Make any special comments relevant to the data request (ie. landowner does not own all 4 subplots, the owner of subplot 2 wants data, etc.) on the plot packet near the owner address label and use code 2.

When collected: All plots

Annual Inventory 2004
PLOT ATTRIBUTES

Field width: 1 digit
Tolerance: No errors
Values:

Code	Landowner data request
0	No data request
1	Plot summary requested
2	Special case request

Item 33--Owner name/address update

1-digit code which indicates if the landowner name and address printed on the plot packet label (the owner of subplot 1) needs to be updated. It is important that this information be verified for all plots, not just the ones where the owner has requested data. Write corrections to the printed name and address on the plotcard near the ownership label. Be sure to include the full address. If a landowner of plot area other than subplot 1 requests data, make it clear in the note that the 'official' (subplot 1) owner has not changed. If there is no recorded landowner on the plot packet label (it is blank) record a code 1. The crew should collect the owner's name and address and write it on the plot packet label.

When collected: All plots
Field width: 1 digit
Tolerance: No errors
Values:

Code	Owner name/address update
0	Current name and address is correct
1	Name and/or address needs to be updated (see plot packet)

Item 34--Topographic position

Record a 1-digit code for topographic position that best describes the plot area. Use the common shape of slope listed in the table below as a guide. Record the code that best fits the topographic position.

If the plot straddles a canyon bottom or on a narrow ridge top, but most of the area lies on one side hill record the topographic position of the side hill.

When collected: All plots with at least one accessible forest land condition class
Field width: 1 digit
Tolerance: 1 class for codes 3, 4, and 5. No error for other codes.
Values:

Code	Topographic Position	Common shape of slope
1	Ridge top or mountain peak over 130 feet	Flat
2	Narrow ridge top or peak less than 130 feet wide.	Convex
3	Side hill -- upper 1/3	Convex
4	Side hill -- middle 1/3	No rounding
5	Side hill -- lower 1/3	Concave
6	Canyon bottom less than 660 feet wide	Concave
7	Bench, terrace or dry flat	Flat
8	Broad alluvial flat over 660 feet wide	Flat
9	Swamp or wet flat	Flat

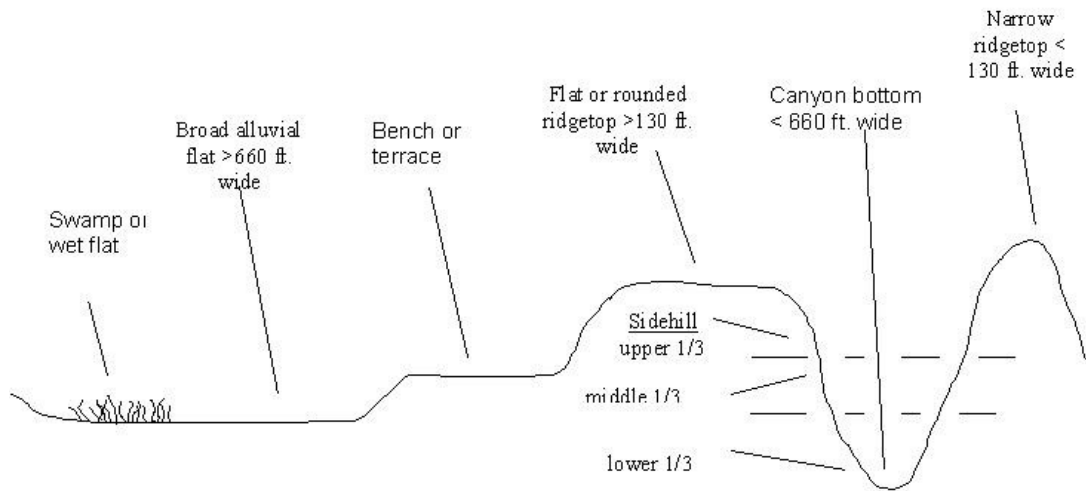

Item 35--STRAIGHT LINE DISTANCE TO IMPROVED ROAD

Record the straight-line distance from plot center (subplot 1) to the nearest improved road. An improved road is a road of any width that is maintained as evidenced by pavement, gravel, grading, ditching, and/or other improvements.

When collected: All plots with at least one accessible forest land condition class (PLOT STATUS =1)

Field width: 1 digit

Tolerance: No errors

Values:

Code	Horizontal Distance
1	100 ft. or less
2	101 to 300 ft.
3	301 to 500 ft.
4	501 to 1000 ft.
5	1001 ft. to 1/2 mile
6	1/2 to 1 mile
7	1 to 3 miles
8	3 to 5 miles
9	Greater than 5 miles

GPS COORDINATES

Use a global positioning system (GPS) unit to determine the plot coordinates and elevation of all field visited plot locations (including Nonforest and Not in the sample plot locations).

GPS UNIT SETTINGS, DATUM, and COORDINATE SYSTEM

Consult the GPS unit operating manual or other regional instructions to ensure that the GPS unit internal settings, including Datum and Coordinate system, are correctly configured.

Use the NAD 27 Datum (also known as NAS-C or NA 27 CONUS/CLK66) and the UTM coordinate system. See Chapter XIV for instructions on setting up and using the PLGR GPS unit.

COLLECTING READINGS

Collect at least 180 GPS readings at the plot center which will then be averaged by the GPS unit. Each individual reading should have an error of less than 70 feet if possible (the error of all the averaged readings is far less).

Soon after arriving at plot center, use the GPS unit to attempt to collect coordinates. If suitable readings (180 readings at error less than or equal to 70 feet) cannot be obtained, try again before leaving the plot center.

Annual Inventory 2004
PLOT ATTRIBUTES

If it is still not possible to get suitable coordinates from plot center, attempt to obtain them from a location within 200 ft of plot center. Obtain the azimuth and horizontal distance from the "offset" location to plot center. If a PLGR unit is used use the Rng-Calc function in the PLGR to compute the coordinates of the plot center (see page 219). If another type of GPS unit is used, record the azimuth and horizontal distance in *Items 41 and 42*.

Coordinates may be collected further than 200 feet away from the plot center if a laser measuring device is used to determine the horizontal distance from the "offset" location to plot center. Again, if a PLGR unit is used, Use the Rng-Calc function in the PLGR to compute the coordinates of the plot center. If another type of GPS unit is used, record the azimuth and horizontal distance in *Items 41 and 42*.

In all cases try to obtain at least 180 readings before recording the coordinates.

Item 36--GPS UNIT TYPE

Record the kind of GPS unit used to collect coordinates. If suitable coordinates cannot be obtained, record 0.

When collected: All field visited plots
Field width: 1 digit
Tolerance: No errors
Values:

Code	GPS UNIT TYPE
0	GPS coordinates not collected
1	Rockwell Precision Lightweight GPS Receiver (PLGR)
2	Other brand capable of field averaging
3	Other brands capable of producing files that can be post processed
4	Other brands not capable of field averaging or post processing

Item 37--GPS SERIAL NUMBER

Record the last six digits of the serial number on the GPS unit used.

When collected: When GPS UNIT TYPE > 0
Field width: 6 digits
Tolerance: No errors
Values: *Alphanumeric*

Item 38--COORDINATE SYSTEM

Record a code indicating the type of coordinate system used to obtain readings.

When collected: When GPS UNIT TYPE > 0
Field width: 1 digit
Tolerance: No errors
Values:

2	UTM coordinate system
---	-----------------------

Item 39--UTM ZONE

Record a 2-digit and 1-character UTM ZONE as determined by GPS.

When collected: When COORDINATE SYSTEM = 2
Field width: 3 digits: (##C)
Tolerance: No errors
Values: 10, 11, and U, T, or S

Item 40--EASTING (X) UTM

Record, *in meters*, the Easting coordinate of the plot center as determined by GPS. The Husky data recorder will require that this item be entered two times. The first entry is the UTM as displayed by the GPS unit. The second entry is the UTM numbers in reverse order (from right to left).

Annual Inventory 2004
PLOT ATTRIBUTES

When collected: When COORDINATE SYSTEM = 2
Field width: 7 digits
Tolerance: +/- 140 ft
Values:

Item 41--NORTHING (Y) UTM

Record, *in meters*, the Northing coordinate of the plot center as determined by GPS.
The Husky data recorder will require that this item be entered two times. The first entry is the UTM as displayed by the GPS unit. The second entry is the UTM numbers in reverse order (from right to left).

When collected: When COORDINATE SYSTEM = 2
Field width: 7 digits
Tolerance: +/- 140 ft
Values:

Item 42--GPS ELEVATION

Record the elevation above mean sea level of the plot center, in feet, as determined by GPS.

When collected: When GPS UNIT TYPE = 1, 2 or 4
Field width: 6 digits
Tolerance: +/- 280 ft
Values: -00100 to 20000

Item 43--GPS ERROR

Record the error as shown on the GPS unit to the nearest foot. As described *on page 33*, make every effort to collect readings only when the error less than or equal to 70 feet. However, if after trying several different times during the day, at several different locations, this is not possible, record readings with an error of up to 999 feet.

When collected: When GPS UNIT TYPE = 1 or 2
Field width: 3 digits
Tolerance: No errors
Values: 000 to 070 if possible
071 to 999 if an error of less than 70 cannot be obtained

Item 44--NUMBER OF READINGS

Record a 3-digit code indicating how many readings were averaged by the GPS unit to calculate the plot coordinates. Collect at least 180 readings if possible.

The Husky data recorder requires that the number of averaged readings be entered. The Magellan unit does not have a number of readings counter, instead it utilizes a timer. The timer is displayed on the position screen. It displays in hours/minutes/and seconds. The GPS receiver collects one reading per second while averaging. To correctly enter the number of readings in the husky, the time in minutes and seconds must be converted to number of readings. Since the unit collects 60 readings per minute of averaging crews must remember to multiply the number of minutes by 60 and then add the number of seconds shown to that figure. For example, if the Magellan receiver averages for three minutes and twelve seconds it will display 00:03:12. To convert this to number of readings multiple three minutes by sixty and add twelve. $3 \times 60 = 180 + 12 = 192$. Crews would enter 192 in the husky data recorder for Number of Readings.

When collected: When GPS UNIT TYPE = 1 or 2
Field width: 3 digits
Tolerance: No errors
Values: 001 to 999

Item 45--GPS FILENAME (CORE OPTIONAL)

Record the filename containing the GPS positions collected on the plot.

When collected: When GPS UNIT = 3, STATE = 06 (California), and CREW TYPE = 3 (contractor field crew)

Annual Inventory 2004
PLOT ATTRIBUTES

Field width: 8 characters.3 characters (e.g., R0171519.ssf)
Tolerance: No errors
MQO: At least 99% of the time
Values: Letters and numbers

CORRECTION FOR "OFFSET" LOCATION

As described in *the beginning of the GPS section*, coordinates may be collected at a location other than the plot center (an "offset" location). If a PLGR unit is used all offset coordinates will be "corrected" back using the Rng/Calc function. If a GPS unit other than a PLGR is used, then record AZIMUTH TO PLOT CENTER and DISTANCE TO PLOT CENTER.

Item 46--AZIMUTH TO PLOT CENTER

Record, *in degrees*, the azimuth from the location where coordinates were collected to actual plot center. If coordinates are collected at plot center, record 000.

When collected: When GPS UNIT = 2, 3 or 4
Field width: 3 digits
Tolerance +/- 3 degrees
Values: 000 when coordinates **are** collected at plot center
001 to 360 when coordinates **are not** collected at plot center

Item 47--DISTANCE TO PLOT CENTER

Record the horizontal distance in feet from the location where coordinates were collected to the actual plot center. If coordinates are collected at plot center, record 000. As described in Section 1.18.2, if a Laser range finder is used to determine DISTANCE TO PLOT CENTER, offset locations may be up to 999 feet from the plot center. If a range finder is not used, the offset location must be within 200 feet.

When collected: When GPS UNIT = 2, 3 or 4
Field width: 3 digits
Tolerance: +/- 6 ft
Values: 000 when coordinates **are** collected at plot center
001 to 200 when a Laser range finder **is not** used to determine distance
001 to 999 when a Laser range finder **is** used to determine distance

Downloaded plot coordinates

For some plots, previous estimates of plot coordinates (pinprick location) may be available. These estimates come from several sources and will be of undocumented accuracy, but can be used as an aid in plot location. If available, the approximate plot coordinates will be downloaded to the data recorder and will be printed on the previous plot data sheets. They can be saved as a waypoint on the PLGR and used to help locate the plot. Do not change any of the downloaded/printed plot coordinates codes.

Item 48--Previous UTM zone

A 2-digit and 1 character field indicating which UTM zone the plot is located in. If UTM Zone is not downloaded, it can be determined by turning on the PLGR GPS unit once in the plot area and viewing the UTM Zone of new readings. Correct entry of UTM Zone is vital to use the PLGR for navigating.

Item 49--Previous Easting (X) UTM

A 7-digit code indicating the Easting as determined from USGS maps, aerial photos, or a previous plot visit.

Item 50--Previous Northing (Y) UTM

A 7-digit code indicating the Northing as determined from USGS maps, aerial photos, or a previous plot visit.

Item 51--Previous coordinates method

A 1-character code indicating the method by which previous plot coordinates were obtained.

Code	Previous coordinates method
D	Digitized from USGS maps

M	Digitized (MDSD) from PI photography (usually small scale)
P	Digitized (MDSD) from PLOT photography (usually large scale)
G	Collected at the plot location using a GPS unit

Reference point (RP) data items

Record the following items which describe the RP and the course from the RP to the plot as described on page 16. These data items should match what is recorded on the paper Plot Card form.

Item 52--RP species

If the RP is a tree or stump record it's species code (see page 157). If it is not, record 999.

Field width: 4 digits
Tolerance: No errors

Item 53--RP diameter

If the RP is a tree or stump measure (or estimate) and record it's diameter (see page 158) to the nearest inch. If it is not a tree or stump record 999.

Field width: 3 digits
Tolerance: +/- 10%

Item 54--RP azimuth

Record, in degrees, the azimuth from the RP to the plot.

Field width: 3 digits
Tolerance: +/- 4 degrees

Item 55--RP distance

Record, to the nearest foot, the slope distance from the RP to the plot.

Field width: 4 digits
Tolerance: +/- 5%

Item 56--RP az/dist to subplot #

Record the 1-digit number of the subplot which is referenced from the RP. Reference to subplot 1 whenever possible.

Field width: 1 digit
Tolerance: No errors
Values: 1 to 4

Item 57--Plot card data items

The following items are collected and recorded on the paper Plot Card form:

Cruiser names

Record the first and last names of all people collecting data on the plot.

RP description

Record a description of the RP and course to the plot from RP to plot as described on page 16.

Plot write up

Provide a written description of the plot area. The description normally includes an explanation of the site productivity, treatment, insect/disease, harvest, ownership class, and any other items of note that might be used by an analyst examining discrepancies in the plot data or by a person trying to relocate the plot at a future time.

Annual Inventory 2004
PLOT ATTRIBUTES

.

V. SUBPLOT ATTRIBUTES

TABLE OF CONTENTS

V. SUBPLOT ATTRIBUTES	39
A. Subplot identification	41
Item 1--SUBPLOT NUMBER	41
Item 2 SUBPLOT/ANNULAR PLOT STATUS	41
Item 3 ANNULAR PLOT NONSAMPLED REASON	41
Item 4--SUBPLOT CENTER CONDITION	42
Item 5--MICROPLOT CENTER CONDITION	42
B. Physioclass information	42
Item 6--SUBPLOT ASPECT	42
Item 7--SUBPLOT SLOPE	43
Item 8-- <i>Annular Plot</i> PHYSIOGRAPHIC CLASS	43
C. Water information	43
Item 9--WATER ON <i>SUBPLOT</i>	43
Item 10--Water proximity	45
Item 11--SNOW/WATER DEPTH	45
D. BOUNDARY REFERENCES	45
BOUNDARY DATA	46
Item 12--SUBPLOT NUMBER	46
Item 13--PLOT TYPE	46
Item 14--CONTRASTING CONDITION	47
Item 15--LEFT AZIMUTH	47
Item 16--CORNER AZIMUTH	47
Item 17--CORNER DISTANCE	47
Item 18--RIGHT AZIMUTH	47
Hectare plot mapping	48
Region 6 hectare plot mapping	48
Region 5 hectare plot mapping	48
Boundary mapping examples	48
E. Non-forest inclusions	49
1. General instructions	49
2. Downloaded estimates of non-forest inclusions	50
3. Estimating and recording non-forest inclusion area percentages by condition class	51
F. Root disease mapping/rating	51
1. General instructions	51
2. Downloaded estimates of root disease	52
3. Mapping root diseases	52
Western OR, Western WA, and CA (North Coast only)	52
Eastern OR, and Eastern WA, and CA (except the North Coast)	53
4. Guide for identifying root diseases	54
5. Estimating and recording root disease area percentages by condition class	54
Item 19--Root disease severity rating	54
G. SEEDLING COUNT	55
SEEDLING COUNT DATA ITEMS	55
Item 1--SUBPLOT NUMBER	55
Item 2--CONDITION CLASS NUMBER	55
Item 3--SPECIES	55
Item 4--SEEDLING COUNT	56
H. Mortality Assessment	56
Item 1--Line #	56
Item 2--Tree #	56
Item 3--Tree history	56
Item 4--Cause of Death / Damaging Agent	57
I. Subplot disturbance	57

Annual Inventory 2004
SUBPLOT ATTRIBUTES

Item 1--Burn assesment	57
Item 2--Mechanical management assesment	57
J. Special Study 2004a	57
Item 1--Stream Number	59
Item 2--Lake?	59
Subplot Measurements	59
Item 3--Distance to stream	59
Item 4--Azimuth to Stream	59
Item 5—Slope to Stream	60
Cross Section Measurements	60
Item 6--Active Width	60
Item 7--Active Width Maximum Depth	61
Item 8--Canopy Cover	61
Lower-most Cross Section Measurements	61
Item 9--Perennial/Seasonal	61
Item 10--Slope	62
Item 11--Dominant Channel Bed Type	62

V. SUBPLOT ATTRIBUTES

Subplot attributes record important information about the physical setting of the plot and the presence and location of contrasting land types on the plot. This information is used for a variety of topics, including: calculating accurate area estimates of land types and their associated forest information (e.g. tree volume, disease), identifying potential limits to management (e.g. topography), and relating physical site features to forest composition and productivity.

See Appendices 1 & 3 for special rules about nonforest plots/condition classes on R5 and R6 NFS lands.

A. Subplot identification

Each subplot is described by a series of area parameters relating to topographic features and existing cover type. These data also relate to the microplot, since the microplot is contained within the subplot perimeter.

Item 1--SUBPLOT NUMBER

Record a 2-digit code for each subplot that is assessed at the current visit. The second digit is the subplot. At this inventory the first digit is "N" (this is referred to as a "N#" subplot). Other first digit codes (#, C, or R) may be valid for other inventories. See Chapter III for instructions regarding subplot numbering. See plot layout diagram on page 13.

When Collected: All *established* subplots
 Field width: 2 *digits*
 Tolerance: No errors
 Values:

Code	Subplot
N1	center subplot
N2	north subplot
N3	southeast subplot
N4	southwest subplot

Item 2 SUBPLOT/ANNULAR PLOT STATUS

Indicate whether or not this annular plot currently has at least one accessible forested condition class.

When collected: All subplots
 Field width: 1 digit
 Tolerance: No errors
 MQO: At least 99% of the time
 Values:

Code	Plot Status
1	Sampled – at least one accessible forest land condition present on annular plot
2	Sampled – no accessible forest land condition present on annular plot
3	Nonsampled

Item 3 ANNULAR PLOT NONSAMPLED REASON

For entire annular plots that cannot be sampled, record one of the following reasons.

When collected: When SUBPLOT/ANNULAR PLOT STATUS = 3
 Field width: 2 digits
 Tolerance: No errors
 MQO: At least 99% of the time
 Values:

Code	Nonsampled Reason
01	Outside U.S. boundary – Assign this code to condition classes beyond the U.S. border.
02	Denied access area – Any area within the sampled area of a plot to which access is denied by the legal owner, or to which an owner of the only reasonable route to the plot denies access. There are no minimum area or width requirements for a condition class delineated by denied access. Because a denied-access condition can become accessible in the future, it remains in

Annual Inventory 2004
 SUBPLOT ATTRIBUTES

	the sample and is re-examined at the next occasion to determine if access is available. In some regions denied access plots may be replaced; check with the field supervisor regarding regional protocols for plot replacement.
03	Hazardous situation – Any area within the sampled area on plot that cannot be accessed because of a hazard or danger, for example cliffs, quarries, strip mines, illegal substance plantations, temporary high water, etc. Although the hazard is not likely to change over time, a hazardous condition remains in the sample and is re-examined at the next occasion to determine if the hazard is still present. There are no minimum size or width requirements for a condition class delineated by a hazardous condition. In some regions hazardous plots may be replaced; check with the field supervisor regarding regional protocols for plot replacement.

Item 4--SUBPLOT CENTER CONDITION

Record the CONDITION CLASS NUMBER of the condition class at the subplot center.

When collected: All *established* subplots
 Field width: 1 digit
 Tolerance: No errors
 Values: 1 to 9

Item 5--MICROPLOT CENTER CONDITION

Record the CONDITION CLASS NUMBER of the condition class at the microplot center.

When collected: All microplots where subplot center is CONDITION CLASS STATUS = 1, 2, 3, 7
 Tolerance: No errors
 Values: 1 to 9

B. Physioclass information

Aspect, slope, and physiographic class are recorded by subplot as well as by (accessible forestland) condition class. Code these items for each established subplot on the 4-subplot standard layout if one or more accessible forestland condition classes are present within the subplot's fixed-radius plot, i.e., if all condition classes present on a subplot are non-forestland, leave aspect, slope, and physiographic class blank. Physioclass data by subplot aids in determining these variables by forest condition class.

Item 6--SUBPLOT ASPECT

Record the aspect across the *24.0 ft radius* subplot, to the nearest 1-degree. SUBPLOT ASPECT is determined along the direction of slope for land surfaces with at least 5 percent slope in a generally uniform direction. SUBPLOT ASPECT is measured with a hand compass along the same direction used to determine slope. If aspect changes gradually across the subplot, record an average aspect. If aspect changes across the subplot but the aspect is predominately of one direction, code the predominate direction rather than the average.

If the subplot falls on or straddles a canyon bottom or narrow ridge top, code the aspect of the ridgeline or canyon bottom. If the subplot falls on a canyon bottom or on a narrow ridge top, but most of the area lies on one side hill, code the aspect of the side hill.

When the previous aspect data is downloaded/printed as a 2-character code, it requires updating with a current 3-digit numerical code.

When collected: All subplots with at least one accessible forestland condition present in subplot
 Field width: 3 digits
 Tolerance: +/- 10 degrees
 Values:

Code	Aspect
000	no aspect, slope < 5 percent
001	1 degree
002	2 degrees

Annual Inventory 2004
SUBPLOT ATTRIBUTES

*	*
*	*
360	360 degrees, due north

Item 7--SUBPLOT SLOPE

Record the angle of slope across the *24.0 ft radius* subplot to the nearest 1 percent. SUBPLOT SLOPE is determined by sighting the clinometer along a line parallel to the average incline (or decline) of each subplot. This angle is measured along the shortest pathway down slope before the drainage direction changes. To measure SUBPLOT SLOPE, Observer 1 should stand at the uphill edge of the subplot and sight Observer 2, who stands at the downhill edge of the subplot. Sight Observer 2 at the same height as the eye-level of Observer 1. Read the slope directly from the percent scale of the clinometer.

If slope changes gradually across the subplot, record an average slope. If slope changes across the subplot but the slope is predominately of one direction, code the predominant slope percentage rather than the average. If the subplot falls directly on or straddles a canyon bottom or narrow ridge top, code the average slope of the side hill(s). If the subplot falls on a canyon bottom or on a narrow ridge top, but most of the area lies on one side hill, code the slope of the side hill where most of the area lies.

When collected: All subplots with at least one accessible forestland condition present in subplot
Field width: 3 digits
Tolerance: +/- 10%
Values: 000 to 155

Item 8—Annular Plot PHYSIOGRAPHIC CLASS

Record the code that best describes the PHYSIOGRAPHIC CLASS of the annular plot; land form, topographic position, and soil generally determine physiographic class. As a rule of thumb, look over the *58.9 ft radius* annular plot area to determine physiographic class.

When collected: All annular plots with an accessible forestland condition class
Field width: 2 digits
Tolerance: No errors
Values:

Xeric -- Sites that are normally low or deficient in moisture available to support vigorous tree growth. These areas may receive adequate precipitation, but experience a rapid loss of available moisture due to runoff, percolation, evaporation, etc.

Code	Physiographic class	Description
11	Dry Tops	Ridge tops with thin rock outcrops and considerable exposure to sun and wind.
12	Dry Slopes	Slopes with thin rock outcrops and considerable exposure to sun and wind. Includes most mountain/steep slopes with a southern or western exposure.
13	Deep Sands	Sites with a deep, sandy surface subject to rapid loss of moisture following precipitation. Typical examples include sand hills, sites along the beach and shores of lakes and streams.
19	Other Xeric	All dry physiographic sites not described above. <i>Describe in Plot Notes</i>

Mesic -- Sites that have moderate but adequate moisture available to support vigorous tree growth except for periods of extended drought. These sites may be subjected to occasional flooding during periods of heavy or extended precipitation.

Code	Physiographic class	Description
21	Flatwoods	Flat or fairly level sites outside flood plains. Excludes deep sands and wet, swampy sites.
22	Rolling Uplands	Hills and gently rolling, undulating terrain and associated small streams. Excludes deep sands, all hydric sites, and streams with associated floodplains.
23	Moist Slopes and	Moist slopes and coves with relatively deep, fertile soils. Often

Annual Inventory 2004
 SUBPLOT ATTRIBUTES

	Coves	these sites have a northern or eastern exposure and are partially shielded from wind and sun. Includes moist mountain tops and saddles.
24	Narrow Floodplains/ Bottomlands	Flood plains and bottomlands less than 1/4-mile in width along rivers and streams. These sites are normally well drained but are subjected to occasional flooding during periods of heavy or extended precipitation. Includes associated levees, benches, and terraces within a 1/4 mile limit. Excludes swamps, sloughs, and bogs
25	Broad Floodplains/ Bottomlands	Flood plains and bottomlands 1/4 mile or wider in width along rivers and streams. These sites are normally well drained but are subjected to occasional flooding during periods of heavy or extended precipitation. Includes associated levees, benches, and terraces. Excludes swamps, sloughs, and bogs with year-round water problems.
29	Other Mesic	All moderately moist physiographic sites not described above. <i>Describe in Plot Notes</i>

Hydric -- Sites that generally have a year-round abundance or over-abundance of moisture. Hydric sites are very wet sites where excess water seriously limits both growth and species occurrence.

Code	Physiographic class	Description
31	Swamps/Bogs	Low, wet, flat forested areas usually quite extensive that are flooded for long periods of time except during periods of extreme drought. Excludes cypress ponds and small drains.
32	Small Drains	Narrow, stream-like, wet strands of forestland often without a well-defined stream channel. These areas are poorly drained or flooded throughout most of the year and drain the adjacent higher ground.
33	Bays and wet pocosins	Low, wet, boggy sites characterized by peaty or organic soils. May be somewhat dry during periods of extended drought. Examples include sites in the Lake States with lowland swamp conifers or the Carolina bays in the southeast US.
34	Beaver ponds	
35	Cypress ponds	
39	Other hydric	All other hydric physiographic sites. <i>Describe in Plot Notes</i>

C. Water information

Item 9--WATER ON SUBPLOT

Record the water source that has the greatest impact on the area within the accessible forestland portion of any of the four (58.9 ft.) annular plots. The coding hierarchy is listed in order from large permanent water to temporary water. This variable may be used for recreation, wildlife, hydrology, and timber availability studies. If no water source occurs on the 58.9 ft. annular plot, then record the code for any water source that occurs within 215 horizontal feet of subplot center. An individual water source may be recorded on two or more subplots. On P3 plots where the annular ring is not being measured (not co-visited for the current panel), evaluate the 24.0 ft radius subplot.

See the definitions on page 71.

When collected: All subplots with at least one accessible forestland condition present in subplot where STATE = 06 (California), 41 (Oregon), or 53 (Washington)

Field width: 1 digit

Tolerance: No errors

Values:

Code	Water on subplot
0	None -- no water sources within the accessible forestland condition class
1	Permanent (year-round) streams or ponds too small to qualify as noncensus water
2	Permanent water in the form of deep swamps, bogs, marshes with or without standing trees present

Annual Inventory 2004
 SUBPLOT ATTRIBUTES

3	Ditch/canal – human made channels used as a means of moving water, such as irrigation or drainage which are too small to qualify as noncensus water
4	Temporary (<i>intermittent</i>) stream that flows only part time because it receives water from seasonal sources such as springs and bank storage as well as precipitation
5	Flood zones – evidence of flooding when bodies of water exceed their natural banks
8	Census or noncensus water (<i>Census and noncensus water within the 58.9 ft radius annular subplot is already delineated in Subplot Mapping. Record in this item census/noncensus water within 215 ft., but not within the 58.9 ft. subplot</i>)
9	Other temporary water – specify in field notes

Item 10--Water proximity

Record a 3-digit code indicating the horizontal distance in feet from the edge of the water source to the subplot center. If there is no water source within 215 feet horizontal distance of subplot center, record "000". Valid codes are 000 through 215.

When collected: When WATER ON SUBPLOT > 0
 Field width: 3 digits
 Tolerance: +/- 10%
 Values: 0 to 215

Item 11--SNOW/WATER DEPTH

Record to the nearest 0.1 foot. the average approximate depth of water or snow covering the 24.0 ft radius subplot at the time of data collection. This variable is used to indicate plots where some variables (e.g. seedling count, total lengths) may be measured with less certainty due to conditions at the time of measurement.

This item is intended for water/snow which covers substantial portions of subplots. Do not record the depth of streams or other water sources if contained within their established banks and are not affecting tree or vegetation measurements.

When collected: All subplots with an accessible forestland condition class
 Field width: 2 digits (x.y)
 Tolerance: +/- 0.5 ft
 Values: 0.0 to 9.9

D. BOUNDARY REFERENCES

Boundary reference data are used to compute the area for the condition classes sampled on a plot and to remeasure plots. Record all boundaries between condition classes that occur within the sampled (fixed-radius) area on subplots and microplots (and optionally annular plots). Boundaries outside sampled (fixed-radius) areas are not referenced.

In addition to using the recording procedures described herein, sketch maps of condition class boundaries onto the pre-printed plot diagrams on paper field tally sheets.

If the national mapping procedures do not accurately represent the boundary, enter the national boundary data as best as possible into the data recorder, then sketch the boundary on the back of the plotcard so that it accurately represents the area mapped.

REFERENCE PROCEDURE

Reference the sampled area on each microplot, subplot, and annular plot, the approximate boundary of each condition class that differs from the condition classes at a subplot center. Trees selected on these fixed-radius plots are assigned to the actual condition in which they lie regardless of the recorded approximate boundary delineated.

Subplot/Annular boundary referencing is done by recording azimuths and distances from subplot center to the reference points and/or from microplot center to the reference points (see examples on page 48). Each boundary

Annual Inventory 2004
SUBPLOT ATTRIBUTES

is marked by a maximum of three points - two where the boundary intersects the subplot circumference or microplot circumference, and one "corner" point between the two end points, if necessary. Only the corner point requires a distance, since the distance from the center to the circumference is always equal to the fixed plot radius.

Microplot boundaries are referenced *from* the microplot center.

Hectare boundaries are always referenced from the center of Subplot 1.

Note that the larger the plot, the greater likelihood of a need for a boundary corner to record boundaries that are not straight lines.

Refer to the general condition class delineation guidelines *for Condition class status and Accessible Forestland on pages 66 and 72*. The following additional rules apply when referencing a boundary within a subplot, microplot, or annular plot:

1. When a boundary between accessible forestland and non-forest land or between two contrasting accessible forestland condition classes is clearly marked, use that feature to define the boundary. Examples of clear demarcation are a fence line, plowed field edge, sharp ridgeline, *defined stem line*, and water's edge along a stream course, ditch, or canal.
2. When a boundary between forestland and non-forestland is not clearly marked by an obvious feature, the boundary should follow the non-forest side of the stems of the trees at the forest edge.
3. When a boundary between two contrasting forestland condition classes is not clearly marked, map along the stems of the contrasting condition. When the boundary between two contrasting forestland condition classes is separated by a narrow linear inclusion (creek, fire line, narrow meadow, unimproved road), establish the boundary at the far edge, relative to subplot center, of the inclusion.
4. When a plot is remeasured, the crew will examine the boundaries referenced at last inventory. If no change has occurred, the current crew will retain the boundary data that were recorded at last inventory. If a boundary has changed, or a new boundary is present, or the previous crew made an obvious error, record new or updated boundary data. Delete boundaries that are no longer distinct.
5. Although individual MQOs are specified for the azimuths and distances, in practice a crew will be considered 'correct' when the difference in areas as mapped by the original crew and by the QA crew is less than 10 percent of the subplot or microplot area. This allows for slight variations in azimuths or distances due to the approximate nature of mapping procedures.

BOUNDARY DATA

Record the appropriate value *for each of the following data items* for each boundary mapped on the subplot, microplot or annular plot as follows.

If no boundaries are recorded for a subplot, enter one record with PLOT TYPE = 0.

Item 12--SUBPLOT NUMBER

Record the code corresponding to the number of the subplot. *Use the same code used for SUBPLOT NUMBER on page 41.*

When collected: All boundaries
Field width: 2 digits
Tolerance: No errors
Values: N1, N2, N3, N4

Item 13--PLOT TYPE

Record the code to specify whether the boundary data are for a subplot, microplot, annular, or hectare plot. *If no boundaries are recorded for a subplot, enter one record with PLOT TYPE = 0.*

When collected: All boundaries
Field width: 1 digit
Tolerance: No errors
Values:

Code	Plot Type
------	-----------

Annual Inventory 2004
 SUBPLOT ATTRIBUTES

0	<i>No boundaries are recorded for the subplot</i>
1	<i>Subplot boundary (will prompt for the associated annular plot (PLOT TYPE = 3) boundary)</i>
2	<i>Microplot boundary</i>
3	<i>Annular plot boundary</i>
4	<i>Hectare plot boundary (coded from subplot 1 only)</i>

Item 14--CONTRASTING CONDITION

Record the CONDITION CLASS NUMBER of the condition class that contrasts with the condition class located at the subplot center (for boundaries on the subplot, annular *or* *hectare* plot) or at the microplot center (for boundaries on the microplot), e.g., the condition class present on the other side of the boundary line.

When collected: All boundaries
 Field width: 1 digit
 Tolerance: No errors
 Values: 1 to 9

Item 15--LEFT AZIMUTH

Record, *in degrees*, the azimuth from the subplot, microplot, annular, *or* *hectare* plot center to the farthest left point (facing the contrasting condition class) where the boundary intersects the subplot, microplot, annular, *or* *hectare* plot circumference.

When collected: All boundaries
 Field width: 3 digits
 Tolerance: +/- 10 degrees
 Values: 001 to 360

Item 16--CORNER AZIMUTH

Record, *in degrees*, the azimuth from the subplot, microplot, annular, *or* *hectare* plot center to a corner or curve in a boundary. If a boundary is best described by a straight line between two circumference points, then record 000 for CORNER AZIMUTH (000=none).

When collected: All boundaries
 Field width: 3 digits
 Tolerance: +/- 10 degrees
 Values: 000 to 360

Item 17--CORNER DISTANCE

Record the horizontal distance, to the nearest 1 foot, from the subplot, microplot, annular, *or* *hectare* plot center to a boundary corner point.

When collected: All boundaries when CORNER AZIMUTH > 000
 Field width: 3 *digits*
 Tolerance: +/- 1 ft
 Values:

Plot Type	Values for Corner Distance
Microplot	01 to 07 ft (actual limiting distance is 6.8 ft.)
Subplot	01 to 24 ft.
annular plot	01 to 59 ft. (actual limiting distance is 58.9 ft)
<i>hectare plot</i>	<i>01 to 185 ft.</i>

Item 18--RIGHT AZIMUTH

Record, *in degrees*, the azimuth from the subplot, microplot, annular, *or* *hectare* plot center to the farthest right point (facing the contrasting condition class) where the boundary intersects the subplot, microplot, annular, *or* *hectare* plot circumference.

When collected: All boundaries

Annual Inventory 2004
SUBPLOT ATTRIBUTES

Field width: 3 digits
Tolerance: +/- 10- degrees
Values: 001 to 360

Hectare plot mapping

See Item 17--Hectare plot? on page 28 to determine if Hectare measurements are made on a plot.

Region 6 hectare plot mapping

A hectare plot (185.1 ft. fixed-radius plot around the center of subplot 1) is established if the center of subplot 1 is on R6 national forest land. The hectare plot is established even if there are no forested condition classes present on the subplots or annular plots.

Mapping condition classes:

All forest and nonforest condition classes present on the hectare plot are sketch mapped on the dot-map on the back of the plot card. The condition class boundaries are entered into the BOUNDARY MAPPING for subplot 1. Attributes for all condition classes mapped on the hectare are assigned.

Region 5 hectare plot mapping

A hectare plot (185.1 ft. fixed-radius plot around the center of subplot 1) will be established for designated plots within the Northwest Forest Plan area. The hectare plot is established on these plots even if there are no forested condition classes present on any of the subplots or annular plots. Size requirements are for trees of 32.0" d.b.h./d.r.c. on "east" side plots, and 48.0" d.b.h./d.r.c. on "west" side plots. The data recorder will designate if a plot is a hectare plot or not. There will also be an indication on the plot jacket. See Appendix 3, section A for more information.

Mapping condition classes:

Condition classes are mapped on the subplots and annular plots using normal procedures. Any additional condition classes present on the hectare plot that contain a hectare tally tree, but are not already delineated are mapped. Sketch the condition class on the dot-map on the back of the plot card. The boundaries are entered into the BOUNDARY MAPPING for subplot 1.

Boundary mapping examples

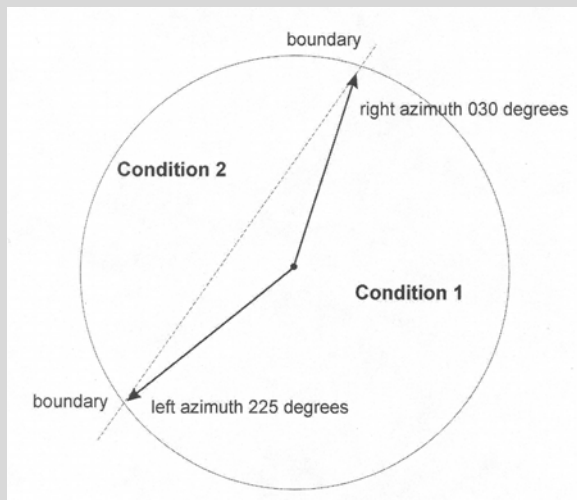

How to measure a straight boundary on a seedling/sapling plot or subplot.

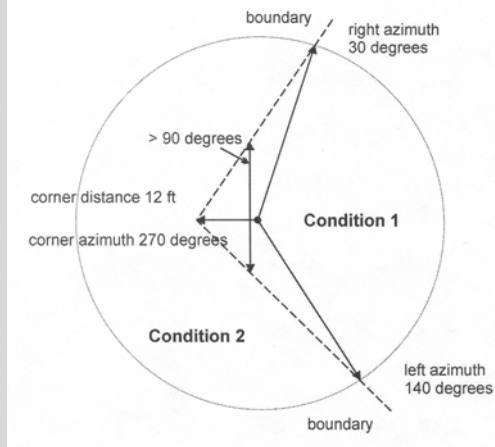

How to measure a boundary with a corner on a seedling/sapling plot or subplot.

Example of mapping subplot 1

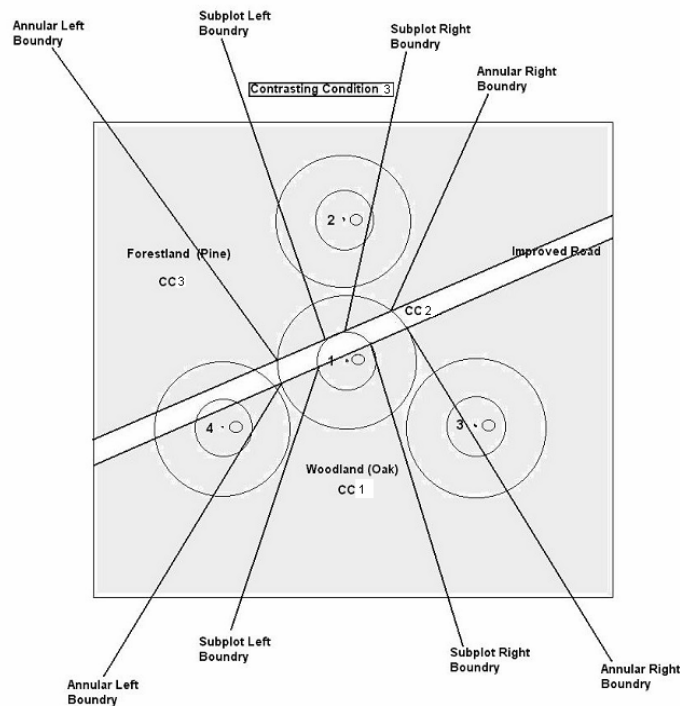

E. Non-forest inclusions

Non-forest inclusions are areas that are non-forest but are too small by definition to qualify as a separate non-forest condition class. These inclusions are inherently incapable of supporting tree stocking at 10 percent or more of normal full stocking for the life of a stand. Examples of non-forest inclusions can be unimproved dirt lanes, small streams, and sites with standing or running water, a high water table, a rock outcropping occupying at least 65 square feet, severe soil compaction (i.e. an old landing), or mass soil movement (slips, slides, or slumps). A stream or improved non-forest road, which qualifies as non-forestland, should be recognized as a separate non-forest condition class and not as a non-forest inclusion.

1. General instructions

Non-forest inclusions are mapped and recorded by subplot/annular plot and condition class. This is done only if the non-forest inclusion is present within a mapped accessible forestland condition class in Oregon, Washington, and California, and is partially or entirely within the subplot's 58.9-foot fixed-radius plot. If all condition classes present on a subplot/annular plot are non-forest, non-forest inclusion records are set or left blank for the subplot.

Map and label non-forest inclusions lying within the 58.9-foot fixed-radius plot on the subplot diagram. For each accessible forestland condition class mapped on the subplot, estimate the area of the 24.0-foot fixed-radius plot

Annual Inventory 2004
 SUBPLOT ATTRIBUTES

area occupied by the mapped non-forest inclusions; then separately estimate the area of the entire 58.9-foot fixed-radius plot area (including the 24.0 ft subplot) occupied by the mapped non-forest inclusions. See page 51 for how to map and estimate percentages. Record these percentages, their assigned condition class numbers and the type(s) of inclusion under "Inclusions %" on the subplot diagram. Then, record, by condition class, and by subplot/annular plot, these percentages and their assigned condition class numbers under "Non-forest inclusions" within SUBPLOT ATTRIBUTES. Record "00" in the "%" column for each forest condition class without non-forest inclusions.

example:	<u>Condition # 1</u>		<u>Condition # 2</u>	
	24.0 ft.	58.9 ft.	24.0 ft.	58.9 ft.
Rocks	12%	53%	00%	15%

When collected: All subplots with an accessible forestland condition class

Field width: 2 digits

Tolerance: +/- 15%

Values: 1 to 99

2. Downloaded estimates of non-forest inclusions

Non-forest inclusions were mapped and recorded by subplot on FIA timberland plots visited previously. This data is on the old plot sheets, and may assist the present crew in mapping non-forest inclusions. When the present plot is remeasured, non-forest inclusion data will be downloaded/printed and will be revised to reflect the situation at future inventories.

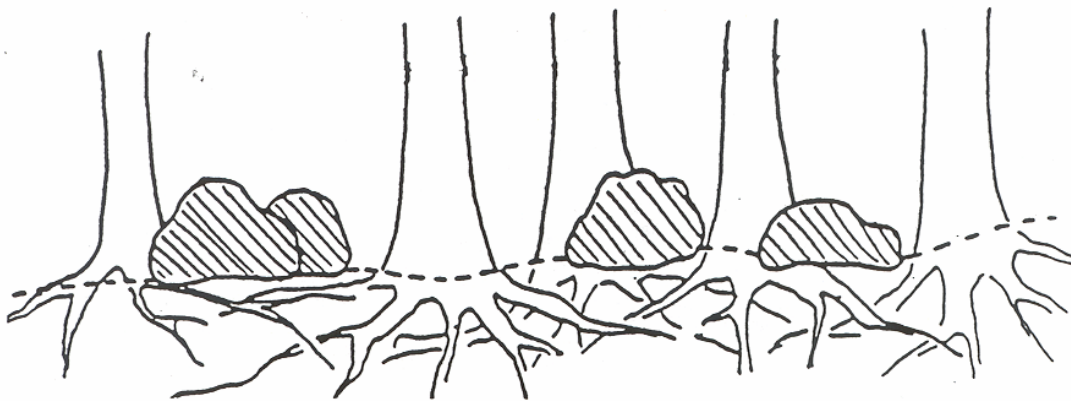

Example: Large, scattered boulders cover 25 percent of the 58.9-foot fixed-radius subplot. However, tree roots can fully utilize the space beneath the boulders. The boulders thus have no effect on potential tree stocking, and the item is coded "00" and the rocks are not mapped on the 58.9-foot fixed-radius subplot diagram as non-forest inclusions.

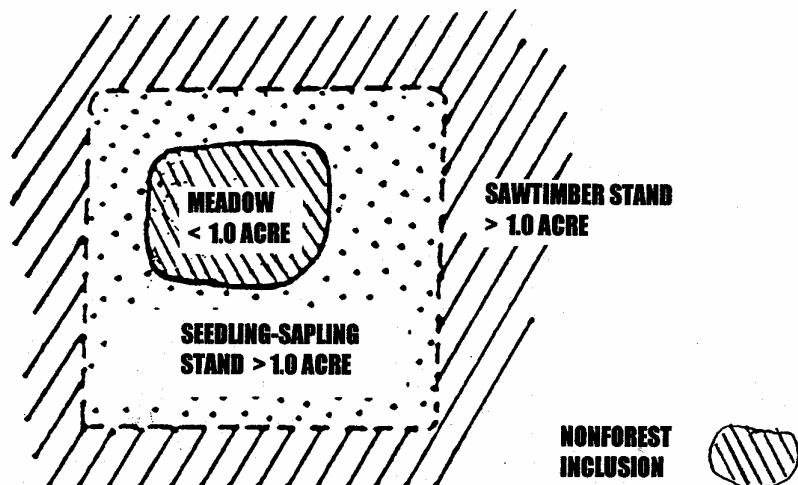

Example: A swampy meadow less than 1.0 acre in area is surrounded by forestland that is greater than 1.0 acre. The meadow is a non-forest inclusion, and the portion of the meadow within the 58.9-foot fixed-radius plot is mapped as a non-forest inclusion on the subplot diagram.

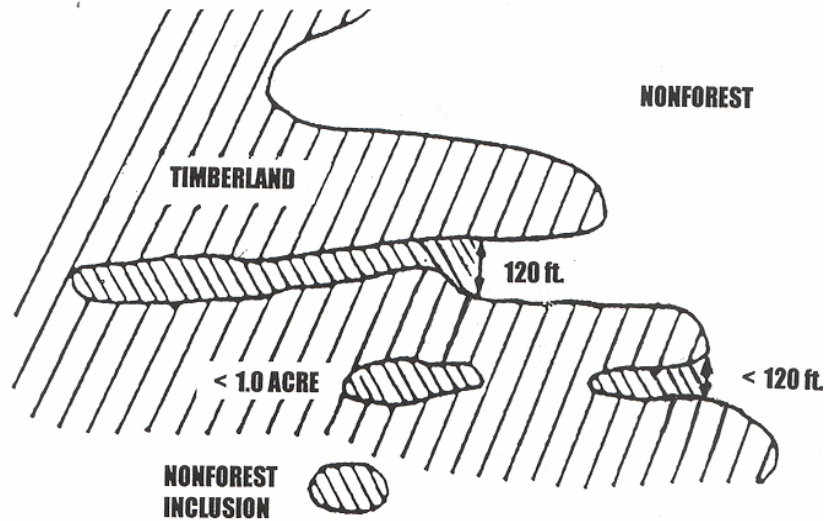

Example: In the above example each non-forest area (see Chapter VI) is classified as accessible forestland because each is not 120.0 ft. wide and 1.0 acre in size. They would be mapped as non-forest inclusions. Where the non-forest area becomes greater than 120.0 feet wide is classified as a part of the non-forest condition class and it would not be mapped as a non-forest inclusion.

3. Estimating and recording non-forest inclusion area percentages by condition class

Use the following steps to estimate, by condition class, the percentage of subplot area mapped as non-forest inclusion.

The following refers to mapping on the dot map on the back of the plotcard:

1. Each dot represents 1.45 percent of the area within the 24.0 ft. subplot plot.
2. Each dot represents 0.23 percent of the area within the entire 58.9 ft. subplot/annular plot.
3. Draw the non-forest inclusion boundary and count the number of dots within the 24.0 ft. subplot boundary within each condition class. Count every other dot of those which fall directly on a boundary.
4. Multiply the number of dots from step 3 by 1.45 to get percent of the 24.0 ft. subplot in that condition class. Alternatively, count the number of dots from step 3; divide by 69 (total number of dots) and multiply by 100 to get the percent of the subplot in that condition class. See the legend on the diagram plot card.
5. Count the number of dots within the 58.9 ft. annular plot boundary within each condition class. Include any dots previously counted in the subplot. Count every other dot of those which fall directly on a boundary.
6. Multiply the number of dots from step 5 by 0.23 to get percent of the 58.9 ft. annular plot (including the subplot) in that condition class. Alternatively, count the number of dots from step 5; divide by 437 (total number of dots) and multiply by 100 to get the percent of the annular plot in that condition class.

F. Root disease mapping/rating

Root diseases, especially laminated root rot in western Oregon, are serious forest pathogens. Information collected about root disease is developed into estimates of the area affected by each of several major diseases. These estimates can be combined with other data from the inventory to analyze the impact of root disease on forestland.

1. General instructions

Annual Inventory 2004
SUBPLOT ATTRIBUTES

Root diseases are mapped and recorded on established 58.9 ft. annular plots in Oregon, Washington, and California. Each disease is mapped and recorded separately (see "Mapping root disease on page 52). A root disease is mapped and recorded only if the area of infection is partially or entirely within an annular plot's 58.9 ft. fixed-radius plot and is within one or more accessible forestland condition classes mapped on the annular plot. If all condition classes mapped on an annular plot's 58.9 ft. fixed-radius plot are non-forestland all root disease records are set or left blank for the annular plot.

Map and label each disease present within the 58.9 ft. annular plot on the subplot diagram. For each accessible forestland condition class mapped on the annular plot, estimate the percentage of the 58.9 ft. fixed-radius plot area occupied by each mapped root disease; see pages 52 and 54 on how to map and estimate percentages. By disease, record these percentages, their assigned forest condition class numbers and the root disease code under "Root Disease" on the subplot diagram; enter "NO" if no disease is present. Then record, by condition class these percentages, their assigned condition class numbers, and the disease code under "Disease 1, 2, or 3" within SUBPLOT ATTRIBUTES. Record a disease code of "NO" (no disease) and "00" in the "%" column for each disease and forest condition class without disease present.

When collected: All annular plots with an accessible forestland condition class
Field width: 2 digits
Tolerance: +/- 15% for each root disease
Values: 1 to 99

2. Downloaded estimates of root disease

Root diseases were mapped and recorded individually by subplot on timberland plots visited last occasion. These data are on the old plot cards and printed records and may help map at the current occasion. When the current plot is remeasured, root disease data will be downloaded/printed and will be revised to reflect the situation at the next plot visit.

3. Mapping root diseases

Western OR, Western WA, and CA (North Coast only)

Define the boundary of an infection zone using straight lines connecting the boles of healthy-appearing trees on the perimeter of a root disease center. A healthy-appearing tree is defined by the following criteria:

- a) The tree lacks crown symptoms of root disease (reduced terminal growth increment, thinning or yellowing crown, or a distress cone crop present);
- b) The tree has a root disease-infected tree as its nearest neighbor on the side facing the infection center; and
- c) The tree has a healthy tree as its nearest neighbor on the side facing away from the infection center.

When determining the area infected by a root disease, do not exclude an island of healthy-appearing trees inside the infected area unless the trees in the island are all of non-host species; susceptible trees in an "island" are likely to be infected. Tally trees may require damaging agent and severity coding for root disease; this includes cases where a tally tree is not within the boundary of a mapped infection zone but, because of proximity to an infected tree or stump, requires a root disease agent code that has a severity rating of 1 (see page 175).

The following diagram shows how infection center boundaries would be defined in several situations.

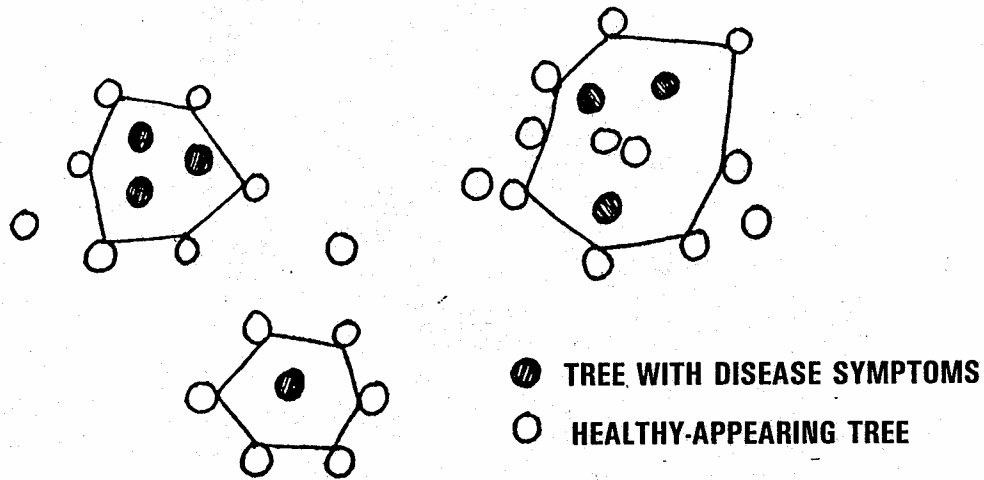

Mapped area of infection should include conifer sites that have no conifers present due to root disease. When mapping areas of infection, do not include areas of non-forest inclusions or area that will not support susceptible host species.

Map and estimate percent cover only if a disease is a primary cause of tree death. Do not map and estimate percent cover for secondary infections (e.g. Armillaria that invaded a tree that was killed by Phellinus). If you find evidence of a secondary agent, note the situation in Present Condition/Past Disturbance.

Sketch the boundaries on the subplot map diagram; shade the infected area, and label with the appropriate code:

Code	Causal fungus	Disease
PW	Phellinus weirii	laminated root disease
CW	Ceratocystis wagneri	black stain root disease (do not map)
FA	Fomes annosus	annosus root disease
AM	Armillaria ostoyae(mellea)	armillaria (shoestring) root disease
UK	Unknown	--
NO	None present	--

If there is evidence of root disease, but the specific disease cannot be identified, enter "UK" (unknown) for the disease code. Do not map or record Phytophthora lateralis (Port-Orford-cedar root rot) on the subplot diagram.

Eastern OR, and Eastern WA, and CA (except the North Coast)

On east-side (mixed conifer) stands where mapping contiguous areas is difficult, map a 30 foot radius circle around all trees and stumps infected with root disease. These circles may overlap. Include in the percent estimate for the annular area that is within 30 ft of an infected tree or stump even if that tree/stump is outside the annular plot being evaluated.

Use the codes and other mapping rules as described above.

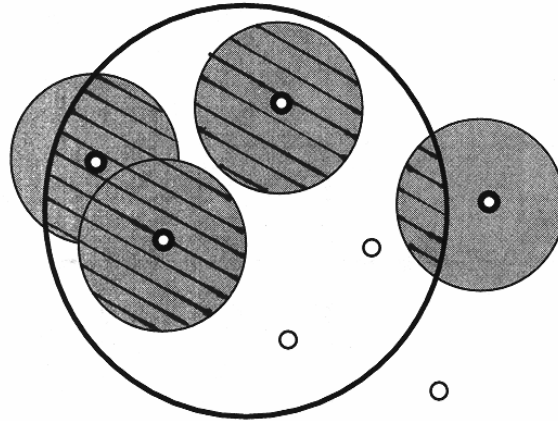

Estimate the percentage of area within the subplot/annular plot boundary (indicated by dashed lines in the diagram above)

4. Guide for identifying root diseases

See Appendix 17 for insect and disease identification information.

5. Estimating and recording root disease area percentages by condition class

Use the following steps to estimate by condition class, the percentage of the subplot area mapped with a root disease.

The following refers to mapping on the dot map on the back of the plotcard:

1. Each dark dot represents 0.23 percent of the area within the entire 58.9-ft subplot/annular plot.
2. Draw the root disease area boundary and count the number of dark dots within the 58.9-ft. annular plot boundary within each condition class. Count every other dark dot of those which fall directly on a boundary.
3. Multiply the number of dark dots from step 2 by 0.23 to get percent of the 58.9-ft. annular plot (including the subplot) in that condition class. Alternatively, count the number of dark dots from step 2; divide by 437 (total number of dark dots) and multiply by 100 to get the percent of the annular plot in that condition class.
4. Root disease mapping percentages are not divided into separate percents for the subplot and percent for the annular plot.

Item 19--Root disease severity rating

In addition to the root disease mapping described above, the annular plot is assigned a Root Disease Rating. Evaluate all accessible forestland area within the 58.9-ft radius annular plot boundary in Oregon, Washington, and California and assign the Root Disease Severity Rating that best describes the degree of root disease present.

When collected: All annular plots with an accessible forestland condition class

Field width: 1 digit

Tolerance: +/- 1 class

Values: 1 to 9

Code	Root disease severity rating
0	No evidence of root disease visible within 50ft. of the 58.9 ft. annular plot.
1	Root disease present within 50 feet of the annular plot, but no evidence of disease on the annular plot.
2	Minor evidence of root disease on the annular plot, such as suppressed tree killed by root

Annual Inventory 2004
 SUBPLOT ATTRIBUTES

	disease, or a minor part of the overstory showing symptoms of infection. Little or no detectable reduction in canopy closure or volume.
3	Canopy reduction evident, up to 20%; usually as result of death of 1 codominant tree on an otherwise fully stocked site. In absence of mortality, numerous trees showing symptoms of root disease infection.
4	Canopy reduction at least 20%; up to 30% as a result of root disease mortality. Snags and downed tress removed from canopy by disease as well as live trees with advance symptoms of disease contribute to impact.
5	Canopy reduction 30-50% as a result of root disease. At least half of the ground area of annular plot considered infested with evidence of root disease-killed trees. Annular plots representing mature stands with half of their volume in root disease-tolerant species usually don't go much above severity 5 because of the ameliorating effect of the disease-tolerant trees.
6	50-75% reduction in canopy with most of the ground area considered infested as evidenced by symptomatic trees. Much of the canopy variation in this category is generally a result of root disease-tolerant species occupying infested ground.
7	At least 75% canopy reduction. Annular plots that reach this severity level usually are occupied by only the most susceptible species. There are very few of the original overstory trees remaining although infested ground is often densely stocked with regeneration of susceptible species.
8	The entire annular plot falls within a definite root disease pocket with only one or very few susceptible overstory trees present.
9	The entire subplot falls within a definite root disease pocket with no overstory trees of the susceptible species present.

G. SEEDLING COUNT

Stocking and regeneration information are obtained by counting live seedlings within the 6.8 foot radius microplot located 90 degrees and 12.0 feet from each subplot center within each of the four subplots. Conifer seedlings must be at least 0.5 feet. in length and less than 1.0 inch at d.b.h./d.r.c. in order to qualify for *counting*. Hardwood seedlings must be at least 1.0 foot. in length and less than 1.0 inch at d.b.h./d.r.c. in order to qualify for *counting*. For western woodland species, each stem on a single tree must be less than 1.0 inch in d.r.c. Seedlings are counted in groups by species and condition class. Only count seedlings occurring in accessible forestland condition classes.

Count all live seedlings that have their base inside the microplot boundary regardless of vigor, damage, or closeness to other trees, but count only one seeding from a clump; a clump is 3 or more live stems that sprouted from a common root base (including stumps). Note: The selection criteria for seedling count differ from the selection criteria for seedlings on the trackable tree tally (page 150).

SEEDLING COUNT DATA ITEMS

Seedlings are counted within each accessible forestland condition class on each microplot. Record the following data items for each seedling count:

Item 1--SUBPLOT NUMBER

Use the procedures *and tolerances* outlined on page 41

Item 2--CONDITION CLASS NUMBER

Use the procedures *and tolerances* outlined on page 65

Item 3--SPECIES

Use the procedures and codes outlined on page 157.

When Collected: All counts of seedlings

Field width: 4 digits

Tolerance: No errors

Values: See page 157.

Item 4--SEEDLING COUNT

On each microplot, record the number of live tally tree seedlings, by species and condition class. Conifer seedlings must be at least 6.0 inches in length and less than 1.0 inch at DBH to qualify for counting. Hardwood seedlings must be at least 12.0 inches in length and less than 1.0 inch at DBH in order to qualify for counting.

For western woodland species, each stem on a single tree must be less than 1.0 inch at DRC.

Multiple "suckers" that originate from the same location, and stump sprouts are considered one seedling. Do not tally or count "layers" (undetached branches partially or completely covered by soil, usually at the base) as seedlings. Do not tally any seedlings that sprout from a live tally tree.

When Collected: Each accessible forestland condition class on each microplot

Field width: 3 digit

Tolerance: No errors for 5 or less per species, +/- 20% over a count of 5

Values:001 through 999

H. Mortality Assessment

These procedures are to be completed when the center of subplot 1 is in California (R5 NFS and non-NFS), or in off-National Forest in Oregon. In Washington, complete these procedures for off-National Forest plots that were part of the 2000 Western Washington or 2001 Eastern Washington periodic inventory remeasurement. Only subplots that were remeasured in 2000 and 2001 will be assessed for mortality in Washington. Mortality Assessment will not be done on R6 lands. The ownership at subplot 1 is used to determine if Mortality Assessment is completed. The field crew will visit all subplots established at the previous inventory to account for live trees that were measured and were ≥ 5.0 inches in diameter. Trees no longer alive include mortality, harvest, and culturally killed. In addition, trees that were measured in the last inventory and are alive, but suffering from Sudden Oak Death symptoms, will also be tallied by this system. Most previously established R5 CVS plots have 5 subplots. On the few that have 10, mortality is assessed at all 10 points.

On subplots 1 and 2, some (though not all) of the non-live trees may get tallied as part of the normal collection of tree data on the new fixed radius plots; however, because not all of them will, it is best to keep this section consistent for all the old subplots. This may result in some trees being tallied for both tree data and mortality.

A reasonable time is to be spent on this mortality assessment. A reasonable amount of time to spend completing this protocol on old subplots that do not overlap with current subplots is 1 hour if 1 person is doing this assessment, or one-half hour if 2 people are doing it. If after this time the field crew is not finished with the assessment and continuing with it will cause them to have to return to the plot for an additional day that they would not otherwise need to do, the crew is to stop assessment and record a tree history "9", meaning not found for the remaining trees that have yet to be assessed.

The following attributes are to be recorded:

Item 1--Line #

The data recorder will fill out this item.

Item 2--Tree #

Record the tree number that was put on the tree by the previous crew.

Item 3--Tree history

Record a tree history for each tree

Values:

Code	Tree History
1	Live tree
3	Culturally killed by humans. This does not include trees harvested.
5	Mortality. Trees that die naturally or by a non-human cause.
8	Harvested for use by humans.
9	Tree Not Found

Item 4--Cause of Death / Damaging Agent

Record a cause of death (COD) for all dead trees (Tree History = 3, 5, 8) tallied. COD and damaging agent codes are listed in the Trackable Tree section of this manual. Record a code of "31" for live trees affected by Sudden Oak Death.

I. Subplot disturbance

Item 1--Burn assesment

Record the code for the percentage of the 24.0 ft. subplot that shows evidence of having been burned since the previous inventory. On plots visited for the first time record evidence of burn within the past 5 years.

When collected: When CONDITION CLASS STATUS=2, and Nonforest Land Use=45 (R5 NFS chaparral)

Field width: 1 digit

Tolerance: No errors

Values:

Code	Burn Assesment
0	No evidence of fire
1	1 to 50 % of subplot burned
2	51 to 100 % of subplot burned

Item 2--Mechanical management assesment

Record the code for percentage of the 24.0 ft. subplot that shows evidence of having been affected by mechanical manipulation such as tractor use, shear, bulldozer, etc. since previous inventory or with the last 5 years on new plots.

When collected: When CONDITION CLASS STATUS=2, and Nonforest Land Use=45 (R5 NFS chaparral)

Field width: 1 digit

Tolerance: No errors

Values:

Code	Mechanical Management
0	No evidence of mechanical manipulation
1	1 to 50 % of subplot affected
2	51 to 100 % of subplot affected

J. Special Study 2004a

These items are to be completed on all plots in Oregon that are not located on R6 NFS lands.

Researchers from the Oregon Department of Forestry and other agencies, public interest groups, and forest land owners need information about streams, lakes, and streamside vegetation to periodically assess the condition and trends of Oregon's nonfederal forests and to develop policies and forest practice regulations related to fish habitat and habitat recovery efforts.

What defines a stream ?

A stream has to have a defined channel and not be an ephemeral, overland flow, or a road drainage system. The following is the regulatory definition defined in the Forest Practices Act:

"Stream" means a channel, such as a river or creek, that carries flowing surface water during some portion of the year.

- (a) For the purposes of the forest practice rules, streams include:
 - (A) The water itself, including any vegetation, aquatic life, or habitats therein;
 - (B) Beds and banks below the high water level which may contain water, whether or not water is actually present;
 - (C) The area between the high water level of connected side channels;

Annual Inventory 2004
 SUBPLOT ATTRIBUTES

- (D) Beaver ponds, oxbows, and side channels if they are connected by surface flow to the stream during a portion of the year; and
- (E) Stream-associated wetlands.
- (b) "Streams" do not include:
 - (A) Ephemeral overland flow (such flow does not have a channel); or
 - (B) Road drainage systems or water developments.

Forked streams will be treated as two separate streams. The smaller fork will be recorded as one stream, while the larger fork will be included with the stream below the fork.

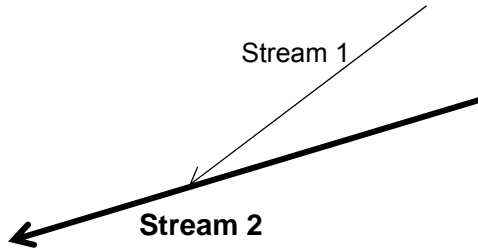

Lakes are bodies of water that are significantly wider than the stream channel at the outlet of the lake, and are permanent features (unlike ponds which are dependent on temporary dams that can come and go with seasonal peak flows.) Lakes also may not have an inlet that is easy to define. Ponds are considered part of the associated stream and will be measured as streams.

What defines a channel?

A "distinct bed" and "banks" scoured by water that periodically (may be dry in summer) or continually contains flowing water. The characteristics to look for are sediments and rounded gravels (opposed to angular gravel) showing evidence of periodic water flow.

A STREAM

NOT A STREAM

Channel has defined scour lines

Ephemeral flow and no defined channel

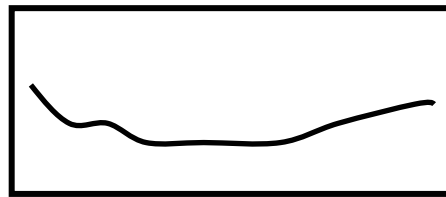
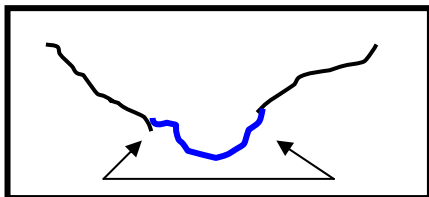

Rounded gravel; assortment of sizes

Angular gravel; similar sizes

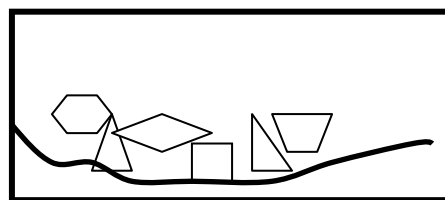
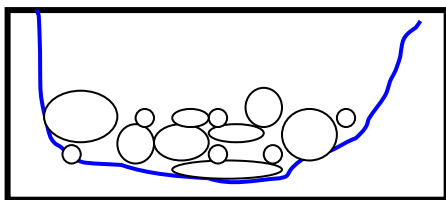

Bodies of water will be sampled on all non-NFS plots in Oregon with at least one accessible forestland condition class within any of the 58.9 foot radius subplots. A body of water must be within 215 horizontal feet of subplot center to be recorded, with a maximum of 2 recorded per subplot. The first body of water to be recorded should be the one closest to subplot center. The second body of water recorded should be the largest body of water within

Annual Inventory 2004
SUBPLOT ATTRIBUTES

215 horizontal feet of subplot center. If the first body of water recorded is also the largest, record the second largest as the second body of water. Number each body of water recorded with consecutive numbers. For each body of water measured, azimuth, distance, and slope will be measured from each subplot, regardless of condition classes present on each subplot (there does not need to be a forested condition class on that subplot). Each stream will also have a set of attributes that will be recorded once for the entire stream. These include, slope, channel bed type, and perennial/seasonal. Canopy cover, width, and depth will each be measured at three locations per stream.

Item 1--Stream Number

For all plots in Oregon that are not on NFS lands, with at least one accessible forestland condition class within any of the 58.9 foot radius subplots, consecutively number each body of water (including lakes) within 215 horizontal feet of subplot center. Beginning with subplot 1, first select the closest body of water to subplot center and number this stream number 1. Second, select the largest body of water within 215 horizontal feet. If the first body of water recorded is also the largest, record the second largest as the second body of water. Number the second body of water encountered as stream number 2. Continue to select up to two bodies of water per subplot using the same selection methods. Once a body of water has been assigned a number, continue to use that number when referring to that body of water throughout the plot. If there are no streams within 215 feet of any subplot center, record "0".

When collected: When STATE = 41 (Oregon) and when OWNER GROUP = 20, 30, or 40
Field width: 1 digit
Tolerance:
Values: 0 to 8

Item 2--Lake?

If a lake is either the closest or largest body of water to any of the subplot centers, it should be recorded and numbered just as streams are. If the body of water qualifies as a lake, record a "Y" in this field. The subplot measurements, Item 3--Distance to Stream, Item 4--Azimuth to Stream, and Item 5--Slope to Stream are the only measurements required for lakes.

When collected: When Stream number > 1
Field Width: 1 digit
Tolerance:
Values:

Y	The body of water is a lake
N	The body of water is not a lake (it is a stream)

Subplot Measurements

Item 3--Distance to Stream, Item 4--Azimuth to Stream and Item 5--Slope to Stream are to be measured for each of the two bodies of water selected per subplot.

Item 3--Distance to stream

Record a three digit code indicating the horizontal distance in feet from the closest edge of the active width of the water source to the subplot center.

When collected: When Stream Number >1
Field width: 3 digits
Tolerance:
Values: 000 to 215

Item 4--Azimuth to Stream

Record a three digit code indicating the azimuth from subplot center to the closest edge of the active width of the water source.

Annual Inventory 2004
SUBPLOT ATTRIBUTES

When collected: When Stream Number >1
Field width: 3 digits
Tolerance:
Values: 000 to 360

Item 5—Slope to Stream

Record a three digit code indicating the slope from subplot center to the closest edge of the active width of the water source.

When collected: When Stream Number >1
Field width: 3 digits
Tolerance:
Values: 000 to 140

Cross Section Measurements

Record Item 6--Active Width, Item 7--Active Width Maximum Depth and Item 8--Canopy Cover at three separate cross sections per stream recorded. These measurements will not be recorded for lakes. The first cross section for each stream is established at the location the stream comes closest to any of the subplot centers. The second cross section is established two active channel widths upstream from the first cross section, at a maximum of 60 feet upstream. The third cross section is established an additional two active channel widths upstream from the second cross section, at a maximum of another 60 feet upstream.

Item 6--Active Width

Record the width of active channel, to the nearest foot, and not the over-bank areas where excess water may have run during infrequent (once every three or more years) flow events. If the stream is greater than 30 feet wide, record "30". Record at each cross section location, for a total of three measurements per stream.

Active Width" defined: The active channel width corresponds to a peak streamflow that occurs on average once every one to two years. Locating the active width, while generally based on scientific principles, requires judgement when making a determination in the field. In alluvial streams (i.e. in low gradient streams in wider valleys) that have not been incised (i.e. downcut), the active mark is usually where the bank slope moderates from being steep to being more gentle or almost flat (Figure 1). Abrupt changes in vegetation are good clues to help determine the active channel width. Abrupt changes in texture of the bank material may also be clues. The active width is measured from one stream bank mark to the other. Features like large islands that would be dry even under active conditions need to be subtracted out.

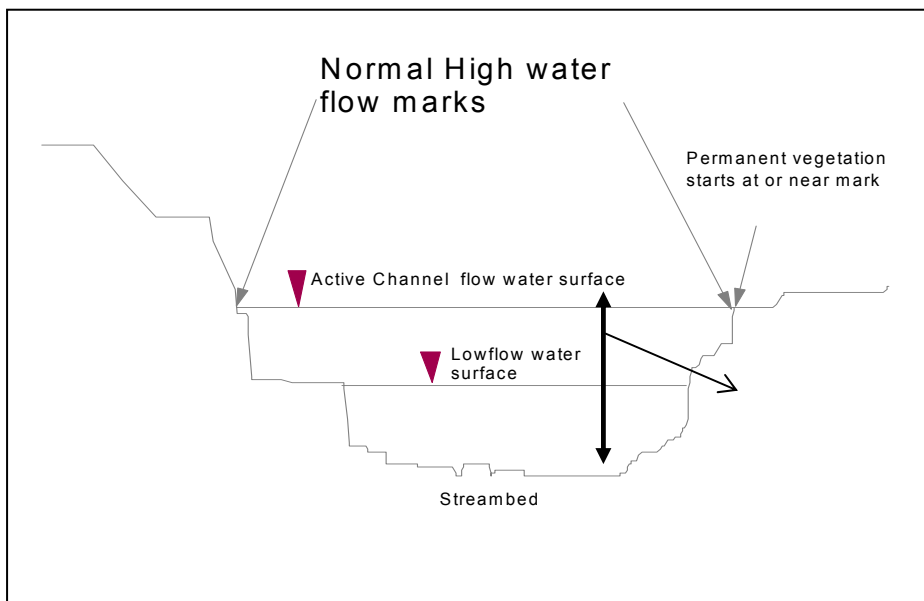

Annual Inventory 2004
 SUBPLOT ATTRIBUTES

For braided channels, the width of each fork is added together to get the total width of the channel. (The width of islands are subtracted out.)

When collected: When Stream Number >1
 Field width: 2 digits
 Tolerance:
 Values: 1 to 30

Item 7--Active Width Maximum Depth

Record the maximum depth of the channel cross-section at the active width to the nearest tenth of a foot. Measure from the deepest point to the normal high water flow marks (see Figure 1). Normal high water flow marks correspond to the peak streamflow that occurs on average every one to two years. Water may not be flowing at maximum depth at the time of visit. If the channel is less than one tenth of a foot deep, record 001. If the channel is too large to wade and measure, record "999". Only record a measured depth if the channel can be physically measured. Do not record estimated depths, instead record "999".

When collected: When Stream Number >1
 Field Width: 3 digits
 Tolerance:
 Values: 001 to 999

Item 8--Canopy Cover

Measure the canopy cover of all vegetation, including, trees, shrubs, forbs, grasses and graminoids, at each cross section location. Record percent cover using the Daubenmire method (see Chapter VIII. Vegetation Profile). Record cover for the width of the active channel, one channel width upstream and one channel width downstream, with a maximum of 30 feet upstream and 30 feet downstream.

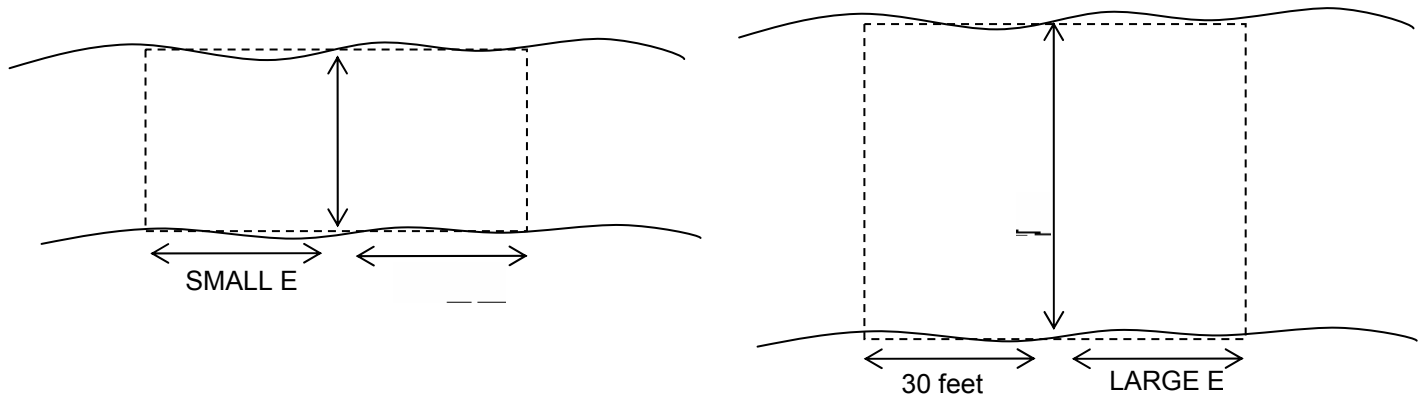

When collected: When Stream Number >1
 Field width: 1 digit
 Tolerance:
 Values:

1	<25% cover
2	25%-75% cover
3	>75% cover

Lower-most Cross Section Measurements

Record Item 9--Perennial/Seasonal, Item 10--Slope and Item 11--Dominant Channel Bed Type at the lower-most cross-section, which is the cross section furthest down stream. These measurements are recorded only once per stream.

Item 9--Perennial/Seasonal

Based on observed flow and time of the year, is the stream likely to be flowing on July 16?

When collected: When Number >1

Annual Inventory 2004
SUBPLOT ATTRIBUTES

Field width: 1 digit

Tolerance:

Values:

0	Stream is very unlikely to have surface flow on July 16
1	Stream is unlikely to have surface flow on July 16
2	Stream is likely to have flow on July 16
3	Stream is very likely to have flow on July 16

Item 10--Slope

Measure the slope of the stream, facing upstream with a clinometer, in percent. Sight to a point at eye height about 100 feet up stream, or as far as you can see, whichever is shorter.

When collected: When Stream Number >1

Field width: 3 digits

Tolerance:

Values: 0 to 140

Item 11--Dominant Channel Bed Type

Classify the dominant channel bed substrate. Looking upstream for a distance 100 feet, or as far as you can see, whichever is shorter. Characterize the dominant (>50% of the visible substrate) type in the channel bed. The dominant type is the type that comprises the largest surface area of the channel bed. Remember, it is easy to over estimate channel bed type because the larger particles tend to distract from the smaller particles.

When collected: When Stream Number >1

Field width: 1 digit

Tolerance:

Values:

1	Fines, Sand, and Fine Gravel <16mm (silt to pea size)
2	Coarse Gravel and Cobbles 16mm-250mm (marble to basketball size)
3	Boulders/Bedrock >250mm (basketball size and greater)

VI. CONDITION CLASS ATTRIBUTES

TABLE OF CONTENTS

VI. CONDITION CLASS ATTRIBUTES	63
Item 1--CONDITION CLASS NUMBER	65
CONDITION CLASS STATUS	65
Item 2--CONDITION CLASS STATUS	65
Instructions for determining condition classes differing in condition class status:	66
Condition class status definitions:	68
1. Accessible forest land	68
2. Nonforest land	70
3. Noncensus water	71
4. Census water	71
Item 3--CONDITION NONSAMPLED REASON	71
CONDITION CLASS DEFINING (DELINEATION) VARIABLES for accessible forest land:	72
Item 4--RESERVED STATUS	75
Item 5 --OWNER GROUP	75
Item 6--FOREST TYPE	75
Item 7--STAND SIZE CLASS	76
Item 8--REGENERATION STATUS	77
Item 9--TREE DENSITY	77
NON-DELINEATING (ANCILLARY) VARIABLES for accessible forest land	78
Item 10--Current Ground Land Class (GLC)	78
Item 11--OWNER CLASS	79
Item 12--PRIVATE OWNER INDUSTRIAL STATUS	80
Item 13--ARTIFICIAL REGENERATION SPECIES	81
Item 14--STAND AGE	81
Item 15--Stand structure	82
Item 16--DISTURBANCE 1	83
Item 17--DISTURBANCE YEAR 1	84
Item 18--DISTURBANCE 2	84
Item 19--DISTURBANCE YEAR 2	84
Item 20--DISTURBANCE 3	84
Item 21--DISTURBANCE YEAR 3	84
Item 22--Historical disturbance 1	84
Item 23--Historical disturbance year 1	84
Item 24--Historical disturbance 2	84
Item 25--Historical disturbance year 2	84
Item 26--Historical disturbance 3	85
Item 27--Historical disturbance year 3	85
Item 28--TREATMENT 1	85
Item 29--TREATMENT YEAR 1	86
Item 30--TREATMENT 2	86
Item 31--TREATMENT YEAR 2	86
Item 32--TREATMENT 3	86
Item 33--TREATMENT YEAR 3	87
Item 34--Historical treatment 1	87
Item 35--Historical treatment year 1	87
Item 36--Historical treatment 2	87
Item 37--Historical treatment year 2	87
Item 38--Historical treatment 3	87
Item 39--Historical treatment year 3	87
Item 40--Stumps present	87
Item 41--Evidence of fire	87
Item 42--CONDITION CLASS PHYSIOGRAPHIC CLASS	88
Item 43--Soil depth	88

CONDITION CLASS ATTRIBUTES

Item 44--Stand condition	88
Item 45--Plant association.....	89
Washington Plant Association Guides:	90
Oregon Plant Association Guides:	91
California Plant Association Guides:	93
Item 46--Mixed conifer site.....	93
Item 47--Stockability indicator set	93
Mapping (condition class defining) variables for nonforest land conditions:.....	94
Determining condition classes within nonforest land:	94
Item 48--PRESENT NONFOREST LAND USE.....	94

VI. CONDITION CLASS ATTRIBUTES

Condition class attributes record information about the land type that allows grouping and analysis of similar land types. They also record information about forest structure, composition, and disturbance, which allows analysts to group similar forest types, understand management practices used by different landowners, examine effects of disturbance, and classify land types on which little data is collected--for example, when a condition class only occurs on a small portion of one subplot.

On revisited plots, some attributes were recorded at the previous visit and are downloaded/printed for condition class 1. Some may require updating.

See Appendices 1 & 3 for special rules about nonforest plots/condition classes on R5 and R6 NFS lands.

Condition classes are delineated in three steps:

- (1) Plot area is divided into condition classes based on differences in condition class status.
- (2) Accessible forest land condition classes condition class status are further divided by differences in 6 mapping variables.
- (3) Nonforest land condition classes are further divided by differences in nonforest land use.

Accessible forest land condition classes can only be delineated (separated from other condition classes) by differences in the following 6 items:

RESERVED STATUS
OWNER GROUP
FOREST TYPE
STAND SIZE CLASS
REGENERATION STATUS
TREE DENSITY

Item 1--CONDITION CLASS NUMBER

On a plot, assign and record a number for each condition class. The condition class at plot center (the center of subplot 1) is designated condition class 1. Other condition classes are assigned numbers sequentially at the time each condition class is delineated.

Number condition classes sequentially as encountered going from subplot 1 thru 4, numerically.

When collected: All condition classes

Field width: 1 digit

Tolerance: No errors

Values: 1 to 9

CONDITION CLASS STATUS

The first step in delineating condition classes is to recognize differences in CONDITION CLASS STATUS.

Item 2--CONDITION CLASS STATUS

Record the code that describes the status of the condition. *Record for all condition classes sampled on a plot.* The instructions following apply when delineating condition classes that differ by CONDITION CLASS STATUS.

When collected: All condition classes

Field width: 1 digit

Tolerance: No errors

Values:

CODE	CONDITION CLASS STATUS
1	Accessible forest land
2	Nonforest land
3	Noncensus water
4	Census water
5	Nonsampled

Instructions for determining condition classes differing in condition class status:

The following guidelines, and those regarding boundaries listed on page 72 apply when delineating condition classes that differ by condition class status.

The most common difference is adjacent accessible forest land and nonforest land. Adjacent accessible forest land and nonforest land condition classes are recognized only if each of the two prospective condition classes is at least 1.0 acre in size, and each is at least 120.0 feet in width. These size and width minimums apply to both accessible forest land and nonforest land.

Within an accessible forest land condition class, unimproved roads, rock outcrops, and natural nonforest openings less than 1.0 ac in size and less than 120.0 feet in width are considered forest land and are not delineated and classified as a separate nonforest condition class.

Within a nonforest land condition class, forested areas or linear strips of trees less than 1.0 acre in size and less than 120.0 feet in width are considered part of the nonforest condition class.

Five exceptions to these size and width requirements apply:

1. *Cultural developments and Rights-of-Ways*: human-caused nonforest land condition classes such as homes or cabins that are less than 1.0 acre in size and 120.0 feet in width and are surrounded by forest land. There are three kinds of developed nonforest inclusions that do not have to meet area or width requirements.
 - a) Improved roads: paved roads, gravel roads, or improved dirt roads regularly maintained for long-term continuing use *by normal passenger vehicles. Generally constructed using machinery. The area where the original topography has been disturbed by cutbanks and fill is considered part of the road, if that area is maintained.* Unimproved traces and roads created for skidding logs are not considered improved roads.
 - b) Maintained rights-of-way: corridors created for railroads, power lines, gas lines, and canals that are periodically treated to limit the establishment and growth of trees and shrubs. Areas under powerlines are considered maintained right of way even if no evidence of vegetation treatment is currently evident.
 - c) Developments: structures and the maintained area next to a structure, all less than 1.0 acre in size and surrounded by forest land. Examples of developments are houses or trailers on very small lots, communication installations in a small cleared area within forest land, and barns and sheds.
2. Distinct, alternating strips of forest and nonforest land: this situation occurs when a plot or subplot samples a condition class that is less than 1.0 acre in size and less than 120.0 feet in width. The condition class is one of a series of parallel strips of forest and nonforest land in which none of the strips meet the minimum width requirement. This exception applies only to nonforest conditions that are not listed under #1, e.g., improved roads, maintained rights-of-way, and developments.

For many small intermingled strips, determine the total area that the alternating strips occupy, and classify according to the CONDITION CLASS STATUS (forest land or nonforest land) that occupies the greater area. If the area of alternating strips is so large or indistinct as to make a total area determination impractical, then classify the sample as forest land.

For two alternating strips of forest and nonforest between two qualifying areas of nonforest land and forest land, see *the figure below*. The figure delineates the boundary between the forest and nonforest condition classes for four different examples. The plot center defines the plot condition for all strips covered by the arrow. Any subplot that falls in the alternating strips uses the rule. Any subplot that falls in assigned nonforest / forest is assigned that type.

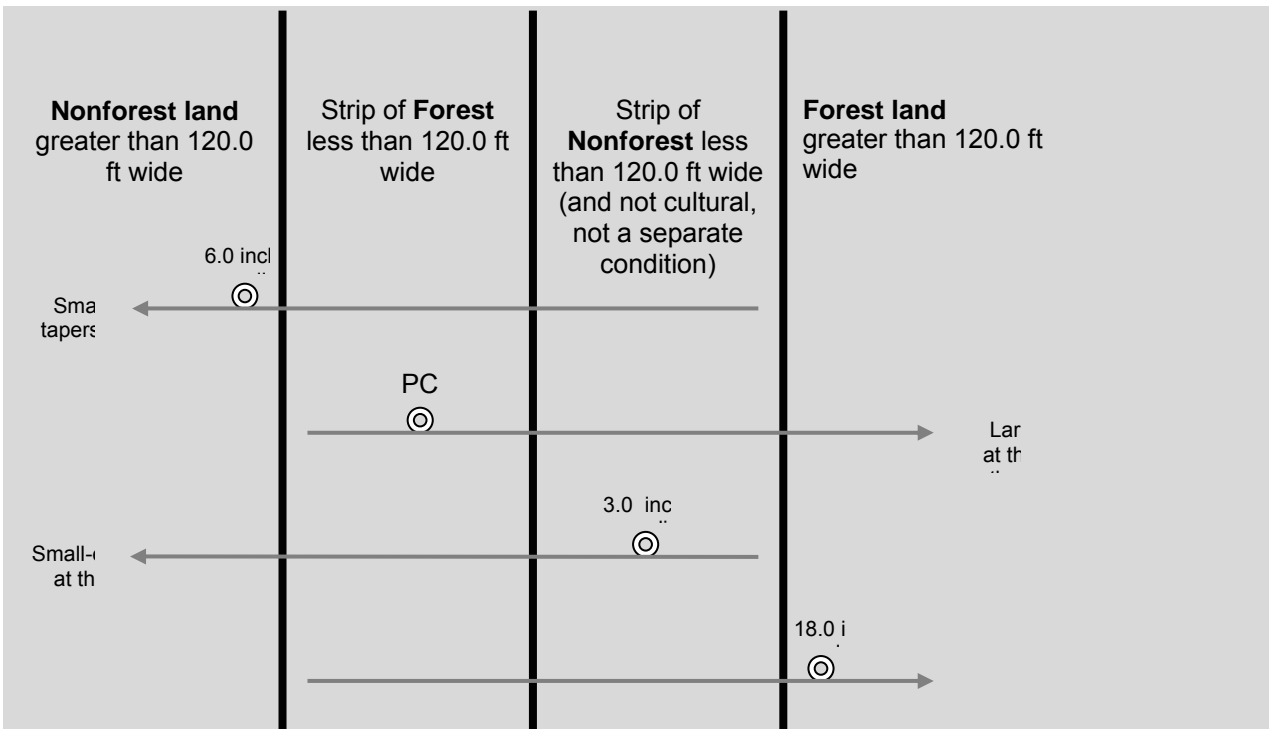

Example of alternating strips of forested and non forested conditions

3. The 120.0 foot minimum width for delineation does not apply when a corner angle is 90 degrees or greater.

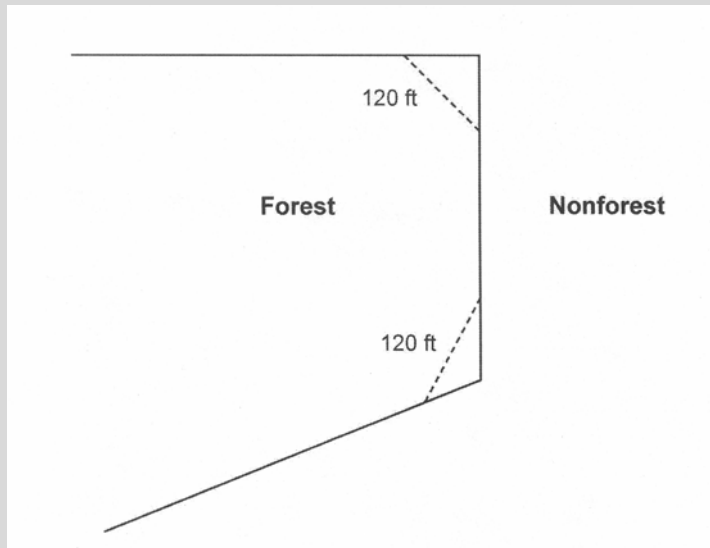

Illustration of the 90 degree corner rule. The dotted lines do not create nonforest conditions.

4. Linear water features: natural water features that are linear in shape such as streams and rivers. A linear water feature must meet the definition for Census or noncensus water to be nonforest area. Therefore, a linear water feature must be at least 30.0 feet wide and cover at least 1.0 acre. The width of a linear water feature is measured across its channel between points on either side up to which water prevents the establishment and survival of trees. To determine whether a linear water feature qualifies as nonforest, rely on all available information on hand such as aerial photos, topographic maps, past survey land calls, and ocular estimates at the current survey visit. Linear water features, that do not meet the definition for Census or noncensus water should be classified as forest land only if bounded by forest land on both

shores. Crews are NOT expected to measure the length of a linear water feature to determine if it meets the 1.0 acre requirement; use professional judgment and common sense on any linear water feature. *A 30 ft wide stream needs to be 1452 ft long to be an acre in size.*

5. Nonsampled conditions within accessible forest land are delineated, regardless of size, as a separate condition.

Condition class status definitions:

1. Accessible forest land

Land that is within the population of interest is accessible, is on a subplot that can be occupied at subplot center, can safely be visited, and meets at least one of the two following criteria:

- (a) the condition is at least 10-percent stocked by trees of any size (APPENDIX 7 -- TREE SPECIES LISTS) or has been at least 10-percent stocked in the past. Additionally, the condition is not subject to nonforest use(s) that prevent normal tree regeneration and succession such as regular mowing, *current* intensive grazing, or recreation activities;

or

- (b) in several western woodland species (*denoted with a "w" in APPENDIX 7 -- TREE SPECIES LISTS on page 279 and listed below*) where stocking cannot be determined, and the condition has at least **5 percent crown cover by trees of any size**, or has had at least 5 percent cover in the past. Additionally, the condition is not subject to nonforest use that prevents normal regeneration and succession such as regular mowing, chaining, or recreation activities.

Woodland	Code	Common Name	Genus	Species
W	62	California juniper	Juniperus	californica
W	65	Utah juniper	Juniperus	osteosperma
W	66	Rocky Mountain juniper	Juniperus	scopulorum
W	106	common pinyon	Pinus	edulis
W	133	singleleaf pinyon	Pinus	monophylla
W	134*	border pinyon	Pinus	discolor
W	140*	Mexican pinyon pine	Pinus	cembroides
W	321	Rocky Mountain maple	Acer	douglasii
W	475	curlleaf mountain-mahogany	Chrysolepis	ledifolius
W	756	Western honey mesquite	Prosopis	glandulosa var. torreyana
W	757	velvet mesquite	Prosopis	velutina
W	758	screwbean mesquite	Prosopis	pubescens
W	814*	Gambel oak	Quercus	gambelii

* unlikely to be found in PNW region

To qualify as forest land, the prospective condition must be at least 1.0 acre in size and 120.0 feet wide measured stem-to-stem from the outer-most edge. Forested strips must be 120.0 feet wide for a continuous length of at least 363.0 feet in order to meet the acre threshold. Forested strips that do not meet these requirements are classified as part of the adjacent nonforest land.

Transition zones and forest/nonforest encroachment. When an accessible forest land condition encroaches into a nonforest condition, the border between forest and nonforest is often a gradual change in tree cover or stocking with no clear and abrupt boundary. In addition, it may be difficult to determine exactly where the forested area meets the minimum stocking criteria and where it does not. For these cases, determine where the land clearly meets the 10 percent minimum forest land stocking, and where it clearly is less than required stocking; divide the zone between these points in half, and determine the side of the zone on which the subplot center is located. Classify the condition class of the subplot based on this line.

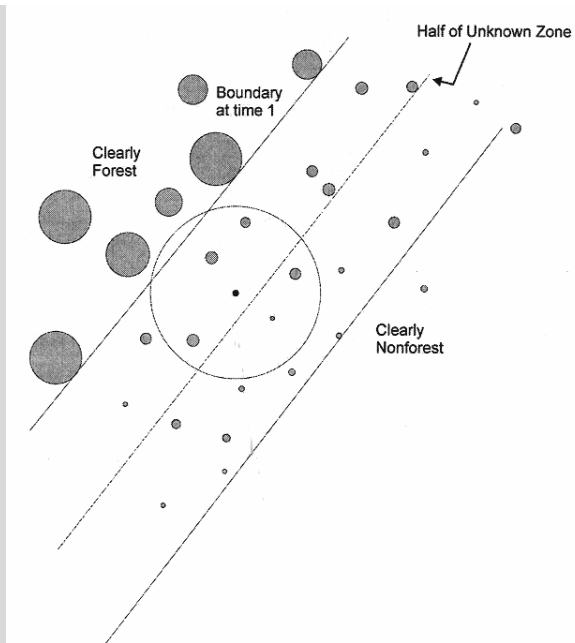

Example of classifying the condition class of the subplot in a transition zone with forest/nonforest encroachment.

For example, at measurement time 1, a clear and distinct boundary existed between the forest and nonforest condition classes. At time 2, however, there now exists a zone of regeneration or small diameter trees between the previous forest condition and where the nonforest clearly remains. If the zone of encroachment is clearly stocked where it meets the nonforest, classify the entire zone as forest. If the zone is clearly nonforest up to the original stand, call it all nonforest. If the encroachment or transition zone is not clearly stocked where it meets the nonforest, determine where it is clearly stocked (forest) and where it is clearly not stocked (nonforest); divide this zone in half, and classify the entire subplot based on which side of the line the subplot center falls.

Treated strips – Occasionally, crews will come across plantations of trees, in which rows of trees alternate with strips of vegetation that have been bulldozed, mowed, tilled, treated with herbicide, or crushed. Because these strip treatments are conducted to optimize growth or to release the stand, the areas are considered forest land, and the treatment is considered a timber stand improvement operation. Do not confuse these practices with similar treatments on nonforest lands such as yards or rights-of-way. Contact with the landowner may help determine the intent of a treatment.

Indistinct boundary due to the condition minimum-width definition: Do not subdivide subplots where a condition class may change due only to the forest vs. nonforest minimum width (120.0 feet) definition. Although the point where the definition changes from forest to nonforest creates an invisible “line” between conditions, **this definitional boundary is not distinct and obvious.** See *the figures below*. Where the point of the definition change occurs on the subplot, determine only if the subplot center is on the forest or nonforest side of that approximate boundary, and classify the entire subplot based on the condition of the subplot center. If the boundary crosses through the center of the subplot, classify the subplot as the condition it most resembles. If the boundary occurs between subplots, classify each subplot based on its relation to the definitional boundary.

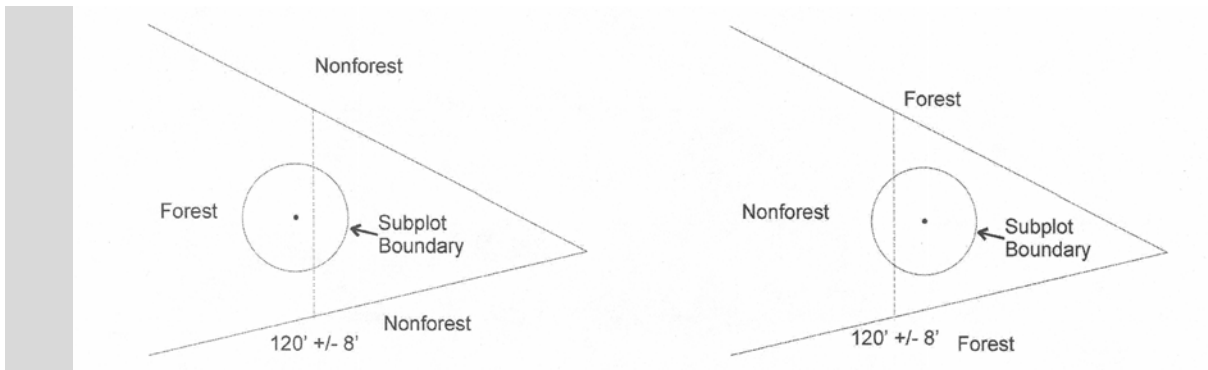

Forest condition narrows within a nonforest condition. Examine the location of the subplot center in reference to the approximate line where the forest narrows to 120.0 feet wide. In this example the entire subplot is classified as forest.

Nonforest condition narrows within a forest condition. Examine the location of the subplot center in reference to the approximate line where the non forest narrows to 120.0 feet wide. In this example the entire subplot is classified as forest.

Land may be developed for nonforest use even though tree cover is present. Indications of nonforest use may include the presence of fences or structures, the clearing of stumps, current extreme grazing, the absence of forest vegetation, evidence of human habitation and use around maintained structures such as landscaping, gardens, lawns, and play areas. The absence of forest vegetation means that some or all layers of the vegetation present--trees, shrubs and forbs--differ from what one would expect on forest land undisturbed by nonforest use; for example, a fenced, farm-lot may have forest trees present, but if extreme, sustained grazing has severely diminished or eliminated forest shrub and forb communities and tree regeneration is stifled, the farm-lot is likely nonforest. (In the Pacific Northwest and California, grazing, common on forest lands, is rarely reason to classify a plot as "developed for nonforest use" unless a situation similar to the example is encountered).

2. Nonforest land

Nonforest land is any land within the sample that does not meet the definition of accessible forest land or any of the *other* CONDITION CLASS STATUS values defined *below*. To qualify, the area must be at least 1.0 acre in size and 120.0 feet wide, with 5 exceptions discussed *starting on page 66*. Do not consider evidence of "possible" or future development or conversion. A nonforest land condition will remain in the sample and will be examined at the next occasion to see if it has become forest land.

On all field visited plots with an accessible forest land condition class in California, Oregon or Washington, map all of the nonforest condition classes present on the 58.9-foot fixed-radius at each established subplot on the 4-subplot standard layout that has an accessible forest land condition class. Do not combine nonforest condition classes present. Example: if nonforest--urban land and nonforest--cropland are both present within a 58.9-foot fixed-radius plot, map each nonforest land use as a separate condition class. On subplots with no accessible forest land condition classes within the 58.9 ft radius, record only the nonforest land use at the subplot center. All Nonforest land condition classes are assigned a use code see Item 48--PRESENT NONFOREST LAND USE on page 94.

Plots that are entirely nonforest fall into one of the following three categories:

1. The plot is field visited on the ground.
 PRESENT NONFOREST USE is collected at each subplot center.
 GPS coordinates are collected.
 A plot file is created in the field data recorder.
2. The plot is field visited and viewed from a distance.
 PRESENT NONFOREST USE is collected for each subplot center.
 A plot file is created in the field data recorder.
3. The plot is not field visited.
 PRESENT NONFOREST USE is collected for each subplot center.
 A plot data file is created in the office.

3. Noncensus water

Lakes, reservoirs, ponds, and similar bodies of water 1.0 acre to 4.5 acres in size. Rivers, streams, canals, etc., 30.0 ft to 200 ft wide.

If a subplot center (including subplot 1) lands in Noncensus water, the entire subplot is considered Noncensus water and is classified as a condition class with CONDITION CLASS STATUS = 3 (Noncensus water). No field measurements are made on that subplot. Establish and measure other subplots following normal procedures.

If the center of a subplot is accessible, but the subplot has Noncensus water present within it's 58.9-foot fixed-radius plot; 1) Map the Noncensus water area as a separate condition class. 2) Record the segment lengths of any CWD transects that extend into the noncensus water condition class. 3) Use normal procedures to map and measure other condition classes.

4. Census water

Lakes, reservoirs, ponds, and similar bodies of water 4.5 ac in size and larger; and rivers, streams, canals, etc., more than 200 ft wide (1990 U.S. Census definition).

If a subplot center (including subplot 1) lands in Census water, the entire subplot is considered Census water and is classified as a condition class with CONDITION CLASS STATUS = 4 (Census water). No field measurements are made on that subplot. Establish and measure other subplots following normal procedures.

If the center of a subplot is accessible, but the subplot has Census water present within it's 58.9-foot fixed-radius plot; 1) Map the Census water area as a separate condition class. 2) Record the segment lengths of any CWD transects that extend into the Census water condition class. 3) Use normal procedures to map and measure other condition classes.

Item 3--CONDITION NONSAMPLED REASON

For portions of plots that cannot be sampled (CONDITION CLASS STATUS = 5), record one of the following reasons.

When collected: When CONDITION CLASS STATUS = 5

Field width: 2 digits

Tolerance: No errors

MQO: At least 99% of the time

Values:

Code	Nonsampled Reason
01	Outside U.S. boundary – Assign this code to condition classes beyond the U.S. border.
02	Denied access area – Any area within the sampled area of a plot to which access is denied by the legal owner, or to which an owner of the only reasonable route to the plot denies access. There are no minimum area or width requirements for a condition class delineated by denied access. Because a denied-access condition can become accessible in the future, it remains in the sample and is re-examined at the next occasion to determine if access is available. In some regions denied access plots may be replaced; check with the field supervisor regarding regional protocols for plot replacement.
03	Hazardous situation – Any area within the sampled area on plot that cannot be accessed because of a hazard or danger, for example cliffs, quarries, strip mines, illegal substance plantations, temporary high water, etc. Although the hazard is not likely to change over time, a hazardous condition remains in the sample and is re-examined at the next occasion to determine if the hazard is still present. There are no minimum size or width requirements for a condition class delineated by a hazardous condition.
10	Other – This code is used whenever a plot or condition class is not sampled due to a reason other than one of the specific reasons listed. A field note is

	required to describe the situation.
--	-------------------------------------

Denied access area

If a subplot center (including subplot 1) lands in a access denied area, the entire subplot is considered access denied and is classified as a condition class with CONDITION NONSAMPLED REASON = 2 (denied access area). No field measurements are made on that subplot. Establish and measure other subplots following normal procedures.

If the center of a subplot is accessible, but the subplot has access denied area present within it's 58.9-foot fixed-radius plot, 1) map the access denied area as a separate condition class, 2) record the segment lengths of any CWD transects that extend into the access denied condition class. 3) use normal procedures to map and measure other condition classes.

Hazardous situation

A plot or subplot is hazardous according to the crew's judgment.

If a subplot center (including subplot 1) lands in a hazardous area, the entire subplot is considered hazardous and is classified as a condition class with CONDITION NONSAMPLED REASON = 3 (hazardous situation). No field measurements are made on that subplot. Establish and measure other subplots following normal procedures.

If the center of a subplot is accessible, but the subplot has hazardous area present within it's 58.9-foot fixed-radius plot, 1) map the hazardous area as a separate condition class, 2) record the segment lengths of any CWD transects that extend into the hazardous condition class. 3) do not estimate, or 'rough in' tree, vegetation, or other data on the hazardous portion. 4) follow normal field instructions to the extent safely possible to map and measure other condition classes.

CONDITION CLASS DEFINING (DELINEATION) VARIABLES for accessible forest land:

Instructions: Determining condition classes within accessible forest land

Any condition class sampled as accessible forest land (*Condition class status = 1*) may be further subdivided, **in order of listed priority**, into smaller condition classes if distinct, contrasting condition classes are present because of variation within the sampled area in any of the following attributes:

RESERVED STATUS
OWNER GROUP
FOREST TYPE
STAND SIZE CLASS
REGENERATION STATUS
TREE DENSITY

Specific criteria apply for each of the six attributes and are documented by attribute in Items 4 to 9. "Stands" are defined by plurality of stocking for all live trees that are not overtopped.

Additionally, each separate forest condition class recognized within accessible forest land must be at least 1.0 acre in size and at least 120.0 feet in width. If prospective contrasting forest land condition classes do not each meet these minimum size and width requirements, the most similar prospective conditions should be combined until these minimums are attained.

No other attribute shall be the basis for recognizing contrasting condition classes within accessible forest land. For each condition class recognized, many "ancillary attributes" that help describe the condition will be collected, but will not be used for delineation purposes (see Items 10+).

General instructions for delineating condition classes within accessible forest lands:

1. Distinct boundary within an annular plot (if applicable), subplot or microplot: Separate condition classes ARE recognized if, within a subplot, two (or more) distinctly different condition classes are present and delineated by a distinct, abrupt boundary. The boundary is referenced, see *page 45*.

2. Indistinct boundary within a subplot: Separate condition classes are NOT recognized if the prospective condition classes abut along an indistinct transition zone, rather than on an abrupt, obvious boundary. Only one condition is recognized, and the subplot is classified entirely as the condition it most resembles.

Example: The four subplots all sample only accessible forest land. Subplots 1, 3, and 4 sample what is clearly a stand of large diameter trees. Subplot 2 falls in the middle of a stand size transition zone. In the zone, the large diameter stand phases into a sapling stand.

Subplot 2 must not be divided into two condition classes on the basis of stand size. Instead, it is treated entirely as part of the large diameter condition class or is assigned entirely to a new condition class that is classified as a seedling/sapling stand. The latter occurs only if the crew thinks the entire subplot is more like a stand of seedlings/saplings than a stand of large diameter trees; then the boundary between the large and small diameter stands is assumed to occur between and not on the subplots.

3. A boundary or transition zone between fixed radii plots that sample distinctly different condition classes: Separate condition classes are recognized and recorded when a valid attribute obviously differs between two fixed radius plots, but a distinct boundary or indistinct transition zone exists outside the sampled (fixed-radius) area of the subplots. In such cases, a boundary, if present, is not referenced.

Example: The northernmost subplot (2) samples entirely accessible forest land. The other three subplots, 1, 3, and 4, fall clearly in a nonforest meadow. Between subplot 1 and 2 is a transition zone; the number of trees present goes from none to what clearly represents at least 10-percent tree stocking. Two condition classes are sampled: accessible forest land sampled on subplot 2, and nonforest land sampled on the other subplots.

4. **Riparian forest area**: A riparian forest area is defined as a forest area between 30.0 and 120.0 feet wide, and 1.0 acre or more in size, cumulative, but not necessarily present on both sides of and adjacent to a naturally occurring or artificially created body of water or watercourse with continuous or intermittent flow. Riparian forest areas may be associated with but not limited to streams, rivers, lakes, sloughs, seeps, springs, marsh, beaver ponds, sink holes, cypress domes and ponds, man-made ditches and canals. **A riparian forest area must be associated “within forest” and contain at least one distinct and obvious change in a condition class delineation attribute from its adjacent accessible forest land condition class.**

Note: When the width of forest adjacent to a stream is between 120.0 feet and 150.0 feet and the width of the riparian forest is at least 30.0 feet wide, the rules for identifying the non-riparian forest (at least 30.0 feet but less than 120.0 feet) need to be modified. The non-riparian forest can be between 30.0 feet and 120.0 feet and mapped as a separate condition as long as it meets the criteria for delineating a separate condition class, otherwise it will be an inclusion in the riparian forest condition class.

A riparian area (ie. a band of alder trees along a creek within a Douglas fir condition class) is typically different from the surrounding forest because of forest type. However, a change in any of the 6 condition class delineating variables makes the riparian area a candidate for a riparian area condition class. A riparian condition class only needs to be at least 30.0 ft wide instead of the standard 120.0 ft. It still must be at least 1.0 ac in size, and must be surrounded by forest on at least one side.

Because chaparral is considered nonforest, riparian areas through chaparral must qualify as accessible forest land (120 ft wide and 1 ac in size) on their own in order to be delineated as a separate condition class.

An area 30 ft wide needs to be 1452 ft long to be an acre in size. An area 60 wide needs to be 726 ft wide, and an area 90 ft wide needs to be 484 ft long.

Annual Inventory 2004
 CONDITION CLASS ATTRIBUTES

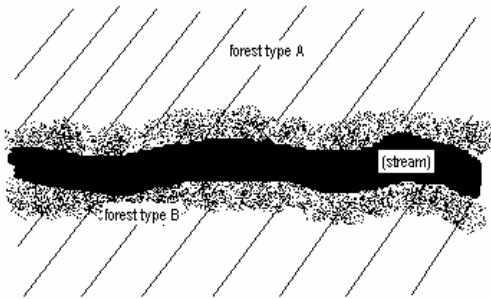

If the stream is > 30.0 feet wide, forest type B is a separate condition class (riparian) if either of the two widths of the bands falls between 30.0 feet and 120.0 feet wide and is ≥ 1.0 acre in size.

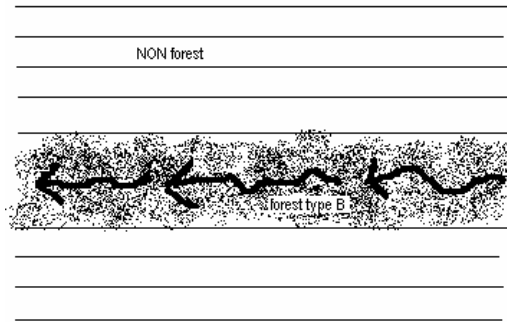

In a non-forested area, a band of forest type B that is < 120.0 feet wide is NOT considered a riparian area. It is not a separate condition class at all.

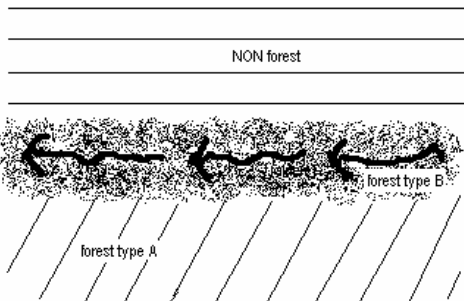

Forest type B is a separate condition class (riparian) if the band of it is between 30.0 feet and 120.0 feet wide, and is ≥ 1.0 acre in size.

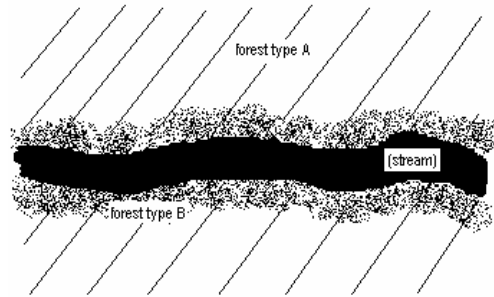

If the stream is < 30.0 feet wide, forest type B is a separate condition class (riparian) if the sum of the two widths of the bands falls between 30.0 feet and 120.0 feet wide, and is ≥ 1.0 acre in size.

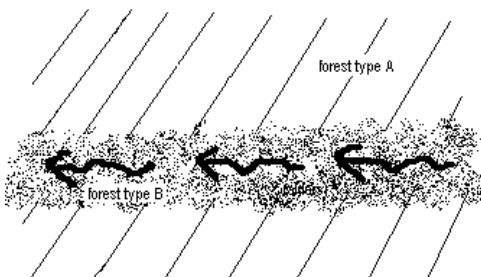

Forest type B is a separate condition class (riparian) if the band of it is between 30.0 feet and 120.0 feet wide, and is ≥ 1.0 acre in size.

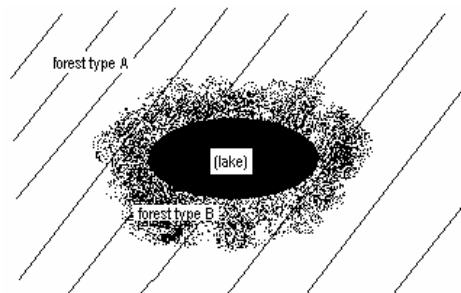

Forest type B is a separate condition class (riparian) if the band of it is between 30.0 feet and 120.0 feet wide, and is ≥ 1.0 acre in size.

CONDITION CLASS ATTRIBUTES

Record the code that identifies the reserved designation for the condition. Reserved land is withdrawn by law(s) prohibiting the management of land for the production of wood products (not merely controlling or prohibiting wood harvesting methods). Such authority is vested in a public agency or department, and supersedes rights of ownership. The prohibition against management for wood products cannot be changed through decision of the land manager (management agency) or through a change in land management personnel, but is permanent in nature

Such areas include Congressional designated wilderness areas, National Parks, state parks, or other lands protected by law or deed. 2004 note: private owners such as the Nature Conservancy may have areas of land on which timber harvest is prohibited by deed. Record land as reserved only if the landowner has verified this status or if somehow (i.e. posted sign) it is otherwise clearly defined.

When collected: All accessible forestland condition classes (CONDITION CLASS STATUS = 1)

Field width: 1 digit

Tolerance: No errors

Values:

Code	Reserve Status
0	Not reserved
1	Reserved

Item 5 --OWNER GROUP

Record the OWNER GROUP code identifying the ownership (or the managing Agency for public lands) of the land in the condition class. Conditions will be delineated based on changes in OWNER GROUP only; separate conditions due to changes in OWNER GROUP are recognized only where differences can be clearly identified on the ground when visiting the plot.

When collected: *All condition classes on plots with at least one accessible forest land condition class*

Field width: 2 digits

Tolerance: No errors

Values:

Code	Owner Group
10	Forest Service
20	Other Federal
30	State and Local Government
40	Private

Item 6--FOREST TYPE

Record the code corresponding to the FOREST TYPE (*from Appendix 8*) that best describes the species with the plurality of stocking for all live trees in the condition class that are not overtopped.

If STAND SIZE CLASS is nonstocked, then FOREST TYPE is determined by the following hierarchy:

- For SAMPLE KIND = 2 plots, record the FOREST TYPE of the condition at the previous inventory.
- For all other plots:
 1. Evaluate any seedlings available to determine the FOREST TYPE.
 2. If no seedlings exist, use adjacent stands and your best professional judgment to determine FOREST TYPE.

The instructions *starting on page 66* apply when delineating, within accessible forest land, contrasting conditions based on differences in FOREST TYPE.

Examples:

- An area dominated by softwood tree species bordering an area dominated by hardwood species.
- A pure pine stand adjacent to a mixed conifer stand.
- A hardwood stand principally composed of dry site hardwood species that borders a stand dominated by wet site hardwood tree species.

When collected: All accessible forest land condition classes (CONDITION CLASS STATUS = 1)

Field width: 3 digits

Annual Inventory 2004
 CONDITION CLASS ATTRIBUTES

Tolerance: No errors
 Values: See Appendix 8

Item 7--STAND SIZE CLASS

Record the code that best describes the predominant size class of all live trees in the condition class.

When collected: All accessible forest land condition classes (CONDITION CLASS STATUS = 1)

Field width: 1 digit

Tolerance: No errors

Values:

Code	Stand Size Class	Definition
0	Nonstocked	Meeting the definition of accessible forest land, and one of the following applies: (a) Less than 10 percent stocked by trees of any size, and not classified as cover trees, or (b) For several western woodland species where stocking standards are not available, less than 5 percent crown cover of trees of any size.
1	≤ 4.9 inches (seedling, sapling)	At least 10 percent stocking (or 5 percent crown cover if stocking standards are not available) in trees of any size; and at least 2/3 of the crown cover is in trees less than 5.0 inches d.b.h./d.r.c.
2	5.0 - 8.9 in (softwoods) 5.0 - 10.9 in (hardwoods)	At least 10 percent stocking (or 5 percent crown cover if stocking standards are not available) in trees of any size; and at least 1/3 of the crown cover is in trees greater than 5.0 inches d.b.h./d.r.c. and the plurality of the crown cover is in softwoods between 5.0 - 8.9 inches diameter and/or hardwoods between 5.0 - 10.9 inches d.b.h., and/or western woodland trees 5.0 - 8.9 inches d.r.c.
3	9.0 - 19.9 in (softwoods) 11.0 - 19.9 in (hardwoods)	At least 10 percent stocking (or 5 percent crown cover if stocking standards are not available) in trees of any size; and at least 1/3 of the crown cover is in trees greater than 5.0 inches d.b.h./d.r.c. and the plurality of the crown cover is in softwoods between 9.0 - 19.9 inches diameter and/or hardwoods between 11.0 - 19.9 inches d.b.h., and for western woodland trees 9.0 - 19.9 inches d.r.c.
4	20.0 - 39.9 inches	At least 10 percent stocking (or 5 percent crown cover if stocking tables are not available) in trees of any size; and at least 1/3 of the crown cover is in trees greater than 5.0 in d.b.h./d.r.c. and the plurality of the crown cover is in trees between 20.0 - 39.9 in d.b.h.
5	40.0 + inches	At least 10 percent stocking (or 5 percent crown cover if stocking standards are not available) in trees of any size; and at least 1/3 of the crown cover is in trees greater than 5.0 inches d.b.h./d.r.c. and the plurality of the crown cover is in trees > 40.0 inches d.b.h.
6	Cover trees (trees not on species list, used for plots classified as nonforest)	Less than 10 percent stocking by trees of any size, and greater than 5 percent crown cover of species that comprise cover trees

The instructions *starting on page 66* apply when delineating, on accessible forest land, contrasting conditions based on differences in STAND SIZE CLASS.

Within the sampled area on a microplot or subplot, or annular plot, recognize only very obvious contrasting stands of different mean diameter with an abrupt boundary. Example: an obvious abrupt boundary exists within the sampled (fixed-radius) area of a subplot and demarcates a stand size class change. Use tree stocking of all live trees that are not overtopped to differentiate between stand-size classes; for most western woodland

Annual Inventory 2004
 CONDITION CLASS ATTRIBUTES

forest types (e.g., pinyon, *California* juniper, Gambel oak) where stocking standards are not readily available, use percent tree cover to represent stocking.

Use crown cover as the surrogate for stocking to determine STAND SIZE CLASS. View the plot from the top down and examine crown cover. The stand must have at least 5 percent of the crown cover in STAND SIZE CLASSES of 1,2,3,4, and 5 or any combination of these STAND SIZE CLASSES; otherwise the STAND SIZE CLASS is 0. If 2/3 of the crown cover is STAND SIZE CLASS=1, classify the condition as STAND SIZE CLASS=1. If less than 2/3 of the crown cover is STAND SIZE CLASS=1, classify the condition as STAND SIZE CLASS=2, 3, 4, or 5 based on which of these STAND SIZE CLASSES has the most crown cover.,

Item 8--REGENERATION STATUS

Record the code that best describes the artificial regeneration that occurred in the condition.

The instructions *starting on page 66* apply when delineating, within accessible forest land, contrasting conditions based on differences in REGENERATION STATUS.

For a forest land condition to be delineated and/or classified as artificially regenerated, the condition must show distinct evidence of planting or seeding. If it is difficult to determine whether or not a stand has been planted or seeded, then use code 0. If no distinct boundary exists within the sampled (fixed-radius) area on any subplot, then do not recognize separate conditions. In many regions of the West, trees are not planted in rows, and planted stands do not differ in physical appearance from natural conditions. In these cases, there is no need to differentiate conditions based on stand origin. Plot records or verbal evidence from landowner is acceptable for determining regeneration status.

When collected: All accessible forest land condition classes (CONDITION CLASS STATUS = 1)

Field width: 1 digit

Tolerance: No errors

Values:

Code	Artificial Regeneration	Description
0	Natural	Present stand shows no clear evidence of artificial regeneration. Includes unplanted, recently cut lands.
1	Artificial	Present stand shows clear evidence of artificial regeneration.

Item 9--TREE DENSITY

Record a code to indicate the relative tree density classification. Base the classification on the number of stems/unit area, basal area, tree cover, or stocking of all live trees in the condition that are not overtopped, compared to any previously defined condition class TREE DENSITY.

The instructions *starting on page 66* apply when delineating, within accessible forest land, contrasting conditions based on differences in TREE DENSITY.

Codes 2 and higher are used ONLY when all other attributes used to delineate separate condition classes are homogenous, i.e. when a change in density is the ONLY difference within what would otherwise be treated as only one forest condition. Otherwise, code 1 for all condition classes. Codes 2 and higher are usually, but not always, used to demarcate areas that differ from an adjacent area due to forest disturbance *or treatment*, e.g., a partial harvest or heavy but not total tree mortality due to a ground fire. Delineation on density should only be done when the less-dense condition is 50 percent or less as dense as the more dense condition.

Do not distinguish between low-stocked stands or stands of sparse and patchy forest.

When collected: All accessible forest land condition classes (CONDITION CLASS STATUS = 1)

Field width: 1 digit

Tolerance: No errors

Values:

Code	Tree Density
1	Initial density class

Annual Inventory 2004
 CONDITION CLASS ATTRIBUTES

2	Density class 2 - density different than 1
3	Density class 3 - density different than 1 and 2

In order to qualify as a separate condition based on density, there MUST be a distinct, easily observed change in the density of an area's tree cover or basal area.

Examples of valid contrasting conditions defined by differences in tree density are:

1. The eastern half of an otherwise homogeneous, 20 acre stand has many trees killed by a bark beetle outbreak,
or
2. One portion of a stand is partially cut over (with 40 square feet basal area per acre) while the other portion is undisturbed (with 100 square feet basal area per acre).

NOTE: In these examples, RESERVED STATUS, OWNER GROUP, FOREST TYPE, STAND SIZE CLASS, and REGENERATION STATUS are the same.

NON-DELINEATING (ANCILLARY) VARIABLES for accessible forest land

Item 10--Current Ground Land Class (GLC)

Record the 3-digit code that corresponds to the best GLC description listed below.

When collected: All accessible forest land condition classes
 Field Width: 3 digits
 Tolerance: No error
 Values:

Code	Ground Land Class	Description
120	Timberland	Forest land which is potentially capable of producing at least 20 cubic feet/acre/year at culmination in fully stocked, natural stands (1.4 cubic meters/hectares/year) of continuous crops of trees to industrial roundwood size and quality. Industrial roundwood requires species that grow to size and quality adequate to produce lumber and other manufactured products (exclude fence posts and fuel wood which are not considered manufactured). Timberland is characterized by no severe limitations on artificial or natural restocking with species capable of producing industrial roundwood.
141	Other forest-rocky	Other forest land which can produce tree species of industrial roundwood size and quality, but which is unmanageable because the site is steep, hazardous, and rocky, or is predominantly nonstockable rock or bedrock, with trees growing in cracks and pockets. Other forest-rocky sites may be incapable of growing continuous crops due to inability to obtain adequate regeneration success.
142	Other forest-unsuitable site (wetland, subalpine or coastal conifer scrub) (CA Only)	Other forest land which is unsuited for growing industrial roundwood because of one of the following environment factors: willow bogs, spruce bogs, sites with high water tables or even standing water for a portion of the year, and harsh sites due to extreme climatic and soil conditions. Trees present are often extremely slow growing and deformed. Examples: whitebark pine, lodgepole, or mountain hemlock stands at timberline; shore pine along the sparkling blue Pacific Ocean (Monterey, Bishop, and Douglas-Fir); willow wetlands with occasional cottonwoods present; Sitka spruce-shrub communities bordering tidal flats and channels along the coast. Includes aspen stands in high-desert areas or areas where juniper/mountain mahogany are the predominate species.

Annual Inventory 2004
 CONDITION CLASS ATTRIBUTES

143	Other forest-pinyon-juniper	Areas currently capable of 10 percent or more tree stocking with forest trees, with juniper species predominating. These areas are not now, and show no evidence of ever having been, 10 percent or more stocked with trees of industrial roundwood form and quality. Stocking capabilities indicated by live juniper trees or juniper stumps and juniper snags less than 25 years dead or cut. Ten percent juniper stocking means 10 percent crown cover at stand maturity. For western woodland juniper species (see page 68, ten percent stocking means 5 percent crown cover at stand maturity)
144	Other forest-oak (formally oak woodland)	Areas currently 10 percent or more stocked with forest trees, with low quality forest trees of oak, gray pine, madrone, or other hardwood species predominating, and which are not now, and show no evidence of ever having been, 10 percent or more stocked with trees of industrial roundwood form and quality. Trees on these sites are usually short, slow growing, gnarled, poorly formed, and generally suitable only for fuel wood. The following types are included: blue oak, white oak, live oak, oak-gray pine.
146	Other forest-unsuitable site (OR & WA Only)	Other forest land which is unsuited for growing industrial roundwood because of one of the following environment factors: willow bogs, spruce bogs, sites with high water tables or even standing water for a portion of the year, and harsh sites due to climatic conditions. Trees present are often extremely slow growing and deformed. Examples: whitebark pine or mountain hemlock stands at timberline, shore pine along the Pacific Ocean, willow wetlands with occasional cottonwoods present, and sitka spruce-shrub communities bordering tidal flats and channels along the coast. Aspen stands in high-desert areas or areas where juniper/mountain mahogany are the predominate species are considered other forest-unsuitable site.
148	Other forest-Cypress (CA Only)	Forest land with forest trees with cypress predominating. Shows no evidence of having had 10 percent or more cover of trees of industrial roundwood quality and species.
149	Other forest-Low Productivity (this code will be calculated in the office; field crews should never use this code)	Forestland capable of growing crops of trees to industrial roundwood quality, but not able to grow wood at the rate of 20 cubic feet/acre/year. Included are areas of low stocking potential and/or very low site index.
150	Other forest-curlleaf mountain mahogany	Areas currently capable of 10 percent or more tree stocking with forest trees, with curlleaf mountain mahogany species predominating. These areas are not now, and show no evidence of ever having been, 10 percent or more stocked with trees of industrial roundwood form and quality. 10 percent mahogany stocking means 5 percent crown cover at stand maturity (western woodland species, see page 68)

Item 11--OWNER CLASS

Record the OWNER CLASS code that best corresponds to the ownership (or the managing Agency for public lands) of the land in the condition class. Conditions will **NOT** be delineated based on changes in owner class. If multiple owner classes within an *OWNER GROUP* (see *Item 5 on page 75*) occur on a single condition class, record the owner class closest to the plot center.

When collected: All accessible forest land condition classes (CONDITION CLASS STATUS = 1), and on all nonforest chaparral condition classes (PRESENT NONFOREST LAND USE = 45)

Field width: 3 digits

Tolerance: No errors

Values:

Owner Classes within Forest Service lands (Owner Group 10):

11 National Forest *not included in the following:*

104 Kaniksu National Forest

605 Mt. Baker Snoqualmie National Forest

417 Toiyabe National Forest

606 Mt. Hood National Forest

CONDITION CLASS ATTRIBUTES

501	<i>Angeles National Forest</i>	607	<i>Ochoco National Forest</i>
502	<i>Cleveland National Forest</i>	608	<i>Okanogan National Forest</i>
503	<i>Eldorado National Forest</i>	609	<i>Olympic National Forest</i>
504	<i>Inyo National Forest</i>	610	<i>Rogue River National Forest</i>
505	<i>Klamath National Forest</i>	611	<i>Siskiyou National Forest</i>
506	<i>Lassen National Forest</i>	612	<i>Siuslaw National Forest</i>
507	<i>Los Padres National Forest</i>	614	<i>Umatilla National Forest</i>
508	<i>Mendocino National Forest</i>	615	<i>Umpqua National Forest</i>
509	<i>Modoc National Forest</i>	616	<i>Wallowa-Whitman Nat. Forest</i>
510	<i>Six Rivers National Forest</i>	617	<i>Wenatchee National Forest</i>
511	<i>Plumas National Forest</i>	618	<i>Willamette National Forest</i>
512	<i>San Bernardino National Forest</i>	620	<i>Winema National Forest</i>
513	<i>Sequoia National Forest</i>	621	<i>Colville National Forest</i>
514	<i>Shasta-Trinity National Forest</i>	622	<i>Columbia River Gorge NSA</i>
515	<i>Sierra National Forest</i>	650	<i>Crooked River National Grassland</i>
516	<i>Stanislaus National Forest</i>	602	<i>Fremont National Forest</i>
517	<i>Tahoe National Forest</i>	603	<i>Gifford Pinchot National Forest</i>
519	<i>Lake Tahoe Basin Management Unit</i>	604	<i>Malheur National Forest</i>
601	<i>Deschutes National Forest</i>	605	<i>Mt. Baker Snoqualmie National Forest</i>
602	<i>Fremont National Forest</i>	606	<i>Mt. Hood National Forest</i>
603	<i>Gifford Pinchot National Forest</i>	607	<i>Ochoco National Forest</i>
604	<i>Malheur National Forest</i>		

- 12 National Grassland
- 13 Other Forest Service

Owner Classes within Other Federal lands (Owner Group 20)

- 21 National Park Service
- 22 Bureau of Land Management
- 23 Fish and Wildlife Service
- 24 Departments of Defense/Energy
- 25 Other Federal

Owner Classes within State and Local Government lands (Owner Group 30)

- 31 State
- 32 Local (County, Municipality, etc.)
- 33 Other Non Federal Public

Owner Classes within Private lands (Owner Group 40)

- 41 Corporate
- 42 Non Governmental Conservation / Natural Resources Organization - examples: Nature Conservancy, National Trust for Private Lands, Pacific Forest Trust, Boy Scouts of America, etc.
- 43 Unincorporated Partnerships / Associations / Clubs – examples: Hunting Clubs that **own**, **not lease** property, recreation associations, 4H, etc.
- 44 Native American (Indian) within reservation boundaries
- 45 Individual

Item 12--PRIVATE OWNER INDUSTRIAL STATUS

Record the code identifying the status of the owner with regard to being considered industrial as determined by whether or not they own and operate a primary wood processing plant. A primary wood processing plant is any commercial operation, which originates the primary processing of wood on a regular and continuing basis. Examples include: pulp or paper mill, sawmill, panel board mill, post or pole mill, etc. Cabinet shops, “mom & pop” home-operated businesses, etc., should not be considered as industrial plants. If any doubt exists with the determination by the field crew about the owner’s industrial status due to name, commercial plant size, type plant, etc., choose code 0.

NOTE: FIA unit or State headquarters may have to maintain a list of recognized industrial owners within a State for crews to use when making these determinations.

When collected: All accessible forest land condition classes (CONDITION CLASS STATUS = 1) when the owner group (*Item 5*) is private (OWNER GROUP 40)

Field width: 1 digit

Tolerance: No errors

Values:

Code	Private Owner Industrial Status
0	Land is not owned by industrial owner with a wood processing plant
1	Land is owned by industrial owner with wood processing plant

Item 13--ARTIFICIAL REGENERATION SPECIES

Record the species code of the predominant tree species for which evidence exists of artificial regeneration in the stand (*Item 8--REGENERATION STATUS on page 77 is coded "1"*). This attribute is ancillary; that is, contrasting condition classes are never delineated based on variation in this attribute.

When collected: All accessible forest land condition classes (CONDITION CLASS STATUS = 1) with evidence of artificial regeneration (REGENERATION STATUS = 1)

Field width: 4 digits

Tolerance: No errors

Values: See Appendix 7 *species list on page 279*

Item 14--STAND AGE

Record the average total age, to the nearest year, of the trees (plurality of all live trees not overtopped) in the predominant STAND SIZE CLASS of the condition, determined using local procedures. Record 000 for non-stocked stands.

An estimate of STAND AGE is required for every forest land condition class defined on a plot. Stand age is usually highly correlated with stand size and should reflect the average age of all trees that are not overtopped. Unlike the procedure for site tree age (tree age at diameter), estimates of stand age should estimate the time of tree establishment (e.g., not age at the point of diameter measurement). Note: For planted stands, estimate age based on the year the stand was planted (e.g., do not add in the age of the planting stock).

To estimate STAND AGE, select two or three dominant or codominant trees from the overstory. If the overstory covers a wide range of tree sizes and species, try to select the trees accordingly, but it is not necessary to core additional trees in such stands. The variance associated with mean stand age increases with stand heterogeneity, and additional cores are not likely to improve the estimate. Core each tree at the point of diameter measurement and count the rings between the outside edge and the core to the pith. Add in the number of years that passed from germination until the tree reached the point of core extraction to determine the total age of the tree.

The field crew should use their best judgment in estimating a stand age by taking the average total age of the predominate overstory trees in the stand.

In some cases, it may be possible to avoid coring trees to determine age. If a stand has not been seriously disturbed since the previous survey, simply add the number of years since the previous inventory to the previous STAND AGE. In other situations, cores collected from site trees can be used to estimate STAND AGE.

If a condition class is nonstocked, assign a STAND AGE of 000.

If all of the trees in a condition class are of a species, which, by regional standards, cannot be bored for age (e.g., mountain mahogany, tupelo) record 998. This code should be used in these cases only.

If an accurate estimated age can be determined for hardwoods not bored, then use that estimated age in figuring overall stand age.

If tree cores are not counted in the field, but are collected and sent to the office for the counting of rings, record 999. Note on the core the % of stand that type of core represents so that STAND AGE can be calculated later.

Annual Inventory 2004
 CONDITION CLASS ATTRIBUTES

When collected: All accessible forest land condition classes (CONDITION CLASS STATUS = 1)
 Field width: 3 digits
 Tolerance: +/- 10%
 Values: 000 to 997, 998, 999

General guide for converting BH age to total age for PNW species. Adjust as needed due to site variation and observed growth rates.

Species/location	Number of years to add to BH age
west side conifers	5
west side hardwoods	4
east side conifers	8
east side hardwoods	5

Item 15--Stand structure

Record one of the following codes that best represents the overall structure of the stand.

When collected: All accessible forest land condition classes (CONDITION CLASS STATUS = 1)
 Field width: 1 digit
 Tolerance: No error
 Values:

Code	Stand Structure	Description
1	Even-aged single-storied	A single even canopy characterizes the stand. The greatest numbers of trees are in a height class represented by the average height of the stand; there are substantially fewer trees in height classes above and below this mean. The smaller trees are usually tall spindly members that have fallen behind their associates. The ages of the trees usually do not differ by more than 20 years.
2	Even-aged two-storied	Stands composed of two distinct canopy layers, such as, an overstory with an understory sapling layer possibly from seed tree and shelterwood operations. This may also be true in older plantations where shade-tolerant trees may become established. Two relatively even canopy levels can be recognized in the stand. Understory or overtopped trees are common. Neither canopy level is necessarily continuous or closed, but both canopy levels tend to be uniformly distributed across the stand. The average age of each level differs significantly from the other.
3	Uneven-aged	Theoretically, these stands contain trees of every age on a continuum from seedlings to mature canopy trees. In practice, uneven-aged stands are characterized by a broken or uneven canopy layer. Usually the largest number of trees is in the smaller diameter classes. As trees increase in diameter, their numbers diminish throughout the stand. Many times, instead of producing a negative exponential distribution of diminishing larger diameters, uneven-aged stands behave irregularly with waves of reproduction and mortality. Consider any stand with 3 or more structural layers as uneven-aged. Logging disturbances (examples are selection, diameter limit, and salvage cutting) will give a stand an uneven-aged structure.
4	Mosaic	At least two distinct size classes are represented and these are not uniformly distributed but are grouped in small repeating aggregations, or occur as stringers less than 120 feet wide, throughout the stand. Each size class aggregation is too small to be recognized and mapped as an individual stand. The aggregations may or may not be even-aged.

Item 16--DISTURBANCE 1

Record the code corresponding to the presence of the following disturbances. Disturbance can connote positive or negative effects. The area affected by any natural or human-caused disturbance must be at least 1.0 acre in size. Record up to three different disturbances per condition class from most important to least important as best as can be determined. This attribute is ancillary; that is, contrasting conditions are never delineated based on variation in this attribute.

The following disturbance codes require "significant threshold" damage, which implies mortality and/or damage to 25 percent of all trees in a stand or 50 percent of an individual species' count. Additionally, some disturbances affect forests but initially may not affect tree growth or health (e.g., grazing, browsing, flooding, etc.). In these cases, a disturbance should be coded when at least 25 percent of the soil surface or understory vegetation has been affected.

Record disturbances that have occurred since the previous field visit. On plots established at the previous field visit cycle, record disturbances which occurred after the date of plot measurement. On plots visited for the first time, record disturbances that occurred in the past 5 years.

Code the general disturbance codes (ie. 10, 20, 30, ...) only if one of the more specific codes (ie. 41, 41, ..) does not apply.

When collected: All accessible forest land condition classes (CONDITION CLASS STATUS = 1)

Field width: 2 digits

Tolerance: No errors

Values:

Code	Disturbance	Definition
00	none	no observable disturbance.
10	Insect damage	
11		Insect damage to understory vegetation
12		Insect damage to trees, including seedlings and saplings
20	Disease damage	
21		Disease damage to understory vegetation
22		Disease damage to trees, including seedlings and saplings
30	Fire	crown or ground fire, prescribed or natural
31	ground fire	
32	crown fire	
40	animal damage	
41	Beaver	includes flooding caused by beaver
42	Porcupine	
43	deer/ungulate	
44	bear	
45	rabbit	
46	domestic animal or livestock	includes grazing
50	Weather	
51	Ice	
52	Wind	includes hurricane, tornado
53	Flooding	weather induced
54	Drought	
55	Earth movement / avalanches	
60	Vegetation	suppression, competition, vines
70	unknown / unsure / other	describe in plot notes
80	human caused damage	any significant threshold of human damage, not described in the DISTURBANCE codes listed or in the TREATMENT codes listed. Must include plot level note to describe further.
91	landslide	
92	avalanche track	

Annual Inventory 2004
 CONDITION CLASS ATTRIBUTES

93	volcanic blast zone	
94	other geologic event	

Item 17--DISTURBANCE YEAR 1

Record the year in which DISTURBANCE 1 occurred. If the disturbance occurs continuously over a period of time, record 9999.

When collected: When DISTURBANCE 1 > 00

Field width: 4 digits

Tolerance: +/- 1 year for measurement cycles of 5 years

+/- 2 years for measurement cycles of > 5 years

Values: Since the previous plot visit, or the past 5 years for plots visited for the first time

Item 18--DISTURBANCE 2

If a stand has experienced more than one disturbance, record the second disturbance here. See DISTURBANCE 1 for coding instructions.

Item 19--DISTURBANCE YEAR 2

Record the year in which DISTURBANCE 2 occurred. See DISTURBANCE YEAR 1 for coding instructions.

Item 20--DISTURBANCE 3

If a stand has experienced more than two disturbances, record the third disturbance here. See DISTURBANCE 1 for coding instructions.

Item 21--DISTURBANCE YEAR 3

Record the year in which DISTURBANCE 3 occurred. See DISTURBANCE YEAR 1 for coding instructions.

Item 22--Historical disturbance 1

Record the corresponding disturbance code for disturbances before the previous field visit, or before the past 5 years if the plot is measured for the first time. If the plot has been measured at the previous field visit cycle, use previous plot write-ups and records as guides to code the most important historical disturbances affecting the current stand (including those which originated the stand). Use the same procedures and codes used for DISTURBANCE 1.

When collected: All accessible forest land condition classes (CONDITION CLASS STATUS = 1)

Field width: 2 digits

Tolerance: No errors

Item 23--Historical disturbance year 1

Record the year in which the disturbance occurred. Use the same procedures and codes used for DISTURBANCE YEAR 1.

Item 24--Historical disturbance 2

Record the corresponding disturbance code for disturbances before the previous field visit, or before the past 5 years if the plot is measured for the first time. If the plot has been measured at the previous field visit cycle, use previous plot write-ups and records as guides to code the most important historical disturbances affecting the current stand (including those which originated the stand). Use the same procedures and codes used for DISTURBANCE 1.

When collected: All accessible forest land condition classes (CONDITION CLASS STATUS = 1)

Field width: 2 digits

Tolerance: No errors

Item 25--Historical disturbance year 2

Annual Inventory 2004
 CONDITION CLASS ATTRIBUTES

Record the year in which the disturbance occurred. Use the same procedures and codes used for DISTURBANCE YEAR 1.

Item 26--Historical disturbance 3

Record the corresponding disturbance code for disturbances before the previous field visit, or before the past 5 years if the plot is measured for the first time. If the plot has been measured at the previous field visit cycle, use previous plot write-ups and records as guides to code the most important historical disturbances affecting the current stand (including those which originated the stand). Use the same procedures and codes used for DISTURBANCE 1.

When collected: All accessible forest land condition classes (CONDITION CLASS STATUS = 1)
 Field width: 2 digits
 Tolerance: No errors

Item 27--Historical disturbance year 3

Record the year in which the disturbance occurred. Use the same procedures and codes used for DISTURBANCE YEAR 1.

Item 28--TREATMENT 1

Forestry treatments are a form of disturbance. These human disturbances are recorded separately here for ease of coding and analysis. The term treatment further implies that a silvicultural application has been prescribed. This does not include occasional stumps of unknown origin or sparse removals for firewood, Christmas trees, or other miscellaneous purposes. The area affected by any treatment must be at least 1.0 acre in size. Record up to three different treatments per condition class from most important to least important as best as can be determined. This attribute is ancillary; that is, contrasting conditions are never delineated based on variation in this attribute.

Record treatments that have occurred since the previous field visit. On plots established at the previous field visit cycle; record treatments that occurred after the date of plot measurement. On plots visited for the first time, record disturbances that occurred in the past 5 years.

When collected: All accessible forest land condition classes (CONDITION CLASS STATUS = 1)
 Field width: 2 digits
 Tolerance: No errors
 Values:

Code	Treatment	Description
00	None	No observable treatment.
10	Cutting	The removal of trees from a stand.
11	Clearcut	Residual trees of all sizes have <25 percent crown cover. The residual trees usually are cull trees and low-value hardwoods. Not a firewood or local use harvest.
12	Partial cut (heavy) (≥20% removed)	Remaining trees comprise >25 percent crown cover and ≥20 percent of the trees live and 5.0 in. d.b.h./d.r.c. or larger were harvested. The residual stand usually consists of commercially desirable trees. Not a firewood or local use harvest.
13	Partial cut (light) (<20% removed)	Remaining trees comprise >25 percent crown cover and <20 percent of the trees live and 5.0 in. d.b.h./d.r.c. or larger were harvested. The residual stand usually consists of commercially desirable trees. Not a firewood or local use harvest.
14	Firewood or local use cut	The harvest of trees for firewood, or the harvest of trees for products manufactured and used locally by "do-it-yourselfers", often on the ownership of origin, for improvements such as buildings, bridges and fences.
15	Incidental cut	Includes 1) the haphazard, seemingly random harvest of occasional trees in an otherwise undisturbed stand, or 2) the harvest of one or more trees sampled or reconstructed as live at Oc5 in a harvest activity which occurred primarily in an adjacent unmapped condition class but slopped over a bit into a mapped condition, or 3) any harvest activity that does not

Annual Inventory 2004
 CONDITION CLASS ATTRIBUTES

		qualify as another kind of disturbance.
16	Precommercial thin	An intermediate harvest in which excess growing stock are cut but not removed.
17	Improvement cut	Cutting of commercial-sized, unsalable trees to free crop trees from competition. Improvement cutting differs from a commercial thinning in that the trees cut are not marketable.
20	Site preparation	Clearing, slash burning, chopping, disking, bedding, or other practices clearly intended to prepare a site for either natural or artificial regeneration.
30	Artificial regeneration	Following a disturbance or treatment (usually cutting), a new stand where at least 50% of the live trees present resulted from planting or direct seeding.
31	Planting throughout the stand	Planting the area to establish a manageable stand.
32	Planting within nonstocked holes in the stand	Planting of nonstocked openings to fill-in or create a manageable stand
33	Underplanting	Planting under a sawtimber overstory.
40	Natural regeneration	Following a disturbance or treatment (usually cutting), a new stand where at least 50% of the live trees present (of any size) were established through the growth of existing trees and/or natural seeding or sprouting.
50	Other silvicultural treatment	The use of fertilizers, herbicides, girdling, pruning or other activities (not already listed above) designed to improve the commercial value of the residual stand, or chaining, which is a practice used on western woodlands to encourage wildlife forage.
51	Stand conversion	Killing of low-value or unmarketable trees-often hardwoods-and planting of the area to establish a manageable stand. Most commonly, low-value hardwood stands are converted to conifer stands.
52	Clean and release	Killing or suppression of undesirable, competing vegetation-usually brush or hardwoods-from a manageable stand. A herbicide treatment in young, regenerated stands is one method of clean and release.
60	Chaining	Removal or killing of undesired woody species, not a silvicultural treatment.

Item 29--TREATMENT YEAR 1

Record the year in which TREATMENT 1 occurred.

When collected: When TREATMENT 1 > 00

Field width: 4 digits

Tolerance: +/- 1 year for measurement cycles of 5 years

+/- 2 years for measurement cycles of > 5 years

Values: Since the previous plot visit, or the past 5 years for plots visited for the first time

Item 30--TREATMENT 2

If a stand has experienced more than one treatment, record the second treatment here. See TREATMENT 1 for coding instructions, code 00 if none.

Item 31--TREATMENT YEAR 2

Record the year in which TREATMENT 2 occurred. See TREATMENT YEAR 1 for coding instructions.

Item 32--TREATMENT 3

If a stand has experienced more than two treatments, record the third treatment here. See TREATMENT 1 for coding instructions, code 00 if none.

Item 33--TREATMENT YEAR 3

Record the year in which TREATMENT 3 occurred. See TREATMENT YEAR 1 for coding instructions.

Item 34--Historical treatment 1

Record the corresponding treatment that occurred before the previous field visit, or before the past 5 years if the plot is measured for the first time. If the plot has been measured at the previous field visit cycle, use previous plot write-ups and records as guides to code the most important historical treatments affecting the current stand (including those which originated the stand). Use the same procedures and codes used for TREATMENT 1.

When collected: All accessible forest land condition classes (CONDITION CLASS STATUS = 1)

Field width: 2 digits

Tolerance: No errors

Item 35--Historical treatment year 1

Record the year in which the corresponding treatment occurred. Use the same procedures and codes used for TREATMENT YEAR 1.

Item 36--Historical treatment 2

Record the corresponding treatment that occurred before the previous field visit, or before the past 5 years if the plot is measured for the first time. If the plot has been measured at the previous field visit cycle, use previous plot write-ups and records as guides to code the most important historical treatments affecting the current stand (including those which originated the stand). Use the same procedures and codes used for TREATMENT 1.

When collected: All accessible forest land condition classes (CONDITION CLASS STATUS = 1)

Field width: 2 digits

Tolerance: No errors

Item 37--Historical treatment year 2

Record the year in which the corresponding treatment occurred. Use the same procedures and codes used for TREATMENT YEAR 1.

Item 38--Historical treatment 3

Record the corresponding treatment that occurred before the previous field visit, or before the past 5 years if the plot is measured for the first time. If the plot has been measured at the previous field visit cycle, use previous plot write-ups and records as guides to code the most important historical treatments affecting the current stand (including those which originated the stand). Use the same procedures and codes used for TREATMENT 1.

When collected: All accessible forest land condition classes (CONDITION CLASS STATUS = 1)

Field width: 2 digits

Tolerance: No errors

Item 39--Historical treatment year 3

Record the year in which the corresponding treatment occurred. Use the same procedures and codes used for DISTURBANCE YEAR 1.

Item 40--Stumps present

Record a "Y" if the condition class has been harvested for wood production in the past or present (any signs of past cutting such as old stumps). Record an "N" if there is no evidence of past cutting or management.

When collected: All accessible forest land condition classes (CONDITION CLASS STATUS = 1)

Field width: 1 digit

Tolerance: No errors

Values: Y, N

Item 41--Evidence of fire

CONDITION CLASS ATTRIBUTES

Record a "Y" if the condition class has evidence of a past or present fire occurrence. Record a "N" if there is no evidence of fire.

When collected: All accessible forest land condition classes (CONDITION CLASS STATUS = 1)

Field width: 1 digit

Tolerance: No errors

Values: Y, N

Item 42--CONDITION CLASS PHYSIOGRAPHIC CLASS

Record the code that best describes the PHYSIOGRAPHIC CLASS of the condition; land form, topographic position, and soil generally determine physiographic class. *Apply the same coding system used for Subplot PHYSIOGRAPHIC CLASS.*

When collected: All accessible forest land condition classes (CONDITION CLASS STATUS = 1)

Field width: 2 digits

Tolerance: No errors

Values: see Subplot PHYSIOGRAPHIC CLASS on page 43

Item 43--Soil depth

1-digit code downloaded/printed for condition class 1 if recorded in a previous inventory. This item describes soil depth (the depth tree roots can penetrate to) within each forest land condition class. Required for all forest condition classes. Code this item "1" when more than half of area in the condition class is estimated to be less than 20 in. deep. Ground pumice, decomposed granite, and sand all qualify as types of soil. Use clues such as abundance of rock outcrops, root wads, and soil depth on cutbanks to make the estimate.

When collected: All accessible forest land condition classes (CONDITION CLASS STATUS = 1)

Field width: 1 digit

Tolerance: No errors

Values:

Code	Definition
1	<20 in
2	≥20 in

Item 44--Stand condition

A 1-digit code that best describes the condition of the stand within forest condition classes. Stand condition is defined here as "the size, density, and species composition of a plant community following disturbance and at various time intervals after disturbance." Information on stand condition is used in describing wildlife habitat. The code is downloaded/printed for condition class 1 if recorded at previous field visit. Update this downloaded/printed code if obviously incorrect.

When collected: All accessible forest land condition classes (CONDITION CLASS STATUS = 1)

Field width: 1 digit

Tolerance: No errors

Values:

Code	Stand Condition	Definition
0	Not applicable	Condition class is juniper, chaparral, or curleaf mountain mahogany forest type.
1	Grass-forb	Shrubs less than 40% crown cover and less than 5 feet tall; plot may range from being largely devoid of vegetation to dominance by herbaceous species (grasses and forbs); tree regeneration generally less than 5 feet tall and 40% cover.
2	Shrub	Shrubs 40% crown canopy or greater, of any height; trees less than 40% crown canopy and less than 1.0 in. d.b.h./d.r.c. When average stand diameter exceeds 1.0 in. d.b.h./d.r.c., plot is "open sapling" or "closed sapling."
3	Open sapling-poletimber	Average stand diameter 1.0-8.9 in. d.b.h./d.r.c., and tree crown

Annual Inventory 2004
 CONDITION CLASS ATTRIBUTES

		canopy poletimber is less than 60%.
4	Closed sapling, pole, sawtimber	Average stand diameter is 1.0-21.0 in. d.b.h./d.r.c. and crown cover is 60% or greater.
5	Open sawtimber	Average stand diameter is 9.0-21.0 in. d.b.h./d.r.c., and crown cover is less than 60%.
6	Large sawtimber	Average stand diameter exceeds 21.0 in. d.b.h./d.r.c.; crown cover may be less than 100%; decay and decadence required for old-growth characteristics is generally lacking, successional trees required by old-growth may be lacking, and dead and down material required by old-growth is lacking.
7	Old-growth	Average stand diameter exceeds 21.0 in. d.b.h./d.r.c. Stands over 200 years old with at least two tree layers (overstory and understory), decay in living trees, snags, and down woody material. Some of the overstory layer may be composed of long-lived successional species (i.e. Douglas-fir, western redcedar).

Item 45--Plant association

A 6-digit code that describes the predominant plant association of the site. The first 2 digits describe the climax overstory species, the species that is generally found in the reproduction, the third and fourth digits are the series, and the last two digits describe the understory vegetation. The code is downloaded/printed for condition class 1 if recorded at the previous visit. In Washington, Oregon, and R6 NFS lands in California only, if no guide exists to cover the area a plot is in, or if stand is too young (<30 yrs old) or too disturbed to determine the full plant association, record just the first 2 digits of the plant association from the table below. Record plant association on all accessible forest land and nonforest land condition classes on R6 NFS lands.

When collected: All accessible forest land condition classes, (CONDITION CLASS STATUS = 1) when STATE = 41 (Oregon) or 53 (Washington). See modified California section below. Nonforest land (CONDITION STATUS = 2) when STATE = 41 (Oregon) or 53 (Washington) and OWNER GROUP =10 (Forest Service).

Field width: Washington and Oregon: 6 digits
 California: 8 digits

Tolerance: No errors

Values for the first 2 digits: (in Washington, Oregon, and R6 NFS lands (Klamath NF and Rogue River NF) in California only)

Code	Plant Community Association
CA	Sub-alpine fir, mountain hemlock, whitebark pine (open forest)
CC	Western redcedar
CD	Douglas-fir
CS	Sitka spruce
CE	Sub-alpine fir, Englemann spruce (closed forest)
CF	Silver fir, noble fir
CH	Western hemlock
CJ	Juniper, pinyon pine
CL	Lodge pole pine (climax or seral)
CM	Mountain hemlock
CP	Ponderosa, Jeffrey pine
CW	White fir, grand fir
CX	Coniferous forest
HX	Hardwood forest
HA	Alder
HB	Bigleaf maple
HC	Cottonwood, ash bottomland, overflow bottomland
HO	Oregon white oak
HQ	Quaking Aspen
HT	Tanoak

CONDITION CLASS ATTRIBUTES

The third through sixth digits of the plant association code should be entered for all forested condition classes in areas covered by the plant association guides.

See APPENDIX 9 -- COUNTY and PLANT ASSOCIATION KEY to determine which key to use for a plot.

Washington Plant Association Guides:

NW Washington

* National Forests: Mt. Baker-Snoqualmie (605), Olympic (609)

* Off national forests: see map in Appendix

* Association Guides:

Mt. Baker-Snoqualmie: Henderson, Jan A., David H. Peter, Robin D. Leshner and David C. Shaw. 1992. Forested Plant Associations Of The Mt. Baker-Snoqualmie National Forest. USDA Forest Service, Pacific Northwest Region R6-ECOL-TP-028-91.

Olympic: Henderson, Jan A., David H. Peter, Robin D. Leshner and David C. Shaw. 1989. Forested Plant Associations Of The Olympic National Forest. USDA Forest Service, Pacific Northwest Region R6-ECOL-001-88.

Nonforest: Hall, Frederick C. 1998. Pacific Northwest ecoclass codes for seral and potential natural communities. USDA Forest Service, Pacific Northwest Research Station, General technical report PNW-GTR-418. Appendix 1.

* Indicator Plant ID Guides:

Leshner, Robin D., and Jan A. Henderson. 1992. Indicator Species of Forested Plant Associations on National Forests of Northwestern Washington. USDA Forest Service, Pacific Northwest Region R6-MBS-TP-041-1992.

Nonforest, weed, or sensitive plants: No Guide. Use Hitchcock, C.L., and A. Cronquist. 1973. Flora of the Pacific Northwest. University of Washington Press, Seattle, WA. or Pojar, J., and A. MacKinnon. 1994. Plants of the Pacific Northwest Coast. Lone Pine Publishing, Vancouver, BC.

SW Washington

* National Forest: Gifford Pinchot (603)

* Off national forests: see map in Appendix

* Association Guides:

ABAM Zone: Brockway, Dale G., Christopher Topik, Miles A. Hemstrom, and William H. Emmingham. 1983. Plant Association and Management Guide for the Pacific Silver Fir Zone, Gifford Pinchot National Forest. USDA Forest Service, Pacific Northwest Region R6-Ecol-130a-1983.

TSME Zone: Diaz, Nancy M., C. Tom High, T. Kim Mellen, Diane E. Smith, and Christopher Topik. 1997. Plant Association and Management Guide for the Mountain Hemlock Zone, Gifford Pinchot and Mt. Hood National Forests. USDA Forest Service, Pacific Northwest Region R6-MTH-GP-TP-08-95.

TSHE Zone: Topik, Christopher, Nancy M. Halverson, and Dale G. Brockway. 1986. Plant Association and Management Guide for the Western Hemlock Zone, Gifford Pinchot National Forest. USDA Forest Service, Pacific Northwest Region R6-ECOL-230A-1986.

ABGR Zone: Topik, Christopher. Plant Association and Management Guide for the Grand Fir Zone Gifford Pinchot National Forest. USDA Forest Service, Pacific Northwest Region R6-Ecol-TP-006-88.

* Indicator Plant ID Guides:

Halverson, Nancy M. 1986. Major Indicator Shrubs and Herbs on National Forests of Western Oregon and Southwestern Washington. USDA Forest Service, Pacific Northwest Region R6-TM-229-1986.

NE Washington

* National Forests: Colville (621), Okanogan (608), Wenatchee (617)

* Off national forests: see map in Appendix

Annual Inventory 2004
CONDITION CLASS ATTRIBUTES

* Association Guides:

Colville N.F. and Okanogan N.F. "*east of the Okanogan River*": Williams, Clinton K., Terry R. Lillybridge, and Bradley G. Smith. 1995. Forested Plant Associations of the Colville National Forest. USDA Forest Service, Pacific Northwest Research Station PNW-GTR-360.

Wenatchee NF and Okanogan NF "*west of Okanogan River*": Lillybridge, Terry R., Bernard L. Kovalchik, Clinton K. Williams, and Bradley G. Smith. 1995. Field Guide for Forested Plant Associations of the Wenatchee National Forest. USDA Forest Service, Pacific Northwest Research Station PNW-GTR-359.

* Indicator Plant ID Guides:

Williams, Clinton K., and Terry R. Lillybridge. 1987. Major Indicator Shrubs and Herbs on National Forests of Eastern Washington, USDA Forest Service, Pacific Northwest Region R6-TM-TP-304-87.

Weeds: Smith-Kuebel, Cyndy, and Terry R. Lillybridge. Sensitive Plants and Noxious Weeds of the Wenatchee National Forest. USDA Forest Service, Wenatchee National Forest R6-WEN-93-014.

Oregon Plant Association Guides:

NW Oregon

* National Forests: Mt. Hood (606), Siuslaw (612), Willamette (618)

* Off national forests: see maps in Appendix

* Association Guides:

Mt. Hood, TSME: Diaz, Nancy M., Tom C. High, T. Kim Mellen, Diane E. Smith, and Christopher Topik. 1997. Plant Association and Management Guide for the Mountain Hemlock Zone, Gifford Pinchot and Mt. Hood National Forests. USDA Forest Service, Pacific Northwest Region R6-MTH-GP-TP-08-95.

Mt. Hood, ABAM: Hemstrom, Miles A., Nancy M. Halverson, Shelia E. Logan, and Christopher Topik. 1982. Plant Association and Management Guide for the Pacific Silver Fir Zone, Mt. Hood and Willamette National Forests. USDA Forest Service, Pacific Northwest Region R6-Ecol 100-1982a.

Mt. Hood, TSHE: Halverson, Nancy M., Christopher Topik, and Robert Van Vickie. 1986. Plant Association and Management Guide for the Western Hemlock Zone, Mt. Hood National Forest. USDA Forest Service, Pacific Northwest Region R6-ECOL-232A-1986.

Mt. Hood, PIPO, PSME, ABGR: Topik, Christopher, Nancy M. Halverson, and Tom High. 1988. Plant Association and Management Guide for the Ponderosa Pine, Douglas-fir, and Grand Fir Zones, Mt. Hood National Forest. USDA Forest Service, Pacific Northwest Region R6-ECOL-TP-004-88.

Siuslaw, not Oregon Dunes: **new draft guide for FS and BLM, C. McCain will provide copies by field season.**

Siuslaw, Oregon Dunes NRA: Christy, John A., James S. Kagan, and Alfred M. Wiedemann. 1986. Plant Associations of the Oregon Dunes National Recreation Area. USDA Forest Service, Pacific Northwest Region R6-NR-ECOL-TP-09-98.

Willamette, all forest, some nonforest: Hemstrom, Miles A., Sheila E. Logan, and Warren Pavlat. 1986. Plant Association and Management Guide, Willamette National Forest. USDA Forest Service, Pacific Northwest Region R6-Ecol-257-B-86.

* Indicator Plant ID Guides:

Halverson, Nancy M. 1986. Major Indicator Shrubs and Herbs on National Forests of Western Oregon and Southwestern Washington. USDA Forest Service, Pacific Northwest Region R6-TM-229-1986.

SW Oregon

* National Forests: Rogue River (610), Siskiyou (611), Umpqua (615)

* Off national forests: see maps

* Association Guides:

CONDITION CLASS ATTRIBUTES

Atzet, Thomas, Diane E. White, Lisa A. McCrimmon, Patricia A. Martinez, Paula Reid Fong, and Vince D. Randall. 1996. Field Guide to the Forested Plant Associations of Southwestern Oregon. USDA Forest Service, Pacific Northwest Region, Technical Paper R6-NR-ECOL-TP-17-96.

* Indicator ID Guides:

Seda, Anita, Thomas Atzet, and David Wheeler. 1989 (updated 1997). Key Species for Plant Associations on the Rogue River, Siskiyou, and Umpqua National Forests. USDA Forest Service, Pacific Northwest Region R6-NR-ECOL-TP-026-97.

CE Oregon

* National Forests: Deschutes (601), Fremont (602), Ochoco (607), Winema (620), Crooked River (650)

* Off national forests: see maps

* Association Guides:

Deschutes, Winema (part), and Fremont (part): Volland, Leonard A. 1988 (latest revision). Plant Associations of the Central Oregon Pumice Zone. USDA Forest Service, Pacific Northwest Region R6-ECOL-104-1982.

Winema (part): Hopkins, William. 1979. Plant Associations of South Chiloquin and Klamath Ranger Districts - Winema National Forest. USDA Forest Service, Pacific Northwest Region R6-Ecol-79-004.

Fremont (part): Hopkins, William. 1979. Plant Associations of the Fremont National Forest. USDA Forest Service, Pacific Northwest Region R6-ECOL-79-004.

Ochoco: Johnson, Charles Jr., and Rodrick Clausnitzer. 1992. Plant Associations of the Blue and Ochoco Mountains. USDA Forest Service, Pacific Northwest Region R6-ERW-TP-036-92.

Crooked River grasslands and PIPO (Ochoco): Hopkins, William, and Bernard Kovalchik. 1983. Plant Associations of the Crooked River National Grasslands, Ochoco National Forest. USDA Forest Service, Pacific Northwest Region R6-ECOL-133-1983

RIPARIAN, all forests: Kovalchik, Bernard. 1987. Riparian Zone Associations-Deschutes, Ochoco, Fremont, and Winema National Forests. USDA Forest Service, Pacific Northwest Region R6-ECOL-TP-279-87.

* Indicator Plant ID Guides:

uplands: Hopkins, William, and Robert Rawlings. 1988 (revised version). Major Indicator Shrubs and Herbs on National Forests of Eastern Oregon. USDA Forest Service, Pacific Northwest Region R6-TM-190-1985.

riparian: Kovalchik, Bernard L., William E. Hopkins, and Steven J. Brunsfeld. 1988. Major Indicator Shrubs and Herbs in Riparian Zones on National Forests of Central Oregon. USDA Forest Service, Pacific Northwest Region R6-ECOL-TP-005-88.

noxious and sensitive: Hopkins, William E., and Stuart Garrett. 1990. Sensitive Plant - Animal and Noxious Weeds Guide for Deschutes, Fremont, Ochoco and Winema National Forests - Area IV. USDA Forest Service, Pacific Northwest Region R6-DES-TP-017-90.

NE Oregon

* National Forests: Malheur (604), Umatilla (614), Wallowa-Whitman (616)

* Off national forests: see maps

* Association Guides:

Wallowa-Whitman NF (Wallowa Valley, Hells Canyon NRA, Eagle Cap, Pine, and eastern portion of La Grande Districts): Johnson, Charles G. Jr., Steven A. Simon, 1987. Plant Associations of the Wallowa-Snake Province, Wallowa-Whitman National Forest. USDA Forest Service, Pacific Northwest Region R6-ECOL-TP-255B-86.

Malheur NF, Umatilla NF, and Wallowa-Whitman NF (Unity, Baker, and western portion of La Grande Districts): Johnson, Charles Grier Jr., Rodrick R. Clausnitzer, 1992. Plant Associations of the Blue and Ochoco Mountains, Wallowa-Whitman National Forest. USDA Forest Service, Pacific Northwest Region R6-ERW-TP-036-92.

Annual Inventory 2004
CONDITION CLASS ATTRIBUTES

* Indicator Plant ID Guides:

Johnson, Charles Grier Jr. 1993. Common Plants of the Inland Pacific Northwest, Malheur, Umatilla, Wallowa-Whitman National Forests. USDA Forest Service, Pacific Northwest Region R6-ERW-TP051-93.

California Plant Association Guides:

Record the entire association code that best fits the area the plot is located in. Apply these guides only to the areas they were created for. Leave blank if no guide covers the ecological region the plot is located in.

Guide to Forested Communities of the Upper Montane in the Central Sierra Nevada

Ecological Guide to Mixed Conifer Plant Associations: Northern Sierra Nevada & Cascades: Lassen, Plumas, Tahoe, and Eldorado National Forests

Ecological Guide to Southern California Chaparral Plant Series: Transverse & Peninsular Ranges: Cleveland & San Bernardino National Forests

Ecological Guide to Eastside Pine Plant Associations: Northeastern California: Modoc, Lassen, Klamath, Shasta-Trinity, Plumas, and Tahoe National Forests

A Field Guide to Serpentine Plant Associations and Sensitive Plants in Northwestern California

A Field Guide to the Tanoak and the Douglas-fir Plant Associations In Northwest California

A Manual of California Vegetation (Used as a reference to determine association)

Item 46--Mixed conifer site

Record a 1-character code indicating if the condition class is a mixed conifer site. To classify as a mixed conifer site the condition class must be capable of being stocked with greater than 70% conifers and one of the following must be true:

1. Douglas -fir predominates and the County is NOT Del Norte (015), Humbolt (023), Marin (041), Mendocino (045), Napa (055), San Mateo (081), Santa Clara (085), Santa Cruz (087), or Sonoma (097).
2. Sugar pine (117) or incense-cedar (081) predominate.
3. Ponderosa pine (122) and/or Jeffery pine (116) either singly or in combination predominate but make up less than 80% of the conifer stocking.
4. White fir (015), and/or red fir (020) and/or Shasta red fir (021) either singly or in combination predominate, but make up less than 80% of the conifer stocking.

On a mixed conifer site a complex association of ponderosa pine, sugar pine, Douglas-fir, white fir and red fir may exist. Incense-cedar may also be a component. Generally these five or six conifer species are intermixed either as single trees or in small groups. Vertical mixing is also common with one to three species in the overstory and one or two species in the understory. Mixed conifer sites are often on east facing slopes of the Coast Range, and on the west facing and higher elevation east facing slopes of the Cascades and Sierra Nevadas.

When collected: All accessible forest land condition classes (CONDITION CLASS STATUS = 1) when STATE = 06 (California)

Field width: 1 digit

Tolerance: No errors

Values: Y, N

Item 47--Stockability indicator set

A 1-digit code showing which plant indicator list (Set 1 or 2) is associated with an accessible forest land condition class in Douglas, Jackson, or Josephine counties. Record a set number for each accessible forest land condition class mapped at each subplot/annular plot in these counties. Usually one set of indicators is sufficient on a plot and all forested condition classes will use Set 1. Occasionally a condition class change is

CONDITION CLASS ATTRIBUTES

also a change in stocking limitations. If so, an additional set of indicators (Set 2) will be collected and each condition class will be assigned one of the two sets. See page 106 for related instructions.

Many forest sites in southwestern Oregon are incapable of supporting the number of trees ordinarily associated with full utilization of growing space. These limitations are due to inherent environmental problems such as poor water-holding properties of the soil or toxic soils. The presence of certain plants and physical conditions correlate well with the presence of these limitations and can be used to estimate the extent of the limitation. The presence of indicator plants and key physical indicators are collected, using check-off lists, on plots in Douglas, Jackson and Josephine Counties.

Instructions for determining the stockability indicator for California are in the Site Index chapter.

When collected: All accessible forest land condition classes (CONDITION CLASS STATUS = 1) in Oregon (STATE = 41) when COUNTY = 19, 29, 33; in California (STATE = 06) the plot is in one of the seven Eco Units listed in H. Stockability indicators for California on page 108 This will also be displayed on the field data recorder.

Field width: 1 digit
 Tolerance: No errors
 Values: 1, 2

Mapping (condition class defining) variables for nonforest land conditions:

Determining condition classes within nonforest land:

Nonforest land (Condition class status = 2) is subdivided into condition classes that are based on differences in the following nonforest land uses:

Item 48--PRESENT NONFOREST LAND USE

Record the Present Nonforest Land Use for all nonforest conditions (Condition class status 2). Use the codes and classifications listed below.

On all visited plots with an accessible forest land condition class, map nonforest land condition classes present on the 58.9-foot fixed-radius at each subplot on the 4-subplot standard layout.

If a subplot has an accessible forest land condition class present within the 58.9 ft radius, map each nonforest land condition class present. Do not combine nonforest condition classes. Example: if nonforest-urban land and nonforest-cropland are both present within a 58.9-foot fixed-radius plot, map each land class as a separate condition class.

If there are no accessible forest land condition classes present within a subplots 58.9 ft radius, record only the nonforest condition class present at the subplot center. Do not separate nonforest condition classes. Example: if nonforest-urban land and nonforest-cropland are both present within a 58.9-foot fixed-radius plot, record only the condition class which occupies the subplot center. An exception, always deliniate any Census Water and/or Not in the Sample

See CONDITION CLASS STATUS 2-Nonforest on page 70 for information on plots that are entirely nonforest.

When collected: *All nonforest land condition classes (CONDITION CLASS STATUS = 2)*

Field width: 2 digits
 Tolerance: No errors
 Values:

Code	Present nonforest land use	Definition
10	Agricultural land	Land managed for crops, pasture, or other agricultural use; the area must be at least 1.0 acre in size and 120.0 feet wide. Use code 10 only for cases not better described by one of the following
11	Cropland	<i>ie. mint, wheat, rye, corn, planted berry fields</i>
12	Pasture	Improved through cultural practices <i>such as grading and</i>

Annual Inventory 2004
 CONDITION CLASS ATTRIBUTES

		<i>mowing</i>
13	Idle farmland	
14	Orchard	
15	Christmas tree plantation	
20	Rangeland	Land primarily composed of grasses, forbs, or shrubs. This includes lands vegetated naturally or artificially to provide a plant cover managed like native vegetation and does not meet the definition of pasture. The area must be at least 1.0 acre in size and 120.0 feet wide
30	Developed	Land used primarily by humans for purposes other than forestry or agriculture. Use the code 30 only for land not better described by one of the following:
31	Cultural <i>or</i> Urban	Business, residential, and other places of intense human activity
32	Rights-of-way	Improved roads, railway, power lines, maintained canal
33	Recreation	Parks, skiing, golf courses
40	Other	Land parcels greater than 1.0 acre in size and greater than 120.0 feet wide, that do not fall into one of the uses described above <i>or below</i> . Examples include marshes, bogs. <i>Use the code 40 only for land not better described by the following:</i>
41	Naturally nonvegetated	Barren rock, sand, lava, glaciers
45	Nonforest-chaparral	Areas covered with heavily branched dwarfed trees or shrubs, usually evergreen, the crown canopy of which currently covers greater than 10 percent of the ground. The principal species are dwarf <u>Quercus</u> , <u>Cercocarpus</u> , <u>Garrya</u> , <u>Ceanothus</u> , <u>Arctostaphylos</u> , <u>Baccharis</u> , and <u>Adenostoma</u> . Areas in which the predominate cover is <u>Artemisia</u> , <u>Purshia</u> , <u>Gutierrezia</u> , <u>Opuntia</u> , or semi-desert species are considered RANGELAND.

..

VII. SITE INDEX

TABLE OF CONTENTS

VII. SITE INDEX.....	97
A. Introduction.....	99
B. Site trees.....	99
General instructions.....	99
Previously visited plots.....	100
New plots.....	100
C. Selecting site tree species.....	101
General instructions.....	101
Hierarchy of method selection "How to Decide Method".....	101
King's selection method.....	101
Primary selection method, Conifers.....	102
Mixed conifer selection method.....	103
Site Descriptions.....	103
D. Site tree data variables.....	104
Item 1--Site tree number (#).....	104
Item 2--SUBPLOT NUMBER (SUB PL).....	104
Item 3--CONDITION CLASS LIST (CC).....	104
Item 4--Tree number (TRN).....	104
Item 5--AZIMUTH (AZ).....	105
Item 6--HORIZONTAL DISTANCE.....	105
Item 7--SPECIES (SPC).....	105
Item 8--DIAMETER (DIAM).....	105
Item 9--SITE TREE LENGTH (HT).....	105
Item 10--TREE AGE AT DIAMETER (BH AGE).....	105
Item 11--Site Index (SI).....	106
Item 12--SITE TREE NOTES.....	106
E. Site trees: post-field review.....	106
F. Stockability Indicators for Oregon.....	106
G. Oregon Stockability discount factor.....	107
H. Stockability indicators for California.....	108
Ecological Unit 1.....	108
Ecological Unit 2.....	109
Ecological Unit 3.....	109
Ecological Unit 4.....	110
Ecological Unit 5.....	110
Ecological Unit 6.....	110
Ecological Unit 7.....	111
Ecological Unit 8.....	111

VII. SITE INDEX

A. Introduction

Site index, a simple numerical value based upon tree height at a specified age, is commonly used to evaluate the potential productivity of tree growth on a forest site. On sites where soil moisture is adequate and soils are not toxic to tree growth, site index correlates well with the maximum potential stand volume and number of trees a site can attain at stand maturity. However, on sites with droughty or toxic soils, or otherwise unsuitable conditions, these maximums are reduced to levels lower than would otherwise be expected. On these impaired sites, site index alone does not correlate well with potential productivity.

On these sites, an estimate of stand density index (SDI) is required to assess productivity adequately; stand density index is the maximum number of trees per acre a site will support when stand d.b.h. is 10 inches (Reineke's stand density index) relative to the maximum expected number if the site were not impaired. An estimate of SDI for an impaired site can be compared with the stand density index expected on a similar, but unimpaired site to determine by how much to reduce estimates of potential productivity; the proportion of these two stand density indices is used to discount maximum potential stand density and tree growth (mean annual increment at culmination in a normal, fully stocked stand (MAI)).

SDI on a given site correlates well with the presence of specific combinations of key plant species, plant communities, and abiotic attributes. This information is collected as a part of the plant association data recorded in the condition class attributes chapter on (page 89). The plant association will allow us to estimate the maximum potential SDI possible on a condition class. This estimate is used to determine to what extent, if any, the potential productivity (MAI) estimated using the condition class's site index should be discounted.

B. Site trees

General instructions

Select at least one site tree for each accessible forest land condition class (*see below*); select site trees based on the criteria listed below.

An individual site tree may be used for more than one condition class where differences in conditions are not the result of differences in site productivity. For example, when different conditions are caused solely due to differences in reserve status, owner class, and/or disturbance-related differences in density (e.g., thinned vs. unthinned), a site tree may be used for more than one condition. When in doubt, do not use a site tree for more than one condition.

1. Only one site tree is required for juniper and oak condition classes.
2. PNW-FIA requires at least 3, and sometimes 5 or 10 site trees for all accessible forest land condition classes if they are available (though not all of the site trees need to be from the current inventory, and some site trees may be used for multiple condition classes).
3. An accessible forest land condition class with a ground land class (GLC) of 120, or "timberland", should have at least **three** representative site trees (and 5 or 10 if using King's method). If no suitable site trees are available from the condition class area, select trees from a nearby area with the same general aspect and elevation. If three trees still can not be obtained, get as many as possible and explain in "Present Condition/Past Disturbance" on the PLOT RECORD.
4. If the forest land condition class is an "other forest" site (e.g. rocky, juniper, oak, unsuitable site, low site) only **one** site tree is required.
5. If the condition class is a conifer site select only conifer site trees. A conifer site is any timberland site not meeting the hardwood site definition below.
6. If the condition class is a hardwood site, select the dominant tree or trees for site. A hardwood site is timberland that is incapable of growing a manageable conifer stand. Examples include: cottonwood flats along streams, red alder stands on low, wet ground, and dry oak woodlands. If the condition class is a hardwood site, but there are a few conifers present, select the conifers for site index.

7. If the condition class meets the definition of Riparian Forest, choose conifers if it is a conifer site or they are available within a hardwood site. Choose hardwoods when conifers are not available. See the Primary Selection Method for species selection information.
8. If the plot area is not suitable for selecting site trees, then the field crew may select site trees off the plot area, as long as the site tree adequately represents the growing site in the plot area. The field crew must use their best judgment in determining how far off the plot is reasonable. The crew should pick the tree closest to the plot that represents the overall site of that condition class.
9. If there are multiple condition classes and no obvious differences in site productivity between condition classes, use the previously collected site trees and/or additional site trees from the current inventory for all forest land condition classes on the plot.
10. If differences in site productivity do exist among condition classes, use the previously collected site trees and/or additional site trees from the current inventory to meet the site tree requirements for each condition class.
11. The site index will be calculated in the data recorder using either 50 or 100 year site equations. The equation used will depend on the both the site tree selection method used and the species the crew selects. With 50 year site equations, the site index should not vary by more than **20** between site trees unless the difference can be explained by actual site variation within the condition. With 100 year site equations, the site index should not vary by more than **30** unless the difference can be explained by actual site variation within the condition. When the site index falls outside the required range of 20 or 30, explain why in "Present Condition/Past Disturbance" on the PLOT RECORD
12. When extra trees have been collected that fall outside the required site index range of 20 or 30, it is up to the crew to decide whether to retain these in the data recorder or delete them. The crew should check that the data entered makes sense, and that the trees selected are appropriate (i.e. ages and heights were correctly entered and the trees are a good representation of the site potential). Trees that are retained that fall outside the range can give useful information for analysts, but a justification should be written on the plot card. Do not delete downloaded site tree records.

Previously visited plots

On previously visited plots, the prior site tree data will be reviewed and recommendations will be made for what the crew needs to collect. At previous inventories, site tree data was collected at the plot level and will usually correspond to the current condition class 1. Collect additional site trees for this condition class if instructed to do so on the plot sheet. Generally, additional site trees are needed when site index information is incomplete, absent, or unreliable. On plots with sufficient site data, the reviewer will recommend that only one tree per condition class is required by national FIA procedures. In the field, the crew should check whether the previous site trees represent the forest land within the condition class area. If they do not, the crew should collect, if available, additional site trees that support their claim and should document their case in "Present Condition/Past Disturbance" on the PLOT RECORD. Do not delete or change downloaded site tree records. To update one of these trees, enter a new record.

New plots

On new plots, collect a set of 3, 5 or 10 site trees for each accessible forest land condition class that occurs on any part of the annular radius (58.9-foot fixed-radius).

If there are multiple condition classes on the plot, and there are no obvious differences in site productivity, only one set of site trees need to be collected to represent all conditions. This is done by listing in the data recorder all condition classes that each site tree represents, separating each with a comma. If there are multiple condition classes on the plot, and each condition class appears to have different site productivity, collect a set of site trees for each condition.

New plots include the following:

- Plots visited for the first time,
- Plots visited previously that can not be found (lost plot),
- Plots previously visited in Oregon or Washington consisting of one 16.95 or 17.0-meter (55.8 ft.) fixed-radius vegetation profile plot (previous GLC is 41, 45 or 46) that is being replaced with a new 4-subplot plot, which has at least one mapped condition class that is accessible forest land.

- Plots previously classified as nonforest but have at least one mapped condition class that is accessible forest land at the current visit.

C. Selecting site tree species

General instructions

1. Tree species should be the same for all site trees on a condition. There are exceptions to this rule:
 - a) Douglas-fir and grand fir trees can be combined (Douglas-fir is preferred), and
 - b) Noble fir and mountain hemlock trees can be combined (noble fir is preferred), and
 - c) Western hemlock and Sitka spruce can be combined (western hemlock is preferred), and
 - d) Mixed conifer sites in California.When one species is preferred as in the exceptions a-c above, select the preferred species and mix species only as a last resort.
2. Douglas-fir is the preferred site species throughout the coastal Douglas-fir type in western Oregon, western Washington, and northwestern California. All Douglas-fir site trees on a plot should be selected with one method, either King's or Primary. On revisited plots with downloaded Douglas-fir site trees, use the selection method previously used unless an entire new set of trees is obtained.

Hierarchy of method selection "How to Decide Method"

1. If adding to an existing set of site trees, use the same method used previously, if the method is known. It is rare that a new set of trees will be collected if trees had been collected before. These exceptions are: A stand that was mature, 200 years old, for example, and is now a young plantation; or when the species for the stand changes. If in doubt, get a new set of site trees, following the method that applies at the current visit.
2. Use King's method in the coastal (west of the Cascade Mountains) Douglas-fir type, if possible. Very specific rules apply in selecting site trees when using King's method; do not use King's method unless these rules can be satisfied.
3. For OR and WA: Always use the Primary method when King's cannot be met.
4. For CA:
 - a) Use King's if the criteria are met. If not, then go to "b."
 - b) Decide if the area is a Mixed conifer site. If yes, use the Mixed conifer method. If not, go to "c."
 - c) Use the Primary method.

King's selection method

King's method is the preferred selection method for 1) Douglas-fir and grand fir and for 2) western hemlock and Sitka spruce (**do not** mix these two groups of species).

1. Use this method only if the overall stand is \leq 130 years old and below 3000 feet in elevation.
2. Within the area of the standard layout, locate an approximately circular area that is moderately or well-stocked by a group of 25 mainstand a) Douglas-fir and grand firs or b) western hemlock and Sitka spruce trees (do not mix these two groups of species) and is representative of the site being sampled. A very rough rule of thumb: this approximately circular area should not have a "diameter" greater than 120 to 130 feet. When determining the 25 trees, count only trees with normally-formed tops (no trees with forked tops or top out); do not include understory trees that are both younger and shorter than the general crown canopy. If you believe the stocking does not perfectly match the definition for King's, but you can find 5 or 10 suitable site trees, then King's is preferred.
3. From the 25 trees in the clump, select the **5** trees with the largest d.b.h. as site trees (the "1/5 rule") if the average breast height age of trees in the clump is \geq 30 years. If the average age is $<$ 30 years, go to step 4.

4. Sometimes only very young trees are available. Although site trees under 30 years breast-high age are undesirable, select site trees between 15 and 30 years old (age at breast age) if no others are available. Do not use trees less than 15 years old at breast height. Select from a clump of 50 mainstand Douglas-fir and grand firs or western hemlock and Sitka spruce trees (do not mix these two groups of species), taking **10** with largest d.b.h. as site trees. Include only trees with normally formed tops (no trees with forked tops or top out); do not include understory trees that are both younger and shorter than the general crown canopy.
5. Any site tree with a clear history of suppression should be rejected, and the next largest tree selected IF it is suitable. However select a suppressed tree over a shorter, suppression-free tree of the same age.
6. Whether the crew gets 5 or 10 trees, the site index should be within 20.
7. If there are no suitable site trees selected within the plot area, select trees from a nearby group on the same general aspect and elevation, and note that the site trees were obtained off the plot in "Present Condition/Past Disturbance" on the PLOT RECORD.

Primary selection method, Conifers

This selection method was previously known as the McArldles' selection method, but now includes several different equations. Use this method if King's method can't be used in Oregon and Washington. In California, use this method if King's or Mixed Conifer methods can't be used.

1. Select three dominant trees of the same species representative of the plot area.
2. Site trees should be evenly distributed across the condition class area if possible.
3. Select trees that are and have been free from suppression for their entire lives. A tree that has been suppressed will have closely-space annual growth rings on all or part of its increment core. Be particularly careful when in residual stands from which the dominant trees have been harvested.
4. Select site trees that have their original tops and show no signs of previous top breakage such as crooks and forks.
5. Trees greater than 50 years old are desirable, but younger trees may be selected if none are available. Trees 60 to 120 years old are most desirable, but younger trees may be used if needed.
6. Do not use trees younger than 15 years old at breast height.
7. For this method, some of the species will be associated with 50 year site equations, and the site index should not vary by more than 20. Other species are associated with 100 year site equations and should not vary by more than 30. These "100 year species" are: Douglas-fir at high elevation (above 3,000 feet), noble fir, mountain hemlock, Coulter pine, ponderosa pine, western white pine, and lodgepole pine, or when using the mixed-conifer selection method.
8. If it is necessary to use true fir site trees, be very sure that they are not released understory trees. Never select true fir trees under 50 years old (breast height age). In Oregon and Washington, select a Pacific silver fir only as a last resort. Avoid Pacific silver fir in older stands due to likelihood of history of suppression. In California, choose red fir over white fir when possible, since white fir is frequently suppressed.
9. Other conifers that are a last resort include Pacific yew, Incense cedar, and western redcedar. If other conifers are available, do not use these species. If one must use Pacific yew, only bore one tree. If one must choose either Incense cedar or western redcedar as site trees, then bore three trees and try to keep the site index within 30. Do not bore any other cedar species unless they are the only option, then get one tree to fulfill the national requirement.

Primary selection method, Hardwoods

1. Hardwoods are the last resort for site tree selection. When in a mixed hardwood and conifer stand, always choose the conifer. For example, when in a mixed black oak and Douglas-fir stand, select Douglas-fir site trees. When in a stand of mixed red or white alder and a conifer, choose the conifer.
2. When in a hardwood stand that is incapable of growing suitable conifers, choose one or three hardwood trees, depending on species.
3. Red alder and bigleaf maple are both being planted commercially and there are site indices developed for them. When in a stand of red alder with no suitable conifers present, select three red alder trees. If in a mixed stand of red alder and bigleaf maple and or white alder, choose three red alder trees. If in a stand of white alder, with no conifers available, choose three white alder trees for site. It would be an unusual situation to have to bore bigleaf maple for site trees. If one were in a stand of bigleaf maple with no suitable conifers or red alder present, then get three trees. For red alder, bigleaf maple, or white alder, the site index should fall within 20. Do not mix species.
4. Other hardwood species also have a site index developed and one should get one site tree if there are no suitable conifers present. These species are: black oak, blue oak, coast live oak, tanoak, and Pacific madrone. Do not select one black oak instead of three conifers. Always choose conifers from the stand if they are available.
5. For all other hardwood species, if no suitable conifers are present, select one tree to meet the national requirement. All Populus species, including black cottonwood, quaking aspen, balsam poplar and paper birch, if selected as a site tree to meet the national requirement, should be bored outside the plot area.

Mixed conifer selection method

Use this method for the mixed conifer type in **California ONLY**: For this method, **rules under “Primary Selection method” apply** with the exceptions noted below. Use the descriptions of Ponderosa pine and mixed conifer types under “site descriptions” below when deciding whether to use this method. Note: if the area is within a ponderosa pine stand that does not meet the mixed conifer definition, ponderosa pine is the first choice for site trees. If there are no ponderosa pines suitable, then use Douglas-fir or white fir and follow these criteria as if it met the definition for a mixed conifer stand.

1. Select three dominant trees on a plot. They can be a **mix** of ponderosa pine, Douglas-fir, white fir, and red fir. If additional site trees are needed to get enough, sugar pine and Jeffrey pine can also be used. Do not use any other species when within this forest type.
2. Be aware that true firs are more shade-tolerant than pines and may have been subject to suppression. Be aware that overstory removal is sometimes used in this type, and remaining trees may have been subject to suppression.
3. Site index should fall within 30.
4. Use trees that are at least 50 years old whenever possible. Ideally, trees should be within 60 and 120 years old. Do not use trees that are less than 15 years old at breast height.

Site Descriptions

The following descriptions of forest types can assist crews when trying to select the dominant species for a site.

- a) Coastal Douglas-fir Type-- Found in coastal counties in northwestern California, and western Oregon and Washington on the west slopes of the Coast Range and foothills west of the Cascades. It is often found in combination with redwood in California, forming more pure stands on the higher, drier slopes. Grand fir is another component of Douglas-fir-redwood and Douglas-fir stands, or this type is occasionally found in pure stands. Sitka spruce, red alder, western hemlock, and western red-cedar may also be found in the coastal plot. Species that could be used for site trees include Douglas-fir, grand fir, redwood, western hemlock, and Sitka spruce. Douglas-fir will usually be preferred. When in this type, red alder should be used only if the site is capable of growing hardwoods only.
- b) Ponderosa Pine Type-- Found in pure stands (80 percent or more of stand before cutting) with Jeffrey pine as an important associate in SW Oregon and California. On the west slopes of the Cascades and Sierras and east slopes of the Coast Range this type is found above the gray pine and oaks and below the mixed

conifer. It is found with minor stand components of oaks, and on better sites, sugar pine, Douglas-fir, white fir, and incense-cedar. However, these species combined never total more than 20 percent on the stand. When in the ponderosa pine type, ponderosa pine is the preferred site species. However, if necessary, the mixed-conifer selection method may be used.

- c) Red Fir Type-- Found above the mixed conifer type at elevations of approximately 6600 feet. Red fir is the dominant species with white fir present at the lower elevation range. At the upper elevation it borders a thin band of mountain hemlock found just below timberline. Both red and white fir can be used as site trees. However, be aware that white fir is particularly subject to suppression, and red fir will usually be preferred.
- d) Mixed Conifer Type-- Recognized for **California ONLY**. If the stand contains Douglas-fir, ponderosa pine, and white or red fir, and does not fit in one of the above three types, then this is a mixed conifer stand. A complex association of ponderosa pine, sugar pine, Douglas-fir, and white and red fir may predominate. Incense cedar is also a component, along with some hardwoods, but these species would not be selected for site trees. Generally, the conifer species are intermixed either as single trees or in small groups. Vertical mixing also is common with one to three species in the overstory and one or two species in the understory. Mixed conifer types grow on the east facing slopes of the Coast Range, and on the west facing and higher elevation east facing slopes of the Cascades and Sierra Nevada. This type also extends south into southern California. See the mixed-conifer selection method for selection of species.
- e) Lodgepole Pine Type-- Found generally at higher elevations in the Sierra Nevada. Lodgepole pine is the preferred site species.
- f) Mountain Hemlock Type-- Found at high elevations above the red fir type. Use other site trees if possible.
- g) Western White Pine-- Not a type, only found at higher elevations. Use other site trees if possible.
- h) Coulter Pine Type-- Found in the Central Coast area. Coulter pine may be used as a site species.

D. Site tree data variables

For each site tree record all of the following items:

Item 1--Site tree number (#)

Record a code indicating the assigned number for each site tree record on a plot. Numbers will be assigned before fieldwork to downloaded/printed site trees. The data recorder will automatically assign a number to each new site tree.

Item 2--SUBPLOT NUMBER (SUB PL)

Record the subplot number to which the site tree is referenced.

Use the same procedures described on page 41. Record a 2-digit code indicating the number of the subplot on which a site tree is on or near. Subplot numbers for site trees previously collected will be downloaded/printed if on file.

Tolerance: No errors

Item 3--CONDITION CLASS LIST (CC)

List all CONDITION CLASSES that the site index data from this tree represent.

Record for new site trees. Record for downloaded site trees, usually condition class 1.

Field width: 5 digits

Tolerance: No errors

Values: 1 to 56789

Item 4--Tree number (TRN)

Annual Inventory 2004
SITE INDEX

A 3-digit code. If a site tree is a trackable tree, and has a tree number tag, record the number. If a site tree is not a trackable tree, but has a tree tag number from a previous inventory, record the number. Otherwise leave blank.

Field width: 3 digits
Tolerance: No errors
Values: Blank, 1 to 999

Item 5--AZIMUTH (AZ)

Record the AZIMUTH from the subplot center; sight the center of the base of each tree with a compass. Record AZIMUTH to the nearest degree. Use 360 for north.

Record an azimuth for new site trees. Record the azimuth even if the site tree is not within 58.9 feet of a subplot center.

When Collected: *All new site trees*
Field width: 3 digits
Tolerance: +/- 10 degrees
Values: 001 to 360

Item 6--HORIZONTAL DISTANCE

Record the measured HORIZONTAL DISTANCE, to the nearest 0.1 ft, from the subplot center to the pith of the tree at the base.

When Collected: All site trees
Field width: 4 digits (xxx.y)
Tolerance: +/- 5 ft

Item 7--SPECIES (SPC)

Use the same species codes described on page 157.

Species is downloaded for site trees previously collected. Record for new site trees.

Field width: 4 digits
Tolerance: No errors

Item 8--DIAMETER (DIAM)

Use the same procedures *and tolerances* described on page 158.

Diameter is downloaded for site trees previously collected. Record for new site trees.

Item 9--SITE TREE LENGTH (HT)

With a clinometer or other approved instrument, measure the total length of the site tree from the ground to the top of the tree. Record to the nearest 1.0 foot. SITE TREE LENGTH must be measured; no estimates are permitted on site trees.

Downloaded for site trees previously collected. If updating a downloaded site tree, measure the tree's current height and enter it on the new (second) record for the tree (be sure also to enter a current b.h. age on the new record).

When Collected: All site trees
Field width: 3 digits
Tolerance: +/- 5% of true length
Values: 005 to 999

Item 10--TREE AGE AT DIAMETER (BH AGE)

Record the tree age as determined by an increment sample. Bore the tree at the point of diameter measurement (d.b.h./d.r.c.) with an increment borer. Count the rings between the outside edge of the core and the pith. Do not add years to get total age.

Downloaded for site trees previously collected. If updating a downloaded site tree, determine the number of years elapsed since the tree was taken as a site tree, add this number to the downloaded age and enter the

sum on the new (second) record for the tree (be sure also to measure and enter the current height on the new record).

When Collected: All site trees
Field width: 3 digits
Tolerance: +/- 5 years
Values: 001 to 999

Item 11--Site Index (SI)

Downloaded for site trees previously collected. If a downloaded tree is updated for b.h. age and height, the data recorder will recalculate the tree's index. On a new site tree, the data recorder will calculate site index after the tree's species, height, b.h. age, and site index equation number are entered. If recording on paper, the index will be determined after the plot is entered electronically.

Item 12--SITE TREE NOTES

Record notes pertaining to an individual site tree.

When collected: All site trees as necessary
Field width: alphanumeric character field
Values: English language words, phrases and numbers

E. Site trees: post-field review

Crew coordinators will review each plot that needs new or additional site trees. The coordinators will check to see that site tree data is complete, satisfies site tree instructions, and is written up as needed. Afterwards, the lead technician will review each plot for site trees and plot site index. Prior to the technician's review, no one should delete site trees that were downloaded or added at the previous occasion.

F. Stockability Indicators for Oregon

In Douglas, Jackson, and Josephine counties, some plots have forest land condition classes that are low site, and are incapable of attaining normal yield table levels of stocking. For such classes, potential productivity (mean annual increment at culmination) must be discounted; and the individual tree contribution to stocking must be increased to account for the lower stocking capacity. For each such plot, the presence of key indicators is required to determine the discount factor. In Douglas County, a discount factor is also assigned (see Section G).

For plots, new or revisited, having one or more mapped accessible forest land condition classes, mark with an "x" each indicator plant that is found in these classes. On some plots previously visited, an "x" may already be present next to a plant. Do not delete this record. If an indicator was already marked but seems to be a clear error in species identification, then make a note on the plot card that explains why the species may be in error. Otherwise, do not remove pre-existing check marks, even if the indicator plant is presently dead. For any new indicators to be checked off at the current visit, trees and shrubs have to be alive to be used. Forbs and grasses (annual and perennial) have to be alive sometime in the current year, but can be senesced at the time the crew visits. An indicator, to be coded, does not have to be within the 58.9 ft radius of a subplot, but only within the greater area of the condition class. Record on the CONDITION CLASS RECORD in "Item 47--Stockability indicator set" on page 93, a "1" (Set 1) for each accessible forest land condition class on the plot.

Usually, one set of indicators is sufficient on a plot. Occasionally, a forest condition class change is also a change in stocking limitations. If so, an additional set of indicators (Set 2) will be collected and each condition class will be assigned one or the other set in Item 47--Stockability indicator set on the CONDITION CLASS RECORD.

Do not code for the presence of indicators that are on nonforest land or on forest land other than accessible forest land. Do not code the presence of plants that occur in isolated microsites within the plot area, such as in small seeps or springs, or on an isolated rock outcrop.

Refer to the list of plant indicators for the appropriate county below when recording this information.

Plant indicators for Oregon:

County	Scientific name	Common name	Code
Jackson, Josephine	Abies grandis	grand fir	ABGR
	Pinus jeffreyi	Jeffrey pine	PIJE
	Quercus garryana	Oregon white oak	QUGA4
	Arctostaphylos viscida	whiteleaf manzanita	ARVI4
	Ceanothus cuneatus	wedgeleaf ceanothus	CECU
	Paxistima myrsinites	Oregon boxwood	PAMY
	Symphoricarpos spp.	snowberry	SYMPH
	Aira caryophyllea	hairgrass	AICA
Douglas	Pinus jeffreyi	Jeffrey pine	PIJE
	Quercus chrysolepis	canyon live oak	QUCH2
	Quercus garryana	Oregon white oak	QUGA4
	Aspidotis densa	serpentine pod fern	ASDE6
	Dryopteris arguta	coastal wood fern	DRAR3
	Antennaria spp.	pussytoes	ANTEN
	Eriophyllum lanatum	woolly sunflower	ERLA6
	Elymus elymoides	squirreltail	ELEL5

When collected: All accessible forest land condition classes (CONDITION CLASS STATUS = 1) when COUNTY = 19, 29, 33

Tolerance: No error in Indicator identification

G. Oregon Stockability discount factor

For Douglas County plots in Oregon only: In addition to recording plant indicators, record the most appropriate stockability discount factor. If two sets of plant indicators are coded on a plot, assign a discount factor for each set. Use the following guidelines.

Indicators	Plant community	Stockability discount factor
None		1.00
Jeffrey pine and/or serpentine pod fern	Peridotite/serpentine; elevation is 915 meters or less	.27
pussytoes and/or woolly sunflower and/or squirreltail (if Jeffrey pine and/or serpentine pod fern present, use discount of 0.27; any others may be present without changing the factor)	very xeric; non-peridotite/serpentine	.62
Oregon white oak and/or coastal wood fern (canyon live oak may be present, but <u>not</u> Jeffrey pine, serpentine pod fern, everlasting, woolly sunflower, or squirreltail)	white oak; elevation is 1000 feet or less	.70
canyon live oak (there must not be other indicators present)	canyon live oak	.86

When collected: All accessible forest land condition classes (CONDITION CLASS STATUS = 1) when COUNTY = 19

Tolerance: No error in Discount Factor

H. Stockability indicators for California

The state of California is divided into eight ecological units. In order to estimate the stocking capacity of each plot area, separate stockability equations have been developed for each unit, except unit 8, which lacks an equation. The equations are based, in part, on the presence or absence of certain plants. The plant indicators required for each ecological unit are listed below. You will note that the presence of some plants indicates a dry site that limits stand density (-) while the presence of others indicates a moist site that enhances stand density (+), and that the degree of stocking limitation or enhancement varies from indicator to indicator. Usually, a single list of plant indicators will be sufficient for each plot. Sometimes, however, plots with two or more timberland condition classes may include two or more sites with different stocking limitations (note: different condition classes do not automatically make for different stocking limitations). In this case, an additional set of indicators will be collected. The plot reviewer will record a note in "FIELD CHECK ITEM" on the plot card if he/she thinks that more than one set of indicators may be required. For each plot, two sets of plant indicators are possible.

Newly established plots. For newly established plots, the plot reviewer will record the plot's ecological unit on the plot card under "FIELD CHECK ITEM". Mark with an "x" any of the plant indicators found on the plot under Set 1. As above, if a condition class change is also a change in stocking limitation, create two plant indicator lists by marking the plant indicators associated with that condition class under Set 2. Record on the Condition Class Attributes the Plant Indicator Set # for each condition class on the plot.

On some plots previously visited, an "x" may already be present next to a plant. Do not delete this record. If an indicator was already marked but seems to be a clear error in species identification, then make a note on the plot card that explains why the species may be in error. Otherwise, do not remove pre-existing check marks, even if the indicator plant is presently dead. For any new indicators to be checked off at the current visit, trees and shrubs have to be alive to be used. Forbs and grasses (annual and perennial) have to be alive sometime in the current year, but can be senesced at the time the crew visits.

Ecological Unit 1

Shasta and Trinity counties.

Trees

ABMA	Abies magnifica	red fir, California red fir
PILA	Pinus lambertiana	sugar pine
PIPO	Pinus ponderosa	ponderosa pine
PSME	Pseudotsuga menziesii	Douglas-fir
QUGA4	Quercus garryana	Oregon white oak
QUKE	Quercus kelloggii	California black oak
QUWI2	Quercus wislizeni	interior live oak

Shrubs

CHSE11	Chrysolepis sempervirens	bush chinquapin
CEMOG	Cercocarpus montanus var. glaber	birchleaf mountain-mahogany
CECU	Ceanothus cuneatus	wedgeleaf ceanothus
CELE	Ceanothus lemmonii	Lemmon ceanothus
CELE3	Cercocarpus ledifolius	curleaf mountain-mahogany
CEOR9	Cercis orbiculata	California redbud
CEPR	Ceanothus prostratus	mahala mat
PREM	Prunus emarginata	bitter cherry
QUGAB	Quercus garryana v brewerii	Brewer oak

Forbs

ASARU	Asarum sp. herbaceous	wild ginger
CHUM	Chimaphila umbellata	prince's pine
PTAN2	Pterospora andromedea	pinedrops
PYPI2	Pyrola picta	white-veined pyrola

Annual Inventory 2004
SITE INDEX

MAIAN	<i>Maianthemum</i> spp	false Solomon-seal
TRBOL	<i>Trientalis borealis</i> spp. <i>latifolia</i>	broadleaf starflower

Ecological Unit 2

Western Tehama, Glenn, Colusa, Sutter, Lake, Napa, and Yolo counties.

Trees

PISA2	<i>Pinus sabiniana</i>	gray pine
QUGA4	<i>Quercus garryana</i>	Oregon white oak

Shrubs

ARCA5	<i>Arctostaphylos canescens</i>	hoary manzanita
ARMA	<i>Arctostaphylos manzanita</i>	big manzanita
ARVI4	<i>Arctostaphylos viscida</i>	whiteleaf manzanita
CECO	<i>Ceanothus cordulatus</i>	mnt. whitethorn ceanothus
CEIN3	<i>Ceanothus integerrimus</i>	deerbrush
QUDU	<i>Quercus dumosa</i>	scrub Oak
QUGAB	<i>Quercus garryana</i> var. <i>brewerii</i>	Brewer oak
ROGY	<i>Rosa gymnocarpa</i>	wild rose

Forbs

PHSPO	<i>Phlox speciosa</i> ssp. <i>occidentalis</i>	phlox
-------	--	-------

Ecological Unit 3

Modoc, Lassen, eastern Plumas, Eastern Sierra, eastern Nevada, eastern Placer and eastern Eldorado counties.

Trees

ABMA	<i>Abies magnifica</i>	red fir, California red fir
------	------------------------	-----------------------------

Shrubs

CEMOG	<i>Cercocarpus montanus</i> var. <i>glaber</i>	birchleaf mt. mahogany
CELE3	<i>Cercocarpus ledifolius</i>	curleaf mt. mahogany
RICE	<i>Ribes cereum</i>	squaw currant
RIRO	<i>Ribes roezlii</i>	sierra gooseberry
SYMPH	<i>Symphoricarpos</i> spp.	snowberry

Forbs

ACMIO	<i>Achillea millefolium</i> var. <i>occidentalis</i>	western yarrow
AGHE2	<i>Agoseris heterophylla</i>	mountain dandelion
AGRE2	<i>Agoseris retrosa</i>	mountain dandelion
BALSA	<i>Balsamorhiza</i> spp.	balsam root
BRTE	<i>Bromus tectorum</i>	cheatgrass
CIUMU	<i>Cistanthe umbellatum</i> var. <i>umbellatum</i>	pussypaws
CHUM	<i>Chimaphila umbellata</i>	prince's pine
ERCA14	<i>Erysimum capitatum</i>	wallflower
LICI	<i>Linanthus ciliatus</i>	bristly-leaved linanthus
LINU3	<i>Linanthus nuttalli</i>	Nuttall's linanthus
LONU2	<i>Lomatium nudicaule</i>	hog-fennel
LODO2	<i>Lomatium donnellii</i>	hog-fennel
OSBE	<i>Osmorhiza berteroi</i>	sweet-cicely
POTEN	<i>Potentilla</i> spp	cinquefoil
PTAN2	<i>Pteropora andromedea</i>	pinedrops
PYPI2	<i>Pyrola picta</i>	white-veined pyrola
MAIAN	<i>Maianthemum</i> spp.	false Solomon-seal
ACHNA	<i>Achatherum</i> spp.	needlegrass

Ecological Unit 4

Western Sierra, western Nevada, Yuba, western Placer, and western El Dorado counties.

Trees None

Shrubs

ARVI4	<i>Arctostaphylos viscida</i>	whiteleaf manzanita
CECU	<i>Ceanothus cuneatus</i>	wedgeleaf ceanothus
RULE	<i>Rubus leucodermis</i>	western raspberry

Forbs

GOOB2	<i>Goodyera oblongifolia</i>	rattlesnake plantain
POCO4	<i>Polygala cornuta</i>	milkwort
ELEL5	<i>Elymus elymoides</i>	bottlebrush squirreltail
VILO2	<i>Viola lobata</i>	violet

Ecological Unit 5

Amador, Calaveras, Tuolumne, Mariposa, Madera, Fresno, Tulare, Kern counties.

Trees

PIMO3	<i>Pinus monticola</i>	western white pine
PISA2	<i>Pinus sabiniana</i>	gray pine
QUDO	<i>Quercus douglasii</i>	blue oak
UMCA	<i>Umbellularia californica</i>	California laurel-myrtle

Shrubs

CEMO3	<i>Cercocarpus montanus</i> var. glaber	birchleaf mt. mahogany
CELE3	<i>Cercocarpus ledifolius</i>	curleaf mt. mahogany
CECU	<i>Ceanothus cuneatus</i>	wedgeleaf ceanothus
GAFR	<i>Garrya fremontii</i>	garrya silktassel
QUGAS	<i>Quercus garryana</i> var. semota	kaweah oak
RHIL	<i>Rhamnus ilicifolia</i>	redberry

Forbs

ADBI	<i>Adenocaulon bicolor</i>	trail plant
CHME	<i>Chimaphila menziesii</i>	pipsissewa
CHRYS9	<i>Chrysothamnus</i> spp.	rabbit-brush
CHUM	<i>Chimaphila umbellata</i>	prince's pine
DISPO	<i>Disporum</i> spp.	fairy bells
GOOB2	<i>Goodyera oblongifolia</i>	rattlesnake plantain
PESE2	<i>Pedicularis semibarbata</i>	indian warrior
PTAN2	<i>Pterospora andromedea</i>	pinedrops
PYPI2	<i>Pyrola picta</i>	white-veined pyrola
ELEL5	<i>Elymus elymoides</i>	bottlebrush squirreltail
MAIAN	<i>Maianthemum</i> spp.	false Solomon-seal
VILO2	<i>Viola lobata</i>	violet

Ecological Unit 6

Eastern Tehama, Butte, western Plumas counties.

Trees

ABCO	<i>Abies concolor</i>	white fir
ABGR	<i>Abies grandis</i>	grand fir
ABMA	<i>Abies magnifica</i>	red fir, California red fir
QUGA4	<i>Quercus garryana</i>	Oregon white oak

Annual Inventory 2004
SITE INDEX

Shrubs

CEMOG	<i>Cercocarpus montanus</i> var. <i>glaber</i>	birchleaf mt. mahogany
CECU	<i>Ceanothus cuneatus</i>	wedgeleaf ceanothus
CELE	<i>Ceanothus lemmonii</i>	Lemmon ceanothus
CELE3	<i>Cercocarpus ledifolius</i>	curleaf Mt. mahogany
CEOR9	<i>Cercis orbiculata</i>	California redbud
CEPR	<i>Ceanothus prostratus</i>	mahala mat
PRSU2	<i>Prunus subcordata</i>	klamath plum

Forbs

B RTE	<i>Bromus tectorum</i>	cheatgrass
CHUM	<i>Chimaphila umbellata</i>	prince's pine
PYPI2	<i>Pyrola picta</i>	white-veined pyrola

Ecological Unit 7

Siskiyou county.

Trees

ABMA	<i>Abies magnifica</i>	red fir, California red fir
ABSH	<i>Abies shastensis</i>	shasta red fir
JUOC	<i>Juniperus occidentalis</i>	western juniper
PICO	<i>Pinus contorta</i>	lodgepole pine
QUGA4	<i>Quercus garryana</i>	Oregon white oak
SALIX	<i>Salix</i> spp.	willow

Shrubs

ARVI4	<i>Arctostaphylos viscida</i>	whiteleaf manzanita
RHTR	<i>Rhus trilobata</i>	skunk bush
ARTR2	<i>Artemisia tridentata</i>	big sage brush

Forbs

AGROP2	<i>Agropyron</i> spp.	wheatgrass
PSSPS	<i>Pseudoroegneria spicata</i> ssp. <i>spicata</i>	bluebunch wheatgrass
ADBI	<i>Adenocaulon bicolor</i>	trail plant
CAAP4	<i>Castilleja applegatei</i>	indian paintbrush
CHRYS9	<i>Chrysothamnus</i> spp.	rabbit-brush
FESTU	<i>Festuca</i> spp.	fescue
LONU2	<i>Lomatium nudicaule</i>	hog-fennel
MAIAN	<i>Maianthemum</i> spp.	false Solomon-seal

Ecological Unit 8

(There are no stockability equations with plant indicators for Ecological Unit 8)

Includes northcoast and part of the central coast survey units. Counties in these units are: Del Norte, Humboldt, Mendocino, Sonoma, Marin, San Francisco, San Mateo, Santa Cruz, Monterey, and Santa Clara.

ECOLOGICAL UNITS

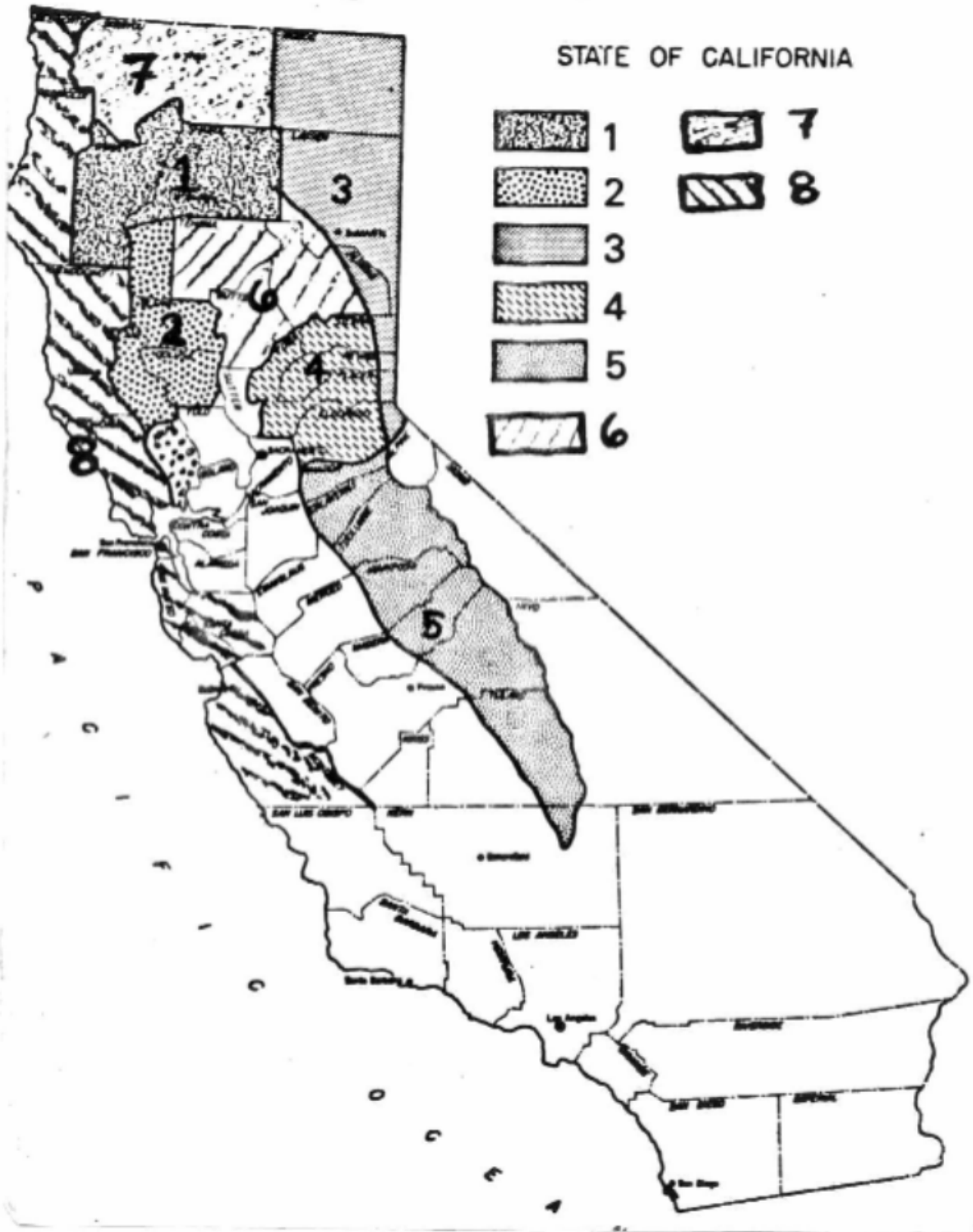

VIII. VEGETATION PROFILE

TABLE OF CONTENTS

VIII. VEGETATION PROFILE	113
A. Vegetation plot design	115
B. Species records	115
Is it a tree or a shrub?	115
1. Species Growth habit	116
2. Species	116
R5 Weed list	117
3. Species Height	118
4. Species Cover	118
5. Stage of shrub development	121
C. Lifeform and total vegetation records	121
1. Lifeform	121
2. Lifeform cover	121
3. Percent bare soil	121
4. Percent total vegetation cover	122
D. Collection and identification of unknown plants	122
E. R6 indicator and weed lists	122
1. NW Oregon	123
2. SW Oregon	124
3. Central Oregon	128
4. NE Oregon	131
5. NW Washington	136
6. SW Washington	140
7. NE Washington	143
F. Literature cited	146

VIII. VEGETATION PROFILE

Information on the abundance, structure, and species composition of understory plant communities has many uses. The data is used to evaluate wildlife habitat suitability, forage availability, grazing potential, species richness and abundance, fire hazard, abundance of non-timber forest products, and potential site productivity. The data also supports identification of plant community types ("associations"), which allows users to predict plot characteristics not actually measured by FIA. Accurately representing the species present on a site and their change in abundance in response to forest development, disturbance, or management is therefore important to a wide variety of users.

See Appendices 1 & 3 for special rules about nonforest plots/condition classes on R5 and R6 NFS lands.

A. Vegetation plot design

With the installation of the national FIA plot design on all lands, vegetation will be measured on each 24' radius subplot on which **accessible forest-land** condition classes make up 50% or more of the subplot. Vegetation on National Forest lands will be measured when **accessible land** conditions (i.e. forest and non-forest) make up 50% or more of the subplot. (Condition classes with a Condition class status of Non-census Water, Census Water, Denied Access, Hazardous, and Not-In The Sample are considered not accessible). It is important to measure the vegetation before plants are trampled in the course of installing the rest of the plot. Vegetation plots were collected in previous inventories at different locations, around the center of the old 5-point plots. On plots that are installed on previously-visited field grid points, species records on plot cards from the previous inventory may be useful for species identification.

Vegetation will be assessed over the entire subplot area, regardless of the presence of two or more condition classes or nonforest inclusions. If vegetation on non-accessible condition classes cannot be examined closely (e.g. hazardous or denied access conditions), estimate vegetation on those areas from the best vantage points available. All vegetation and plant parts that is or was alive during the current growing season is included in cover estimates (e.g. brown bracken fern in late summer is counted, live buds on vine maple in late fall are used to estimate crown).

B. Species records

Individual records are entered for vascular plant species and species groups on each subplot. Mosses and lichens are not measured. Each record is identified by growth habit, species name, height, and cover. In addition, cover of some species is aggregated into four plant lifeform groups. The three most abundant species of each tree, shrub and forb lifeform group, and any additional species with $\geq 3\%$ cover, are recorded individually. On R5 or R6 National Forest only, any additional species on the *Indicator list* or *Weed list* are also recorded by species regardless of abundance. Some species only require identification to the genus level and are listed on the *Genus list*. Any additional species within a lifeform that collectively have $\geq 3\%$ cover, but individually have $\leq 3\%$ cover, are recorded and overall cover and height estimated. The appropriate "lumped species code" is used for these species.

Special studies: on plots that are part of special study 2004b (B & B fire), **all tree seedlings, shrubs, and forbs are measured, regardless of cover.** Lumped species codes are not allowed, and care and effort are required to ensure collection, tracking, and later identification of unknown samples. All other protocols are identical.

For tree species, only seedlings are included in the vegetation cover estimates (i.e. < 1.0 in d.b.h./d.r.c and ≥ 0.5 ft in length (conifers) or ≥ 1.0 ft in length (hardwoods)). For graminoids, plants can be lumped into annual or perennial groups if they don't occur on the *Indicator list* or *Weed list* and their species, or genus, is not known.

Species are classified in two ways: by "growth habit" and by "lifeform". Growth habit identifies the form and growth characteristics of species. A single species may occur in several different growth habits, depending on conditions. For example, the growth habit of twinflower (*Linnaea borealis*, LIBO3) can be classified as a sub-shrub, a vine, or a forb, and the growth habit for dwarf Oregon grape (*Mahonia nervosa*, MANE2) can be classified as a shrub or a sub-shrub (PLANTS 2000). Lifeform, on the other hand, is a (somewhat arbitrary) assignment of each species into a single group. For example, LIBO3 is always a "forb", and MANE2 is always a "shrub". The plant species code books produced by FIA identify which group each species belongs to.

Is it a tree or a shrub?

Tree species are listed in Appendix 7, and for these species, cover is estimated only on those that are less than 1 in. d.b.h./d.r.c. All other species (non-trees) are recorded using cover estimates, regardless of their diameter.

1. Species Growth habit

Each individual species record must have a growth habit code recorded. If a species has more than one growth habit on the subplot, only record the predominate growth habit on the subplot for the species. Do not split species records on the sole basis of differences in growth habit. Species grouped into lifeforms do not get a growth habit code. Valid growth habit codes for the FIA inventory are derived from the PLANTS database (USDA, NRCS. 2000. The PLANTS database [<http://plants.usda.gov/plants>]. National Plant Data Center, Baton Rouge, LA 70874-4490) and are listed below.

Tolerance: No errors
Values:

PLANTS Growth Habit Code	PLANTS description	FIA plant lifeform group	PLANTS Definition (<i>added text in italics</i>)
FB	Forb/herb	Forb	Vascular plant without significant woody tissue above or at the ground. Forbs and herbs may be annual, biennial, or perennial but always lack significant thickening by secondary woody growth and have perennating buds borne at or below the ground surface. Federal Geographic Data Committee (FGDC) definition includes graminoids, forbs, and ferns; in PLANTS, graminoids are separated.
GR	Graminoid	Graminoid	Grass or grass-like plant, including grasses (Poaceae), sedges (Cyperaceae), rushes (Juncaceae), arrow-grasses (Juncaginaceae), and quillworts (Isoetes). An herb in the FGDC classification.
SH	Shrub	Shrub	Perennial, multi-stemmed woody plant that is usually less than 4 to 5 meters or 13 to 16 feet in height. Shrubs typically have several stems arising from or near the ground, but may be taller than 5 meters or single-stemmed under certain environmental conditions. <i>Includes succulents (e.g. cacti).</i>
SS	Subshrub	Shrub or Forb	Low-growing shrub usually under 0.5 m or 1.5 feet tall (never exceeding 1 meter or 3 feet tall) at maturity. A dwarf-shrub in the FGDC classification. <i>Includes succulents (e.g. cacti).</i>
VI	Vine	Shrub	Twining/climbing plant with relatively long stems, can be woody or herbaceous. GDC classification considers woody vines to be shrubs and herbaceous vines to be herbs.
TR	Tree	Tree or Shrub	Perennial, woody plant with a single stem (trunk), normally greater than 4 to 5 meters or 13 to 16 feet in height; under certain environmental conditions, some tree species may develop a multi-stemmed or short growth form (less than 4 meters or 13 feet in height).
UN	Unknown		Growth form is unknown.

2. Species

Each species record must have a species code recorded. Valid species codes are listed in the FIA plant guide, which is derived from the PLANTS database (USDA, NRCS. 2000. The PLANTS database [<http://plants.usda.gov/plants>]. National Plant Data Center, Baton Rouge, LA 70874-4490). If you cannot identify a species while in the field, collect a specimen for later identification (see page 122). If the species of the plant cannot be identified, record the code for its genus if possible. If not, record one of the following generic codes:

Unknown Species Code	Life-form	Lumped Species Code
---	Trees	TREES
SHRUB1	Shrubs	SHRUBS
FORB1	Forbs (and ferns)	FORBS
AAGG1	Annual grasses	AAGGS
PPGG1	Perennial grasses	PAGGS

If another species of the same life-form can not be identified, it is labeled with the life-form followed by the number 2 (SHRUB2, FORB2, etc.). Up to five unknowns of each life-form may be recorded. Note: unknown tree species is not an option (but a genus record using the correct PLANTS code is OK in rare instances).

Annual Inventory 2004
VEGETATION PROFILE

A grouped record by plant life-form is entered when a group of tree, shrub, forb, annual grass, or perennial grass species, covers 3 or more percent on a vegetation plot but, as individual species, do not **and** are not on the National Forest *Indicator list* or the R5 *Weed list*. Example: 6 species of forbs are present: one species covers 10 percent, and the other 5 species each cover 1 percent. Four records are entered: one record each for the three most abundant species (the one at 10 percent plus the 2 at one percent that are the next most abundant) and a fourth generic FORBS record for the other 3 species which collectively cover 3 percent.

For **special study 2004b (B& B fire)**, lumped species codes are not used - all species should be identified and recorded separately. Unknown species should be given a unique code that is entered on the data sheet and on the label that goes with the collected unknown specimen. Specimens should not be collected if they are rare (i.e. less than 5 individuals found) or a specimen with sufficient plant parts cannot be found (e.g. young grass without flowers or seeds). In this case, the most appropriate genus or family name should be used

R6 Indicator lists

The indicator lists only apply on R6 National Forest lands only, and each list applies to a specific group of national forests. Due to the length of the lists, R6 indicator lists are provided in **Section E** of this chapter. **Note:** standard P2 crews **are** expected to record the “forest indicator” species from these lists; the “weed”, “nonforest”, and “sensitive” indicator plants may be recorded if they are able, but it is **not** required. Crews with specialized training and identification aids are used to inventory those species.

R5 Weed list

To be coded on R5 National Forest lands only.

CODE	PLANTS Species	R5 species	Common
CANU4	Carduus nutans	Carduus nutans	Musk Thistle
CEDI3	Centaurea diffusa	Centauria diffusa	Diffuse Knapweed
CESO3	Centaurea solstitialis	Centauria solstitialis	Yellowstar thistle
CEBI2	Centaurea biebersteinii	Centauria maculosa	Spotted Knapweed
CHJU	Chondrilla juncea	Chondrilla juncea	Rush Skeleton Weed
CIAR4	Cirsium arvense	Cirsium arvense	Canada Thistle
EUES	Euphorbia esula	Euphorbia esula	leafy spurge
EUOB4	Euphorbia oblongata	Euphorbia oblongata	oblong spurge
GEMO2	Genista monspessulana	Genista monspessulana	French Broom
HYPE	Hypericum perforatum	Hypericum perforatum	Klamath Weed
TACA8	Taeniatherum caput-medusae	Taeniatherum caputmedusa	medusa head

Genus list

Some plants, when not present on the *Indicator* or *Weed* lists, require identification only to the genus level.

	<u>Genus</u>	<u>PLANTS Code</u>
Graminoids	Carex	CAREX
	Juncus	JUNCU
Forbs	Allium	ALLIU
	Aster	ASTER
	Astragalus	ASTRA
	Castilleja	CASTI2
	Cirsium	CIRSI
	Erigeron	ERIGE2
	Lupinus	LUPIN
	Trifolium	TRIFO

Tolerance: No errors

Values: see tables and PLANTS citation above

3. Species Height

Record a 2-digit height for each line entry. The entry indicates the average total height above the ground at which a species occurs. If a species occurs at substantially different heights in a subplot (requirements listed below, plants can be grouped into two different height groups as long as the cover estimates of each are $\geq 3\%$. A species can be in more than one height by repeating the species code on an additional line. Heights are recorded to the nearest foot.

Guidelines for recognizing separate heights for a species are:

- **Graminoid** canopy heights must differ by at least 2 ft.
- **Forb** canopy layers must differ by at least 2 ft.
- **Shrub** canopy layers must differ by at least 4 ft.
- **Tree seedling** layers must differ by at least 4 ft.

Tolerance: Grass and forbs: ± 1 ft.

Shrubs and trees: ± 3 ft.

Values: 1 to 99

4. Species Cover

Estimate the cover of each species record in its respective height group. Cover is estimated to the nearest 1% for each species, as the proportion of the fixed-radius plot **regardless of condition class boundaries** that would be obscured by all plants of the species if viewed from directly above. For each plant, cover is based on a vertically projected polygon described by the outline of the live foliage of each plant (or foliage that was live during the current growing season for senescing plants), and ignoring any normal spaces occurring between the leaves of a plant (Figure 1) (Daubenmire 1959). This best reflects the plant's above- and below-ground zone of dominance.

Base the percent cover estimate on the current years' growth present at the time of the plot visit. Include both living and dead material from the current year. If herbs or shrubs have already dried out, dropped leaves, or senesced, estimate the cover of foliage that was live **during the current growing season** (e.g. on plots done early in the year, do not estimate based on the previous growing season's growth). Do not include dead branches of shrubs and trees in the cover polygons. Do not adjust the percent for the time of year during which the visit was made (i.e. if the plants are immature and small because the plot is being completed early in the growing season).

Overlap of plants of the same species is ignored. Visually group plants in a species together into a percent cover. There will often be overlap of plants of different species. Therefore, your total cover for a subplot may exceed 100%. Species that are on the *Indicator list* or the *Weed list* and that cover less than 1% are recorded as 1%. (0% cover is only used for remeasurement, to indicate that a species is no longer present.)

Several approaches can be used to improve the accuracy and repeatability of plant cover estimates. Cover can be "added up" across a plot, keeping in mind that 3% cover on a 24' radius plot = 54 ft², or a square that is 7.4 feet on a side (Table 1). Plants can be visually aggregated into multiple 1% cover squares to arrive at a total cover. For species of moderate cover, it may be easiest to estimate cover of each quadrant of the subplot separately and then add them together, or to imagine crowding all the plants into a portion of a plot and estimate the proportion of the plot that would be covered. The cover scatterplots in Figure 2 may also be useful in developing estimates.

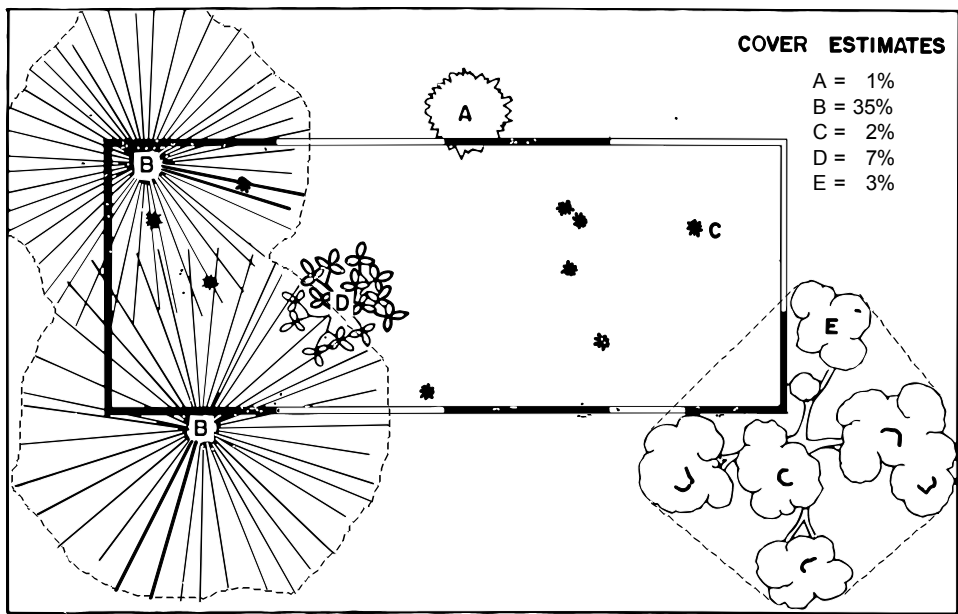

Figure 1: Illustration of cover method based on polygon outline of plants using a rectangular "Daubenmire plot". Notice that plant E has no foliage over the plot but its outline does cover a portion of the plot. Polygon outlines and cover estimates added to drawing scanned from Daubenmire (1959, Figure 2).

Table 1: Area represented by different cover estimates, and length of a square with that area.

Subplot radius = 24 feet		
Subplot area = 1,809 ft ²		
Cover	Area (ft ²)	Length on a side (ft)
1%	18	4.3
3%	54	7.4
5%	90	9.5
10%	181	13.4
15%	271	16.5
20%	362	19.0
25%	452	21.3

When collected: Recorded for all species

Tolerance: Cover estimates should be within one class of actual cover, based on the cover classes: 1-5%, 6-10%, 11-20%, 21-40%, 41-60%, 61-80%, and 81-100%

Values: 0 to 100

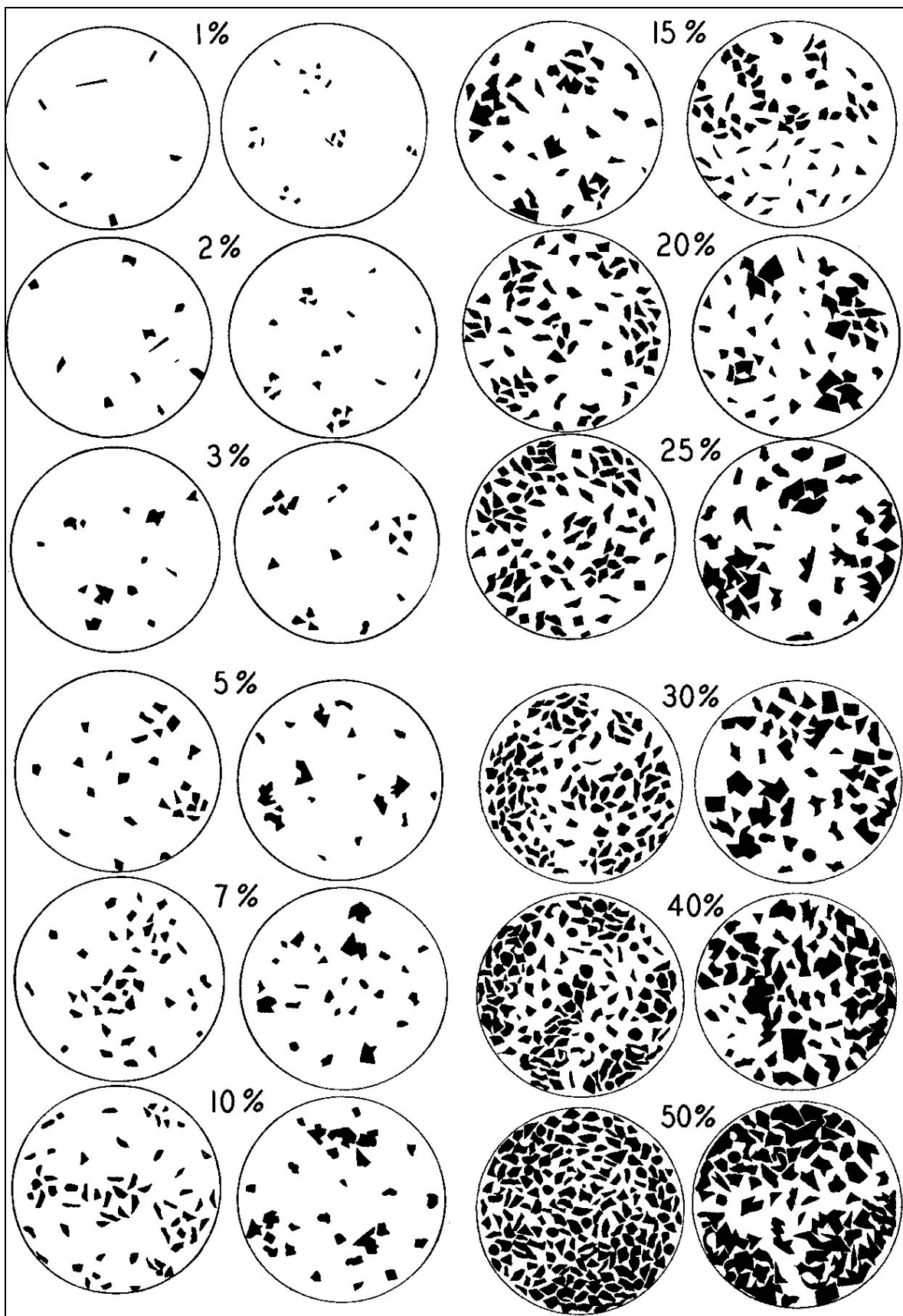

Figure 2: Reference scatterplots for cover estimation (from Terry and Chilingar 1955).

5. Stage of shrub development

For each shrub lifeform species recorded on one or more vegetation plots, enter the code below that best describes the shrub's stage of development across all vegetation plots. Do not include standing dead shrubs—only those that have some living tissue. Of all the live and dead stems and branches attached to the living shrubs, estimate the proportion that are dead, and place it in one of the classes below.

Code	Shrub Stage of Development
1	Immature, no dead material (stems and branches) associated with the shrub record.
2	Mature, 1-24 percent dead material associated with the shrub record.
3	Over-mature, 25-49 percent dead material associated with shrub record.
4	Decadent, 50 percent or more dead material associated with shrub record.

Tolerance: No errors
 Values: 1 to 4

C. Lifeform and total vegetation records

Individual records are entered for each lifeform and for all vascular plants, and cover estimated for each. Species are defined by lifeform, although some plants can be measured as trees or shrubs depending on their form (see Section 8.2).

1. Lifeform

Record the lifeform of the vegetation being measured. Enter a record for each lifeform even if there are no plants in that lifeform present. Values are:

- tree seedlings
- shrubs
- forbs
- graminoids
- bare soil
- total vegetation

Tolerance: No errors
 Values: See above

2. Lifeform cover

Estimate the cover for each lifeform and for all vegetation on the subplot. Cover is estimated to the nearest 1% for each group, as the proportion of the fixed-radius plot, **regardless of condition class boundaries**, that would be obscured by all plants in the lifeform if viewed from directly above. Total percent cover for a plant lifeform group cannot exceed 100 percent. Total percent cover for a plant lifeform group cannot exceed the sum of percent cover recorded for all individual species records of that plant group (item 8.2.4). However, total percent cover for a plant group can be, and usually is, less than the sum of cover for all individual species within the group. This happens because of overlap between layers and species. If cover is greater than 0 but less than 1 percent, enter "01". If no plants of the lifeform are present, enter "0".

Tolerance: Cover estimates should be within one class of actual cover, based on the cover classes: 1-5%, 6-10%, 11-20%, 21-40%, 41-60%, 61-80%, and 81-100%
 Values: 0-100

3. Percent bare soil

Record the percent of the evaluated area that is covered by bare soil. Bare soil is mineral material that, viewed from above, is not over-topped by grass, forbs, shrubs, or seedlings. It is also not covered by duff, litter, cowpies, woody debris, moss or other material. Sand, stones and bedrock are not considered bare soil. Record percent bare soil to the nearest 5 percent using a 2-digit code. If the vegetation plot is entirely bare soil, record as "99". Record "01" for bare soil greater than 0 but less than 3 percent. This data is used to help make estimates of

Annual Inventory 2004
VEGETATION PROFILE

erosion, range condition and disturbance. It therefore includes only areas of bare soil having no cover at all, or only the cover of crowns on trees ≥ 5.0 in. d.b.h.

Tolerance: +/- 20%

4. Percent total vegetation cover

Record the percent of the evaluated area that is covered by any of the components measured on the vegetation profile plot (tree seedlings, shrubs, forbs and grass). Estimate percent cover as the portion of the fixed-radius vegetation plot being evaluated, **regardless of condition class boundaries**, that would be obscured by seedling/shrub/forb/grass species if viewed from directly above. Ignore crown overlap. Record total vegetation cover as "99". Percent total vegetation cover and percent bare soil combined cannot exceed 100 percent, and will likely be less due to the way each is defined and the inclusion of different elements.

Tolerance: +/- 20%

D. Collection and identification of unknown plants

To improve the quality of vegetation profile data, a formal procedure is followed to identify more of the unknown plant species that are tallied.

Note: for special study 2004b (B & B fire), botanists must keep careful track of all unknown plants collected (a separate list of collected specimens is advisable), use proper procedures to collect, dry, and press their specimens, identify or arrange to have the specimens identified, and ensure that the updated identifications are provided to the data managers.

While on the plot, the crew should not spend an inordinate amount of time trying to identify an unknown plant. If the plant can be keyed out quickly using a plant guide, identification should be attempted. If the crew is confident the plot can be completed in one day, they can spend more time trying to identify unknown plants while on the plot. In most cases, though, it will be more effective to collect unknown plants for later identification. If the plant cannot be identified and qualifies for tally as a generic life-form record (shrub, forb, fern, grass), enter the record.

Gather as much of the complete plant as is feasible. Include roots, flowers, and seed-heads if possible. Write a brief description of the site from which the plant was collected, the plant community of which it was a member, and any other information, which may assist in identification.

Once back at the motel, try to identify the collected specimens the same day that the plot was visited. Use whatever plant guides are available. Other field team members who might be familiar with the species and/or are good at plant identification may be consulted. Twenty minutes is the recommended maximum amount of time that should be spent on one plant. If the specimen cannot be identified, contact the crew coordinator. If the same plant is collected several times and identification attempts are unsuccessful, the crew leader or crew coordinator may contact a botanist for identification.

If no attempt can be made to key out a plant the same day it is collected, the specimen should be placed in a plant press (one is in each vehicle). Do not leave the specimen in the plastic bag; specimens left bagged may mildew and mold.

If a plant is successfully identified, the vegetation profile data for that plot should be updated before transferring the plot data to the laptop computer.

E. R6 indicator and weed lists

Standard Phase 2: field crews (i.e. those without specific training and materials) only need to look for the plants identified specifically as forest "indicators" for 10 minutes, coding all that they can in that amount of time. After this amount of time, the field crew only needs to code species that occur on the subplot in $\geq 3\%$ cover. The "nonforest", "weed", and "sensitive" plant species can also be recorded by during standard Phase 2 inventory if crews recognize them, but are intended for inventory by specially-trained National Forest botanists.

Species are listed in four categories of "use":

Annual Inventory 2004
VEGETATION PROFILE

1. **indi**: indicator species for forested plant associations-recorded only when 50% or more of a subplot is in a forested condition class,
2. **nfor**: indicator species for nonforest plant associations (either completed or in development)-recorded only when 50% or more of a subplot is in a “natural” nonforest condition class,
3. **weed**: noxious or invasive plants of special interest-recorded on all lands, and
4. **sens**: usually rare species that are believed to be sensitive to management-recorded on all lands.

Most National Forests have produced illustrated guides to identify these forest indicator (“indi”) species and distinguish them from related species; they are listed below for each zone . Some species that are defined as “trees” by FIA, and should be sampled using normal tree tally procedures, are included on the list only for reference because they appear as “shrubs” in the R6 guides. The “R6 old species” names and codes are those found in the Plant Association Guides for the respective forests. Within each zone’s list, species are grouped first by use, then sorted by PLANTS species name.

1. NW Oregon

This list is to be used on the Mt. Hood, Siuslaw, and Willamette National Forests

ID Guide: Halverson, Nancy M. 1986. Major Indicator Shrubs and Herbs on National Forests of Western Oregon and Southwestern Washington. USDA Forest Service, Pacific Northwest Region R6-TM-229-1986.

PLANTS	PLANTS species	use	form	R6code	R6 old species	common_name
ACCI	<i>Acer circinatum</i>	indi	shrub	ACCI	<i>Acer circinatum</i>	Vine maple
ACTR	<i>Achlys triphylla</i>	indi	forb	ACTR	<i>Achlys triphylla</i>	Vanilla Leaf
ACRU2	<i>Actaea rubra</i>	indi	forb	ACRU	<i>Actaea rubra</i>	baneberry
ADBI	<i>Adenocaulon bicolor</i>	indi	forb	ADBI	<i>Adenocaulon bicolor</i>	trail plant
ADAL	<i>Adiantum aleuticum</i>	indi	forb	ADPE	<i>Adiantum pedatum</i>	maidenhar fern
AMAL2	<i>Amelanchier alnifolia</i>	indi	shrub	AMAL	<i>Amelanchier alnifolia</i>	Saskatoon Serviceberry
ARNE	<i>Arctostaphylos nevadensis</i>	indi	shrub	ARNE	<i>Arctostaphylos nevadensis</i>	pinemat manzanita
ARUV	<i>Arctostaphylos uva-ursi</i>	indi	shrub	ARUV	<i>Arctostaphylos uva-ursi</i>	Bearberry, Kinnikinnick
ASCA2	<i>Asarum caudatum</i>	indi	forb	ASCA3	<i>Asarum caudatum</i>	wild ginger
ATFI	<i>Athyrium filix-femina</i>	indi	forb	ATFI	<i>Athyrium filix-femina</i>	common ladyfern
BASA3	<i>Balsamorhiza sagittata</i>	indi	forb	BASA	<i>Balsamorhiza sagittata</i>	Arrowleaf Balsamroot
BLSP	<i>Blechnum spicant</i>	indi	forb	BLSP	<i>Blechnum spicant</i>	deer fern
CAGE2	<i>Carex geyeri</i>	indi	grami	CAGE	<i>Carex geyeri</i>	elk sedge
CHUM	<i>Chimaphila umbellata</i>	indi	shrub	CHUM	<i>Chimaphila umbellata</i>	Prince'S Pine
CHHC4	<i>Chrysolepis chrysophylla</i> va. <i>chrysophylla</i>	indi	tree	CACH	<i>Castanopsis chrysophylla</i>	Golden Chinquapin
CLSI2	<i>Claytonia sibirica</i>	indi	forb	MOSI	<i>Claytonia sibirica</i>	miner's lettuce
CLDO2	<i>Clinopodium douglasii</i>	indi	forb	SADO	<i>Satureja douglasii</i>	yerba buena
CLUN2	<i>Clintonia uniflora</i>	indi	forb	CLUN	<i>Clintonia uniflora</i>	queen's cup beadlilly
COCA13	<i>Cornus Canadensis</i>	indi	forb	COCA	<i>Cornus canadensis</i>	bunchberry
COCO6	<i>Corylus cornuta</i>	indi	shrub	COCO2	<i>Corylus cornuta</i>	California Hazel
DRCA11	<i>Dryopteris carthusiana</i>	indi	forb	DRAU2	<i>Dryopteris austriaca</i>	shield-fern
ERMO8	<i>Erythronium montanum</i>	indi	forb	ERMO	<i>Erythronium montanum</i>	avalanche lily/giant faw
EULEL2	<i>Eucephalus ledophyllus</i> var. <i>ledophyllus</i>	indi	forb	ASLE2	<i>Aster ledophyllus</i>	Cascades aster
FEOC	<i>Festuca occidentalis</i>	indi	grami	FEOC	<i>Festuca occidentalis</i>	Western Fescue
FEVI	<i>Festuca viridula</i>	indi	grami	FEVI	<i>Festuca viridula</i>	green fescue
FRAGA	<i>Fragaria</i> sp.	indi	forb	FRAGA	<i>Fragaria</i> sp.	strawberry species
FRVE	<i>Fragaria vesca</i>	indi	forb	FRVE	<i>Fragaria vesca</i>	woodland strawberry
GASH	<i>Gaultheria shallon</i>	indi	shrub	GASH	<i>Gaultheria shallon</i>	salal
HAL2	<i>Hieracium albiflorum</i>	indi	forb	HAL	<i>Hieracium albiflorum</i>	White Hawkweed

Annual Inventory 2004
VEGETATION PROFILE

PLANTS	PLANTS species	use	form	R6code	R6 old species	common_name
HODI	Holodiscus discolor	indi	shrub	HODI	Holodiscus discolor	oceanspray
JUCO6	Juniperus communis	indi	shrub	JUCO4	Juniperus communis	common juniper
LAPO3	Lathyrus polyphyllus	indi	forb	LAPO	Lathyrus polyphyllus	leafy pea vine
LIBO3	Linnaea borealis	indi	forb	LIBO2	Linnaea borealis	twinflower
LUZUL	Luzula sp.	indi	grami	LUZUL	Luzula sp.	woodrush
LYAM3	Lysichiton americanus	indi	forb	LYAM	Lysichiton americanum	skunk cabbage
MAAQ2	Mahonia aquifolium	indi	shrub	BEAQ	Berberis aquifolium	Tall Oregon Grape
MANE2	Mahonia nervosa	indi	shrub	BENE	Berberis nervosa	Oregon Grape
MADI2	Maianthemum dilatatum	indi	forb	MADI2	Maianthemum dilatatum	false lily of the vally
MARA7	Maianthemum racemosum	indi	forb	SMRA	Smilacina racemosa	False Solomn'S Seal
MAST4	Maianthemum stellatum	indi	forb	SMST	Smilacina stellata	Starry Solomn'S Seal
MEFE	Menziesia ferruginea	indi	shrub	MEFE	Menziesia ferruginea	fool's huckleberry
MOMA3	Moehringia macrophylla	indi	forb	ARMA3	Arenaria macrophylla	Bigleaf Sandwort
OPHO	Oplopanax horridus	indi	shrub	OPHO	Oplopanax horridus	devil's club
OSBE	Osmorhiza berteroi	indi	forb	OSCH	Osmorhiza chilensis	Sweet Cicely
OXOR	Oxalis oregana	indi	forb	OXOR	Oxalis oregana	Oregon oxalis
PHEM	Phyllodoce empetriformis	indi	shrub	PHEM	Phyllodoce empetriformis	pink mountain-heath
POPU3	Polemonium pulcherrimum	indi	forb	POPU	Polemonium pulcherrimum	Jacob's ladder
PODA	Polygonum davisiae	indi	forb	PONE4	Polygonum newberryi	Newberry's fleecflower
POMU	Polystichum munitum	indi	forb	POMU	Polystichum munitum	western swordfern
PUTR2	Purshia tridentata	indi	shrub	PUTR	Purshia tridentata	bitterbrush
RHAL2	Rhododendron albiflorum	indi	shrub	RHAL	Rhododendron albiflorum	cascades azalea
RHMA3	Rhododendron macrophyllum	indi	shrub	RHMA	Rhododendron macrophyllum	Pacific rhododendron
RUPA	Rubus parviflorus	indi	shrub	RUPA	Rubus parviflorus	Thimbleberry
RUSP	Rubus spectabilis	indi	shrub	RUSP	Rubus spectabilis	salmonberry
RUUR	Rubus ursinus	indi	shrub	RUUR	Rubus ursinus	Pacific blackberry
STME	Stachys mexicana	indi	forb	STME2	Stachys mexicana	Mexican hedgenettle
STLAC	Streptopus lanceolatus var. curvipes	indi	forb	STRO	Streptopus roseus	Rosy twistedstalk
SYAL	Symphoricarpos albus	indi	shrub	SYAL	Symphoricarpos albus	Common snowberry
SYHE	Symphoricarpos hesperius	indi	shrub	SYMO	Symphoricarpos mollis	Trailing Snowberry
SYRE	Synthyris reniformis	indi	forb	SYRE	Synthyris reniformis	snowqueen
TITR	Tiarella trifoliata	indi	forb	TITR	Tiarella trifoliata	threeleaf foamflower
TODI	Toxicodendron diversilobum	indi	shrub	RHDI	Rhus diversiloba	poison oak
TRBOL	Trientalis borealis ssp. Latifolia	indi	forb	TRLA2	Trientalis latifolia	Western Starflower
VADE	Vaccinium deliciosum	indi	shrub	VADE	Vaccinium deliciosum	delicious blueberry
VAME	Vaccinium membranaceum	indi	shrub	VAME	Vaccinium membranaceum	big huckleberry
VAOV	Vaccinium ovalifolium	indi	shrub	VAAL	Vaccinium alaskense	Alaska huckleberry
VAOV	Vaccinium ovalifolium	indi	shrub	VAOV	Vaccinium ovalifolium	oval-leaf huckleberry
VAOV2	Vaccinium ovatum	indi	shrub	VAOV2	Vaccinium ovatum	evergreen huckleberry
VAHE	Vancouveria hexandra	indi	forb	VAHE	Vancouveria hexandra	white inside-out-flower
WHMO	Whipplea modesta	indi	shrub	WHMO	Whipplea modesta	whipplevine
XETE	Xerophyllum tenax	indi	forb	XETE	Xerophyllum tenax	Beargrass

2. SW Oregon

Annual Inventory 2004
VEGETATION PROFILE

This list is to be used on the Rogue River, Siskiyou, and Umpqua National Forests

ID Guide: Seda, Anita, Thomas Atzet, and David Wheeler. 1989 (updated 1997). Key Species for Plant Associations on the Rogue River, Siskiyou, and Umpqua National Forests. USDA Forest Service, Pacific Northwest Region R6-NR-ECOL-TP-026-97.

PLANTS	PLANTS species	use	form	R6code	R6 old species	common_name
ACCI	<i>Acer circinatum</i>	indi	shrub	ACCI	<i>Acer circinatum</i>	Vine maple
ACGLD4	<i>Acer glabrum</i> var. <i>Douglasii</i>	indi	shrub	ACGLD	<i>Acer glabrum</i> var. <i>Douglasii</i>	Douglas maple
ACMI2	<i>Achillea millefolium</i>	indi	forb	ACMI	<i>Achillea millefolium</i>	Western Yarrow
ACTR	<i>Achlys triphylla</i>	indi	forb	ACTR	<i>Achlys triphylla</i>	Vanilla Leaf
ACRU2	<i>Actaea rubra</i>	indi	forb	ACRU	<i>Actaea rubra</i>	baneberry
ADBI	<i>Adenocaulon bicolor</i>	indi	forb	ADBI	<i>Adenocaulon bicolor</i>	trail plant
ANDE3	<i>Anemone deltoidea</i>	indi	forb	ANDE	<i>Anemone deltoidea</i>	threeleaf anemone
APAN2	<i>Apocynum androsaemifolium</i>	indi	forb	APAN	<i>Apocynum androsaemifolium</i>	spreading dogbane
ARCA5	<i>Arctostaphylos canescens</i>	indi	shrub	ARCA5	<i>Arctostaphylos canescens</i>	hoary manzanita
ARCO3	<i>Arctostaphylos columbiana</i>	indi	shrub	ARCO3	<i>Arctostaphylos columbiana</i>	hairy manzanita
ARNE	<i>Arctostaphylos nevadensis</i>	indi	shrub	ARNE	<i>Arctostaphylos nevadensis</i>	pinemat manzanita
ARPA6	<i>Arctostaphylos patula</i>	indi	shrub	ARPA	<i>Arctostaphylos patula</i>	Greenleaf Manzanita
ARCTO3	<i>Arctostaphylos</i> spp.	indi	shrub	ARCTO	<i>Arctostaphylos</i> spp.	<i>Arctostaphylos</i> spp.
ARVI4	<i>Arctostaphylos viscida</i>	indi	shrub	ARVI	<i>Arctostaphylos viscida</i>	whiteleaf manzanita
ARCO9	<i>Arnica cordifolia</i>	indi	forb	ARCO	<i>Arnica cordifolia</i>	heart-leaf arnica
ARLA8	<i>Arnica latifolia</i>	indi	forb	ARLA	<i>Arnica latifolia</i>	Broadleaf Arnica
ASDE6	<i>Aspidotis densa</i>	indi	forb	ASDE	<i>Aspidotis densa</i>	rock fern
CAPEV	<i>Carex pensylvanica</i> var. <i>vespertina</i>	indi	grami	CAPE5	<i>Carex pensylvanica</i>	Long-Stolon Sedge
CECU	<i>Ceanothus cuneatus</i>	indi	shrub	CECU	<i>Ceanothus cuneatus</i>	buckbrush
CEIN3	<i>Ceanothus integerrimus</i>	indi	shrub	CEIN	<i>Ceanothus intergerrimus</i>	deerbrush
CEPR	<i>Ceanothus prostratus</i>	indi	shrub	CEPR	<i>Ceanothus prostratus</i>	Squawcarpet
CEPU	<i>Ceanothus pumilus</i>	indi	shrub	CEPU	<i>Ceanothus pumilus</i>	dwarf ceanothus
CETH	<i>Ceanothus thyrsiflorus</i>	indi	shrub	CETH	<i>Ceanothus thyrsiflorus</i>	blue blossom ceanothus
CEVE	<i>Ceanothus velutinus</i>	indi	shrub	CEVE	<i>Ceanothus velutinus</i>	Snowbrush Ceanothus
CHME	<i>Chimaphila menziesii</i>	indi	shrub	CHME	<i>Chimaphila menziesii</i>	little prince's-pine
CHUM	<i>Chimaphila umbellata</i>	indi	shrub	CHUM	<i>Chimaphila umbellata</i>	Prince'S Pine
CHCHC4	<i>Chrysolepis chrysophylla</i> var. <i>chrysophylla</i>	indi	tree	CACH	<i>Castanopsis chrysophylla</i>	Golden Chinquapin
CLUN2	<i>Clintonia uniflora</i>	indi	forb	CLUN	<i>Clintonia uniflora</i>	queen's cup beadlilly
COCOC	<i>Corylus cornuta</i> var. <i>californica</i>	indi	shrub	COCOC	<i>Corylus cornuta californica</i>	California hazel
CYGR	<i>Cynoglossum grande</i>	indi	forb	CYGR	<i>Cynoglossum grande</i>	Pacific hound's-tongue
CYEC	<i>Cynosurus echinatus</i>	indi	grami	CYEC	<i>Cynosurus echinatus</i>	hedgehog dogtail
DIHOO	<i>Disporum hookeri</i> var. <i>oreganum</i>	indi	forb	DIHOO	<i>Disporum hookeri oreganum</i>	Oregon fairybell
EQAR	<i>Equisetum arvense</i>	indi	forb	EQAR	<i>Equisetum arvense</i>	Common horsetail
ERUM	<i>Eriogonum umbellatum</i>	indi	forb	ERUM	<i>Eriogonum umbellatum</i>	sulphurflower
FEID	<i>Festuca idahoensis</i>	indi	grami	FEID	<i>Festuca idahoensis</i>	idaho fescue

Annual Inventory 2004
VEGETATION PROFILE

PLANTS	PLANTS species	use	form	R6code	R6 old species	common_name
FESTU	<i>Festuca</i> sp.	indi	grami	FESTU	<i>Festuca</i> spp.	fescue species
FRVEB2	<i>Fragaria vesca</i> ssp. <i>bracteata</i>	indi	forb	FRVEB	<i>Fragaria vesca</i> <i>bracteata</i>	woods strawberry
FRCA12	<i>Frangula californica</i>	indi	shrub	RHCA	<i>Rhamnus californica</i>	coffeeberry
FRPU7	<i>Frangula purshiana</i>	indi	shrub	RHPU	<i>Rhamnus purshiana</i>	cascara
GAAM2	<i>Galium ambiguum</i>	indi	forb	GAAM	<i>Galium ambiguum</i>	obscure bedstraw
GAAP2	<i>Galium aparine</i>	indi	forb	GAAP	<i>Galium aparine</i>	catchweed bedstraw
GAOR	<i>Galium oreganum</i>	indi	forb	GAOR	<i>Galium oreganum</i>	Oregon bedstraw
GATR3	<i>Galium triflorum</i>	indi	forb	GATR	<i>Galium triflorum</i>	Sweetscented bedstraw
GABU2	<i>Garrya buxifolia</i>	indi	shrub	GABU	<i>Garrya buxifolia</i>	box-leaved silk-tassel
GAOV2	<i>Gaultheria ovatifolia</i>	indi	shrub	GAOV	<i>Gaultheria ovatifolia</i>	slender salal
GASH	<i>Gaultheria shallon</i>	indi	shrub	GASH	<i>Gaultheria shallon</i>	salal
GOOB2	<i>Goodyera oblongifolia</i>	indi	forb	GOOB	<i>Goodyera oblongifolia</i>	Western Rattlesnake-Plantain
HIAL2	<i>Hieracium albiflorum</i>	indi	forb	HIAL	<i>Hieracium albiflorum</i>	White Hawkweed
HODI	<i>Holodiscus discolor</i>	indi	shrub	HODI	<i>Holodiscus discolor</i>	oceanspray
LEDA	<i>Leucothoe davisiae</i>	indi	shrub	LEDA	<i>Leucothoe davisiae</i>	Sierra-laurel
LIBOL2	<i>Linnaea borealis</i> ssp. <i>longiflora</i>	indi	forb	LIBOL	<i>Linnaea borealis</i> <i>longiflora</i>	western twinflower
LIDEE	<i>Lithocarpus densiflora</i> var. <i>echinoides</i>	indi	tree	LIDEE	<i>Lithocarpus densiflora</i> <i>echinoides</i>	tanoak (shrub form)
LOHI2	<i>Lonicera hispidula</i>	indi	shrub	LOHI	<i>Lonicera hispidula</i>	hairy honeysuckle
MAMA	<i>Madia radioides</i>	indi	forb	MAMA	<i>Madia radioides</i>	woodland tarweed
MAAQ2	<i>Mahonia aquifolium</i>	indi	shrub	BEPI	<i>Berberis piperiana</i>	Piper's Oregongrape
MANE2	<i>Mahonia nervosa</i>	indi	shrub	BENE	<i>Berberis nervosa</i>	Oregon Grape
MARE11	<i>Mahonia repens</i>	indi	shrub	BERE	<i>Berberis repens</i>	Creeping Oregon Grape
MARA7	<i>Maianthemum racemosum</i>	indi	forb	SMRA	<i>Smilacina racemosa</i>	False Solomn'S Seal
MAST4	<i>Maianthemum stellatum</i>	indi	forb	SMST	<i>Smilacina stellata</i>	Starry Solomn'S Seal
MESU	<i>Melica subulata</i>	indi	grami	MESU	<i>Melica subulata</i>	Alaska oniongrass
MITR4	<i>Mitella trifida</i>	indi	forb	MITR2	<i>Mitella trifida</i>	three-tooth mitrewort
MOOD	<i>Monardella odoratissima</i>	indi	forb	MOOD	<i>Monardella odoratissima</i>	mountain balm
ORSE	<i>Orthilia secunda</i>	indi	forb	PYSE	<i>Pyrola secunda</i>	Sidebells Pyrola
OSBE	<i>Osmorhiza berteroi</i>	indi	forb	OSCH	<i>Osmorhiza chilensis</i>	Sweet Cicely
OSPU	<i>Osmorhiza purpurea</i>	indi	forb	OSPU	<i>Osmorhiza purpurea</i>	purple sweet-root
OXOR	<i>Oxalis oregana</i>	indi	forb	OXOR	<i>Oxalis oregana</i>	Oregon oxalis
PAMY	<i>Paxistima myrsinites</i>	indi	shrub	PAMY	<i>Pachistima myrsinites</i>	Oregon Boxwood
POPU3	<i>Polemonium pulcherrimum</i>	indi	forb	POPU	<i>Polemonium pulcherrimum</i>	Jacob's ladder
POMU	<i>Polystichum munitum</i>	indi	forb	POMU	<i>Polystichum munitum</i>	western swordfern
PTAQ	<i>Pteridium aquilinum</i>	indi	forb	PTAQ	<i>Pteridium aquilinum</i>	bracken fern
PYAS	<i>Pyrola asarifolia</i>	indi	forb	PYAS	<i>Pyrola asarifolia</i>	alpine pyrola
PYDE	<i>Pyrola dentata</i>	indi	forb	PYDE	<i>Pyrola dentata</i>	toothleaf pyrola
PYPI2	<i>Pyrola picta</i>	indi	forb	PYPI	<i>Pyrola picta</i>	whitevein pyrola
QUSA2	<i>Quercus sadleriana</i>	indi	shrub	QUSA	<i>Quercus sadleriana</i>	Sadler oak
QUVA	<i>Quercus vaccinifolia</i>	indi	shrub	QUVA	<i>Quercus vaccinifolia</i>	huckleberry oak
RHMA3	<i>Rhododendron macrophyllum</i>	indi	shrub	RHMA	<i>Rhododendron macrophyllum</i>	Pacific rhododendron

Annual Inventory 2004
VEGETATION PROFILE

PLANTS	PLANTS species	use	form	R6code	R6 old species	common_name
RHOC	Rhododendron occidentale	indi	shrub	RHOC	Rhododendron occidentale	western azalea
RIBI	Ribes binominatum	indi	shrub	RIBI	Ribes binominatum	Siskiyou gooseberry
RICE	Ribes cereum	indi	shrub	RICE	Ribes cereum	Squaw Current
RICR	Ribes cruentum	indi	shrub	RICR	Ribes cruentum	shinyleaf gooseberry
RILA	Ribes lacustre	indi	shrub	RILA	Ribes lacustre	Prickly currant
RILO	Ribes lobbii	indi	shrub	RILO	Ribes lobbii	gummy gooseberry
RIMA2	Ribes marshallii	indi	shrub	RIMA	Ribes marshallii	Applegate gooseberry
RISA	Ribes sanguineum	indi	shrub	RISA	Ribes sanguineum	red currant
RIVI3	Ribes viscosissimum	indi	shrub	RIVI	Ribes viscosissimum	Sticky Currant
ROGY	Rosa gymnocarpa	indi	shrub	ROGY	Rosa gymnocarpa	Baldhip Rose
RULA2	Rubus lasiococcus	indi	shrub	RULA	Rubus lasiococcus	dwarf bramble
RUNI2	Rubus nivalis	indi	shrub	RUNI	Rubus nivalis	snow bramble
RUSP	Rubus spectabilis	indi	shrub	RUSP	Rubus spectabilis	salmonberry
RUUR	Rubus ursinus	indi	shrub	RUUR	Rubus ursinus	Pacific blackberry
SYHE	Symphoricarpos hesperius	indi	shrub	SYMO	Symphoricarpos mollis	Trailing Snowberry
TITRU	Tiarella trifoliata var. unifoliata	indi	forb	TITRU	Tiarella trifoliata unifoliata	coolwort foamflower
TODI	Toxicodendron diversilobum	indi	shrub	RHDI	Rhus diversiloba	poison oak
TRBOL	Trientalis borealis ssp. latifolia	indi	forb	TRLA2	Trientalis latifolia	Western Starflower
TROV2	Trillium ovatum	indi	forb	TROV	Trillium ovatum	White trillium
VAME	Vaccinium membranaceum	indi	shrub	VAME	Vaccinium membranaceum	big huckleberry
VAOV2	Vaccinium ovatum	indi	shrub	VAOV2	Vaccinium ovatum	evergreen huckleberry
VAPA	Vaccinium parvifolium	indi	shrub	VAPA	Vaccinium parvifolium	red huckleberry
VASC	Vaccinium scoparium	indi	shrub	VASC	Vaccinium scoparium	grouse huckleberry
VASI	Valeriana sitchensis	indi	forb	VASI	Valeriana sitchensis	sitka valerian
VAHE	Vancouveria hexandra	indi	forb	VAHE	Vancouveria hexandra	white inside-out-flower
VIGL	Viola glabella	indi	forb	VIGL	Viola glabella	stream violet
VIOR	Viola orbiculata	indi	forb	VIOR2	Viola orbiculata	round-leaved violet
WHMO	Whipplea modesta	indi	shrub	WHMO	Whipplea modesta	whipplevine
XETE	Xerophyllum tenax	indi	forb	XETE	Xerophyllum tenax	Beargrass
ACNO4	Acaena novae-zelandica	weed	forb	ACAN?	Acaena anserinifolia	Biddy-biddy
ACRE3	Acroptilon repens	weed	forb	CERE	Centaurea repens	Russian knapweed
CANU4	Carduus nutans	weed	forb	CANU5	Carduus nutans	Musk thistle
CAPY2	Carduus pycnocephalus	weed	forb	CAPY3	Carduus pycnocephalus	Italian thistle
CALA20	Carthamus lanatus	weed	forb	CALA?	Carthamus lanatus	Woolly distaff thistle
CEBI2	Centaurea biebersteinii	weed	forb	CEMA	Centaurea maculosa	Spotted knapweed
CEDET	Centaurea debeauxii ssp. thuillieri	weed	forb	CEPR?	Centaurea pratensis	Meadow knapweed
CEDI3	Centaurea diffusa	weed	forb	CEDI	Centaurea diffusa	Diffuse knapweed
CEME2	Centaurea melitensis	weed	forb	CEME	Centaurea melitensis	Malta starthistle
CESO3	Centaurea solstitialis	weed	forb	CESO	Centaurea solstitialis	Yellow starthistle
CETR8	Centaurea triumfetti	weed	forb	CEVI?	Centaurea virgata	Squarrose knapweed
CHJU	Chondrilla juncea	weed	forb	CHJU	Chondrilla juncea	Rush skeletonweed
CIAR4	Cirsium arvense	weed	forb	CIAR	Cirsium arvense	Canada thistle
CIVU	Cirsium vulgare	weed	forb	CIVU	Cirsium vulgare	Bull thistle

Annual Inventory 2004
VEGETATION PROFILE

PLANTS	PLANTS species	use	form	R6code	R6 old species	common_name
COAR4	<i>Convolvulus arvensis</i>	weed	forb	COAR2	<i>Convolvulus arvensis</i>	Field bindweed
CORTA	<i>Cortaderia</i> spp.	weed	grami	CORTA?	<i>Cortaderia</i> spp.	Pampas grasses
CYOF	<i>Cynoglossum officinale</i>	weed	forb	CYOF	<i>Cynoglossum officinale</i>	Houndstongue
CYES3	<i>Cyperus esculentus</i>	weed	grami	CYES	<i>Cyperus esculentus</i>	Yellow nutsedge
CYSC4	<i>Cytisus scoparius</i>	weed	shrub	CYSC	<i>Cytisus scoparius</i>	Scotch broom
ELRE4	<i>Elymus repens</i>	weed	grami	AGRE	<i>Agropyron repens</i>	Quackgrass
GEMO2	<i>Genista monspessulana</i>	weed	shrub	CYMO3	<i>Cytisus monspessulanas</i>	French broom
HYPE	<i>Hypericum perforatum</i>	weed	forb	HYPE	<i>Hypericum perforatum</i>	St. Johnswort
ISTI	<i>Isatis tinctoria</i>	weed	forb	ISTI	<i>Isatis tinctoria</i>	Dyers woad
LIDA	<i>Linaria dalmatica</i>	weed	forb	LIDA	<i>Linaria dalmatica</i>	Dalmation toadflax
LIVU2	<i>Linaria vulgaris</i>	weed	forb	LIVU2	<i>Linaria vulgaris</i>	Yellow toadflax
LYSA2	<i>Lythrum salicaria</i>	weed	forb	LYSA	<i>Lythrum salicaria</i>	Purple loosestrife
POSA4	<i>Polygonum sachalinense</i>	weed	forb	POSA2	<i>Polygonum sachalinense</i>	Giant knotweed
SEJA	<i>Senecio jacobaea</i>	weed	forb	SEJA	<i>Senecio jacobaea</i>	Tansy ragwort
SIMA3	<i>Silybum marianum</i>	weed	forb	SIMA3	<i>Silybum marianum</i>	Milk thistle
SPJU2	<i>Spartium junceum</i>	weed	shrub	SPJU?	<i>Spartium junceum</i>	Spanish broom
TACA8	<i>Taeniatherum caput-medusae</i>	weed	grami	TACA2	<i>Taeniatherum caput-medusae</i>	Medusahead rye
TRTE	<i>Tribulus terrestris</i>	weed	forb	TRTE	<i>Tribulus terrestris</i>	Puncturevine
ULEU	<i>Ulex europaeus</i>	weed	shrub	ULEU	<i>Ulex europaeus</i>	Gorse

3. Central Oregon

This list is to be used on the Deschutes, Fremont, Ochoco, and Winema National Forests, and the Crooked River National Grassland.

ID Guide: Hopkins, William, and Robert Rawlings. 1988 (revised version). Major Indicator Shrubs and Herbs on National Forests of Eastern Oregon. USDA Forest Service, Pacific Northwest Region R6-TM-190-1985.

PLANTS	PLANTS species	use	form	R6code	R6 old species	common_name
ACCI	<i>Acer circinatum</i>	indi	shrub	ACCI	<i>Acer circinatum</i>	Vine maple
ACGLD4	<i>Acer glabrum</i> var. <i>Douglasii</i>	indi	shrub	ACGLD	<i>Acer glabrum</i> var. <i>Douglasii</i>	Douglas maple
ACMI2	<i>Achillea millefolium</i>	indi	forb	ACMI	<i>Achillea millefolium</i>	Western Yarrow
ACTR	<i>Achlys triphylla</i>	indi	forb	ACTR	<i>Achlys triphylla</i>	Vanilla Leaf
ACOCO	<i>Achnatherum occidentale</i> ssp. <i>occidentale</i>	indi	grami	STOC	<i>Stipa occidentalis</i>	western needlegrass
AMAL2	<i>Amelanchier alnifolia</i>	indi	shrub	AMALA	<i>Amelanchier alnifolia</i>	Saskatoon Serviceberry
ANOR	<i>Anemone oregana</i>	indi	forb	ANOR	<i>Anemone oregana</i>	Oregon Anemone
ANPI	<i>Anemone piperi</i>	indi	forb	ANPI	<i>Anemone piperi</i>	Piper's Anemone
ARNE	<i>Arctostaphylos nevadensis</i>	indi	shrub	ARNE	<i>Arctostaphylos nevadensis</i>	pinemat manzanita
ARPA6	<i>Arctostaphylos patula</i>	indi	shrub	ARPA	<i>Arctostaphylos patula</i>	Greenleaf Manzanita
ARUV	<i>Arctostaphylos uva-ursi</i>	indi	shrub	ARUV	<i>Arctostaphylos uva-ursi</i>	Bearberry, Kinnikinnick
ARKI	<i>Arenaria kingii</i>	indi	forb	ARKI	<i>Arenaria kingii</i>	King's Sandwort
ARCO9	<i>Arnica cordifolia</i>	indi	forb	ARCO	<i>Arnica cordifolia</i>	heart-leaf arnica
ARLA8	<i>Arnica latifolia</i>	indi	forb	ARLA	<i>Arnica latifolia</i>	Broadleaf Arnica
ARAR8	<i>Artemisia arbuscula</i>	indi	shrub	ARAR	<i>Artemisia arbuscula</i>	low sagebrush
ARRI2	<i>Artemisia rigida</i>	indi	shrub	ARRI	<i>Artemisia rigida</i>	stiff sagebrush

Annual Inventory 2004
VEGETATION PROFILE

PLANTS	PLANTS species	use	form	R6code	R6 old species	common_name
ARTR2	<i>Artemisia tridentata</i>	indi	shrub	ARTR	<i>Artemisia tridentata</i>	Big Sagebrush
ARTRV	<i>Artemisia tridentata</i> ssp. <i>vaseyana</i>	indi	shrub	ARTRV	<i>Artemisia tridentata</i> <i>vaseyana</i>	mountain big sagebrush
BASA3	<i>Balsamorhiza sagittata</i>	indi	forb	BASA	<i>Balsamorhiza sagittata</i>	Arrowleaf Balsamroot
BRCA5	<i>Bromus carinatus</i>	indi	grami	BRCA	<i>Bromus carinatus</i>	California Brome
BRTE	<i>Bromus tectorum</i>	indi	grami	BRTE	<i>Bromus tectorum</i>	Cheatgrass
BRVU	<i>Bromus vulgaris</i>	indi	grami	BRVU	<i>Bromus vulgaris</i>	columbia brome
CARU	<i>Calamagrostis rubescens</i>	indi	grami	CARU	<i>Calamagrostis rubescens</i>	pinegrass
CASTI3	<i>Calamagrostis stricta</i> ssp. <i>inexpansa</i>	indi	grami	CAIN	<i>Calamagrostis inexpansa</i>	Northern Reedgrass
CACO11	<i>Carex concinnoides</i>	indi	grami	CACO	<i>Carex concinnoides</i>	Northwestern Sedge
CAGE2	<i>Carex geyeri</i>	indi	grami	CAGE	<i>Carex geyeri</i>	elk sedge
CANE2	<i>Carex nebrascensis</i>	indi	grami	CANE	<i>Carex nebraskensis</i>	Nebraska sedge
CAPEV	<i>Carex pensylvanica</i> var. <i>vespertina</i>	indi	grami	CAPE5	<i>Carex pensylvanica</i>	Long-Stolon Sedge
CARO5	<i>Carex rossii</i>	indi	grami	CARO	<i>Carex rossii</i>	ross' sedge
CEPR	<i>Ceanothus prostratus</i>	indi	shrub	CEPR	<i>Ceanothus prostratus</i>	Squawcarpet
CEVE	<i>Ceanothus velutinus</i>	indi	shrub	CEVE	<i>Ceanothus velutinus</i>	Snowbrush Ceanothus
CELE3	<i>Cercocarpus ledifolius</i>	indi	tree	CELE	<i>Cercocarpus ledifolius</i>	curlleaf mountain mahogany
CHUM	<i>Chimaphila umbellata</i>	indi	shrub	CHUM	<i>Chimaphila umbellata</i>	Prince'S Pine
CHCHC4	<i>Chrysolepis chrysophylla</i> va. <i>chrysophylla</i>	indi	tree	CACH	<i>Castanopsis chrysophylla</i>	Golden Chinquapin
CIVU	<i>Cirsium vulgare</i>	indi	forb	CIVU	<i>Cirsium vulgare</i>	bull thistle
CLUN2	<i>Clintonia uniflora</i>	indi	forb	CLUN	<i>Clintonia uniflora</i>	queen's cup beadlilly
CONU4	<i>Cornus nuttallii</i>	indi	tree	CONU	<i>Cornus nuttallii</i>	Pacific dogwood
COCO6	<i>Corylus cornuta</i>	indi	shrub	COCO2	<i>Corylus cornuta</i>	California Hazel
DITR2	<i>Disporum trachycarpum</i>	indi	forb	DITR	<i>Disporum tracycarpum</i>	fairly bells
ELELE	<i>Elymus elymoides</i> ssp. <i>elymoides</i>	indi	grami	SIHY	<i>Sitanion hystrix</i>	Bottlebrush Squirreltail
ELGL	<i>Elymus glaucus</i>	indi	grami	ELGL	<i>Elymus glaucus</i>	Blue wildrye
EUCO36	<i>Eurybia conspicua</i>	indi	forb	ASCO	<i>Aster conspicuus</i>	Showy Aster
FEID	<i>Festuca idahoensis</i>	indi	grami	FEID	<i>Festuca idahoensis</i>	idaho fescue
FEOC	<i>Festuca occidentalis</i>	indi	grami	FEOC	<i>Festuca occidentalis</i>	Western Fescue
FRVI	<i>Fragaria virginiana</i>	indi	forb	FRVI	<i>Fragaria virginiana</i>	Strawberry
GOOB2	<i>Goodyera oblongifolia</i>	indi	forb	GOOB	<i>Goodyera oblongifolia</i>	Western Rattlesnake-Plantain
HABL3	<i>Haplopappus bloomeri</i>	indi	forb	HABL	<i>Haplopappus bloomeri</i>	Rabbitbrush Goldenweed
HIAL2	<i>Hieracium albiflorum</i>	indi	forb	HIAL	<i>Hieracium albiflorum</i>	White Hawkweed
HICY	<i>Hieracium cynoglossoides</i>	indi	forb	HIAL2	<i>Hieracium albertinum</i>	Western Hawkweed
HODI	<i>Holodiscus discolor</i>	indi	shrub	HODI	<i>Holodiscus discolor</i>	oceanspray
LALA3	<i>Lathyrus lanszwertii</i>	indi	forb	LALA2	<i>Lathyrus lanszwertii</i>	Thick-Leaved Peavine
LINUN	<i>Linanthus nuttallii</i> ssp. <i>nuttallii</i>	indi	forb	LINU	<i>Linanthastrum nuttallii</i>	Linanthastrum
LIBO3	<i>Linnaea borealis</i>	indi	forb	LIBO2	<i>Linnaea borealis</i>	twinflor
LOCA6	<i>Lonicera caerulea</i>	indi	shrub	LOCA3	<i>Lonicera caerulea</i>	Fly Honeysuckle
LOCO5	<i>Lonicera conjugialis</i>	indi	shrub	LOCO	<i>Lonicera conjugialis</i>	Purpleflower Honeysuckle
LOIN5	<i>Lonicera involucrata</i>	indi	shrub	LOIN	<i>Lonicera involucrata</i>	Bearberry Honeysuckle

Annual Inventory 2004
VEGETATION PROFILE

PLANTS	PLANTS species	use	form	R6code	R6 old species	common_name
LUAL3	Lupinus albicaulis	indi	forb	LUAL	Lupinus albicaulis	Pine Lupine
LUAR3	Lupinus argenteus	indi	forb	LUAR3	Lupinus argenteus	Silvery Lupine
LUCA	Lupinus caudatus	indi	forb	LUCA	Lupinus caudatus	Tailcup Lupine
LUHI4	Luzula hitchcocki	indi	grami	LUHI	Luzula hitchcocki	Smooth Woodrush
LUMUM2	Luzula multiflora ssp. multiflora var. multiflora	indi	grami	LUCAM	Luzula campestris multiflora	Common Woodrush
MAAQ2	Mahonia aquifolium	indi	shrub	BEAQ	Berberis aquifolium	Tall Oregon Grape
MANE2	Mahonia nervosa	indi	shrub	BENE	Berberis nervosa	Oregon Grape
MARE11	Mahonia repens	indi	shrub	BERE	Berberis repens	Creeping Oregon Grape
MARA7	Maianthemum racemosum	indi	forb	SMRA	Smilacina racemosa	False Solomn's Seal
MAST4	Maianthemum stellatum	indi	forb	SMST	Smilacina stellata	Starry Solomn's Seal
MIST3	Mitella stauropetala	indi	forb	MIST2	Mitella stauropetala	Side-Flowered Mitrewort
MOMA3	Moehringia macrophylla	indi	forb	ARMA3	Arenaria macrophylla	Bigleaf Sandwort
ORSE	Orthilia secunda	indi	forb	PYSE	Pyrola secunda	Sidebells Pyrola
OSBE	Osmorhiza berteroi	indi	forb	OSCH	Osmorhiza chilensis	Sweet Cicely
PAMY	Paxistima myrsinites	indi	shrub	PAMY	Pachistima myrsinites	Oregon Boxwood
PEEU	Penstemon euglaucus	indi	forb	PEEU	Penstemon euglaucus	Glaucus Penstemon
PELA7	Penstemon laetus	indi	forb	PELA	Penstemon laetus	Gay Penstemon
PHMA5	Physocarpus malvaceus	indi	shrub	PHMA	Physocarpus malvaceus	ninebark
PONE2	Poa nervosa	indi	grami	PONE	Poa nervosa	Wheeler'S Bluegrass
POSE	Poa secunda	indi	grami	POSA3	Poa sandbergii	Sandberg's Bluegrass
POPU3	Polemonium pulcherrimum	indi	forb	POPU	Polemonium pulcherrimum	Jacob's ladder
PSSPS	Pseudoroegneria spicata ssp. spicata	indi	grami	AGSP	Agropyron spicatum	bluebunch wheatgrass
PSJA2	Pseudostellaria jamesiana	indi	forb	STJA	Stellaria jamesiana	Tuber Starwort
PTAQ	Pteridium aquilinum	indi	forb	PTAQ	Pteridium aquilinum	bracken fern
PUTR2	Purshia tridentata	indi	shrub	PUTR	Purshia tridentata	bitterbrush
RICE	Ribes cereum	indi	shrub	RICE	Ribes cereum	Squaw Current
RILA	Ribes lacustre	indi	shrub	RILA	Ribes lacustre	Prickly currant
RIVI3	Ribes viscosissimum	indi	shrub	RIVI	Ribes viscosissimum	Sticky Currant
ROGY	Rosa gymnocarpa	indi	shrub	ROGY	Rosa gymnocarpa	Baldhip Rose
RUPA	Rubus parviflorus	indi	shrub	RUPA	Rubus parviflorus	Thimbleberry
SASC	Salix scouleriana	indi	shrub	SASC	Salix scouleriana	Scouler's Willow
SPBE2	Spiraea betulifolia	indi	shrub	SPBE	Spiraea betulifolia	birchleaf spirea
SPDOM	Spiraea douglasii var. menzensii	indi	shrub	SPDOM	Spiraea douglasii menzensii	Menzies Spirea
SYAL	Symphoricarpos albus	indi	shrub	SYAL	Symphoricarpos albus	Common snowberry
SYHE	Symphoricarpos hesperius	indi	shrub	SYMO	Symphoricarpos mollis	Trailing Snowberry
THOC	Thalictrum occidentale	indi	forb	THOC	Thalictrum occidentale	Western Meadowrue
TRBOL	Trientalis borealis ssp. latifolia	indi	forb	TRLA2	Trientalis latifolia	Western Starflower
VACA13	Vaccinium caespitosum	indi	shrub	VACA	Vaccinium caespitosum	Dwarf Huckleberry
VAME	Vaccinium membranaceum	indi	shrub	VAME	Vaccinium membranaceum	big huckleberry
VASC	Vaccinium scoparium	indi	shrub	VASC	Vaccinium scoparium	grouse huckleberry
VAUL	Vaccinium uliginosum	indi	shrub	VAOC2	Vaccinium occidentale	Bog blueberry
WYAM	Wyethia amplexicaulis	indi	forb	WYAM	Wyethia amplexicaulis	Mules Ear Wyethia

Annual Inventory 2004
VEGETATION PROFILE

PLANTS	PLANTS species	use	form	R6code	R6 old species	common_name
WYHE2	Wyethia helianthoides	indi	forb	WYHE	Wyethia helianthoides	White-Head Wyethia
WYMO	Wyethia mollis	indi	forb	WYMO	Wyethia mollis	Woolly Wyethia
XETE	Xerophyllum tenax	indi	forb	XETE	Xerophyllum tenax	Beargrass
ACRE3	Acroptilon repens	weed	forb	CERE	Centaurea repens	Russian Knapweed
CANU4	Carduus nutans	weed	forb	CANU	Carduus nutans	musk thistle
CEBI2	Centaurea biebersteinii	weed	forb	CEMA	Centaurea maculosa	spotted knapweed
CESO3	Centaurea solstitialis	weed	forb	CESO	Centaurea solstitialis	yellow starthistle
CEDI3	Centurea diffusa	weed	forb	CEDI	Centurea diffusa	diffuse knapweed
CIAR4	Cirsium arvense	weed	forb	CIAR	Cirsium arvense	canada thistle
EUES	Euphorbia esula	weed	forb	EUES	Euphorbia esula	leafy spurge
HYPE	Hypericum perforatum	weed	forb	HYPE	Hypericum perforatum	common st. john's wort
ISTI	Isatis tinctoria	weed	forb	ISTI	Isatis tinctoria	Dyers Woad
LIDA	Linaria dalmatica	weed	forb	LIDA	Linaria dalmatica	dalmation toadflax
ONAC	Onopordum acanthium	weed	forb	ONAC	Onopordum acanthium	scotch thistle
SAAE	Salvia aethiopis	weed	forb	SAAE	Salvia aethiopis	mediterranean sage
SEJA	Senecio jacobaea	weed	forb	SEJA	Senecio jacobaea	tansy ragwort
TACA8	Taeniatherum caput-medusae	weed	grami	TACA	Taeniatherum caput-medusae	medusa head

4. NE Oregon

This list is to be used on the Malheur, Umatilla, and Wallowa-Whitman National Forests.

Note: only record those species that apply to the appropriate vegetation series for the plot (e.g. ABLA2 or PIPO). Record any weed found on the plot.

ID Guide: Johnson, Charles Grier Jr. 1993. Common Plants of the Inland Pacific Northwest, Malheur, Umatilla, Wallowa-Whitman National Forests. USDA Forest Service, Pacific Northwest Region R6-ERW-TP051-93.

PLANTS	PLANTS species	use	form	R6code	R6 old species	common_name
ARCO9	Arnica cordifolia	ABLA2	forb	ARCO	Arnica cordifolia	heart-leaf arnica
CLUN2	Clintonia uniflora	ABLA2	forb	CLUN	Clintonia uniflora	queen's cup beadlilly
LIBO3	Linnaea borealis	ABLA2	forb	LIBO2	Linnaea borealis	twinflower
POPU3	Polemonium pulcherrimum	ABLA2	forb	POPU	Polemonium pulcherrimum	Jacob's ladder
POPH	Polygonum phytolaccaefolium	ABLA2	forb	POPH	Polygonum phytolaccaefolium	pokeweed fleecflower
SETR	Senecio triangularis	ABLA2	forb	SETR	Senecio triangularis	arrowleaf groundsel
STAM2	Streptopus amplexifolius	ABLA2	forb	STAM	Streptopus amplexifolius	twisted stalk
TITRU	Tiarella trifoliata var. unifoliata	ABLA2	forb	TITRU	Tiarella trifoliata unifoliata	coolwort foamflower
TRCA	Trautvetteria caroliniensis	ABLA2	forb	TRCA3	Trautvetteria caroliniensis	false bugbane
VASI	Valeriana sitchensis	ABLA2	forb	VASI	Valeriana sitchensis	sitka valerian
BRVU	Bromus vulgaris	ABLA2	grami	BRVU	Bromus vulgaris	columbia brome
CARU	Calamagrostis rubescens	ABLA2	grami	CARU	Calamagrostis rubescens	pinegrass
CAGE2	Carex geyeri	ABLA2	grami	CAGE	Carex geyeri	elk sedge
CARO5	Carex rossii	ABLA2	grami	CARO	Carex rossii	ross' sedge
JUDR	Juncus drummondii	ABLA2	grami	JUDR	Juncus drummondii	drummond rush
ACOCO	Achnatherum occidentale ssp. occidentale	ABLA2	grami	STOC	Stipa occidentalis	western needlegrass
MEFE	Menziesia ferruginea	ABLA2	shrub	MEFE	Menziesia ferruginea	fool's huckleberry
PHEM	Phyllodoce empetriformis	ABLA2	shrub	PHEM	Phyllodoce empetriformis	pink mountain-heath

Annual Inventory 2004
VEGETATION PROFILE

PLANTS	PLANTS species	use	form	R6code	R6 old species	common_name
RHAL2	Rhododendron albiflorum	ABLA2	shrub	RHAL	Rhododendron albiflorum	cascades azalea
VAME	Vaccinium membranaceum	ABLA2	shrub	VAME	Vaccinium membranaceum	big huckleberry
VASC	Vaccinium scoparium	ABLA2	shrub	VASC	Vaccinium scoparium	grouse huckleberry
ADBI	Adenocaulon bicolor	ABGR	forb	ADBI	Adenocaulon bicolor	trail plant
ARCO9	Arnica cordifolia	ABGR	forb	ARCO	Arnica cordifolia	heart-leaf arnica
ASCA2	Asarum caudatum	ABGR	forb	ASCA3	Asarum caudatum	wild ginger
CLUN2	Clintonia uniflora	ABGR	forb	CLUN	Clintonia uniflora	queen's cup beadiilly
COOC2	Coptis occidentalis	ABGR	forb	COOC2	Coptis occidentalis	goldthread
COCA13	Cornus canadensis	ABGR	forb	COCA	Cornus canadensis	bunchberry
DITR2	Disporum trachycarpum	ABGR	forb	DITR	Disporum tracycarpum	fairy bells
GYDR	Gymnocarpium dryopteris	ABGR	forb	GYDR	Gymnocarpium dryopteris	oak fern
LIBO3	Linnaea borealis	ABGR	forb	LIBO2	Linnaea borealis	twinline
POMU	Polystichum munitum	ABGR	forb	POMU	Polystichum munitum	western swordfern
PTAQ	Pteridium aquilinum	ABGR	forb	PTAQ	Pteridium aquilinum	bracken fern
TITRU	Tiarella trifoliata var. unifoliata	ABGR	forb	TITRU	Tiarella trifoliata unifoliata	coolwort foamflower
TRCA	Trautvetteria caroliniensis	ABGR	forb	TRCA3	Trautvetteria caroliniensis	false bugbane
BRVU	Bromus vulgaris	ABGR	grami	BRVU	Bromus vulgaris	columbia brome
CARU	Calamagrostis rubescens	ABGR	grami	CARU	Calamagrostis rubescens	pinegrass
CAGE2	Carex geyeri	ABGR	grami	CAGE	Carex geyeri	elk sedge
CARO5	Carex rossii	ABGR	grami	CARO	Carex rossii	ross' sedge
ACGLD4	Acer glabrum var. Douglasii	ABGR	tree	ACGL	Acer glabrum var. Douglasii	Douglas maple
ALVIS	Alnus viridis ssp. sinuata	ABGR	shrub	ALSI	Alnus sinuata	sitka alder
ARNE	Arctostaphylos nevadensis	ABGR	shrub	ARNE	Arctostaphylos nevadensis	pinemat manzanita
SPBE2	Spiraea betulifolia	ABGR	shrub	SPBE	Spiraea betulifolia	birchleaf spirea
VAME	Vaccinium membranaceum	ABGR	shrub	VAME	Vaccinium membranaceum	big huckleberry
VASC	Vaccinium scoparium	ABGR	shrub	VASC	Vaccinium scoparium	grouse huckleberry
TABR2	Taxus brevifolia	ABGR	tree	TABR	Taxus brevifolia	western yew
CARU	Calamagrostis rubescens	PSME	grami	CARU	Calamagrostis rubescens	pinegrass
CAGE2	Carex geyeri	PSME	grami	CAGE	Carex geyeri	elk sedge
ACGLD4	Acer glabrum var. Douglasii	PSME	tree	ACGL	Acer glabrum var. Douglasii	Douglas maple
ARNE	Arctostaphylos nevadensis	PSME	shrub	ARNE	Arctostaphylos nevadensis	pinemat manzanita
HODI	Holodiscus discolor	PSME	shrub	HODI	Holodiscus discolor	oceanspray
PHMA5	Physocarpus malvaceus	PSME	shrub	PHMA	Physocarpus malvaceus	ninebark
SPBE2	Spiraea betulifolia	PSME	shrub	SPBE	Spiraea betulifolia	birchleaf spirea
SYAL	Symphoricarpos albus	PSME	shrub	SYAL	Symphoricarpos albus	Common snowberry
SYOR2	Symphoricarpos oreophilus	PSME	shrub	SYOR	Symphoricarpos oreophilus	mountain snowberry
VAME	Vaccinium membranaceum	PSME	shrub	VAME	Vaccinium membranaceum	big huckleberry
CELE3	Cercocarpus ledifolius	PSME	tree	CELE	Cercocarpus ledifolius	curlleaf mountain mahogany
PSSPS	Pseudoroegneria spicata ssp. spicata	PIPO	grami	AGSP	Agropyron spicatum	bluebunch wheatgrass
CARU	Calamagrostis rubescens	PIPO	grami	CARU	Calamagrostis rubescens	pinegrass
CAGE2	Carex geyeri	PIPO	grami	CAGE	Carex geyeri	elk sedge

Annual Inventory 2004
VEGETATION PROFILE

PLANTS	PLANTS species	use	form	R6code	R6 old species	common_name
CARO5	Carex rossii	PIPO	grami	CARO	Carex rossii	ross' sedge
FEID	Festuca idahoensis	PIPO	grami	FEID	Festuca idahoensis	idaho fescue
POWH2	Poa wheeleri	PIPO	grami	PONEW	Poa nervosa wheeleri	wheeler's bluegrass
ARAR8	Artemisia arbuscula	PIPO	shrub	ARAR	Artemisia arbuscula	low sagebrush
ARTRV	Artemisia tridentata ssp. vaseyana	PIPO	shrub	ARTRV	Artemisia tridentata vaseyana	mountain big sagebrush
PERA4	Peraphyllum ramosissimum	PIPO	shrub	PERA3	Peraphyllum ramosissimum	squaw apple
PUTR2	Purshia tridentata	PIPO	shrub	PUTR	Purshia tridentata	bitterbrush
RHGL	Rhus glabra	PIPO	shrub	RHGL	Rhus glabra	smooth sumac
SPBE2	Spiraea betulifolia	PIPO	shrub	SPBE	Spiraea betulifolia	birchleaf spirea
SYAL	Symphoricarpos albus	PIPO	shrub	SYAL	Symphoricarpos albus	Common snowberry
SYOR2	Symphoricarpos oreophilus	PIPO	shrub	SYOR	Symphoricarpos oreophilus	mountain snowberry
CELE3	Cercocarpus ledifolius	PIPO	tree	CELE	Cercocarpus ledifolius	curlleaf mountain mahogany
PSSPS	Pseudoroegneria spicata ssp. spicata	JUOC	grami	AGSP	Agropyron spicatum	bluebunch wheatgrass
CAGE2	Carex geyeri	JUOC	grami	CAGE	Carex geyeri	elk sedge
FEID	Festuca idahoensis	JUOC	grami	FEID	Festuca idahoensis	idaho fescue
POWH2	Poa wheeleri	JUOC	grami	PONEW	Poa nervosa wheeleri	wheeler's bluegrass
POSE	Poa secunda	JUOC	grami	POSA	Poa sandbergii	Sandberg's Bluegrass
ARAR8	Artemisia arbuscula	JUOC	shrub	ARAR	Artemisia arbuscula	low sagebrush
ARRI2	Artemisia rigida	JUOC	shrub	ARRI	Artemisia rigida	stiff sagebrush
ARTRV	Artemisia tridentata ssp. vaseyana	JUOC	shrub	ARTRV	Artemisia tridentata vaseyana	mountain big sagebrush
PUTR2	Purshia tridentata	JUOC	shrub	PUTR	Purshia tridentata	bitterbrush
CELE3	Cercocarpus ledifolius	JUOC	tree	CELE	Cercocarpus ledifolius	curlleaf mountain mahogany
ACRE3	Acroptilon repens	weed	forb	ACRE3	Acroptilon repens	russian knapweed
CADR	Cardaria draba	weed	forb	CADR2	Cardaria draba	white top (hoary cress)
CANU4	Carduus nutans	weed	forb	CANU4	Carduus nutans	musk thistle
CEBI2	Centaurea biebersteinii	weed	forb	CEMA	Centaurea maculosa	spotted knapweed
CESO3	Centaurea solstitialis	weed	forb	CESO	Centaurea solstitialis	yellow starthistle
CEDI3	Centurea diffusa	weed	forb	CEDI	Centurea diffusa	diffuse knapweed
CHJU	Chondrilla juncea	weed	forb	CHJU	Chondrilla juncea	rush skeletonweed
CIDO	Cicuta douglasii	weed	forb	CIDO	Cicuta douglasii	water hemlock
CIAR4	Cirsium arvense	weed	forb	CIAR	Cirsium arvense	canada thistle
CIVU	Cirsium vulgare	weed	forb	CIVU	Cirsium vulgare	bull thistle
COMA2	Conium maculatum	weed	forb	COMA2	Conium maculatum	poison hemlock
CYOF	Cynoglossum officinale	weed	forb	CYOF	Cynoglossum officinale	hound's tongue
DIFU2	Dipsacus sylvestris	weed	forb	DISY	Dipsacus sylvestris	teasel
EUES	Euphorbia esula	weed	forb	EUES	Euphorbia esula	leafy spurge
HEPU5	Hemizonia pungens	weed	forb	HEPU2	Hemizonia pungens	spikeweed
HYNI	Hyoscyamus niger	weed	forb	HYNI	Hyoscyamus niger	black henbane
HYPE	Hypericum perforatum	weed	forb	HYPE	Hypericum perforatum	common st. john's wort
LELA2	Lepidium latifolium	weed	forb	LELA	Lepidium latifolium	perennial pepperweed
LIDA	Linaria dalmatica	weed	forb	LIDA	Linaria dalmatica	dalmation toadflax

Annual Inventory 2004
VEGETATION PROFILE

PLANTS	PLANTS species	use	form	R6code	R6 old species	common_name
LIVU2	<i>Linaria vulgaris</i>	weed	forb	LIVU	<i>Linaria vulgaris</i>	yellow toadflax
LYSA2	<i>Lythrum salicaria</i>	weed	forb	LYSA	<i>Lythrum salicaria</i>	purple loosestrife
ONAC	<i>Onopordum acanthium</i>	weed	forb	ONAC	<i>Onopordum acanthium</i>	scotch thistle
PORE5	<i>Potentilla recta</i>	weed	forb	PORE5	<i>Potentilla recta</i>	cinquefoil, sulfur
SAAE	<i>Salvia aethiopis</i>	weed	forb	SAAE2	<i>Salvia aethiopis</i>	mediterranean sage
SAOF4	<i>Saponaria officinallis</i>	weed	forb	SAOF2	<i>Saponaria officinallis</i>	bouncing bet, soapwort
SEJA	<i>Senecio jacobaea</i>	weed	forb	SEJA	<i>Senecio jacobaea</i>	tansy ragwort
TAVU	<i>Tanacetum vulgare</i>	weed	forb	TAVU	<i>Tanacetum vulgare</i>	common tansy
TRTE	<i>Tribulus terrestris</i>	weed	forb	TRTR	<i>Tribulus terrestris</i>	puncturevine
ZIVE	<i>Zigadenus venenosus</i>	weed	forb	ZIVE	<i>Zigadenus venenosus</i>	meadow deathcamus
THIN6	<i>Thinopyrum intermedium</i>	weed	grami	AGIN2	<i>Agropyron intermedium</i>	intermediate wheatgrass
THIN6	<i>Thinopyrum intermedium</i>	weed	grami	AGTR2	<i>Agropyron trichophorum</i>	pubescent wheatgrass
DAGL	<i>Dactylis glomerata</i>	weed	grami	DAGL	<i>Dactylis glomerata</i>	orchard grass
LOLIU	<i>Lolium spp</i>	weed	grami	LOLIU	<i>Lolium spp</i>	ryegrass
PHPR3	<i>Phleum pratense</i>	weed	grami	PHPR	<i>Phleum pratense</i>	timothy
TACA8	<i>Taeniatherum caput-medusae</i>	weed	grami	TACA	<i>Taeniatherum caput-medusae</i>	medusa head
CYSC4	<i>Cytisus scoparius</i>	weed	shrub	CYSC4	<i>Cytisus scoparius</i>	broom, Scotch
ASCA2	<i>Asarum caudatum</i>	nfor	forb	ASCA3	<i>Asarum caudatum</i>	wild ginger
ASCU5	<i>Astragalus cusickii</i>	nfor	forb	ASCU4	<i>Astragalus cusickii</i>	Cusick's Milkvetch
ASIN5	<i>Astragalus inflexus</i>	nfor	forb	ASIN2	<i>Astragalus inflexus</i>	Hairy Milkvetch
BAIN	<i>Balsamorhiza incana</i>	nfor	forb	BAIN	<i>Balsamorhiza incana</i>	Hoary Balmroot
BASA3	<i>Balsamorhiza sagittata</i>	nfor	forb	BASA	<i>Balsamorhiza sagittata</i>	Arrowleaf Balmroot
CACU2	<i>Camassia cusickii</i>	nfor	forb	CACU	<i>Camassia cusickii</i>	Cusick's Camas
ERCH4	<i>Erigeron chrysopsidis</i>	nfor	forb	ERCH	<i>Erigeron chrysopsidis</i>	Dwarf Yellow Fleabane
ERPU2	<i>Erigeron pumilus</i>	nfor	forb	ERPU	<i>Erigeron pumilus</i>	Shaggy Fleabane
ERDO	<i>Eriogonum douglasii</i>	nfor	forb	ERDO	<i>Eriogonum douglasii</i>	Douglas' Buckwheat
ERFL4	<i>Eriogonum flavum</i>	nfor	forb	ERFL	<i>Eriogonum flavum</i>	Golden Buckwheat
ERHE2	<i>Eriogonum heracleoides</i>	nfor	forb	ERHE	<i>Eriogonum heracleoides</i>	Creamy Or Wyeth's Buckwheat
ERMI4	<i>Eriogonum microthecum</i>	nfor	forb	ERMI	<i>Eriogonum microthecum</i>	Slender Buckwheat
ERST4	<i>Eriogonum strictum</i>	nfor	forb	ERST2	<i>Eriogonum strictum</i>	Strict Buckwheat
ERUMM	<i>Eriogonum umbellatum</i> var. <i>majus</i>	nfor	forb	ERUMS	<i>Eriogonum umbellatum</i> <i>subalpinum</i>	Sulfur Buckwheat
FRAL2	<i>Frasera albicaulis</i>	nfor	forb	FRAL2	<i>Frasera albicaulis</i>	White Stemmed Frasera
GETR	<i>Geum triflorum</i>	nfor	forb	GETR	<i>Geum triflorum</i>	Red Avens, Old Man's Whiskers
HICY	<i>Hieracium cynoglossoides</i>	nfor	forb	HIAL2	<i>Hieracium albertinum</i>	Western Hawkweed
LECOW	<i>Lewisia columbiana</i> var. <i>wallowaensis</i>	nfor	forb	LECOW	<i>Lewisia columbiana</i> <i>wallowaensis</i>	Wallowa Lewisia
LOCO4	<i>Lomatium cous</i>	nfor	forb	LOCO2	<i>Lomatium cous</i>	Cous Biscuit-Root
LOMA3	<i>Lomatium macrocarpum</i>	nfor	forb	LOMA	<i>Lomatium macrocarpum</i>	Large Fruited Lomatium
LUCA	<i>Lupinus caudatus</i>	nfor	forb	LUCA	<i>Lupinus caudatus</i>	Tailcup Lupine
LUARL5	<i>Lupinus argenteus</i> ssp. <i>argenteus</i> var. <i>laxiflorus</i>	nfor	forb	LULA2	<i>Lupinus laxiflorus</i>	Spurred Lupine

Annual Inventory 2004
VEGETATION PROFILE

PLANTS	PLANTS species	use	form	R6code	R6 old species	common_name
LUSE4	Lupinus sericeus	nfor	forb	LUSE	Lupinus sericeus	Silky lupine
OECA10	Oenothera caespitosa	nfor	forb	OECA2	Oenothera caespitosa	Desert Evening Primrose
OPPO	Opuntia polyacantha	nfor	forb	OPPO	Opuntia polyacantha	Plains Prickly Pear
PEEL4	Penstemon elegantulus	nfor	forb	PEEL	Penstemon elegantulus	Lovely Penstemon
PEGL5	Penstemon globosus	nfor	forb	PEGL4	Penstemon globosus	Globe Penstemon
PETR6	Penstemon triphyllus	nfor	forb	PETR	Penstemon triphyllus	Whorled Penstemon
DAOR2	Dalea ornata	nfor	forb	PEOR4	Petalostemon ornatus	Western Prairie-Clover
PHCO10	Phlox colubrina	nfor	forb	PHCO2	Phlox colubrina	Snake River Phlox
PHOR2	Physaria oregana	nfor	forb	PHOR	Physaria oregana	Oregon Twinpod
POPH	Polygonum phytolaccaefolium	nfor	forb	POPH	Polygonum phytolaccaefolium	pokeweed fleecflower
SCAN3	Scutellaria angustifolia	nfor	forb	SCAN	Scutellaria angustifolia	Narrowleaf Skullcap
SELA	Sedum lanceolatum	nfor	forb	SELA2	Sedum lanceolatum	Lanceleaved Stonecrop
TRMA3	Trifolium macrocephalum	nfor	forb	TRMA	Trifolium macrocephalum	Bighead Clover
PSSPS	Pseudoroegneria spicata ssp. spicata	nfor	grami	AGSP	Agropyron spicatum	bluebunch wheatgrass
ARPUL	Aristida purpurea longiseta	nfor	grami	ARLO3	Aristida longiseta	Fendler (Red) Threawn
BRCA5	Bromus carinatus	nfor	grami	BRCA	Bromus carinatus	California Brome
CAGE2	Carex geyeri	nfor	grami	CAGE	Carex geyeri	elk sedge
CAHO5	Carex hoodii	nfor	grami	CAHO	Carex hoodii	Hood's Sedge
CAPE7	Carex petasata	nfor	grami	CAPE	Carex petasata	Liddon's Sedge
DAIN	Danthonia intermedia	nfor	grami	DAIN	Danthonia intermedia	Timber Oatgrass
DAUN	Danthonia unispicata	nfor	grami	DAUN	Danthonia unispicata	One-Spike Oatgrass
LECI4	Leymus cinereus	nfor	grami	ELCI2	Elymus cinereus	Giant Wildrye
FEID	Festuca idahoensis	nfor	grami	FEID	Festuca idahoensis	idaho fescue
FEVI	Festuca viridula	nfor	grami	FEVI	Festuca viridula	green fescue
JUPA	Juncus parryi	nfor	grami	JUPA	Juncus parryi	Parry's rush
KOMA	Koeleria macrantha	nfor	grami	KOCR	Koeleria cristata	Prairie Junegrass
POWH2	Poa wheeleri	nfor	grami	PONEW	Poa nervosa wheeleri	wheeler's bluegrass
POPR	Poa pratensis	nfor	grami	POPR	Poa pratensis	Kentucky bluegrass
POSE	Poa secunda	nfor	grami	POSA	Poa sandbergii	Sandberg's Bluegrass
ELELE	Elymus elymoides ssp. elymoides	nfor	grami	SIHY	Sitanian hystrix	Bottlebrush Squirreltail
SPCR	Sporobolus cryptandrus	nfor	grami	SPCR	Sporobolus cryptandrus	Sand Dropseed
ACOCO	Achnatherum occidentale ssp. occidentale	nfor	grami	STOC	Stipa occidentalis	Western Needlegrass
ALVIS	Alnus viridis ssp. sinuata	nfor	shrub	ALSI	Alnus sinuata	sitka alder
AMAL2	Amelanchier alnifolia	nfor	shrub	AMAL	Amelanchier alnifolia	Saskatoon Serviceberry
ARAR8	Artemisia arbuscula	nfor	shrub	ARAR	Artemisia arbuscula	low sagebrush
ARRI2	Artemisia rigida	nfor	shrub	ARRI	Artemisia rigida	stiff sagebrush
ARTRV	Artemisia tridentata ssp. vaseyana	nfor	shrub	ARTRV	Artemisia tridentata vaseyana	mountain big sagebrush
CEVE	Ceanothus velutinus	nfor	shrub	CEVE	Ceanothus velutinus	Snowbrush Ceanothus
CELAR	Celtis laevigata var. reticulata	nfor	shrub	CERE2	Celtis reticulata	Nettleleaf Hackberry

Annual Inventory 2004
VEGETATION PROFILE

PLANTS	PLANTS species	use	form	R6code	R6 old species	common_name
GLSPA	Glossopetalon spinescens var. aridium	nfor	shrub	GLNE	Glossopetalon nevadense	Snake River Green-Bush
HODI	Holodiscus discolor	nfor	shrub	HODI	Holodiscus discolor	oceanspray
PERA4	Peraphyllum ramosissimum	nfor	shrub	PERA3	Peraphyllum ramosissimum	squaw apple
PHLE4	Philadelphus lewisii	nfor	shrub	PHLE4	Philadelphus lewisii	Lewis' Mock Orange
PHMA5	Physocarpus malvaceus	nfor	shrub	PHMA	Physocarpus malvaceus	ninebark
PRUNU	Prunus spp	nfor	shrub	PRUNUS	Prunus spp	Cherry Or Choke Cherry
PUTR2	Purshia tridentata	nfor	shrub	PUTR	Purshia tridentata	bitterbrush
RHGL	Rhus glabra	nfor	shrub	RHGL	Rhus glabra	smooth sumac
ROSA5	Rosa spp.	nfor	shrub	ROSA	Rosa spp.	Rose
SYAL	Symphoricarpos albus	nfor	shrub	SYAL	Symphoricarpos albus	Common snowberry
SYOR2	Symphoricarpos oreophilus	nfor	shrub	SYOR	Symphoricarpos oreophilus	mountain snowberry
ACGLD4	Acer glabrum var. Douglasii	nfor	tree	ACGLD	Acer glabrum var. Douglasii	Douglas maple
CELE3	Cercocarpus ledifolius	nfor	tree	CELE	Cercocarpus ledifolius	curlleaf mountain mahogany

5. NW Washington

This list is to be used on the Mt. Baker-Snoqualmie (605), Olympic (609) National Forests.

ID Guide: Leshner, Robin D., and Jan A. Henderson. 1992. Indicator Species of Forested Plant Associations on National Forests of Northwestern Washington. USDA Forest Service, Pacific Northwest Region R6-MBS-TP-041-1992.

PLANTS	PLANTS species	Use	form	R6code	R6 old species	common_name
ACTR	Achlys triphylla	Indi	forb	ACTR	Achlys triphylla	Vanilla Leaf
ATFI	Athyrium filix-femina	Indi	forb	ATFI	Athyrium filix-femina	common ladyfern
BLSP	Blechnum spicant	indi	forb	BLSP	Blechnum spicant	deer fern
CALEH2	Caltha leptosepala ssp. howellii	indi	forb	CABI	Caltha biflora	two-flowered marsh-marigold
CASC7	Campanula scouleri	indi	forb	CASC2	Campanula scouleri	Scouler's harebell
CIAL	Circaea alpina	indi	forb	CIAL	Circaea alpina	enchanter's nightshade
CLSI2	Claytonia sibirica	indi	forb	MOSI	Claytonia sibirica	miner's lettuce
CLUN2	Clintonia uniflora	indi	forb	CLUN	Clintonia uniflora	queen's cup beadiilly
COME4	Corallorhiza mertensiana	indi	forb	COME	Corallorhiza mertensiana	western coralroot
COCA13	Cornus canadensis	indi	forb	COCA	Cornus canadensis	bunchberry
DRCA11	Dryopteris carthusiana	indi	forb	DRAU2	Dryopteris campyloptera	shield-fern
ERMO8	Erythronium montanum	indi	forb	ERMO	Erythronium montanum	avalanche lily/giant faw
GATR3	Galium triflorum	indi	forb	GATR	Galium triflorum	Sweetscented bedstraw
GOOB2	Goodyera oblongifolia	indi	forb	GOOB	Goodyera oblongifolia	Western Rattlesnake-Plantain
GYDR	Gymnocarpium dryopteris	indi	forb	GYDR	Gymnocarpium dryopteris	oak fern
LIBO3	Linnaea borealis	indi	forb	LIBO2	Linnaea borealis	twinline
LULA4	Lupinus latifolius	indi	forb	LULA	Lupinus latifolius	Broadleaf lupine
LYAM3	Lysichiton americanus	indi	forb	LYAM	Lysichiton americanum	skunk cabbage

Annual Inventory 2004
VEGETATION PROFILE

PLANTS	PLANTS species	Use	form	R6code	R6 old species	common_name
MADI2	<i>Maianthemum dilatatum</i>	indi	forb	MADI2	<i>Maianthemum dilatatum</i>	false lily of the vally
MAST4	<i>Maianthemum stellatum</i>	indi	forb	SMST	<i>Smilacina stellata</i>	Starry Solomn'S Seal
MOMA3	<i>Moehringia macrophylla</i>	Indi	forb	ARMA3	<i>Arenaria macrophylla</i>	Bigleaf Sandwort
PYSEOR SE	<i>OrthiliaPyrola secunda</i>	indi	forb	PYSE	<i>Pyrola secunda</i>	Sidebells Pyrola
OXOR	<i>Oxalis oregana</i>	indi	forb	OXOR	<i>Oxalis oregana</i>	Oregon oxalis
POMU	<i>Polystichum munitum</i>	indi	forb	POMU	<i>Polystichum munitum</i>	western swordfern
STLAC	<i>Streptopus lanceolatus</i> var. <i>curvipes</i>	indi	forb	STRO	<i>Streptopus roseus</i>	Rosy twistedstalk
STST3	<i>Streptopus streptopoides</i>	indi	forb	STST	<i>Streptopus streptopoides</i>	kruhsea twisted-stalk
TITR	<i>Tiarella trifoliata</i>	indi	forb	TITR	<i>Tiarella trifoliata</i>	threeleaf foamflower
TITRU	<i>Tiarella trifoliata</i> var. <i>unifoliata</i>	indi	forb	TIUN	<i>Tiarella unifoliata</i>	Coolwort foamflower
TRBOL	<i>Trientalis borealis</i> ssp. <i>latifolia</i>	indi	forb	TRLA2	<i>Trientalis latifolia</i>	Western Starflower
VASI	<i>Valeriana sitchensis</i>	indi	forb	VASI	<i>Valeriana sitchensis</i>	sitka valerian
VAHE	<i>Vancouveria hexandra</i>	indi	forb	VAHE	<i>Vancouveria hexandra</i>	white inside-out-flower
XETE	<i>Xerophyllum tenax</i>	indi	forb	XETE	<i>Xerophyllum tenax</i>	Beargrass
FEOC	<i>Festuca occidentalis</i>	indi	grami	FEOC	<i>Festuca occidentalis</i>	Western Fescue
ACCI	<i>Acer circinatum</i>	indi	shrub	ACCI	<i>Acer circinatum</i>	Vine maple
ARUV	<i>Arctostaphylos uva-ursi</i>	indi	shrub	ARUV	<i>Arctostaphylos uva-ursi</i>	Bearberry, Kinnikinnick
CHME	<i>Chimaphila menziesii</i>	indi	shrub	CHME	<i>Chimaphila menziesii</i>	little prince's-pine
CHUM	<i>Chimaphila umbellata</i>	indi	shrub	CHUM	<i>Chimaphila umbellata</i>	Prince'S Pine
CLPY3	<i>Cladothamnus pyroliflorus</i>	indi	shrub	CLPY	<i>Cladothamnus pyrolaeiflorus</i>	copperbrush
FRPU7	<i>Frangula purshiana</i>	indi	shrub	RHPU	<i>Rhamnus purshiana</i>	casara
GASH	<i>Gaultheria shallon</i>	indi	shrub	GASH	<i>Gaultheria shallon</i>	salal
HODI	<i>Holodiscus discolor</i>	indi	shrub	HODI	<i>Holodiscus discolor</i>	oceanspray
JUCO6	<i>Juniperus communis</i>	indi	shrub	JUCO4	<i>Juniperus communis</i>	common juniper
LOHI2	<i>Lonicera hispidula</i>	indi	shrub	LOHI	<i>Lonicera hispidula</i>	hairy honeysuckle
MANE2	<i>Mahonia nervosa</i>	indi	shrub	BENE	<i>Berberis nervosa</i>	Oregon Grape
OPHO	<i>Oplopanax horridus</i>	indi	shrub	OPHO	<i>Oplopanax horridus</i>	devil's club
PAMY	<i>Paxistima myrsinites</i>	indi	shrub	PAMY	<i>Pachistima myrsinites</i>	Oregon Boxwood
PHEM	<i>Phyllodoce empetriformis</i>	indi	shrub	PHEM	<i>Phyllodoce empetriformis</i>	pink mountain-heath
RHAL2	<i>Rhododendron albiflorum</i>	indi	shrub	RHAL	<i>Rhododendron albiflorum</i>	cascades azalea
RHMA3	<i>Rhododendron macrophyllum</i>	indi	shrub	RHMA	<i>Rhododendron macrophyllum</i>	Pacific rhododendron
RIBR	<i>Ribes bracteosum</i>	indi	shrub	RIBR	<i>Ribes bracteosum</i>	stink currant
ROGY	<i>Rosa gymnocarpa</i>	indi	shrub	ROGY	<i>Rosa gymnocarpa</i>	Baldhip Rose
RULA2	<i>Rubus lasiococcus</i>	indi	shrub	RULA	<i>Rubus lasiococcus</i>	dwarf bramble
RUPE	<i>Rubus pedatus</i>	indi	shrub	RUPE	<i>Rubus pedatus</i>	Five-leaved bramble
RUSP	<i>Rubus spectabilis</i>	indi	shrub	RUSP	<i>Rubus spectabilis</i>	salmonberry
SARA2	<i>Sambucus racemosa</i>	indi	shrub	SARA	<i>Sambucus racemosa</i>	red elderberry
SOSI2	<i>Sorbus sitchensis</i>	indi	shrub	SOSI	<i>Sorbus sitchensis</i>	Sitka mountain-ash
SYAL	<i>Symphoricarpos albus</i>	indi	shrub	SYAL	<i>Symphoricarpos albus</i>	Common snowberry
VADE	<i>Vaccinium deliciosum</i>	indi	shrub	VADE	<i>Vaccinium deliciosum</i>	delicious blueberry

Annual Inventory 2004
VEGETATION PROFILE

PLANTS	PLANTS species	Use	form	R6code	R6 old species	common_name
VAME	<i>Vaccinium membranaceum</i>	indi	shrub	VAME	<i>Vaccinium membranaceum</i>	big huckleberry
VAOV	<i>Vaccinium ovalifolium</i>	indi	shrub	VAAL	<i>Vaccinium alaskense</i>	Alaska huckleberry
VAOV	<i>Vaccinium ovalifolium</i>	indi	shrub	VAOV	<i>Vaccinium ovalifolium</i>	oval-leaf huckleberry
VAOV2	<i>Vaccinium ovatum</i>	indi	shrub	VAOV2	<i>Vaccinium ovatum</i>	evergreen huckleberry
VAPA	<i>Vaccinium parvifolium</i>	indi	shrub	VAPA	<i>Vaccinium parvifolium</i>	red huckleberry
ANLA3	<i>Antennaria lanata</i>	nfor	forb	ANLA	<i>Antennaria lanata</i>	woolly pussytoes
CALEH2	<i>Caltha leptosepala</i> ssp. <i>howellii</i>	nfor	forb	CABI	<i>Caltha biflora</i>	two-flowered marsh-marigold
CAPA26	<i>Castilleja parviflora</i>	nfor	forb	CAPA3	<i>Castilleja parviflora</i>	mountain paintbrush
CARU9	<i>Castilleja rupicola</i>	nfor	forb	CARU4	<i>Castilleja rupicola</i>	cliff paintbrush
CHLA13	<i>Chamerion latifolium</i>	nfor	forb	EPLA	<i>Epilobium latifolium</i>	dwarf fireweed
DOJE	<i>Dodecatheon jeffreyi</i>	nfor	forb	DOJE	<i>Dodecatheon jeffreyi</i>	Sierra shootingstar
DOPU	<i>Dodecatheon pulchellum</i>	nfor	forb	DOPU2	<i>Dodecatheon pulchellum</i>	darkthroat shootingstar
EPAN4	<i>Epilobium anagallidifolium</i>	nfor	forb	EPAL	<i>Epilobium alpinum</i>	pimpernel willowherb
EQAR	<i>Equisetum arvense</i>	nfor	forb	EQAR	<i>Equisetum arvense</i>	Common horsetail
EQFL	<i>Equisetum fluviatile</i>	nfor	forb	EQFL	<i>Equisetum fluviatile</i>	water horsetail
EQHY	<i>Equisetum hyemale</i>	nfor	forb	EQHY	<i>Equisetum hyemale</i>	scouringbrush horsetail
ERPE3	<i>Erigeron peregrinus</i>	nfor	forb	ERPE	<i>Erigeron peregrinus</i>	subalpine fleabane
HEMA80	<i>Heracleum maximum</i>	nfor	forb	HELA	<i>Heracleum lanatum</i>	common cowparsnip
LEPY	<i>Leptarrhena pyrolifolia</i>	nfor	forb	LEPY2	<i>Leptarrhena pyrolifolia</i>	fireleaf leptarrhena
LOMA5	<i>Lomatium martindalei</i>	nfor	forb	LOMA2	<i>Lomatium martindalei</i>	Cascade desertparsley
LUPE	<i>Luetkea pectinata</i>	nfor	forb	LUPE	<i>Luetkea pectinata</i>	partridgefoot
LULA4	<i>Lupinus latifolius</i>	nfor	forb	LULA	<i>Lupinus latifolius</i>	Broadleaf lupine
METR3	<i>Menyanthes trifoliata</i>	nfor	forb	METR	<i>Menyanthes trifoliata</i>	buckbean
MILE2	<i>Mimulus lewisii</i>	nfor	forb	MILE	<i>Mimulus lewisii</i>	purple monkeyflower
NULUP	<i>Nuphar lutea</i> ssp. <i>polysepala</i>	nfor	forb	NUPO	<i>Nuphar polysepala</i>	Rocky Mountain pondlily
PEGR2	<i>Pedicularis groenlandica</i>	nfor	forb	PEGR	<i>Pedicularis groenlandica</i>	Elephanthead
PEDA2	<i>Penstemon davidsonii</i>	nfor	forb	PEDA	<i>Penstemon davidsonii</i>	Davidson's penstemon
PHDI3	<i>Phlox diffusa</i>	nfor	forb	PHDI	<i>Phlox diffusa</i>	spreading phlox
POBI6	<i>Polygonum bistortoides</i>	nfor	forb	POBI	<i>Polygonum bistortoides</i>	American bistort
POFL3	<i>Potentilla flabellifolia</i>	nfor	forb	POFL2	<i>Potentilla flabellifolia</i>	high mountain cinquefoil
RAES	<i>Ranunculus eschscholtzii</i>	nfor	forb	RAES	<i>Ranunculus eschscholtzii</i>	Eschsholtz's buttercup
SABR6	<i>Saxifraga bronchialis</i>	nfor	forb	SABR	<i>Saxifraga bronchialis</i>	yellowdot saxifrage
SATO2	<i>Saxifraga tolmiei</i>	nfor	forb	SATO	<i>Saxifraga tolmiei</i>	Tolmie's saxifrage
SIAC	<i>Silene acaulis</i>	nfor	forb	SIAC	<i>Silene acaulis</i>	moss campion
VASI	<i>Valeriana sitchensis</i>	nfor	forb	VASI	<i>Valeriana sitchensis</i>	sitka valerian
VEVI	<i>Veratrum viride</i>	nfor	forb	VEVI	<i>Veratrum viride</i>	American false hellebore
VIPA4	<i>Viola palustris</i>	nfor	forb	VIPA2	<i>Viola palustris</i>	marsh violet
XETE	<i>Xerophyllum tenax</i>	nfor	forb	XETE	<i>Xerophyllum tenax</i>	Beargrass
CACA4	<i>Calamagrostis canadensis</i>	nfor	grami	CACA	<i>Calamagrostis canadensis</i>	Bluejoint reedgrass
CAIN11	<i>Carex interior</i>	nfor	grami	CAIN5	<i>Carex interior</i>	inland sedge
CALE8	<i>Carex lenticularis</i>	nfor	grami	CALE5	<i>Carex lenticularis</i>	lakeshore sedge

Annual Inventory 2004
VEGETATION PROFILE

PLANTS	PLANTS species	Use	form	R6code	R6 old species	common_name
CANI2	Carex nigricans	nfor	grami	CANI2	Carex nigricans	Black alpine sedge
CASP5	Carex spectabilis	nfor	grami	CASP	Carex spectabilis	showy sedge
ERAN6	Eriophorum angustifolium	nfor	grami	ERPO2	Eriophorum polystachion	many-spiked cotton-grass
FEOV	Festuca ovina	nfor	grami	FEOV	Festuca ovina	sheep fescue
FEVI	Festuca viridula	nfor	grami	FEVI	Festuca viridula	green fescue
JUDR	Juncus drummondii	nfor	grami	JUDR	Juncus drummondii	drummond rush
JUPA	Juncus parryi	nfor	grami	JUPA	Juncus parryi	Parry's rush
LUPI2	Luzula piperi	nfor	grami	HEGL	Luzula piperi	Piper's woodrush
SCMI2	Scirpus microcarpus	nfor	grami	SCMI	Scirpus microcarpus	Small-fruit bulrush
SPAN2	Sparganium angustifolium	nfor	grami	SPAN	Sparganium angustifolium	narrowleaf burr-reed
ALVIS	Alnus viridis ssp. sinuata	nfor	shrub	ALSI	Alnus sinuata	sitka alder
ARUV	Arctostaphylos uva-ursi	nfor	shrub	ARUV	Arctostaphylos uva-ursi	Bearberry, Kinnikinnick
CAME7	Cassiope mertensiana	nfor	shrub	CAME	Cassiope mertensiana	western moss heather
CLPY3	Cladothamnus pyroliflorus	nfor	shrub	CLPY	Cladothamnus pyrolaeiflorus	copperbrush
COSES	Cornus sericia ssp. sericia	nfor	shrub	COST	Cornus stolonifera	Red-osier dogwood
DAFL3	Dasiphora floribunda	nfor	shrub	POFR	Potentilla fruticosa	shrubby cinquefoil
EMNI	Empetrum nigrum	nfor	shrub	EMNI	Empetrum nigrum	black crowberry
JUCO6	Juniperus communis	nfor	shrub	JUCO4	Juniperus communis	common juniper
KAMI	Kalmia microphylla	nfor	shrub	KAMI	Kalmia microphylla	alpine laurel
KAMI	Kalmia microphylla	nfor	shrub	KAOC	Kalmia occidentalis	alpine laurel
PHEM	Phyllodoce empetriformis	nfor	shrub	PHEM	Phyllodoce empetriformis	pink mountain-heath
PHGL6	Phyllodoce glanduliflora	nfor	shrub	PHGL	Phyllodoce glanduliflora	tellow mountain-heath
RIBR	Ribes bracteosum	nfor	shrub	RIBR	Ribes bracteosum	stink currant
RUSP	Rubus spectabilis	nfor	shrub	RUSP	Rubus spectabilis	salmonberry
SABA3	Salix barclayi	nfor	shrub	SABA3	Salix barclayi	Barclay's willow
SACA6	Salix cascadenis	nfor	shrub	SACA6	Salix cascadenis	Cascade willow
SACO2	Salix commutata	nfor	shrub	SACO2	Salix commutata	Undergreen willow
SANI8	Salix nivalis	nfor	shrub	SANI	Salix nivalis	snow willow
SASI2	Salix sitchensis	nfor	shrub	SASI2	Salix sitchensis	Sitka willow
SPDO	Spiraea douglasii	nfor	shrub	SPDO	Spiraea douglasii	Douglas spiraea
SPSPS	Spiraea splendens var. splendens	nfor	shrub	SPDE	Spiraea densiflora	rose meadowsweet
VADE	Vaccinium deliciosum	nfor	shrub	VADE	Vaccinium deliciosum	delicious blueberry
BOTRY	Botrychium spp.	sens	forb	BOSPP	Botrychium spp.	grageferns (Genus)
COAS	Coptis asplenifolia	sens	forb	COAS	Coptis asplenifolia	spleen-leaved goldthread
ERRE5	Erythronium revolutum	sens	forb	ERRE	Erythronium revolutum	pink fawn lily
GAKA	Galium kamtschaticum	sens	forb	GAKA	Galium kamtschaticum	boreal bedstraw
PLFI2	Pleuricospora fimbriolata	sens	forb	PLFI2	Pleuricospora fimbriolata	fringed pinesap
CEBI2	Centaurea biebersteinii	weed	forb	CEMA	Centaurea maculosa	spotted knapweed
CEDET	Centaurea debeauxii ssp. thuillieri	weed	forb	CENI3	Centaurea jacea x nigra	knapweed, meadow
CEJA	Centaurea jacea	weed	forb	CEJA	Centaurea jacea	brown knapweed

Annual Inventory 2004
VEGETATION PROFILE

PLANTS	PLANTS species	Use	form	R6code	R6 old species	common_name
CENI3	<i>Centaurea nigrescens</i>	weed	forb	CENI4	<i>Centaurea nigrescens</i>	vochin knapweed
CESO3	<i>Centaurea solstitialis</i>	weed	forb	CESO	<i>Centaurea solstitialis</i>	yellow starthistle
CEDI3	<i>Centurea diffusa</i>	weed	forb	CEDI	<i>Centurea diffusa</i>	diffuse knapweed
CHLE80	<i>Chrysanthemum leucanthemum</i>	weed	forb	CHLE2	<i>Chrysanthemum leucanthemum</i>	daisy, oxeve
CIAR4	<i>Cirsium arvense</i>	weed	forb	CIAR	<i>Cirsium arvense</i>	canada thistle
CIVU	<i>Cirsium vulgare</i>	weed	forb	CIVU	<i>Cirsium vulgare</i>	bull thistle
DACA6	<i>Daucus carota</i>	weed	forb	DACA4	<i>Daucus carota</i>	wild carrot
GERO	<i>Geranium robertianum</i>	weed	forb	GERO	<i>Geranium robertianum</i>	herb-Robert
HIAU	<i>Hieracium aurantiacum</i>	weed	forb	HIAU	<i>Hieracium aurantiacum</i>	hawkweed, orange
HICA10	<i>Hieracium caespitosum</i>	weed	forb	HICA	<i>Hieracium caespitosum</i>	yellow hawkweed
HYPE	<i>Hypericum perforatum</i>	weed	forb	HYPE	<i>Hypericum perforatum</i>	common st. john's wort
HYRA3	<i>Hypochaeris radicata</i>	weed	forb	HYRA	<i>Hypochaeris radicata</i>	catsear, spotted
LELA2	<i>Lepidium latifolium</i>	weed	forb	LELA	<i>Lepidium latifolium</i>	perennial pepperweed
LIDAD	<i>Linaria dalmatica</i> ssp. <i>dalmatica</i>	weed	forb	LIGED	<i>Linaria genistifolia</i> <i>dalmatian</i>	dalmatian toadflax
LIVU2	<i>Linaria vulgaris</i>	weed	forb	LIVU2	<i>Linaria vulgaris</i>	yellow toadflax
LYSA2	<i>Lythrum salicaria</i>	weed	forb	LYSA	<i>Lythrum salicaria</i>	purple loosestrife
POCU6	<i>Polygonum cuspidatum</i>	weed	forb	POCU2	<i>Polygonum cuspidatum</i>	Japanese knotweed
PORE5	<i>Potentilla recta</i>	weed	forb	PORE	<i>Potentilla recta</i>	cinquefoil, sulfur
SEJA	<i>Senecio jacobaea</i>	weed	forb	SEJA	<i>Senecio jacobaea</i>	tansy ragwort
SOAR2	<i>Sonchus arvensis</i>	weed	forb	SOAR	<i>Sonchus arvensis</i>	perennial sowthistle
TAVU	<i>Tanacetum vulgare</i>	weed	forb	TAVU	<i>Tanacetum vulgare</i>	common tansy
VETH	<i>Verbascum thapsus</i>	weed	forb	VETH	<i>Verbascum thapsus</i>	mullein, common
CYES3	<i>Cyperus esculentus</i>	weed	grami	CYES	<i>Cyperus esculentus</i>	yellow nutsedge
PHAR3	<i>Phalaris arundinacea</i>	weed	grami	PHAR	<i>Phalaris arundinacea</i>	reed canarygrass
CYSC4	<i>Cytisus scoparius</i>	weed	shrub	CYSC	<i>Cytisus scoparius</i>	broom, Scotch

6. SW Washington

This list is to be used on the Gifford Pinchot (603) National Forest.

ID Guide: Halverson, Nancy M. 1986. Major Indicator Shrubs and Herbs on National Forests of Western Oregon and Southwestern Washington. USDA Forest Service, Pacific Northwest Region R6-TM-229-1986.

PLANTS	PLANTS species	use	form	R6code	R6 old species	common_name
ACTR	<i>Achlys triphylla</i>	indi	forb	ACTR	<i>Achlys triphylla</i>	Vanilla Leaf
ADAL	<i>Adiantum aleuticum</i>	indi	forb	ADPE	<i>Adiantum pedatum</i>	maidenhair fern
ADBI	<i>Adenocaulon bicolor</i>	indi	forb	ADBI	<i>Adenocaulon bicolor</i>	trail plant
ANDE3	<i>Anemone deltoidea</i>	indi	forb	ANDE	<i>Anemone deltoidea</i>	threeleaf anemone
ARLA8	<i>Arnica latifolia</i>	indi	forb	ARLA	<i>Arnica latifolia</i>	Broadleaf Arnica
ASCA2	<i>Asarum caudatum</i>	indi	forb	ASCA3	<i>Asarum caudatum</i>	wild ginger
ATFI	<i>Athyrium filix-femina</i>	indi	forb	ATFI	<i>Athyrium filix-femina</i>	common ladyfern
BLSP	<i>Blechnum spicant</i>	indi	forb	BLSP	<i>Blechnum spicant</i>	deer fern
CLSI2	<i>Claytonia sibirica</i>	indi	forb	MOSI	<i>Claytonia sibirica</i>	miner's lettuce
CLUN2	<i>Clintonia uniflora</i>	indi	forb	CLUN	<i>Clintonia uniflora</i>	queen's cup beadlilly
COCA13	<i>Cornus canadensis</i>	indi	forb	COCA	<i>Cornus canadensis</i>	bunchberry
DIHO3	<i>Disporum hookeri</i>	indi	forb	DIHO	<i>Disporum hookeri</i>	Hooker fairybells
DRCA11	<i>Dryopteris carthusiana</i>	indi	forb	DRAU2	<i>Dryopteris campyloptera</i>	shield-fern
ERMO8	<i>Erythronium montanum</i>	indi	forb	ERMO	<i>Erythronium montanum</i>	avalanche lily/giant faw

Annual Inventory 2004
VEGETATION PROFILE

EULEL2	<i>Eucephalus ledophyllus</i> var. <i>ledophyllus</i>	indi	forb	ASLE2	<i>Aster ledophyllus</i>	Cascades aster
FRVE	<i>Fragaria vesca</i>	indi	forb	FRVE	<i>Fragaria vesca</i>	woodland strawberry
GATR3	<i>Galium triflorum</i>	indi	forb	GATR	<i>Galium triflorum</i>	Sweetscented bedstraw
GYDR	<i>Gymnocarpium dryopteris</i>	indi	forb	GYDR	<i>Gymnocarpium dryopteris</i>	oak fern
HIAL2	<i>Hieracium albiflorum</i>	indi	forb	HIAL	<i>Hieracium albiflorum</i>	White Hawkweed
IRTE	<i>Iris tenax</i> Dougl. ex Lindl	indi	forb	IRTE	<i>Iris tenax</i>	Oregon Iris
LAPO3	<i>Lathyrus polyphyllus</i>	indi	forb	LAPO	<i>Lathyrus polyphyllus</i>	leafy pea vine
LIBO3	<i>Linnaea borealis</i>	indi	forb	LIBO2	<i>Linnaea borealis</i>	twinflower
LULA4	<i>Lupinus latifolius</i>	indi	forb	LULA	<i>Lupinus latifolius</i>	Broadleaf lupine
LYAM3	<i>Lysichiton americanus</i>	indi	forb	LYAM	<i>Lysichiton americanum</i>	skunk cabbage
MADI2	<i>Maianthemum dilatatum</i>	indi	forb	MADI2	<i>Maianthemum dilatatum</i>	false lily of the vally
MARA7	<i>Maianthemum racemosum</i>	indi	forb	SMRA	<i>Smilacina racemosa</i>	False Solomn'S Seal
MAST4	<i>Maianthemum stellatum</i>	indi	forb	SMST	<i>Smilacina stellata</i>	Starry Solomn'S Seal
MIBR6	<i>Mitella breweri</i>	indi	forb	MIBR	<i>Mitella breweri</i>	Brewer's miterwort
MOMA3	<i>Moehringia macrophylla</i>	indi	forb	ARMA3	<i>Arenaria macrophylla</i>	Bigleaf Sandwort
OXOR	<i>Oxalis oregana</i>	indi	forb	OXOR	<i>Oxalis oregana</i>	Oregon oxalis
PODA	<i>Polygonum davisiae</i>	indi	forb	PONE4	<i>Polygonum newberryi</i>	Newberry's fleecflower
POMU	<i>Polystichum munitum</i>	indi	forb	POMU	<i>Polystichum munitum</i>	western swordfern
PTAQ	<i>Pteridium aquilinum</i>	indi	forb	PTAQ	<i>Pteridium aquilinum</i>	bracken fern
PYSE	<i>Pyrola secunda</i>	indi	forb	PYSE	<i>Pyrola secunda</i>	Sidebells Pyrola
SAME7	<i>Saxifraga mertensiana</i>	indi	forb	SAME3	<i>Saxifraga mertensiana</i>	Merten's saxifrage
STLAC	<i>Streptopus lanceolatus</i> var. <i>curvipes</i>	indi	forb	STRO	<i>Streptopus roseus</i>	Rosy twistedstalk
STME	<i>Stachys mexicana</i>	indi	forb	STME2	<i>Stachys mexicana</i>	Mexican hedgenettle
SYRE	<i>Synthyris reniformis</i>	indi	forb	SYRE	<i>Synthyris reniformis</i>	snowqueen
TITRU	<i>Tiarella trifoliata</i> var. <i>unifoliata</i>	indi	forb	TITRU	<i>Tiarella trifoliata unifoliata</i>	coolwort foamflower
TRBOL	<i>Trientalis borealis</i> ssp. <i>latifolia</i>	indi	forb	TRLA2	<i>Trientalis latifolia</i>	Western Starflower
TROV2	<i>Trillium ovatum</i>	indi	forb	TROV	<i>Trillium ovatum</i>	White trillium
VAHE	<i>Vancouveria hexandra</i>	indi	forb	VAHE	<i>Vancouveria hexandra</i>	white inside-out-flower
VASI	<i>Valeriana sitchensis</i>	indi	forb	VASI	<i>Valeriana sitchensis</i>	sitka valerian
VIGL	<i>Viola glabella</i>	indi	forb	VIGL	<i>Viola glabella</i>	stream violet
XETE	<i>Xerophyllum tenax</i>	indi	forb	XETE	<i>Xerophyllum tenax</i>	Beargrass
CAGE2	<i>Carex geyeri</i>	indi	grami	CAGE	<i>Carex geyeri</i>	elk sedge
CARU	<i>Calamagrostis rubescens</i>	indi	grami	CARU	<i>Calamagrostis rubescens</i>	pinegrass
FEID	<i>Festuca idahoensis</i>	indi	grami	FEID	<i>Festuca idahoensis</i>	idaho fescue
FEOC	<i>Festuca occidentalis</i>	indi	grami	FEOC	<i>Festuca occidentalis</i>	Western Fescue
FEVI	<i>Festuca viridula</i>	indi	grami	FEVI	<i>Festuca viridula</i>	green fescue
LUHI4	<i>Luzula hitchcocki</i>	indi	grami	LUHI	<i>Luzula hitchcocki</i>	Smooth Woodrush
ACCI	<i>Acer circinatum</i>	indi	shrub	ACCI	<i>Acer circinatum</i>	Vine maple
AMAL2	<i>Amelanchier alnifolia</i>	indi	shrub	AMAL	<i>Amelanchier alnifolia</i>	Saskatoon Serviceberry
ARNE	<i>Arctostaphylos nevadensis</i>	indi	shrub	ARNE	<i>Arctostaphylos nevadensis</i>	pinemat manzanita
ARUV	<i>Arctostaphylos uva-ursi</i>	indi	shrub	ARUV	<i>Arctostaphylos uva-ursi</i>	Bearberry, Kinnikinnick
CHUM	<i>Chimaphila umbellate</i>	indi	shrub	CHUM	<i>Chimaphila umbellate</i>	Prince'S Pine
COCO6	<i>Corylus cornuta</i>	indi	shrub	COCO2	<i>Corylus cornuta</i>	California Hazel
GASH	<i>Gaultheria shallon</i>	indi	shrub	GASH	<i>Gaultheria shallon</i>	salal

Annual Inventory 2004
VEGETATION PROFILE

HODI	Holodiscus discolor	indi	shrub	HODI	Holodiscus discolor	oceanspray
JUCO6	Juniperus communis	indi	shrub	JUCO4	Juniperus communis	common juniper
LOHI2	Lonicera hispidula	indi	shrub	LOHI	Lonicera hispidula	hairy honeysuckle
MAAQ2	Mahonia aquifolium	indi	shrub	BEAQ	Berberis aquifolium	Tall Oregon Grape
MANE2	Mahonia nervosa	indi	shrub	BENE	Berberis nervosa	Oregon Grape
MEFE	Menziesia ferruginea	indi	shrub	MEFE	Menziesia ferruginea	fool's huckleberry
OPHO	Oplopanax horridus	indi	shrub	OPHO	Oplopanax horridus	devil's club
PAMY	Paxistima myrsinites	indi	shrub	PAMY	Pachistima myrsinites	Oregon Boxwood
PHEM	Phyllodoce empetrifomis	indi	shrub	PHEM	Phyllodoce empetrifomis	pink mountain-heath
RHAL2	Rhododendron albiflorum	indi	shrub	RHAL	Rhododendron albiflorum	cascades azalea
RHMA3	Rhododendron macrophyllum	indi	shrub	RHMA	Rhododendron macrophyllum	Pacific rhododendron
ROGY	Rosa gymnocarpa	indi	shrub	ROGY	Rosa gymnocarpa	Baldhip Rose
RULA2	Rubus lasiococcus	indi	shrub	RULA	Rubus lasiococcus	dwarf bramble
RUPA	Rubus parviflorus	indi	shrub	RUPA	Rubus parviflorus	Thimbleberry
RUPE	Rubus pedatus	indi	shrub	RUPE	Rubus pedatus	Five-leaved bramble
RUSP	Rubus spectabilis	indi	shrub	RUSP	Rubus spectabilis	salmonberry
RUUR	Rubus ursinus	indi	shrub	RUUR	Rubus ursinus	Pacific blackberry
SYHE	Symphoricarpos hesperius	indi	shrub	SYMO	Symphoricarpos mollis	Trailing Snowberry
VADE	Vaccinium deliciosum	indi	shrub	VADE	Vaccinium deliciosum	delicious blueberry
VAME	Vaccinium membranaceum	indi	shrub	VAME	Vaccinium membranaceum	big huckleberry
VAOV	Vaccinium ovalifolium	indi	shrub	VAAL	Vaccinium alaskense	Alaska huckleberry
VAOV	Vaccinium ovalifolium	indi	shrub	VAOV	Vaccinium ovalifolium	oval-leaf huckleberry
VAOV2	Vaccinium ovatum	indi	shrub	VAOV2	Vaccinium ovatum	evergreen huckleberry
VAPA	Vaccinium parvifolium	indi	shrub	VAPA	Vaccinium parvifolium	red huckleberry
VASC	Vaccinium scoparium	indi	shrub	VASC	Vaccinium scoparium	grouse huckleberry
WHMO	Whipplea modesta	indi	shrub	WHMO	Whipplea modesta	whipplevine
CEBI2	Centaurea biebersteinii	weed	forb	CEMA	Centaurea maculosa	spotted knapweed
CEDET	Centaurea debeauxii ssp. thuillieri	weed	forb	CENI3	Centaurea jacea x nigra	knapweed, meadow
CEDI3	Centurea diffusa	weed	forb	CEDI	Centurea diffusa	diffuse knapweed
CEJA	Centaurea jacea	weed	forb	CEJA	Centaurea jacea	brown knapweed
CENI3	Centaurea nigrescens	weed	forb	CENI4	Centaurea nigrescens	vochin knapweed
CESO3	Centaurea solstitialis	weed	forb	CESO	Centaurea solstitialis	yellow starthistle
CHLE80	Chrysanthemum leucanthemum	weed	forb	CHLE2	Chrysanthemum leucanthemum	daisy, oxeye
CIAR4	Cirsium arvense	weed	forb	CIAR	Cirsium arvense	canada thistle
CIVU	Cirsium vulgare	weed	forb	CIVU	Cirsium vulgare	bull thistle
DACA6	Daucus carota	weed	forb	DACA4	Daucus carota	wild carrot
GERO	Geranium robertianum	weed	forb	GERO	Geranium robertianum	herb-Robert
HIAU	Hieracium aurantiacum	weed	forb	HIAU	Hieracium aurantiacum	hawkweed, orange
HICA10	Hieracium caespitosum	weed	forb	HICA	Hieracium caespitosum	yellow hawkweed
HYPE	Hypericum perforatum	weed	forb	HYPE	Hypericum perforatum	common st. john's wort
HYRA3	Hypochaeris radicata	weed	forb	HYRA	Hypochaeris radicata	catsear, spotted
LELA2	Lepidium latifolium	weed	forb	LELA	Lepidium latifolium	perennial pepperweed
LIDAD	Linaria dalmatica ssp. dalmatica	weed	forb	LIGED	Linaria genistifolia dalmatian	dalmatian toadflax
LIVU2	Linaria vulgaris	weed	forb	LIVU2	Linaria vulgaris	yellow toadflax
LYSA2	Lythrum salicaria	weed	forb	LYSA	Lythrum salicaria	purple loosestrife

Annual Inventory 2004
VEGETATION PROFILE

POCU6	<i>Polygonum cuspidatum</i>	weed	forb	POCU2	<i>Polygonum cuspidatum</i>	Japanese knotweed
PORE5	<i>Potentilla recta</i>	weed	forb	PORE	<i>Potentilla recta</i>	cinquefoil, sulfur
SEJA	<i>Senecio jacobaea</i>	weed	forb	SEJA	<i>Senecio jacobaea</i>	tansy ragwort
SOAR2	<i>Sonchus arvensis</i>	weed	forb	SOAR	<i>Sonchus arvensis</i>	perennial sowthistle
TAVU	<i>Tanacetum vulgare</i>	weed	forb	TAVU	<i>Tanacetum vulgare</i>	common tansy
VETH	<i>Verbascum thapsus</i>	weed	forb	VETH	<i>Verbascum thapsus</i>	mullein, common
CYES3	<i>Cyperus esculentus</i>	weed	grami	CYES	<i>Cyperus esculentus</i>	yellow nutsedge
PHAR3	<i>Phalaris arundinacea</i>	weed	grami	PHAR	<i>Phalaris arundinacea</i>	reed canarygrass
CYSC4	<i>Cytisus scoparius</i>	weed	shrub	CYSC	<i>Cytisus scoparius</i>	broom, Scotch

7. NE Washington

This list is to be used on the Colville (621), Okanogan (608), Wenatchee (617) National Forests.

ID Guide: Williams, Clinton K., and Terry R. Lillybridge. 1987. Major Indicator Shrubs and Herbs on National Forests of Eastern Washington, USDA Forest Service, Pacific Northwest Region R6-TM-TP-304-87

PLANTS	PLANTS species	use	form	R6code	R6 old species	common_name
ACMI2	<i>Achillea millefolium</i>	indi	forb	ACMI	<i>Achillea millefolium</i>	Western Yarrow
ACTR	<i>Achlys triphylla</i>	indi	forb	ACTR	<i>Achlys triphylla</i>	Vanilla Leaf
ACRU2	<i>Actaea rubra</i>	indi	forb	ACRU	<i>Actaea rubra</i>	baneberry
ADBI	<i>Adenocaulon bicolor</i>	indi	forb	ADBI	<i>Adenocaulon bicolor</i>	trail plant
ARNU2	<i>Aralia nudicaulis</i>	indi	forb	ARNU3	<i>Aralia nudicaulis</i>	Wild sarsparilla
MOMA3	<i>Moehringia macrophylla</i>	indi	forb	ARMA3	<i>Arenaria macrophylla</i>	Bigleaf Sandwort
ARCO9	<i>Arnica cordifolia</i>	indi	forb	ARCO	<i>Arnica cordifolia</i>	heart-leaf arnica
ARLA8	<i>Arnica latifolia</i>	indi	forb	ARLA	<i>Arnica latifolia</i>	Broadleaf Arnica
ASCA2	<i>Asarum caudatum</i>	indi	forb	ASCA3	<i>Asarum caudatum</i>	wild ginger
ASDE6	<i>Aspidotis densa</i>	indi	forb	ASDE	<i>Aspidotis densa</i>	rock fern
ATFI	<i>Athyrium filix-femina</i>	indi	forb	ATFI	<i>Athyrium filix-femina</i>	common ladyfern
BASA3	<i>Balsamorhiza sagittata</i>	indi	forb	BASA	<i>Balsamorhiza sagittata</i>	Arrowleaf Balsamroot
CLUN2	<i>Clintonia uniflora</i>	indi	forb	CLUN	<i>Clintonia uniflora</i>	queen's cup beadlilly
COCA13	<i>Cornus canadensis</i>	indi	forb	COCA	<i>Cornus canadensis</i>	bunchberry
DIHO3	<i>Disporum hookeri</i>	indi	forb	DIHO	<i>Disporum hookeri</i>	Hooker fairybells
DITR2	<i>Disporum trachycarpum</i>	indi	forb	DITR	<i>Disporum trachycarpum</i>	fairy bells
EQAR	<i>Equisetum arvense</i>	indi	forb	EQAR	<i>Equisetum arvense</i>	Common horsetail
GATR3	<i>Galium triflorum</i>	indi	forb	GATR	<i>Galium triflorum</i>	Sweetscented bedstraw
GYDR	<i>Gymnocarpium dryopteris</i>	indi	forb	GYDR	<i>Gymnocarpium dryopteris</i>	oak fern
HIAL2	<i>Hieracium albiflorum</i>	indi	forb	HIAL	<i>Hieracium albiflorum</i>	White Hawkweed
LAPA5	<i>Lathyrus pauciflorus</i>	indi	forb	LAPA3	<i>Lathyrus pauciflorus</i>	Few-flowered peavine
LIBOL2	<i>Linnaea borealis</i> ssp. <i>longiflora</i>	indi	forb	LIBOL	<i>Linnaea borealis longiflora</i>	western twinflower
CANA5	<i>Cacaliopsis nardosima</i>	indi	forb	LUNA2	<i>Luina nardosima</i>	silvercrown
LULA4	<i>Lupinus latifolius</i>	indi	forb	LULA	<i>Lupinus latifolius</i>	Broadleaf lupine
LUSE4	<i>Lupinus sericeus</i>	indi	forb	LUSE	<i>Lupinus sericeus</i>	Silky lupine
OSBE	<i>Osmorhiza berteroi</i>	indi	forb	OSCH	<i>Osmorhiza chilensis</i>	Sweet Cicely
PEBR	<i>Pedicularis bracteosa</i>	indi	forb	PEBR	<i>Pedicularis bracteosa</i>	Bracted pedicularis
PERA	<i>Pedicularis racemosa</i>	indi	forb	PERA	<i>Pedicularis racemosa</i>	Sickle-top pedicularis
POMU	<i>Polystichum munitum</i>	indi	forb	POMU	<i>Polystichum munitum</i>	western swordfern
PTAQ	<i>Pteridium aquilinum</i>	indi	forb	PTAQ	<i>Pteridium aquilinum</i>	bracken fern
PYAS	<i>Pyrola asarifolia</i>	indi	forb	PYAS	<i>Pyrola asarifolia</i>	alpine pyrola
ORSE	<i>Orthilia secunda</i>	indi	forb	PYSE	<i>Pyrola secunda</i>	Sidebells Pyrola

Annual Inventory 2004
VEGETATION PROFILE

PLANTS	PLANTS species	use	form	R6code	R6 old species	common_name
SETR	Senecio triangularis	indi	forb	SETR	Senecio triangularis	arrowleaf groundsel
MARA7	Maianthemum racemosum	indi	forb	SMRA	Smilacina racemosa	False Solomn'S Seal
MAST4	Maianthemum stellatum	indi	forb	SMST	Smilacina stellata	Starry Solomn'S Seal
STAM2	Streptopus amplexifolius	indi	forb	STAM	Streptopus amplexifolius	twisted stalk
STLAC	Streptopus lanceolatus var. curvipes	indi	forb	STRO	Streptopus roseus	Rosy twistedstalk
THOC	Thalictrum occidentale	indi	forb	THOC	Thalictrum occidentale	Western Meadowrue
TITRU	Tiarella trifoliata var. unifoliata	indi	forb	TIUN	Tiarella unifoliata	Coolwort foamflower
TRCA	Trautvetteria caroliniensis	indi	forb	TRCA3	Trautvetteria caroliniensis	false bugbane
TRBOL	Trientalis borealis ssp. latifolia	indi	forb	TRLA2	Trientalis latifolia	Western Starflower
TROV2	Trillium ovatum	indi	forb	TROV	Trillium ovatum	White trillium
VASI	Valeriana sitchensis	indi	forb	VASI	Valeriana sitchensis	sitka valerian
VEVI	Veratrum viride	indi	forb	VEVI	Veratrum viride	American false hellebore
VIGL	Viola glabella	indi	forb	VIGL	Viola glabella	stream violet
VIOR	Viola orbiculata	indi	forb	VIOR2	Viola orbiculata	round-leaved violet
VIPU4	Viola purpurea	indi	forb	VIPU	Viola purpurea	Goosefoot violet
XETE	Xerophyllum tenax	indi	forb	XETE	Xerophyllum tenax	Beargrass
PSSPS	Pseudoroegneria spicata ssp. spicata	indi	grami	AGSP	Agropyron spicatum	bluebunch wheatgrass
CARU	Calamagrostis rubescens	indi	grami	CARU	Calamagrostis rubescens	pinegrass
CACO11	Carex concinnoides	indi	grami	CACO	Carex concinnoides	Northwestern Sedge
CAGE2	Carex geyeri	indi	grami	CAGE	Carex geyeri	elk sedge
CARO5	Carex rossii	indi	grami	CARO	Carex rossii	ross' sedge
FEID	Festuca idahoensis	indi	grami	FEID	Festuca idahoensis	idaho fescue
FEOC	Festuca occidentalis	indi	grami	FEOC	Festuca occidentalis	Western Fescue
LUHI4	Luzula hitchcocki	indi	grami	LUHI	Luzula hitchcocki	Smooth Woodrush
ACCI	Acer circinatum	indi	shrub	ACCI	Acer circinatum	Vine maple
ACGLD4	Acer glabrum var. Douglasii	indi	tree	ACGLD	Acer glabrum var. Douglasii	Douglas maple
ALVIS	Alnus viridis ssp. sinuata	indi	shrub	ALSI	Alnus sinuate	sitka alder
AMAL2	Amelanchier alnifolia	indi	shrub	AMAL	Amelanchier alnifolia	Saskatoon Serviceberry
ARNE	Arctostaphylos nevadensis	indi	shrub	ARNE	Arctostaphylos nevadensis	pinemat manzanita
ARUV	Arctostaphylos uva-ursi	indi	shrub	ARUV	Arctostaphylos uva-ursi	Bearberry, Kinnikinnick
ARTRV	Artemisia tridentata ssp. vaseyana	indi	shrub	ARTRV	Artemisia tridentata vaseyana	mountain big sagebrush
MAAQ2	Mahonia aquifolium	indi	shrub	BEAQ	Berberis aquifolium	Tall Oregon Grape
MANE2	Mahonia nervosa	indi	shrub	BENE	Berberis nervosa	Oregon Grape
CESA	Ceanothus sanguineus	indi	shrub	CESA	Ceanothus sanguineus	Redstem ceanothus
CEVE	Ceanothus velutinus	indi	shrub	CEVE	Ceanothus velutinus	Snowbrush Ceanothus
CHUMO	Chimaphila umbellata ssp. occidentalis	indi	shrub	CHUMO	Chimaphila umbellata var. occidentalis	Western prince's pine
COSES	Cornus sericia ssp. sericia	indi	shrub	COST	Cornus stolonifera	Red-osier dogwood
GAOV2	Gaultheria ovatifolia	indi	shrub	GAOV	Gaultheria ovatifolia	slender salal
HODI	Holodiscus discolor	indi	shrub	HODI	Holodiscus discolor	oceanspray
LEGL	Ledum glandulosum	indi	shrub	LEGL	Ledum glandulosum	Western ledum
LOUT2	Lonicera utahensis	indi	shrub	LOUT2	Lonicera utahensis	Utah honeysuckle

Annual Inventory 2004
VEGETATION PROFILE

PLANTS	PLANTS species	use	form	R6code	R6 old species	common_name
MEFE	<i>Menziesia ferruginea</i>	indi	shrub	MEFE	<i>Menziesia ferruginea</i>	fool's huckleberry
OPHO	<i>Oplopanax horridus</i>	indi	shrub	OPHO	<i>Oplopanax horridus</i>	devil's club
PAMY	<i>Paxistima myrsinites</i>	indi	shrub	PAMY	<i>Pachistima myrsinites</i>	Oregon Boxwood
PHEM	<i>Phyllodoce empetrifomis</i>	indi	shrub	PHEM	<i>Phyllodoce empetrifomis</i>	pink mountain-heath
PHMA5	<i>Physocarpus malvaceus</i>	indi	shrub	PHMA	<i>Physocarpus malvaceus</i>	ninebark
PUTR2	<i>Purshia tridentata</i>	indi	shrub	PUTR	<i>Purshia tridentata</i>	bitterbrush
RHAL2	<i>Rhododendron albiflorum</i>	indi	shrub	RHAL	<i>Rhododendron albiflorum</i>	cascades azalea
RICE	<i>Ribes cereum</i>	indi	shrub	RICE	<i>Ribes cereum</i>	Squaw Current
RILA	<i>Ribes lacustre</i>	indi	shrub	RILA	<i>Ribes lacustre</i>	Prickly currant
RIV13	<i>Ribes viscosissimum</i>	indi	shrub	RIVI	<i>Ribes viscosissimum</i>	Sticky Currant
ROGY	<i>Rosa gymnocarpa</i>	indi	shrub	ROGY	<i>Rosa gymnocarpa</i>	Baldhip Rose
ROSA5	<i>Rosa</i> spp.	indi	shrub	ROSA	<i>Rosa</i> spp.	Rose
RULA2	<i>Rubus lasiococcus</i>	indi	shrub	RULA	<i>Rubus lasiococcus</i>	dwarf bramble
RUPA	<i>Rubus parviflorus</i>	indi	shrub	RUPA	<i>Rubus parviflorus</i>	Thimbleberry
RUPE	<i>Rubus pedatus</i>	indi	shrub	RUPE	<i>Rubus pedatus</i>	Five-leaved bramble
SASC	<i>Salix scouleriana</i>	indi	shrub	SASC	<i>Salix scouleriana</i>	Scouler's Willow
SHCA	<i>Shepherdia canadensis</i>	indi	shrub	SHCA	<i>Shepherdia canadensis</i>	Russet buffaloberry
SOSC2	<i>Sorbus scopulina</i>	indi	shrub	SOSC2	<i>Sorbus scopulina</i>	Mountain ash
SPBEL	<i>Spiraea betulifolia</i> var. <i>lucida</i>	indi	shrub	SPBEL	<i>Spiraea betulifolia</i> var. <i>lucida</i>	Shiny-leaf spirea
SYAL	<i>Symphoricarpos albus</i>	indi	shrub	SYAL	<i>Symphoricarpos albus</i>	Common snowberry
SYHE	<i>Symphoricarpos hesperius</i>	indi	shrub	SYMOH	<i>Symphoricarpos mollis</i> var. <i>hesperius</i>	Creeping snowberry
SYOR2	<i>Symphoricarpos oreophilus</i>	indi	shrub	SYOR	<i>Symphoricarpos oreophilus</i>	mountain snowberry
VAOV	<i>Vaccinium ovalifolium</i>	indi	shrub	VAAL	<i>Vaccinium alaskense</i>	Alaska huckleberry
VACA13	<i>Vaccinium caespitosum</i>	indi	shrub	VACA	<i>Vaccinium caespitosum</i>	Dwarf Huckleberry
VADE	<i>Vaccinium deliciosum</i>	indi	shrub	VADE	<i>Vaccinium deliciosum</i>	delicious blueberry
VAME	<i>Vaccinium membranaceum</i>	indi	shrub	VAME	<i>Vaccinium membranaceum</i>	big huckleberry
VAMY2	<i>Vaccinium myrtillus</i>	indi	shrub	VAMY	<i>Vaccinium myrtillus</i>	Low huckleberry
VAOV	<i>Vaccinium ovalifolium</i>	indi	shrub	VAOV	<i>Vaccinium ovalifolium</i>	oval-leaf huckleberry
VAPA	<i>Vaccinium parvifolium</i>	indi	shrub	VAPA	<i>Vaccinium parvifolium</i>	red huckleberry
VASC	<i>Vaccinium scoparium</i>	indi	shrub	VASC	<i>Vaccinium scoparium</i>	grouse huckleberry
TABR2	<i>Taxus brevifolia</i>	indi	tree	TABR	<i>Taxus brevifolia</i>	western yew
ANAR16	<i>Anchusa arvensis</i>	weed	forb	ANOF	<i>Anchusa arvensis</i>	bugloss, annual
CADR	<i>Cardaria draba</i>	weed	forb	CADR	<i>Cardaria draba</i>	white top (hoary cress)
CAAC	<i>Carduus acanthoides</i>	weed	forb	CAAC	<i>Carduus acanthoides</i>	thistle, plumeless
CANU4	<i>Carduus nutans</i>	weed	forb	CANU5	<i>Carduus nutans</i>	musk thistle
CECA2	<i>Centaurea calcitrapa</i>	weed	forb	CECA	<i>Centaurea calcitrapa</i>	starthistle, purple
CEDET	<i>Centaurea debeauxii</i> ssp. <i>thuillieri</i>	weed	forb	CENIJ	<i>Centaurea jacea</i> x <i>nigra</i>	knapweed, meadow
CEBI2	<i>Centaurea bieberstinii</i>	weed	forb	CEMA	<i>Centaurea maculosa</i>	spotted knapweed
ACRE3	<i>Acroptilon repens</i>	weed	forb	CERE	<i>Centaurea repens</i>	Russian Knapweed
CESO3	<i>Centaurea solstitialis</i>	weed	forb	CESO	<i>Centaurea solstitialis</i>	yellow starthistle
CEDI3	<i>Centurea diffusa</i>	weed	forb	CEDI	<i>Centurea diffusa</i>	diffuse knapweed
CHJU	<i>Chondrilla juncea</i>	weed	forb	CHJU	<i>Chondrilla juncea</i>	rush skeletonweed
CHLE80	<i>Chrysanthemum leucanthemum</i>	weed	forb	CHLE2	<i>Chrysanthemum leucanthemum</i>	daisy, oxeye

Annual Inventory 2004
VEGETATION PROFILE

PLANTS	PLANTS species	use	form	R6code	R6 old species	common_name
CIAR4	<i>Cirsium arvense</i>	weed	forb	CIAR	<i>Cirsium arvense</i>	canada thistle
CIVU	<i>Cirsium vulgare</i>	weed	forb	CIVU	<i>Cirsium vulgare</i>	bull thistle
CRVU2	<i>Crupina vulgaris</i>	weed	forb	CRVU	<i>Crupina vulgaris</i>	crupina, common
CYOF	<i>Cynoglossum officinale</i>	weed	forb	CYOF	<i>Cynoglossum officinale</i>	hound's tongue
ECVU	<i>Echium vulgare</i>	weed	forb	ECVU	<i>Echium vulgare</i>	blueweed
EUES	<i>Euphorbia esula</i>	weed	forb	EUES	<i>Euphorbia esula</i>	leafy spurge
HIAU	<i>Hieracium aurantiacum</i>	weed	forb	HIAU	<i>Hieracium aurantiacum</i>	hawkweed, orange
HIPR	<i>Hieracium pratense</i>	weed	forb	HIPR	<i>Hieracium pratense</i>	hawkweed, yellow
HYPE	<i>Hypericum perforatum</i>	weed	forb	HYPE	<i>Hypericum perforatum</i>	common st. john's wort
HYRA3	<i>Hypochaeris radicata</i>	weed	forb	HYRA	<i>Hypochaeris radicata</i>	catsear, spotted
ISTI	<i>Isatis tinctoria</i>	weed	forb	ISTI	<i>Isatis tinctoria</i>	Dyers Woad
LELA2	<i>Lepidium latifolium</i>	weed	forb	LELA	<i>Lepidium latifolium</i>	perennial pepperweed
LIDAD	<i>Linaria dalmatica</i> ssp. <i>dalmatica</i>	weed	forb	LIGEN	<i>Linaria genistifolia</i> <i>dalmatiana</i>	dalmatian toadflax
LIVU2	<i>Linaria vulgaris</i>	weed	forb	LIVU	<i>Linaria vulgaris</i>	yellow toadflax
LYSA2	<i>Lythrum salicaria</i>	weed	forb	LYSA	<i>Lythrum salicaria</i>	purple loosestrife
MINY	<i>Mirabilis nyctaginea</i>	weed	forb	MINY	<i>Mirabilis nyctaginea</i>	four o'clock, wild
MYSP2	<i>Myriophyllum spicatum</i>	weed	forb	MYSP2	<i>Myriophyllum spicatum</i>	Eurasian water-milfoil
ONAC	<i>Onopordum acanthium</i>	weed	forb	ONAC	<i>Onopordum acanthium</i>	scotch thistle
PORE5	<i>Potentilla recta</i>	weed	forb	PORE	<i>Potentilla recta</i>	cinquefoil, sulfur
SAPR2	<i>Salvia pratensis</i>	weed	forb	SAPR	<i>Salvia pratensis</i>	Meadow clary (sage)
SEJA	<i>Senecio jacobaea</i>	weed	forb	SEJA	<i>Senecio jacobaea</i>	tansy ragwort
TAVU	<i>Tanacetum vulgare</i>	weed	forb	TAVU	<i>Tanacetum vulgare</i>	common tansy
VETH	<i>Verbascum thapsus</i>	weed	forb	VETH	<i>Verbascum thapsus</i>	mullein, common
AECY	<i>Aegilops cylindrica</i>	weed	grami	AECY	<i>Aegilops cylindrica</i>	goatgrass, jointed
CELO3	<i>Cenchrus longispinus</i>	weed	grami	CELO	<i>Cenchrus longispinus</i>	sandbur, longspine
CYSC4	<i>Cytisus scoparius</i>	weed	shrub	CYSC	<i>Cytisus scoparius</i>	broom, Scotch

F. Literature cited

Daubenmire, R. 1959. A canopy-coverage method of vegetational analysis. Northwest Science 33(1): 43-64.

IX. TRACKABLE TREE AND SNAG SELECTION

TABLE OF CONTENTS

IX. TRACKABLE TREE AND SNAG SELECTION	147
A. Introduction	149
B. Determining if a tree/sapling/seedling is selected on a fixed-radius plot.....	149
C. Trackable tree and snag selection	149
D. Seedling requirements.....	150
E. Tree and snag selection MQO.....	151

Annual Inventory 2004
TRACKABLE TREE AND SNAG SELECTION

IX. TRACKABLE TREE AND SNAG SELECTION

A. Introduction

Large trees and snags (≥ 5.0 in. d.b.h./d.r.c.) are sampled using the 1/24 acre fixed-radius subplot. Each subplot has a fixed-radius of 24.0 feet horizontal.

Saplings (1.0 in. to 4.9 in. d.b.h./d.r.c.) are sampled more efficiently using the small (1/300 acre) fixed-radius microplot. Each microplot has a fixed-radius of 6.8 feet horizontal. Saplings are referenced to the microplot center.

Seedlings (conifers < 1.0 in. d.b.h./d.r.c. and ≥ 0.5 ft. in length; and hardwoods < 1.0 in. d.b.h./d.r.c. and ≥ 1.0 ft. in length) are also sampled most efficiently using the microplot (1/300 acre). Seedlings are counted by species and condition class (see "Seedling Count" on page 55) and in some cases, are tallied individually. Seedlings are referenced to the microplot center.

Large trees and snags (≥ 24.0 in. d.b.h./d.r.c. in Eastern Washington, Eastern Oregon, and California; ≥ 30.0 in. d.b.h./d.r.c. in Western Washington and Western Oregon) are sampled using the 1/4 acre fixed radius annular plot. Each annular plot has a fixed radius of 58.9 feet horizontal.

On R6 and R5 national forests within the Northwest Forest Plan area only, very large trees (≥ 32.0 in. d.b.h./d.r.c. in Eastern Washington, Eastern Oregon, and parts of California; ≥ 48.0 in. in Western Washington, Western Oregon and parts of California) are sampled using the full hectare plot. The size class to use will be downloaded in the data recorder. The hectare plot has a fixed radius of 185.1 feet horizontal from plot center. These trees are referenced to nearest subplot center. See Appendices 1 & 3 for additional special rules about nonforest plots/condition classes on R5 and R6 NFS lands.

B. Determining if a tree/sapling/seedling is selected on a fixed-radius plot

Trees are selected only when the distance from their bole center at the ground to the subplot center is less than the radius of that subplot/microplot/annular plot (see figure below).

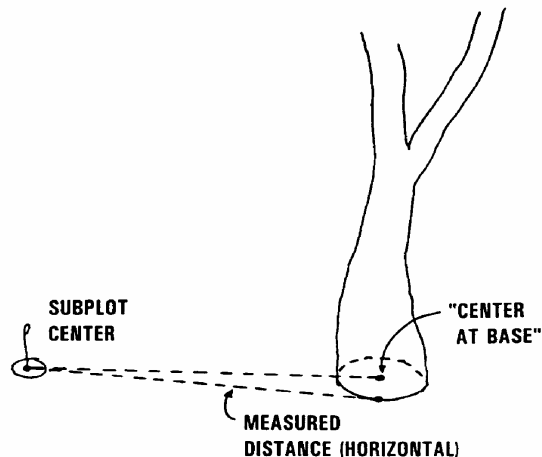

C. Trackable tree and snag selection

Is it a tree or a branch?:

See the rule for forked trees in tree data Item 12--DIAMETER (DIAM)

Is it a stump?:

High stumps meeting size and lean angle requirements shall be tallied as standing dead tally trees and are noted as a stump (Item 45--Stump (STUMP)).

Annual Inventory 2004
TRACKABLE TREE AND SNAG SELECTION

Follow the steps below:

1.) If the condition class is accessible forest land (CONDITION CLASS STATUS = 1) do the following steps in the condition class:

- a) Tally all trees live and ≥ 5.0 in. d.b.h./d.r.c. that are within the 24.0 ft. subplot.

Assign a TREE STATUS = 1.

- b) Tally all trees standing dead, ≥ 5.0 in. d.b.h./d.r.c., ≥ 4.5 feet tall, leaning < 45 degrees, that are within the 24.0 ft. subplot.

Assign a TREE STATUS = 2.

- c) Tally all live trees 1.0 to 4.9 in. d.b.h./d.r.c. that are within the 6.8 ft. microplot.

Assign a TREE STATUS = 1.

- d) Tally live seedlings (see Seedling Requirements) within the 6.8 ft. microplot only when the combined tally of live trees ≥ 1.0 in. d.b.h./d.r.c. present in the condition class on the 24.0 ft radius subplot is less than 4. Tally seedlings, if present, until the total tally of live trees and seedlings is 4 in the condition class on the 24.0 ft radius subplot. Tally a seedling only if it meets the requirements specified in the section "Seedling requirements" on page 150.

Assign these seedlings TREE STATUS = 1.

- e) Tally all live trees ≥ 24.0 in. d.b.h./d.r.c. in Eastern Washington, Eastern Oregon, and California, and ≥ 30.0 in. d.b.h./d.r.c. in Western Washington and Western Oregon that are within the 58.9 ft. annular plot which were not already tallied in step a).

Assign a TREE STATUS = 1.

- f) Tally all standing dead trees, ≥ 24.0 in. d.b.h./d.r.c. in Eastern Washington, Eastern Oregon, and California, and ≥ 30.0 in. d.b.h./d.r.c. in Western Washington and Western Oregon, ≥ 4.5 feet tall, leaning < 45 degrees, that are within the 58.9 ft. annular plot which were not already tallied in step b).

Assign a TREE STATUS = 2.

- g) On R6 national forests, and on R5 national forests within the Northwest Forest Plan area only: Tally all live trees ≥ 32.0 in. d.b.h./d.r.c. in Eastern Washington, Eastern Oregon, and 'east-side' California, and ≥ 48.0 in. d.b.h./d.r.c. in Western Washington, Western Oregon, and 'west-side' California that are within the 185.1 ft. hectare plot which were not already tallied in step a) or step e).

Assign a TREE STATUS = 1.

- h) On R6 national forests, and on R5 national forests within the Northwest Forest Plan area only: Tally all standing dead trees ≥ 32.0 in. d.b.h./d.r.c. in Eastern Washington, Eastern Oregon, and 'east-side' California, and ≥ 48.0 in. d.b.h./d.r.c. in Western Washington and Western Oregon, and 'west-side' California that are within the 185.1 ft. hectare plot which were not already tallied in step b) or step f).

Assign a TREE STATUS = 2.

2.) If the condition class is NOT accessible forest land and is NOT on R6 or R5 national forests:

Do not tally live trees, dead trees, or seedlings.

D. Seedling requirements

A seedling is: a live tree less than 1.0 in. d.b.h./d.r.c., a conifer at least 0.5 ft. in length or a hardwood at least 1.0 ft. in length, and established in mineral soil. (The requirements that follow differ from the requirements for "Seedling Count" on page 55).

Annual Inventory 2004
TRACKABLE TREE AND SNAG SELECTION

Tally a seedling only if it meets the following requirements:

1. Select a seedling only if its bole center at the ground is within 6.8 feet (horizontal distance) of microplot center.
2. Select a seedling only if it is expected to live at least 10 more years.
3. Do not tally a suppressed seedling.
4. Dominant and codominant seedlings less than 4.5 feet tall, and all overtopped and intermediate seedlings must be at least 2 feet from any other tree tallied on the microplot or subplot. Ignore residual overstory conifer and hardwood trees ≥ 5.0 in. d.b.h./d.r.c. when evaluating the crown class of an additional stocking seedling.
5. If a conifer, select a seedling only if it currently is not overtopped and shaded by another conifer and will not be overtopped and shaded by another conifer before reaching 9.0 in. d.b.h./d.r.c. This includes overtopping by other conifers that are within or outside the 6.8 foot fixed-radius plot. Ignore overtopping by conifers ≥ 9.0 in. d.b.h./d.r.c. and 50 years old (b.h. age) if the conifer seedling is of a shade tolerant species (true firs except noble fir, hemlocks, spruces, and cedars except incense cedar).

Whether or not a conifer is overtopped is estimated by using the "inverted cone" method. This method projects two straight lines along the branch tips of a tree's cone-shaped crown upward from their intersection at the tree's tip to create an imaginary cone, in the growing space above the tree. If one-third or more of the imaginary cone is occupied by the live crown(s) of other conifer(s), the tree is considered overtopped. If less than one-third of the imaginary cone is occupied, the tree is considered "free-to-grow".

6. Only one hardwood seedling in a hardwood clump can be selected. If more than one seedling in a clump is a candidate for being tallied, select the most dominant seedling candidate. Do not tally seedling-sized suckers that have sprouted from the base of a live, unsuppressed hardwood stem that is ≥ 5.0 in. d.b.h./d.r.c. A clump is defined as 3 or more live stems that sprouted from a common root system which had originated as part of a earlier tree whose above-ground bole was cut or is no longer alive.
7. Select trees by the following species priority:
 - a) Conifer species except for Pacific yew, incense cedar, and Port Orford cedar.
 - b) Incense cedar and Port Orford cedar.
 - c) Red alder and black cottonwood.
 - d) All other hardwood species except for dogwood, cherries, willows, hollies, or species coded 999.
 - e) Do not tally Pacific yew, dogwood, cherries, willows, hollies, or species coded 999. Within each level of species priority, select seedlings in order of dominance and vigor.

E. Tree and snag selection MQO

Tally tree selection:

Tolerance:

Seedling within the microplot: No errors

Sapling within the microplot: No errors

Live tree within the subplot: No errors

Dead tree within the subplot: No errors

Live tree within the annular plot: No errors

Dead tree within the annular plot: No errors

Live tree within the hectare plot: No errors

Dead tree within the hectare plot: No errors

Annual Inventory 2004
TRACKABLE TREE AND SNAG SELECTION

X. TRACKABLE TREE AND SNAG DATA

TABLE OF CONTENTS

X. TRACKABLE TREE AND SNAG DATA	153
Data recording	155
Item 1--Line number (LINE #)	155
Item 2--TREE RECORD NUMBER	155
Item 3--SUBPLOT NUMBER (Sub Pl)	155
Item 4--CONDITION CLASS NUMBER (Cc)	155
Item 5--PRESENT TREE STATUS (STAT)	156
Item 6--SPECIES (SPC).....	157
Item 7--AZIMUTH (AZM).....	157
Item 8--HORIZONTAL DISTANCE (HDIST)	157
Item 9--Slope distance (SDIST)	158
Item 10--Previous tree number (OLD TRN)	158
Item 11--Tree number (TRN).....	158
Item 12--DIAMETER (DIAM).....	158
DIAMETER AT BREAST HEIGHT (DBH)	159
DIAMETER AT ROOT COLLAR (DRC)	163
Item 13--DIAMETER CHECK (CHK).....	164
Item 14--10-Year increment (10-YR INC)	164
Item 15--5-Year increment (INC 5-YR)	165
Item 16--Tree age (AGE).....	165
Item 17--5-Year height growth (5-YR HT).....	167
Item 18--ACTUAL LENGTH (ACT)	167
Item 19--TOTAL LENGTH (TOT).....	167
Item 20--LENGTH METHOD (METH)	168
Item 21--COMPACTED CROWN RATIO (CR)	168
Item 22--CROWN CLASS (C)	169
Item 23--Remnant tree	170
Item 24--MISTLETOE CLASS (M)	170
Item 25--ROUGH CULL (RUF)	171
Item 26--ROTTEN/MISSING CULL (ROT).....	172
Item 27--Platform abundance (PLAT)	173
Item 28--Moss abundance (MOSS)	174
Item 29--Hardwood clump (CL).....	174
Item 30--Form class (FORM)	174
Item 31--Cavity presence (USE)	175
Items 32 through 37--PNW Damaging agent/severity (Agt, S)	175
Items 38 through 43--TREE DAMAGE (Dam, Loc, Sev)	179
Item 44--CAUSE OF DEATH (COD).....	179
Item 45--Stump (STUMP).....	179
Item 46--SNAG DECAY CLASS (DECAY).....	180
Item 47--Snag reason for disappearance (DIS)	181
Item 48--UTILIZATION CLASS (UTL).....	181
Item 49--TREE NOTES (NOTE)	182

X. TRACKABLE TREE AND SNAG DATA

Data recording

Record one line on the data recorder for each tree sampled. Required data items for these trees vary by subplot, condition class and tree status. Use this section to determine which items to complete for a particular kind of tree.

For each condition class where there are no tree records for the condition class other than TREE STATUS of 2 (snag), or 9 (witness-only) for any of the plot sizes within 58.9 feet of subplot center, record one line with the subplot number, the condition class number, a TREE STATUS of "N" and enter "NO TALLY" in remarks. If all forest condition classes within subplot 1 are "NO TALLY", two additional records are required to witness subplot center. These witness records can represent sound stumps or snags, but live trees are preferable (see pages 14 and 18 for instructions on referencing subplots). If the plot is entirely nonforest and stocking subplots were installed to determine condition class status, record two witness records for subplot 1. If the plot is entirely nonforest and is on NFS lands, record two witness records for subplot 1.

If both forest and one or more nonforest condition classes are mapped on a subplot's 58.9-foot fixed-radius plot, enter one line for each nonforest condition class; for each of these records, enter the subplot number, condition class number, and a TREE STATUS of N, and enter "NO TALLY" in remarks.

See Appendices 1 & 3 for additional special rules about nonforest plots/condition classes on R5 and R6 NFS lands.

Item 1--Line number (LINE #)

New records are assigned a line number by the Husky data recorder. At the time of remeasurement, Line Number will be printed/downloaded for previously recorded trees, snags, witness-only trees, and "no tally" records. In either case, the line number should not be changed by the field crew.

Item 2--TREE RECORD NUMBER

This item will not be collected in the field. It will be derived in the office for inclusion in the database. It is different than Item 1--Line number and Item 11--Tree number.

Record a 3 *digit* code to uniquely and permanently identify each tree on a given subplot. The TREE RECORD NUMBERS must be unique within a subplot - that is more important than being sequential. In general, work clockwise from azimuth 001 to 360, and work outwards from subplot center to subplot perimeter. On remeasured plots, use the previously assigned tree number. Saplings tallied on microplots will retain their initially assigned tree number if they grow to tree size. Missed trees will be assigned the next available tree number. DO NOT renumber all plot trees in order to assign a more 'correct' tree number to a missed tree. Numbers assigned to trees which are subsequently found to be extra trees will be dropped and not reused.

Item 3--SUBPLOT NUMBER (Sub PI)

Record the subplot number where the tree occurs.

A 2-digit code recorded for all trees on all subplots. The second digit is the previous visit subplot. At this inventory the first digit is "N" (this is referred to as a "N#" subplot). Other first digit codes (C, or #) may be valid for other inventories. See Chapter III for further instructions.

When Collected: All live and standing dead tally trees ≥ 1.0 in d.b.h./d.r.c., *witness only trees, seedlings*

Field width: 2 digits

Tolerance: No errors

Values: N1, N2, N3, N4

Item 4--CONDITION CLASS NUMBER (Cc)

Record the CONDITION CLASS NUMBER in which each tree is located. Often, a referenced boundary is approximate, and trees selected for tally are assigned to the actual condition in which they lie regardless of the recorded approximate boundary.

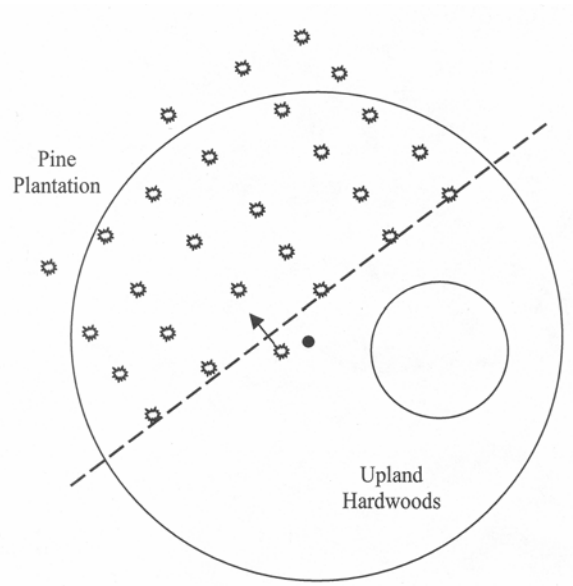

Ragged condition class boundary and tree condition class designation.

When Collected: All trees
 Field width: 1 digit
 Tolerance: No errors
 Values: 1 to 9

Item 5--PRESENT TREE STATUS (STAT)

Record a current PRESENT TREE STATUS for each tallied tree; this code is used to track the status of sample trees over time: as they first appear, as ingrowth, as they survive, and when they die or are removed. This information is needed to correctly assign volume information to the proper component of volume change.

When collected: All new live tally trees ≥ 1.0 in d.b.h./d.r.c,
 All new dead tally trees > 5.0 in
Witness only trees, seedlings

Field width: 1 digit
 Values:

Code	TREE STATUS	Description
0	No Status	Remeasurement plots only. Tree is not presently in the sample. Tree was incorrectly tallied at the previous inventory or currently is not tallied due to definition or procedural change, or is not tallied due to natural causes. Requires RECONCILE code=5-8
1	Live	Live tree (new, remeasured or ingrowth)
2	Dead	Any dead tree (new, remeasured or ingrowth) regardless of cause of death Includes all previously standing dead trees that no longer qualify as standing dead, as well as trees killed by silvicultural or land clearing activity, and are assumed not to have been utilized.. <i>Stumps meeting size and lean criteria are tallied as dead trees.</i>
3	Removed	Remeasurement plots only. Tree that has been cut or removed by direct human activity related to harvesting, silvicultural activity or land clearing. The tree is assumed to have been utilized.
9	Witness Only	A subplot witness that is not a trackable tree
N	No Live Tally	Used for each condition class on each subplot without live tally trees (TREE STATUS 1)
X	Delete Record	Deletes a record inadvertently entered.

Item 6--SPECIES (SPC)

Record the appropriate SPECIES code from the list in APPENDIX 7 -- TREE SPECIES LISTS. If you encounter a species not listed in Appendix 4 and are not sure if it should be tallied as a tree, consult your Field Supervisor. If the species cannot be determined in the field, tally the tree, but bring branch samples, foliage, cones, flowers, bark, etc. to your supervisor for identification. If possible, collect samples outside the subplots from similar specimens and make a note to correct the SPECIES code later. Use code 0299 for unknown dead conifer and 0998 for unknown dead hardwood when the genus or species codes cannot be used. The generic code should only be used when you are sure the species is on the species list, but you cannot differentiate among acceptable species. This is often the case with standing dead trees on newly established plots. In this case use the sample collections procedures described earlier in this paragraph.

Appendix 7 does not contain "genus-only" codes. They are not valid.

Plants included in the tree species list are measured as trees regardless of form. Procedures will be developed in the future to record tree species with shrub form. At the current inventory use the standard tree rules (1.0 in. diameter to be a sapling, etc.) and make notes in the plot card as needed. Those plants not included in the list are never tallied as trees, but are included in understory vegetation data collection.

When Collected: All live tally trees > 1.0 in d.b.h./d.r.c. and standing dead tally trees > 5.0 in d.b.h./d.r.c.
seedlings, witness-only trees

Field width: 4 digits

Tolerance: No errors

Values: See APPENDIX 7 -- TREE SPECIES LISTS

Monumenting information

Tree azimuth, distance, and tree number are used to relocate subplots and the live and dead trees tallied on subplots.

Item 7--AZIMUTH (AZM)

Record the AZIMUTH from the subplot center (for trees greater than or equal to 5.0 inches d.b.h./d.r.c.) or the microplot center (*for seedlings, and trees greater than or equal to 1.0 inch and less than 5.0 inches d.b.h./d.r.c.*), sight the center of the base of each tree with a compass. Sight to the geographic center for multi-stemmed western woodland species. The geographic center is a point of equal distance between all tallied stems for a given woodland tree. Record AZIMUTH to the nearest degree. Use 360 for north.

Use the magnetic declinations shown on page 24.

"Hectare" trees (see page 150) within a 58.9' radius subplot boundary must be referenced to that subplot.

Hectare trees not within a 58.9' radius subplot boundary can be referenced to any subplot.

When Collected: All live tally trees > 1.0 in d.b.h./d.r.c.) and standing dead tally trees > 5.0 in d.b.h./d.r.c.
seedlings, witness-only trees

Field width: 3 digits

Tolerance: +/- 10 degrees

Values: 001 to 360

Item 8--HORIZONTAL DISTANCE (HDIST)

Record the measured HORIZONTAL DISTANCE, to the nearest 0.1 foot, from the subplot center (for trees greater than or equal to 5.0 inches d.b.h./d.r.c) or microplot center (for trees greater than or equal to 1.0 inch and less than 5.0 inches d.b.h./d.r.c.) to the pith of the tree at the base. For all multi-stemmed western woodland trees the HORIZONTAL DISTANCE is measured from subplot or microplot center to the "geographic center" of the tree. The geographic center is a point of equal distance between all tallied stems for a given woodland tree.

The HORIZONTAL DISTANCE recorded for each tree must reflect the size radius plot the tree actually occurs in. For example: a tree at 23.4 ft. has a distance tolerance of +/- 1.0 ft., but its distance must be recorded as ≤ 24.0 or the recorded distance is incorrect.

"Hectare" trees (see page 150) within a 58.9' radius subplot boundary must be referenced to that subplot.

Hectare trees not within a 58.9' radius subplot boundary can be referenced to any subplot.

When Collected: All live tally trees > 1.0 in d.b.h./d.r.c. and standing dead tally trees > 5.0 in d.b.h./d.r.c.,
seedlings

Field width: 4 digits (xxx.y)

Tolerance: Microplot: +/- 0.2 ft

Subplot: +/- 1.0 ft

Annual Inventory 2004
TRACKABLE TREE AND SNAG DATA

Annular plot: +/- 10.0 ft
Hectare plot: +/- 10.0 ft
Values: Microplot: 0.1 to 6.8
Subplot: 0.1 to 24.0
Annular plot: 0.1 to 58.9
Hectare plot: 0.1 to 185.1

Item 9--Slope distance (SDIST)

Record the slope distance to the nearest 0.1 ft. from subplot center to the head of the nail that affixes the tree number/basal tag. In wilderness areas or National Parks where number/basal tags can not be used, measure from subplot center to front of the tree at the base.

When Collected: All witness trees
Field width: 3 digits (xx.y)
Tolerance: +/- 0.2 ft.
Values: 0.1 to 99.9

Item 10--Previous tree number (OLD TRN)

If any tree tallied at the current inventory has a tree number tag from a previous R6 CVS plot, R5 inventory plot, or PNW-FIA plot, record the number that is on that tag. If more than one old tree number tag is present record the one from the most recent inventory. This item is recorded for live trees, dead trees, and saplings, and will help link current data to previously collected data.

When Collected: All tally trees with a previous R6 CVS, R5, or PNW-FIA number tag on the tree
Field width: 3 digits
Tolerance: No errors
Values: 1 to 999

Item 11--Tree number (TRN)

All trees live and 5.0 in d.b.h./d.r.c. or larger sampled at the current inventory must be marked with an aluminum tree number tag and have the number recorded EXCEPT for trees that are witnesses.

Be sure the tag is nailed to the tree below stump height and faces subplot center. The nail should be driven in only as far as necessary to firmly anchor it in the wood. If a tree which requires a Tree Number has a PNW-FIA tag from a previous inventory, reuse the old tag if serviceable or attach a new tag. When replacing an old PNW-FIA tag, discard it. If an old tag cannot be removed, pound it in until flush with the bark so it will be overgrown and not confused with the new tag.

Do not use a tree number more than once on the same plot. Before leaving the vehicle, make sure the tree numbers previously assigned to downloaded trees are different than the numbers on the new tags you may use.

On R6 National Forests use blue colored number tags at the current visit to differentiate them from the old CVS tag. DO NOT REMOVE previous R6 CVS tree number tags.

On R5 National Forests use standard number tags at the current visit. DO NOT REMOVE previous R5 inventory tree number tags.

Follow any special monumenting protocols specified for wilderness or National Park plots.

When Collected: All live tally trees > 5.0 in. d.b.h./d.r.c.
Field width: 3 digits
Tolerance: No errors
Values: 1 to 999

Item 12--DIAMETER (DIAM)

Diameter is either diameter at breast height (DBH) or diameter at the root collar (DRC). Species requiring DRC are noted by a "w" in APPENDIX 7 -- TREE SPECIES LISTS.

Diameters are used in calculating volume, growth, average stand diameter, and stocking-related estimates such as forest type and stand size.

Marking Current Diameter:

1. Marking d.b.h./d.r.c. on trees previously marked:

The place where diameter was measured at the previous visit on trees tallied live and ≥ 3.0 in. d.b.h./d.r.c. was marked with an aluminum nail. On these trees, remeasure diameter at the location of the previous crew's nail if appropriate using the rules below. Reset the old nail enough so that as much of the old nail is exposed as possible. If the old nail cannot be pulled out to meet this requirement, set a new nail at the same location. If the previous location is no longer accessible (ie. covered in a landslide), there is an abnormality at the previous DIAMETER measurement point, or is more than 12 inches away from where the diameter should be measured according to current protocols (either because protocols have changed or the previous crew made a mistake) move the point of measurement and assign a DIAMETER CHECK code of 2. If the old nail marks a point of diameter measurement not used at the current inventory, remove it if possible; otherwise pound it in flush with the tree.

2. Marking trees ≥ 3.0 in. d.b.h./d.r.c, or snags ≥ 5.0 in. d.b.h./d.r.c, tallied for the first time:

Set an aluminum nail at the point of diameter measurement. On level ground, place the nail on the side of the tree facing the sample point. On a slope, place the nail on the uphill side of the bole. Leave as much of the nail exposed as possible, but be sure it is firmly affixed to the tree. For trees with multiple stems measured at d.r.c., place a nail at the point of measurement on each stem. Use caution to avoid damaging trees with scribes and nails. Do not scribe or nail trees less than 3.0-inches in diameter.

3. General instructions on marking diameter:

If a tree or snag (new or remeasured) is 32.0 in. d.b.h./d.r.c. or larger, affix an additional nail for every additional (above 32.0 in.) 12 in. of diameter, distributing the nails evenly around the circumference of the bole. Set these nails while the diameter tape is girdling the tree at the point of diameter.

4. Use painted nails if required by special monumenting protocols for wilderness or National Park plots.

Diameter for tallied seedlings is recorded as "0001".

When Collected: All live tally trees ≥ 1.0 in d.b.h./d.r.c.,
all standing dead tally trees ≥ 5.0 in d.b.h./d.r.c.
seedlings, witness-only trees

Field width: 4 digits (xxx.y)

Tolerance: Live trees, and dead trees with Decay Class 1, 2: ± 0.1 in. per 20.0 in increment of measured diameter. A tree with a diameter of 41.0 in would have a tolerance of ± 0.3 in.

Dead trees with Decay Class 3, 4, 5: ± 1.0 in. per 20.0 in increment of measured diameter.

Values: 001.0 to 999.9

DIAMETER AT BREAST HEIGHT (DBH)

Unless one of the following special situations is encountered, measure DBH at 4.5 ft above the ground line on the uphill side of the tree. Round each measurement down to the last 0.1 inch. For example, a reading of 3.68 inches is recorded as 3.6 inches.

Special DBH situations:

1. **Forked tree:** In order to qualify as a fork, the stem in question must be at least 1/3 the diameter of the main stem and must branch out from the main stem at an angle of 45 degrees or less. Forks originate at the point on the bole where the piths intersect. Forked trees are handled differently depending on whether the fork originates below 1.0 foot, between 1.0 and 4.5 feet, or above 4.5 feet.

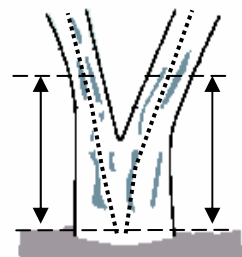

- Trees forked below 1.0 foot. Trees forked in this region are treated as distinctly separate trees. Distances and azimuths are measured individually to the center of each stem where it splits from the stump. DBH is measured for each stem at 4.5 feet above the ground. When stems originate from pith intersections below 1 foot, it is possible for some stems to be within the limiting distance of the microplot or subplot, and others to be beyond the limiting distance. If stems originating from forks that occur below 1.0 foot fork again between 1.0 and 4.5 feet, the rules in the next paragraph apply.

- Trees forked between 1.0 foot and 4.5 feet. Trees forked in this region are also counted as separate trees, but only one distance and azimuth (to the central stump) is used for all. Although a single azimuth and distance applies to all, multiple stems should be recorded as they occur in clockwise order (from front to back when one stem is directly in front of another). The DBH of each fork is measured at a point 3.5 feet above the pith intersection. When forks originate from pith intersections between 1.0 and 4.5 feet, the limiting distance is the same for all forks--they are either all on, or all off the plot.

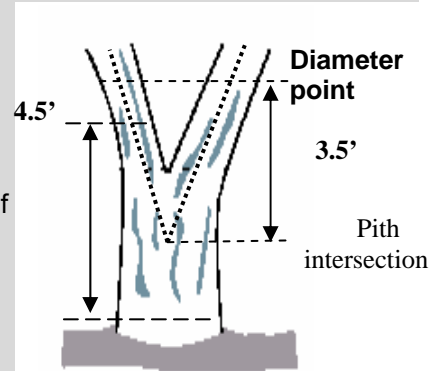

Multiple forks are possible if they all originate from approximately the same point on the main stem. In such cases, measure DBH on all stems at 3.5 feet above the common pith intersection.

Once a stem is tallied as a fork that originated from a pith intersection between 1.0 and 4.5 feet, do not recognize any additional forks that may occur on that stem. Measure the diameter of such stems below the base of stem separation (i.e., do not move the point of diameter the entire 3.5 feet above the first fork).

- Trees forked at or above 4.5 feet. Trees forked in this region count as one single tree. If a fork occurs at or immediately above 4.5 feet, measure diameter below the fork just beneath any swelling that would inflate DBH.

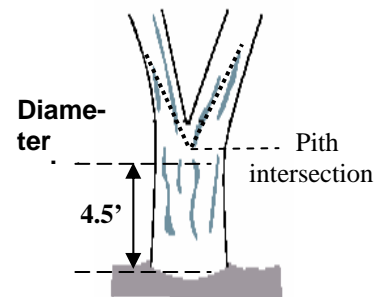

2. Stump Sprouts. Stump sprouts originate between ground level and 4.5 feet on the boles of trees that have died or been cut. Stump sprouts are handled the same as forked trees, with the exception that stump sprouts are not required to be 1/3 the diameter of the dead bole. Stump sprouts originating below 1.0 foot are measured at 4.5 feet from ground line. Stump sprouts originating between 1.0 foot and 4.5 feet are measured at 3.5 foot above their point of occurrence. As with forks, rules for measuring distance and azimuth depend on whether the sprouts originate above or below 1.0 foot. For multi-stemmed woodland species, treat all new sprouts as part of the same new tree.

3. Tree with butt-swell or bottleneck: Measure these trees 1.5 feet above the end of the swell or bottleneck if the swell or bottleneck extends 3.0 feet or more above the ground.

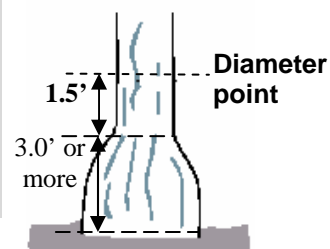

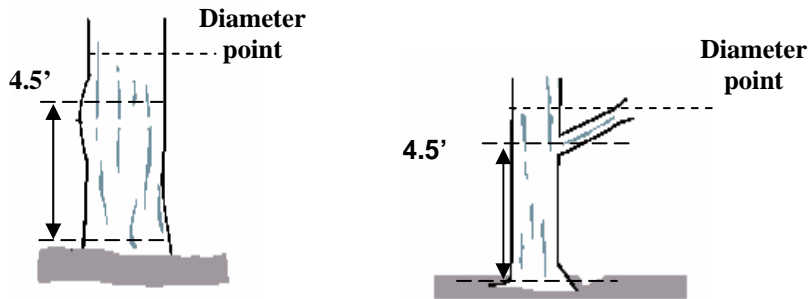

4. Tree with irregularities at DBH: On trees with swellings, bumps, depressions, and branches at DBH, diameter will be measured immediately above the irregularity at the place it ceases to affect normal stem form. See above diagrams.

5. Tree on slope: Measure diameter at 4.5 feet from the ground along the bole on the uphill side of the tree.

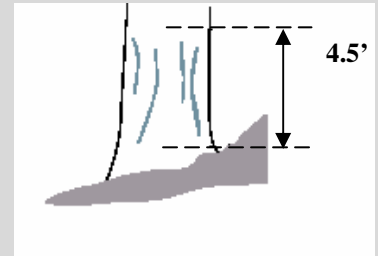

6. Leaning tree: Measure diameter at 4.5 feet from the ground along the bole. The 4.5 foot distance is measured along the underside face of the bole.

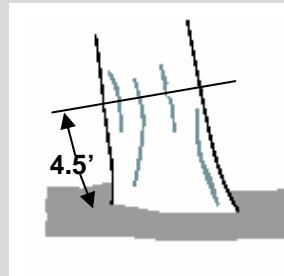

7. Turpentine tree: On trees with turpentine face extending above 4.5 feet, estimate the diameter at 10.0 feet above the ground and multiply by 1.1 to estimate DBH outside bark.

8. Independent trees that grow together: If two or more independent stems have grown together at or above the point of DBH, continue to treat them as separate trees.

Set two diameter nails at d.b.h./d.r.c. halfway around the tree's circumference from each other. Measure the distance between the nails with a diameter tape. Multiply the measurement by 2 and record the result as the current diameter. Example: Distance measured = 12.8 in. $(12.8 \times 2) = 25.6$ in. Set DIAMETER CHECK = 7.

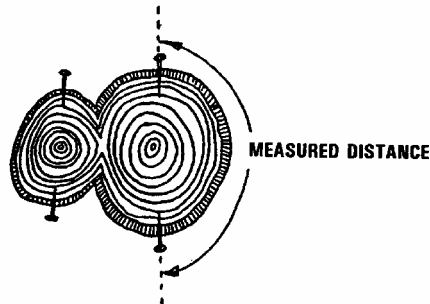

9. Missing wood or bark. Do not reconstruct the DBH of a tree that is missing wood or bark or at the point of measurement. Record the diameter, to the nearest 0.1 inch, of the wood and bark that is still attached to the tree. If a tree has a localized abnormality (gouge, depression, etc.) at the point of point of DBH, apply the procedure described for trees with irregularities at DBH.

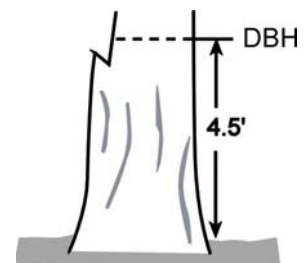

10. Live windthrown tree: Measure from the top of the root collar along the length to 4.5 feet.

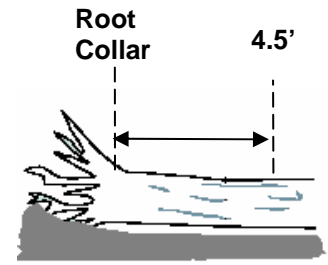

11. Down live tree with tree-form branches growing vertical from main bole. When a down live tree, touching the ground, has vertical (less than 45 degrees from vertical) tree-like branches coming off the main bole, first determine whether or not the pith of the main bole (averaged along the first log of the tree) is above or below the duff layer.

- If the pith of the main bole is above the duff layer, use the same forking rules specified for a forked tree, and take all measurements accordingly (figure below).
- If the pith intersection of the main down bole and vertical tree-like branch occurs below 4.5 feet from the stump along the main bole, treat that branch as a separate tree, and measure DBH 3.5' above the pith intersection for both the main bole and the tree-like branch (figure below).

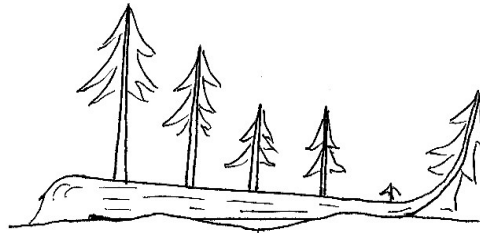

Down tree above duff

- If the intersection between the main down bole and the tree-like branch occurs beyond the 4.5-foot point from the stump along the main bole, treat that branch as part of the main down bole (figure above).
- If the pith of main tree bole is below the duff layer, ignore the main bole, and treat each tree-like branch as a separate tree; take DBH and length measurements from the ground, not necessarily from the top of the down bole (figure below). However, if the top of the main tree bole curves out of the ground towards a vertical angle, treat that portion of that top as an individual tree originating where the pith leaves the duff layer.

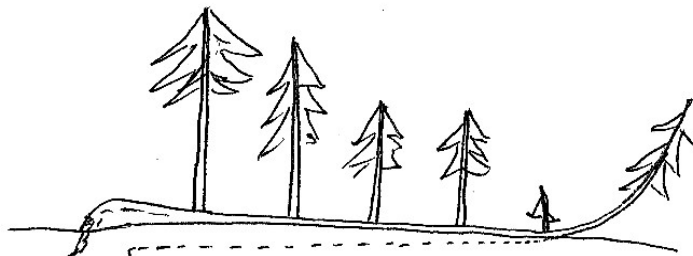

12. Tree with curved bole (pistol butt tree): Measure along the bole on the uphill side (upper surface) of the tree.

13. Diameter on stump: Use a logger's tape, cloth tape or ruler to measure the longest and shortest axis across the top of the stump. Record diameter as the average of the two measurements.

DIAMETER AT ROOT COLLAR (DRC)

For species requiring diameter at the root collar (refer to APPENDIX 7 -- TREE SPECIES LISTS), measure the diameter at the ground line or at the stem root collar, whichever is higher. For these trees, treat clumps of stems having a unified crown and common root stock as a single tree; examples include mesquite, juniper, and mountain mahogany. Treat stems of woodland species such as Gambel oak and Rocky Mountain maple as individual trees if they originate below the ground. For multi-stemmed trees, compute and record a cumulative DRC; record individual stem diameters and a stem status (live or dead) on a separate form or menu as required.

The data recorder has a feature to compute d.r.c, and forms are available. An example is in the Appendix with the tally sheets.

Measuring DRC:

Before measuring DRC, remove the loose material on the ground (e.g. ,litter) but not mineral soil. Measure just above any swells present, and in a location so that the diameter measurements are reflective of the volume above the stems (especially when trees are extremely deformed at the base).

Stems must be at least 1.0 foot in length and 1.0 inch in diameter to qualify for measurement; stems that are missing due to cutting or damage must have previously been at least 1.0 foot in length.

Whenever DRC is impossible or extremely difficult to measure with a diameter tape (e.g., due to thorns, extreme number of limbs), stems may be estimated and recorded to the nearest 1.0-inch class.

Additional instructions for DRC measurements are illustrated *below*.

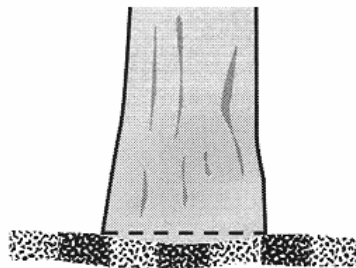

1. Measure at ground line when reasonable.

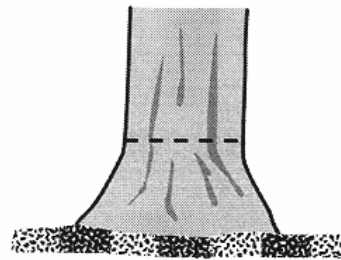

2. Measure above root collar.

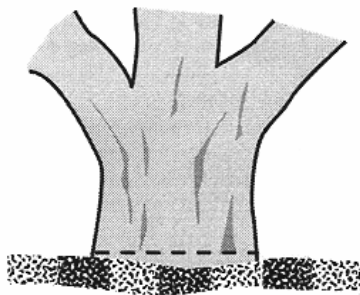

3. Multistemmed above diameter.

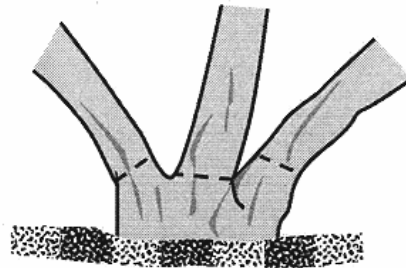

4. Excessive diameter below stems. Measure stems. Compute DRC.

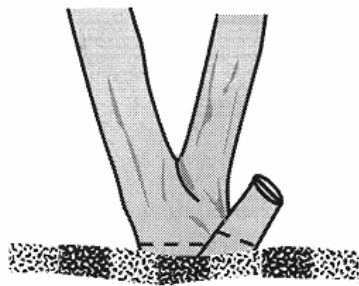

5. Measure missing stem(s).
 Compute DRC.

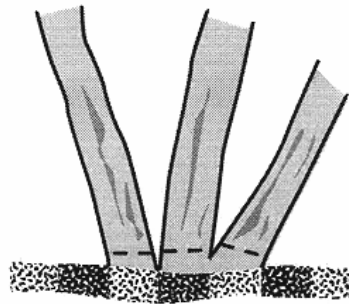

6. Multistemmed at or below
 ground. Compute DRC.

Computing and Recording DRC:

For all tally trees requiring DRC, with at least one stem 1.0 inch in diameter or larger at the root collar, DRC is computed as the square root of the sum of the squared stem diameters. For a single-stemmed DRC tree, the computed DRC is equal to the single diameter measured.

Use the following formula to compute DRC: $DRC = \text{SQRT} [\text{SUM} (\text{stem diameter}^2)]$

Round the result to the nearest 0.1 inch. For example, a multi-stemmed woodland tree with stems of 12.2,

13.2, 3.8, and 22.1 would be calculated as:

$$\begin{aligned}
 \text{DRC} &= \text{SQRT} (12.2^2 + 13.2^2 + 3.8^2 + 22.1^2) \\
 &= \text{SQRT} (825.93) \\
 &= 28.74 \\
 &= 28.7
 \end{aligned}$$

Item 13--DIAMETER CHECK (CHK)

Record this code to identify any irregularities in diameter measurement positions (i.e. abnormal swellings, diseases, damage, new measurement positions, etc.) that may affect use of this tree in diameter growth/change analyses. If *diameter is both estimated and moved*, use code 2.

If diameter is estimated because of moss/vine/obstruction etc., record an estimate of the diameter without the obstruction.

If diameter at the current inventory is measured at a different location than at the previous inventory, record DIAMETER CHECK=2 and remove the d-nail(s) from the previous inventory. If the previous point of diameter measurement can not be found on a live tree (ie. nail fell out) also record code 2.

When Collected: All live tally trees > 1.0 in d.b.h./d.r.c. and standing dead tally trees > 5.0 in d.b.h./d.r.c.

Field width: 1 digit

Tolerance: No errors

Values:

Code	Diameter check
0	Diameter measured accurately
1	Diameter estimated <i>for reason other than moss or vines.</i>
2	Diameter measured at different location than previous measurement (remove original d-nail)
5	Diameter estimated because of moss.
6	Diameter estimated because of vines.
7	Diameter estimated (double nail diameter)

Item 14--10-Year increment (10-YR INC)

A 3-digit code recording bored radial increment inside the bark to the nearest 1/20th inch for a 10-year period. Bored increment is required for every tree cored for tree age with an increment borer at the current inventory which does not have a Previous Tree Number.

Annual Inventory 2004
 TRACKABLE TREE AND SNAG DATA

Additional increment data will be derived in the office by comparing old diameter measurements to current diameter (using the Previous Tree Number, and eliminating trees where current diameter is not measured at the same place as past).

To obtain radial increment:

1. Bore the tree just below the point of diameter measurement (to avoid impacting the diameter measurement), on the side of the tree facing the point. If slope and tree size make this impossible, bore the tree on the side opposite the point.
2. Count back 10 growth rings from the cambium end of the core starting from the first fully-formed ring (and skipping this year's summer growth).
3. Measure the length of this segment of the core to the nearest 1/20 in. to get radial increment. Enter this radial increment as the number of twentieths. e.g. 18/20 is recorded "18" and 27/20 is recorded "27" .

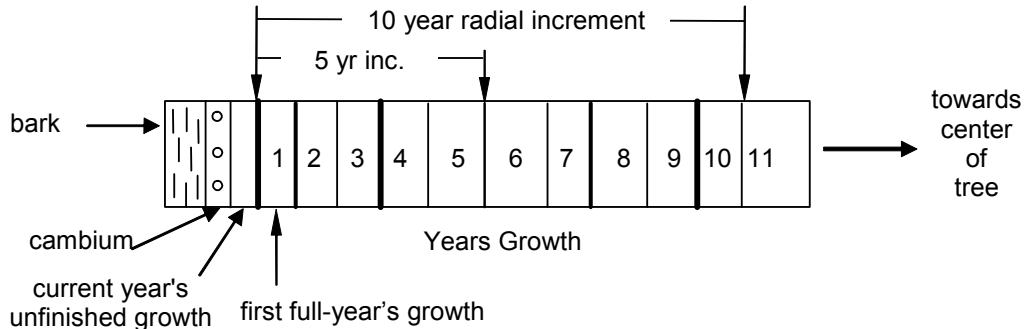

The cambium is often pinkish in color with a squishy, moist, corklike texture.
 The current year's unfinished growth is usually very light colored.

When Collected: See above instructions
 Field width: 3 digits
 Tolerance: +/- 1/20th per 1 inch of increment
 Values: 1 to 999

Item 15--5-Year increment (INC 5-YR)

A 3-digit code recording bored radial increment inside the bark to the nearest 1/20th inch for a 5-year period. 5-Year Bored increment is required for every tree cored for tree age with an increment borer. The procedures for the 5-year increment are the same as for Item 14--10-Year increment (10-YR INC), except that the increment period is 5 years.

When Collected: All trees cored for 10-Year increment
 Field width: 3 digits
 Tolerance: +/- 1/20th per 1 inch of increment
 Values: 1 to 999

Item 16--Tree age (AGE)

A 3-digit code indicating age at the point of diameter measurement. This variable is used in determining stand age, and in developing regression estimators of tree growth, mortality and harvest.

Starting from North and working in a clockwise direction on each microplot/subplot, determine the age of one live tree representing each species, in each crown class, for each condition class present on the plot. Although this selection method is to be used on each subplot, only one tree in each species/crown class/condition class needs to be bored on the entire plot. (Example: subplot 1 has a white fir in condition class 1, with a crown class of 3. Over the entire plot, only one white fir in condition class 1 with a crown class of 3 needs a bored age and increment.) This selection method is applied regardless of differences in diameter of the trees.

In addition, on plots where hectare trees are measured (See Item 17--Hectare plot? on page 28), for each species, if no hectare tree has been aged using the selection criteria above, bore the first hectare tree tallied of that species (regardless of crown class)

Bore trees ≥ 5.0 in. diameter, whorl count above 4.5 ft. pines and Douglas fir and true fir trees < 5.0 in. diameter. Be cautious of "false whorls" on lodgepole pine, true firs. Do not bore any tree < 5.0 in.

Hardwoods: do not bore any hardwoods except red alder.

Tree age may also be obtained from measurements made at previous inventories. If the previous inventory data is not downloaded to the data recorder, use the plot data sheets to determine which trees were bored for age. Add the number of growing seasons to that age and record the current age. (Note: in R5 only, previous Tree Age includes 10 years that were added to d.b.h. ages to allow for tree growth to 4.5 ft. Subtract this 10 years before adding the number of seasons to the current year). In some cases, new printed sheets may be provided which update the previous ages to the current year. Ages obtained from previous inventories can be used to fulfill the selection requirements above (species/crown class/condition class), however, the current crew is responsible for the accuracy of these ages.

Tree bored or 'whorl-counted' at the current inventory are marked with a "+" to the right of the age. Ages that are derived from previous inventory data are marked with a "p". Extrapolated ages are marked with a "e". The "+", "p", and "e" are entered on the Husky data recorder by typing a "V" after the age.

Trees with rotten centers (or rot within 16" of the bark on large-diameter trees) on which age cannot be accurately determined, and any tree with severe deformities at d.b.h. should not be bored. Bypass these trees and select the next one by species/crown class/condition class.

Tree size is not a valid reason for bypassing a tree. See the following instructions on extrapolating age for large trees.

Determining breast-height age of large trees: To determine the age of a tree whose radius is greater than the length of the increment borer, use the following procedure. This procedure may be available as a "pop-up" menu on the data recorder.

1. Bore into the tree as far as possible, extract the core, and count the rings.
2. Count the number of rings in the inner 2 inches of the core.
3. Measure the total length of the extracted core to the nearest 0.1 inch. (include the **entire** thickness of bark, even though some of it may not be in the core because it crumbled or the tree was cored in a bark furrow)
4. Divide the tree's diameter by 2.
5. Subtract (3) from (4). This gives you the distance by which you are short of reaching tree center.
6. Divide this number (5) by 2. This tells you how many 2-inch lengths you were short by.
7. Multiply this number (6) by the number of rings in inner 2 inches (2).
8. Add this number (7) to the total number of rings in the extracted core (1). This is the tree's estimated breast-high age.
9. Note "extrapolated age" with an "e" by typing a "V" after the age.

Example: Determine the age of a 59.6-inch Douglas-fir. The core has 110 rings, and has 10 rings in the inner 2 inches. 0.8 in. of the 16.4-inch-long increment borer did not penetrate the tree. Each number below is associated with its corresponding step above:

- Step 1: **110** rings counted
Step 2: **10** rings in the inner 2 in. of the core
Step 3: 14.6 in. of core was extracted + 1 in of bark that was not in the core = 15.6
Step 4: 59.6 in. is the tree's diameter and you then divide by 2 = **29.8** in. to center of tree (pith)
Step 5: 29.8 in. (true center) – 15.6 in. (measured core) = **14.2** in. short of reaching the pith
Step 6: 14.2 in./ 2 = **7.1 (2 in.) lengths short**
Step 7: 7.1 (from step6) x 10 (from step 2) = **71** rings not counted
Step 8: 110 rings counted (step 1) + 71 rings not counted (step 7) = **181 years old at BH**
Step 9: In the remarks column note "**extrapolated age**"

After boring a tree for age, leave the extracted increment core at the base of the tree (for the convenience of the check-plotter!).

Annual Inventory 2004
 TRACKABLE TREE AND SNAG DATA

When collected: First live tree by species/crown class/ condition class, and first hectare tree by species if no hectare tree of that species selected by above rule

Field width: 3 digits

Tolerance: Trees with measured age: +/- 10%

Trees with estimated age: +/- 20%

Trees with extrapolated age: +/- 30%

Values: 1 to 999

Item 17--5-Year height growth (5-YR HT)

For R6 and R5 national forests only, a 5-year height growth will be recorded on saplings (trees ≥ 1.0 in and < 5.0 in. d.b.h.). Begin at the sixth branch whorl from the top of the tree and measure to the first branch whorl from the top. Do not count false whorls or the current year's growth. Measure to the nearest 0.1 ft.

Starting from North and working in a clockwise direction on each microplot, record a 5-year height growth measurement for at least the first tree representing each species, in each crown class, for each condition class present on the plot for which a bored increment has not already been measured. Do not count whorls on suppressed trees (either a crown class of 5 or Damage Agent 50 is recorded). Although this selection method is to be used on each subplot, only one tree in each species/crown class/ condition class needs a growth measurement on the entire plot.

When Collected: See above; Do not record on Pacific yew, hemlocks, cedars, junipers, or hardwoods.

Field width: 3 digits

Tolerance: The tolerance depends on the height of the tree.

Height	Tolerance
< 15 ft.	+/- 0.1 ft.
15 – 35 ft.	+/- 1.0 ft.
36 – 50 ft.	+/- 2.0 ft.
> 50 ft.	+/- 3.0 ft.

Values: 1 to 25.0

Item 18--ACTUAL LENGTH (ACT)

For trees with missing tops (top on live trees is completely detached; top on dead trees is greater than 50 percent detached from the tree). Record the ACTUAL LENGTH of the tree to the nearest 1.0 foot from ground level to the break. Use the length to the break for ACTUAL LENGTH until a new leader qualifies as the new top for TOTAL LENGTH; until that occurs, continue to record ACTUAL LENGTH to the break. Trees with previously broken tops are considered recovered (i.e., ACTUAL LENGTH = TOTAL LENGTH) when a new leader is 1/3 the diameter of the broken top at the point where the top was broken (not where the new leader originates from the trunk). ACTUAL LENGTH is the length of the bole, not the vertical height and should only differ from TOTAL LENGTH if the tree has a broken or missing top.

When Collected: All live and standing dead tally trees

Field width: 3 digits

Tolerance: Live trees < 60 ft.: +/- 5% of true length

Live trees ≥ 60 ft. and all dead trees: +/- 10% of true length

Values: 001 to 400

Item 19--TOTAL LENGTH (TOT)

Record the TOTAL LENGTH of the tree, to the nearest 1.0 ft from ground level to the top of the tree. For trees growing on a slope, measure on the uphill side of the tree. If the tree has a missing top (top is broken and completely detached from the tree), estimate what the total length would be if there were no missing top. Dead, crooked, or forked tops do not affect TOTAL LENGTH.

Height on leaning trees: Measure or estimate total normally-formed bole length (from the base to the tip of the tree), and not the perpendicular from the ground to the tip. To measure heights of leaning trees using a clinometer, follow these steps:

1. Move to a point along a line (point D) that is perpendicular to the plane in which the tree is leaning.

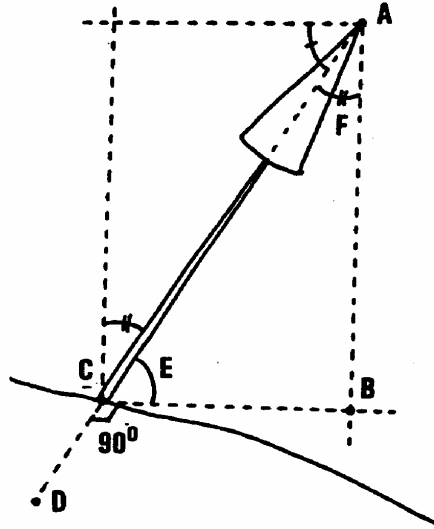

2. Using your clinometer, measure the height of point A above point B.
3. By standing at the base of the tree and sighting up the bole with your clinometer, measure the slope of the bole in degrees. (Angle E in the diagram above)
4. Subtract the degrees of lean (step 3.) from 90 degrees. This gives you the degrees of angle F.
5. By sighting through your clinometer, convert the angle calculated in step 4 to a percentage.
6. Use the slope correction table on page 267 to determine the expansion factor for the percent slope determined in step 5. Multiply the expansion factor by the measured distance from point A to point B (step 2). This gives the length of the bole (point A to point C).

When Collected: All live tally trees ≥ 1.0 in. d.b.h./d.r.c. and,
 all standing dead tally trees ≥ 5.0 in. d.b.h./d.r.c.
 Field width: 3 digits
 Tolerance: +/- 10% of true length
 Values: 001 to 400

Item 20--LENGTH METHOD (METH)

Record the code that indicates the method used to determine tree lengths.

When Collected: All live tally trees ≥ 1.0 in. d.b.h./d.r.c., and
 all standing dead tally trees ≥ 5.0 in d.b.h./d.r.c.
 Field width: 1 digit
 Tolerance: No errors
 Values:

Data Recorder Code	Code	Length Method
B	1	Actual and total lengths are field measured with a measurement instrument (e.g., laser, clinometer, relascope)
A	2	Actual length is measured with an instrument, total length is visually estimated
N	3	Actual and total and lengths are visually estimated (<i>not measured</i>).

Item 21--COMPACTED CROWN RATIO (CR)

Record the COMPACTED CROWN RATIO for each live tally tree, 1.0 in and larger to the nearest 1 percent. COMPACTED CROWN RATIO is that portion of the tree supporting live foliage (or in the case of extreme temporary defoliation, should be supporting live foliage) and is expressed as a percentage of the ACTUAL TREE LENGTH (*ie. include dead tops, but not missing tops in the ratio*). To determine COMPACTED CROWN RATIO, ocularly transfer lower live branches to fill in large holes in the upper portion of the tree until a full, even crown is visualized. *Try to picture the normal density of photosynthetic foliage and adjust for it (i.e. some*

branches may be very sparse with needles/leaves). Do not over-compact trees beyond their typical full crown situation. For example, if tree branches tend to average 2-feet between whorls, do not compact crowns any tighter than the 2-foot spacing. *Include epicormic branches once they are 1" diameter*. Crown ratio is based on the ratio of foliage, not where the limbs attach to the tree bole. Crown ratio is an indicator of a tree's vigor. In data analysis, trees with a crown ratio of 30 percent or less are considered less vigorous. For this reason, be particularly careful when deciding between codes greater or less than "30." It is preferable to use a laser or clinometer to measure live crown ratios on these trees.

When Collected: All live tally trees \geq 1.0 in. d.b.h./d.r.c., *seedlings*
 Field width: 2 digits
 Tolerance: +/- 10% (10% of 100)
 Values: 00 to 99

Item 22--CROWN CLASS (C)

Rate tree crowns in relation to the **sunlight received** and proximity to neighboring trees (see diagrams below). Base the assessment on the position of the crown at the time of observation. Example: a formerly overtopped tree which is now dominant due to tree removal is classified as dominant. Crown class describes a tree's "social" position in the stand and may indicate how well the tree is competing for light.

Crown classifications are easily applied in even-aged stands. Classifications are more difficult to assign in uneven-aged stands or in plots where more than one age class is present. In these situations, classify the tree based on its immediate environment. In other words, base your classification on how much light the tree's crown is receiving, not its position in the canopy. This data item is used to predict tree growth. The intermediate and overtopped crown classes are meant to include trees seriously affected by direct competition with adjacent trees.

For example, a young, vigorous tree that is considerably shorter than other trees in the stand-but that is not overtopped by other trees and that receives full light from above and partly from the side-is classified as dominant. The same principle applies to two-storied stands: understory trees should only be assigned subordinate crown classes if they are adjacent to overtopping trees. In plots with scattered residual overstory trees over younger trees, a considerable portion of the understory trees will be classified as dominant or codominant.

When Collected: All live tally trees \geq 1.0 in d.b.h./d.r.c., *seedlings*
 Field width: 1 digit
 Tolerance: No errors
 Values:

Code	Crown class	Definition
1	Open grown	Trees with crowns that receive full light from above and from all sides throughout most of its life, particularly during its early developmental period.
2	Dominant	Trees with crown extending above the general level of the crown canopy and receiving full light from above and partly from the sides. These trees are taller than the average trees in the stand and their crowns are well developed, but they could be somewhat crowded on the sides. Also, trees whose crowns have received full light from above and from all sides during early development and most of their life. Their crown form or shape appears to be free of influence from neighboring trees.
3	Codominant	Trees with crowns at the general level of the crown canopy. Crowns receive full light from above but little direct sunlight penetrates their sides. Usually they have medium-sized crowns and are somewhat crowded from the sides. In stagnated stands, codominant trees have small-sized crowns and are crowded on the sides.
4	Intermediate	These trees are shorter than dominants and codominants, but their crowns extend into the canopy of codominant and dominant trees. They receive little direct light from above and none from the sides. As a result, intermediate trees usually have small crowns and are very crowded from the sides.
5	Overtopped	Trees with crowns entirely below the general level of the crown canopy that receive no direct sunlight either from above or the sides

Item 23--Remnant tree

A remnant tree is a tree left by previous mangement activity or catastrophic event that is significantly older than the surrounding vegetation. Remnant trees do not form a canopy layer and are usually isolated individuals or small clumps. Record a code that indicates whether or not the tree is a remnant.

When collected: All live trees \geq 5.0 in. d.b.h./d.r.c.

Field width: 1 digit

Tolerance: No errors

Values:

Code	Description
0	No
1	Yes

Item 24--MISTLETOE CLASS (M)

Record a code indicating the extent and severity of mistletoe infection for all live conifer and oak trees \geq 1.0 in. d.b.h./d.r.c.

Rate all live conifer species, except juniper species *and incense cedar*, \geq 1.0 in diameter for dwarf mistletoe (*Arceuthobium* spp.) infection. Use the Hawksworth six-class rating system: divide the live crown into thirds, and rate each third using the following scale. See the note below regarding mistle toe on white fir in CA.

Code	Mistletoe	Description
0	No visible infection	None
1	Light infection	< 50 percent of the total branches infected
2	Heavy infection	> 50 percent of the total branches infected

Sum the three individual ratings to obtain a total mistletoe class (0 to 6) for the tree.

Example: A conifer tree has no infection in top third of crown, light infection in the middle third, and has many brooms in the lower third.

The total score is: 0 + 1 + 2 = 3; the code is: "3"

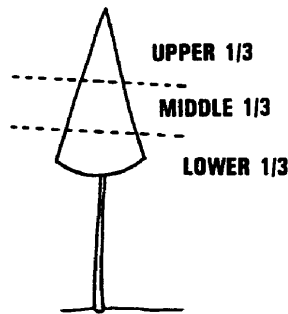

Rate all juniper species, incense cedars, white fir (CA only), and oak trees for leafy mistletoe infection. This item is used to describe the extent and severity of mistletoe infection. Rate leafy mistletoe using the following criteria:

Code	Description
0	No leafy mistletoe is present
7	Branch infections. <50% of crown involved
8	Branch infections. >50% of crown involved. Any occurrence on the bole

White fir (CA only): Rate this species for both dwarf mistletoe and leafy mistletoe. Record the code for the more severe infection. If the infections are equally severe, record the dwarf mistletoe code.

When Collected: All live conifer and oak trees \geq 1.0 in d.b.h./d.r.c.

Field width: 1 digit

Annual Inventory 2004
 TRACKABLE TREE AND SNAG DATA

Tolerance: +/- 1 class
 Values: 0 to 6: Conifer (except juniper and incense cedar) trees ≥ 1.0 in d.b.h./d.r.c.,
 0, 7, 8: *Juniper species, incense cedar, white fir (CA only), and oaks*

Item 25--ROUGH CULL (RUF)

For each live tally tree 5.0 inches d.b.h./d.r.c. or larger, record the total percentage of cubic-foot volume that is cull due to sound dead material or tree form. Record to the nearest 1 percent. When estimating volume loss (tree cull), only consider the cull on the merchantable bole/portion of the tree, from a 1-foot stump to a 4-inch top. For western woodland species, the merchantable portion is between the point of DRC measurements to a 1.5-inch DOB top, and rough cull includes only sound dead. Refer to local defect guidelines *below* as an aid in determining cull volume for various damages such as crook, fork, sweep, postil butt, etc. Small trees (5-9 inches for softwoods and 5-11 inches for hardwoods) that have poor form and are not expected to ever produce merchantable material should be coded 99% rough cull.

Code only when 3.0 ft. or more of the tree is defective. Record the reason for the deduction by recording a PNW Damaging Agent code in Items 32, 34, or 36; a severity rating is not required.

Conifer merchantability minimums

	Size class (in.)	Stump height (ft.)	Log length (ft.)	Minimum top diameter outside bark (in.)
Poletimber	5.0-8.9	1.0	8.0	4.0
Sawtimber	9.0+	1.5	16.0	7.0

Percentage distribution of total tree volume for sawtimber conifers (9.0 in. d.b.h. and larger)

(16.0 ft. logs)

Tree height (in logs)	Log number											
	1	2	3	4	5	6	7	8	9	10	11	12
1	100											
2	70	24										
3	55	35	10									
4	41	31	20	8								
5	32	27	21	14	6							
6	27	23	19	15	11	5						
7	23	20	17	15	12	8	5					
8	20	18	16	14	12	9	7	4				
9	17	16	15	13	11	10	8	6	4			
10	16	15	13	12	11	10	8	7	5	3		
11	14	13	13	11	11	10	8	7	6	4	3	
12	14	13	12	11	10	10	8	7	6	4	3	2

**Percentage distribution of total tree volume
 for hardwoods and poletimber conifers (conifers 5.0-8.9 in. d.b.h.)**

(8.0 ft. logs)

Tree height (in logs)	Log number									
	1	2	3	4	5	6	7	8	9	10
1	100									
2	55	45								
3	41	33	25							
4	33	28	22	17						
5	28	24	20	16	12					
6	25	22	18	15	12	8				
7	22	20	17	14	12	9	6			
8	20	18	16	14	11	9	7	5		
9	18	17	15	13	11	9	7	6	4	
10	17	16	14	12	10	9	8	6	5	3

When Collected: All live tally trees \geq 5.0 in. d.b.h./d.r.c.
 Field width: 2 digits
 Tolerance: +/- 10%
 Values: 00 to 99

Item 26--ROTTEN/MISSING CULL (ROT)

Record the percent rotten or missing cubic-foot cull.

When estimating volume loss (tree cull), only consider the cull on the merchantable bole/portion of the tree, from a 1-foot stump to a 4-inch top. Do not include any cull estimate above ACTUAL LENGTH. For western woodland species, the merchantable portion is between the point of d.r.c. measurement to a 1.5 inch DOB top.

Rotten and missing volume loss is often difficult to estimate. Refer to supplemental disease and insect pests field guides and local defect guidelines as an aid in identifying damaging agents and their impact on volume loss. Use your best judgment and be alert to such defect indicators as the following:

- Cankers or fruiting bodies.
- Swollen or punky knots.
- Dull, hollow sound of bole (use regional standards).
- Large dead limbs, especially those with frayed ends.
- Sawdust around the base of the tree.

Use the following PNW-FIA regional guidelines to determine the PERCENT ROTTEN/MISSING cull in the tree. If the tree is physically missing some of its volume (below ACTUAL HEIGHT), use the volume estimation tables under ROUGH CULL to estimate the percent that is missing. Record that estimation here. Broken tops occur above ACTUAL HEIGHT and are not included in ROTTEN/MISSING CULL (the volume of the broken top is obtained in the office by comparing ACTUAL vs. TOTAL HEIGHT).

Do not include evidence of rot which is obtained solely by coring the tree.

If the tree has rotten portions, use the following guidelines to determine what category of rot it falls under. Record the code associated with the category shown in the table below.

- 1.) Determine if the bole is at least 10-percent rotten. The tree is assigned to category "0" if none of the following indicators are present:
 - a) Open or closed trunk wound over 10 years old and in contact with the ground.
 - b) Open trunk wound with visible rot, or a closed trunk wound over 10 years old. To qualify, the wound must be either 10 feet long in the lower half of the bole, or 16 feet long in the top half of the bole. For true fir and hemlock, the wound must be \geq 5 feet long anywhere on the bole.
 - c) The tree is a conifer and has, in the lower 2/3 of the bole, 2 or more crooks or forks which indicate past top out.
 - d) A swollen or hollow butt.

Annual Inventory 2004
TRACKABLE TREE AND SNAG DATA

- e) Large rotten knots or limb stubs.
- f) Conk(s).

2.) If one or more of these indicators are present, use the following guide to assign a rot code:

Category 3: The tree is assigned to category "3" if one or more of the following is present:

- a) Echinodontium tinctorium or Phellinus pini conks present and spread along 60 percent or more of the bole.
- b) Echinodontium tinctorium or Phellinus pini conks present and spread along 30-59 percent or more of the bole, and top is missing.
- c) 30-59 percent of bole is rotten and top is out.
- d) 60 percent or more of merchantable bole from the ground up is rotten.
- e) Oligoporus amarus (Polyporus amarus) rot, conk or shot hole cup present on incense cedar or Fomitopsis officinalis conk present on Douglas fir, pine, or larch..
- f) Tree is a hardwood >100 years old and any amount of rot or ≥ 2 conks are present.

Category 2: The tree is assigned to category "2" if one or more of the following is present:

- a) Echinodontium tinctorium or Phellinus cancriformans are present.
- b) Phellinus pini conk(s) spread along 30-59 percent of the bole.
- c) 30-59 percent of bole is rotten.
- d) Tree is a hardwood and one conk present.

Category 1: The tree is assigned to category "1" for the presence of indicators that are not listed under category 2 or 3 and the bole is at least 10 percent rotten; e. g. Phaeolus schweinitzii conks on bole near ground.

Code	Category	Range of Field % Rot
0	0	0-9%
25	1	10-39%
50	2	40-74%
99	3	75-100%

Record the reason for the current ROTTEN/MISSING CULL by recording a PNW Damaging Agent code in Items 32, 34, or 36; a severity rating is not required.

When Collected: All live tally trees ≥ 5.0 in. d.b.h./d.r.c.
Field width: 2 digits
Tolerance: +/- 10%
Values: 0 to 99

Platform and Moss Abundance

Platform and Moss Abundance data are collected on qualifying trees located on plots where Plot Attribute Item 14--Special study 2002a on page 28 =Y.

Selection of Viewing Position: Select a position, preferably on the uphill side of the tree that provides the clearest view of as much of the tree bole and crown area as possible to estimate platform and moss abundance. As an optional field aide to the inspection process, measure the azimuth and slope distance from the position at which measurements are made to the base of the tree being evaluated. Record the azimuth and slope distance, if collected, in the Tree Comments section for the tree.

The Azimuth/Distance (an optional field) for the tree viewing position selected is used to assist in the inspection process only. When recording viewing position, complete azimuth to the nearest degree and slope distance to the nearest foot. For example, 061/051 is equivalent to 61 degree az. and 51 feet distance. Record in the Tree Comments field. If viewing position azimuth/distance is not recorded, the check plotter's determination of best viewing position will be utilized.

Item 27--Platform abundance (PLAT)

Count the number of limbs that contain one or more platforms. Each limb with one or more platforms is counted only once, regardless of the number of platform structures on the limb. Limb counts from 1 to 9 shall

Annual Inventory 2004
TRACKABLE TREE AND SNAG DATA

be tallied as individuals (i.e. 1, 2, 3, etc.). A tree with 10 or greater limbs with one or more platforms shall be tallied as 10. Counts will be summarized into the groups: 0, 1-5, 6-9, ≥ 10 .

A platform is a section or area of a live limb that is >6.0 in. diameter, located >33.0 feet above the ground up to the top of a live crown of a tree, and not positioned at more than a 45 degree angle from horizontal. This includes limb areas where the diameter has been enlarged by effects of insects, mistletoe, disease, physical injury, or the accumulation of moss.

When collected: All live tally trees ≥ 20.0 in. d.b.h. on plots where Plot Attributes Item 14--Special study 2002a = Y

Field width: 2 digits
Tolerance: No errors
Values: 0 to 10

Item 28--Moss abundance (MOSS)

Estimate the percentage of the surface area on the horizontal surface or top of each limb covered by moss ONLY; do not include other epiphytes, such as lichens. From the same point used to estimate Platform abundance (Item 27), estimate moss coverage on the horizontal surface of all visible limbs in the lower two thirds of the live tree crown. Estimate the percent cover of moss on the top of each limb, then average across ALL limbs within the lower two thirds of the crown. Record the result for each tallied tree to the nearest percent from 0 to 99.

Moss is any of various green, nonvascular plants of the class Musci of the division Bryophyta that usually form a mat-like surface on a limb.

When collected: All live trees ≥ 20.0 in. d.b.h. on plots where Plot Attributes Item 14--Special study 2002a = Y with a PLATFORM present.

Field width: 2 digits
Tolerance: +/-20%
Values: 0 to 99

Item 29--Hardwood clump (CL)

A 1-digit code indicating if a hardwood is part of a clump. The clump is assigned a clump number, and the number is recorded for each hardwood tallied that is part of the clump. If a hardwood is not part of a clump, "0" is recorded for the tree. Clumps with tallied trees are numbered in consecutive order on a subplot starting with "1".

Example: Maple trees in three different maple clumps are tallied on a subplot. Trees tallied that are in the first clump are coded "1" for hardwood clump. Trees tallied in the second clump are coded "2" for hardwood clump, and trees tallied in the third clump are coded "3" for hardwood clump.

A clump is defined as 3 or more live hardwood stems originating from a common point in the same root system, usually from a tree now dead or gone. Hardwood clumps typically arise from old stumps that are left from cutting or from natural mortality. Each fork of a forked tree counts as one stem if the fork is below d.b.h./d.r.c. and must be entered on a separate line. Do not tally seedling-sized suckers that have sprouted from the base of a live, unsuppressed hardwood stem that is ≥ 5.0 in. d.b.h./d.r.c.

Clump data are used in adjusting stocking estimates; trees growing in clumps contribute less stocking than those growing as individuals.

When collected: All live hardwood trees ≥ 1.0 in. d.b.h./d.r.c., live hardwood seedlings
Field width: 1 digit
Tolerance: No errors
Values: 0 to 9

Item 30--Form class (FORM)

Record for all live hardwood trees tallied that are ≥ 5.0 in. d.b.h./d.r.c. Form class is used in calculating net tree volume.

When Collected: On all hardwoods; (**on all hardwoods and conifers in R5 national forests**)

Annual Inventory 2004
 TRACKABLE TREE AND SNAG DATA

Field width: 1 digit
 Tolerance: No errors
 Values: 1 to 3

Code	Form class
1	First 8 feet above stump is straight. (A log is considered straight if a line drawn through the centers of both ends of the log does not pass outside the curve of the log.)
2	First 8 feet above stump is NOT straight or forked; but must have at least one straight 8 foot log elsewhere in the tree.
3	No 8 foot logs anywhere in tree now or in the future due to form. Includes the sea serpents, octopi, giant tumbleweeds, pretzels, cauliflowers, and various free form trees. Requires entry of a Damaging Agent.

Stoppers include forks, culled missing sections

HARDWOOD FORM CLASS

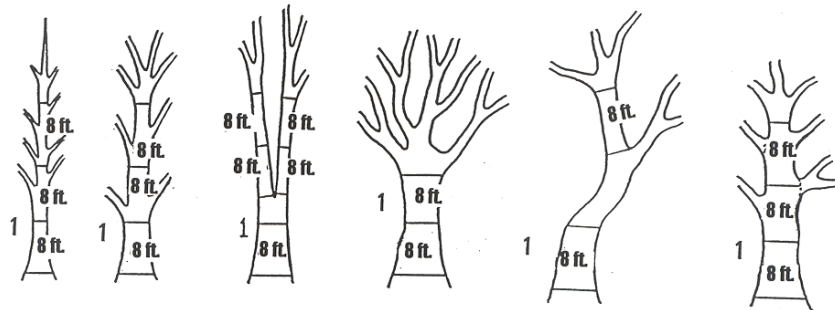

Various examples of form class 1.

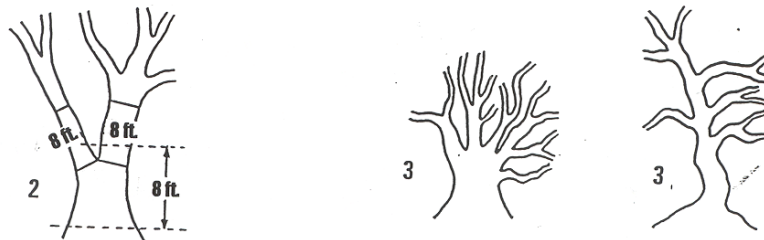

Example of a fork stopping a 8' section

Example of trees with no qualifying 8' section

Item 31--Cavity presence (USE)

Record a code to indicate wildlife use. A cavity must be able to be used by wildlife (birds, small mammals, large mammals, etc.) to be coded. If more than cavity is present, record the size of the largest one.

When Collected: All live and standing dead tally trees ≥ 5.0 in. (TREE STATUS = 1 or 2).

Field width: 1 digit
 Tolerance: No errors
 Values:

Code	Description
0	No cavity or den present
1	Cavity or den present < 6.0 inches
2	Cavity or den present ≥ 6.0 inches

Items 32 through 37--PNW Damaging agent/severity (Agt, S)

Damaging agent: a 2-digit code entered, if needed, in three agent fields (Items 32, 34, and 36). Severity: a 1-digit code entered, if required, in three severity fields available (Item 33, 35, and 37). For all trees tallied live at last field visit, record up to 3 damaging agents, each with a severity rating (if required).

Annual Inventory 2004
 TRACKABLE TREE AND SNAG DATA

The agent and severity codes are used to indicate the type of agents present on a tree and describe their severity. Several damaging agents are automatically of highest importance and should be coded before any other agents; these agents are grouped as Class I Agents. Class I insects, diseases, or physical injuries can seriously affect vegetation. Failure to account for these agents can result in large differences in predicted outcomes for tree growth, survival, vegetative composition and structure. Class II agents can be important in local situations; recording their incidence and severity provides valuable information for those situations. Record Class II agents when present but only after all Class I agents. If more than three damaging agents are found on a tree, then code the three agents thought to have the most impact on forest conditions in the condition class (remembering to code Class I agents first).

Agents and their severity ratings are grouped by broad category. Each category has a general agent and specific agents listed. The general codes should be used if there is any question as to the identity of the specific damaging agent.

- Item 32--Agent 1 (Agt1)**
- Item 33--Severity 1 (S1)**
- Item 34--Agent 2 (S2)**
- Item 35--Severity 2 (S2)**
- Item 36--Agent 3 (Agt3)**
- Item 37--Severity 3 (S3)**

When collected: All live tally trees

Tolerance: Agents detected and classified in correct category

Severity: for agents with 3 or less available codes, no error. For agents with 4 or more available codes, +/- one code

Values:

CLASS I AGENTS

Bark beetles:

<u>Code</u>	<u>Agent</u>	<u>Code</u>	<u>Severity</u>
01	General/other bark beetle	1	Unsuccessful current attack
02	Mountain pine beetle	2	Successful current attack
03	Douglas-fir beetle	3	Last year's successful attack
04	Spruce beetle	4	Older dead
05	Western pine beetle	5	Top kill
06	Pine engraver beetle		
07	Fir engraver beetle		
08	Silver fir beetle		
09	Red turpentine beetle		
26	Jeffrey pine beetle		

Note: Bark beetles often attack trees weakened by root disease fungi. Carefully evaluate trees suffering bark beetle attack for evidence of root disease.

Defoliators:

<u>Code</u>	<u>Agent</u>	<u>Code</u>	<u>Severity</u>
10	General/other	1 to 9	Divide live crown into thirds.
11	Western blackheaded budworm		Rate each third separately based on
12	Pine butterfly		the following classes:
13	Douglas-fir tussock moth		0 - No detectable defoliation
14	Larch casebearer		1 - Up to 33% of foliage (old and new) affected
15	Western spruce or Modoc budworm		2 - 34 to 66% of foliage affected
16	Western hemlock looper		3 - 67 to 100% of foliage affected
17	Sawflies		
18	Needle and sheath miners		Obtain severity rating by adding ratings for each
19	Gypsy moth		third. Record total.

Root diseases: (see Appendix 17 for identification of individual root disease symptoms)

Annual Inventory 2004
TRACKABLE TREE AND SNAG DATA

<u>Code</u>	<u>Agent</u>	<u>Code</u>	<u>Severity</u>
60	General/other	1	Tree is a live tally tree within 30 ft of a tree or stump that has a root disease to which the tally tree is susceptible. Enter the agent code.
61	Annosus root disease	2	Live tally tree with signs or symptoms diagnostic for root disease such as characteristic decay, stain, ectotrophic mycelia, mycelial fans, conks or excessive resin flow at the root collar. No visible crown deterioration.
62	Armillaria root disease		
63	Black stain root disease		
65	Laminated root rot		
66	Port-Orford-cedar root disease		
		3	Live tally tree with signs or symptoms diagnostic for root disease such as characteristic decay, stain, ectotrophic mycelia, mycelial fans, conks, or excessive resin flow at the root collar. Visible crown deterioration such as thinning chlorotic foliage, reduced terminal growth, and/or stress cones.

White pine blister rust:

<u>Code</u>	<u>Agent</u>	<u>Code</u>	<u>Severity</u>
36	White pine blister rust	1	Branch infections located more than 2.0 ft. from tree bole.
		2	Branch infections located 0.5 to 2.0 ft. from bole.
		3	Bole infections present, Or: branch infections within 0.5 ft. of bole.

Sudden oak death (tanoak, coast live oak, black oak)

<u>Code</u>	<u>Agent</u>	<u>Code</u>	<u>Severity</u>
31*	Sudden Oak Death Symptoms	1	Bleeding present on bole
		2	Bleeding present on bole and adjacent mortality present
		3	Laboratory confirmed Sudden Oak Death (NOT to be coded by the field crew)

Follow the instructions in section D. Sudden Oak Death (SOD) Syndrome on page 265 anytime code 31 is used.

CLASS II AGENTS:

Other insects:

<u>Code</u>	<u>Agent</u>	<u>Code</u>	<u>Severity</u>
20	General	1	Bottlebrush or shortened leaders, 0-2 forks on the tree's stem, Or: less than 20% of the branches affected, Or: <50% of the bole has visible larval galleries.
21	Shoot moths	2	3 or more forks on the tree's bole, Or: 20% or more of the branches are affected, Or: the terminal leader is dead, Or: ≥50% of the bole has visible larval galleries.
22	Weevils		
23	Wood borers		
24	Balsam wooly adelgid (aphid)		
25	Sitka spruce terminal weevil		

Stem-branch cankers:

<u>Code</u>	<u>Agent</u>	<u>Code</u>	<u>Severity</u>
40	General/other	1	Branch infections present. <50% of the crown affected.
41	Western gall rust (Pipo, Pico)	2	Branch infections present. ≥50% of the crown affected, Or: any infection on the bole.
42	Commandra blister rust (Pipo)		
43	Stalactiform rust (Pico)		
44	Atropellis canker (Pinus spp.)		
45	Cytospora or Phomopsis (Psme, Abies spp.)		
33	Diplodia blight		

Pitch Canker

<u>Code</u>	<u>Agent</u>	<u>Code</u>	<u>Severity</u>
32	Pitch Canker (CA Pinus spp)	1	no bole canker + < 10 infected branch tips

Annual Inventory 2004
TRACKABLE TREE AND SNAG DATA

2	no bole canker + \geq 10 infected branch tips
3	1 or more bole cankers + < 10 infected branch tips
4	1 or more bole cankers + \geq 10 infected branch tips

Stem decays:

<u>Code</u>	<u>Agent</u>	<u>Code</u>	<u>Severity</u>
46	General/other	1	1 conk on the stem or present at ground level.
47	Red ring rot (<i>P. pini</i>)	2	2 or more conks separated by < 16 ft. on bole.
48	Indian paint rot (<i>E. tinctorium</i>)	3	2 or more conks separated by \geq 16 ft. on bole.
49	Brown cubical rot (<i>P. schweinitzii</i>)	4	No conks. Visible decay in the interior of the bole. Do not include decay found only as a result of coring the tree.

Special agents:

<u>Code</u>	<u>Agent</u>	<u>Severity/Instructions</u>
50	Suppression	No severity rating. Code this agent if tree is overtopped by other trees and will not live 10 more years, Or: will prevent a sapling from reaching 5.0 in. d.b.h./d.r.c.
51	Excessively deformed sapling	No severity rating. Code this agent on live trees (1.0-4.9 in. d.b.h./d.r.c.) that will never produce a minimum log. A minimum log for conifers is 16.0 ft. long, and, for hardwoods, 8.0 ft. long.

Foliar pathogens:

<u>Code</u>	<u>Agent</u>	<u>Code</u>	<u>Severity</u>
55	General/other	1	<20% of foliage affected, Or: <20% of crown in brooms.
56	Rhabdocline (only on <i>Psme</i>)		
57	Elytroderma (only on <i>Pipo</i>)		
58	Broom rusts (only on <i>Abies</i> , <i>Picea</i> , <i>Juoc</i> – <i>Gymnosporagium</i> , and <i>Calocedrus decurrens</i>)	2	\geq 20% of foliage affected, Or: >20% of crown in brooms.
59	Swiss needle cast [only on <i>Psme</i>]		

Animal agents:

<u>Code</u>	<u>Agent</u>	<u>Code</u>	<u>Severity</u>
70	Animal: general/unknown	1	<20% of the crown is affected. Bole damage is restricted to less than half of circumference.
71	Mountain beaver		
72	Livestock		
73	Deer or elk	2	\geq 20% of the crown is affected. Bole damage to half or more of circumference.
74	Porcupines		
75	Pocket gophers, squirrels, mice voles, rabbits, hares.		
76	Beaver		
77	Bear		
78	Human (not logging)		

Weather agents:

<u>Code</u>	<u>Agent</u>	<u>Code</u>	<u>Severity</u>
80	Weather: general/unknown	1	<20% of the crown is affected.
81	Windthrow or wind breakage		
82	Snow/ice bending or breakage	2	\geq 20% of the crown is affected, Or: any damage to the bole.
83	Frost damage on shoots		
84	Winter desiccation		
85	Drought/moisture deficiency		
86	Sun scald		
87	Lightning		

Physical Injury:

<u>Code</u>	<u>Agent</u>	<u>Code</u>	<u>Severity</u>
90	Other: general/unknown	1	<20% of the crown affected.
91	Logging damage		

Annual Inventory 2004
 TRACKABLE TREE AND SNAG DATA

92	Fire: basal scars or scorch	2	≥20% of the crown affected, Or:
93	Improper planting		any damage to the bole.
94	Air pollution or other chemical damage		

Physical Defect:

<u>Code</u>	<u>Severity</u>		
95	Unspecified physical defect	0	Severity is not rated
96	Broken/Missing Top		
97	Dead top		
98	Forks and Crooks (only if caused by old top out or dead top)		
99	Checks/bole cracks		

Only codes 96, and 97 are of much importance.

Code 95, 98, and 99 only after any other agents present are coded.
 Codes 90 and 95 require a comment in Tree Notes.

Items 38 through 43--TREE DAMAGE (Dam, Loc, Sev)

The FIA National CORE damage reporting system lists up to 2 different damages per tree. Each damage record consists of codes for location of damage, type of damage, and severity of damage. These codes and their descriptions can be found in chapter 11 of this manual. This method of recording tree damage is described in Chapter XI. NATIONAL TREE DAMAGE PROCEDURES.

National Core tree damage procedures are currently being reviewed, and may possibly be revised. This data will not be collected on either P2 or P3 plots during the 2004 field season.

Item 38--DAMAGE LOCATION 1

Item 39--DAMAGE TYPE 1

Item 40--DAMAGE SEVERITY 1

Item 41--DAMAGE LOCATION 2

Item 42--DAMAGE TYPE 2

Item 43--DAMAGE SEVERITY 2

Item 44--CAUSE OF DEATH (COD)

Record a cause of death for all trees that have died or been cut since the previous survey. If cause of death cannot be reliably estimated, record unknown/not sure.

When Collected: All TREE STATUS = 1 at time 1, and trees with TREE STATUS = 2 or 3 at time 2

Field width: 2 digits

Tolerance: No errors

Values:

Code	CAUSE OF DEATH
10	Insect
20	Disease
30	Fire
40	Animal
50	Weather
60	Vegetation (suppression, competition, vines/kudzu)
70	Unknown/not sure/other- includes death from human activity not related to silvicultural or landclearing activity (accidental, random, etc.) Tree notes required.
80	Silvicultural or landclearing activity (death caused by harvesting or other silvicultural activity, including girdling, chaining, etc., or to landclearing activity)

Item 45--Stump (STUMP)

Annual Inventory 2004
 TRACKABLE TREE AND SNAG DATA

Record a code to indicate if a standing dead tree record is a stump (its bole was severed by human mechanical activity). On most trees, evidence of cutting is distinct, on older trees use the presence of springboard notches, and the presence/condition of nearby stumps as guidelines. Cutting of the tree may have occurred while the tree was either live or dead. Note: To qualify as a standing dead tally record, the stump must meet minimum size criteria (≥ 5.0 in dia, $\geq 4.5'$ tall) and lean < 45 degrees.

When Collected: All trees with TREE STATUS = 2
 Field width: 1 digit
 Tolerance: No errors
 Values:

Code	Description
0	Not a stump
1	Is a stump
2	Is a stump with another tree growing out of it

Item 46--SNAG DECAY CLASS (DECAY)

Record for each standing dead tree, 5.0-inch in diameter and larger, indicating the trees stage of decay. It is unlikely that decay class 5 will apply to a tally tree; by the time a dead tree has reached decay class 5, it will have toppled over or have become too short to qualify for tally.

When Collected: All standing dead tally trees ≥ 5.0 in d.b.h./d.r.c.
 Field width: 1 digit
 Tolerance: +/- 1 class
 Values: Use the following table for guidelines:

Characteristics of Douglas-fir snags by decay class¹

Snag characteristics						
Decay Class (code)	Limbs and Branches	Top	% Bark Remaining	Sapwood Presence	Sapwood Condition	Heartwood Condition
1	All present	Pointed	100	Intact	Sound, incipient decay, hard, original color	Sound, hard, original color
2	Few limbs, no fine branches	Broken	Variable	Sloughing	Advanced decay, fibrous, firm to soft, light brown	Sound at base, incipient decay in outer edge of upper bole, hard, light to reddish brown
3	Limb stubs	Broken	Variable	Sloughing	Fibrous, soft, light to reddish brown	Incipient decay at base, advanced decay throughout upper bole, fibrous, hard to firm, reddish brown
4	Few or no stubs	Broken	Variable	Sloughing	Cubical, soft, reddish to dark brown	Advanced decay at base, sloughing from upper bole, fibrous to cubical, soft, dark reddish brown
5	None	Broken	Less than 20	Gone	Gone	Sloughing, cubical, soft, dark brown, <u>OR</u> fibrous, very soft, dark reddish brown, encased in hardened shell

¹ Characteristics are for Douglas-fir. Snags for other species may vary somewhat; use this table as a guide.

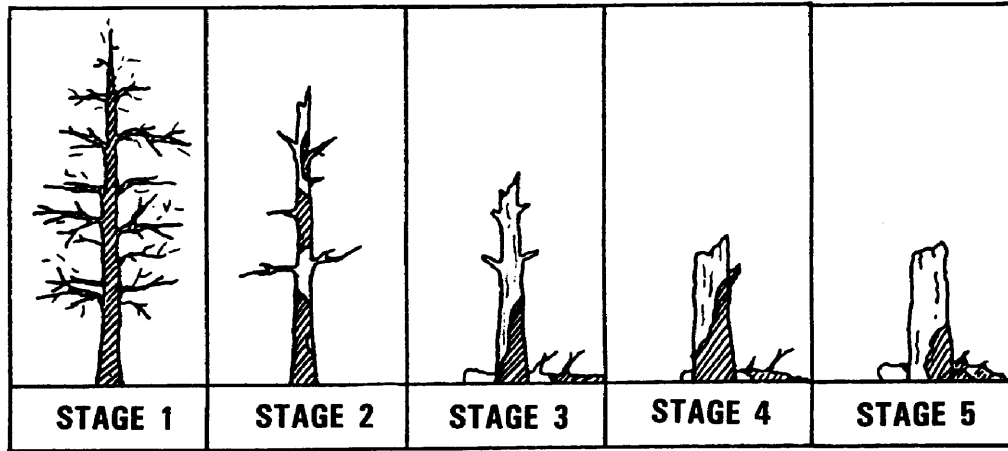

Item 47--Snag reason for disappearance (DIS)

Record a code to indicate the reason for disappearance of a tree previously tallied as dead.

When Collected: All trees with TREE STATUS = 2 at time 1

Field width: 1 digit

Tolerance: Correctly identify if tree is present or not

Values:

Code	Description
2	Fell over "naturally" (wind, decay, etc.) or no longer self-supported; still present.
3	Fell over "naturally;" removed from the site, or not discernible by crew.
4	Cut down or pushed over; still present.
5	Cut down or pushed over; removed from the site, or not discernible by crew.
6	D.b.h./d.r.c and/or height no longer meet minimum for tally (snag "shrank" to less than 5.0 in. d.b.h./d.r.c. or less than 4.5 feet tall).

Item 48--UTILIZATION CLASS (UTL)

Record the code to identify cut trees that have been removed from the site.

Definitions of harvest use:

Harvested for industrial supply means the tree was harvested for industrial roundwood or chips. The tree was not used for firewood or for products manufactured and used by "do-it-yourselfers", often on the property of origin for improvements such as fences, buildings and bridges. The tree was marketed and transported from the property of origin to wood-using plant or export operation.

Harvested for firewood or local use means the tree was harvested for firewood, or for wood products manufactured and used locally by "do-it-yourselfers", often on the ownership of origin, for improvements such as fences, buildings and bridges. The tree was not marketed and transported to a wood-processing plant or export operation.

Harvested for incidental reasons means the tree was harvested (1) as an isolated removal in an otherwise undisturbed stand or (2) as part of a harvest activity in an adjacent stand condition that resulted in the removal of one or more tally trees.

When Collected: All TREE STATUS = 3

Field width: 1 digit

Tolerance: No errors

MQO: At least 99% of the time

Values:

Code	UTILIZATION CLASS
0	Not utilized - can still be found on the site
1	Utilized – some portion of the tree cannot be found on site, assumed to have been removed
2	Harvested for industrial supply

Annual Inventory 2004
TRACKABLE TREE AND SNAG DATA

3	Harvested for firewood or local use
4	Harvested for incidental reasons

Item 49--TREE NOTES (NOTE)

Record notes pertaining to an individual tree as called for to explain or describe another variable.

When collected: All trees. Field width: Alphanumeric character field

Tolerance: N/A

Values: English language words, phrases and numbers

XI. NATIONAL TREE DAMAGE

TABLE OF CONTENTS



XI. NATIONAL TREE DAMAGE PROCEDURES

National Core tree damage procedures are currently being reviewed, and may possibly be revised. This data will not be collected on either P2 or P3 plots during the 2004 field season.

XII. DOWN WOODY MATERIALS

TABLE OF CONTENTS

XII. DOWN WOODY MATERIALS.....	187
A. Introduction.....	189
B. Definition of down woody materials.....	189
C. Locating and establishing line transects.....	190
D. Transect line segmenting.....	191
Item 1--SUBPLOT NUMBER.....	192
Item 2--TRANSECT.....	192
Item 3--CONDITION CLASS NUMBER.....	192
Item 4--BEGINNING DISTANCE.....	192
Item 5--ENDING DISTANCE.....	193
Item 6--SLOPE PERCENT.....	193
E. Sampling Methods for coarse woody debris (CWD).....	193
F. Marking CWD.....	196
G. Recording procedures for CWD.....	196
Item 1--SUBPLOT NUMBER.....	196
Item 2--TRANSECT.....	196
Item 3--CWD SLOPE DISTANCE.....	196
Item 4--CWD DECAY CLASS.....	197
Item 5--SPECIES.....	197
Item 6 -DIAMETER AT POINT OF INTERSECTION.....	199
Item 7--DIAMETER AT THE SMALL END.....	199
Item 8--DIAMETER AT THE LARGE END.....	199
Item 9--CWD TOTAL LENGTH.....	199
Item 10--HOLLOW.....	200
Item 11--Percent of log charred by fire (CHARR).....	200
Item 12--CWD history.....	201
H. Sampling methods for fine woody debris (FWD).....	201
Item 1--SUBPLOT NUMBER.....	202
Item 2--CONDITION CLASS NUMBER.....	202
Item 3--SMALL FWD COUNT.....	202
Item 4--MEDIUM FWD COUNT.....	202
Item 5--LARGE FWD COUNT.....	203
Item 6--HIGH COUNT REASON.....	203
Item 7--RESIDUE PILE ON TRANSECT.....	203
I. Duff, litter, and fuelbed depth measurements.....	203
Item 1--SUBPLOT NUMBER.....	205
Item 2--TRANSECT.....	205
Item 3--DUFF, LITTER, AND FUELBED SAMPLE.....	205
Item 4--DUFF DEPTH.....	205
Item 5--LITTER DEPTH.....	205
Item 6--FUELBED DEPTH.....	206
J. Fuel loading on the Microplot.....	206
Item 1--SUBPLOT NUMBER.....	207
Item 2--LIVE SHRUB PERCENT COVER.....	207
Item 3--LIVE SHRUB HEIGHT.....	207
Item 4--DEAD SHRUBS PERCENT COVER.....	207
Item 5--DEAD SHRUBS HEIGHT.....	208
Item 6--LIVE HERBS PERCENT COVER.....	208
Item 7--LIVE HERBS HEIGHT.....	208
Item 8--DEAD HERBS PERCENT COVER.....	208
Item 9--DEAD HERBS HEIGHT.....	209
Item 10--LITTER PERCENT COVER.....	209
K. Sampling residue piles.....	209

Annual Inventory 2004
DOWN WOODY MATERIALS

Selection instructions	209
Item 1--SUBPLOT NUMBER	210
Item 2--CONDITION CLASS	210
Item 3--PILE AZIMUTH	210
Item 4--SHAPE	210
Item 5--PILE LENGTH 1	211
Item 6--PILE LENGTH 2	211
Item 7--PILE WIDTH 1	211
Item 8--PILE WIDTH 2	211
Item 9--PILE HEIGHT 1	211
Item 10--PILE HEIGHT 2	211
Item 11--PILE DENSITY	212
Item 12—Horizontal Distance to Pile	212

XII. DOWN WOODY MATERIALS

A. Introduction

Down woody materials (DWM) are an important component of forest ecosystems across the country. DWM is dead material on the ground in various stages of decay. Wildlife biologists, ecologists, mycologists, foresters, and fuels specialists are some of the people interested in DWM because it helps describe the:

- quality and status of wildlife habitats
- structural diversity within a forest
- fuel loading and fire behavior
- carbon sequestration-the amount of carbon tied up in dead wood
- storage and cycling of nutrients and water-important for site productivity.

Down woody components and fuels estimated by the FIA program are: coarse woody, fine woody, litter, herb/shrubs, slash, duff, and fuelbed. Any crew member can learn to collect down woody materials data. If untrained members of the crew are available to help, they can locate, measure, and flag transect lines and record condition class information for the transect segments.

DWM is only sampled in accessible forest conditions intersected by the transect. If a transect crosses a nonforest condition, the boundaries of the condition are recorded (see section 14.3) but no DWM or fuels measurements are taken along this portion of the transect. The majority of DWM in the inventory is sampled using the line intersect sampling method (also called planar intercept method). In this method, transects are established, and individual pieces of CWD or FWD are tallied if the central axis of the piece is intersected by the plane of the transect. In addition, each piece must meet specified dimensions and other criteria before being selected for tally. Special procedures apply when a CWD piece lays across a condition class boundary. Transects will always be used to sample FWD. Transects will be used to sample CWD when crews are able to see and measure individual pieces.

The line intersect method is not practical for sampling CWD when it is part of machine-piled windrows or slash piles, or part of log "jumbles" at the bottom of steep-sided ravines. In these situations, individual pieces are impractical to tally separately and are labeled as "residue piles". A different sampling method is used to tally and measure CWD residue piles (see "Sampling residue piles" on page 209).

See Appendices 1 & 3 for special rules about nonforest plots/condition classes on R5 and R6 NFS lands.

B. Definition of down woody materials

CWD:

In this inventory, CWD includes downed, dead tree and shrub boles, large limbs, and other woody pieces that are severed from their original source of growth. CWD also includes dead trees leaning > 45 degrees from vertical. Also included are non-machine processed round wood such as fence posts and cabin logs. For multi-stemmed woodland trees such as juniper, only tally stems that are dead, detached, and on the ground; or dead and leaning > 45 degrees from vertical.

CWD does **not** include:

1. Woody pieces < 3.0 inches in diameter at the point of intersection with the transect.
2. Dead trees leaning 0 to 45 degrees from vertical
3. Dead shrubs, self-supported by their roots.
4. Trees showing any sign of life.
5. Stumps that are rooted in the ground (i.e. not uprooted).
6. Dead foliage, bark or other non-woody pieces that are not an integral part of a bole or limb. (Bark attached to a portion of a piece is an integral part).
7. Roots or main bole below the root collar.

FWD:

In this inventory, FWD includes downed, dead branches, twigs, and small tree or shrub boles that are not attached to a living or standing dead source. FWD can be connected to a larger branch, as long as this branch is on the ground and not connected to a standing dead or live tree. Only the woody branches, twigs, and fragments that intersect the transect are counted. FWD can be connected to a down, dead tree bole or down, dead shrub. FWD can be twigs from shrubs and vines. FWD must be no higher than 6 feet above the ground to be counted.

Annual Inventory 2004
DOWN WOODY MATERIALS

FWD does **not** include:

- 1) Woody pieces ≥ 3.0 inches in diameter at the point of intersection with the transect.
- 2) Dead branches connected to a live tree or shrub; or to a standing dead tree or dead shrub.
- 3) Dead foliage (i.e. pine or fir needles, or leaf petioles).
- 4) Bark fragments or other non-woody pieces that are not an integral part of a branch, twig, or small bole.
- 5) Small pieces of decomposed wood (i.e. chunks of cubical rot)

C. Locating and establishing line transects

Transects are established on each subplot if the subplot center is accessible (i.e. not census water, access denied, or hazardous), and there is at least one forest land condition class mapped within the 58.9 ft annular plot (Condition class status = 1). Transects begin at the subplot center and extend 58.9 ft. to the edge of the annular plot. The location of condition class boundaries are recorded along the transect. It is extremely important to lay out the transect in a straight line to avoid biasing the selection of pieces and to allow the remeasurement of transect lines and tally pieces for future change detection.

Transect lines should be marked with a small piece of flagging at the end of the line (58.9 feet, horizontal distance) to help the QA staff identify the path of the transect during the check-plot procedure. Because the tolerance for the transect azimuth is +/- 2 degrees, the line might have been laid down in a slightly different direction from the check-plot crew. This could affect the location of diameter measurements for CWD pieces as well as identifying whether a CWD piece is a valid tally piece. It is also helpful to mark the point where the FWD transect begins (14 ft, slope distance).

CWD transects

Two transects are established that originate at the subplot center and extend out 58.9-foot horizontal distance (the radius of the annular plot).

Transect orientation differs depending on subplot number (see diagram below):

1. Subplots 1 and 4: azimuths are 150 and 270 degrees (from subplot center).
2. Subplots 2 and 3: azimuths are 30 and 150 degrees (from subplot center).

Note: the reasons that different azimuths were chosen are:

1. to avoid sampling bias on sloped land, where it is possible that CWD may be oriented in one direction. This configuration of transects should pick up CWD logs that are lying parallel to the slope, perpendicular to the slope, and across slope;
2. the outer ends of the transects do not meet at the edge of the annular plot, avoiding the possibility of double counting CWD tallied at the transect ends;
3. these azimuths correspond to previously installed transects in the 3-year DWD pilot.

FWD transects

One transect is established on each subplot, along the 150 degree azimuth. FWD is tallied within 3 size classes. Because FWD is generally present in higher densities, a shorter transect will pick up an acceptable amount of tally. The transect begins at 14 feet (slope distance) from the subplot center and extends out either 6 or 10 feet (slope distance) depending on the FWD size class, as follows:

Category of FWD	Size Class	Diameter range	Transect length (slope distance)	Transect location (slope distance)
Small FWD	1	.01 in. to .24 in.	6 feet	14 to 20 feet
Medium FWD	2	0.25 in. to .9 in.	6 feet	14 to 20 feet
Large FWD	3	1.0 in. to 2.9 in.	10 feet	14 to 24 feet

Note that the FWD transects are slope distance not horizontal distance. The formulas used to estimate biomass from the data contain an adjustment for slope.

It is helpful to have a size gauge available until your eye is 'trained' to recognize the 3 size classes. Examples include a plastic or cardboard card with 3 notches cut for each size class, or a set of 3 dowels representing each size class.

LINE TRANSECT LAYOUT FOR SAMPLING CWD AND FWD ON THE PLOT

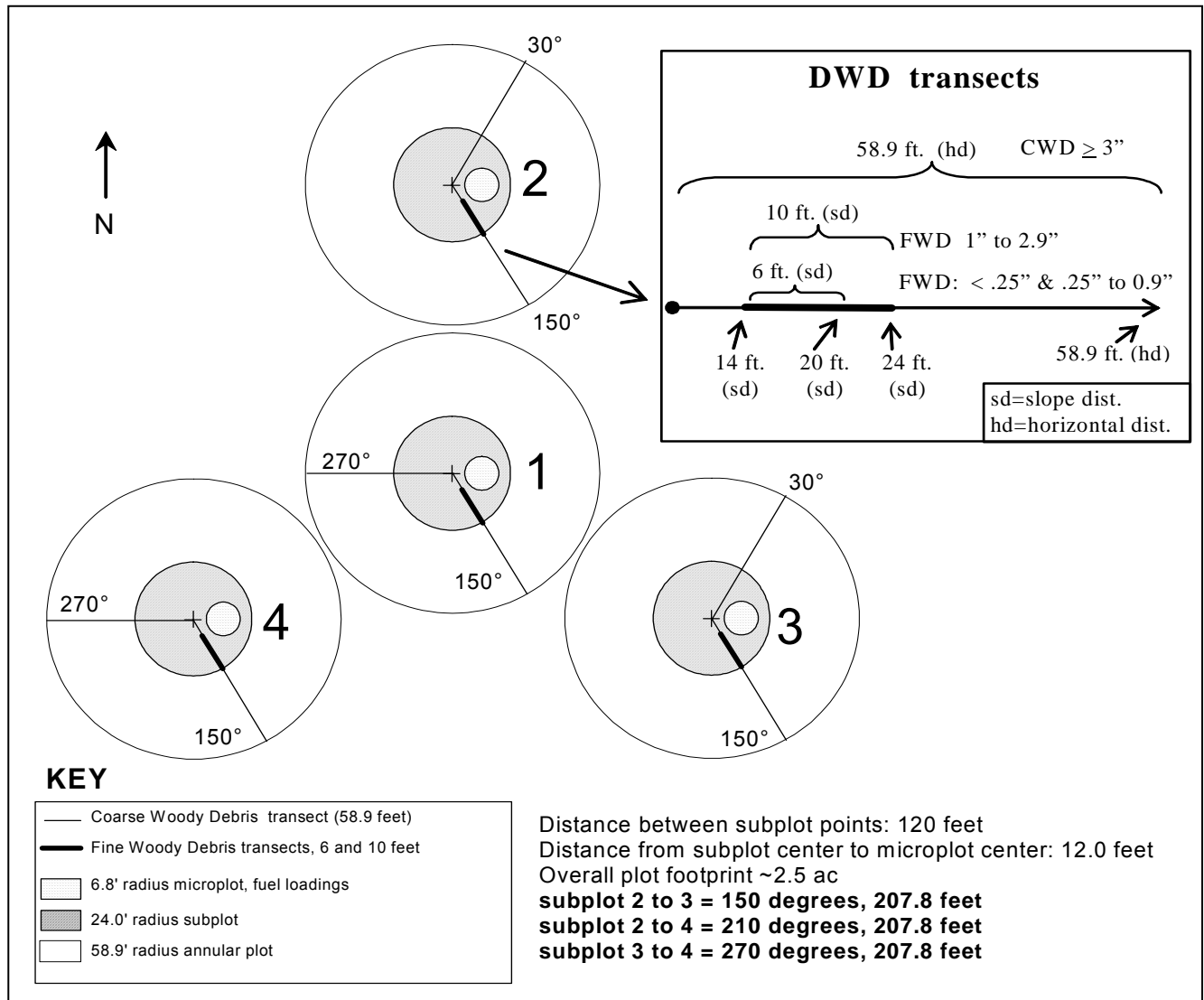

D. Transect line segmenting

Transect lines are segmented to determine the length of transect that occurs within each mapped condition class intersecting the line. A segment is a length of transect that is in one condition. Segments are identified by recording the beginning distance and ending distance of the slope from subplot center out to the end of the annular plot. In the office, the segmenting data will be combined with CWD distances to determine which condition class each piece falls in (condition classes are not assigned to CWD pieces in the field). If more than one condition is found on the FWD transects, the segmenting information recorded here, will provide the length of transect in each condition.

Starting at the subplot center and working towards the fixed radius plot boundary, each segment of transect line in a different condition class is delineated and recorded as a separate record. On each record, the beginning distance and ending distance of the slope are recorded for each condition class encountered. The first record for each transect will have a beginning distance (DIST1) of 0 feet. If only one condition class occurs on the transect line, only one segment is recorded. The transect must extend a total of 58.9 feet horizontal distance. If the entire 58.9-foot subplot is nonforest, enter codes for SUBPLOT NUMBER, TRANSECT, CONDITION CLASS NUMBER, followed by zeros in the remaining fields (see Appendices 1 & 3 for special rules about nonforest plots/condition classes on R5 and R6 NFS lands).

On subplots where a transect intersects a boundary between condition classes, the transect continues across the boundary into the adjacent class. **All condition class boundaries (beginning and ending distances) are recorded on each transect.**

Individual pieces of DWM intersected by a transect are tallied or counted if they meet the tally rules for CWD or FWD specified in the sections that follow. It is expected that the majority of FWD transects will be in one condition, but if the condition class changes along the transect, a count is recorded for each condition. Again, the segmenting data recorded here will identify which condition class is associated with each count.

Transects are installed across condition class boundaries :

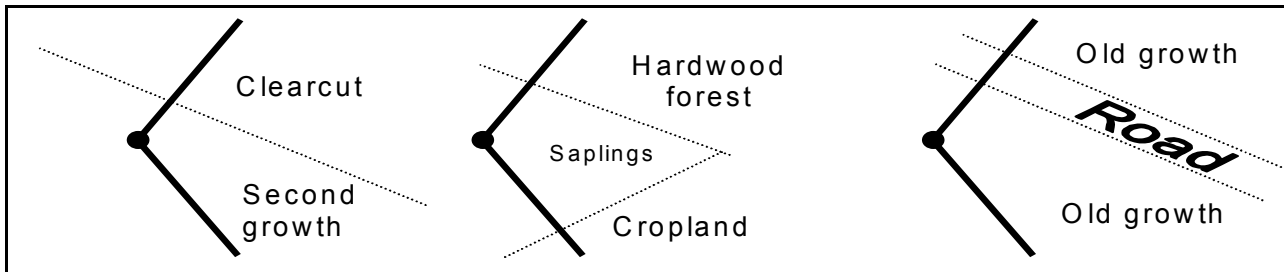

Item 1--SUBPLOT NUMBER

Record the code indicating the subplot center from which the transect originates.

Field width: 1 digit
Tolerance: No errors
Values: 1 to 4

1	Center subplot
2	North subplot
3	Southeast subplot
4	Southwest subplot

Item 2--TRANSECT

Record the code indicating the transect on which a condition class is being delineated. The three transects used are 30 degrees, 150 degrees, and 270 degrees. These transects, when being installed, have a tolerance of +/- 2 degrees.

When Collected: All tally segments
Tolerance for the code: No errors
Tolerance for the azimuth : +/- 2 degrees
Values:

Code	Azimuth tolerance	Definition
030	30 degrees +/- 2 degrees	Transect extends 30 degrees from subplot center
150	150 degrees +/- 2 degrees	Transect extends 150 degrees from subplot center
270	270 degrees +/- 2 degrees	Transect extends 270 degrees from subplot center

Item 3--CONDITION CLASS NUMBER

Record the code indicating the number of the condition class for the transect segment. Use the same code used for CONDITION CLASS NUMBER on page 65. The first segment recorded for each transect will have the same CONDITION CLASS NUMBER as assigned to the subplot center.

Tolerance: No errors

Item 4--BEGINNING DISTANCE

Beginning at subplot center, record the slope distance along the transect line where the transect intersects the boundary with the adjacent condition class nearer to the subplot center. The first record for each transect will have a Beginning Distance of 0.0 ft. Each subsequent record will have a Beginning Distance equal to the Ending Distance of the previous record. Record to the nearest 0.1 foot.

Tolerance: +/- 1.0 ft.
Values: 00.0 to 99.9

Item 5--ENDING DISTANCE

Record the slope distance along the transect line where the transect exits the condition class segment being delineated and intersects the boundary with a different condition class further away from the subplot center. If no other condition classes are encountered, record the slope distance on the transect line to the edge of the annular plot. Record to the nearest 0.1 foot.

Tolerance: +/- 1.0 ft.
Values: 00.1 to 99.9

Item 6--SLOPE PERCENT

Record the code indicating the average slope percent along the transect within the condition class being segmented. When only one condition class is present on a transect, slope percent is the average slope percent along the entire transect. Measure to the nearest 5%.

Tolerance: +/- 10%
Values: 005 to 155

E. Sampling Methods for coarse woody debris (CWD)

1. Coarse woody debris (CWD) is sampled in accessible forest land conditions only. Tally a piece if its central longitudinal axis intersects the transect, and the condition class is accessible forest land at the point of intersection. The entire piece is assigned to this condition class.

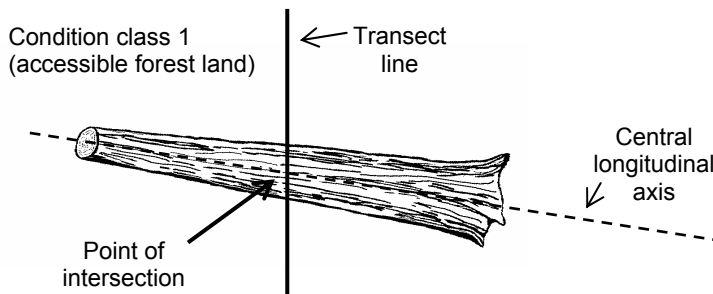

2. Tally dead trees IF they are leaning > 45 degrees from vertical. Do not tally live trees or standing dead trees and stumps that lean < 45 degrees from vertical. Most CWD will be lying on the ground.
3. The minimum length of any tally piece is 3.0 feet. When CWD pieces are close to 3 feet, measure the length to the nearest 0.1 foot to determine if it is ≥ 3.0 feet.
4. Decay class of the piece determines whether or not the piece is tallied.

For decay classes 1 to 4: tally a piece if it is ≥ 3.0 inches in diameter at the point of intersection with the transect. The piece must be ≥ 3.0 feet in length and ≥ 3.0 in. or more in diameter along that length. If the intersect diameter is close to 3.0 inches, measure the diameter to the nearest 0.1 in. to determine if the piece qualifies.

For decay class 5: tally a piece if it is ≥ 5.0 inches in

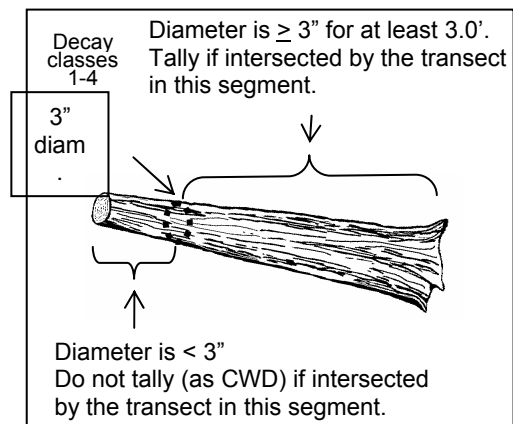

diameter at the point of intersection and ≥ 5.0 inches high from the ground. The piece must be ≥ 3.0 feet in length and ≥ 5.0 in. or more in diameter along that length. The reason for treating decay class 5 pieces differently is because they are difficult to identify, especially when heavily decomposed. Only pieces that still have some shape and log form are tallied—humps of decomposed wood that are becoming part of the duff layer, are not tallied.

5. Tally pieces created by natural causes (examples: natural breakage or uprooting) or by human activities such as cutting only if not systematically machine-piled. Do not record pieces that are part of machine-piled slash piles or windrows, or that are part of a log "jumble" at the bottom of a steep-sided ravine in which individual pieces are impractical to tally separately. Instead, sample these piles according to instructions on "Sampling residue piles" (see page 209). A slash pile or windrow consists of broken logs, limbs, and other vegetative debris.
6. Tally a piece only if the point of intersection occurs above the ground. If one end of a piece is buried in the soil, the piece ends at the point where it is no longer visible. Measure the diameter and length at this point.
7. If the central longitudinal axis of a piece is intersected more than once on a transect line or if it is intersected by two transect lines, tally the piece each time it is intersected (uncommon situation).

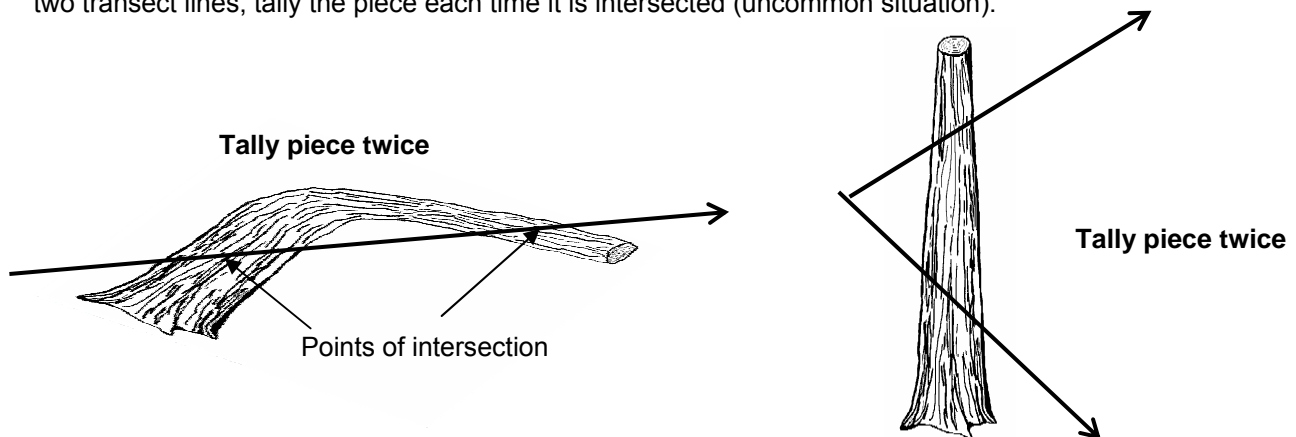

8. Tally a piece only once if the subplot center falls directly on the central longitudinal axis of the piece. Tally the piece on the 30 degree transect on subplots 2 and 3, and on the 150 degree transect on subplots 1 and 4. Record the CWD Distance as 001.
9. If a piece is fractured across its diameter or length, and would pull apart at the fracture if pulled from either end or sides, treat it as two separate pieces. If judged that it would not pull apart, tally as one piece. Tally only the piece intersected by the transect line.
10. Do not tally a piece if it intersects the transect on the root side of the root collar. Do not tally roots.
11. When the transect crosses a forked down tree bole or large branch connected to a down tree, tally each qualifying piece separately. To be tallied, each individual piece must meet the minimum diameter and length requirements.
12. In the case of forked trees, consider the "main bole" to be the piece with the largest diameter at the fork. Characteristics for this fork such as length and decay class should pertain to the entire main bole. For smaller forks, or branches connected to a main bole (even if the main bole is not a tally piece) characteristics pertain only to that portion of the piece up to the point where it attaches to the main bole (see diagram below).
13. If a transect intersects a nonforest condition (e.g., a road), no CWD is tallied (see Appendices 1 & 3 for special rules about nonforest plots/condition classes on R5 and R6 NFS lands).

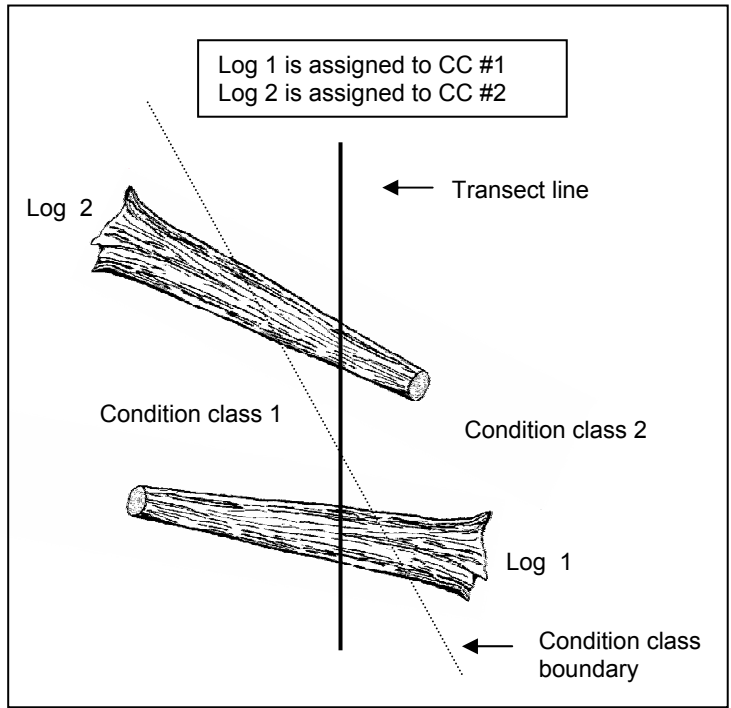
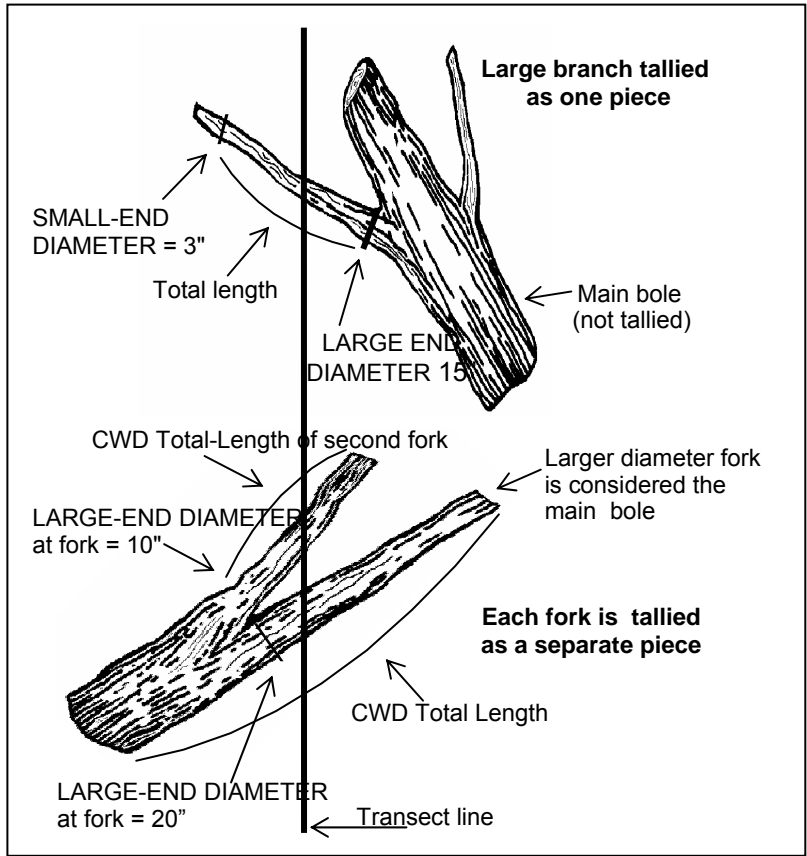

Note Crews do not actually record a condition class for each piece. The computer 'assigns' the piece to a condition class by comparing the recorded distance to the piece with the beginning and ending distances recorded for each condition class boundary.

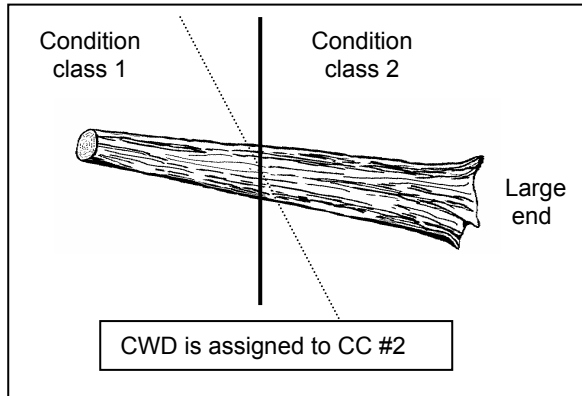

For example:
Slope distance to the point of intersection and the beginning boundary of condition class #2 is 15 feet.
The large end is in CC#2, so... record the CWD DIST as 15.1 feet.
This forces the CWD piece into CC#2.

F. Marking CWD

Marking CWD is optional. Marked CWD is an aid to future crews returning to the plot for a QA check or to remeasure the plot at the next remeasurement period. Nails can be used to mark the location of the point of intersection, if the piece is in decay class 1, 2, or 3. Position the nail on top of the piece, and if possible, drive the nail into the piece so that about 1 inch of the nail is left exposed. Please see the section on Transect Segmenting, for information on the required marking of the transect line.

G. Recording procedures for CWD

The tolerance for the total number of pieces (≥ 3 inches, transect diameter) tallied across all transects on the plot is : +/- 2 piece or +/- 5%, whichever is greater for the plot. Note: always round up to a whole piece count when using the 5% option.

Item 1--SUBPLOT NUMBER

Record the code indicating the number of the subplot center from which the transect originates.

When collected: All tally pieces
Field width: 1 digit
Tolerance: No errors
Values: 1 to 4

1	Center subplot
2	North subplot
3	Southeast subplot
4	Southwest subplot

Item 2--TRANSECT

Record the code indicating the azimuth of the transect on which the piece is sampled.

When Collected: All tally pieces
Tolerance: No errors
Values:

030	Transect extends 30 degrees from subplot center
150	Transect extends 150 degrees from subplot center
270	Transect extends 270 degrees from subplot center

Item 3--CWD SLOPE DISTANCE

Record the code indicating the slope distance from the subplot center to the point where the transect intersects the longitudinal center of the piece. If two or more pieces have the same slope distances, record the top piece first. Measure and record to the nearest 0.1 feet. CWD slope distance is an important item because it will be used to assign the CWD piece to a condition class by comparing the recorded distance to the piece with the

Annual Inventory 2004
DOWN WOODY MATERIALS

recorded beginning distance and ending distance to the condition class boundary. CWD slope distance is also used to locate the piece for remeasurement in future inventories.

When Collected: All tally pieces
Tolerance: +/- 1.0 ft.
Values: 00.1 to 99.9

Item 4--CWD DECAY CLASS

Record a 1-digit code indicating the decay class of the piece. Code the decay class which predominates along the recorded CWD TOTAL LENGTH of the piece. Use the guide below to determine CWD DECAY CLASS.

When Collected: All tally pieces
Field width: 1 digit
Tolerance: +/- 1 class
Values:

Decay Class	Structural Integrity	Texture of Rotten Portions	Color of Wood	Invading Roots	Branches and Twigs
1	Sound, freshly fallen, intact logs	Intact, no rot; conks of stem decay absent	Original color	Absent	If branches are present, fine twigs are still attached and have tight bark
2	Sound	Mostly intact; sapwood partly soft (starting to decay) but can't be pulled apart by hand	Original color	Absent	If branches are present, many fine twigs are gone and remaining fine twigs have peeling bark
3	Heartwood sound; piece supports its own weight	Hard, large pieces; sapwood can be pulled apart by hand or sapwood absent	Reddish-brown or original color	Sapwood only	Branch stubs will not pull out
4	Heartwood rotten; piece does not support its own weight, but maintains its shape	Soft, small blocky pieces; a metal pin can be pushed into heartwood	Reddish or light brown	Through-out	Branch stubs pull out
5	None, piece no longer maintains its shape, it spreads out on ground	Soft; powdery when dry	Red-brown to dark brown	Through-out	Branch stubs and pitch pockets have usually rotted down

Note: CWD DECAY CLASS 5 pieces can be difficult to identify because they often blend into the duff and litter layers. They must still resemble a log, therefore, the first tally rule is that they must be > 5.0 inches in diameter, > 5.0 inches from the surface of the ground, and at least 3.0 feet long. Decomposed logs that are slightly elevated 'humps' on the ground are not tallied.

CWD DECAY CLASS: The chart above was developed primarily for Douglas-fir in the Pacific Northwest. At the present time, there are no other charts available to use to describe decay classes for other species or locations. Concentrate on the structural integrity and texture when estimating a decay class for CWD logs.

If a log is case hardened (hard, intact outer sapwood shell) but the heartwood is rotten, code this log as a CWD DECAY CLASS 2 with a HOLLOW PIECE code of 1. CWD DECAY CLASS 1 should be reserved for 'freshly fallen' logs that are completely intact (i.e., recent windfalls, or harvest).

Item 5--SPECIES

Record the code indicating the species of the piece. Species codes are the same as those used in P2 (see page 157). Because CWD includes the tally of qualifying shrub boles, **enter a code of '0001' for SPECIES if the tally piece is a shrub or vine.**

Species identification may be uncertain for some pieces. The piece's bark (either attached or sloughed and laying beside the piece), branching pattern (if the branches are still present), or heartwood smell (particularly if cedars, Douglas-fir, or western hemlock) may provide clues. On remeasurement plots, see what tree species were tallied in past inventories. One way to distinguish hardwoods from softwoods is by the type of decay present. Hardwoods usually have a white or grayish stringy rot, while softwoods usually have a reddish-brown blocky rot. If it's not possible to identify the species, attempt to determine if it is a softwood or hardwood. Enter code 0299 for unknown conifer or 0998 for unknown hardwood. If all else fails, enter the unknown species code (0999).

When Collected: CWD Decay Class 1 to 4 tally pieces
Field width: 4 digits
Tolerance: No errors
Values: See APPENDIX 7 -- TREE SPECIES LISTS

Diameters

The diameter is most commonly measured by holding a tape above the log, at a position perpendicular to the length. It is useful to carry a steel carpenters retracting tape to measure diameters. Other methods include wrapping a tape around the bole if possible, holding a straight-edge ruler above the piece, or using calipers.

For pieces that are not round in cross-section because of missing chunks of wood or "settling" due to decay, measure the diameter in two directions and take an average. Estimate the longest and shortest axis of the cross-section ("A" and "B" in the diagram below), and enter the average in the diameter field. This technique applies to intersect, small-end, and large-end diameters.

If the transect intersects the log at the decayed or splintered end (i.e. the portion where it is not considered part of the log because it's falling apart), record the diameter at this location as the intersect diameter, but record the large end and small end diameter according to established rules (i.e. at the points where they best represent the log volume). If the splintered end appears to be two separate pieces (i.e. a major split located just at the end) treat it as one log and take a diameter around the end (take two measurements if it is odd shaped). Length is measured between the large and small end diameters.

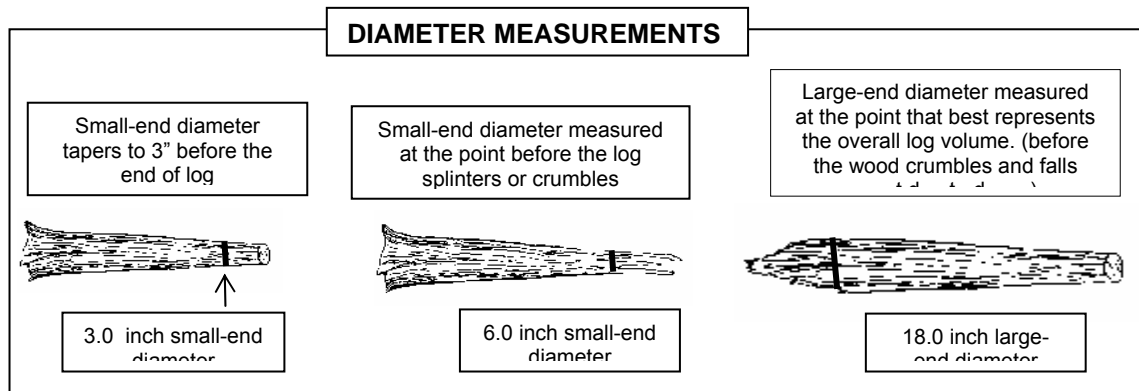
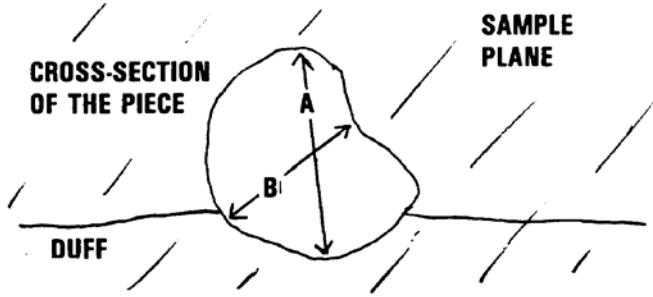

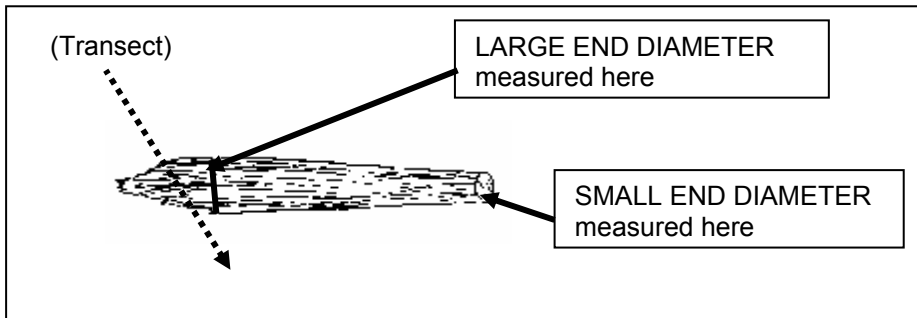

Item 6 -DIAMETER AT POINT OF INTERSECTION

Record the code indicating the piece's diameter at the point where the transect intersects the longitudinal center of the piece. If the diameter is close to 3 inches, measure the diameter to the nearest 0.1 inch to determine if the piece is actually ≥ 3.0 inches and a valid tally piece. The diameter is recorded to the nearest inch.

When Collected: All tally pieces

Tolerance: No errors on whether or not a piece is to be tallied

Pieces < 20.0 in. diameter: ± 3.0 in.

Pieces ≥ 20.0 in. diameter: $\pm 20\%$

Values: 003 to 200

Item 7--DIAMETER AT THE SMALL END

Record the code indicating the diameter at the piece's small end. The diameter is recorded to the nearest inch. The diameter at the small end occurs either at 1) the actual end of the piece, if the end has a diameter ≥ 3.0 inches, or 2) at the point where the piece tapers down to 3.0 inches in diameter. If the end is splintered or decomposing (sloughing off), measure the diameter at the point where it best represents the overall log volume. Use the same measuring procedures described in Item 5 (see diagram below).

When Collected: CWD Decay Class = 1 to 4

Tolerance Pieces < 20.0 in. diameter: ± 2.0 in.

Pieces ≥ 20.0 in. diameter: $\pm 10\%$

Values: 3 to 200

Item 8--DIAMETER AT THE LARGE END

Record the code indicating the diameter at the piece's large end. The diameter is recorded to the nearest inch. The large end will occur either at a broken or sawn end, at a fracture, or at the root collar. If the end is splintered or decomposing (sloughing off), measure the diameter at the point where it best represents the overall log volume. Use the same measuring procedures used for Item 5.

When Collected: CWD Decay Class = 1 to 4

Tolerance: Pieces < 20.0 in. diameter: ± 2.0 in.

Pieces ≥ 20.0 in. diameter: $\pm 15\%$

Values: 3 to 200

Item 9—CWD TOTAL LENGTH

Record the code indicating the total length of the piece. CWD total length is the length of the piece that lies between the piece's recorded small and large end diameters (Items 7 & 8). For Decay Class 5, small and large end diameters are not recorded for a log, therefore the length is measured between the two physical ends of the log. For curved logs, measure along the curve. The minimum log length is 3.0 feet before it is a valid tally log. CWD total length is recorded to the nearest foot.

When Collected: All tally pieces

Tolerance: + / - 20%
Values: 3 to 250

Item 10--HOLLOW

Record the code indicating whether or not the piece is hollow (see diagram below). A piece is considered hollow if a cavity extends at least 2 feet along the central longitudinal axis of the piece, and the diameter of the entrance to the cavity is at least 1/4 of the diameter of the piece where the entrance occurs. The entrance occurs at the point where wood is present completely around the circumference of the cavity. The length of the cavity begins at this point

When Collected: All CWD Decay Class = 1 to 4
Tolerance: No errors
Values:

Code	Definition
0	A piece is considered hollow if a cavity extends at least 2 feet along the central longitudinal axis of the piece, and the diameter of the entrance to the cavity is at least 1/4 of the diameter of the piece where the entrance occurs. The entrance occurs at the point where the circumference of the cavity is whole -- the point where wood is present completely around the circumference of the cavity. The length of the cavity begins at this point.
1	Does meet criteria for being a hollow log

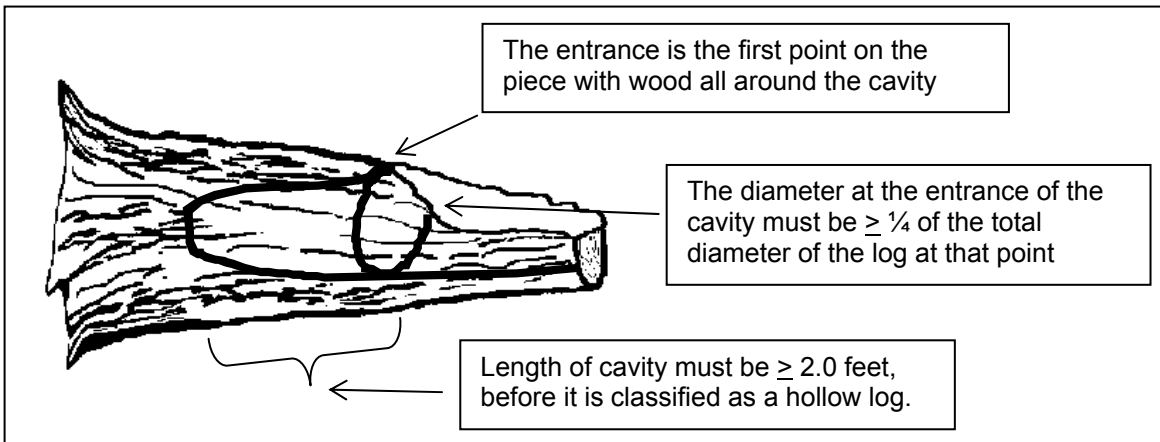

Item 11--Percent of log charred by fire (CHARR)

Record a 1-digit code that represents the percentage of the log's surface area that has been charred by fire. Only examine the visible surface of the log. This data will be used by wildlife biologists to determine the impact fire has had on wildlife habitat. Wildlife tend to avoid charred logs because fire seals the wood making it slow to rot and hard to excavate.

When Collected: All tally pieces ≥ 20 in. Transect Diameter and Decay Class 1, 2 or 3
When Special Study 2004 **Error! Reference source not found.** (B & B burn areas) = Y:
All tally pieces ≥ 3.0 in. Transect Diameter and Decay Class 1, 2, 3, 4

Tolerance: +/- 1 class
Values:

Code	Definition
0	None of the log is charred by fire
1	Up to 1/3 of the log is charred by fire
2	1/3 to 2/3 of the log is charred by fire
3	2/3 or more of the log is charred by fire

Item 12--CWD history

Record the code that indicates whether or not the piece of CWD is on the ground as a result of harvesting operations or as a result of natural circumstances. One objective of this Item is to identify those pieces that are considered logging residue. If the piece appears to have fallen to the ground as a result of natural causes such as decomposition or windfall, enter a code of 1. This category would include blown out tops, snapped off boles, wind-fallen trees on clearcut edges, and trees that basically collapsed and fell over due to decomposition.

If the piece is on the ground as a result of RECENT (since last annual remeasurement; if the plot is new, the time between the panel remeasurements) harvesting activity, either because the tree was cut down with a chainsaw (or other device) or pushed over by harvesting equipment (bulldozer), enter a code of 2. A code of 2 would be considered logging residue (usually in a recent clearcut).

If the piece is on the ground as a result of OLDER (more than 15 years) harvesting activity, enter a code of 3. This would be a situation where you tally an old decomposing log that has a sawn end – if it appears that the log was cut and left on site, then enter a code of “3”.

If a piece is on the ground as a result of incidental harvest (such as a standing tree was cut for firewood or small clearing), enter a code of “4”. Incidental harvest involves a few trees and is not a part of a major organized harvesting operation.

If the crew cannot decide the history of the CWD log, classify it as “unknown”, and record code of “5”.

When Collected: CWD Decay Class = 1 to 4

Tolerance: No errors

Values:

Code	Definition
1	CWD piece is on the ground as a result of natural causes
2	CWD piece is on the ground as a result of major RECENT harvest activity (<=15 yrs old)
3	CWD piece is on the ground as a result of OLDER harvest activity (>15 yrs old)
4	CWD piece is on the ground as a result of an incidental harvest (such as firewood cutting)
5	Exact Reason Unknown

H. Sampling methods for fine woody debris (FWD)

Fine Woody Debris (FWD) is only sampled in accessible forest conditions intersected by the transect. The length of FWD transects are measured in slope distance--no correction is applied to obtain a horizontal distance. The FWD transects start at 14 feet slope distance and extend for 6 or 10 feet slope distance. Estimates of FWD biomass calculated in the office, will include a slope correction factor obtained from the transect segmenting data on the subplot.

Only sample FWD that intersects the transect from the ground to a height of 6 feet.

FWD is sampled in three size classes, on the 150 degree azimuth transect. Two of the FWD size classes (0.01 to 0.24 inches and 0.25 to 0.9 inches) are counted on a 6 foot transect, from 14 to 20 feet. Pieces in the third size class (1.0 to 2.9 inches) are counted on a 10 foot transect, from 14 to 24 feet (see Section D for details on transects). These transects overlap. Note: individual diameters are not recorded for FWD. Only count a piece of FWD if it intersects the transect, and if the twig, branch, wood fragment (splinters), or shrub/tree bole are woody. Do not count conifer needles or non-woody parts of a tree or shrub. Do not count rotted pieces of a larger log.

Accumulate the number of pieces counted within each size class and enter the total count on one record for the subplot (unless there are >1 condition classes). If there is no tally on a transect, enter zero's for the count. Count only what can be seen from a “bird's-eye view”; do not dig under any litter or debris to count pieces not normally seen.

Accurate counts of FWD can be conducted efficiently up to about 50 pieces for small and medium size classes, and up to 20 pieces for the large size class. After that, crews can begin estimating counts in a systematic fashion.

Annual Inventory 2004
DOWN WOODY MATERIALS

Transects that fall on very dense FWD where counting is nearly impossible, can be subsampled and calculated. For example, an accurate count can be conducted on a 2.0 foot-section of the transect and then multiplied by 3 to provide an estimate for the 6 foot transect, as long as the crew feels that the remaining transect has a similar density of FWD pieces.

If a transect intersects a large pile of material such as a wood rat's nest or a recently fallen tree (with many attached fine branches), crews should estimate a count based on Item 5 above, but also enter a code indicating that this is an unusual situation (see HIGH COUNT REASON below).

If rocks, logs, or other obstructions are present along the transect (14 to 24 foot section) include any FWD that is present on top of these obstructions in the respective FWD counts. If the obstructions are so large (huge boulder) that the top surface cannot be seen, assume the count is Zero in this area, and continue counting if there is transect line beyond the boulder.

If a residue pile intersects the FWD transect **at any point** along the 14 to 24 foot section, **do not measure FWD on this transect**. It is too subjective determining exact boundaries of the pile, and how they relate to the exact point on the transect line. To identify this situation, code 1 in RESIDUE PILE ON TRANSECT which indicates that a residue pile has intersected the transect line.

If a transect crosses a condition class boundary, record the condition class number and enter a count for each condition on separate records. Transect lengths within each condition class will be obtained from the transect segmenting data entered for the subplot.

Item 1--SUBPLOT NUMBER

Record the code indicating the subplot center from which the transect originates.

When collected: All tally segments
Field width: 1 digit
Tolerance: No errors
Values: 1 to 4

1	Center subplot
2	North subplot
3	Southeast subplot
4	Southwest subplot

Item 2--CONDITION CLASS NUMBER

Record the code indicating the number of the condition class that pertains to the FWD count.

When collected: All tally segments
Field width: 1 digit
Tolerance: No errors
Values: 1 to 9

Item 3--SMALL FWD COUNT

Record the number of pieces counted in this size class (0.01 to 0.24 inch diameter) along the transect segment. An accurate count should be conducted up to 50 pieces. If the count exceeds 50, the transect can be subsampled to estimate a total count for the transect segment.

When collected: On the 150 degree transect in CONDITION CLASS STATUS = 1
Field width: 3 digits
Tolerance: 0 to 50 +/- 20% of the total count for the transect
Tolerance: 51 to 100 +/- 25% of the total count for the transect
Tolerance: 100 + +/- 50% of the total count for the transect (Item 6 should have a code > 0)
Values: 000 to 999

Item 4--MEDIUM FWD COUNT

Annual Inventory 2004
DOWN WOODY MATERIALS

Record the number of pieces counted in this size class (0.25 TO 0.9 inch diameter) along the transect segment. An accurate count should be conducted up to 50 pieces. If the count exceeds 50, the transect can be subsampled to estimate a total count for the transect segment.

When collected: On the 150 degree transect in CONDITION CLASS STATUS = 1
Field width: 3 digits
Tolerance: +/- 20% of the total count for the transect
Values: 000 to 999

Item 5--LARGE FWD COUNT

Record the number of pieces counted in this size class (1.0 to 2.9 inch diameter) along the transect segment. An accurate count should be conducted up to 20 pieces. If the count exceeds 20, the transect can be subsampled to estimate a total count for the transect segment.

When collected: On the 150 degree transect in CONDITION CLASS STATUS = 1
Field width: 3 digits
Tolerance: +/- 20% of the total count for the transect
Values: 000 to 500

Item 6--HIGH COUNT REASON

Enter the appropriate code when the count on a transect exceeds 100 pieces.

When Collected: When any count on the transect ≥ 100
Field width: 1 digit
Tolerance: No errors
Values:

Code	Definition
0	FWD is not unusually high
1	High count is due to an overall high density of FWD across the transect
2	Wood Rat's nest located on transect
3	Tree or shrub laying across transect
4	Other reason

Item 7--RESIDUE PILE ON TRANSECT

Enter a code that indicates whether a residue pile intersects the FWD transect segment. The default is always 0; crews will enter a 1 if the situation is encountered on the transect.

When Collected: On all FWD transects (between 14 and 24 feet)
Tolerance: No errors
Values:

0	There is no residue pile on the transect
1	There is a residue pile on the transect

I. Duff, litter, and fuelbed depth measurements

Depth measurements are sampled in accessible forest land conditions. The depth of the duff layer, litter layer, and overall fuelbed are important components of fire models used to estimate fire behavior, fire spread, fire effects, and smoke production. These measurements are taken at the 24 ft. location on each transect. Mark the location that depth measurements are taken with a small piece flagging. An average depth will be calculated in the office and stored with other information about the condition class on the plot. **If a residue pile intersects the transect at the 24 ft location, do not measure the duff or litter depth. But, DO measure the fuelbed depth.**

Definitions:

1. Litter is the layer of freshly fallen leaves, needles, twigs (< 0.25 inch in diameter), cones, detached bark chunks, dead moss, dead lichens, detached small chunks of rotted wood, dead grasses, herbaceous stems and flower parts (detached and not upright). Litter is the loose plant material found on the top surface of the forest floor. Little decomposition has begun in this layer.

Annual Inventory 2004
DOWN WOODY MATERIALS

Litter is flash fuel – so think about it as the loose material that is exposed to the air, capable of igniting quickly and carrying a fire across the surface of the forest floor.

Litter does not include bark that is still attached to a down log, or rotten chunks of wood that are still inside a decaying log or log end (i.e. if a decayed log end has a lot of rotten cubes or pieces laying on a log surface and exposed to air, they are considered part of the log and not litter – fire would burn differently if it hit a pile of rotten punky wood chips, cradled by the unrotted sapwood shell). If these rotten chunks have spilled out to the ground and are actually on the ground surface, then they would be included in the litter layer.

Litter does not include animal manure.

Microplot estimates: Litter is the material that can be seen on the surface of the forest floor; it does not include litter underneath a log or other obstruction.

2. Duff is the layer just below litter. It consists of decomposing leaves and other organic material. You should see NO recognizable plant parts, the duff layer is usually dark decomposed organic matter. When moss is present, the top of the duff layer is just below the green portion of the moss. The bottom of this layer is the point where mineral soil (A horizon) begins.
3. The fuelbed is the accumulated mass of dead, woody material on the surface of the forest floor. It begins at the top of the duff layer, and includes litter, FWD, CWD, and dead woody shrubs. In this definition, the fuelbed does not include dead hanging branches from standing trees or standing dead seedlings or saplings.

Overview of Measurements:

Depth measurements will be taken at the 24 foot (slope distance) location on each transect: If a log, rock or other obstruction occurs at the sample location do not measure duff or litter depth, regardless of what is on top of the obstruction. However, if the obstruction is a log, proceed with the fuelbed depth estimate.

The DUFF, LITTER, AND FUELBED SAMPLE variable has three options for indicating if duff, litter, and/or fuelbed were measured at each sample location. The default value for this variable is 1, indicating that all three variables were measured (duff, litter, and fuelbed). A value of 0 is entered if duff and litter were not sampled (obstruction), but fuelbed was sampled. A value of 2 is entered if none of the three (duff, litter, and the fuelbed) were sampled (i.e., submerged part of plot).

Duff and Litter:

The duff layer is the organic material layer between the A-horizon (or uppermost soil mineral horizon) and the litter layer. The duff is a soil layer dominated by organic material derived from the decomposition of plant and animal litter (pine straw, leaves, twigs, etc) and deposited on either an organic or a mineral surface. This layer is distinguished from the litter layer in that the original organic material has undergone sufficient decomposition that the source of this material (e.g., individual plant parts) can no longer be identified. Litter is defined as undecomposed or only partially decomposed organic material that can be readily identified (e.g., plant leaves, twigs, etc.). As a general rule, duff depth should rarely exceed a few inches. Crews should be absolutely sure they are measuring deep duff depths, instead of mineral soil layers or parts of the litter layer. Duff can easily weigh more than 6 times that of litter. If unsure of the bottom of the duff layer, crews should feel the texture of the suspect material in their hand. Rub the soil between your finger. Does it crumble (duff) or feel more like modeling clay (mineral).

Carefully expose a shallow profile of the forest floor by digging out an area at the sample point using a knife, hatchet, or other tool. Estimate the depth of each layer with a ruler to the nearest 0.1 inch. If there is a log, rock, or other obstruction on the surface at the sample point, do not measure the litter or duff depth (record DUFF, LITTER, AND FUELBED SAMPLE = N) ; a value of 99.9 will be entered by the program for each depth.

As you dig the hole for this measurement, if you encounter a rock, root, or buried log – stop the depth measurement at this point.

Annual Inventory 2004
DOWN WOODY MATERIALS

The height of the litter should be measured at the top of the loose material located at the sample point on the transect. Try to preserve the conditions of this location by walking around this point, so the QA staff will measure the same height as the original crew.

Fuelbed:

Measure the height of the fuelbed from the top of the duff layer (just below the litter) to the highest piece of woody debris found at the transect point. Round to the nearest 0.1 foot. If a rock or other obstruction occurs at the 24.0 foot sample location, do not measure fuelbed depth. Logs are not considered an obstruction to Fuelbed measurements.

Item 1--SUBPLOT NUMBER

Record the code indicating the number of the subplot center from which the transect originates.

When collected: All tally segments
Field width: 1 digit
Tolerance: No errors
Values: 1 to 4

- 1 Center subplot
- 2 North subplot
- 3 Southeast subplot
- 4 Southwest subplot

Item 2--TRANSECT

Record the code indicating the azimuth of the transect.

When collected: All tally segments
Field width: 3 digits
Tolerance: No errors
Values:

- 030 Transect extends 30 degrees from subplot center
- 150 Transect extends 150 degrees from subplot center
- 270 Transect extends 270 degrees from subplot center

Item 3--DUFF, LITTER, AND FUELBED SAMPLE

Record the code indicating if the depth of the duff and litter layer was measured.

When collected: At 24.0 ft on each transect
Field width: 1 digit
Tolerance: No errors
Values:

0	Duff and litter depth not sampled; Fuelbed is sampled
1	All sampled; Duff, litter, and fuelbed
2	Nothing sampled; Duff litter, fuelbed are not sampled

Item 4--DUFF DEPTH

Record the code indicating the depth of the duff layer to the nearest 0.1 inch.

When collected: At 24.0 ft on each transect
Field width: 3 digits
Tolerance: +/- 0.5 inch
Values: 00.0 to 99.9

Item 5--LITTER DEPTH

Record the code indicating the depth of the litter layer to the nearest 0.1 inch.

Annual Inventory 2004
DOWN WOODY MATERIALS

When collected: At 24.0 ft on each transect
Field width: 3 digits
Tolerance: +/- 0.5 inch
Values: 0 to 99.9

Item 6--FUELBED DEPTH

Record the code indicating the depth of the fuelbed layer, to the nearest 0.1 foot.
If the fuelbed depth is >0 and <= 0.1 foot enter 0.1 foot. In this situation finer depth resolution will be obtained from the duff and litter measurements.

When collected: At 24.0 ft on each transect
Field width: 3 digits
Tolerance: +/- 20%
Values: 00.0 to 99.9

J. Fuel loading on the Microplot

Another component of the total fuel loading on a plot is the biomass of live and dead understory material. The 6.8 foot radius microplot will be used to estimate the percent cover and height of live and dead shrubs, live and dead herbs (includes grasses) and litter. Fuel loading is estimated in accessible forest land conditions on the microplot. Enter one value for all forested conditions combined.

Shrubs are plants with woody stems, including woody vines. Herbs are non-woody herbaceous plants, but also include ferns, mosses, lichen, sedges, and grasses. Although many forbs and grasses will die by the end of the growing season, an estimate of live and dead biomass on a given date will help fire modelers predict the phenology of herbaceous material during the year, allowing them to estimate fire danger patterns across the landscape.

Microplot fuel loading is only sampled if an accessible forest condition exists on the microplot. If the microplot is to be sampled, evaluate the entire area of the microplot, regardless of condition class boundaries that may be present.

Percent cover is estimated for each of the five fuel categories (live shrubs, dead shrubs, live herbs, dead herbs, and litter) in 10-percent classes for the accessible forested conditions of the microplot. For live fuels, estimate the percent of the microplot area that is covered by live plant material. Include whole plants that are entirely green (or alive) and the live branches on plants that are a mixture of live and dead plant parts. Include live branches or leaves that extend into the microplot area from a plant that is actually rooted outside of the microplot. **Do not include herbaceous material above 6 feet** (i.e. moss, ferns, lichens, epiphytes that are growing in tree branches above 6 feet).

For dead fuels, estimate the percent cover using the same procedures as live fuels, but include plants that are entirely dead and branches or leaves that are dead but still attached to a live plant. Dead plant material must be clearly visible. Do not include dead material that has fallen to the ground, or is detached and suspended. Cover estimates are made by visualizing an outline around the dead material (with all 'air' space included) and accumulating this across the forested microplot area.

An estimate of the height of the shrub and herbaceous layers is also needed to calculate biomass and fuel loadings. Record a height estimate for each fuel category, except litter. Height is estimated for the tallest shrub on the microplot.

Microplot Cover Estimation Guide (Hint: 8.5" x 11" = about 0.5% coverage)

%	area (sq ft)	radius (ft)	square (ft)
1	1.45	0.68	1.20
10	14.52	2.15	3.81
20	29.04	3.04	5.39
30	43.56	3.72	6.60
40	58.08	4.30	7.62
50	72.60	4.81	8.52
60	87.12	5.27	9.33

Annual Inventory 2004
DOWN WOODY MATERIALS

70	101.64	5.69	10.08
80	116.16	6.08	10.78
90	130.68	6.45	11.43
100	145.2	6.80	12.05

Item 1--SUBPLOT NUMBER

Record the code indicating the number of the subplot center from which the transect originates.

When collected: All microplots with at least one CONDITION CLASS STATUS = 1

Field width: 1 digit

Tolerance: No errors

Values: 1 to 4

1	Center subplot
2	North subplot
3	Southeast subplot
4	Southwest subplot

Item 2--LIVE SHRUB PERCENT COVER

Record the code for the cover class that indicates the percent cover of the forested microplot area covered with live shrubs.

When collected: All microplots with at least one CONDITION CLASS STATUS = 1

Field width: 2 digits

Tolerance: +/- 1 class

Values:

00	Absent
01	Trace (< 1% cover)
10	1 – 10%
20	11-20%
30	21-30%
....	
90	81-90%
99	91-100%

Item 3--LIVE SHRUB HEIGHT

Record the code indicating the height of the tallest shrub to the nearest 0.1 foot. Measure heights < 6 feet and estimate heights > 6 feet.

When collected: All microplots with at least one CONDITION CLASS STATUS = 1

Field width: 3 digits

Tolerance: +/- 0.5 feet

Values: 0 to 99.9

Item 4--DEAD SHRUBS PERCENT COVER

Record the code for the cover class that indicates the percent cover of the forested microplot area covered with dead shrubs and dead branches attached to live shrubs if visible from above.

Tolerance: +/- 1 class

Values:

00	Absent
01	Trace (< 1% cover)
10	1 – 10%

Annual Inventory 2004
DOWN WOODY MATERIALS

20	11-20%
30	21-30%
....	
90	81-90%
99	91-100%

Item 5--DEAD SHRUBS HEIGHT

Record the code indicating the height of the tallest dead shrub layer to the nearest 0.1 foot. Measure heights < 6 feet and estimate heights > 6 feet.

When collected: All microplots with at least one CONDITION CLASS STATUS = 1
Field width: 3 digits
Tolerance: +/- 0.5 feet
Values: 00.0 to 99.9

Item 6--LIVE HERBS PERCENT COVER

Record the code for the cover class that indicates the percent cover of the forested microplot area covered with live herbaceous plants.

When collected: All microplots with at least one CONDITION CLASS STATUS = 1
Field width: 2 digits
Tolerance: +/- 1 class
Values:

00	Absent
01	Trace (< 1% cover)
10	1 – 10%
20	11-20%
30	21-30%
....	
90	81-90%
99	91-100%

Item 7--LIVE HERBS HEIGHT

Record the code indicating the height (at the tallest point) of the live herbaceous layer to the nearest 0.1 foot. Maximum height is 6 feet.

When collected: All microplots with at least one CONDITION CLASS STATUS = 1
Field width: 2 digits
Tolerance: +/- 0.2 feet
Values: 0.0 to 6.0

Item 8--DEAD HERBS PERCENT COVER

Record a the for the cover class that indicates the percent cover of the forested microplot area covered with dead herbaceous plants and dead leaves attached to live plants if visible from above.

When collected: All microplots with at least one CONDITION CLASS STATUS = 1
Field width: 2 digits
Tolerance: +/- 1 class
Values:

00	Absent
01	Trace (< 1% cover)
10	1 – 10%
20	11-20%
30	21-30%
....	
90	81-90%

99	91-100%
----	---------

Item 9--DEAD HERBS HEIGHT

Record the code indicating the height (at the tallest point) of the dead herbaceous layer to the nearest 0.1 foot. Maximum height is 6 feet.

When collected: All microplots with at least one CONDITION CLASS STATUS = 1
Field width: 2 digits
Tolerance: +/- 0.2 feet
Values: 00.0 to 6.0

Item 10--LITTER PERCENT COVER

Record the code for the cover class that indicates the percent cover of the forested microplot area covered with litter. Litter is the layer of freshly fallen leaves, twigs, dead moss, dead lichens, and other fine particles of organic matter found on the surface of the forest floor. Decomposition is minimal.

When collected: All microplots with at least one CONDITION CLASS STATUS = 1
Field width: 2 digits
Tolerance: +/- 1 class
Values:

00	Absent
01	Trace (< 1% cover)
10	1 – 10%
20	11-20%
30	21-30%
...	
90	81-90%
99	91-100%

K. Sampling residue piles

The line transect method is not practical when sampling CWD within piles and windrows. Piles and windrows will be located and sampled on the 58.9-foot annular plot, regardless of whether they intersect a transect.

Piles and windrows created directly by human activity and log piles at the bottom of steep-sided ravines in which individual pieces are impossible to tally separately, are more efficiently sampled by using the following instructions. However, loose CWD in piles created by wind throw, landslides, fires, and other natural causes should be tallied using line transects (if this material intersects the established transects on the subplot) unless it is physically impossible to measure the pieces in the natural pile.

Selection instructions

For a pile to be tallied on a subplot that contains forest land, **all** of the following criteria must be met;

- The pile's center must be within 58.9 horizontal feet of subplot center.
- The pile's center must be in an accessible forestland condition class.
- The pile contains any pieces of CWD ≥ 3.0 inches that would be impossible to tally separately.

Use the PILE DENSITY variable to estimate the percent of the pile that contains woody material ≥ 3 inches.

The pile is assigned to the condition class in which the pile center lies.

Apply the following steps to determine the center of a pile or windrow:

1. Determine the longest axis of a pile.
2. Determine the midpoint of this axis.

Annual Inventory 2004
DOWN WOODY MATERIALS

3. Project a line through this midpoint that is perpendicular to the axis determined in step 1.
4. Determine the midpoint of the segment of this projected line that crosses the pile.
5. This is the center of the pile.

Piles that cross the 58.9-foot fixed-radius annular plot boundary: If the center of a pile is within 58.9 horizontal feet of subplot center, tally the pile, recording the dimensions of the entire pile even if part of the pile is beyond 58.9 feet. If the center of a pile is more than 58.9 horizontal feet of subplot center, do not tally the pile or any portion of the pile.

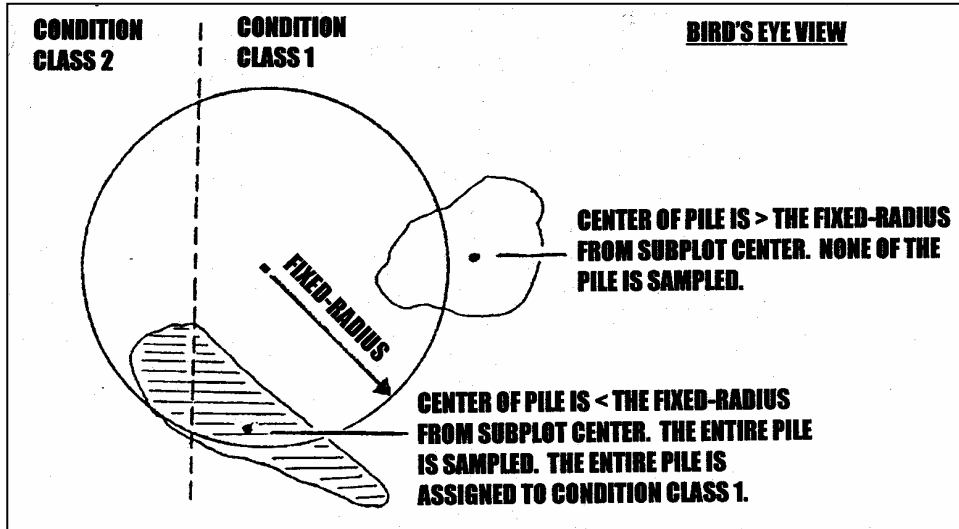

Item 1--SUBPLOT NUMBER

Record the code indicating the subplot number.

When collected: Record for all sampled residue piles
Field width: 1 digit
Tolerance: No errors
Values: 1 to 4

1	Center subplot
2	North subplot
3	Southeast subplot
4	Southwest subplot

Item 2--CONDITION CLASS

Record the code indicating the number of the condition class to which the pile is assigned. Use the same code used for CONDITION CLASS NUMBER on page 65.

When collected: Record for all sampled residue piles
Tolerance: No errors

Item 3--PILE AZIMUTH

Record the code indicating the azimuth from the subplot center to the pile center so that it can be relocated. Record 000 for subplots on which no piles are tallied. Use 360 for north.

When collected: All sampled residue piles
Tolerance: +/- 10
Values: 000, 1 to 360

Item 4--SHAPE

Record the code indicating the shape of the pile. Determine which of the four shapes diagrammed below most resembles the pile and record the dimensions. Pile dimensions should be ocularly smoothed out when making estimates. Average the unevenness of protruding pieces.

When collected: All sampled residue piles
 Tolerance: No errors

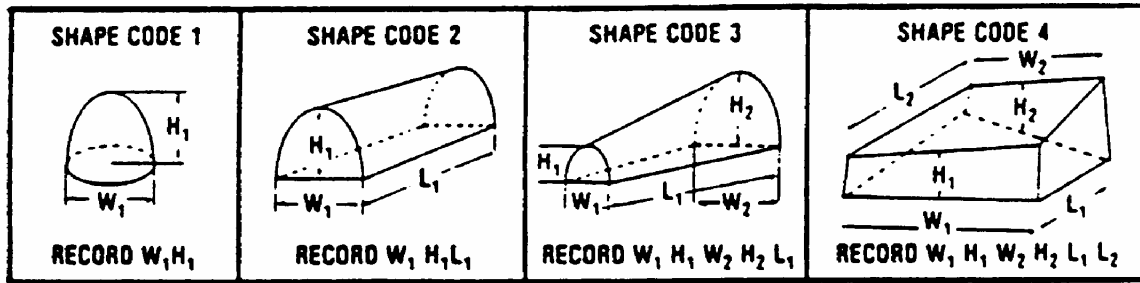

Item 5--PILE LENGTH 1

Record the code indicating the length of the sides of the pile. Estimate to the nearest foot. Pile length 1 may often equal pile length 2.

When collected: All sampled residue piles and SHAPE = 1, 2, 3, 4
 Tolerance: +/- 10%
 Values: 1 to 99

Item 6--PILE LENGTH 2

Record the code indicating the length of the sides of the pile. Estimate to the nearest foot. PILE LENGTH 1 may often equal PILE LENGTH 2.

When collected: All sampled residue piles and PILE SHAPE = 4
 Field width: 2 digits
 Tolerance: +/- 10%
 Values: 01 to 99

Item 7--PILE WIDTH 1

Record the code indicating the width of the sides of the pile. Estimate to the nearest foot. Pile width 1 may often equal pile width 2.

When collected: All sampled residue piles, and SHAPE=1, 2, 3, 4
 Tolerance: +/- 10%
 Values: 1 to 99

Item 8--PILE WIDTH 2

Record the code indicating the width of the sides of the pile. Estimate to the nearest foot. PILE WIDTH 1 may often equal PILE WIDTH 2.

When collected: All sampled residue piles, and PILE SHAPE = 3, 4
 Field width: 2 digits
 Tolerance: +/- 10%
 Values: 01 to 99

Item 9--PILE HEIGHT 1

Record the code indicating the height of either end of the pile. Estimate to the nearest foot. Pile height 1 may often equal Pile height 2.

When collected: All sampled residue piles, and SHAPE=1, 2, 3, 4
 Tolerance: +/- 10%
 Values: 1 to 99

Item 10--PILE HEIGHT 2

Record the code indicating the height of either end of the pile. Estimate to the nearest foot. PILE HEIGHT 1 may often equal PILE HEIGHT 2.

Annual Inventory 2004
DOWN WOODY MATERIALS

When collected: All sampled residue piles, and PILE SHAPE = 3, 4
Field width: 2 digits
Tolerance: +/- 10%
Values: 01 to 99

Item 11--PILE DENSITY

Record the code estimating the percent of the pile that consists of wood. Visualize the shape of the pile you selected in Item 4, and factor air, soil, rock, plants out of the estimate. Estimate to the nearest 10 percent.

When collected: All sampled residue piles
Tolerance: +/- 20%
Values:

00	Absent
01	Trace (< 1% cover)
10	1 – 10%
20	11-20%
30	21-30%
...	
90	81-90%
99	91-100%

Item 12—Horizontal Distance to Pile

Record the horizontal distance from subplot center to the center of the residue pile for piles recorded on co-located Phase 2 and Phase 3 plots. Estimate to the nearest foot. The Horizontal distance recorded for each pile must reflect the size radius plot the pile actually occurs in. For example: a pile at 24 ft. has a distance tolerance of +/- 1 ft., but it's distance must be recorded as ≤ 24 or the recorded distance is incorrect.

When collected: All sampled residue piles on co-located Phase 2 and Phase 3 plots.
Field Width: 2 digits
Tolerance: Subplot: +/- 1 foot
Annular plot: +/- 10 feet
Value: 00 to 59

XIII. GROUND COVER ON NFS LANDS

TABLE OF CONTENTS

XIII. GROUND COVER ON NFS LANDS	213
Ground cover measurements	215
Item 1--Subplot number (SUB PL)	215
Item 2--Transect (T)	215
Item 3--Segment ID	215
Item 4--Ground cover type	215
Item 5--Cover	216

XIII. GROUND COVER ON NFS LANDS

Information on the abundance of different ground cover types provides information on the hydrologic function of a site and its potential to erode. Because estimates of bare ground and rock cover need to be relatively precise, estimates are done on the plot transects, rather than on the subplot as a whole (as is done for vegetation cover). Two 10-foot long segments are located on each of the two transects, and cover estimated separately on each section.

On established field plots if the center of any subplot is in R6 or R5 National Forest, ground cover is measured on all accessible (forest and nonforest) condition classes on that subplot. If the transect crosses an ownership or other condition class boundary, record the change in condition class at the boundary point as part of Down Woody Debris transect segmenting procedures. If a portion of a transect falls into hazardous, census/noncensus water, Denied access, or Not in the sample area, record the change in condition class status at that point on the transect.

Ground cover measurements

Item 1--Subplot number (SUB PL)

Record a 2-digit code indicating the subplot center from which the transect originates. Use the procedures described on page 41.

Item 2--Transect (T)

Record a 3-digit code indicating the transect on which Ground Cover is being measured.

When Collected: All tally segments

Tolerance: No errors

Values:

Code	Definition
030	Transect extends 30 degrees from subplot center
150	Transect extends 150 degrees from subplot center
270	Transect extends 270 degrees from subplot center

Item 3--Segment ID

Starting at 4 feet slope distance from plot center, the 10 foot segments are numbered 1-2 out to the edge of the subplot. Record the appropriate segment number (1 or 2), based on the slope distance from point center as:

Tolerance: No errors

Values: 1, 2

Segment	Slope Distance
1	4.0-14.0 ft.
2	14.0-24.0 ft.

Item 4--Ground cover type

Record the appropriate ground cover code for cover types found on each transect segment. Select ground cover items that are visible when looking down for items in contact with the ground (e.g., a log suspended 1' above the ground over the transect does not count as ground cover). In order to get an accurate portrayal of ground cover; cover of basal portions of forbs, grass clumps, trees, and woody shrubs, plus any other non-vegetation cover must all add up to 100 percent for each segment along the transect. Select ground layers in the order presented, top to bottom. At times items will overlay each other (e.g., MOSS over ROCK). When this occurs the portions of each item that are viewed from above is what will be selected and measured.

Tolerance: No errors

Values:

Code	Ground Layer Description

Annual Inventory 2004
GROUND COVER ON NFS LANDS

BARE	Exposed Soil: Bare soil, composed of particles less than 1/8 inch in diameter, which is not covered by rock, cryptogams, or organic material. Does not include any part of a road (see definition for road).
LICH	Lichens: an organism generally recognized as a single plant that consists of a fungus and an alga or cyanobacterium living in a symbiotic association. This code does not apply to lichen growing on bare soil in dry rangeland conditions. For rangeland conditions see cryptogamic crusts.
MOSS	Mosses: Nonvascular, terrestrial green plant, including mosses, hornworts, and liverworts. Always herbaceous. This code does not apply to moss growing on bare soil in dry rangeland conditions. For rangeland conditions see cryptogamic crusts.
CRYP	Thin, biotically dominated ground or surface crusts on soil in dry rangeland conditions; e.g. cryptogamic crust (algae, lichen, mosses or cyanobacteria).
ROCK	Rock: Relatively hard, naturally formed mineral or petrified matter greater than 1/8 inch in diameter appearing on the soil surface, as small to large fragments, or as relatively large bodies, cliffs, outcrops or peaks. Includes bedrock.
WATE	Water: Water is coded where the water table is above the ground surface during the growing season, such as streams, bogs, swamps, marshes, and ponds.
PEIS	Surface area covered by ice and snow at the time of plot measurement, considered permanent.
TRIS	Surface area covered by ice and snow at the time of plot measurement, considered transient.
ROAD	Roads: includes improved roads used to assign condition class, which are generally constructed using machinery, and is the area where the original topography has been disturbed by cutbanks and fill. Also includes unimproved trails impacted by regular use of motorized machines (e.g. motorcycles, jeeps, and ORV's). Non-motorized trails and unimproved traces, and roads created by occasional use for skidding logs are not included
DEVP	Surface area occupied or covered by any man-made structure other than a road, such as a building, dam, parking lot, electronic site/structure.
LITT	Leaf and needle litter, and duff not yet incorporated into the decomposed top humus layer.
BAVE	The basal area cover, at ground surface, of any plants occupying the ground surface area. Includes any trees, shrubs, basal grasses, and forbs (live, or senesced from the current year). Senesced = live during the current year's growing season, but now dead
WOOD	Woody Material, Slash & Debris: Any woody material, small and large woody debris, regardless of depth. Includes stumps. Litter is not included.
ASH	Residue after wood and other combustible material has been burned off.
TEPH	All material formed by volcanic explosion or aerial expulsion from a volcanic vent, such as tephra, or pyroclastic material.
NOIN	Non-inventoried condition classes: Census water, Hazardous, Access denied, or Not in the Sample

Item 5--Cover

Estimate the percent cover of each item from one edge to the other as it is intersected by the transect section. Remember to view the ground layer in the absence of aerial vegetation for purposes of measurement. Record the accumulated cover for each ground item within a ten-foot section of the transect to the nearest 1% (0.1 foot on a 10 foot section equals 1% cover). Note: Within each section the accumulated covers for all ground items must equal 100%.

Tolerance: +/- 5% for each item on a segment

Annual Inventory 2004
GROUND COVER ON NFS LANDS

Values: 0 to 100

XIV. COORDINATES (GPS)

TABLE OF CONTENTS

XIV. COORDINATES (GPS).....	219
A. Overview.....	221
B. When and where to collect readings.....	221
C. Recording GPS information.....	221
D. GPS keypad layout and commands.....	221
GPS keypad commands.....	222
E. GPS setup options.....	223
F. Operating the GPS on plot.....	223
G. Collecting coordinates away from plot center.....	225
H. Waypoints (Advanced GPS use).....	226
Creating a waypoint (when coordinates are given).....	226
Marking (storing) your current location.....	226
I. Navigating with the PLGR (Advanced GPS use).....	226
K. Batteries.....	227

XIV. COORDINATES (GPS)

A. Overview

An objective of the inventory is to obtain accurate coordinates for each field grid location. Coordinates are used to correlate plot information with remotely sensed imagery and data and in relocating the plot at future inventories. On each visited plot, coordinates are collected using GPS recorders when possible. GPS stands for Global Positioning System, a technology that uses signals from satellites to triangulate and compute the coordinates of locations on the ground. In collecting GPS coordinates PNW-FIA uses Magellan Meridian GPS receivers.

This chapter is written so that the first 7 Sections (A-G) and the final Section (J), are essential for plot coordinate collection. The other Sections (H-I) demonstrates some of the more advanced features of the GPS. Although these advanced features are not entirely necessary for plot work, they can be of much value and save a lot of time if used properly. The procedures are written in a simple, step by step fashion (which makes them appear lengthy at first glance). But after using the GPS a few times, a person will be able to maneuver through the various menus with relative ease and confidence

B. When and where to collect readings

For each plot visited, attempt to collect a GPS reading that has averaged for at least **3 minutes** with an EPE (estimated position error) of **70 feet** or less. Always start GPS procedures on a plot by trying to collect an adequate set of readings at the center of subplot 1 on the standard layout; the objective is to obtain coordinates at this subplot center, the field grid location. A good plan is to try to collect an adequate set of readings as soon as the center of subplot 1 is located, and, if unsuccessful, to try again shortly before going to the next subplot. **Success** is GPS-generated coordinates for the field grid location (subplot 1) that are based on a reading that has averaged for at least 3 minutes with ≤ 70 feet EPE.

If unsuccessful at the field grid location, try to obtain coordinates at a different location. **NOTE:** Allow at least 45 min to an hour between readings to allow for different or new satellites to come into clear view of the receiver. If more than one coordinate is collected, record the coordinate that is closest to subplot 1 center and has averaged for at least 3 minutes. Write any other collected GPS coordinates or any notes regarding GPS use on the front of the plot card. Record the azimuth and distance from the GPS reading location to the center of subplot 1.

C. Recording GPS information

GPS information is recorded in the Husky field data recorder (See GPS COORDINATES in the PLOT ATTRIBUTES section of this manual). For Magellan Meridian GPS receivers, record: GPS UNIT TYPE (Unit = 2)

GPS SERIAL NUMBER (GPSId = #####)

COORDINATE SYSTEM (Sys = 2)

UTM ZONE (Zone = ##C) displayed to the left of the easting coordinate.

EASTING (X) UTM (Easting (X) = #####)

NORTHING (Y) UTM (Northing (Y) = #####)

GPS ELEVATION (Elevat = #####)

GPS ERROR (Error = ###)

NUMBER OF READINGS (Read = #####)

**** Important Note**** The Husky data recorder requires that the number of averaged readings be entered. The Magellan unit does not have a number of readings counter, instead it utilizes a timer. The timer is displayed on the position screen. It displays in hours/minutes/and seconds. The GPS receiver collects one reading per second while averaging. To correctly enter the number of readings in the husky, the time in minutes and seconds must be converted to number of readings. Since the unit collects 60 readings per minute of averaging crews must remember to multiply the number of minutes by 60 and then add the number of seconds shown to that figure. For example, if the Magellan receiver averages for three minutes and twelve seconds it will display 00:03:12. To convert this to number of readings multiple three minutes by sixty and add twelve. $3 \times 60 = 180 + 12 = 192$. Crews would enter 192 in the husky data recorder for Number of Readings.

AZIMUTH TO PLOT CENTER (Azm = ###) if coordinates were collected at plot center enter 000.

DISTANCE TO PLOT CENTER (Dist = ###) if coordinates were collected at plot center enter 000.

D. GPS keypad layout and commands

GPS keypad commands

PWR: power key turns the unit on and off. To turn the unit on, hit the PWR key, then the ENTER key

ENTER: confirms data entry or menu selections

MENU: provides access to waypoint and setup functions

ESC: cancels the operation of the last button pressed

NAV: accesses the various navigation screens

GOTO: creates a direct route to any waypoint stored in memory, and is used to MARK a position

IN: zooms in the display of the map screen

OUT: zooms out the display of the map screen

LEFT/RIGHT arrow keys move the cursor left or right while entering data

UP/DOWN arrow keys move the cursor up and down while entering data or selecting menu options

Initiate screen backlight: press and hold the PWR key for 2 seconds

The backlight quickly drains the batteries, so avoid accidentally turning on the backlight.

Adjust screen backlight: after turning the screen backlight on, press and hold the PWR key for 2 seconds. This will increase the strength of the backlight. Press and hold the PWR key for 2 seconds again to turn the backlight off.

Location of GPS Buttons

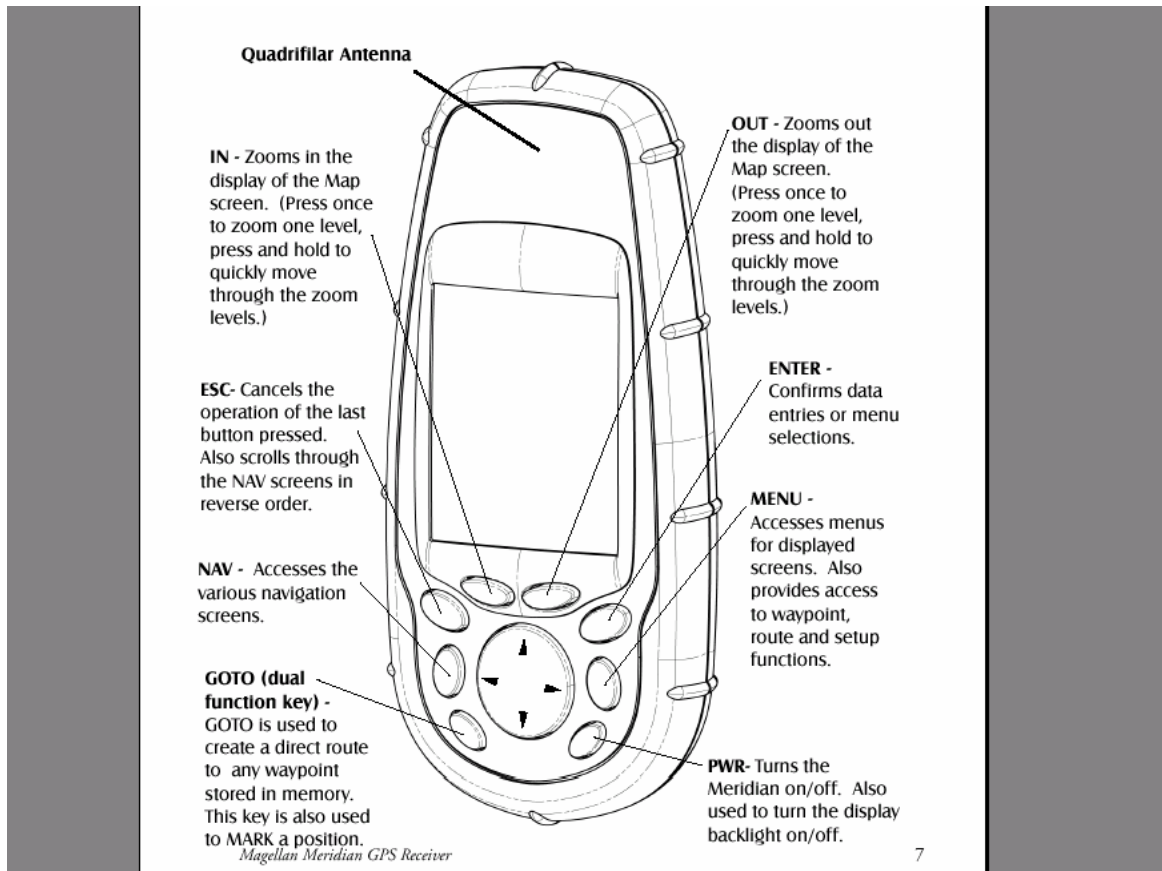

E. GPS setup options

Listed below are the parameters to be setup before collecting satellite readings. Once these parameters are set up for the first time they will not need to be reset. Periodically (at least weekly) the unit should be checked to see that the settings have not been inadvertently changed.

NAVIGATION SCREENS

The Meridian has nine navigation screens that can be displayed or turned off. Some screens must be displayed in order to get coordinate information. Several screen display similar or the same information and it is recommended that these screens not be displayed.

Turn the unit on and press NAV until the map screen appears. Press MENU and select Setup by scrolling down until it is highlighted and press the ENTER key. Select Nav Screen in the same manner.

Sat Status = **On**
Compass = **Off**
Large Data = **On**
Position = **On**
Road = **Off**
Data = **Off**
Speed = **Off**.

SETUP UNITS

Press MENU key, use up or down arrow to select Setup option, then press the ENTER key to enter the Setup pages. To scroll through the following pages use the up/down arrows. Once the desired Setup menu option is highlighted, press the ENTER key to select it.

COORDINATE SYTEM: Primary = UTM, Secondary = UTM

MAP DATUM: Primary = NAD 27, Secondary = UTM

ELEV MODE: 3D

TIME FORMAT: Local AM/PM

NAV UNITS: Miles/Ft/MPH

NORTH REFERENCE: True

DAYLIGHT SAVINGS: United States

POWER OFF TIMER: On/Time/30 minutes

LIGHT TIMER: 4 Minutes

BEEPER: Off

POWER KEY: On/Off protected

IMPORTANT: Make sure that the MAP DATUM being used is the correct DATUM specified for your area. This is set on the SETUP page. Using a different datum will alter the coordinates significantly.

Oregon, Washington, California = NAD 27

Pacific Islands = WGS 84

CUSTOMIZING NAVIGATION SCREENS

It is important that navigation screens are setup consistently among all units.

Large Data Screen:

Press NAV until the Large Data screen displays. Press MENU and select Customize. Press ENTER and select BEARING and press ENTER. Press ENTER and select DISTANCE press ENTER. Press ENTER and select HEADING press ENTER. Press ENTER and select SPEED press ENTER.

Position Screen:

Press NAV until the Position screen displays. Press MENU, scroll down until Customize is highlighted, press ENTER. Press ENTER, scroll down and highlight EPE (estimated position error), press ENTER. Now the EPE will still be displayed while the unit is averaging. Monitor EPE to ensure that readings are not taken at > 70 feet.

F. Operating the GPS on plot

Carry extra batteries at all times. The two AA-alkaline batteries begin to lose power after approximately four hours of use. See Section K. Batteries, for more details.

1. Turn on the GPS unit

2. Check to see if the unit is receiving satellite readings by pressing the NAV key until the satellite status screen is visible. The satellite status screen shows 2 circles at the top of the screen, and the horizontal battery status bar at the bottom. If there are 4 vertical black bars below the 2 circles and above the battery status bar, then the unit is receiving enough satellites to calculate your position.

GPS Satellite Status Screen

Satellite Status Screen

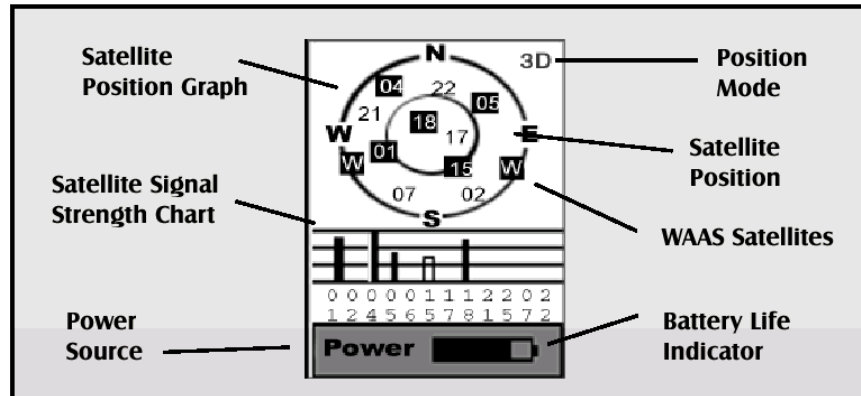

Satellite Position Graph

The two circles indicate satellite elevation as seen from your current position; the outer circle represents the horizon and the inner circle represents 45° from the horizon.

Power Source

Indicates the source of power being used – POWER (Internal Battery) or POWER EXTERNAL.

Position Mode

3D - position computed is

Satellite Position Graph

The two circles indicate satellite elevation as seen from your current position; the outer circle represents the horizon and the inner circle represents 45° from the horizon. The center of the circle is 90° from the horizon, or directly overhead.

Power Source

Indicates the source of power being used – POWER (Internal Battery) or POWER EXTERNAL.

Position Mode

3D - position computed is 3-dimensional (elevation is being computed).

Satellite Signal Strength Chart

Clear bar indicates that the Meridian is starting to get information from the satellite. Satellites that are being used to compute your position are shown with solid bars. The height of the bar indicates the relative signal strength.

2D - position computed is

2-dimensional (elevation is not being computed).

Blank - Meridian is not computing a position fix.

Satellite Position

Where the satellite is located relative to your position.

3. When the unit has locked onto 4 satellites, push the NAV key until the Position Screen is displayed. The Position Screen shows the current UTM coordinates and elevation at the top of the screen. The date, time, and position error are shown in the center of the screen. If the GPS unit is not receiving satellites, the position error will show "Search", and the UTM coordinates shown at the top of the screen will be the last location where the unit was able to lock onto 4 satellites.

4. In the Position Screen, the EPE (estimated position error) is displayed just above the trip odometer. The GPS receiver will enter averaging mode anytime it is stationary. To ensure that only reading at plot center are averaged, from several feet away, slowly move the unit onto plot center and let it remain stationary in averaging mode for at least three minutes.

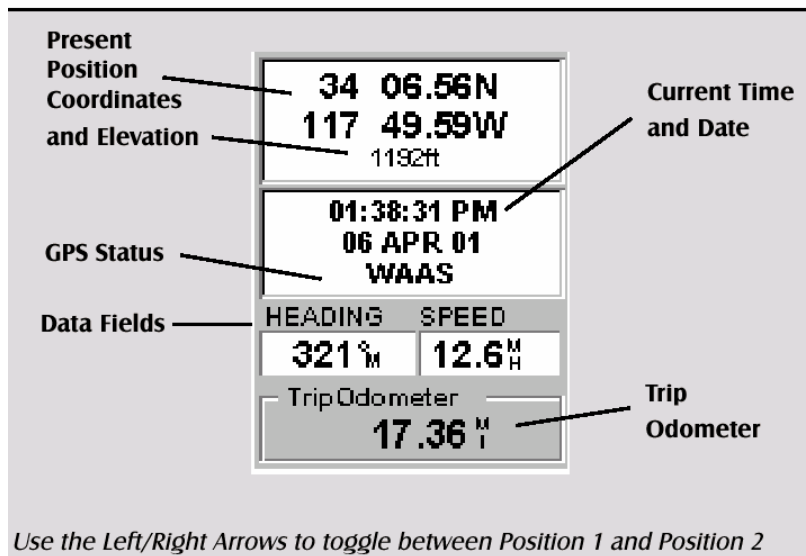

GPS Position Screen

Message	Description
Searching - 1st sat	Searching for 1st satellite.
Searching - 2nd sat	1st satellite found; searching for 2nd satellite
Searching - 3rd sat	Two satellites are being tracked and searching for a third.
Searching - 4th sat	Three satellites are being tracked and searching for the fourth.
Collecting Data	All satellites needed for position fix are being tracked and position is being computed.
Averaging	Meridian is computing fixes; speed is near 0.0 so position is being averaged.
EPE xxft	Estimated Position Error in feet. Meridian is computing fixes while moving.
DGPS	Computed fixes are being differentially corrected.

5. Record the coordinates, elevation, time of averaging, datum, UTM zone, etc under Plot Data in the Husky data recorder. If the coordinates are recorded at plot center, then azimuth and distance to plot center will be recorded as zero.

G. Collecting coordinates away from plot center

GPS coordinates should always be recorded at plot center when possible.

If for some reason you can't get an adequate set of readings at plot center, you may take readings at another location, and then record the azimuth and distance to plot center so that someone in the office can calculate the coordinates at plot center. Take the GPS unit to a location where you will be able to collect 3 minutes of averaged readings at ± 70ft accuracy, and where you will be able to accurately measure the horizontal distance, azimuth and

slope in degrees to plot center. Do not move to a distance more than 200ft away if you don't have a laser range finder.

Record the coordinates, elevation, length of time coordinates are averaged, UTM zone, azimuth, and distance to plot center under Plot Data in the Husky data recorder.

H. Waypoints (Advanced GPS use)

Creating a waypoint (when coordinates are given)

A waypoint is a fairly precise location (on the ground, for our purposes), that a GPS user may assign a number and/or label to identify. For the purposes of PNW-FIA the location format of choice is called UTM/UPS (Universal Transverse Mercator/Universal Polar Stereographic). This format allows for the following required information: **Zone**- a 2 digit number (01-60) with a letter (C-X) attached. For our purposes, all zones in the western U.S. will be any combination of the numbers **10,11** and letters **U, T, or S**. **Easting**- a seven digit number (usually the first digit will be a zero) that represents distance from the eastern boundary of the particular zone. **Northing**- also a seven digit number that represents distance north of the equator (Northing numbers are usually instrumental in determining what zone the coordinates are in).

To create a new waypoint when the UTM coordinates are given with the plot data, turn on the GPS and then hold down the GOTO button. This will bring up the MARK screen with **SAVE** highlighted. Push either the up or down arrow until the Location field is highlighted. Press ENTER. The "UTM hemi" screen is displayed. Highlight North and press ENTER. Edit line 1 of the location field by press the up or down arrow until the desired digit is displayed, then press the right arrow to move to the next digit. When the desired zone and Easting coordinate are displayed, press ENTER. Edit line 2 of the location field in the same manner, and press ENTER. Edit the Elevation field in the same manner, and press ENTER. If you need to edit the icon, name, or message for a waypoint, use the UP/DOWN arrows to highlight the field you wish to change and press ENTER. You are then placed in the edit mode. Use the arrow and ENTER keys to select the icons or letters you wish to use. After you are finished changing the name or message, highlight the OK button and press ENTER to return to the MARK screen. When you have entered all the necessary data, highlight the Save button, and press ENTER.

Marking (storing) your current location

This feature is used to mark/store a current location as a waypoint in the Magellan's internal memory bank. Storing the location of a vehicle, RP, campsite, or starting point is a good example on how you can use this feature in the field. Stored waypoints can be useful in approaching locations in a different way, taking a different route back to the vehicle, or if you should get lost (see navigating to a waypoint).

To start, make sure the unit is on and you are receiving good signals. Check the Position screen (see Section F. Operating the GPS) and be sure that you are getting readings from at least 4 satellites. If you are moving, the GPS status should have EPE of less than 70 feet. If you are standing still, the GPS status should show that the unit is averaging your position.

Once you have confirmed good signal reception push on the GOTO button and hold it down until the **MARK** screen appears. You can now select a name to assign as a waypoint for your current location. Push the UP/DOWN arrows until "name" is highlighted, then press ENTER. Use the arrow and ENTER keys to select the letters or symbols you wish to use. After you are finished changing the name highlight the OK button and press ENTER to return to the MARK screen. Scroll down and highlight the save button and press enter. The GPS's current location (under the assigned name), is now stored in it's memory and can be used to navigate with.

I. Navigating with the PLGR (Advanced GPS use)

To begin navigation, you must first have a waypoint stored in the GPS unit (see Section G. Waypoints). Also, unless you have a good sense of azimuth (to the nearest few degrees), a compass will be needed. (**NOTE:** keep the compass away from the body of the GPS to keep it from affecting the magnetic accuracy). Once you know which waypoint number you are going to travel towards, turn the GPS on and then, after the unit has locked onto 4 satellites, push the GOTO button. Highlight "**User**" in the menu, and press the right or left arrow buttons until "Alphabetical" shows in the field under FIND BY at the bottom of the screen. Press the ENTER button. A list of

user-stored waypoints appears. Scroll down through the list until you find the name or number of the desired waypoint. Highlight the desired waypoint and press ENTER.

If you are not getting satellite signals then you will get the bearing and distance to the waypoint you selected from the last position the GPS unit obtained satellite signals. You may want to move in the general direction of the waypoint and hope that satellites will come into better view, or you may want to let the GPS sit for a few minutes to lock on to some signals.

Once you are sure you are receiving satellites you can press the NAV button to find the Large Data screen. This screen displays the bearing (azimuth) and distance to the waypoint and also the heading and speed of the GPS receiver. Follow the bearing as you walk towards the waypoint and the distance should steadily decrease. Eventually, as you get closer to the waypoint, the distance will get very small (about 10-30ft), and the bearing will begin to jump around dramatically. This means that you are very close to your destination (so look for the stake and witness trees if the waypoint is subplot 1).

Other data you might see on the navigation screens:

Bearing This is the direction to your destination from your present position, in degrees, from North.

Distance This is distance (measured in the Nav Units selected in Setup) to your destination.

Speed This is the rate that you are travelling. The unit of measure is selected in Setup - Nav Units.

Heading This is the direction you are moving (measured in degrees). When the heading and bearing are the same, you are travelling on a direct line to your destination.

VMG (Velocity Made Good). This is the speed that you are getting closer to your destination. If the heading and bearing are the same, then VMG will be the same as Speed since all of the speed that you are travelling is being applied to arriving to your destination. However, if you are off course, your VMG will be less than the speed that you are travelling.

CTS (Course To Steer). This is the angle that you need to turn to put you back on course.

ETA (Estimated Time of Arrival). This the local time that you will arrive at your destination based on the rate of speed that you are moving to your destination. (See VMG.)

ETE (Estimated Time Enroute). This is how long, in time, that it will take you to arrive at your destination based upon your present speed to the destination.

XTE (Cross Track Error). XTE is the perpendicular distance from your present position to the course line you should be on to go to your destination.

Turn This is the direction you need to turn to put you on the shortest distance to your destination from your present position.

Elevation This is the distance above sea level that you are presently at.

Time Local time.

Date Current date.

K. Batteries

GPS machines use two AA batteries, which usually last for eight hours of use. Replace the batteries when the Power Indicator (found on the bottom of the satellite locator screen) is low. The GPS may have trouble locating satellites if the battery is low.

Annual Inventory 2004
COORDINATES

.

XV. LASER 200 INSTRUCTIONS

TABLE OF CONTENTS

XV. LASER 200 INSTRUCTIONS	229
A. Overview	231
B. Basic operation	231
C. Settings.....	231
D. Filter and Reflectors	232
E. Distances and % slope	232
F. Tree heights	232
G. Gates	232
H. Cumulative distances	233

XV. LASER 200 INSTRUCTIONS

A. Overview

Accurate heights are necessary in our inventory in order to determine volume and for other uses. The Laser can be used to get fast and accurate tree heights. It can also be used to measure distances and % slope. This instrument is more fragile than the GPS units. Some precautions must be taken with the Lasers to keep them working properly. These are:

1. Never look at the sun through the scope. Looking directly at the sun can permanently damage your eyes.
2. Never point the Laser directly at the sun. Exposing the lens system to direct sunlight, even for a brief period, may permanently damage the laser transmitter.
3. Do not expose the Laser to extreme temperatures. It is rated for a temperature range of -22 to +140 deg. F. Don't leave the instrument in the vehicle during the heat of the day.
4. Do not use batteries with "voltage check" features built on the batteries. The battery case of the Laser is too narrow for these batteries, and they could get stuck in the instrument.
5. Do not drop the Laser. Immediately return it to its case when you get back to the vehicle. There is usually more danger of damaging the instrument in the vehicle than out in the woods.

B. Basic operation

All directions for using the Laser buttons are given assuming you are holding the instrument with the LCD display screen facing you and the 2 round lenses are facing the object you want to measure. The buttons will be referred to as:

- L1 the left button closest to you
- L2 the left button in the middle
- L3 the left button furthest away from you
- R1 the right button closest to you
- R2 the right button in the middle
- R3 the right button furthest away from you

Turn the Laser on by pushing L1 or R1

Turn it off by pushing L2 and L3 at the same time. The Laser may turn itself off after a period of inactivity. Once the instrument is on, push the R1 button to make the red dot appear in the sighting scope. If there is no red sighting dot, repeatedly push the L2 button until the red dot appears and is the correct brightness.

To light up the display screen, press L3. Press L3 again to turn off the light.

C. Settings

Make sure the settings are correct before using the Laser. To set the correct measurement units, go into the main menu and:

1. Press R2 or R3 to scroll through the menu until SYS is displayed in the upper right hand corner of the screen.
2. Press R1. ON or OFF will show in the center of the screen. FILTER will flash at the bottom.
3. Press R2 until OFFSET is flashing. The number displayed should be 0000.00.
4. Press R2 until PIVOT is flashing. The number displayed should be 0000.59. When this number is set at 0.00, the Laser is set to calculate heights using a tripod attached to the center of the instrument. The pivot point is the center of the Laser. We use the pivot value at 0.59 because this sets the pivot point at the rear of the instrument, and this allows you to shoot a height while using your head as the pivot point. To change this number, press L1 until the number you want to change is flashing. Press L2 or L3 until the correct number is showing. When the number is set at 0000.59, press R1.
5. Press R2 until UNITS is flashing. Select F (feet) using the R1 button.
6. Press R2 again and D (degrees) should be flashing. If not, press R1 to toggle on D.
7. Press R2 again and % should be flashing. It should say ON. If not, press R1.
8. Press R3 twice to accept the new settings and back out to the main display.

D. Filter and Reflectors

When you are working in areas of dense brush, you need to make sure the Laser is giving you the distance to the correct target. The best way to do this is to use a reflector as a target and use the filter option on the Laser. The Laser will only lock onto the highly reflective targets and ignore the less reflective brush. To use the filter option:

1. Place a reflector (or have someone hold it) on the tree where it can be seen from the required distance. The Laser will not work in the filter mode without a reflector as a target.
2. Go to the main menu on the Laser and push R2 or R3 until SYS is displayed on the screen.
3. Press R1 to select the SYS option. The FILTER option will blink, and it will say the FILTER is OFF or ON.
4. Push R1 to toggle FILTER between ON and OFF.
5. Press R3 to save the desired setting and to back out into the main display. When the FILTER is on, FILTER will appear at the bottom of the screen when the Laser is measuring distances.

E. Distances and % slope

Horizontal distance (HD): Turn the Laser on. The top-middle of the LCD screen will say HD. Point the red sighting dot at the target. Press R1 and hold it down until the Laser locks on the target, then release. You can tell when the instrument locks onto its target by sound. It buzzes while it is searching for the target, then beeps when it locks on to a target or there is an error. If you get an error message, simply aim again and press R1.

Slope distance (SD) and Vertical distance (VD): Push R2 or R3 until the correct display is shown. Then aim and press R1 until the Laser locks on target. Or, measure a horizontal distance, then push R2 until the correct display is shown.

% slope: Press R2 or R3 until INC is displayed. Then aim and press R1.

F. Tree heights

The best way to measure a tree height is to make sure you have a clear shot at the leader or a clear shot of the tree trunk. Make sure you are getting a distance to the tree trunk, and not some branches in front of it. If you can't get a clear shot at the leader or the tree trunk, use a reflector (see section D). Once you are in position with your target in sight, go to the main menu:

1. Push R2 or R3 until HT is displayed in the upper left of the screen.
2. Push R1 once, aim at the target, then push R1 until the Laser locks on target. This will measure the horizontal distance.
3. The down arrow will flash. Aim at the base of the tree and push R1 to get the % slope.
4. The up arrow will flash. Aim at the top of the tree and push R1 again to get another % slope.
5. Press R1 once more and the Laser will display the height. Make sure this height is reasonable before recording it in the Husky.

G. Gates

The gate option can extend the Laser's minimum range or restrict its maximum range. It is most often used to help you make sure you are hitting the right target when objects near you or just beyond your target might give you false readings. You don't have to set both gates. You will probably only need to set the short gate because of brush or fog between you and your target. You can set a gate by shooting a target or by entering distances into the instrument. To set a short gate by laser, go to the main menu and:

1. Press R2 or R3 until GATE is shown on the display.
2. Push R1 to select the gate option.
3. Press R1 to toggle the gate between ON and OFF.
4. Push R2. The S indicator will flash.
5. Aim at a target that is at the distance you want to set as the short gate and press R1.
6. Now you can either set a long gate, or press R3 to go back to save the short gate and return to the main menu. The S will be displayed when you are measuring distances to show the short gate is on.

To set a long gate:

7. Push R2. The L indicator will flash.
8. Aim at an appropriate target and press R1
9. Press R3 to save the gate and go back to the main display. The L will be displayed when measuring distances.

The gates are reset to OFF when the Laser is turned off, but gate values are saved in memory. This means that if you have saved a gate and turn off the instrument, when you turn it back on the gate will be set to OFF. If you go back into the gate option and turn the gate ON, it will remember the last distances you shot for the long and short gates.

To clear out a gate value: Display the gate values by following the instructions in this section (section G). When the desired gate value is displayed, press and hold down R3 until the number is deleted.

H. Cumulative distances

A cumulative distance measurement allows you to move from one target point to the next, stopping at each one to measure the distance to the next target point. The Laser accumulates the measured distances in both slope and horizontal distances (SD and HD) to give you a running total.

To take a cumulative distance, go to the main menu and:

1. Press R2 or R3 until MULTI is displayed on the screen.
2. Press R1 to enter the MULTI option. DIFF will be displayed.
3. Press R2 once. CUM will be displayed.
4. Press R1. Either SEL or a number will be displayed. If SEL is displayed, HD will flash on and off. Press R1 to toggle between HD and SD. Press R2 when the correct indicator is flashing. If a number is displayed, that means there is already a cumulative distance saved on this instrument. You can either clear out this distance by holding down R3 until 0.00 appears, or continue to add to the distance by going to step 5.
5. Aim at the target and press R1 to fire the laser.
6. If you are not satisfied with the measurement, repeat step 5 to retake the measurement. If you are satisfied with the measurement, and wish to add it to your total, press R2. The new total will be displayed.
7. Repeat steps 5 and 6 to add more measurements to the total.

You can choose whether you want horizontal or slope distances at any time. If a distance has been measured, you can change from slope or horizontal distance by pressing R3 twice. SEL will be displayed. Push R1 to toggle between SD and HD. Press R2 twice to get back to the total distance. Go to step 5 to add more distances.

The cumulative measurement total is saved in memory even if the instrument is turned off. Turn the instrument on and scroll back to the MULTI-CUM option and resume the procedure with step 5. To clear out the current total and begin another series of measurements, hold down R3 while the cumulative distance is showing until the number is deleted.

XVI. APPENDICES

TABLE OF CONTENTS

XVI. APPENDICES	235
APPENDIX 1 -- R6 NATIONAL FOREST PLOTS - SPECIAL RULES	237
A. Hectare plot	237
B. Plot installation on nonforest condition classes	237
C. Ground Cover on NFS lands	237
D. Previous R6 rules for plot installation ('Old' R6 plot)	237
Primary Sample Unit Establishment	237
PSU Location ('Old' R6 plot)	237
Stake Position Installation ('Old' R6 plot)	238
Stake Position Reference (SPR) ('Old' R6 plot)	239
Orange Tags ('Old' R6 plot)	240
Subplot Layout ('Old' R6 plot)	240
APPENDIX 2 -- R6 OFF-NATIONAL FORESTS	241
A. Background: plot layout at previous Washington and Oregon inventories	241
Inventory design	241
Washington	241
All Occasions	241
Oregon	241
Occasion 1	241
Occasion 2	241
Occasion 3	241
Occasion 4	242
Occasion 5	242
Forest Health Monitoring Program	242
B. Products	242
C. Research topics	242
D. Previous plot layouts	242
E. Additional sources of documentation	245
F. Oregon plot completion	245
APPENDIX 3 -- R5 NATIONAL FOREST PLOTS - SPECIAL RULES	247
A. Hectare plot	247
B. Plot installation on nonforest condition classes	247
C. Ground cover on NFS lands	247
D. Mortality assessment	247
E. Monumenting within wilderness areas in Region 5	247
F. R5 Chaparral Procedures	248
G. R5 National Forest and Ranger District location information	250
H. Region 5 National Forest Contacts for FIA	253
I. Previously used procedures and codes in the R5 survey	253
R5 National Forest and Ranger District Codes	253
R5 Past Plot Design	255
Region 5 FIA Program Species Codes and the current PNW equivalent	257
R5 Tree Type Measurement Codes	258
Previous R5 plot measurement process. (Sequencing and methodology)	258
APPENDIX 4 -- R5 OFF NATIONAL FORESTS	263
A. The Inventory of California	263
Background	263
Inventory Design	263
Forest Health Monitoring Program	263

APPENDICES

Additional sources of inventory documentation	263
History of Survey in CA, all Occasions:.....	264
B. PNW Past Occasion Plot layout	264
C. PNW Tree History Codes and definitions from the previous inventory (Oc3).....	264
D. Sudden Oak Death (SOD) Syndrome	265
 APPENDIX 5 -- SLOPE CORRECTION TABLE.....	 267
 APPENDIX 6 -- DETERMINATION OF STOCKING VALUES FOR LAND USE CLASSIFICATION.....	 269
 APPENDIX 7 -- TREE SPECIES LISTS	 279
 APPENDIX 8 -- FOREST TYPE CODES	 287
 APPENDIX 9 -- COUNTY and PLANT ASSOCIATION KEY	 291
Washington	291
Oregon	293
California	298
 APPENDIX 10 -- METRIC EQUIVALENTS AND AIDS	 299
 APPENDIX 11 -- HELLO LETTER/DATA CONFIDENTIALITY	 301
 APPENDIX 12 -- INTERIM LOCATION CONFIDENTIALITY POLICY.....	 303
Summary of FIA privacy (confidentiality) policy	303
Final Interim Privacy Policy	306
Confidentiality Certification.....	308
Sample Memorandum of Understanding	311
New Legislation on privacy for FIA data and information	313
 APPENDIX 13 -- LANDOWNER CONTACT LETTER.....	 317
 APPENDIX 14 -- LIABILITY LETTER	 319
 APPENDIX 15 -- GLOSSARY.....	 321
 APPENDIX 16 -- CHECK PLOTS	 323
 APPENDIX 17 -- INSECT AND DISEASE KEYS	 325
 APPENDIX 18 -- TREE VOLUME TABLES.....	 327
 APPENDIX 19 -- SAMPLE PLOT FORMS.....	 329
 APPENDIX 20 -- INDEX	 345
 APPENDIX 21 -- IMPORTANT PHONE NUMBERS	 347
 APPENDIX 22-- SUMMARY OF MANUAL CHANGES FROM 2003.....	 349
 APPENDIX 23 -- BLANK PAGE FOR NOTES	 353

APPENDIX 1 -- R6 NATIONAL FOREST PLOTS - SPECIAL RULES

A. Hectare plot

A hectare plot (185.1 ft. fixed-radius plot around the center of subplot 1) is established if the center of subplot 1 is on R6 national forest land. The hectare plot is established even if there are no forested condition classes present on the subplots or annular plots.

Mapping condition classes:

All forest and nonforest condition classes present on the hectare plot are mapped on the dot-map on the back of the plot card. The approximate boundaries are entered into the BOUNDARY MAPPING for subplot 1. Attributes for condition classes mapped on the hectare are assigned.

Tree Tally:

Very large trees meeting the following requirements are sampled on the hectare plot.

1. ≤ 185.1 ft horizontal distance from subplot 1 to the center of the tree at its base
2. located in an accessible (forest or nonforest) condition class
3. d.b.h ≥ 32.0 in. ("east" side plots) or ≥ 48.0 in. ("west" side plot)
4. standing tree (live or dead)

Hectare trees are referenced to the nearest subplot center. If no hectare trees are tallied on a subplot the data recorder program will display a warning and the crew will confirm that no hectare tally trees are present.

B. Plot installation on nonforest condition classes

If the center of a subplot is on R6 national forest land, measurements are taken in all accessible (forest and nonforest) condition classes on that subplot. This is true even if there are no forested condition classes on that subplot. Measurements taken in nonforest condition classes include tree measurements, DWD, fuel loading, understory vegetation, and ground cover. Plant association will also be collected in nonforest condition classes.

C. Ground Cover on NFS lands

Use the procedures listed in Chapter XIII to install ground cover transects on all field visited R6 plots.

D. Previous R6 rules for plot installation ('Old' R6 plot)

Primary Sample Unit Establishment

Establishment is the process of locating, installing, and referencing each PSU that is on National Forest land. Horizontal measurements shall be used to establish the PSU and to locate positions within the PSU, unless otherwise stated.

PSU Location ('Old' R6 plot)

At the end of the RP to PSU traverse, consult the aerial photos and verify you are at the ground location represented by the PSU photo pinprick. The photo pinprick identifies the location of stake position 1. Resolve any discrepancies between the photo pinprick and your ground location before proceeding. Under normal circumstances stake position 1 is the reference for the PSU. When stake position 1 cannot be installed, use one of the remaining installable stake positions as the PSU reference. Correct the RP to PSU traverse information and ground monuments to correspond to the new stake position reference. Record this information in the RP Information block and Stake Position Reference (SPR) block of the identification form.

At times, situations arise that do not allow a PSU to be established. This will happen when **all five** of the stake positions cannot be installed because **all five** are either 1) not on National Forest land or 2) not accessible by foot. In either case, record all Agency-provided information on the Identification Form and include the following additional information:

1. When **all five** of the stake positions are not on National Forest land include Stake Position Status and use the Present Condition/Past Disturbance and Remarks blocks to explain the situation.

2. When **all five** of the stake positions on National Forest lands are not accessible by foot include Physiography, Stake Position Status, Ecoclass (aerial photo interpreted or ground estimate, note which in Remarks.), Route to RP, Present Condition/Past Disturbance (explain the situation) and RP Information.
3. When **all five** of the stake positions are not installed due to both of the above conditions include Physiography, Stake Position Status, Route to RP, Present Condition/Past Disturbance (explain the situation) and RP Information. Record the Ecoclass (aerial photo interpreted or ground estimate, note which in Remarks.) only for stake positions that are on National Forest lands.

In either case, return the PSU packet to the Area Inventory Coordinator. No additional information will be collected.

Stake Position Installation ('Old' R6 plot)

Locate all stake positions in their standard position as shown in Figure 1 on page 239. Stake position 1 represents the center of the PSU. Stake positions 2 through 5 form an annular ring around stake position 1, each in a different cardinal direction and 133.9 feet away from stake position 1. Install a stake at each stake position.

Access to each stake position is not always a straight line. When obstructions interfere with accessing a stake position, use traverse offsets to navigate around the obstructions. A PSU is considered established when one or more of the stake positions are installed on National Forest land. At times, situations arise that do not allow installation of one or more of the stake positions. These include:

1. A stake position is not on National Forest land.
2. A stake position on National Forest land is not accessible by foot travel.

A stake position installation, on National Forest land, is obstructed by solid objects (trees, rock pinnacles, etc.) within the specified tolerances of the contract.

When a stake position is on National Forest land but not installed, record the following information on the Identification Form for that stake position: Stake Position Status, Ecoclass (aerial photo interpreted or ground estimate, note which in Remarks) and explain the situation in Present Condition/Past Disturbance and/or Remarks. For stake positions not on National Forest land, do the same but do not record Ecoclass. Continue installation at the next stake position.

A stake represents the physical location of a stake position. At each installable stake position drive a stake securely into the ground, leaving 1/3rd of its length above the ground. Secure an aluminum nail to the top of the stake. The nail defines the center of each circular subplot and the beginning of each planar subplot.

Drive a 10-inch length by 3/8th inch diameter piece of rebar into the ground, next to the stake that designates the end of the RP to PSU traverse. Leave 2 inches of the rebar above ground level. When the stake or rebar is not secure in the ground, build a rock monument around them to provide immobility. Leave 2 inches of the stake and rebar exposed, above the rock monument.

When a stake position falls on a road or trail, do not install the stake or rebar. Temporarily locate the point until properly referenced and all data collection is complete. Note on the Identification Form, in remarks, that the stake position was not permanently installed.

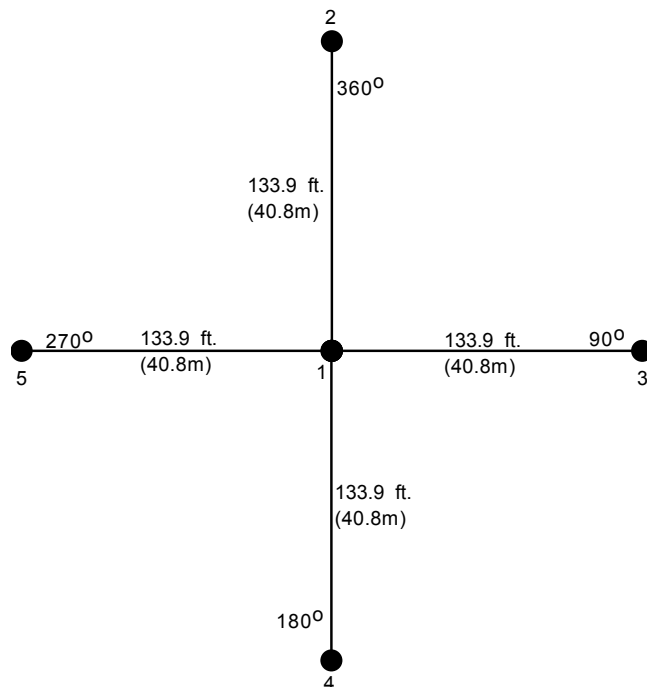

Figure 1: Locating stake positions 1-5.

(Distance and cardinal directions from stake position 1)

Stake Position Reference (SPR) ('Old' R6 plot)

Reference each stake position to three items. Choose references that form radial symmetry around the stake. Select references in the following order of priority:

1. Live trees ≥ 3.0 inches DBH and within 30 feet of the stake, or live trees > 5.0 inches DBH and between 30 and 50 feet from the stake.
2. Sound dead trees or stumps ≥ 5.0 inches DBH and within 30 feet of the stake, or sound dead trees > 10.0 inches DBH and between 30 and 50 feet from the stake.
3. Live trees ≥ 1.0 inches DBH and within 30 feet of the stake.
4. Additional stakes established 5 to 10 feet from the stake.

Monument all references used to identify the stake position at the end of the RP-to-PSU traverse with a 3" by 3" aluminum tag (Figure 2). This includes non-tally references (except stakes) if possible.

On each reference tag inscribe the following information: Reference type (SPR), PSU Number, Azimuth (from the stake position to the reference) and Distance (measure the direct slope distance between the nail in the stake and the head of the nail affixing the aluminum number tag to each tally tree, or to the bottom nail of the aluminum reference tag on non-tally references. When a direct slope measurement is blocked, measure a horizontal distance and write "HD" in remarks).

All inscriptions shall be legible and permanent, lasting for a period of 12 years. Do not confuse these with the RP reference tags. Under no circumstances shall an RP serve as a Stake Position Reference (SPR) for any stake position.

Reference Type
PSU number

Azimuth (Stake to SPR)

Horizontal Distance (Stake to SPR)

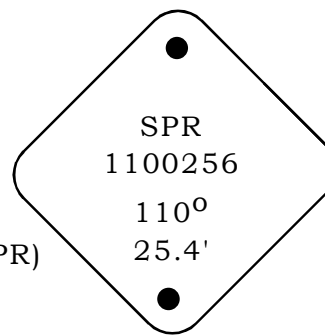

Figure 2: Stake Position Reference (SPR) tag.

Attach the aluminum tag to each reference between ground level and 12 inches above ground level with two nails, and facing the stake position. If the stake position reference is a tally tree attach the number tag to the bottom nail of the reference tag between the nail head and reference tag.

Nail a number tag to the top of the stakes used as non-tally references. Place the number facing upward. Record "REF." along with the tag number, in the remarks column, on the Vegetation Data Form.

Record SPR information for the same stake position identified in the RP information block on the Identification Form and as part of the line entry on the Vegetation Data Form. Record the remaining stake position reference information as part of the line entry on the Vegetation Data Form.

Record each tally tree used as a reference in its tallied order. Record non-tally references immediately before the sample plane information for each stake position. Write "Ref." in the remarks column of the vegetation data form for each line entry selected as a stake position reference.

Orange Tags ('Old' R6 plot)

Attach two orange tags to each tree stake position reference identified in the RP Information block. Locate these tags above DBH or at eye level, whichever is higher. Attach one orange tag facing the RP and the other facing 180 degrees from the RP. Position the longest side of each tag parallel to the tree bole and affix with one or two nails. Insert up to, but not more than, 1.5 inches of the nail into the tree.

In the event all three sets of orange tags are not placed on the stake position identified in the RP information section, install them at the next stake position. Record each orange tag location by writing "OT", in remarks, for the line entry it is associated with.

Do not use orange tags in wilderness areas.

Subplot Layout ('Old' R6 plot)

Once a stake position is installed, subplot layout can commence. A stake position represents one-fifth of the PSU area. Each area contains 7 subplots (4 concentric fixed area and 3 linear sample planes).

The stake position is the center of each circular subplot and the starting point of each sample plane. Subplots shall be installed in this order unless otherwise directed by the Area Inventory Coordinator. Subplot installation, data collection, and data recording shall be completed at each subplot before starting the next subplot at each stake position.

At stake position one the sample planes radiate in a straight line, bearing 360 degrees from the stake position. The sample planes for stake position 2 through 5 radiate from their respective stake positions toward stake position one. Define the location of a sample plane by extending a tape along the designated azimuth from each stake position. Move the tape to either side of objects that obstruct a straight line (resulting in the least amount of deflection). At the end of the sample plane install a stake in the ground and hang two feet of flagging above it.

Do not use flagging in wilderness areas.

APPENDIX 2 -- R6 OFF-NATIONAL FORESTS

A. Background: plot layout at previous Washington and Oregon inventories

In the late 1950s, PNW-FIA generated a grid of field locations across all lands in Washington and Oregon. This was done on USGS map or other available map coverage. To generate the grid on these maps, a point was selected randomly, and from this point grid lines were mapped out on cardinal directions every 3.4 miles. The intersections of these east-west and north-south lines on the maps became the basis for locating field plots on the ground in all PNW-FIA inventories since the late 1950s. In some cases, the grid was drawn county by county, and errors caused gaps or concentrations in the grid where the lines did not match up along county boundaries.

Inventory design

FIA publishes information on area by forest land and owner classes and by degree of urbanization; land use change; timber volume, growth, mortality, and removals; potential forest productivity; opportunities for silvicultural treatment. The annual inventory design is based on a double sample for stratification as described by Cochran (1977, p. 327-335), but differing from Cochran's description in that both primary and second phases are permanent, systematic grids of photo and field plots and therefore, not strictly allocated proportionally by stratum. The primary plots are on a 0.85 mile (1.37 kilometer) grid that was established on base maps and transferred to aerial photos. The primary grid is subsampled by the secondary field grid. The field plot grid is laid out with 1 field plot per 6,000 acres, providing an average of one secondary field grid location for every 13 primary photo plots. The primary phase--the photo grid--is used to stratify inventoried area by land class and degree of urbanization, and, where forest land, by forest condition. The stratification reduces overall variance, resulting in more precise estimates of forest area and volume statistics. Data collected on the field plots are used to adjust area estimates developed from classification of the primary grid and to obtain comprehensive information about forest conditions that is of known precision.

Washington

All Occasions

Add text here in 2003 manual

See the previous plot layout diagrams on following pages.

Oregon

Occasion 1

All Oregon counties were assigned to one of five administrative units, the Southwest unit, West-Central, Northwest, Central, or the Blue Mountain unit. Plots were established in 1961-1962 (Southwest, West-Central, and Northwest), 1964 (Central) and 1969 (Blue Mountains) using a 10-subplot, 1-acre plot. The counties and their units are listed on page 24.

Occasion 2

At Oc2 the 1-acre, 10-subplot plots were remeasured in Douglas County in 1973, the Southwest unit in 1974, the West-Central in 1975, and the Northwest in 1976. In 1977 a new 5-subplot, 10-acre plot was established in the Central unit, and 3 of the 10 original subplots were remeasured. The Blue Mountain unit was measured in 1977 with a "walk-through" inventory that classified trees as living, mortality or cut, and which updated the seedling, sapling and tree tally.

Occasion 3

In 1984-1986 the new 5-subplot, 10-acre plot design was established in western Oregon, and 3 of the previous 10 subplots were remeasured. About 99 hardwood plot areas were projected at this time with models in western Oregon. In Central Oregon 1/6 of the 5-subplot, 7.5-acre plots were remeasured in 1986. In 1987 the remaining 5/6 of these plots were surveyed with the "walkthrough" method described above. Also in 1987, the 5-subplot, 7.5-acre plot design was established in the Blue Mountains, while 3 of the previous 10 subplots were remeasured. In eastern Oregon at this time, about 57 5-subplot, 10-acre juniper plots were established for the Oregon juniper inventory.

Occasion 4

At Oc4 the 5-subplot, 7.5-acre plot design was used for remeasurement and new data in western Oregon in 1995-1997, and for eastern Oregon timberland plots in 1998 and 1999. In 1999 approximately 600 juniper plots were established in eastern Oregon using the 4-subplot, 24.0 foot fixed-radius plot design.

Occasion 5

The current field visit cycle in Oregon is sometimes referred to as Occasion 5 (Oc5). This terminology is fading now that we are beginning to install annual inventory plots across all states, in order to avoid confusion with other states' occasions. Prior to the Occasion 5 inventory an intensified grid of 6000 acre hexagons were laid down across the state and nation. Within each hexagon one field location was selected. All previously measured phase 3 locations were retained. Most of the phase 2 locations were retained. Approximately 30% of the hexagons had a new plot location assigned.

Forest Health Monitoring Program

In 1997, forest health monitoring plots now called Phase 3 (P3) plots, were installed at the grid locations on 207 forested plots in Oregon and 144 plots in Washington. Each year crews will measure about 58 plots in Oregon and about 52 in Washington on a 5-year cycle, resulting in an eventual total of approximately 250 and 200 plots respectively. On P3 plots, tree, vegetation, lichens, ozone, and soils data are collected. P3 plots use the same 4-subplot, 24.0 foot fixed-radius design which will be installed by PNW-FIA crews in the Oc5 inventory. Copies of P3 tree tally cards will be in the plot packet.

B. Products

PNW-FIA provides information needed by resource planners, policy analysts, and others involved in forest resource decision-making. Data collected in PNW-FIA inventories is summarized, interpreted, analyzed, and published in statistical and analytical reports of national, state, and subregional scope. PNWkind and area of wildlife habitats. PNW-FIA also provides data to answer questions about forest resources.

C. Research topics

The data collected in these inventories represent a wealth of information for both applied and basic questions concerning forest ecosystems. Topics include: the distribution of plant species and their relationship to environment, the incidence of insects and disease in relation to forest type and condition, changes in forest structure in productivity due to disturbance, and improved prediction of forest growth and development on different sites and in response to management.

D. Previous plot layouts

Usually, the 5-subplot plots installed at Occasions 2 and 3 were laid out in the standard pattern diagrammed on page 13 (the older 10-point plot is diagrammed on page 243). However, subplots were installed at positions off of the standard pattern in order to keep all 5 subplots entirely within the same forest land class and stand condition (broad forest type and stand size); i.e., subplots were never split between forest and nonforest land or between different stand condition classes.

The location of subplots that were not on the standard pattern was determined one of two ways:

- 1) A substitute subplot location (a "**substituted subplot**") was adopted if the center of the standard subplot location was in different forest land class or forest condition than was present at the field grid location.
- 2) If the subplot center was in the same forest land class and forest condition class as the field grid location but was within 58.9 ft. of a different land class or forest condition class, the standard subplot center was moved (a "**moved subplot**") until 58.9 ft. inside the same forest land class and forest condition present at the field grid location.

At Oc3, a single fixed-radius plot (16.95, or 17.0-meter radius) for sampling the vegetation profile was installed at field grid locations that fell in forest land classified as other forest-rocky, chaparral, or unsuitable site (GLCs 41, 45, 46) or were at locations that ordinarily required a 5-subplot plot but were too hazardous (cliffs etc.) to allow its installation.

At Occasion 4 the 5-subplot plots installed at all western Oregon and all eastern Oregon timberland locations is diagramed below. All subplots are laid out in their standard location across condition classes to collect data about the current status of forest resources.

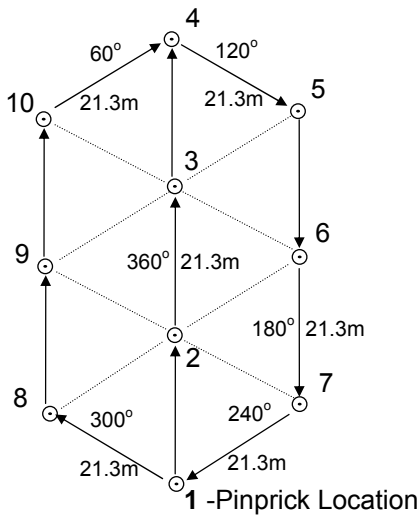

Central Oregon, Oc1;
21.3m = 70 ft

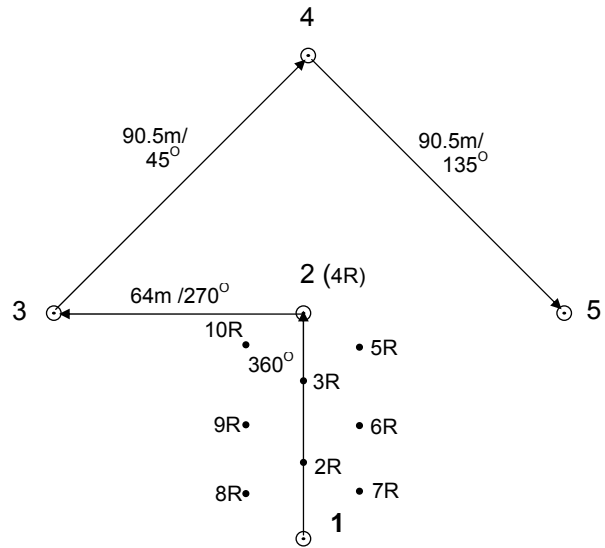

Central Oregon, Oc2
Oc3 & Oc4 (no R-points included)
Point 1 to 2 = 64m (210 ft)

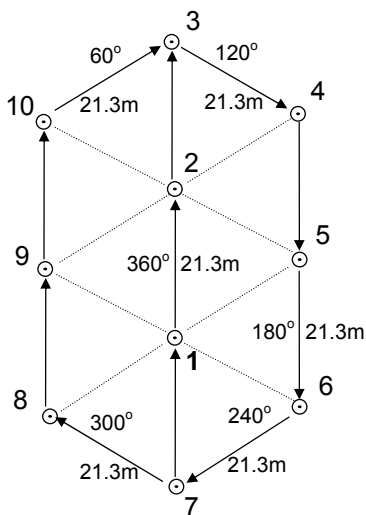

Blue Mountain Unit, Oc1 & Oc2
Puget Unit, Oc1
Olympic Unit, Oc1
21.3m = 70 ft

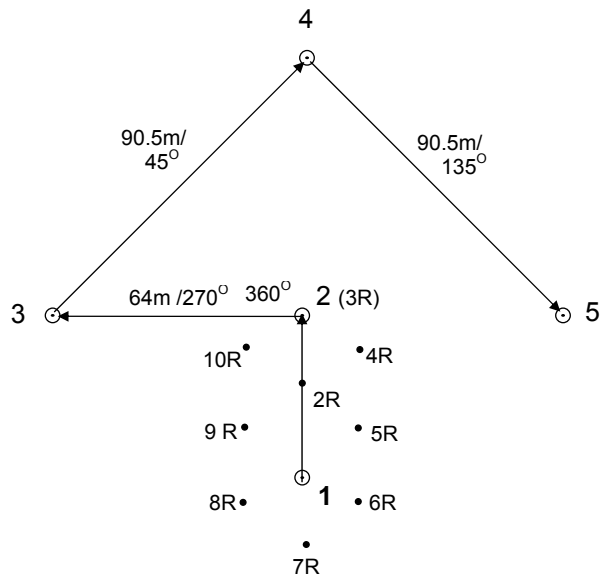

Blue Mountain Unit, Oc3
Oc4 (no R-points included)
Puget Unit, Oc1
Olympic Unit, Oc1
Point 1 to 2 = 42.6m (140 ft)

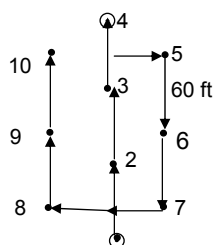

Western Oregon, Oc1 & Oc2
Southwestern WA Unit, Oc1
60 ft between points

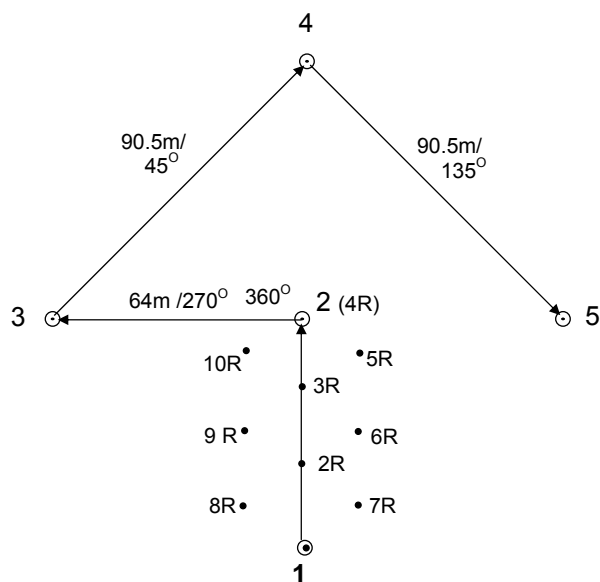

Western Oregon, Oc3
Oc4 (no R-points included)
Southwestern WA Unit, Oc2 & Oc3
Point 1 to 2 = 55m (180 ft)

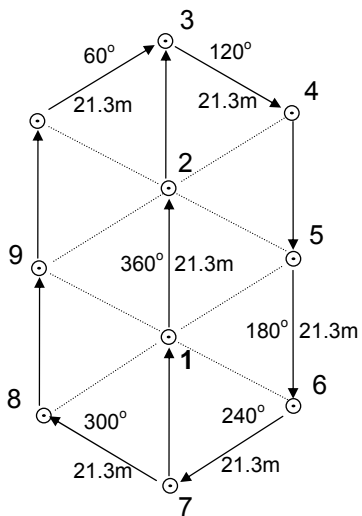

Eastern WA Unit, Oc1
60 ft between points

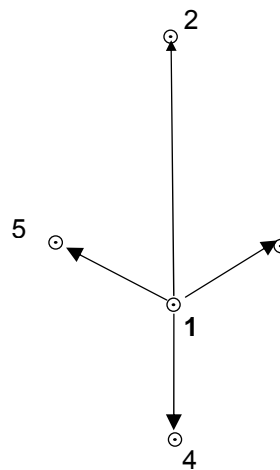

Eastern WA Unit Oc2 & Oc3 & Oc4

The 1999 Eastern Oregon juniper inventory used the same plot layout as the Annual inventory.

E. Additional sources of documentation

More information about the inventory design and procedures are available in the following documents which are on file at the office of the program in Portland, Oregon:

Forest Survey Field Instructions; Oregon and Washington – 1961-62.

Manual of Field Instructions for Forest Survey and Timber Management Inventories; Oregon and Washington – 1964.

Field Instructions for Integrated Forest Survey and Timber Management Inventories in Oregon, Washington, and California – 1969.

Forest Survey Field Instructions for Oregon, Washington, and California – 1973.

Forest Survey Field Instructions for Southwest Oregon – 1974.

Forest Survey Field Instructions for West Central Oregon – 1975.

Forest Survey Field Instructions for Northwest Oregon – 1976.

Forest Survey Field Instructions for Eastern Oregon – 1977.

Field Instructions for the Inventory Clatsop & Columbia counties, Western Oregon – 1984.

Field Instructions for the Inventory of Western Oregon – 1985-86.

Field Instructions for the Inventory of Eastern Oregon – 1986-87.

Field Instructions for the Inventory of Western Oregon – 1995-97.

Field instructions for the Inventory of Eastern Oregon – 1998.

F. Oregon plot completion

OFFICE CHECKED

Western Oregon:

All plots that are completely urban will be classified from aerial photos. The condition class will be that of the plot center.

Eastern Oregon:

All plots that were completely nonforest and field established in the 1999 juniper inventory. The condition class will be as classified in 1999.

All other nonforest plots that are completely urban, cropland, non-vegetated or rangeland with no trees in the plot vicinity will be classed from aerial photos. The condition class will be that of the plot center.

FIELD CHECKED

Western Oregon:

All completely nonforest field plots other than urban will be field checked for change to forest land. If access is denied and the plot is not visible from a public view, the plot will be classed from the aerial photo. The condition class will be that of the plot center.

Eastern Oregon:

All nonforest plots with trees visible in the plot vicinity will be field checked for forest land. If access is denied, these will be classed from the aerial photo. If accessible the plot center will get GPS coordinates.

FIELD ESTABLISHED

Western Oregon:

All forested plots.

Annual Inventory 2004
APPENDICES

Eastern Oregon:

Plots established as juniper or oak woodland in the 1999 juniper inventory will be field established in 2004, including those with no change. If a juniper plot from the 1999 inventory has burned since the 1999 inventory and no longer supports at least 10% stocking, then this condition class is called nonforest rangeland.

All other forested plots.

APPENDIX 3 -- R5 NATIONAL FOREST PLOTS - SPECIAL RULES

A. Hectare plot

A hectare plot (185.1 ft. fixed-radius plot around the center of subplot 1) will be established on R5 National Forests on plots and BLM plots within the North West Forest Plan area. The hectare plot is established on these plots even if there are no forested condition classes present on any of the subplots or annular plots.

Mapping condition classes:

Condition classes are mapped on the subplots and annular plots using normal procedures. Only additional condition classes present on the hectare plot that contain a hectare tally tree are also mapped in conditions not already delineated. Sketch the condition class on the dot-map on the back of the plot card. The approximate boundaries are entered into the BOUNDARY MAPPING for subplot 1. Attributes for these additional condition classes mapped on the hectare are assigned.

Tree Tally:

Very large trees meeting the following requirements are sampled on the hectare plot.

1. ≤ 185.1 ft horizontal distance from subplot 1 to the center of the tree at its base
2. located in an accessible (forest or nonforest) condition class
3. d.b.h ≥ 32.0 in. ("east" side plots) or ≥ 48.0 in. ("west" side plot) (North West Forest Plan area)
4. standing tree (live or dead)

Hectare trees within an annular plot radius must be referenced to that subplot. Hectare trees that are not within an annular plot radius are referenced to the any subplot center. If no hectare trees are tallied on a subplot the data recorder program will display a warning and the crew will confirm that no hectare tally trees are present.

B. Plot installation on nonforest condition classes

If the center of a subplot 1 is on R5 national forest land, and there is an accessible forest land condition class present on the subplots/annular plots, measurements are taken in all accessible (forest and nonforest) condition classes on that subplot. Measurements taken in nonforest condition classes include tree measurements, DWD, fuel loading, understory vegetation, and ground cover.

If the center of subplot 1 is on R5 national forest land, and there are no accessible forest land condition classes present on the subplots/annular plots, the plot is considered nonforest, and no measurements are taken (this plot will be installed by an R5 crew at a later date).

AN EXCEPTION: Plots on the Six Rivers, Mendocino, Shasta-Trinity, Klamath, Lassen, Modoc, Plumas, Tahoe, Eldorado, Lake Tahoe Basin Management Unit, and Stanislaus National Forests were previously reviewed in the office to exclude entirely nonforest plots. If a field visited plot on one of these National Forests is found to be entirely nonforest, measurements are taken in all accessible condition classes as described above.

C. Ground cover on NFS lands

Use the procedures listed in Chapter XIII to install ground cover transects on all field visited R5 plots.

D. Mortality assessment

Use the procedures listed on page 56 to assess mortality on previously established R5 (and non-NFS plots in CA) plots. Remember to enter this data into the data recorder when collected.

E. Monumenting within wilderness areas in Region 5

1. Plot origin (point #1) is monumented with a cedar stake and rock cairn.
2. Referenced to two permanent features (trees or rocks), no circles or squares.
3. Biodegradable paper flagging is hung at plot origin to facilitate inspection.
4. Subplots 2-4 are monumented with a metal pin and rock cairns and referenced to 2 trees (no circles used).
5. Trees over 1" DBH are tagged with aluminum tree number tags; and a nail is placed at DBH for all live trees. Tags and nails are painted brown.

6. Crew prepares plot diagram, showing RP's, and other physical features to facilitate relocation, as well as route-to-plot, etc.

F. R5 Chaparral Procedures

Chaparral plots are considered Non Forest land by the standards used in the FIA National Core Field Guide, but are measured on R5 National Forest lands. If any portion of any 58.9 ft radius annular plots contains Accessible Forest Land, the plot is not Chaparral and is installed using the standard procedures described in the preceding chapters of this field guide. If no Accessible Forest Land is present, and a Chaparral condition class is present within one or more annular plots, use the procedures below to install the plot. These instructions detail the differences between standard procedures and those for used for Chaparral plots.

INTRODUCTION--same. See paragraph above.

TRAVEL PLANNING AND LOCATING THE PLOT--same

PLOT LAYOUT AND REFERENCING

- A. Plot layout at the current annual inventory--same
- B. Census water, Denied access, Hazardous, and Not in the sample areas--same
- C. Recognition of condition classes--same
- D. Subplot numbering--same
- E. Referencing the plot
 1. Referencing a plot visited previously--Only reference plot center (sub1). Continue the same photo documentation, installing a cedar stake, 2 reference trees identified and hardware installed.
 2. Referencing plots not visited previously--same
 3. An exception--same
 4. The reference point--same
 5. Referencing the cedar stake-- If no suitable trees are available, use objects or landmarks in the area. Describe on plot card, with azimuth and distance if necessary.
 6. Referencing the microplot--Microplot dropped from chaparral survey.
- F. Referencing the other subplots on the standard layout--On points 2-4, there will be no referencing of the subplot centers. These are floating points defined by a pin in the ground with a round.
 1. Mark subplot center--Place a metal round with the pin installed in the ground. Tie flagging to the pin, and also above the pin location for ease of reference on subplot and to facilitate relocating for check cruising purposes.
 2. Select reference trees--Dropped from chaparral survey.
 3. Tag the reference trees--Dropped from the chaparral survey
 4. Record data about the reference tree--Dropped form the chaparral survey
- G. Recording reference tree data--Dropped from chaparral survey.
- H. Plot layout and referencing MQO--Same

PLOT ATTRIBUTES--Same for all items.

SUBPLOT ATTRIBUTES

- A. Subplot Identification
 - Item 1--same
 - Item 2--same
 - Item 3--Dropped from chaparral survey
- B. Physio class information--same
- C. Water information--same
- D. Boundary References--If any forested condition exists within any 58.9' annular subplot, then the entire plot (all 4 points) will be installed as a regular forested plot. *There will be no mapping of within condition changes on chaparral plots.* We will still map between different non-forest, as well as forest vs. non-forest conditions, but not within a chaparral condition.
- E. Non-forest inclusions--Dropped from chaparral survey.

- F. Root disease mapping/rating--Dropped from chaparral survey.
- G. Seedling count--Dropped from chaparral survey (no microplot).
- H. Mortality assessment--same (still only looking at trees over 5"DBH).
- I. Subplot disturbance
 - Item 1--Percentage of subplot that is burned - same
 - Item 2--Percent of mechanical manipulation - same

CONDITION CLASS ATTRIBUTES

- Item 1--same
- Condition class status
 - Item 2--Because chaparral is considered non-forest, these lands are evaluated differently. The only status valid for a chaparral defined condition, is 2. Stocking determination will change from a stem count for forestland conditions, to a percent cover of shrub species for non-forest chaparral conditions. There will have to be 10% or more cover of chaparral shrub species (species that are considered chaparral in both presence and association with other species) for a condition to be delineated. Tree species considered shrubs **must** exhibit shrub form, and **NOT** be 5" DBH/DRC, or making up 10% stem stocking within the condition area.
If an area currently has less than 10% cover of chaparral shrub species, but was either stocked in the past or currently has the potential to be stocked in the future with chaparral species (look at the surrounding area), consider the area as a chaparral condition.
Examples of this are past recent fires, mudslides or other disturbances that have affected the plot area.
 - Item 3--same
 - Item 4--same
 - Item 5--same
 - Item 6--same
 - Item 7--same
 - Item 8--same
- Non-Delineating (Ancillary) Variables for accessible forest land
 - Item 9 thru 14--same
 - Item 15 thru 38--code as found in the current chaparral condition. The significant thresholds for disturbances is still 25%, but with fire such an important factor in chaparral lands, make sure that any fire disturbance is coded even if it is under the threshold limit for the condition. Also code 'Burn Assessment' in subplot attributes as applies.
 - Item 39--same
 - Item 40--Same, just coding that which is within the condition
 - Item 41 thru 45--need to be coded for chaparral plots
 - Item 46 thru 48--same, no coding for non-forest plots (including chaparral).
 - Item 49--same, just code anything that happens to be present
- Mapping (condition class defining) variables for non-forest land conditions.
 - Item 50--same; code 45 is the only valid code for a chaparral plot since this is a non-forest survey. For other non-forest conditions, indicate which is present, if any, within each subplot. **If a plot is considered chaparral, remember that the 24-foot radius subplot is evaluated.**

SITE INDEX--

- A. Thru G. dropped from chaparral survey
- H. Stockability indicators for California--same (collected on all plots in California where applicable)

VEGETATION PROFILE

- A. Vegetation plot design--same (Remember to include sapling and seedlings in completing the vegetation profile). Also, if you have a height difference between your seedlings and saplings, remember that you can separate them out as 2 different layers within the profile for the same species.
- B. Species records
 - Is it a tree or a shrub--Some tree species have shrub variations within species that are considered shrubs. While other tree species in some sites will only grow in shrub form, and never attain tree status. If the trees within the current condition exhibit shrub form, or are identified as a shrub variation, then code as a shrub (multiple small stems, low dwarf form).

Make this determination early, for it affects how the plot will be installed and which variables are measured.

1. Species growth habit--same
2. Species--same
R5 weed list--same
3. Species height--Make sure to separate sapling and seedling (0.1 to 4.99 DBH) trees into separate layers if warranted within each subplot. The same applies for all vegetation within each subplot.
4. Species cover--Include all saplings and seedlings (0.1 to 4.99 DBH) in cover estimates due to lack of a microplot.
5. Stage of shrub development-

Code	Shrub Stage of Development
1	Immature, no dead material (stems and branches)
2	Mature, 1-24 percent dead material
3	Over-mature, 25-49 percent dead material
4	Decadent, 50-99 percent or more dead material
5	Dead, 100 percent dead material

- C. Lifeform and total vegetation records--same
- D. Collection and identification of unknown plants--same
- E. R6 indicator and weed lists--only valid in Oregon
- F. Literature cited--same

TRACKABLE TREE AND SNAG SELECTION--same

TRACKABLE TREE AND SNAG DATA

- Item 1--same
- Item x--same
- Item 2--same
- Item 3--Do not delineate between different chaparral conditions, but continue to delineate between non-forest conditions.
- Item 4 thru 8--same
- Item 9--dropped on points 2 thru 4
- Item 10 thru 49--same

NATIONAL TREE DAMAGE

Tree damage--same in all respects (not measured in 2004)

DOWN WOODY MATERIALS--Dropped from chaparral survey

GROUND COVER ON NFS LANDS

Ground cover measurements--same in all respects to the 24' transect termination. In completing this transect, it is not necessary to extend a tape, as long as the 2 segments per transect line can be accurately identified, and the correct variables given a measure of what is present.

COORDINATES (GPS)--same in all respects

LASER 200 INSTRUCTIONS--same

G. R5 National Forest and Ranger District location information

USDA Forest Service, Regional Office, R-5... Vallejo, 707-562-8737

Angeles... Arcadia, 626-574-1613
Los Angeles River ... San Fernando, 818-899-1900
San Gabriel River ... Glendora, 626-335-1251

Annual Inventory 2004
APPENDICES

Santa Clara/Mojave Rivers ... Saugus, 661-296-9710
 Chilao Visitor Center La Canada 626-796-5541
 Mt. Baldy Visitor Center Mt. Baldy 909-982-2829
 Clear Creek Info Center La Canada 626-821-6764
 Big Pines Info Center Wrightwood 760-249-3504

Cleveland... Rancho Bernardo; **858-673-6180**
 Descanso, ... Alpine, 619-445-6235
 Palomar, ... Ramona, 760-788-0250
 Trabuco, .. , Corona, 909-736-1811

Eldorado... Placerville, **530-622-5061**
 Amador, ... Pioneer, 209-295-4251
 Georgetown, ...Georgetown 530-333-4312
 Pacific, ... Pollock Pines, 530-644-2349
 Placerville, ... Camino, 530-644-2324

Inyo... Bishop, **760-873-2400**
 Lee Vining 760-647-3044
 Mammoth, Mammoth Lakes, 760-924-5500
 White Mountain, Bishop, 760-873-2500
 Mt. Whitney, Lone Pine, 760-876-6200
 Interagency Visitor Center Lone Pine 760-876-6222
 Mono Basin Scenic Visitor Center, Lee Vining 760-873-2408
 Ancient Bristlecone Pine Forest Visitor Center, 760-873-2500

Klamath...Yreka, **530-842-6131**
 Happy Camp, Happy Camp, 530-493-2243
 Goosenest, Macdoel, 530-398-4391
 Ukonom, Orleans, 530-627-3291
 Salmon River & Scott River, ... Fort Jones, 530-468-5351

Lake Tahoe Basin Management Unit ...South Lake Tahoe **530-543-4036**

Lassen... Susanville **530-257-2151**
 Almanor, ... Chester, 530-258-2141
 Eagle Lake, ... Susanville, 530-257-4188
 Hat Creek, ... Fall River Mills, 530-336-5521

Los Padres... Goleta, **805-968-6640**
 Monterey,... King City, 831-385-5434
 Mt. Pinos,...Frazier Park, 661-245-3731
 Ojai... Ojai, 805-646-4348
 Santa Barbara,... Santa Barbara, 805-967-3481
 Santa Lucia,... Santa Maria, 805-925-9538

Mendocino... Willows, **530-934-3316**
 Covelo, ... Covelo, 707-983-6118
 Grindstone, ... Willows, 530-934-3316
 Stonyford, ...Stonyford 530-963-3128
 Upper Lake, ... Upper Lake, 707-275-2361
 Genetic Resource & Conservation Center, Chico, 530-895-1176
 Paskenta Work Center, Paskenta, 530-833-5544
 Elk Creek Work Center, Elk Creek, 530-968-5329

Modoc... Alturas, **530-233-5811**
 Warner Mountain, ... Cedarville, 530-279-6116
 Big Valley, ... Adin, 530-299-3215

Annual Inventory 2004
APPENDICES

Devil's Garden, ... Alturas, 530-233-5811
Doublehead, ... Tulelake, 530-667-2246

Plumas... Quincy, **530-283-2050**
Beckwourth, ... Blairsden, 530-836-2575
Feather River, ... Oroville, 530-534-6500
Mt. Hough, ... Quincy, 530-283-0555

San Bernardino... San Bernardino, **909-382-2600**

Big Bear, ... Fawnskin, 909-866-3437
Lytle Creek 909-887-2576
San Jacinto, ... Idyllwild, 909-382-2921
Arrowhead, ...Skyforest, 909-382-2782
Mill Creek, ... Mentone, 909-794-1123

Sequoia... Porterville, **559-784-1500**
Hume Lake, ... Dunlap, 559-338-2251
Tule River/Hot Springs, ... Springville, 559-539-2607
Greenhorn, ... Lake Isabella, 760-379-5646
Cannell Meadow, ... Kernville, 760-376-3781
Hot Springs, California Hot Springs, 661-548-6503
Bakersfield Visitor Center, Bakersfield, 661-391-6088

Shasta-Trinity... Redding, **530 226-2500**
Yolla Bolla,...Plantina, 530-352-4211
Big Bar, ...Big Bar, 530 623-6106
Hayfork, ... Hayfork, 530-628-5227
Shasta Lake, ...Redding, 530-275-1587
Mt. Shasta, ...Mt. Shasta, 530 926-4511
McCloud, ...McCloud, 530-964-2184
Weaverville, ...Weaverville, 530-623-2121

Sierra... Clovis, **559-297-0706**
Bass Lake, ...North Fork, 559-877-2218
High Sierra, ...Prather 559-855-5355

Six Rivers... Eureka, **707-442-1721**
Smith River NRA, ...Gasquet, 707-457-3131
Orleans, ... Orleans, 530-627-3291
Lower Trinity, ... Willow Creek, 530-629-2118
Mad River, ... Mad River, 707-574-6233

Stanislaus... Sonora, **209-532-3671**
Calaveras, ... Hathaway Pines, 209-795-1381
Groveland, ... Groveland, 209-962-7825
Mi-Wok, ... Mi-Wuk Village, 209-586-3234
Summit, ... Pinecrest, 209-965-3434

Tahoe... Nevada City, **530-265-4531**
North Yuba, ...Camptonville, 530-288-3231
Foresthill,Foresthill, 530-367-2226
Nevada City, ... Nevada City, 530-265-4531
Sierraville, ... Sierraville, 530-994-3401
Truckee, ... Truckee, 530-587-3558
Big Bend Visitor Center, Soda Springs, 530-426-3609

Toiyabe... Sparks, **775-331-6444**
Bridgeport,...Bridgeport, 760-932-7070

H. Region 5 National Forest Contacts for FIA

FOREST#	FOREST#	FOREST	CONTACT NAME	PHONE#	E-MAIL
1	501	Angeles	Rich Borden	626-574-5255	rborden@fs.fed.us
2	502	Cleveland	Tom White	619-674-2955	twhite02@fs.fed.us
3	503	Eldorado	Tim Dabney	530-621-5221	tdabney@fs.fed.us
4	504	Inyo	Tom Higley	760-647-3032	thigley@fs.fed.us
5	505	Klamath	Rick Svlich	530-841-4521	rsvlich@fs.fed.us
6	506	Lassen	Dave Evans	530-279-6116	devans01@fs.fed.us
7	507	Los Padres	Jim Turner	805-961-5752	jmtturner@fs.fed.us
8	508	Mendocino	Nancy Mulligan	530-934-1149	nmulligan@fs.fed.us
9	509	Modoc	Bill Merrihew	530-233-8736	bmerrihew@fs.fed.us
10	510	Six Rivers	Roy Bergstrom	707-441-3553	rbergstrom@fs.fed.us
11	511	Plumas	Gary Deboi	530-283-7841	gdeboi@fs.fed.us
12	512	San Bernardino	Chris Chandler	909-884-6634	cchandler01@fs.fed.us
13	513	Sequoia	Lew Jump	209-784-1500	ljump@fs.fed.us
14	514	Shasta-Trinity	Robert Ramirez	530-242-2325	rramirez@fs.fed.us
15	515	Sierra	Mark Smith	559-297-0706	msmith04@fs.fed.us
16	516	Stanislaus	Michael Rutty	209-532-3671	mrutty@fs.fed.us
17	517	Tahoe	Jerry Westfall	530-478-6297	jwestfall@fs.fed.us
19	519	LTBMU	Scott Parsons	530-573-2687	sparsons@fs.fed.us
n/a	n/a	Region 5	Kevin Casey	916-454-0802	kcasey@fs.fed.us

I. Previously used procedures and codes in the R5 survey

R5 National Forest and Ranger District Codes

Used to identify Plots on National Forest Lands (Used in R5 past data only)

<u>Code</u>	<u>Forest</u>	<u>Code</u>	<u>Forest</u>
1	Angeles	10	Six Rivers
2	Cleveland	11	Plumas
3	Eldorado	12	San Bernardino
4	Inyo	13	Sequoia
5	Klamath	14	Shasta-Trinity
6	Lassen	15	Sierra
7	Los Padres	16	Stanislaus
8	Mendocino	17	Tahoe
9	Modoc	19	Lake Tahoe Basin

Used to Identify Ranger District Codes:

<u>National Forest (Administered)</u>	<u>Ranger District</u>	<u>Ranger District Number</u>
Angeles	Los Angeles River	51
	San Gabriel	52
	Santa Clara/Mojave Rivers	53
Cleveland	Trabuco	52
	Palomar	53
	Descanso	54
Eldorado	Amador	51

Annual Inventory 2004
APPENDICES

	Georgetown	53
	Pacific	55
	Placerville	56
	Placerville Nursery & Forest Genetics	57
Inyo	Mono Lake	51
	Mammoth	52
	White Mountain	53
	Mt. Whitney	54
Klamath	Oak Knoll	51
	Happy Camp	52
	Salmon River	54
	Scott River	55
	Gooseneck	57
	Ukonom	58
Lassen	Almanor	51
	Hat Creek	53
	Eagle Lake	58
Los Padres	Monterey	51
	Santa Lucia	53
	Santa Barbara	54
	Ojai	55
	Mt. Pinos	57
Mendocino	Corning	51
	Chico Tree Improvement	52
	Stonyford	53
	Upper Lake	54
	Covelo	56
Modoc	Warner Mt.	53
	Big Valley	54
	Devil's Garden	55
	Doublehead	56
Six Rivers	Gasquet	51
	Orleans	52
	Lower Trinity	53
	Mad River	54
	Humboldt Nursery	69
Plumas	Beckwourth	51
	Mount Hough	52
	Feather River	53
San Bernardino	Arrowhead	51
	Big Bear	52
	Cajon	53
	San Gorgonio	54
	San Jacinto	55
Sequoia	Hume Lake	51
	Tule River	52
	Hotsprings	53
	Greenhorn	54
	Cannell Meadow	56

Annual Inventory 2004
APPENDICES

Shasta-Trinity	Yolla Bolla	51
	Hayfork	52
	Big Bar	54
	Weaverville	56
	Shasta Lake	58
	Mt. Shasta	59
	McCloud	61
Sierra	Mariposa	51
	Pineridge	53
	Kings River	54
	Minarets	55
	San Joaquin Exp.Ranger	56
Stanislaus	Mi-Wok	51
	Calaveras	52
	Summit	53
	Groveland	54
Tahoe	Downieville	53
	Foresthill	54
	Nevada City	55
	Sierraville	56
	Truckee	57
Lake Tahoe Basin	Lake Tahoe Basin	51

R5 Past Plot Design

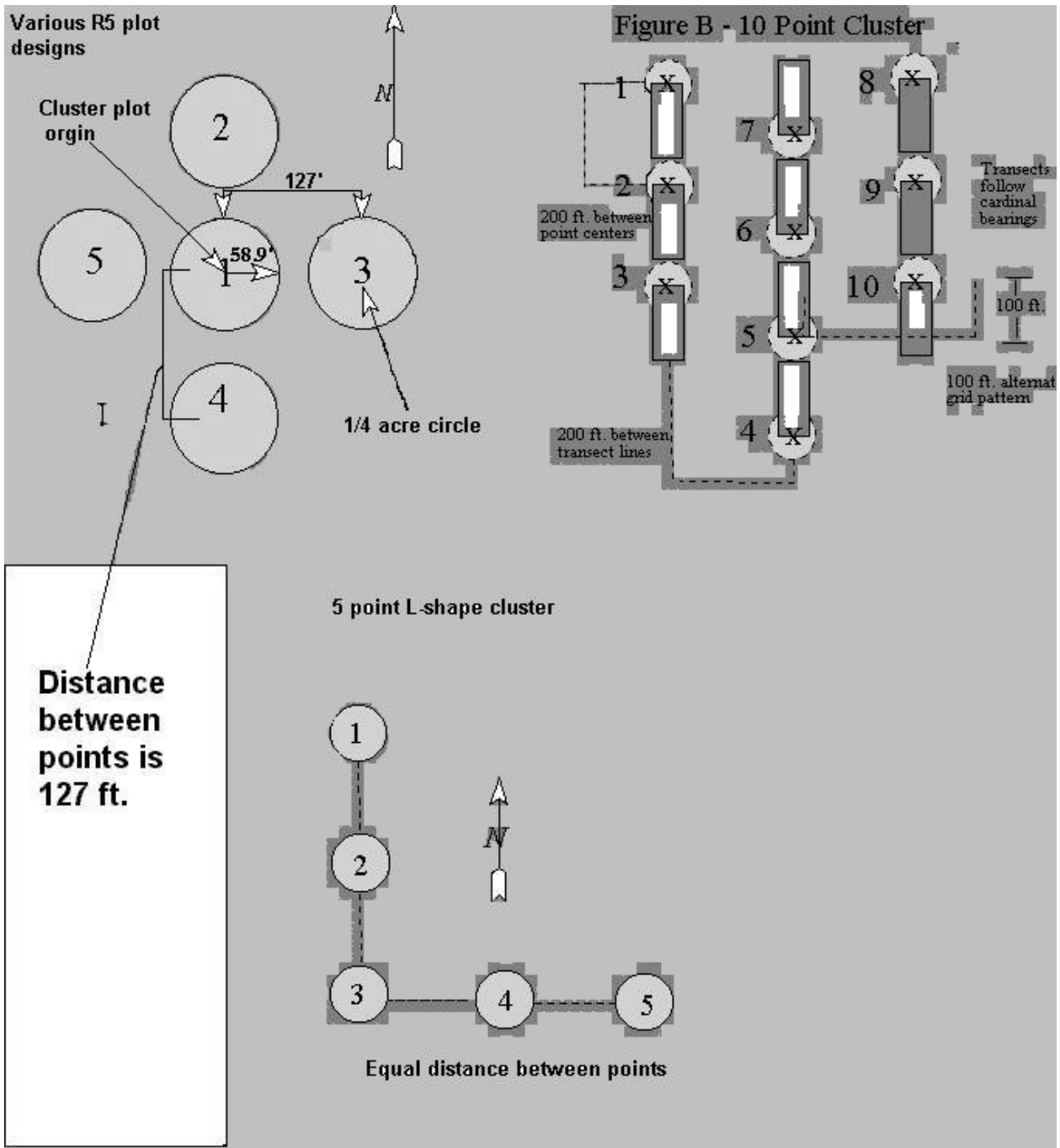

Region 5 FIA Program Species Codes and the current PNW equivalent

<u>R5 Code</u>	<u>Species</u>	<u>Scientific name</u>	<u>PNW Code</u>
1	Douglas-fir	<i>Pseudotsuga menziesii</i>	202
2	Bigcone Douglas-fir	<i>Pseudotsuga macrocarpa</i>	201
5	Redwood	<i>Sequoia sempervirens</i>	211
6	Giant sequoia	<i>Sequoiadendron giganteum</i>	212
11	Ponderosa pine	<i>Pinus ponderosa</i>	122
12	Jeffrey pine	<i>Pinus jeffreyi</i>	116
13	Sugar pine	<i>Pinus lambertiana</i>	117
14	Western White Pine	<i>Pinus monticola</i>	119
15	Lodgepole pine	<i>Pinus contorta</i>	108
19	Washoe pine	<i>Pinus washoensis</i>	137
21	Coulter pine	<i>Pinus coulteri</i>	109
22	Monterey pine	<i>Pinus radiata</i>	124
23	Gray pine (Digger pine)	<i>Pinus sabiniana</i>	127
24	Knobcone pine	<i>Pinus attenuata</i>	103
25	Bishop pine	<i>Pinus muricata</i>	120
26	Whitebark pine	<i>Pinus albicaulis</i>	101
27	Singleleaf pinyon	<i>Pinus monophylla</i>	133
28	Bristlecone pine	<i>Pinus aristata</i>	102
29	Limber pine	<i>Pinus flexilis</i>	113
30	Foxtail pine	<i>Pinus balfouriana</i>	104
31	White fir	<i>Abies concolor</i>	15
32	Red fir	<i>Abies magnifica</i>	20
33	Grand fir	<i>Abies grandis</i>	17
34	Bristlecone fir	<i>Abies brackteata</i>	14
35	Noble fir	<i>Abies procera</i>	22
37	Subalpine fir	<i>Abies lasiocarpa</i>	19
39	Pacific silver fir	<i>Abies amabilis</i>	11
42	Sitka spruce	<i>Picea sitchensis</i>	98
45	Baker cypress	<i>Cupressus bakeri</i> ssp. <i>bakeri</i>	50
46	Brewer spruce	<i>Picea breweriana</i>	92
47	Mountain hemlock	<i>Tsuga mertensiana</i>	264
48	Western hemlock	<i>Tsuga heterophylla</i>	263
51	Incense-cedar	<i>Calocedrus decurrens</i> (<i>Libocedrus decurrens</i>)	81
52	Alaska yellow cedar	<i>Chamaecyparis nootkatensis</i>	42
53	Port-Orford-cedar	<i>Chamaecyparis lawsoniana</i>	41
54	Western red-cedar	<i>Thuja plicata</i>	242
57	Monterey cypress	<i>Cupressus macrocarpa</i>	54
58	Tecate cypress	<i>Cupressus forbesii</i>	53
59	MacNab cypress	<i>Cupressus macnabiana</i>	50
61	California-nutmeg	<i>Torreya californica</i>	251
62	Pacific yew	<i>Taxus brevifolia</i>	231
63	Western juniper	<i>Juniperus occidentalis</i>	64
64	Cypress	<i>Cupressus</i> sp.	50
65	Utah juniper	<i>Juniperus osteosperma</i>	65
66	California juniper	<i>Juniperus californica</i>	62
68	Other conifers		999
70	California buckeye	<i>Aesculus californica</i>	333
71	Red alder	<i>Alnus oregona</i> (<i>rubra</i>)	351
72	Ash	<i>Fraxinus</i> sp.	540
73	Aspen	<i>Populus tremuloides</i>	746
74	White alder	<i>Alnus rhombifolia</i>	352
75	Black cottonwood	<i>Populus trichocarpa</i>	747
76	Bigleaf maple	<i>Acer macrophyllum</i>	312
77	Tree of Heaven	<i>Ailanthus altissima</i>	341

Annual Inventory 2004
APPENDICES

78	Fremont cottonwood	Populus fremontii	748
79	Engelmann oak	Quercus engelmanni	811
80	Unknown oak sp.	Quercus sp.	999
81	California black oak	Quercus kelloggii	818
82	Coast live oak	Quercus agrifolia	801
83	California white (Valley) oak	Quercus lobata	821
84	Canyon live oak	Quercus chrysolepis	805
85	Interior live oak	Quercus wislizenii	839
86	Oregon white oak	Quercus garryana	815
87	Tanoak	Lithocarpus densiflorus	631
88	Blue oak	Quercus douglassii	807
89	Willow sp.	Salix sp.	920
90	Walnut sp.	Juglans sp.	600
91	California-laurel	Umbellularia californica	981
92	California boxelder	Acer negundo californicum	313
93	Giant chinquapin	Castanopsis chrysophylla	431
94	Madrone	Arbutus menziesii	361
95	Pacific dogwood	Cornus nuttallii	492
96	Sycamore	Platanus racemosa	730
97	Eucalyptus sp.	Eucalyptus sp.	510
98	Other hardwoods		999

R5 Tree Type Measurement Codes

Prism Factors used on past R5 plots: 20 or 40 BAF.

The type of record for each item that was measured or tallied.

<u>Code</u>	<u>Record Type</u>
P	Prism tree record
M	Measured tree record for prism plot
N	Measured tree record for fixed area plot
S	Seedling record for fixed area plot
F	Fixed area plot tree/snag record
D	Down log record for fixed area plot
R	Root collar record for fixed area plot
X	Non-stockable plot

Type "S" records show the number of seedlings that exist on that point. This number would be "0" if no seedlings exist on the point and the area is capable of growing trees (does not qualify as non-stockable). If the point is non-stockable, record an X.

Even if a point has no tree or down log records at all, as a minimum the point must have **either** a null seedling record ("S" record with zero in the tree number field), or an "X" record. This assures that the point will be counted in the statistics and not dropped

Previous R5 plot measurement process. (Sequencing and methodology)

Tree/Log Number or Number of Seedlings

Size = 1-3; type = numeric

Number all trees \geq 1 inch DBH as specified starting with the first tree measured or tallied. Up to 999 trees/logs can be recorded on a single point; each tree/log must have a unique number.

The order in which the data is collected can be varied, but the following protocol is recommended.

a. Live Trees

Annual Inventory 2004
APPENDICES

1. Variable plot (trees \geq 5 inches DBH)--number all selected trees consecutively at each point. Start at true north and proceed clockwise.
2. Fixed plot (trees 1 to 4.9 inches DBH)--number all selected trees consecutively starting with next tree number after the last prism tree. Start again at true north and proceed clockwise.
3. Seedling plot (trees < 1 inch DBH) --count up to ten trees per species which are taller than six (6) inches and less than 1.0 inch DBH. Record only undamaged seedlings by species.

b. Dead Trees

1. Mortality trees. All recently dead (within the last 5 years) trees 1" to 7.9" DBH. Trees will be consecutively numbered as they are encountered starting with the next number after the 1/100 acre fixed plot trees (live saplings).
2. Snags. All dead trees within the plot, 8 inches DBH and larger, 6 feet tall and taller will be tallied. The trees will be consecutively numbered as they are encountered.

c. Down Logs

All down logs, 10 inches in diameter at the large end and 10 feet long or longer, that fall (large end in) into the fixed plot will be consecutively numbered as they are encountered.

Note: Mortality trees, snags, and down logs can be recorded and numbered consecutively as they are encountered while traversing the plot. All live trees, dead trees, snags, and logs must have a unique number on a point.

Limiting Distance tables for each factored prism of 20 and 40:
Limiting Distance = Factor X DBH;

BAF 20				BAF 40			
DBH	Dist in Feet	DBH	Dist in Feet	DBH	Dist in Feet	DBH	DIST in Feet
.01	.2	27	53.8	0.1	0.1	27	37.1
.2	.4	28	55.8	.2	.3	28	38.5
.3	.6	29	57.8	.3	.4	29	39.9
.4	.8	30	59.8	.4	.6	30	41.2
.5	1.0	31	61.8	.5	.7	31	42.6
.6	1.2	32	63.8	.6	.8	32	44.0
.7	1.4	33	65.8	.7	1.0	33	45.4
.8	1.6	34	67.8	.8	1.1	34	46.8
.9	1.8	35	69.8	.9	1.2	35	48.1
1	2.0	36	71.8	1	1.4	36	49.5
2	4.0	37	73.8	2	2.8	37	50.9
3	6.0	38	75.8	3	4.1	38	52.2
4	8.0	39	77.8	4	5.5	39	53.6
5	10.0	40	79.8	5	6.9	40	55.0
6	12.0	41	81.8	6	8.2	41	56.4
7	14.0	42	83.7	7	9.6	42	57.8
8	16.0	43	85.7	8	11.0	43	59.1
9	17.9	44	87.7	9	12.4	44	60.5
10	19.9	45	89.7	10	13.8	45	61.9
11	21.9	46	91.7	11	15.1	46	63.2
12	23.9	47	93.7	12	16.5	47	64.6
13	25.9	48	95.7	13	17.9	48	66.0
14	27.9	49	97.7	14	19.2	49	67.4
15	29.9	50	99.7	15	20.6	50	68.8
16	31.9	51	101.7	16	22.0	51	70.1
17	33.9	52	103.7	17	23.4	52	71.5
18	35.9	53	105.7	18	24.8	53	72.9

Annual Inventory 2004
APPENDICES

19	37.9	54	107.7	19	26.1	54	74.2
20	39.9	55	109.7	20	27.5	55	75.6
21	41.9	56	111.7	21	28.9	56	77.0
22	43.9	57	113.7	22	30.2	57	78.4
23	45.9	58	115.7	23	31.6	58	79.8
24	47.9	59	117.6	24	33.0	59	81.1
25	49.9	60	119.6	25	34.4	60	82.5
26	51.8			26	35.8		
Factor = 1.994				Factor = 1.375			

R5 plot sizes

Examples of Fixed Plot Codes

<u>Code</u>	<u>Plot Size</u>	<u>Plot Dimensions</u>
1000	1 acre (1.00)	
500	1/2 acre (.50)	66' X 330' rectangle
500	1/2 acre (.50)	83.3' radius circle
250	1/4 acre (.25)	66' X 165' rectangle
250	1/4 acre (.25)	33' X 330' rectangle
250	1/4 acre (.25)	58.9' radius circle
200	1/5 acre (.20)	52.7' radius circle
125	1/8 acre (.125)	33' X 165' rectangle
125	1/8 acre (.125)	41.6' radius circle
100	1/10 acre (.010)	37.2' radius circle
25	1/40 acre (.025)	18.6' radius circle
10	1/100 acre (.001)	11.8' radius circle

Note: Plot dimensions are in horizontal distances

Previous R5 standing dead tree codes

Dead Trees. The following codes will be used for snag condition class:

<u>Code</u>	<u>Description</u>
S1	Dead from 0 to 5 years and salvable. Refer to published "Timber Marking Guides" for each forest for additional information on what qualifies a tree as "salvable".
D1	Dead from 0 to 5 years, not salvable. Beetles have riddled bark, cambium and sapwood with holes and galleries; bark is loosened.
D2	Bark and sapwood has been mined extensively by beetles; softening of the wood allows hole nesting birds to excavate cavities; tops begin to break off.
D3	Sapwood decayed considerably and partially sloughed. Height has decreased; only stubs of the largest limbs remain.
D4	Sapwood has all sloughed off and no sound heartwood remains; chunks of wood and bark have accumulated in a mound around the base.
D5	Snag has reached equilibrium; roots of invading shrubs and trees have stabilized the sloughing of decomposed wood and bark.

Previous R5 down log codes

Code Description

- L1 Bark intact, twigs present. Texture is intact. Wood is original in color. Log is elevated on supported points above ground.
- L2 Bark intact, twigs absent. Texture is intact to partially soft. Wood is original color. Log elevated on supported points but sagging slightly.
- L3 Trace of bark. Twigs are absent and texture is hard large pieces. Color of wood is original to faded. Log is sagging near ground.
- L4 Bark and twigs are absent. Texture of wood is small, soft, blocky pieces. Wood is light brown to faded brown or yellowish. All of the log is on the ground.
- L5 Bark and twigs are absent. Texture of wood is soft and powdery. Color of wood is faded to light yellow or gray. The diameter of the log is attainable, and log debris is not spread out in a flat manner. If a diameter is not attainable, and the log configuration is not discernable, then it is not considered a log but a pile of debris.

Previous R5 vegetation profile information description

Field 1, Record Type

Size = 1; type = alpha

Record the record type for the individual(s) being sampled.

When seedlings and sapling size conifers and hardwood trees are collected in the tree samples on the Tree Plot Record, do not collect data on these species groups as part of the understory vegetation.

Code Explanation

C	Conifer
H	Hardwood
B	Shrub (Brush)
E	Herbaceous
G	Grasses
K	Special Features
Z	Other

Fields 2, Point Number

Size = 1-2; type = numeric

Record the point number at which the information is being taken.

Field 3, Number of Stems (Optional)

Size = 1-3; type = numeric

Record the number of stems (abundance) when this field is necessary. This is not a required field. Number of stems can be recorded as a raw value (up to 3 digits) or as a numeric code representing an abundance class.

Field 4, Plot Factor

Size = 1-4; type = numeric

Record the fixed plot code for the area being sampled. A 1/2 acre plot is usually used, and recorded as 500. Plot sizes other than 1/2 acre can be used where appropriate. Refer to Section 420, Field 4, Plot Factor for a complete list of plot factor codes.

Field 5, Species

Size = 4-5; type = alphanumeric

For each species group: conifer, hardwood, shrub (brush), herbaceous, and grasses, record the three most common species in order of prevalence.

Sample of R5 data sheet

Record Type	Subplot number	Forest	Tree Number	Species	Plot radius or BAF Factor	Plot number	Crown Class	Date of last plot visit	Age
A	16	1	150	52	000	0000	09/1999	N -	4903 4 7 048 3 1
M	1	003	40	11	D	5 0 00 -	223	98 97 5 11	
P	1	004	40	11	C	5 0 00 -	120		
F	1	005	250	51	D	6 0 00 -	503	105	
P	1	006	40	11	C	6 0 00 -	146		
P	1	007	40	11	D	6 0 00 -	262		
P	1	008	40	84	I	7 0 00 -	62	19	
N	1	014	10	13	I	5 0 00 -	12	8 57	1
F	1	016	10	84	I	5 0 00 -	40		
F	1	017	10	84	I	4 0 00 -	32		
F	1	018	10	13	I	6 0 00 -	32		
S	1	010	10	84				1	
S	1	001	10	13				2	
P	2	019	40	11	D	6 0 21 -	395		
P	2	021	40	11	D	4 0 21 -	250		
M	2	022	40	13	D	6 0 00 -	360	99 270 3 7	
P	2	023	40	51	C	6 3 00 -	305		
P	2	024	40	11	C	3 0 21 -	247		
P	2	025	40	11	D	7 0 00 -	359		
P	2	026	40	51	D	7 2 00 -	275		
F	2	027	250	11	C	1 0 D3 -	240	15	
F	2	028	250	13	D	7 0 21 -	455		
S	2	006	10	84				4 999	
S	2	002	10	13				4	
S	2	001	10	51				2	
D	2	029	125	51		L4 -	320	20	
D	2	030	125	13		L2 -	100	10	

APPENDIX 4 -- R5 OFF NATIONAL FORESTS

A. The Inventory of California

Background.

In California, PNW-FIA collects data on all lands, across all ownerships, including National Forests and reserved areas such as State and National Parks. The State has been divided into six inventory units: North Coast, North Interior, Sacramento, Central Coast, San Joaquin, and Southern. The annual inventory of California represents the fourth measurement of plots established by PNW-FIA. California plots were previously measured in 1965-1972, OCC1; 1981-1984, OCC2; and in 1991-1994, OCC3. The current Annual Inventory effort is OCC4.

At OCC1 plots were selected from a .85 mile primary sample grid using Stratified Random sampling. This method utilized several different scale photos and selected plots Outside National Forests and all reserved lands (Municipal, State, and National Parks) only. The actual plot was of a 10-point configuration and was not mapped, and only Timberland plots were established and measured on the ground. At OCC 2, a more standardized 3.4 mile base grid was used in plot selection, with woodlands plot only being established using a 6.8 mile grid resulting in every 4th woodland plot being measured. At this time, some plots from the Soil Conservation Service (currently the National Resource Conservation Service, NRCS) were incorporated in to the selection process thus augmenting the selection process from the grid selection method. The plot design varied between a 5 point design for new installed plots to a 3 point design for remeasured plots from OCC1. At OCC3, further refinement of the plots selection process continued. The field plot grid was spaced again at 3.4 mile intervals, but little augmentation was applied in selecting plot off this grid. No juniper plots were sampled, and the oak woodland plots were again established so that only every second plot using both the 3.4 grid was measured. Although the field grid was established in 1981, about half of the plots are at locations established before 1981.

Inventory Design

The California annual inventory design is based on a double sample for stratification as described by Cochran (1977, p. 327-335), but differing from Cochran's description in that both primary and second phases are permanent, systematic grids of photo and field plots and therefore, not strictly allocated proportionally by stratum. The primary plots are on a 0.85 mile (1.37 kilometer) grid that was established on base maps and transferred to aerial photos. The primary grid is sub-sampled by the secondary field grid. The field plot grid is laid out with 1 field plot per 6,000 acres, providing an average of one secondary field grid location for every 13 primary photo plots. The primary phase--the photo grid--is used to stratify inventoried area by land class and degree of urbanization, and, where forest land, by forest condition. The stratification reduces overall variance, resulting in more precise estimates of forest area and volume statistics. Data collected on the field plots are used to adjust area estimates developed from classification of the primary grid and to obtain comprehensive information about forest conditions that is of known precision. In addition, large areas of continuous non-forest--the "non-forest zone"-- such as extensive agricultural, urban areas, chaparral, and desert are not sampled.

Forest Health Monitoring Program

Since 1992, Forest Health Monitoring plots now called Phase 3 (P3) plots have been established on a subset of FIA Phase 2 (P2) plots across all lands in California. One fifth of these forested plots (approximately 80) are measured each year, resulting in a total of approximately 400 plots. Since P3 plots utilize the same plot design as the P2, any collocation of these plots results in a lichen survey, erosion assessment, soils sample, and crown rating for health monitoring purposes on the P2 plot location.

Additional sources of inventory documentation.

More information on the procedures followed in the 1991-1994 inventory of California is available from the following documents, on file at the PNW-FIA Lab in Portland, Oregon:

1. *Field instructions for the inventory of California --1965/72, 1981-1984.*
2. *California PI manual for 1981-84.*
3. *California PI manual for 1991-94.*
4. *California inventory techniques manual and study plan.*
6. *Complete documentation for the inventory of California, 1991-1994.*

7. Field Instructions for the Annual Inventory of Oregon and California, 2002
8. Forest Inventory and Analysis National Core Field Guide: Phase 2 Version 1.4 February 2000
9. Forest Inventory and Analysis National Core Field Guide: Phase 2 Version 1.5 2001
10. Forest Inventory and Analysis National Core Field Guide: Phase 2 Version 1.6 2002
11. Region 5 FIA Users Guide, 2000.

History of Survey in CA, all Occasions:

- OCC 1 1965-1972
- OCC 2 1981-1984
- OCC 3 1991-1994
- OCC 4 2001-2011

B. PNW Past Occasion Plot layout

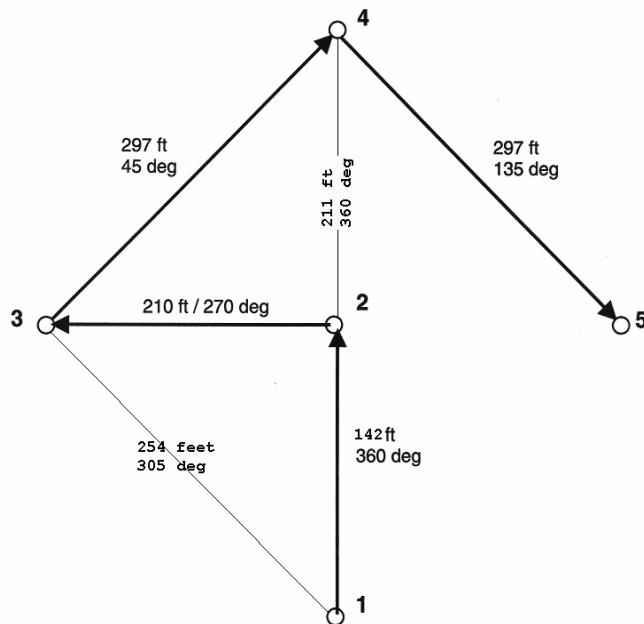

C. PNW Tree History Codes and definitions from the previous inventory (Oc3)

Tree history (TH). 2-digit code needed for all trees. The first digit is code 1-5 and indicates the condition class that the tree is located in. The second digit indicates the tree history.

Cond Class	TH	Tree History	Description
1-5	0	No tally	Enter a line with TH 0 for subplots that do not have any live tally trees (TH 1,2,4,6). Enter a line for nonforest subplots and GLC 44 subplots, which are not on the 11K grid.
1	1	Remeasured	Tree tallied live at OCC2 and still live at OCC3.
1	2	New: re-constructed	Live tree in condition class 1 tallied for the first time at OCC 3.
2-5	2	New: not re-constructed	Live tree in condition class 2-5 at OCC 3.
1	3	Culturally-killed	Culturally-killed tree that was live at OCC 2. Tree was not harvested. It can be a stump, standing, or felled. Include trees killed in logging but not felled. Not tallied on N# subplots.
1	4	OCC3	Tree tallied live at OCC 3 on 10.8 feet fixed radius plot which was not

		Ingrowth	alive at OCC 2 or was < 1 inch at OCC 2. Not tallied on N# subplots.
1	5	Mortality	Tree tallied or reconstructed as live at OCC 2 but now dead. Death was natural and not due to human activity. Include partially uprooted windthrows leaning more than 45 degrees. If the dead tree qualifies as a snag, record snag information on a separate line with the same 5-digit line # and a TH 7. Not tallied on N# subplots.
1	6	Missed tree	Live tree on a remeasured subplot, which should have been tallied at OCC 2. Or a tally tree on the 10.89 feet fixed radius which was > 1 inch dbh at OCC 2 but did not qualify for tally at OCC 2. Requires reconstruction. Not tallied on N# subplots.
1-5	7	Snag	A standing dead tree which is ≥ 9 inches dbh and ≥ 6.6 feet tall at OCC 3. <u>On remeasured subplots:</u> Leave as TH 7 a snag tallied at OCC 2 but gone at OCC 3; leave as TH 7 a snag tallied at OCC 2 but < 9 inches dbh or < 6.6 feet tall at OCC 3. Do not tally snags on remeasured subplots which have "grown in" since OCC 2 and died, but tally missed snags..
1	8	Harvested	A tree tallied or reconstructed as live and ≥ 5 inches dbh at OCC 2 which has been harvested for industrial supply, firewood, local use or incidental reasons. Not tallied on N# subplots.
1-5	9	Reference	Reference only.

D. Sudden Oak Death (SOD) Syndrome

Any time PNW Damaging Agent **31** is coded, a sample of the damage is required.

+/- bleeding- Surveyor needs to check bole of coast live oak (*Quercus agrifolia*), California Black Oak (*Quercus kelloggii*), and tanoak (*Lithocarpus densiflorus*) for bleeding.

+/- leafspots on known hosts- bay laurel (*Umbellularia californica*), rhododendron (*rhododendron spp.*), toyon (*Heteromeles arbutifolia*), big leaf maple (*Acer macrophyllum*), Buckeye (*Aesculus californica*).

If symptoms are found, a sample should be taken as follows:

Bleeding trees – If ooze is present, use a vial and try to collect some for analysis. Label the vial with hex number, species, tree number (if applicable), and date of collection.

Leafspots – Collect symptomatic leafspots, 20 leaves total. If more than one host, can be a mix (ie 10 bay leaves + 3 rhododendron leaves + 2 toyon leaves and 5 big maple leaves). Bay is the preferred host for isolation, so if it is present, select 10 leaves. If more than one bay tree is present with symptoms, collect samples from each bay tree with leafspots. Samples should strive to include all hosts with leafspots. Clip the twigs with the leaves attached and send the entire branch tip since this keeps specimens fresher longer.

Vials with ooze or leaves should be double bagged and labeled with location information (hex, county, date of collection, crew). A clean dry paper towel should be inserted in the bag with the leaves to absorb excess moisture. Crew will mail the sample in to CDFA (address below). The material should be kept as cool as possible after collection has occurred. Mailing labels and containers will be supplied for each crew.

A PDR collection slip should be filled out.

Owner name slot	"Private"
Address	leave blank
Collector	"PNW-FIA"
Quarantine Origin	County name of where specimen was collected
Destination	Sacramento
Host collected	species name of sample
Remarks section	what checking for, and what is being submitted, either leaf or ooze samples
Send Report to	503-808-2020 attn: Bob Rhoads
Upper left corner	Township, Range, and Section

Mail all samples collected to: Cheryl Blomquist

California Department of Food and Agriculture
Plant Pest Diagnostics Branch
3294 Meadowview Road
Sacramento, CA 95832-1448

Each crew will call ahead or email Cheryl that they intend to ship samples to her. Her phone is **(916) 262-1870**, email is Cblomquist@cdfa.ca.gov.

APPENDIX 5 -- SLOPE CORRECTION TABLE

	EXPANSION		-----SLOPE DISTANCE-----			
	PERCENT EXPANSION FACTOR	FACTOR RECIPROCAL	24.0 ft.	58.9 ft.	100 ft.	185.1 ft.
10	1.005	0.995	24.1	59.2	100.5	186.0
15	1.01	0.99	24.3	59.6	101.1	187.2
20	1.02	0.98	24.5	60.1	102.0	188.8
25	1.03	0.97	24.7	60.7	103.1	190.8
30	1.04	0.96	25.1	61.5	104.4	193.3
35	1.06	0.94	25.4	62.4	105.9	196.1
40	1.08	0.93	25.8	63.4	107.7	199.4
45	1.10	0.91	26.3	64.6	109.7	203.0
50	1.12	0.89	26.8	65.9	111.8	206.9
55	1.14	0.88	27.4	67.2	114.1	211.2
60	1.17	0.86	28.0	68.7	116.6	215.9
65	1.19	0.84	28.6	70.2	119.3	220.8
70	1.22	0.82	29.3	71.9	122.1	225.9
75	1.25	0.80	30.0	73.6	125.0	231.4
80	1.28	0.78	30.7	75.4	128.1	237.0
85	1.31	0.76	31.5	77.3	131.2	242.9
90	1.35	0.74	32.3	79.2	134.5	249.0
95	1.38	0.72	33.1	81.2	137.9	255.3
100	1.41	0.71	33.9	83.3	141.4	261.8
105	1.45	0.69	34.8	85.4	145.0	268.4
110	1.49	0.67	35.7	87.6	148.7	275.2
115	1.52	0.66	36.6	89.8	152.4	282.1
120	1.56	0.64	37.5	92.0	156.2	289.1
125	1.60	0.62	38.4	94.3	160.1	296.3
130	1.64	0.61	39.4	96.6	164.0	303.6
135	1.68	0.60	40.3	99.0	168.0	311.0
140	1.72	0.58	41.3	101.3	172.0	318.5
145	1.76	0.57	42.3	103.7	176.1	326.0
150	1.80	0.55	43.3	106.2	180.3	333.7
155	1.84	0.54	44.3	108.6	184.5	341.4

APPENDIX 6 -- DETERMINATION OF STOCKING VALUES FOR LAND USE CLASSIFICATION

Stocking values are required to determine if a CONDITION STATUS = 1 (accessible forest land) exists on a plot. This will determine which data items must be recorded for the condition. When the CONDITION STATUS is in question (usually a nonforest area that is in the process of reverting to forest land or a marginal site that can only support a low number of trees), the crew must determine if there is sufficient stocking to classify the condition as forest. A minimum stocking value of 10 percent is required for accessible forest land (unless the condition was previously forested, such as a recent clear cut).

The following tables show the stocking values to assign to trees or the number of trees per acre to determine if a plot meets the minimum stocking to be considered forest land. In the determination of stocking for this purpose, the field crew should consider the condition over its entire area, not just the trees and seedlings that would be tallied on the subplots and microplots, especially when the plot straddles conditions. Also, for stocking purposes, consider a clump of trees (e.g., stump sprouts) less than 5 inches DBH to be a single tree.

The number of trees per acre needed to obtain minimum stocking depends on the DBH of the largest tree on the plot in the condition being evaluated, and the species and DBH of each of the tally trees. If the condition occurs on all four subplots and the trees are distributed fairly evenly over the entire condition area, the following steps can be used to determine if the condition has the minimum number of trees per acre for forest land.

Observe all of the trees on the plot and classify the condition, based on the tree with the largest DBH, into one of the following groups; the largest tree observed has a DBH of 5 inches or greater, 4.0-4.9 inches, 3.0-3.9 inches, 2.0-2.9 inches, 1.0-1.9 inches or less than 1.0 inch DBH. If you are using the *Stocking Values* table to determine if the condition meets minimum stocking, use table 5a, 5b, 5c, 5d, 5e, or 5f. For trees <5", use table 5c because tally from microplots can be highly variable. If you are using the *Number of Trees* table to determine if the condition meets minimum stocking, use table 5g.

When using a *Stocking Values* table, begin a tally of each subplot and microplot and sum the stocking values for each tree tallied based upon its species and size class. When the stocking values for the tallied trees equals or exceeds 10, the condition meets the minimum stocking requirement for forest land.

For example, a condition that was formerly nonforest is no longer being maintained as nonforest and has begun to revert. A check of all four subplots and microplots confirms that the largest tree there is in the 3.0 – 3.9 inches DBH class. The tally of microplot 1 is one red maple (species code = 316) seedling. The sum of the stocking value (table 5a) to this point is 2.4 and the tally continues on microplot 2.

Subplot Number	Plot Type	Species	Size Class	Number Tallied	Stocking Value
1	2	316	< 1.0	1	2.4
Total					2.4

The tally at microplot 2 is two red maple seedlings. The stocking value for the two seedlings is 4.8. The cumulative stocking value to this point is 7.2. Since the minimum value of 10 percent stocking has not been reached, the tally continues to subplot 3.

Subplot Number	Plot Type	Species	Size Class	Number Talled	Stocking Value
1	2	316	< 1.0	1	2.4
2	2	316	< 1.0	2	4.8
Total					7.2

At microplot 3 one sugar maple (species code = 318) sapling in the 1.0 – 1.9-inch DBH class is tallied. The cumulative stocking value is now 13.1 and the condition meets the minimum stocking to be considered forest land.

Subplot Number	Plot Type	Species	Size Class	Number Talled	Stocking Value
1	2	316	< 1.0	1	2.4
2	2	316	< 1.0	2	4.8
3	2	318	1.0 – 1.9	1	5.9
Total					13.1

When trees of more than one diameter class are present, their contribution towards meeting the minimum must be combined. For example:

In a lodgepole pine stand (species code = 108), the largest tree in the condition is 5.0+ inches DBH. If at least 20 trees that are 5.0-6.9 inches DBH are found on the four subplots, the minimum stocking of 10 percent (table 5b: 5th row, 1st column) is met. In the same condition only 5 tally trees in the 13.0-14.9-inch DBH class are needed to meet minimum stocking of 10 percent. If the tally were three 5.0-6.9-inch trees and two 13.0-14.9-inch DBH class trees (total stocking of $3 \times 0.5 + 2 \times 2.2 = 5.9$), the combined stocking would not meet the minimum 10 percent ($5.9 < 10$) and the condition would be classified nonforest.

When using the *Number of Trees* table (table 5g), estimate the number of trees per acre by the diameter classes. When a condition exists on all 4 of the 24-ft radius subplots, each tally tree (DBH \geq 5.0 inches) represents 6 trees per acre and each sapling (DBH \geq 1.0 inch to $<$ 5.0 inches) or seedling observed on the 4 microplots represents 75 trees per acre.

In sparse stands of smaller trees, a more accurate observation of trees per acre can be determined by observing trees $<$ 5.0 inches DBH on the 24-ft radius subplot. In many forest types no more than 180 trees per acre of the largest diameter class are needed to meet the minimum stocking requirements, a total of 30 trees on all 4 subplots, 7 or 8 smaller trees on each subplot, will provide minimum stocking.

Other things observed on the plot will influence the determination of condition status. In the last lodgepole pine example, evidence of a recent disturbance that reduced the stocking (cutting, fire, etc.) should be considered. Also, a very uneven distribution of the trees across the condition can greatly change the observed number of trees per acre on plots installed across the condition.

If the condition does not cover all four subplots entirely, trees per acre must be expanded using an expansion factor. The expansion factor is equal to $400/\text{sum of the percent of subplot area (\%ARE)}$ for the condition. The trees per acre value of every diameter class is multiplied by this expansion factor.

If the trees are not uniformly distributed throughout the condition or the condition occurs on only a small portion of the plot (half the plot or less), use your best judgment in assigning status. You may place several additional temporary subplots in the condition in order to get a larger sample to base stocking on.

When additional temporary subplots or judgment is used to assign land use, a note should be made on the plot sheet. Use the following procedure to establish these temporary subplots in a condition:

- A. Consider locations 120.0 feet horizontal distance from the highest numbered subplot in the condition. First consider the location 0° azimuth from the subplot center. If this location is unsuitable, consider in order locations at azimuth 120°, and 240°. When a suitable location has been found, establish the temporary subplot. Temporary subplots should be entirely within the condition (locations should not be within 24.0 feet of a mapped boundary).
- B. If Step A fails to yield a suitable subplot location, repeat Step A at each of the next highest-numbered regular subplots in the condition.
- C. If Steps A and B have been exhausted and a suitable temporary subplot still has not been found, repeat Step A at each temporary subplot in turn, beginning with the first temporary subplot that was established.

If more than one temporary subplot is to be established, repeat Steps A and B to establish the second lowest-numbered temporary subplot next, and continue in order until you have enough temporary subplots established in the condition to get a good, representative estimate of stocking. The general rule for establishing temporary subplots is:

- Install the lowest temporary subplot off the highest established subplot, until all the established subplots have been exhausted.
- Then establish the lowest temporary subplot yet to be established off the lowest one already established (lowest off highest, then lowest off lowest).

If there is a transition zone between two conditions use your best judgment to be sure that trees tallied in the transition zone do not have too much weight in the assignment of a land use.

Annual Inventory 2004
APPENDICES

Table 5a. Stocking values for all tallied trees on the four subplots and microplots																					
	DBH of the largest tally tree in the condition																				
	5.0+						4.0-4.9					3.0-3.9				2.0-2.9			1.0-1.9		Seedling
	DBH of tally tree						DBH of tally tree					DBH of tally tree				DBH of tally tree			DBH of tally tree		Seedling
Species	5.0-6.9	4.0-4.9	3.0-3.9	2.0-2.9	1.0-1.9	Seed-ling	4.0-4.9	3.0-3.9	2.0-2.9	1.0-1.9	Seed-ling	3.0-3.9	2.0-2.9	1.0-1.9	Seed-ling	2.0-2.9	1.0-1.9	Seed-ling	1.0-1.9	Seedling	Seedling
19, 93	0.7	6.9	5.2	4.0	2.6	1.2	7.9	6.2	4.6	3.0	1.4	7.6	5.7	3.7	1.8	7.4	4.9	2.3	7.2	3.5	7.0
72, 73	0.6	5.6	4.3	3.3	2.1	1.0	6.4	5.1	3.8	2.5	1.1	6.3	4.6	3.0	1.4	6.1	4.0	1.9	5.9	2.9	5.7
130, 299	1.0	9.1	6.9	5.3	3.4	1.6	10.4	8.3	6.1	4.0	1.9	10.1	7.5	4.9	2.3	9.9	6.5	3.1	9.6	4.7	9.3
108	0.5	5.0	3.7	2.9	1.9	0.8	5.7	4.5	3.3	2.2	1.0	5.5	4.1	2.7	1.3	5.4	3.5	1.7	5.2	2.5	5.1
103, 104, 119	0.4	4.2	3.1	2.4	1.6	0.7	4.7	3.8	2.8	1.8	0.8	4.6	3.4	2.2	1.1	4.5	2.9	1.4	4.4	2.1	4.2
53, 54, 55, 62, 64, 65, 66, 101, 102, 106, 109, 113, 116, 117, 120, 122, 124, 127, 133, 137, 138, 139, 321, 475, 756, 757, 758, 811	0.5	5.0	3.8	2.9	1.9	0.9	5.7	4.6	3.4	2.2	1.0	5.6	4.1	2.7	1.3	5.4	3.6	1.7	5.3	2.6	5.1
15, 201, 202, 511	0.7	6.8	5.1	4.0	2.6	1.2	7.7	6.2	4.6	3.0	1.4	7.5	5.6	3.7	1.7	7.3	4.8	2.3	7.1	3.5	6.9
11, 14, 17, 20, 21, 22, 41, 42, 81, 92, 98, 231, 242, 251, 263, 264	0.5	4.8	3.6	2.8	1.8	0.8	5.4	4.3	3.2	2.1	1.0	5.3	3.9	2.6	1.2	5.1	3.4	1.6	5.0	2.4	4.8
211, 212	0.4	3.8	2.9	2.2	1.4	0.6	4.3	3.4	2.5	1.7	0.8	4.2	3.1	2.0	1.0	4.1	2.7	1.3	4.0	1.9	3.8
312, 341, 421, 631, 763, 768, 821, 997, 999	1.0	9.6	7.2	5.6	3.6	1.6	10.9	8.7	6.4	4.2	2.0	10.6	7.9	5.2	2.4	10.3	6.8	3.3	10.0	4.9	9.8
351, 352, 492	1.3	11.7	8.8	6.8	4.4	2.0	13.3	10.6	7.9	5.1	2.4	13.0	9.6	6.3	3.0	12.6	8.3	4.0	12.3	5.9	11.9
333	1.2	10.9	8.2	6.3	4.1	1.8	12.4	9.8	7.3	4.8	2.2	12.1	9.0	5.9	2.8	11.7	7.7	3.7	11.4	5.5	11.1
375	1.1	10.5	7.9	6.1	4.0	1.8	12.0	9.5	7.1	4.6	2.1	11.6	8.7	5.7	2.7	11.3	7.4	3.6	11.0	5.3	10.7
361, 431, 661, 801, 805, 807, 815, 818, 839, 981	1.2	11.6	8.8	6.8	4.4	2.0	13.2	10.5	7.8	5.1	2.4	12.9	9.6	6.3	3.0	12.5	8.2	3.9	12.2	5.9	11.8
603, 604	1.4	12.7	9.6	7.4	4.8	2.2	14.5	11.5	8.5	5.6	2.6	14.1	10.5	6.9	3.2	13.7	9.0	4.3	13.3	6.5	12.9
741, 746	1.2	10.9	8.3	6.4	4.1	1.9	12.5	9.9	7.3	4.8	2.2	12.1	9.0	5.9	2.8	11.8	7.8	3.7	11.5	5.6	11.1
540, 542	1.0	9.3	7.0	5.4	3.5	1.6	10.6	8.4	6.3	4.1	1.9	10.3	7.7	5.0	2.4	10.0	6.6	3.2	9.8	4.7	9.5
313, 345, 463, 730, 747, 748	1.2	10.8	8.1	6.3	4.1	1.8	12.3	9.8	7.2	4.7	2.2	12.0	8.9	5.8	2.7	11.6	7.6	3.7	11.3	5.5	11.0

Annual Inventory 2004
APPENDICES

Table 5b. Stocking values for all trees tallied on the subplot only													
Species	5.0-6.9	7.0-8.9	9.0-10.9	11.0-12.9	13.0-14.9	15.0-16.9	17.0-18.9	19.0-20.9	21.0-22.9	23.0-24.9	25.0-26.9	27.0-28.9	29.0+
19, 93	0.7	1.1	1.6	2.1	2.6	3.2	3.8	4.4	5.1	5.8	6.5	7.2	8.0
72, 73	0.6	1.0	1.5	2.0	2.6	3.3	4.0	4.9	5.7	6.7	7.6	8.7	9.8
130, 299	1.0	1.5	2.2	3.0	3.8	4.7	5.6	6.6	7.7	8.9	10.1	11.4	12.7
108	0.5	0.9	1.3	1.7	2.2	2.8	3.4	4.1	4.8	5.6	6.4	7.3	8.2
103, 104, 119	0.4	0.7	1.1	1.5	1.9	2.4	3.0	3.6	4.2	4.9	5.6	6.4	7.2
53, 54, 55, 62, 64, 65, 66, 101, 102, 106, 109, 113, 116, 117, 120, 122, 124, 127, 133, 137, 138, 139, 321, 475, 756, 757, 758, 811	0.5	1.0	1.5	2.2	2.9	3.8	4.9	6.0	7.3	8.6	10.1	11.8	13.5
15, 201, 202, 511	0.7	1.1	1.6	2.1	2.7	3.3	4.0	4.7	5.4	6.2	7.0	7.8	8.7
11, 14, 17, 20, 21, 22, 41, 42, 81, 92, 98, 231, 242, 251, 263, 264	0.5	0.8	1.2	1.6	2.1	2.6	3.2	3.8	4.5	5.2	5.9	6.7	7.5
211, 212	0.4	0.7	1.0	1.3	1.7	2.1	2.6	3.1	3.6	4.2	4.8	5.4	6.1
312, 341, 421, 631, 763, 768, 821, 997, 999	1.0	1.6	2.2	3.0	3.8	4.6	5.5	6.5	7.5	8.6	9.7	10.9	12.1
351, 352, 492	1.3	1.9	2.6	3.3	4.1	5.0	5.9	6.8	7.8	8.9	9.9	11.0	12.1
333	1.2	2.0	3.0	4.2	5.6	7.2	9.0	11.0	13.1	15.4	17.8	20.5	23.3
375	1.1	1.9	3.0	4.2	5.6	7.2	9.0	11.0	13.1	15.5	18.0	20.7	23.6
361, 431, 661, 801, 805, 807, 815, 818, 839, 981	1.2	2.0	2.9	3.9	5.0	6.2	7.5	8.9	10.4	11.9	13.6	15.3	17.2
603, 604	1.4	2.1	2.9	3.9	4.9	5.9	7.1	8.3	9.6	10.9	12.3	13.7	15.2
741, 746	1.2	1.8	2.5	3.2	4.0	4.9	5.8	6.8	7.8	8.9	10.0	11.1	12.3
540, 542	1.0	1.4	1.8	2.2	2.6	3.0	3.5	3.9	4.3	4.8	5.2	5.7	6.2
313, 345, 463, 730, 747, 748	1.2	2.0	3.0	4.2	5.6	7.2	8.9	10.9	13.0	15.2	17.7	20.3	23.1

Annual Inventory 2004
APPENDICES

Table 5c. Stocking values for all trees < 7 inches, observed on the four subplots only																					
Species	DBH of the largest tally tree in the condition																				
	5.0+						4.0-4.9					3.0-3.9				2.0-2.9			1.0-1.9		Seedling
	DBH of tally tree						DBH of tally tree					DBH of tally tree				DBH of tally tree			DBH of tally tree		Seedling
	5.0-6.9	4.0-4.9	3.0-3.9	2.0-2.9	1.0-1.9	Seedling	4.0-4.9	3.0-3.9	2.0-2.9	1.0-1.9	Seedling	3.0-3.9	2.0-2.9	1.0-1.9	Seedling	2.0-2.9	1.0-1.9	Seedling	1.0-1.9	Seedling	Seedling
19, 93	0.74	0.55	0.42	0.32	0.21	0.09	0.63	0.50	0.37	0.24	0.11	0.61	0.45	0.30	0.14	0.59	0.39	0.19	0.58	0.28	0.56
72, 73	0.60	0.45	0.34	0.26	0.17	0.08	0.51	0.41	0.30	0.20	0.09	0.50	0.37	0.24	0.11	0.49	0.32	0.15	0.47	0.23	0.46
130, 299	0.98	0.73	0.55	0.43	0.28	0.12	0.83	0.66	0.49	0.32	0.15	0.81	0.60	0.39	0.19	0.79	0.52	0.25	0.77	0.37	0.74
108	0.53	0.40	0.30	0.23	0.15	0.07	0.45	0.36	0.27	0.17	0.08	0.44	0.33	0.21	0.10	0.43	0.28	0.13	0.42	0.20	0.40
103, 104, 119	0.45	0.33	0.25	0.19	0.13	0.06	0.38	0.30	0.22	0.15	0.07	0.37	0.27	0.18	0.08	0.36	0.24	0.11	0.35	0.17	0.34
53, 54, 55, 62, 64, 65, 66, 101, 102, 106, 109, 113, 116, 117, 120, 122, 124, 127, 133, 137, 138, 139, 321, 475, 756, 757, 758, 811	0.54	0.40	0.30	0.24	0.15	0.07	0.46	0.36	0.27	0.18	0.08	0.45	0.33	0.22	0.10	0.43	0.29	0.14	0.42	0.20	0.41
15, 201, 202, 511	0.73	0.54	0.41	0.32	0.20	0.09	0.62	0.49	0.36	0.24	0.11	0.60	0.45	0.29	0.14	0.59	0.39	0.18	0.57	0.28	0.55
11, 14, 17, 20, 21, 22, 41, 42, 81, 92, 98, 231, 242, 251, 263, 264	0.51	0.38	0.29	0.22	0.14	0.06	0.43	0.34	0.26	0.17	0.08	0.42	0.31	0.21	0.10	0.41	0.27	0.13	0.40	0.19	0.39
211, 212	0.41	0.30	0.23	0.18	0.11	0.05	0.34	0.27	0.20	0.13	0.06	0.34	0.25	0.16	0.08	0.33	0.21	0.10	0.32	0.15	0.31
312, 341, 421, 631, 763, 768, 821, 997, 999	1.03	0.77	0.58	0.45	0.29	0.13	0.87	0.69	0.52	0.34	0.16	0.85	0.63	0.41	0.20	0.83	0.54	0.26	0.80	0.39	0.78
351, 352, 492	1.25	0.93	0.71	0.55	0.35	0.16	1.07	0.85	0.63	0.41	0.19	1.04	0.77	0.50	0.24	1.01	0.66	0.32	0.98	0.48	0.95
333	1.17	0.87	0.66	0.51	0.33	0.15	0.99	0.79	0.58	0.38	0.18	0.96	0.72	0.47	0.22	0.94	0.62	0.30	0.91	0.44	0.89
375	1.13	0.84	0.63	0.49	0.32	0.14	0.96	0.76	0.56	0.37	0.17	0.93	0.69	0.45	0.21	0.91	0.60	0.28	0.88	0.43	0.85
361, 431, 661, 801, 805, 807, 815, 818, 839, 981	1.25	0.93	0.70	0.54	0.35	0.16	1.06	0.84	0.62	0.41	0.19	1.03	0.77	0.50	0.24	1.00	0.66	0.32	0.97	0.47	0.95
603, 604	1.36	1.01	0.77	0.59	0.38	0.17	1.16	0.92	0.68	0.44	0.21	1.13	0.84	0.55	0.26	1.10	0.72	0.34	1.07	0.52	1.03
741, 746	1.17	0.87	0.66	0.51	0.33	0.15	1.00	0.79	0.59	0.38	0.18	0.97	0.72	0.47	0.22	0.94	0.62	0.30	0.92	0.45	0.89
540, 542	1.00	0.74	0.56	0.43	0.28	0.13	0.85	0.67	0.50	0.33	0.15	0.83	0.61	0.40	0.19	0.80	0.53	0.25	0.78	0.38	0.76
313, 345, 463, 730, 747, 748	1.16	0.86	0.65	0.50	0.32	0.15	0.98	0.78	0.58	0.38	0.18	0.96	0.71	0.47	0.22	0.93	0.61	0.29	0.90	0.44	0.88

Annual Inventory 2004
APPENDICES

Species	5.0-6.9	7.0-8.9	9.0-10.9	11.0-12.9	13.0-14.9	15.0-16.9	17.0-18.9	19.0-20.9	21.0-22.9	23.0-24.9	25.0-26.9	27.0-28.9	29.0+
19, 93	0.7	1.1	1.6	2.1	2.6	3.2	3.8	4.4	5.1	5.8	6.5	7.2	8.0
72, 73	0.6	1.0	1.5	2.0	2.6	3.3	4.0	4.9	5.7	6.7	7.6	8.7	9.8
130, 299	1.0	1.5	2.2	3.0	3.8	4.7	5.6	6.6	7.7	8.9	10.1	11.4	12.7
108	0.5	0.9	1.3	1.7	2.2	2.8	3.4	4.1	4.8	5.6	6.4	7.3	8.2
103, 104, 119	0.4	0.7	1.1	1.5	1.9	2.4	3.0	3.6	4.2	4.9	5.6	6.4	7.2
53, 54, 55, 62, 64, 65, 66, 101, 102, 106, 109, 113, 116, 117, 120, 122, 124, 127, 133, 137, 138, 139, 321, 475, 756, 757, 758, 811	0.5	1.0	1.5	2.2	2.9	3.8	4.9	6.0	7.3	8.6	10.1	11.8	13.5
15, 201, 202, 511	0.7	1.1	1.6	2.1	2.7	3.3	4.0	4.7	5.4	6.2	7.0	7.8	8.7
11, 14, 17, 20, 21, 22, 41, 42, 81, 92, 98, 231, 242, 251, 263, 264	0.5	0.8	1.2	1.6	2.1	2.6	3.2	3.8	4.5	5.2	5.9	6.7	7.5
211, 212	0.4	0.7	1.0	1.3	1.7	2.1	2.6	3.1	3.6	4.2	4.8	5.4	6.1
312, 341, 421, 631, 763, 768, 821, 997, 999	1.0	1.6	2.2	3.0	3.8	4.6	5.5	6.5	7.5	8.6	9.7	10.9	12.1
351, 352, 492	1.3	1.9	2.6	3.3	4.1	5.0	5.9	6.8	7.8	8.9	9.9	11.0	12.1
333	1.2	2.0	3.0	4.2	5.6	7.2	9.0	11.0	13.1	15.4	17.8	20.5	23.3
375	1.1	1.9	3.0	4.2	5.6	7.2	9.0	11.0	13.1	15.5	18.0	20.7	23.6
361, 431, 661, 801, 805, 807, 815, 818, 839, 981	1.2	2.0	2.9	3.9	5.0	6.2	7.5	8.9	10.4	11.9	13.6	15.3	17.2
603, 604	1.4	2.1	2.9	3.9	4.9	5.9	7.1	8.3	9.6	10.9	12.3	13.7	15.2
741, 746	1.2	1.8	2.5	3.2	4.0	4.9	5.8	6.8	7.8	8.9	10.0	11.1	12.3
540, 542	1.0	1.4	1.8	2.2	2.6	3.0	3.5	3.9	4.3	4.8	5.2	5.7	6.2
313, 345, 463, 730, 747, 748	1.2	2.0	3.0	4.2	5.6	7.2	8.9	10.9	13.0	15.2	17.7	20.3	23.1

Annual Inventory 2004
APPENDICES

Table 5e. Stocking values for all trees < 7 inches observed on one acre																					
Species	DBH of the largest tally tree in the condition																				
	5.0+						4.0-4.9					3.0-3.9				2.0-2.9			1.0-1.9		Seedling
	DBH of tally tree						DBH of tally tree					DBH of tally tree				DBH of tally tree			DBH of tally tree		Seedling
	5.0-6.9	4.0-4.9	3.0-3.9	2.0-2.9	1.0-1.9	Seedling	4.0-4.9	3.0-3.9	2.0-2.9	1.0-1.9	Seedling	3.0-3.9	2.0-2.9	1.0-1.9	Seedling	2.0-2.9	1.0-1.9	Seedling	1.0-1.9	Seedling	Seedling
19, 93	0.12	0.092	0.069	0.054	0.035	0.016	0.105	0.083	0.062	0.040	0.019	0.102	0.076	0.050	0.023	0.099	0.065	0.031	0.096	0.047	0.094
72, 73	0.10	0.075	0.057	0.044	0.028	0.013	0.086	0.068	0.050	0.033	0.015	0.083	0.062	0.041	0.019	0.081	0.053	0.025	0.079	0.038	0.076
130, 299	0.16	0.122	0.092	0.071	0.046	0.021	0.139	0.110	0.082	0.053	0.025	0.135	0.100	0.066	0.031	0.131	0.086	0.041	0.128	0.062	0.124
108	0.09	0.066	0.050	0.039	0.025	0.011	0.075	0.060	0.044	0.029	0.013	0.073	0.055	0.036	0.017	0.071	0.047	0.022	0.069	0.034	0.067
103, 104, 119	0.07	0.055	0.042	0.032	0.021	0.009	0.063	0.050	0.037	0.024	0.011	0.062	0.046	0.030	0.014	0.060	0.039	0.019	0.058	0.028	0.056
53, 54, 55, 62, 64, 65, 66, 101, 102, 106, 109, 113, 116, 117, 120, 122, 124, 127, 133, 137, 138, 139, 321, 475, 756, 757, 758, 811	0.09	0.067	0.051	0.039	0.025	0.011	0.077	0.061	0.045	0.029	0.014	0.074	0.055	0.036	0.017	0.072	0.048	0.023	0.070	0.034	0.068
15, 201, 202, 511	0.12	0.090	0.068	0.053	0.034	0.015	0.103	0.082	0.061	0.040	0.018	0.100	0.075	0.049	0.023	0.098	0.064	0.031	0.095	0.046	0.092
11, 14, 17, 20, 21, 22, 41, 42, 81, 92, 98, 231, 242, 251, 263, 264	0.09	0.063	0.048	0.037	0.024	0.011	0.072	0.057	0.043	0.028	0.013	0.070	0.052	0.034	0.016	0.068	0.045	0.022	0.067	0.032	0.065
211, 212	0.07	0.050	0.038	0.029	0.019	0.009	0.057	0.046	0.034	0.022	0.010	0.056	0.042	0.027	0.013	0.054	0.036	0.017	0.053	0.026	0.051
312, 341, 421, 424, 631, 763, 768, 821, 997, 999	0.17	0.128	0.097	0.075	0.048	0.022	0.146	0.116	0.086	0.056	0.026	0.142	0.105	0.069	0.033	0.138	0.091	0.043	0.134	0.065	0.130
351, 352, 492	0.21	0.156	0.118	0.091	0.059	0.026	0.178	0.141	0.105	0.068	0.032	0.173	0.128	0.084	0.040	0.168	0.111	0.053	0.163	0.079	0.159
333	0.19	0.145	0.110	0.085	0.055	0.025	0.165	0.131	0.097	0.063	0.030	0.161	0.120	0.078	0.037	0.156	0.103	0.049	0.152	0.074	0.148
375	0.19	0.140	0.106	0.082	0.053	0.024	0.160	0.127	0.094	0.061	0.028	0.155	0.115	0.076	0.036	0.151	0.099	0.047	0.147	0.071	0.142
361, 431, 661, 801, 805, 807, 815, 818, 839, 981	0.21	0.155	0.117	0.090	0.058	0.026	0.176	0.140	0.104	0.068	0.032	0.172	0.128	0.084	0.039	0.167	0.110	0.053	0.162	0.079	0.158
603, 604	0.23	0.169	0.128	0.099	0.064	0.029	0.193	0.153	0.114	0.074	0.034	0.188	0.140	0.091	0.043	0.183	0.120	0.057	0.178	0.086	0.172
741, 746	0.20	0.146	0.110	0.085	0.055	0.025	0.166	0.132	0.098	0.064	0.030	0.162	0.120	0.079	0.037	0.157	0.103	0.049	0.153	0.074	0.148
540, 542	0.17	0.124	0.094	0.072	0.047	0.021	0.141	0.112	0.083	0.054	0.025	0.138	0.102	0.067	0.032	0.134	0.088	0.042	0.130	0.063	0.126
313, 345, 463, 730, 747, 748	0.19	0.143	0.109	0.084	0.054	0.024	0.164	0.130	0.097	0.063	0.029	0.159	0.118	0.078	0.037	0.155	0.102	0.049	0.151	0.073	0.146

Annual Inventory 2004
APPENDICES

Table 5f. Stocking values for all trees 5.0 inches and greater observed on one acre													
Species	5.0-6.9	7.0-8.9	9.0-10.9	11.0-12.9	13.0-14.9	15.0-16.9	17.0-18.9	19.0-20.9	21.0-22.9	23.0-24.9	25.0-26.9	27.0-28.9	29.0+
19, 93	0.12	0.19	0.26	0.34	0.43	0.53	0.63	0.73	0.84	0.96	1.08	1.20	1.33
72, 73	0.10	0.17	0.24	0.33	0.44	0.55	0.67	0.81	0.95	1.11	1.27	1.45	1.63
130, 299	0.16	0.26	0.37	0.49	0.63	0.78	0.94	1.11	1.29	1.48	1.68	1.89	2.11
108	0.09	0.14	0.21	0.29	0.37	0.47	0.57	0.69	0.81	0.94	1.07	1.22	1.37
103, 104, 119	0.07	0.12	0.18	0.25	0.32	0.41	0.50	0.60	0.70	0.82	0.94	1.07	1.20
53, 54, 55, 62, 64, 65, 66, 101, 102, 106, 109, 113, 116, 117, 120, 122, 124, 127, 133, 137, 138, 139, 321, 475, 756, 757, 758, 811	0.09	0.16	0.25	0.36	0.49	0.64	0.81	1.00	1.21	1.44	1.69	1.96	2.25
15, 201, 202, 511	0.12	0.19	0.27	0.35	0.45	0.55	0.66	0.78	0.90	1.03	1.16	1.30	1.45
11, 14, 17, 20, 21, 22, 41, 42, 81, 92, 98, 231, 242, 251, 263, 264	0.09	0.14	0.20	0.27	0.35	0.44	0.53	0.64	0.75	0.86	0.98	1.11	1.25
211, 212	0.07	0.11	0.16	0.22	0.28	0.35	0.43	0.51	0.60	0.69	0.79	0.90	1.01
312, 341, 421, 631, 768, 821, 997, 999	0.17	0.27	0.37	0.49	0.63	0.77	0.92	1.08	1.25	1.43	1.62	1.81	2.01
351, 352, 492	0.21	0.31	0.43	0.56	0.69	0.83	0.98	1.14	1.31	1.48	1.65	1.83	2.02
333	0.19	0.33	0.50	0.71	0.94	1.21	1.50	1.83	2.18	2.56	2.97	3.41	3.88
375	0.19	0.32	0.49	0.70	0.93	1.20	1.50	1.83	2.19	2.58	3.00	3.45	3.93
361, 431, 661, 801, 805, 807, 815, 818, 839, 981	0.21	0.33	0.48	0.64	0.83	1.03	1.24	1.48	1.73	1.99	2.27	2.56	2.86
603, 604	0.23	0.35	0.49	0.64	0.81	0.99	1.18	1.38	1.60	1.82	2.05	2.29	2.54
741, 746	0.20	0.30	0.41	0.54	0.67	0.82	0.97	1.13	1.30	1.48	1.66	1.85	2.05
540, 542	0.17	0.23	0.30	0.36	0.43	0.50	0.58	0.65	0.72	0.80	0.87	0.95	1.03
313, 345, 463, 730, 747, 748	0.19	0.33	0.50	0.70	0.93	1.19	1.49	1.81	2.16	2.54	2.95	3.38	3.85

Annual Inventory 2004
APPENDICES

Table 5g. Minimum number of trees per acre for forest land based on largest tally tree

Species	DBH of largest tally tree																	
	Seed-ling	1.0-1.9	2.0-2.9	3.0-3.9	4.0-4.9	5.0-6.9	7.0-8.9	9.0-10.9	11.0-12.9	13.0-14.9	15.0-16.9	17.0-18.9	19.0-20.9	21.0-22.9	23.0-24.9	25.0-26.9	27.0-28.9	29.0+
19, 93	106.9	103.8	100.9	98.1	95.5	81.2	53.0	38.1	29.1	23.2	19.0	16.0	13.7	11.9	10.4	9.3	8.3	7.5
72, 73	130.8	127.0	123.4	120.0	116.8	99.3	60.3	41.0	29.9	22.9	18.2	14.8	12.4	10.5	9.0	7.9	6.9	6.1
130, 299	80.6	78.3	76.1	74.0	72.0	61.2	38.7	27.2	20.3	15.9	12.9	10.7	9.0	7.8	6.8	5.9	5.3	4.7
108	148.4	144.1	140.0	136.2	132.6	112.7	69.1	47.3	34.7	26.7	21.3	17.4	14.6	12.4	10.7	9.3	8.2	7.3
103, 104, 119	177.2	172.0	167.2	162.6	158.2	134.5	81.8	55.6	40.5	31.1	24.7	20.1	16.8	14.2	12.2	10.6	9.4	8.3
53, 54, 55, 62, 64, 65, 66, 101, 102, 106, 109, 113, 116, 117, 120, 122, 124, 127, 133, 137, 138, 139, 321, 475, 756, 757, 758, 811	146.4	142.1	138.1	134.3	130.7	111.1	62.5	40.0	27.8	20.4	15.6	12.3	10.0	8.3	6.9	5.9	5.1	4.4
15, 201, 202, 511	108.5	105.3	102.4	99.6	96.9	82.4	52.9	37.5	28.3	22.3	18.2	15.2	12.9	11.1	9.7	8.6	7.7	6.9
11, 14, 17, 20, 21, 22, 41, 42, 81, 92, 98, 231, 242, 251, 263, 264	154.8	150.3	146.1	142.0	138.2	117.5	72.7	50.1	36.9	28.5	22.8	18.8	15.7	13.4	11.6	10.2	9.0	8.0
211, 212	195.0	189.3	184.0	178.9	174.1	148.0	91.3	62.7	46.2	35.7	28.5	23.4	19.6	16.7	14.4	12.6	11.1	9.9
312, 341, 421, 631, 763, 768, 821, 997, 999	76.9	74.6	72.5	70.5	68.7	58.4	37.6	26.7	20.2	16.0	13.0	10.9	9.2	8.0	7.0	6.2	5.5	5.0
351, 352, 492	63.0	61.2	59.5	57.8	56.3	47.8	31.9	23.3	18.0	14.5	12.0	10.2	8.8	7.7	6.8	6.1	5.5	4.9
333	67.8	65.8	63.9	62.2	60.5	51.4	30.1	19.9	14.2	10.6	8.3	6.7	5.5	4.6	3.9	3.4	2.9	2.6
375	70.2	68.1	66.2	64.4	62.7	53.3	30.9	20.3	14.4	10.7	8.3	6.7	5.5	4.6	3.9	3.3	2.9	2.5
361, 431, 661, 801, 805, 807, 815, 818, 839, 981	63.5	61.6	59.9	58.2	56.7	48.2	30.1	20.9	15.6	12.1	9.7	8.0	6.8	5.8	5.0	4.4	3.9	3.5
603, 604	58.0	56.3	54.7	53.2	51.8	44.0	28.6	20.5	15.6	12.3	10.1	8.5	7.2	6.3	5.5	4.9	4.4	3.9
741, 746	67.4	65.4	63.6	61.8	60.2	51.2	33.6	24.3	18.6	14.8	12.2	10.3	8.8	7.7	6.8	6.0	5.4	4.9
540, 542	79.2	76.9	74.7	72.6	70.7	60.1	43.4	33.7	27.5	23.1	19.8	17.4	15.4	13.8	12.5	11.5	10.5	9.8
313, 345, 463, 730, 747, 748	68.4	66.4	64.5	62.7	61.0	51.9	30.4	20.1	14.3	10.7	8.4	6.7	5.5	4.6	3.9	3.4	3.0	2.6

APPENDIX 7 -- TREE SPECIES LISTS

This following *lists* include all tree species tallied in the Continental U.S and Alaska. Woodland species designate species where DRC is measured instead of DBH.

The first list contains species tallied as trees which are common to the PNW area.
The second list contains species tallied as trees if encountered, but which are not expected to be found in the PNW region.

"Genus-only" codes are not valid.

List 1		Species Common to PNW		
Woodland	Code	Common Name	Genus	Species
	11	Pacific silver fir	Abies	amabilis
	14	Santa Lucia fir	Abies	bracteata
	15	white fir	Abies	concolor
	17	grand fir	Abies	grandis
	19	subalpine fir	Abies	lasiocarpa
	20	California red fir	Abies	magnifica
	21	Shasta red fir	Abies	magnifica var.shastensis
		PNW-FIA name	Abies	shastensis
	22	noble fir	Abies	procera
	41	Port-Orford-cedar	Chamaecyparis	lawsoniana
	42	Alaska yellow-cedar	Chamaecyparis	nootkatensis
	53	Tecate cypress	Cupressus	guadalupensis var. forbesii
		PNW-FIA name	Cupressus	forbesii
	54	Monterey cypress	Cupressus	macrocarpa
	55	Sargent cypress	Cupressus	sargentii
w	62	California juniper	Juniperus	californica
	64	western juniper	Juniperus	occidentalis
w	65	Utah juniper	Juniperus	osteosperma
w	66	Rocky Mountain juniper	Juniperus	scopulorum
	72	subalpine larch	Larix	lyallii
	73	western larch	Larix	occidentalis
	81	incense-cedar	Calocedrus	decurrens
	92	Brewer spruce	Picea	breweriana
	93	Engelmann spruce	Picea	engelmannii
	98	Sitka spruce	Picea	sitchensis
	101	whitebark pine	Pinus	albicaulis
	102	bristlecone pine	Pinus	aristata
		PNW-FIA name	Pinus	longaeva
	103	knobcone pine	Pinus	attenuata
	104	foxtail pine	Pinus	balfouriana
w	106	common pinyon	Pinus	edulis
	108	lodgepole pine	Pinus	contorta
	109	Coulter pine	Pinus	coulteri
	113	limber pine	Pinus	flexilis
	116	Jeffrey pine	Pinus	jeffreyi
	117	sugar pine	Pinus	lambertiana
	119	western white pine	Pinus	monticola
	120	bishop pine	Pinus	muricata
	122	ponderosa pine	Pinus	ponderosa

List 1		Species Common to PNW		
Woodland	Code	Common Name	Genus	Species
	124	Monterey pine	Pinus	radiata
	127	gray pine	Pinus	sabiniana
	130	Scotch pine	Pinus	sylvestris
w	133	singleleaf pinyon	Pinus	monophylla
	137	Washoe pine	Pinus	washoensis
	138	four-leaf pine	Pinus	quadrifolia
	139	Torreya pine	Pinus	torreyana
	201	bigcone Douglas-fir	Pseudotsuga	macrocarpa
	202	Douglas-fir	Pseudotsuga	menziesii
	211	redwood	Sequoia	sempervirens
	212	giant sequoia	Sequoiadendron	giganteum
	231	Pacific yew	Taxus	brevifolia
	242	western redcedar	Thuja	plicata
	251	California torrey (nutmeg)	Torreya	californica
	263	western hemlock	Tsuga	heterophylla
	264	mountain hemlock	Tsuga	mertensiana
	299	Unknown dead conifer	UNKNOWN	CONIFER
	312	bigleaf maple	Acer	macrophyllum
	313	boxelder	Acer	negundo
w	321	Rocky Mountain maple	Acer	douglasii
		PNW-FIA name	Acer	glabrum var. douglasii
	333	California buckeye	Aesculus	californica
	341	ailanthus	Ailanthus	altissima
	345	mimosa, silktree	Albizia	julibrissin
		Corrected spelling	Albizia	julibrissin
	351	red alder	Alnus	rubra
	352	white alder	Alnus	rhombifolia
	361	Pacific madrone	Arbutus	menziesii
	375	paper birch	Betula	papyrifera
	421	American chestnut	Castanea	dentata
	431	giant chinkapin, golden chinkapin	Castanopsis	chrysophylla
		PNW-FIA name	Chrysolepis	chrysophylla
	463	netleaf hackberry	Celtis	reticulata
w	475	curleaf mountain- mahogany	Cercocarpus	ledifolius
	492	Pacific dogwood	Cornus	nuttallii
E	511	Tasmanian bluegum, eucalyptus	Eucalyptus	globululus
	540	ash spp.	Fraxinus	spp.
	542	Oregon ash	Fraxinus	latifolia
	603	California black walnut	Juglans	hindsii
	604	southern California black walnut	Juglans	californica
	631	tanoak	Lithocarpus	densiflorus
	661	Oregon crab apple	Malus	fusca
	730	California sycamore	Platanus	racemosa
	741	balsam poplar	Populus	balsamifera
	746	quaking aspen	Populus	tremuloides
	747	black cottonwood	Populus	trichocarpa

List 1		Species Common to PNW		
Woodland	Code	Common Name	Genus	Species
		PNW-FIA name	Populus	balsamifera ssp. trichocarpa
	748	Rio Gr. cottonwd, Fremont Poplar	Populus	deltoides ssp. wislizeni
		PNW Fremont Poplar	Populus	fremontii
w	756	Western honey mesquite	Prosopis	glandulosa var. torreyana
w	757	velvet mesquite	Prosopis	velutina
		Corrected spelling	Prosopis	
w	758	screwbean mesquite	Prosopis	pubescens
		Corrected spelling	Prosopis	
	763	chokecherry	Prunus	virginiana
	768	bitter cherry	Prunus	emarginata
	801	coast live oak	Quercus	agrifolia
	805	canyon live oak	Quercus	chrysolepis
		Corrected spelling:		chrysolepis
	807	blue oak	Quercus	douglasii
	811	Engelmann oak	Quercus	engelmannii
	815	Oregon white oak	Quercus	garryana
	818	California black oak	Quercus	kelloggii
	821	California white oak	Quercus	lobata
	839	interior live oak	Quercus	wislizeni
	981	California-laurel	Umbellularia	californica
				Tamarix spp.
	997	Russian-olive	Elaeagnus	angustifolia

See the following pages for species tallied as trees, but which are not expected to be found in the PNW region.

The following list contains species tallied as trees, but which are not commonly found in the PNW region.

Woodland	List 2 Code	Trees, not common to PNW Common Name	Genus	Species
	12	balsam fir	Abies	balsamea
	16	Fraser fir	Abies	fraseri
	18	corkbark fir	Abies	lasiocarpa var. arizonica
	43	Atlantic white-cedar	Chamaecyparis	thyoides
	50	cypress	Cupressus	spp.
	51	Arizona cypress	Cupressus	arizonica
	52	Baker cypress	Cupressus	bakeri
w	58	Pinchot juniper	Juniperus	pinchotii
w	59	redberry juniper	Juniperus	erythrocarpa
	61	Ashe juniper	Juniperus	ashei
w	63	alligator juniper	Juniperus	depeana
	67	southern redcedar	Juniperus	silicicola
	68	eastern redcedar	Juniperus	virginiana
w	69	oneseed juniper	Juniperus	monosperma
	71	tamarack (native)	Larix	laricina
	91	Norway spruce	Picea	abies
	94	white spruce	Picea	glauca
	95	black spruce	Picea	mariana
	96	blue spruce	Picea	pungens
	97	red spruce	Picea	rubens
	105	jack pine	Pinus	banksiana
w	106	common pinyon	Pinus	edulis
	107	sand pine	Pinus	clausa
	110	shortleaf pine	Pinus	echinata
	111	slash pine	Pinus	elliottii
	112	Apache pine	Pinus	engelmannii
	114	southwestern white pine	Pinus	strobiformus
	115	spruce pine	Pinus	glabra
	118	Chihuahua pine	Pinus	leiophylla var. chihuahuana
	121	longleaf pine	Pinus	palustris
	123	Table Mountain pine	Pinus	pungens
	125	red pine	Pinus	resinosa
	126	pitch pine	Pinus	rigida
	128	pond pine	Pinus	serotina
	129	eastern white pine	Pinus	strobus
	131	loblolly pine	Pinus	taeda
	132	Virginia pine	Pinus	virginiana
w	134	border pinyon	Pinus	discolor
	135	Arizona pine	Pinus	ponderosa var. arizonica
	136	Austrian pine	Pinus	nigra
w	140	Mexican pinyon pine	Pinus	cembroides
	142	Great Basin bristlecone pine	Pinus	longaeva
w	143	Arizona pinyon pine	Pinus	monophylla var. fallax
	221	baldcypress	Taxodium	distichum
	222	pondcypress	Taxodium	distichum var. nutans
	241	northern white-cedar	Thuja	occidentalis
	252	Florida torreyia	Torreya	taxifolia
	261	eastern hemlock	Tsuga	canadensis
	262	Carolina hemlock	Tsuga	caroliniana
	311	Florida maple	Acer	barbatum
	314	black maple	Acer	nigrum
	315	striped maple	Acer	pensylvanicum
	316	red maple	Acer	rubrum
	317	silver maple	Acer	saccharinum
	318	sugar maple	Acer	saccharum
	319	mountain maple	Acer	spicatum
	320	Norway maple	Acer	platinoides
w	322	bigtooth maple	Acer	grandidentatum
	323	chalk maple	Acer	leucoderme

Woodland	List 2 Code	Trees, not common to PNW Common Name	Genus	Species
	331	Ohio buckeye	Aesculus	glabra
	332	yellow buckeye	Aesculus	octandra
	334	Texas buckeye	Aesculus	glabra var. arguta
	355	European Alder	Alnus	glutinosa
	367	pawpaw	Asimina	triloba
	371	yellow birch	Betula	alleghaniensis
	372	sweet birch	Betula	lenta
	373	river birch	Betula	nigra
	374	water birch	Betula	occidentalis
	378	northwesternpaper birch	Betula	papyrifera var.subcordata
	379	gray birch	Betula	populifolia
	381	chittamwood,gum bumelia	Bumelia	lanuginosa
	391	American	Carpinus	caroliniana
	401	water hickory	Carya	aquatica
	402	bitternut hickory	Carya	cordiformis
	403	pignut hickory	Carya	glabra
	404	pecan	Carya	illinoensis
	405	shellbark hickory	Carya	laciniosa
	406	nutmeg hickory	Carya	myristiciformis
	407	shagbark hickory	Carya	ovata
	408	black hickory	Carya	texana
	409	mockernut hickory	Carya	tomentosa
	410	sand hickory	Carya	pallida
	422	Allegheny chinkapin	Castanea	pumila
	423	Ozark chinkapin	Castanea	ozarkensis
	451	southern catalpa	Catalpa	bignonioides
	452	northern catalpa	Catalpa	speciosa
	461	sugarberry	Celtis	laevigata
	462	hackberry	Celtis	occidentalis
	471	eastern redbud	Cercis	canadensis
	481	yellowwood	Cladrastis	kentukea
	491	flowering dogwood	Cornus	florida
	501	cockspur hawthorn	Crataegus	crus-galli
	502	downy hawthorn	Crataegus	mollis
	521	common persimmon	Diospyros	virginiana
	531	American beech	Fagus	grandifolia
	541	white ash	Fraxinus	americana
	543	black ash	Fraxinus	nigra
	544	Green ash	Fraxinus	pennsylvanica
	545	pumpkin ash	Fraxinus	profunda
	546	blue ash	Fraxinus	quadrangulata
	547	velvet ash	Fraxinus	velutina
	548	Carolina ash	Fraxinus	caroliniana
	551	waterlocust	Gleditsia	aquatica
	552	honeylocust	Gleditsia	triacanthos
	555	loblolly-bay	Gordonia	lasianthus
	571	Kentucky coffeetree	Gymnocladus	dioicus
	591	American Holly	Ilex	Opaca
	601	butternut	Juglans	cinerea
	602	black walnut	Juglans	nigra
	605	Texas walnut	Juglans	microcarpa
	611	sweetgum	Liquidambar	styraciflua
	621	yellow-poplar	Liriodendron	tuliperfia
	641	Osage-orange	Maclura	pomifera
	651	cucumbertree	Magnolia	acuminata
	652	southern magnolia	Magnolia	grandiflora
	653	sweetbay	Magnolia	virginiana
	654	bigleaf magnolia	Magnolia	macrophylla
	655	mountain magnolia	Magnolia	fraseri
	681	white mulberry	Morus	alba
	682	red mulberry	Morus	rubra

Annual Inventory 2004
APPENDICES

Woodland	List 2 Code	Trees, not common to PNW Common Name	Genus	Species
	691	water tupelo	Nyssa	aquatica
	692	Ogechee tupelo	Nyssa	ogechee
	693	blackgum	Nyssa	sylvatica
	694	swamp tupelo	Nyssa	sylvatica var. biflora
	701	eastern hophornbeam	Ostrya	virginiana
	711	sourwood	Oxydendrum	arboreum
	712	paulownia, empress-tree	Paulownia	tomentosa
	721	redbay	Persea	borbonia
	722	water-elm, planertree	Planera	aquatica
	731	sycamore	Platanus	occidentalis
	742	eastern cottonwood	Populus	deltoides
	743	bigtooth aspen	Populus	grandidentata
	744	swamp cottonwood	Populus	heterophylla
	745	plains cottonwood	Populus	deltoides ssp. monilifera
	749	narrowleaf cottonwood	Populus	angustifolia
	752	silver poplar	Populus	alba
	761	pin cherry	Prunus	pensylvanica
	762	black cherry	Prunus	serotina
	765	Canada plum	Prunus	nigra
	766	wild plum	Prunus	americana
	802	white oak	Quercus	alba
w	803	Arizona white oak and gray oak	Quercus	arizonica
	804	swamp white oak	Quercus	grisea
	806	scarlet oak	Quercus	bicolor
	808	scarlet oak	Quercus	coccinea
	808	Durand oak	Quercus	durandii
	809	northern pin oak	Quercus	ellipsoidalis
w	810	Emery oak	Quercus	emoryi
	812	southern red oak	Quercus	falcata var.falcata
	813	cherrybark oak	Quercus	falcata var.pagodifolia
w	814	Gambel oak	Quercus	gambelii
	815	Oregon white oak	Quercus	garryana
	816	bear oak, scrub oak	Quercus	ilicifolia
	817	shingle oak	Quercus	imbricaria
	819	turkey oak	Quercus	laevis
	820	laurel oak	Quercus	laurifolia
	822	overcup oak	Quercus	lyrata
	823	bur oak	Quercus	macrocarpa
	824	blackjack oak	Quercus	marilandica
	825	swamp chestnut oak	Quercus	michauxii
	826	chinkapin oak	Quercus	muehlenbergii
	827	water oak	Quercus	nigra
	828	Nuttall oak	Quercus	nuttallii
w	829	Mexican blue oak	Quercus	oblongifolia
	830	pin oak	Quercus	palustris
	831	willow oak	Quercus	phellos
	832	chestnut oak	Quercus	prinus
	833	northern red oak	Quercus	rubra
	834	Shumard oak	Quercus	shumardii
	835	post oak	Quercus	stellata
	836	Delta post oak	Quercus	stellata var. mississippiensis
	837	black oak	Quercus	velutina
	838	live oak	Quercus	virginiana
	840	dwarf post oak	Quercus	stellata var. margaretta
	841	dwarf live oak	Quercus	minima
	842	bluejack oak	Quercus	incana
w	843	silverleaf oak	Quercus	hypoleucoides
	844	Oglethorpe oak	Quercus	oglethorpensis
	845	Dwarf chinakapin oak	Quercus	prinoides
	901	black locust	Robinia	pseudoacacia
w	902	New Mexico locust	Robinia	neomexicana

Annual Inventory 2004
APPENDICES

Woodland	List 2 Code	Trees, not common to PNW Common Name	Genus	Species
	919	western soapberry	Sapindus	drummondii
	921	peachleaf willow	Salix	amygdaloides
	922	black willow	Salix	nigra
	927	white willow	Salix	alba
	931	sassafras	Sassafras	albidum
	935	American mountain-ash	Sorbus	americana
	936	European mountain-ash	Sorbus	aucuparia
	951	American basswood	Tilia	americana
	952	white basswood	Tilia	heterophylla
	953	Carolina basswood	Tilia	americana var. caroliniana
	971	winged elm	Ulmus	alata
	972	American elm	Ulmus	americana
	973	cedar elm	Ulmus	crassifolia
	974	Siberian elm	Ulmus	pumila
	975	slippery elm	Ulmus	rubra
	976	September elm	Ulmus	serotina
	977	rock elm	Ulmus	thomasii
	989	mangrove	Rhizophora	mangle
w	990	tesota, Arizona-ironwood	Olneya	tesota
	992	melaleuca	Melaleuca	quinquenervia
	993	chinaberry	Melia	azedarach
	994	Chinese tallowtree	Sapium	sebiferum
	995	tung-oil-tree	Aleurites	fordii
	996	smoketree	Cotinus	obovatus

The above list contains species tallied as trees, but which are not commonly found in the PNW region.

APPENDIX 8 -- FOREST TYPE CODES

This following list includes all forest types in the Continental U.S. and Alaska Types designated East/West are commonly found in those regions, although types designated for one region may occasionally be found in another. *These codes are used for FOREST TYPE in Condition Class Attributes.*

East	West	Code	Species Type
E			White / Red / Jack Pine Group
E		101	Jack pine
E		102	Red pine
E		103	Eastern white pine
E		104	Eastern White pine / Eastern hemlock
E		105	Eastern hemlock
E			Spruce / Fir Group
E		121	Balsam fir
E		122	White spruce
E		123	Red spruce
E		124	Red spruce / balsam fir
E		125	Black spruce
E		126	Tamarack
E		127	Northern white-cedar
E			Longleaf / Slash Pine Group
E		141	Longleaf pine
E		142	Slash pine
E			Loblolly / Shortleaf Pine Group
E		161	Loblolly pine
E		162	Shortleaf pine
E		163	Virginia pine
E		164	Sand pine
E		165	Table-mountain pine
E		166	Pond pine
E		167	Pitch pine
E		168	Spruce pine
	W		Pinyon / Juniper Group
E		181	Eastern redcedar
	W	182	Rocky Mountain juniper
	W	183	Western juniper
	W	184	Juniper woodland
	W	185	Pinyon juniper woodland
	W		Douglas-fir Group
	W	201	Douglas-fir
	W	202	Port-Orford-cedar
	W		Ponderosa Pine Group
E	W	221	Ponderosa pine
	W	222	Incense cedar
	W	223	Jeffrey pine / Coulter pine / bigcone Douglas-fir
	W	224	Sugar pine
	W		Western White Pine Group
	W	241	Western white pine
	W		Fir / Spruce / Mountain Hemlock Group

East	West	Code	Species Type
	W	261	White fir
	W	262	Red fir
	W	263	Noble fir
	W	264	Pacific silver fir
	W	265	Engelmann spruce
	W	266	Engelmann spruce / subalpine fir
	W	267	Grand fir
	W	268	Subalpine fir
	W	269	Blue spruce
	W	270	Mountain hemlock
	W	271	Alaska-yellow-cedar
	W		Lodgepole Pine Group
	W	281	Lodgepole pine
	W		Hemlock / Sitka Spruce Group
	W	301	Western hemlock
	W	304	Western redcedar
	W	305	Sitka spruce
	W		Western Larch Group
	W	321	Western larch
	W		Redwood Group
	W	341	Redwood
	W	342	Giant sequoia
	W		Other Western Softwoods Group
	W	361	Knobcone pine
	W	362	Southwest white pine
	W	363	Bishop pine
	W	364	Monterey pine
	W	365	Foxtail pine / bristlecone pine
	W	366	Limber pine
	W	367	Whitebark pine
	W	368	Misc. western softwoods
	W		California Mixed Conifer Group
	W	371	California mixed conifer
E	W		Exotic Softwoods Group
E		381	Scotch pine
E	W	382	Australian pine
E	W	383	Other exotic softwoods
E		384	Norway Spruce
E		385	Introduced larch
E			Oak / Pine Group
E		401	Eastern White pine / N. red oak / white ash
E		402	Eastern redcedar / hardwood
E		403	Longleaf pine / oak
E		404	Shortleaf pine / oak
E		405	Virginia pine / southern red oak
E		406	Loblolly pine / hardwood
E		407	Slash pine / hardwood
E		409	Other pine / hardwood

East	West	Code	Species Type
E			Oak / Hickory Group
E		501	Post oak / blackjack oak
E		502	Chestnut oak
E		503	White oak / red oak / hickory
E		504	White oak
E		505	Northern red oak
E		506	Yellow-poplar / white oak / N. red oak
E		507	Sassafras / persimmon
E		508	Sweetgum / yellow-poplar
E		509	Bur oak
E		510	Scarlet oak
E		511	Yellow-poplar
E		512	Black walnut
E		513	Black locust
E		514	Southern scrub oak
E		515	Chestnut oak / black oak / scarlet oak
E		519	Red maple / oak
E		520	Mixed upland hardwoods
E			Oak / Gum / Cypress Group
E		601	Swamp chestnut oak / cherrybark oak
E		602	Sweetgum / Nuttall oak / willow oak
E		605	Overcup oak / water hickory
E		606	Atlantic white-cedar
E		607	Baldcypress / water tupelo
E		608	Sweetbay / swamp tupelo / red maple
			Elm / Ash / Cottonwood Group
E		701	Black ash / American elm / red maple
E		702	River birch / sycamore
E	W	703	Cottonwood
E	W	704	Willow
E		705	Sycamore / pecan / American elm
E		706	Sugarberry / hackberry / elm / green ash
E		707	Silver Maple/American Elm
E		708	Red maple / lowland
E	W	709	Cottonwood / willow
E	W	722	Oregon ash
E			Maple / Beech / Birch Group
E		801	Sugar maple / beech / yellow birch
E		802	Black cherry
E		803	Cherry / ash / yellow-poplar
E		805	Hard maple / basswood
E		807	Elm / ash / locust
E		809	Red maple / upland
E	W		Aspen / Birch Group
E	W	901	Aspen
E	W	902	Paper birch
E	W	904	Balsam poplar
	W		Alder / Maple Group
	W	911	Red alder
	W	912	Bigleaf maple
	W		Western Oak Group

Annual Inventory 2004
APPENDICES

East	West	Code	Species Type
	W	921	Gray pine
	W	922	California black oak
	W	923	Oregon white oak
	W	924	Blue oak
	W	925	Deciduous oak woodland
	W	926	Evergreen oak woodland
	W	931	Coast live oak
	W	932	Canyon live oak / interior live oak
	W		Tanoak / Laurel Group
	W	941	Tanoak
	W	942	California laurel
	W	943	Giant chinkapin
	W		Other Western Hardwoods Group
	W	951	Pacific madrone
	W	952	Mesquite woodland
	W	953	Cercocarpus woodland
	W	954	Intermountain maple woodland
	W	955	Misc. western hardwood woodlands
E			Tropical Hardwoods Group
E		981	Sabal palm
E		982	Mangrove
E		989	Other tropical
E	W		Exotic Hardwoods Group
E		991	Paulownia
E		992	Melaluca
E	W	993	Eucalyptus
E	W	995	Other exotic hardwoods

For non-stocked stands, see page 75 for procedured to determine FOREST TYPE

APPENDIX 9 -- COUNTY and PLANT ASSOCIATION KEY

The following list identifies which plant association key to use for each plot to determine Condition Class Attribute Item 45--Plant association on page 89. The plant association guide to use will be downloaded on the data recorder.

Washington

Asotin Co. (3) - south of Grande Ronde River- Wallowa-Snake Key

Asotin Co. (3) - north of Grande Ronde River- Blue Mtn Key

Columbia Co. (13) - all- Blue Mtn Key

Cowlitz Co. (15) - west of I5: Olympic Key; east of I5: Gifford-Pinchot keys

Ferry Co. (19) North of the Colville reservation: Colville NF key; south of the Colville reservation's north border: Colville Res. key

Garfield Co. (23) - all- Blue Mtn Key

Klickitat Co. (39) - on National Forest: Gifford-Pinchot keys; east of National Forest: Wenatchee key

Lewis Co. (41) - west of I5: Olympic Key; east of I5: Gifford-Pinchot keys

Lincoln Co. (43) - North-east section: Spokane reservation key

Okanagon Co. (47) - west of the Okanogan River: Wenatchee key; east of Okanogan River and north of the Colville reservation: Colville NF key; east of Okanogan River and south of the Colville reservation's north border: Colville Res. key

Skagit Co. (57) - east of North Cascades National Park: Wenatchee key; otherwise: Mt. Baker-Snoqualmie key

Spokane Co. (63) - NO KEY AVAILABLE

Stevens Co. (65) - North of the Spokane reservation: Colville NF key; south of the Spokane reservation's north border: Spokane Res. key

Thurston Co. (67) - west of I5: Olympic Key; east of I5: Gifford-Pinchot keys

Walla Walla Co. (71) - all- Blue Mtn Key

Whatcom Co. (73) - east of North Cascades National Park: Wenatchee key; otherwise: Mt. Baker-Snoqualmie key

Yakima Co. (77) - on National Forest: Gifford-Pinchot keys; east of National Forest: Wenatchee key; Yakama reservation and north of Yakama reservation: Wenatchee key

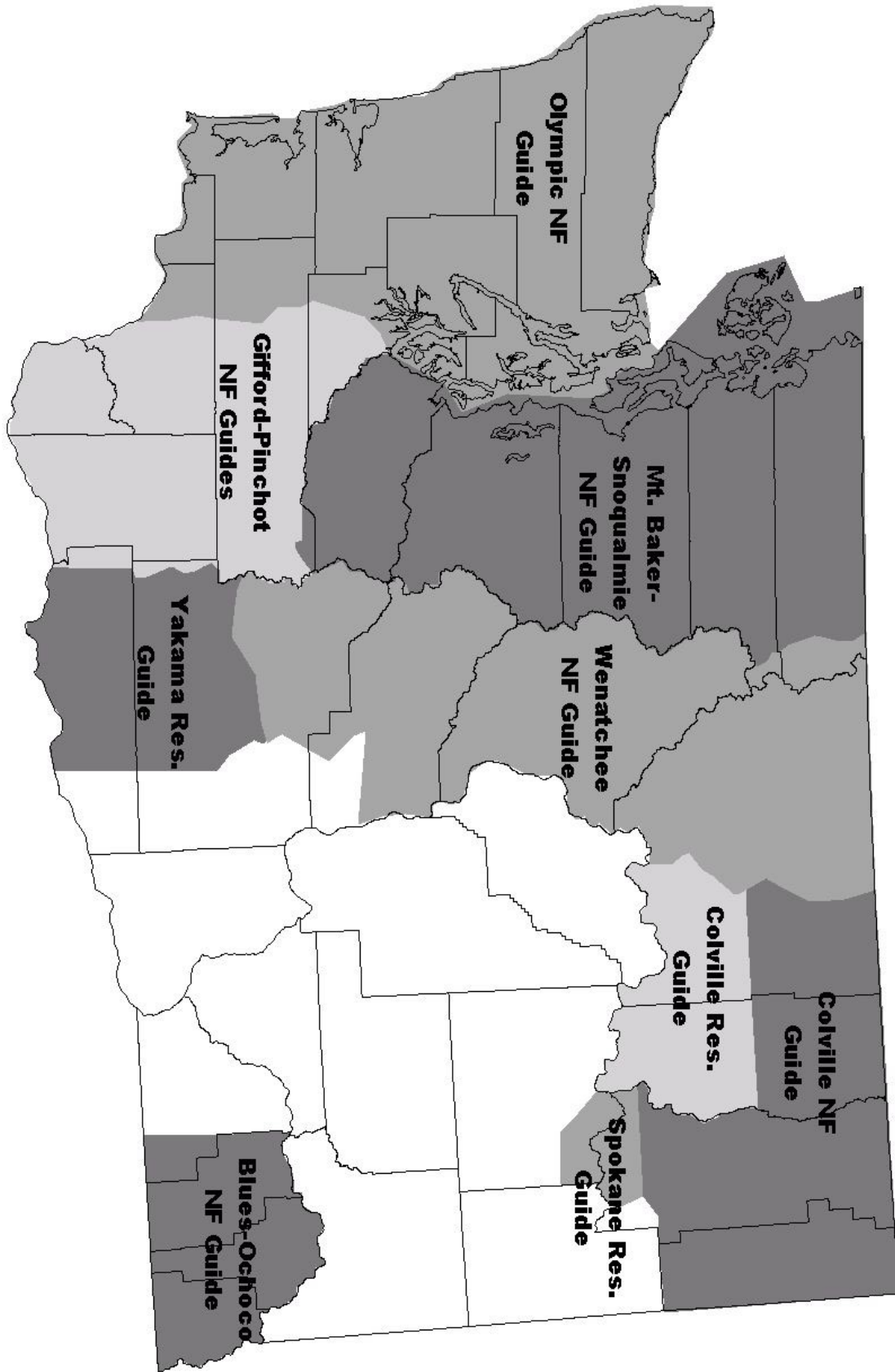

Oregon

Baker Co.- see map on following pages.
north and east of US 80- Wallowa-Snake Key
south and west of US 80- Blue Mtn Key

Crook Co.- all- Blue Mtn Key

Deschutes Co.- see map on following pages.
west of US 97 and south of US 20- Pumice Zone Key

Gilliam Co.- no Key available

Grant Co.- all- Blue Mtn Key

Harney Co.- north of US 20- Blue Mtn Key

Jefferson Co.- see map on following pages.
timberlands on the Warm Springs Reservation- Warm Springs Key
south of Warm Springs Reservation and west from east ½ of Range 11E- Pumice Zone Key
east of Range 14E- Blue Mtn Key
east ½ of Range 11E east thru Range 14E- Crooked River Grasslands Key

Klamath Co.- see map on following pages.
south to south end of Crater Lake NP, south thru north ½ of Township 35S, east to Range 14E- Pumice
Zone Key
from CA border north to the Sprague River, including south ½ of Township 35S, east to Range 12E,
Klamath and S Chiloquin Key
including Range 14 E east- Fremont Key

Lake Co.- see map on following pages.
south to Township 33S, east to Range 15E - Pumice Zone Key
from CA border north, west to Range 14E- Fremont Key

Malheur Co.- no Key available

Morrow Co.- see map on following pages.
south of Township 2S- Blue Mtn Key

Sherman Co.- no Key available

Umatilla Co.- all- Blue Mtn Key

Union Co.- see map on following pages.
east of US 80 and the Grande Ronde River- Wallowa-Snake Key
west of US 80 and the Grande Ronde River- Blue Mtn Key

Wallowa Co.- see map on following pages.
east of the Grande Ronde River- Wallowa-Snake Key
west of the Grande Ronde River- Blue Mtn Key

Wasco Co.- see map on following pages.
timberlands on the Warm Springs Reservation- Warm Springs Key
north of Warm Springs Reservation- generally above 3000 feet- Silver Fir Zone Key
north of Warm Springs Reservation- generally below 3000 feet- Ponderosa-Doug-fir-grand Fir Key

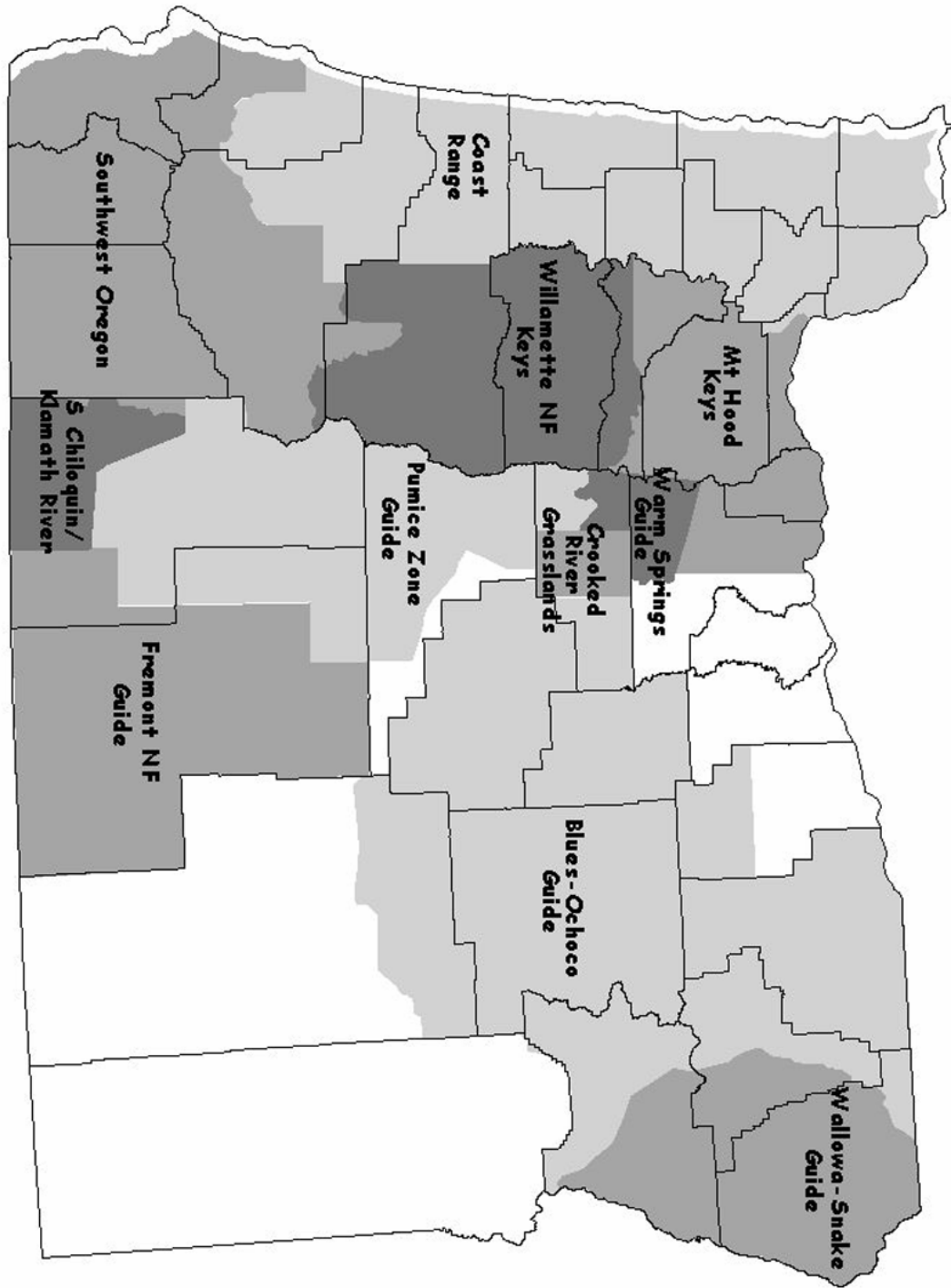

Plant Association Guides for Oregon

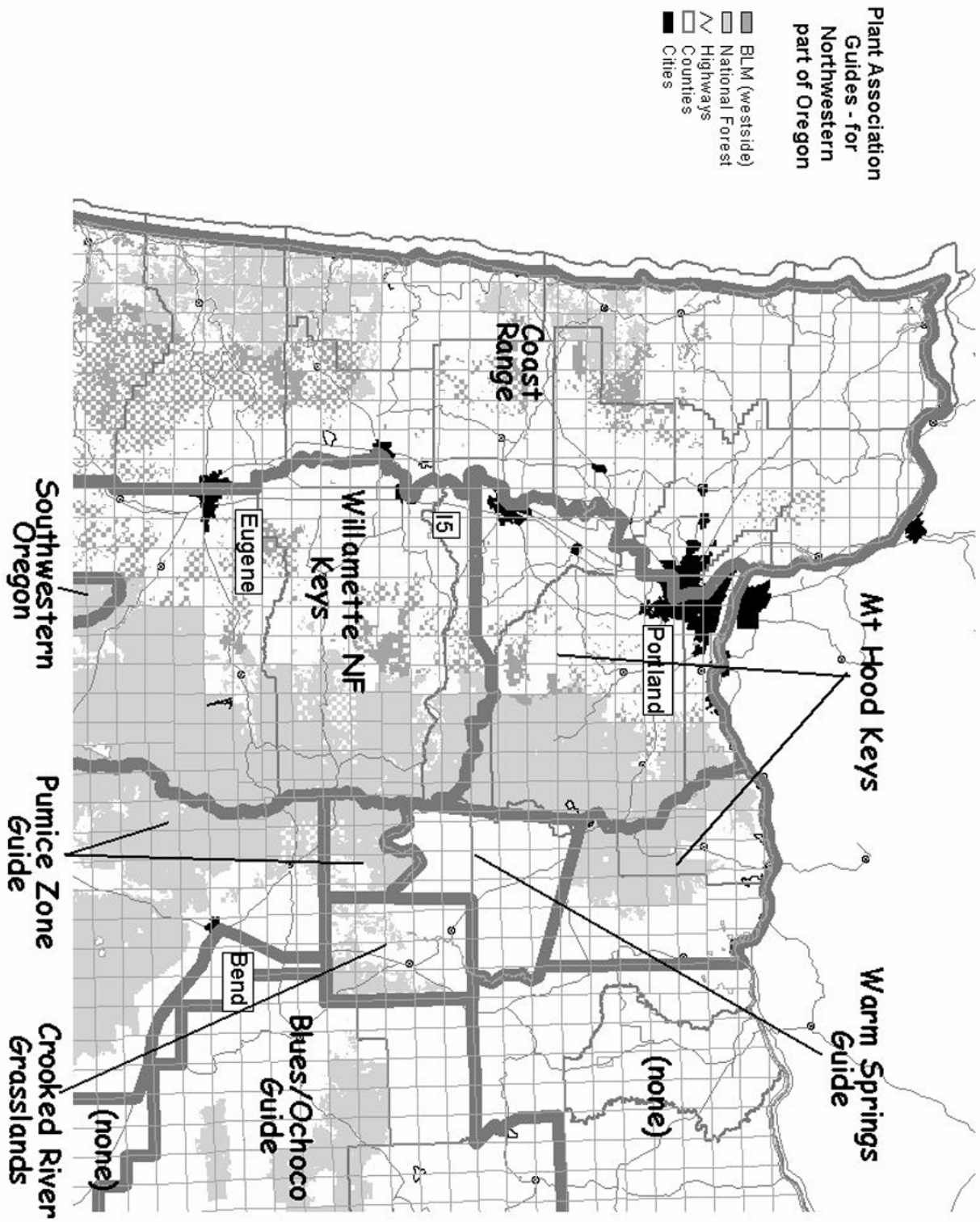

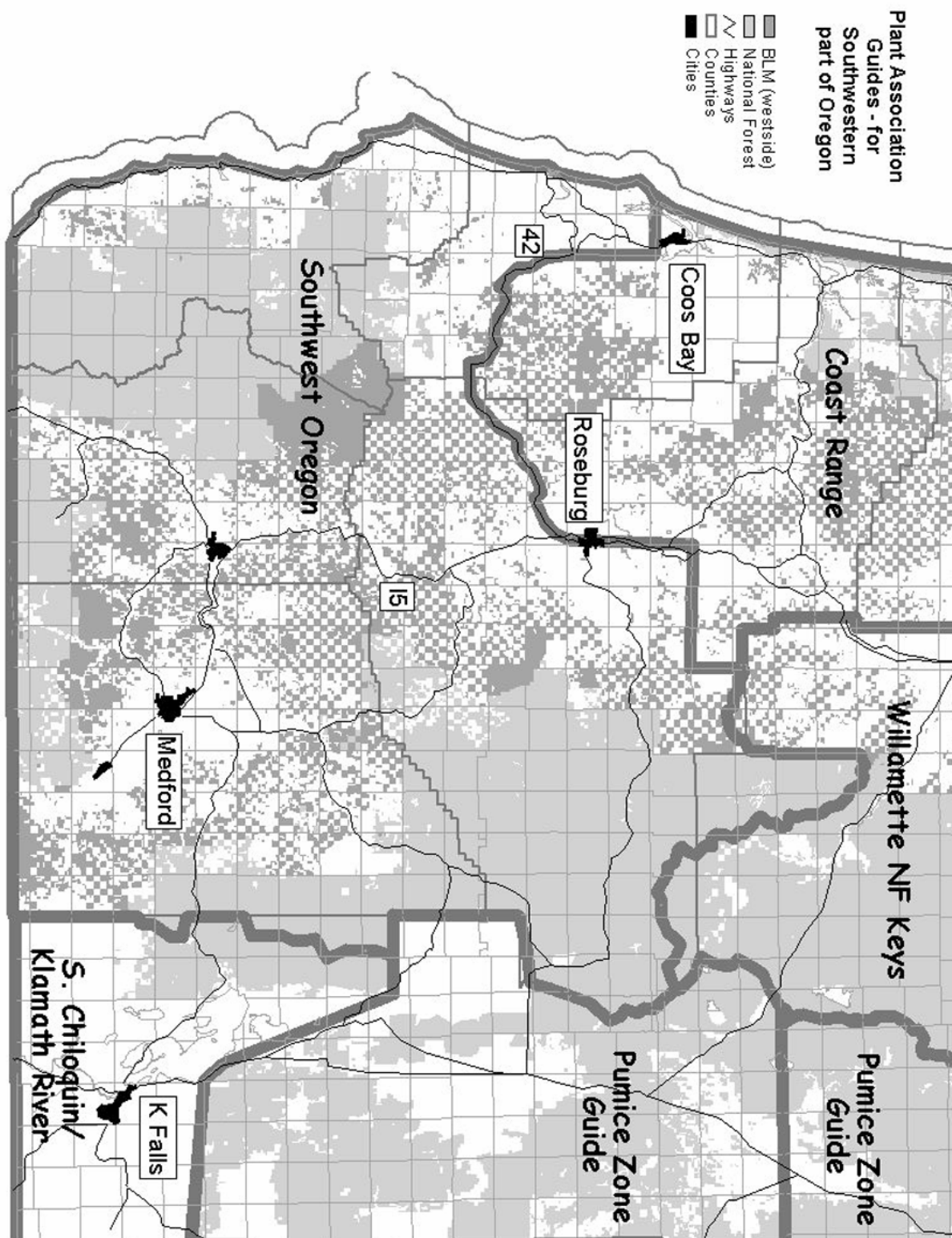

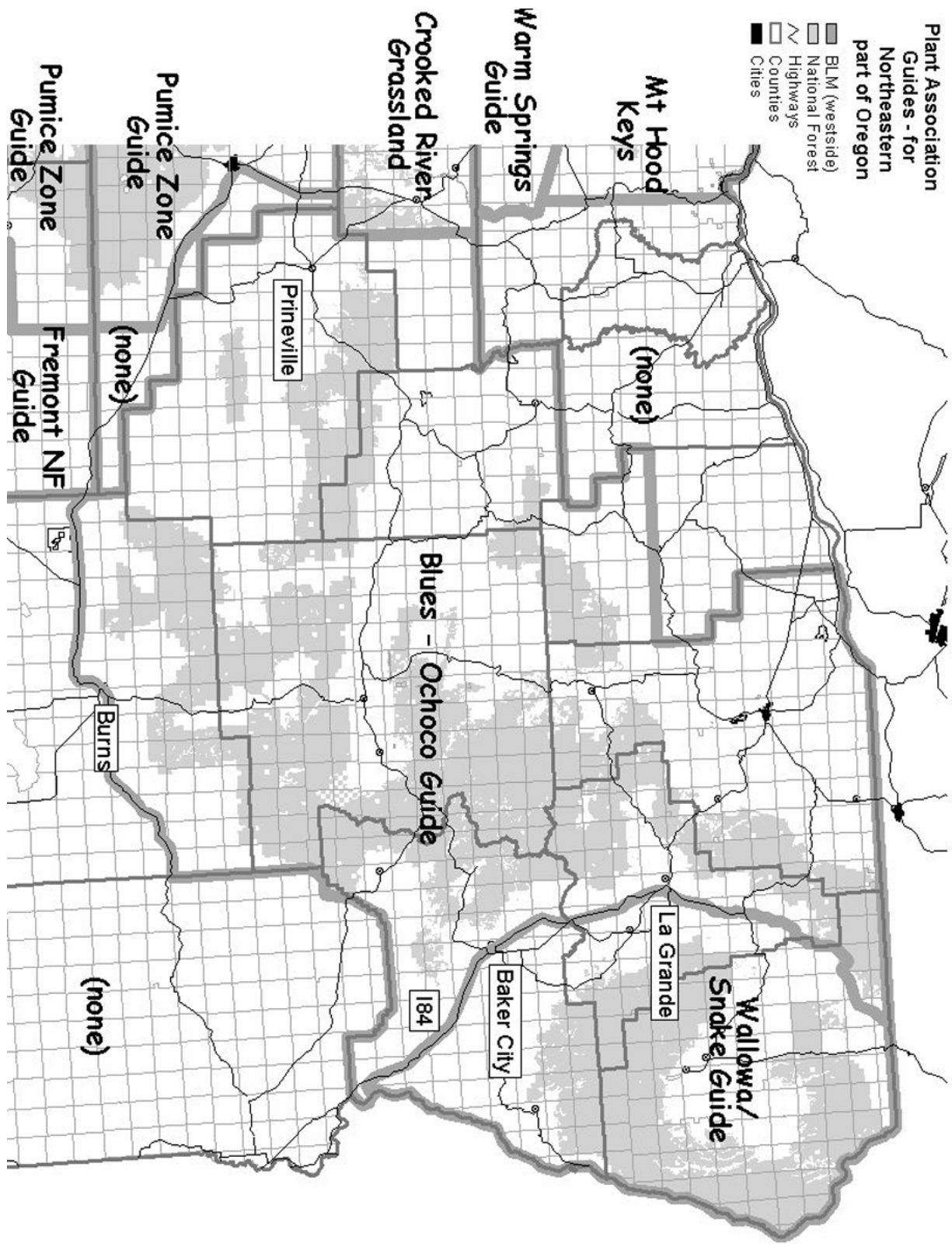

California

Guide to Forested Communities of the Upper Montane in the Central Sierra Nevada

Ecological Guide to Mixed Conifer Plant Associations: Northern Sierra Nevada & Cascades: Lassen, Plumas, Tahoe, and Eldorado National Forests

Ecological Guide to Southern California Chaparral Plant Series: Transverse & Peninsular Ranges: Cleveland & San Bernardino National Forests

Ecological Guide to Eastside Pine Plant Associations: Northeastern California: Modoc, Lassen, Klamath, Shasta-Trinity, Plumas, and Tahoe National Forests

A Field Guide to Serpentine Plant Associations and Sensitive Plants in Northwestern California

A Field Guide to the Tanoak and the Douglas-fir Plant Associations In Northwest California

APPENDIX 10 -- METRIC EQUIVALENTS AND AIDS

Length

1 inch	=	2.54 centimeters (cm.)
0.1 feet	=	3.048 centimeters (cm.)
1 foot	=	0.3048 meter (m.)
1 mile	=	1.609 kilometers (km.)
1 centimeter (cm.)	=	.03 foot (ft.)
1 meter (m.)	=	3.2808 feet (ft.)

Area

1 acre	=	0.4 hectare (ha.) (approximately)
5 acres	=	2 hectares (ha.) (approximately)
1,000 acres	=	404.7 hectares (ha.)
1 hectare	=	2.471 acres (ac.)
2.5 hectares	=	6 acres (ac.) (approximately)

Volume

1,000 cubic feet	=	28.3 meters (m ³)
1 cubic foot per acre	=	0.07 cubic meter per hectare (m ³ /ha)

Condition class minimum area

0.4 hectares (1 acre)	=	4,000 square meters
	=	40 meters x 100 meters
	=	35 meter radius circle
1 acre	=	118 foot radius circle
	=	209 feet x 209 feet
	=	43,560 square feet

Basal Area Factor

Metric units: each selected tree represents XX square meters of basal area per hectare
English units: each selected tree represents XX square feet of basal area per acre.

<u>English</u>	<u>Metric</u>
15	3.44
20	4.59
30.5	7
30	6.88

Metric System-length

1 meter	=	10 decimeters (dm.)
1 meter	=	100 centimeters (cm.)
1 meter	=	1,000 millimeters (mm.)

and:

.001 meters = 1 millimeter
 .01 meters = 1 centimeter
 .1 meters = 1 decimeter
 1 meter = 1 meter
 10 meters = 1 decameter
 100 meters = 1 hectometer
 1,000 meters = 1 kilometer

Photo Scales

<u>Scale</u>	<u>Length on Photo</u>	<u>Length on Ground</u>
1:15,840	1 mm.	15.8 meters
1:24,000	1 mm.	24.0 meters
1:31,680	1 mm.	31.7 meters
1:40,000	1 mm.	40.0 meters
1:15,840	1 inch	1,320 feet
	0.1 inch	132 feet
	.05 inch (1/20)	66 feet
1:24,000	1 inch	2,000 feet
	0.1 inch	200 feet
	.05 inch (1/20)	100 feet
1:31,680	1 inch	2,640 feet
	0.1 inch	264 feet
	.05 inch (1/20)	132 feet
1:40,000	1 inch	3,333 feet
	0.1 inch	333 feet
	.05 inch (1/20)	166 feet

APPENDIX 11 -- HELLO LETTER/DATA CONFIDENTIALITY

**United States
Department of
Agriculture**

**Forest
Service**

**Pacific
Northwest
Research
Station**

**Forestry Sciences Laboratory
P.O. Box 3890
Portland, Oregon 97208
(503) 808-2000**

File Code: 4810

Date: Summer 2004

To Whom It May Concern:

Hello, we are researchers from the USDA Forest Service, Pacific Northwest Research Station. We are obtaining information on the forest resources of the Pacific Northwest from measurements taken on a large number of randomly located sample plots on forestland. We are visiting one of these plots in this general vicinity today.

We locate each plot from a sample selected on an aerial photograph. While at the site we record information pertaining to the type of terrain; tree species, heights, and diameters; insect and disease damage; mortality and regeneration; and the amount and kind of understory vegetation. Many of our field plots were first established in the early 1960's and have been revisited on a 10-year cycle.

With the measurements we take, analysts will develop basic information about the amount, condition, and change in the area's forest resource. Published reports contain data on forest land area and ownership, timber volume, forest growth, mortality and cut, potential productivity, and opportunities for silvicultural treatment.

If you are interested in learning more about our research plans, or care to see publications from previous inventories similar to this one, please contact Otha Terry at (503) 808-2044 or Bob Rhoads at (503) 808-2022 by telephone or by writing to:

Portland Forestry Sciences Laboratory
Forest Inventory and Analysis Program
P. O. Box 3890
Portland, OR 97208-3890

Sincerely,

BOB RHOADS
Team Leader
Forest Inventory and Analysis

APPENDIX 12 -- INTERIM LOCATION CONFIDENTIALITY POLICY

The “Interim Privacy Policy-8/2000” from the Washington FIA Office, describes in detail the confidentiality policy as it applies to all owners. This policy, along with the law as it is written are both provided following this document.

The purpose of this document is to aid field crews in applying the policy and following the law in discussions with landowners. It will provide: a listing of what information we can and cannot provide based on our privacy policy, conversation scenarios showing tactics crews can use with landowners who are requesting location information, how to get directions to the plot without disclosing confidential plot coordinates, what the exception to the law is and why, and finally, what to do when all your attempts seem to fail but you think the owner might still grant access. Contacts and references are provided at the end.

Summary of FIA privacy (confidentiality) policy

Location information we CAN provide to the landowner:

- USGS quad the plot falls on.
- Landmarks near the plot, but not within one mile of the plot.
- Township, Range, and Section (“legal”) the plot falls within. For example, “Township 10 South, Range 5 East, Section 16.”
- Owner’s tax parcel number. Used only when the owner questions whether they own the property.

Location information we CANNOT provide:

- UTM coordinates, whether derived from a map or from the field GPS reading, also known as the “northing” and the “easting.”
- The Quarter Section of the above TRS legal the plot falls within. For Example, “NESW, or, Northeast Quarter of the Southwest Section.”
- Latitude and Longitude.
- Giving the photo (or a copy of the photo) with the pinprick for them to keep or copy.
- Giving the USGS quad (or a copy of the USGS quad) with plot location marked for them to keep or copy.

Conversation scenarios

Occasionally, a landowner insists on detailed location information beyond what we are permitted to disclose. Crews need clear direction in how to proceed in a conversation when they have to deny the owner’s request but still try to gain access to their land. Here are several hypothetical scenarios that demonstrate the policy in action. Suggested crew responses are provided as guides. The scenarios begin after the crew introduces themselves and requests access.

Scenario 1

Landowner (L): small woodlot owner: “Where are you working?”

Crew (C): “The plot is a couple miles up Windy Road and south of Burnt Hill.”

L: “OK, good luck.”

Scenario 2

L: Forester for Small Forest Industries: “Where is your research plot located?”

C: “We’re several miles up road 452.”

L: *“If you tell me the legal description, I can tell you the best way to get there and if there are any gates.”*

C: “It’s located in Township...Range... Section...”

L: “Ok, there is one gate on that road but it’ll be locked after 6pm. Will you be out of there by then?”

<As far as one can gain access without having to say “I am not allowed to give you that information” the smoother the conversation will be. The immediate landowner response to denying them information is nearly always alarm, defensiveness, and distrust. Fortunately, most people don’t want or need a detailed account of the location. The

more general you can be about the location and satisfy the landowner without having to give any further explanations or justifications, then the least likely you are to raise a negative response>

Scenario 3

L: A scientist who spends her spare time exploring wilderness areas. Upon hearing a vague location response, she says, "That's fine, but I'd like to know exactly where it is. A GPS reading even would be nice."

C: "Because of confidentiality laws, I am unable to give you the plot's GPS reading or, UTM coordinates. I know it sounds strange because it is your land, but the law applies to everyone. It was written to protect landowners from data being used against them. I can't give you that information, but I also can't give the EPA or any group that information. This policy attempts to be fair in protecting your privacy."

L: "Laws, huh... Well, I guess it's OK. Can I go with the crew and get my own GPS reading?"

C: "Sure."

<Crews should not initially encourage or offer landowners the option of going with the crew either to obtain their own GPS reading or as an escort. This is used as a last resort when it is clear the landowner won't grant access otherwise. In the cases where the landowner wants to accompany the crew because they are just curious about the work we're doing, rather than the location of the work, emphasize to the landowner the importance of the plot area being treated exactly the same as they would treat the rest of their property. See scenario four, below>

Scenario 4

L: District manager for a large forest industry: "We need your plot coordinates for our records."

C: "I can't provide that information because of confidentiality laws that apply to everyone. The laws protect landowners from information we gather being used against them."

L: "I'm not sure we can grant access without that information. Let me check into it, then get back to you."

C: "I can give TRS, would that be enough? Another reason we don't give coordinates, is that some owners manage the plots differently from the rest of their land once they know where they are, and we don't want that to happen. Since we track changes over time, if there are islands of plots with mature trees surrounded by clearcuts, for example, this means the data has become biased and is now unreliable."

Scenario 5

L: National Forest employee who is not an FIA National Forest regional inventory coordinator. "Where are your plots located in this forest? I want to send a crew along to see how the plots are measured. I am also interested in using the data for analysis."

C: "We cannot permit your crews or other personnel to accompany us to the plot, unless they are contract crews specifically hired to collect FIA data on that plot. This is regulated through a Memorandum of Understanding (MOU) between the FIA program and the National Forest system."

L: "So, you're telling me that even though this is public property, that even federal employees can't have access to the plots or the data? I have a legitimate interest in where these plots are located. Besides, I thought the Freedom Of Information Act was created to allow access to public information."

C: "There is an exemption from the Freedom Of Information Act concerning FIA plot locations. If you believe you have a legitimate need for location information and raw data for analysis, then you will need to contact your National Forest regional FIA coordinator. If you want to visit the plot, you will need to contact our program manager."

<See contacts section>

Scenario 6 (data request)

L: "I am interested in receiving plot data."

Annual Inventory 2004
APPENDICES

C: "No problem. I'll send your request to the office."

<The crew will then enter into the husky program that the owner has requested data. This is all that needs to be done. Otha Terry will obtain the information when the plots are electronically sent to the office. He will then use a program that will summarize the data, and send it to the landowner. However, this data will not include the plot coordinates>

How to get directions

You're trying to get to a plot and you know the landowner often knows the best route in. One could say "The plot is up Mountain Pass Road about 6 miles. Are there any access restrictions?" Or if it's a forester for a timber company, one could give the TRS, which should be enough for him or her to recommend a route. Aerial photos usually provide the crew enough near-plot access information.

Exception to the law

As mentioned in scenario five above, there is a Memorandum of Understanding (MOU) between the FIA program and the National Forest system for obtaining detailed location information. The MOU only covers the National Forest employees that are directly involved in FIA work. Regional inventory coordinators are the official National Forest staff that is given exact plot locations that they may use to give to contract crews and for data analysis.

The last resort

When an owner simply doesn't understand the privacy laws and expresses a desire for more information before they might grant access, then the crew can offer a copy of the law to mail to the owner, and/or give the state coordinator's name and number for the landowner to contact for a more authoritative response.

Contacts

There are a couple of special circumstances where a referral to specific FIA contacts is appropriate. This will be a very rare occurrence, and is not to be used for the majority of landowner questions that can be handled by the crews, state coordinators and assistant state coordinators.

For plot location and data requests from federal land managers who are not directly involved in FIA work already, they can contact our program manager, Sue Willits at 503-808-2066.

For FIA plot locations and data requests from National Forest personnel who are not directly involved in FIA, they can contact their FIA regional coordinator. For Region 5 (California), contact Ralph Warbington at 916-454-0809. For Region 6 (Oregon and Washington), contact Jim Alegria at 503-808-6090.

If National Forest personnel (who are not directly involved in FIA) want to visit an FIA plot, they will need to contact our program manager, Sue Willits at 503-808-2066.

For GIS-specific plot information (generally requested by large landowners like large timber companies) the contact is Dale Weyermann at 503-808-2042.

References

Public Law 99-198 [H.R. 2100]; December 23 1985. Privacy Amendment: H.R.3423 Department of the Interior and Related Agencies Appropriations Act, 2000 (November 17, 1999). Electronic mail: "New Legislation on Privacy for FIA Data and Information."

USDA Forest Service, FIA. "Confidentiality of FIA Sample Locations." FIA Fact Sheet Series. 2001.

USDA Forest Service, Washington Office. "Access to Exact Coordinates for FIA Plots-Interim Privacy Policy." 2000.

Weyermann, Dale. Personal Communication. 2002.

Willits, Susan A. Personal Communication. 2002.

Access to Exact Coordinates for FIA Plots

Final Interim Privacy Policy August 2000

BACKGROUND. Present FIA policy (Federal Register / Vol. 54, No. 203 / Monday, October 23, 1989) calls for public release of coordinates rounded to the nearest 100 seconds (approx. 1 mile). This is currently available publicly for most data collected between 1995 and 1999 (e.g. in the eastwide database) and is sufficient for most users. However, some users may need access to more precise coordinates to reference FIA plot data to some other high-precision data layer, e.g. satellite imagery, DEM, or other modeled output.

FIA sample locations are kept confidential for three primary reasons:

1. **Protect landowners.** Our access to plots is only possible with landowner permission. Landowners are concerned about protecting their privacy, as well as the nuisance factor of having strangers on their property. Historically, we have promised landowners absolute confidentiality of their data - that is, there would be no way associate individual plot data with specific locations (and owners) on the ground. The new legislation now requires this. We also keep visits to a minimum of 1 or 2 times (including QA plots) every 5-10 years.
2. **Protect the integrity of the plots.** All plot visits involve risk of impacting the elements of the plot (e.g. cutting or damaging trees, compacting soils, trampling vegetation). This could result in biased estimates if our permanent plot system becomes unrepresentative of the sample population of interest (all US lands). Since we have no control over access to sample locations, the best way to protect the locations is to keep them confidential.
3. **Protect the reputation of the FIA program for providing unbiased information.** If plot locations are commonly known, specifically by land managers, there may be accusations that land managers are manipulating the results of the inventory by management practices, e.g. by not harvesting forest contained on sample plots.

Recent legislation has increased the emphasis on protecting the privacy of our plot locations beyond this earlier policy. In order to continue to serve our clients and partners, we must develop an interim policy that reflects the intent of the new legislation while we craft a more formal policy. We propose the following interim rules for access to FIA plot locations:

1. **ACCESS BY INTERNAL FIA STAFF.** Access to exact locations are granted to FIA program staff only to the extent that they need to know the location in order to perform their work. 'FIA program staff' refers to duly authorized agents of the FIA program including federal employees in FIA and FHM units, State partners, universities, or contractors who are actively involved in implementing the FIA program. Access to exact coordinates is only for the purpose of performing work in direct support of the FIA program, such as field data collection or analysis.
2. **ACCESS BY EXTERNAL USERS.** 'External users' are all users of FIA data who are not directly involved in accomplishing the FIA mission, including federal research staff, state agencies, universities, and other users. FIA will treat all external requests for exact coordinate information in a consistent fashion. FIA will continue to release approximate plot coordinates rounded to the nearest 100 seconds of latitude and longitude. This amounts to approximately plus or minus 1 mile., and is sufficient for many spatial applications. However, access by external users to exact coordinates differs for private land and public land.

2.1 ACCESS TO EXACT COORDINATES ON PUBLIC LAND.

FIA may release coordinates for plots on public lands to the Agency responsible for managing the land or to other cooperators during the interim policy period. This interim policy is intended to maximize the usefulness of the information on public land and thus maximize benefits to the taxpayers supporting the program. This would only be done under terms of a formal written agreement involving at a minimum the affected FIA unit(s), the affected public land management officers, and the cooperator. Land managers must agree to avoid treating the plot areas any differently than areas without plots to avoid sample bias. Managers will also be requested not to make this information generally public. Managers must understand that if these terms are violated, the plots may have to be abandoned and the data record severed.

The terms of agreement should at a minimum do the following:

- a. Refer to a written study plan describing the nature of the research, where and why the exact coordinates are needed, and how the data will be used.
- b. Set a definite sunset date after which time all coordinates are purged from cooperator paper and electronic files.
- c. State that no plot visits will occur without FIA permission, and that there will be no destructive sampling on plot. Plots must not be impacted by cooperators.
- d. Guarantee that there will be no subsequent sharing or release of coordinates by the cooperator.
- e. Guarantee that the appropriate FIA unit(s) receive credit in all resulting pubs for the grant of data.
- f. Provide for periodic reporting on the status of the research, including where the coordinates are currently located and who has access

2.2 ACCESS TO EXACT COORDINATES ON PRIVATE AND TRIBAL LAND

FIA does not release exact coordinates for private or tribal land, under any circumstances during the interim policy period. This is the only practical way to protect the privacy interests of private landowners. Failure to protect privacy will result in an increase in lands where access to collect data is denied.

For cases where users can demonstrate a true need for greater precision in plot locations, FIA should offer an alternative to release of plot coordinates. FIA can create in-house capability to collaborate with researchers. Coordinates can be used in the FIA office, by FIA staff or visiting colleagues, on FIA equipment. Research results, derived layers (but not exact coordinates) can leave the office when done. Advantage is that it allows research to proceed, increases use of FIA information and products, and does not compromise data security. It creates a way in which both FIA and user interests can be satisfied.

Confidentiality Certification

CONFIDENTIALITY CERTIFICATION AND REQUEST FOR ACCESS TO UNPUBLISHED FOREST INVENTORY AND ANALYSIS (FIA) SAMPLE SITE LOCATION DATA AGREEMENT

Version 1.01
30 April 2004
USDA Forest Service
PNW Research Station
Forest Inventory and Analysis Program
P.O. Box 3890
Portland, OR 97208

This agreement is intended to cover the following individuals and organizations, and is to be completed and signed anew for each research project that makes use of FIA Sample Site

Location Data:

1. Employees of the FIA Program who, while located physically off-premises of the Portland or Anchorage Labs of the PNW Research Station, work with sample site location data or derivative products from which sample locations and/or landowner identities could be recovered by a motivated individual.
2. Researchers who collaborate with employees of the FIA Program and who are given use of derivative products from which sample locations and/or landowner identities could be recovered by a motivated individual.

Non-FIA employees requiring access to sample site location data (i.e., plot coordinates) are required to complete and receive PNW-FIA Program Manager approval of a memorandum of understanding covering such access prior to receiving such data.

A. CERTIFICATION AND RESTRICTIONS ON USE OF FOREST INVENTORY AND ANALYSIS SAMPLE SITE LOCATION DATA

The specific conditions of this agreement are:

1. All individual sample site location data are confidential. No copies of reports or computer files or data sets containing these sample site locations can be made or published. Also, summaries that could possibly reveal the location and/or identity of an FIA sample site may not be published nor made public to anyone not covered by this agreement.
2. These data will be used for "*statistical, analytical and research purposes*" only, and for purposes that enhance the Forest Inventory and Analysis Program.
3. Dissemination or sharing of 1) the FIA provided sample sites, 2) layers derived from the FIA provided sample sites which could be used to identify owners or reconstruct coordinates, or 3) FIA data aggregated in such a way that plot attributes could be linked to owners or used to

reconstruct coordinates, with persons other than those who are directly associated with the project for which the data were obtained and who have completed the CONFIDENTIALITY CERTIFICATION AND REQUEST FOR ACCESS TO UNPUBLISHED FOREST INVENTORY AND ANALYSIS (FIA) SAMPLE SITE LOCATION DATA agreement is strictly prohibited.

4. A courtesy briefing of any report using sample site location data will be given to the Program Manager, PNW Forest Inventory and Analysis Program, prior to publication.
5. Following publication of the research utilizing FIA Sample Site Locations, these location data will be returned to the PNW-FIA Program and any and all copies of this data (e.g., including on removable hard disks and backup tapes) will be destroyed at that time.
6. Confidential data, including sample site locations and any derived layers from which sample site locations could be recovered, will only be stored and used on a computer with security restrictions on file access which include password protection and the absence of a connection to wide area networks other than the firewall-protected Forest Service network.
7. Any questions regarding access to unpublished data, propriety of reports or analysis shall be referred to the *Program Manager, Forest Inventory and Analysis Program, PNW Research Station, USDA-Forest Service* for appropriate response.

In addition to the above conditions, I have been provided a copy of the Food Security Act Of 1985, Public Law 99-198 [H.R. 2100], December 23, 1985, Confidentiality Of Information, sec. 1770, as amended by H.R.3423 on November 17, 1999.

If approval is granted, all employees and/or sub-agents who will have access to FIA SAMPLE SITE LOCATION datasets will be required to sign a notarized or witnessed copy of the CONFIDENTIALITY CERTIFICATION AND REQUEST FOR ACCESS TO UNPUBLISHED FOREST INVENTORY AND ANALYSIS (FIA) SAMPLE SITE LOCATION DATA agreement. This signature certifies compliance with the laws and regulations listed in the agreement regarding confidentiality and other restrictions limiting the use of FIA datasets to the purpose(s) stated in section B: "Forest Inventory and Analysis (FIA) Data Request Overview"

I certify that I have read the above-mentioned conditions and regulations this ___ day of _____, 2003, and agree to these conditions concerning the use of unpublished FIA data provided by the PNW-FIA Program in response to my request.

(Signature)

(Type or print name)

(Agency/Organization)

(City and State)

Witnessed by: _____

Date: _____

B. FOREST INVENTORY AND ANALYSIS (FIA) DATA REQUEST OVERVIEW

Specify sample site data needed (include dates of coverage if applicable):

--

- 1) Plot locations, written directions to plots, and descriptions of plots as needed to facilitate field visitation. This includes geographic coordinates (latitude/longitude, or UTM coordinates) as well all Public Land Survey legal descriptions below the Section level.
- 2) Name, address, and any other identifying information of the owner of record for each plot to be visited.

The following use will be made of these data:

- 1) FIA crews and authorized contractors will use plot locations and descriptions to navigate to each plot in the safest and most efficient manner.
- 2) FIA crews and authorized contractors will use owner information as needed to obtain or verify permission to visit plots, or to contact the owner for access information (road conditions, existence of locked gates, acquiring a key or lock code, etc).
- 3) All location and owner information will be returned to the FIA program office in Portland upon completion of the field season or the termination of the contract. All location and owner information outside the Portland FIA office will be removed from all computers, databases and written records at that time.

Attach other appropriate project information, including:

- (1) Timing of proposed project
- (2) Methods of analysis or statistical techniques to be used
- (3) Levels of reliability required.
- (4) Level of interpretation planned.
- (5) Where the data set will reside or be used and security provisions for the computer on which it will reside (i.e., not connected to any non-Forest Service network, not shared with anyone who has not signed this certification).
- (6) Organizational units and/or sub-agents who will have access to the data.

C. FOREST INVENTORY AND ANALYSIS DATA RELEASE AUTHORIZATION

(reference section A, "Certification and restrictions on use of Forest Inventory and Analysis sample site location data", and section B, "Forest Inventory And Analysis [FIA] data request overview")

Approved ____

Disapproved ____ for the following reasons (if applicable):

(Signature of PNW-FIA Program Manager)

(Date)

Sample Memorandum of Understanding

Between

Name of FIA partner/cooperator here

and

Name of Research Station here

UNITED STATES DEPARTMENT OF AGRICULTURE - FOREST SERVICE

This Memorandum of Understanding (MOU) is made and entered into by and between the **Name of FIA partner/cooperator here**, a public agency, hereinafter referred to as the **Shortened name of FIA partner/cooperator here** and the United States Department of Agriculture, Forest Service, **Name of Research Station here**, hereinafter referred to as the Forest Service.

I. **PURPOSE:** *(amend as necessary)*

The Forest Service collects renewable forest resources information across the **[geographic area of interest here]**, and maintains these data in geospatial databases that can be linked to individual land owners. This raises privacy issues concerning the release of personal information that the landowner may consider proprietary or confidential. New legislation regarding FIA data redefines rules for disclosure of plot locations under Section 1770(d) of the Food Security Act of 1985 (7 U.S.C. 2276(d)) and supercedes the previous release policy found in Forest Resource Inventory Statistics guidance in Federal Register / Vol. 54, No. 203 / Monday, October 23, 1989 / Notices 43189-90.

This agreement document serves as an interim policy and outlines the conditions under which the Forest Service will release plot locations to partners/cooperators who are actively engaged in implementing or forwarding the Forest Service mission through work or research, and the protections imposed to insure continued privacy and confidentiality of the personal information released.

II. **STATEMENT OF MUTUAL BENEFITS AND INTERESTS:** *(amend as necessary)*

Both the Forest Service and **the partner/collaborator** conduct and have a mutual interest in research pertaining to the renewable forest resources of the **[geographic area of interest]**. The Forest Service is conducting research to ascertain the extent, status, and changes in the forests in this region as part of its annual Forest Inventory and Analysis (FIA) effort. The **partner/collaborator** has an interest in obtaining timely, relevant, and accurate research results that are delivered as efficiently as possible. The **partner/collaborator** has the resources, facilities, and expertise to more efficiently [gather resource information on FIA plots, test the feasibility of a new remote sensing technique to speed phase 1 area estimates, employ new remote sensing techniques in forest resource analyses, etc. etc]. In order to take full advantage of the mutual benefits that a collaborative partnership could offer to FIA, the partner/cooperator, and their respective publics, the FIA plot locations will have to be released to the **partner/cooperator**. Given that the Forest Service does not want to release any data that might be considered privileged or proprietary by any individual or corporate landowner; that the Forest Service does not want the release of such data to restrict access to the plots in the future; that the Forest Service does not want the release of such data to cause plots to be treated differently than they would have otherwise been treated, which would bias our results; and that the Forest Service does not want the release of such data to damage the credibility and reputation of the FIA program, both parties agree to share plot location information for the benefit of all with the following stipulations:

III. **THE Partner/cooperator AGREES to:**

1. not disclose the plot locations to any **other** party,
2. not use the plot locations for purposes other than those in this agreement,
3. not visit the actual sites of the plot locations,
4. not contact, bother, or otherwise infringe upon the landowners of the plot locations,
5. not conduct destructive or intrusive sampling (soil extraction, plant removal, trampling, etc) within the bounds of the Forest Service plot (see attached plot diagram),
6. not alter what would be normal business operations/forest management activities on the sites of the plot locations,
7. not disclose the forest inventory data for an individual private or corporate landowner,
8. not use the forest inventory data for regulatory actions against the landowner,

9. allow the Forest Service review study plans and reports resulting from the use of plot locations and their associated forest inventory data,
10. give the Forest Service credit (written/oral acknowledgements, authorships, etc) as the source of the forest inventory data used,
11. allow the Forest Service to use the final product/results in other applications and locations,
12. delete, purge, or otherwise destroy all hardcopy and electronic files containing the plot locations, and to return all plot navigational aids (plot sheets, photos, etc) to the Forest Service at the expiration of this agreement or termination/completion of work.

IV. THE FOREST SERVICE AGREES to: *(amend as necessary)*

1. provide the location (coordinates) of the necessary FIA plots,
2. provide the plot sheets, photos, and other navigational aids necessary to establish or recover the FIA plots,
3. provide the data collected by the Forest Service on these plots in electronic form,
4. provide assistance in understanding, using, and interpreting the data provided.

V. IT IS MUTUALLY AGREED AND UNDERSTOOD BY AND BETWEEN THE SAID PARTIES THAT:

1. Violation. Any act by the partner/cooperator and/or their assigns that violates any of the provisions of plot location access, use, and disclosure describe above will be subject to penalties pursuant to the provisions of the FOOD SECURITY ACT OF 1985 (PL 99-198, December 23, 1985)
2. Termination. Either party(s), in writing, may terminate the instrument in whole, or in part, at any time before the date of expiration.
3. Participation in Similar Activities. This instrument in no way restricts the Forest Service or the Cooperator(s) from participating in similar activities with other public or private agencies, organizations, and individuals.
4. Restriction for Delegates. Pursuant to Section 22, Title 41, United States Code, no member of, or Delegate to, Congress shall be admitted to any share or part of this instrument, or any benefits that may arise therefrom.
5. Completion Date. This instrument is executed as of the last date shown below and expires on **Enter date or expiration**, at which time it will be subject to review, renewal, or expiration.
6. Principal Contacts. The principal contacts for this instrument are:

**Name, address, etc. for
Research Station contact**

**Name, address, etc. for
FIA cooperator**

7. Non-Fund Obligor Document. This instrument is neither a fiscal nor a funds obligation document. Any endeavor involving reimbursement or contribution of funds between the parties to this instrument will be handled in accordance with applicable laws, regulations, and procedures including those for Government procurement and printing. Such endeavors will be outlined in separate agreements that shall be made in writing by representatives of the parties and shall be independently authorized by appropriate statutory authority. This instrument does not provide such authority. Specifically, this instrument does not establish authority for noncompetitive award to the cooperator of any contract or other agreement. Any contract or agreement for training or other services must fully comply with all applicable requirements for competition.
8. Modification. Modifications within the scope of this instrument shall be made by the issuance of a bilaterally executed modification prior to any changes being performed.

IN WITNESS WHEREOF, the parties hereto have executed this MOU as of the last written date below.

Station Director Date

Regional or State Forester Date

Partner/cooperator Date

New Legislation on privacy for FIA data and information

1. Privacy Amendment: H.R.3423 Department of the Interior and Related Agencies Appropriations Act, 2000 (November 17, 1999)

TITLE III--GENERAL PROVISIONS

SEC. 348. Section 1770(d) of the Food Security Act of 1985 (7 U.S.C. 2276(d)) is amended by redesignating paragraph (10) as paragraph (11) and by inserting after paragraph (9) the following new paragraph:

'(10) section 3(e) of the Forest and Rangeland Renewable Resources Research Act of 1978 (16 U.S.C. 1642(e));'

2. The Law which was amended:

FOOD	SECURITY	ACT	OF	1985
PUBLIC LAW 99-198 [H.R. 2100]; December 23, 1985				

CONFIDENTIALITY OF INFORMATION SEC. 1770.

(a) In the case of information furnished under a provision of law referred to in subsection (d), neither the Secretary of Agriculture, any other officer or employee of the Department of Agriculture or agency thereof, nor any other person may-

(1) use such information for a purpose other than the development or reporting of aggregate data in a manner such that the identity of the person who supplied such information is not discernible and is not material to the intended uses of such information; or

(2) disclose such information to the public, unless such information has been transformed into a statistical or aggregate form that does not allow the identification of the person who supplied particular information.

(b) (l) In carrying out a provision of law referred to in subsection (d), no department, agency, officer, or employee of the Federal Government, other than the Secretary of Agriculture, shall require to furnish a copy of statistical information provided a person to the Department of Agriculture.

(2) A copy of such information-

(A) shall be immune from mandatory disclosure of any type, including legal process; and

(B) shall not, without the consent of such person, be admitted as evidence or used for any purpose in any action, suit, or other judicial or administrative proceeding.

(c) Any person who shall publish, cause to be published, or otherwise publicly release information collected pursuant to a provision of law referred to in subsection (d), in any manner or for any purpose prohibited in section (a), shall be fined not more than \$10,000 or imprisoned for not more than 1 year, or both.

(d) For purposes of this section, a provision of law referred to in this subsection means-

(1) the first section of the Act entitled "An Act authorizing the Secretary of Agriculture to collect and publish statistics of the grade and staple length of cotton", approved March 3, 1927 (7 U.S.C. 471) (commonly referred to as the "Cotton Statistics and Estimates Act");

(2) the first section of the Act entitled "An Act to provide for the collection and publication of statistics of tobacco by the Department of Agriculture", approved January 14, 1929 (7 U.S.C. 501);

(3) the first section of the Act entitled "An Act to provide for the collection and publication of statistics of peanuts by the Department of Agriculture", approved June 24, 1936 (7 U.S.C. 951);

(4) section 203(g) of the Agricultural Marketing Act of 1946 (7 U.S.C. 1622(g));

(5) section 526(a) of the Revised Statutes (7 U.S.C. 2204(a));

(6) the Act entitled "An Act providing for the publication of statistics relating to spirits of turpentine and resin", approved August 15, 1935 (7 U.S.C. 2248);

(7) section 42 of title 13, United States Code;

(8) section 4 of the Act entitled "An Act to establish the Department of Commerce and Labor", approved February 14, 1903 (15 U.S.C. 1516);

(9) section 2 of the joint resolution entitled "Joint resolution relating to the publication of economic and social statistics for Americans of Spanish origin or descent", approved June 16, 1976 (15 U.S.C. 1516a).

(10) section 3(e) of the Forest and Rangeland Renewable Resources Research Act of 1978 (16 U.S.C. 1642(e)); or

3. What the amendment applies to:

FOREST AND RANGELAND RENEWABLE RESOURCES RESEARCH ACT
Act of June 30, 1978 (P.L. 95-307, 92 Stat. 353, as amended 16 U.S.C. 1642(e))

RESEARCH AUTHORIZATION

SEC. 3(e) Forest Inventory and Analysis.--

(1) Program required.--In compliance with other applicable provisions of law, the Secretary shall establish a program to inventory and analyze, in a timely manner, public and private forests and their resources in the United States.

(2) Annual state inventory.--

(A) In general.--Not later than the end of each full fiscal year beginning after the date of enactment of this subsection, the Secretary shall prepare for each State, in cooperation with the State forester for the State, an inventory of forests and their resources in the State.

(B) Sample plots.--For purposes of preparing the inventory for a State, the Secretary shall measure annually 20 percent of all sample plots that are included in the inventory program for that State.

(C) Compilation of inventory.--On completion of the inventory for a year, the Secretary shall make available to the public a compilation of all data collected for that year from measurements of sample plots as well as any analysis made of the samples.

(3) 5 -year reports.--Not more often than every 5 full fiscal years after the date of enactment of this subsection, the Secretary shall prepare, publish, and make available to the public a report, prepared in cooperation with State foresters, that--

(A) contains a description of each State inventory of forests and their resources, incorporating all sample plot measurements conducted during the 5 years covered by the report;

(B) displays and analyzes on a nationwide basis the results of the annual reports required by paragraph (2); and

(C) contains an analysis of forest health conditions and trends over the previous 2 decades, with an emphasis on such conditions and trends during the period subsequent to the immediately preceding report under this paragraph.

(4) National standards and definitions.--To ensure uniform and consistent data collection for all forest land that is publicly or privately owned and for each State, the Secretary shall develop, in consultation with State foresters and Federal land management agencies not under the jurisdiction of the Secretary, and publish national standards and definitions to be applied in inventorying and analyzing forests and their resources under this subsection. The standards shall include a core set of variables to be measured on all sample plots under paragraph (2) and a standard set of tables to be included in the reports under paragraph (3).

(5) Protection for private property rights.--The Secretary shall obtain authorization from property owners prior to collecting data from sample plots located on private property pursuant to paragraphs (2) and (3).

(6) Strategic plan.--Not later than 180 days after the date of enactment of this subsection, the Secretary shall prepare and submit to Congress a strategic plan to implement and carry out this subsection, including the annual updates required by paragraph (2) and the reports required by paragraph (3), that shall describe in detail--

(A) the financial resources required to implement and carry out this subsection, including the identification of any resources required in excess of the amounts provided for forest inventorying and analysis in recent appropriations Acts;

(B) the personnel necessary to implement and carry out this subsection, including any personnel in addition to personnel currently performing inventorying and analysis functions;

(C) the organization and procedures necessary to implement and carry out this subsection, including proposed coordination with Federal land management agencies and State foresters;

(D) the schedules for annual sample plot measurements in each State inventory required by paragraph (2) within the first 5-year interval after the date of enactment of this subsection;

(E) the core set of variables to be measured in each sample plot under paragraph (2) and the standard set of tables to be used in each State and national report under paragraph (3); and

(F) the process for employing, in coordination with the Secretary of Energy and the Administrator of the National Aeronautics and Space Administration, remote sensing, global positioning systems, and other advanced technologies to carry out this subsection, and the subsequent use of the technologies.

4. The Statute – applicable US Code:

Ch. 55 DEPARTMENT OF AGRICULTURE

U.S.C. 7 § 2276

§ 2276. Confidentiality of information

(a) Authorized disclosure

In the case of information furnished under a provision of law referred to in subsection (d) of this section, neither the secretary of Agriculture, any other officer or employee of the Department of Agriculture or agency thereof, nor any other person may-

- (1) use such information for a purpose other than the development or reporting of aggregate data in a manner such that the identity of the person who supplied such information is not discernible and is not material to the intended uses of such information; or
- (2) disclose such information to the public, unless such information has been transformed into a statistical or aggregate form that does not allow the identification of the person who supplied particular information.

(b) Duty of Secretary; immunity from disclosure; necessary consent

In carrying out a provision of law referred to in subsection (d) of this section, no department, agency, officer, or employee of the Federal Government, other than the Secretary of Agriculture shall require a person to furnish a copy of statistical information provided to the Department of Agriculture.

(2) A copy of such information-

- (A) shall be immune from mandatory disclosure of any type, including legal process; and
- (B) shall not, without the consent of such person, be admitted as evidence or used for any purpose in any action, suit, or other judicial or administrative proceeding.

(c) Violations; penalties

Any person who shall publish, cause to be published, or otherwise publicly release information collected pursuant to a provision of law referred to in subsection (d) of this section, in any manner or for any purpose prohibited in section 1 (a) of this section, shall be or fined not more than \$10,000 or imprisoned for not more than 1 year, or both.

(d) Specific provisions for collection of information

For purposes of this section, a provision of law referred to in this subsection means-

- (1) the first section of the Act entitled "An Act authorizing the Secretary of Agriculture to collect and publish statistics of the grade and staple length of cotton", approved March 3, 1927 (7 U.S.C. 471) (commonly referred to as the "Cotton Statistics and Estimates Act");
- (2) the first section of the Act entitled "An Act to provide for the collection and publication of statistics of tobacco by the Department of Agriculture", approved January 14, 1929 (7 U.S.C. 501);
- (3) the first section of the Act entitled "An Act to provide for the collection and publication of statistics of peanuts by the Department of Agriculture", approved June 24, 1936 (7 U.S.C. 95 1);
- (4) section 203(g) of the Agricultural Marketing Act of 1946 (7 U.S.C. 1622(g));
- (5) section 526(a) of the Revised Statutes (7 U.S.C. 2204(a)); (6) the Act entitled "An Act providing for the publication of statistics relating to spirits of turpentine and resin", approved August 15, 1935 (7 U.S.C. 2248);
- (7) section 42 of Title 13;
- (8) section 4 of the Act entitled "An Act to establish the Department of Commerce and Labor", approved February 14, 1903 (15 U.S.C. 1516);
- (9) section 2 of the joint resolution entitled "Joint resolution relating to the publication of economic and social statistics for Americans of Spanish origin or descent", approved June 16, 1976 (15 U.S.C. 1516a); or
- (10) section 3(e) of the Forest and Rangeland Renewable Resources Research Act of 1978 (16 U.S.C. 1642(e));

(Pub.L. 99-198, Title XVII, § 1770, Dec. 23, 1985, 99 Stat. 1657.)

1 So in original. Probably should be "subsection".

5. Previously published policy on data release:

Annual Inventory 2004
APPENDICES

Federal Register / Vol. 54, No. 203 / Monday, October 23, 1989 / Notices 43189-90
Forest Resource Inventory Statistics
AGENCY: Forest Service, USDA.
ACTION: Notice; uniform data and coding proposal.

SUMMARY: The Forest Service is proposing to improve the usefulness of its forest resource inventory information by making data available to the public in a uniform format for the entire Eastern United States. The new format would include detailed ownership codes and sample plot coordinates. This change will provide improved public access to current forest resource data collected by four research facilities in the East and improved capabilities for making comparative analyses. Public review is invited

DATE: Comments must be received in writing by December 1, 1989.

ADDRESSES: Send written comments or requests for the draft format and coding publication to F. Dale Robertson, Chief (1500)- Forest Service, USDA, P.O. Box 96090, Washington, DC 20090-6090
Comments are available for inspection in the office of Forest Inventory, Economics, and Recreation Research, 14th and Independence Avenue, SW. room 4105 between the hours of 8 a.m. and 4 p.m. Monday through Friday. To facilitate entrance into building, visitors are encouraged to call ahead (447-2747).

FOR FURTHER INFORMATION CONTACT:
Richard A Birdsey, Forest Inventory, Economics, and Recreation Research Staff, 202-382-9341.

SUPPLEMENTARY INFORMATION: Through its Research organization, the Forest Service conducts continuing Statewide inventories of the Nation's forest resources to ascertain trends in the extent, condition, ownership, quantity, and quality of the forest resources. These statistics and subsequent analyses are released as unit, state, regional, and national resource bulletins and forest resource reports. The statistical reports are based on data collected at sample locations across the United States. Access to original data is available to the public on data tapes or through direct electronic links to data files after the State statistical report has been transmitted for publication.

In the past, data collected at different Experiment Stations have been made available in different formats and systems. For this reason, multiregional analyses were difficult. Four Forest Service Experiment Stations, whose territories encompass the eastern United States (all states east of and including North Dakota, South Dakota, Nebraska, Kansas, Oklahoma, and Texas), have proposed a uniform format and coding system for providing data to requesters. This would allow requesters to perform their own statistical analyses for several States or geographic regions within two or more States inventoried by different Experiment Stations.

The proposed new format includes coding of ownership categories for sample plots on forest lands. Ownership categories include National Forest, Bureau of Land Management, Indian Lands, Other Federal Agencies, State, County and Municipal, Forest Industry, Farmer, Farmer Leased, Other Private-Corporate, Other Private- Individual, Other Private-Corporate Leased, and Other Private-Individual Leased. The new format also includes latitude and longitude coordinates for sample plots with an accuracy of plus or minus 100 seconds (approximately one mile).

If the new format is adopted, it would be used as new State inventories are completed, and the agency would plan to expand this service nationwide as technology and resources permit. A draft publication containing complete details of the proposed formats and coding, and information about how to obtain the data, is available for review upon request.

Dated: October 13, 1989.
George M. Leonard,
Associate Chief
[FR Doc. 89-24929 Filed 10-20-89; 8:45 am]

APPENDIX 13 -- LANDOWNER CONTACT LETTER

United States
Department of
Agriculture

Forest
Service

Pacific
Northwest
Research
Station

Forestry Sciences Laboratory
P.O. Box 3890
Portland, Oregon 97208
(503) 808-2000

File Code: 4810

Date:

«OWN_NAME»
«ADDRESS_LINE_1»
«ADDRESS_LINE_2»
«ADDRESS_LINE_3»

Dear <Salutation>

The Pacific Northwest Research Station in Portland, Oregon, is continuing to collect basic information of forest resources in the State of _____. Forest Inventory and Analysis (FIA) Program participates in a national effort to evaluate the status and condition of our Nation's forest ecosystems. Data is collected on FIA field plots, so that we can determine the amount, condition and trends of _____'s forested resources. The data will also provide information to detect and understand changes in local and regional forest health.

A grid of permanent plots was established in the 1960's and these plots have been re-measured on a 10-year cycle. Recently, our program has undergone changes, affecting how the inventory will be conducted. Starting this year a percentage of the FIA plots in _____ will be sampled across the state each year on a 5 and 10-year cycle. Our records indicate that one of these field plots occurs on property, which you own. The legal location is: Township, Range, and Section.

We would like your permission to access your land to measure the trees and other vegetation on this plot. Our measurements will not affect any ongoing or planned management practices or activities for this particular site. The data are not identified with your name or property, nor is the legal location disclosed. Data collected on your property are combined with that from other areas and counties in _____ to provide information about resource conditions in the State of _____. Collected data are summarized, analyzed, and published in statistical and analytical reports for the United States, for _____ alone, and for various geographic areas within _____ and are available to the public.

Our field staff will visit your area between April 30th and October 1st. We have enclosed a postcard for your response. Please return it so that the crews can contact you before visiting the plot. Please indicate on the response card of any access problems, such as locked gates, or special conditions that you may require of us when working on your land. If you have any questions regarding the Forest Inventory and Analysis Program, please contact Otha Terry at (503)-808-2044, or Bob Rhoads at (503)-808-2022.

We will be happy to share the resource information we gather from your property, should you be interested. Thank you again for your cooperation in this study. Your participation is greatly appreciated.

Sincerely,

SUSAN A. WILLITS
Program Manager
Forest inventory and Analysis

Enclosure

APPENDIX 14 -- LIABILITY LETTER

**United States
Department of
Agriculture**

**Forest
Service**

**Pacific
Northwest
Research
Station**

**Forestry Sciences Laboratory
P.O. Box 3890
Portland, Oregon 97208
(503) 808-2000**

File Code: 4810

Date:

RELEASE

The USDA FOREST SERVICE assumes liability, pursuant to the Federal Tort Claims Act, for any damages caused by negligence of Forest Service personnel while upon the landowner's property in connection with the inventory of forest resources in the State of Oregon, and the landowner shall not be liable for injuries occurring to Forest Service personnel for any reason except the negligent or wrongful acts of the landowner while they are on the property owned or controlled by the landowner.

County _____

Plot Number _____

Landowner _____

SUSAN A. WILLITS
Program Manager
Forest Inventory and Analysis
Pacific Northwest Research Station
US Department of Agriculture

APPENDIX 15 -- GLOSSARY

THE NATIONAL CORE GLOSSARY IS STILL UNDER REVISION (2/04)

APPENDIX 16 -- CHECK PLOTS

A. Objectives: Check plots are performed for several purposes:

1. To assess the accuracy of collected data;
2. To ensure that documented field plot instructions and accuracy standards are uniformly understood and consistently followed;
3. To assess the ability of individual crew members.

B. Check plot policies: The following policies for conducting check plots will be followed:

1. Each person will be checked within the first two weeks of field work and will accompany the checkplotter to the check plot.
2. Check plots will continue during the entire season; each person is checked multiple times throughout the field season.
3. All check plot items count equally for each person who did the plot.

C. Types of check plots:

Hot Check - an informal inspection done as part of the training process. The inspector is present on the plot with the trainee and provides immediate feedback regarding data quality. Data errors are corrected. Hot checks can be done on test plots or production plots.

Cold Check - a formal or informal inspection done either as part of the training process, or as part of an ongoing QC program. The inspector checks completed work after a crew has turned it in. Data errors are corrected. Cold checks are done on production plots only.

Blind Check - a formal inspection done without crew data on hand; a full re-installation of the plot for the purpose of obtaining a measure of data quality. The two data sets are maintained separately. Data errors are NOT corrected. Blind checks are done on production plots only.

D. Check plot procedures:

1. In the field, the check plotter checks all tree classifications and measurements. The check plotter or one of the crew members who originally did the plot makes all of the tree measurements during the check plot visit. These check measurements are compared to the original measurements recorded on the data recorder hardcopy. Items that do not meet accuracy standards are rechecked. Final decisions on accuracy rest with the check plotter. Errors are circled in red on the original tally sheet, and the correct value written near the circle.
2. Completing the check plot form. Field plot items on the check plot form are organized into categories based on what the items are related to. Each category is given a percentage rating based on the amount of items correct. The grading procedures give weights differently to items depending on the item's importance.

APPENDIX 17 -- INSECT AND DISEASE KEYS

Root Disease Identification Aids:

General root disease symptoms

Root disease centers or "pockets" usually appear as patches or groups of dead and dying trees. Trees in all stages of decline--long-dead trees, recent kills, declining live trees--are usually present; old dead trees are found at the center of the pocket, while declining trees occur near the leading edge of the expanding infected area; in contrast, bark beetle group kills usually consist of trees that died suddenly and simultaneously. Wind thrown trees with decayed roots broken off close to the root collar (root ball) may be evident, except for Black stain root disease and Annosus in pines, which do not form root balls. Individual trees affected by root disease may exhibit the following above-ground symptoms:

1. Reduced height growth increment (as compared to neighboring healthy trees). This results from gradual decline as the root system is slowly destroyed. Look for progressively short internodes of the terminal leader.
2. Sparse, yellow crowns. Trees infected by root disease fungi often lose needles; needles that remain are often yellow (chlorotic). The crown appears "transparent".
3. Distress cone crop. In the later stages of decline, infected trees may produce an abundant crop of unusually small cones.

Individual disease descriptions:

Laminated root disease

Affects all conifers to varying degrees. the most susceptible species are Douglas-fir, true-fir, and mountain hemlock. Wind thrown trees have decayed roots broken close to root collar, forming root balls. When duff and soil are removed to expose roots, look for grey-white mycelium on surface of roots; these mycelium penetrate only the outermost few millimeters of bark, forming a crusty sheath that cannot be rubbed off easily. In comparison--Armillaria will have white mycelium on the inside of roots, between the bark and wood.

Laminated root rot is most easily identified by examining decayed wood which can be found on root balls or in stump hollows. Decayed wood separates readily along annual tree growth rings, hence the name "laminated" root rot. Yellowish-brown decayed wood is usually dry and contains numerous 1 millimeter-long oval pits. Reddish-brown wiry whiskers can usually be found between layers of decayed wood and are best seen with a 10x magnifying lens. These whiskers are the best diagnostic indicator of laminated root rot.

Armillaria root disease

Affects all conifers and hardwoods. Root balls on fallen trees may occur in disease centers. Heavy resin flow near base of tree is common. Chopping into root collar or root will reveal white, fan-shaped mats of mycelium between wood and bark. The mats have a texture that may remind one of peeling partially-dry latex paint off a glass surface (if one has ever done that). The mycelium can penetrate a few millimeters into the inner bark, but never evident on the outside of the bark or root surfaces. In comparison, laminated root rot has grey-white mycelium on the outside. Decay in root balls and stumps is soft, spongy, yellowish, usually wet, stringy, and often contains numerous black lines. Honey-colored mushrooms may be present at the base of infected trees and stumps. Black thread-like structures (rhizomorphs) may be present in decaying wood or in infected roots.

Black stain root disease

Pines are the primary host in eastern Oregon. Hemlocks and Douglas-fir can also be affected. Infected trees occasionally have resin flow at the base. Brown to black streaks in the sapwood--usually in the last 3 to 4 annual rings--of the root collar and roots are the best indication of the disease. You must chop into the wood to diagnose Black stain; it does not occur in or on the bark or bole of roots. Root balls are not present in Black stain disease centers (unless an other root disease is present) because the fungus does not rot roots--it plugs sapwood tracheids causing trees to die standing. Black stain is most common in young plantations.

Annosus root disease

Most common on true firs, pine, and hemlock. Most difficult to identify of the major root diseases. Look for groups of trees that have not died all at the same time. Bark beetles usually will be present, especially in true fir, ponderosa pine, and sugar pine. Root balls may be present in disease centers, particularly in true fir stands. In true firs, the decayed wood is soft, spongy, white (often with silvery cast) with black flecks (like small wild rice grains scattered through the decay). Small bracket-shaped conks may be present in stump hollows or under the duff near the root collar of infected dead trees or stumps. Annosus is often identified by default--if it is not one of the other root diseases, and if the symptoms suggest root disease and the decay is similar to the description, then it is probably Annosus. In pines, small "button" conks may be present on the root collar beneath the duff. The roots of infected pines are usually resin-soaked.

Listing of disease-tolerant species by root disease:

Root disease

Disease-tolerant species:

Laminated root rot	larch, pines, cedars
Armillaria root disease	larch, lodgepole pine. On a few sites, ponderosa pine may be susceptible. If this is the case, only larch and lodgepole should be considered tolerant.
Annosus root disease	On sites with abundant true fir, lodgepole and ponderosa pines are tolerant. On ponderosa pine sites, larch and Douglas-fir are tolerant.

Insect and disease identification aids

APPENDIX 18 -- TREE VOLUME TABLES

Species..... WESTERN HEMLOCK (*Tsuga heterophylla*)
 Unit of measure..... Board-foot
 Variables..... D.b.h. and total height
 Log rule..... Scribner
 Scaling length for logs. 16 feet
 Stump height..... 2 feet
 Top d.i.b..... 8 inches
 Trim allowance per log. 0.3 feet
 Method..... Alinement chart
 Number of trees..... 1,461
 Location of trees..... Young and old stands in Oregon and Washington
 Accuracy..... Aggregate deviation 0.06 percent low
 Author..... W.H.Meyer, Pacific Northwest Forest and Range Expt. Sta.
 Source..... Table 48 in U. S. Dept. Agr. Tech. Bul. 544
 Year..... 1937
 Note..... Values for odd d.b.h.'s added in 1953

D.b.h. (inches)	Volume in tens of board-feet when total height of tree in feet is--																			
	60	70	80	90	100	110	120	130	140	150	160	170	180	190	200	210	220	230	240	250
12	8	10	12	14	15	17	19	20	22	23	24	26	---	---	---	---	---	---	---	---
13	10	12	15	17	19	21	23	25	27	29	30	33	---	---	---	---	---	---	---	---
14	12	15	18	20	23	25	27	30	32	35	37	40	---	---	---	---	---	---	---	---
15	14	17	21	24	27	30	32	35	38	41	44	47	---	---	---	---	---	---	---	---
16	17	20	24	28	32	35	38	41	44	48	52	55	59	63	67	---	---	---	---	---
17	19	23	28	32	37	40	44	47	51	56	59	63	67	72	77	---	---	---	---	---
18	22	27	32	37	42	46	50	54	58	64	67	71	76	82	88	---	---	---	---	---
19	25	30	36	41	47	52	56	61	65	71	75	79	84	91	97	---	---	---	---	---
20	28	34	40	46	52	58	63	68	73	79	83	87	93	100	107	113	118	---	---	---
21	---	38	44	51	58	64	70	75	81	87	92	97	103	109	116	122	128	---	---	---
22	---	42	49	56	64	71	77	83	90	96	101	107	113	119	125	132	138	---	---	---
23	---	---	54	62	70	77	84	91	98	105	111	117	124	130	137	144	150	---	---	---
24	---	---	60	68	76	84	92	99	107	114	121	128	135	142	150	157	163	---	---	---
25	---	---	---	74	82	91	100	108	116	124	131	139	147	155	165	172	178	---	---	---
26	---	---	---	80	89	98	108	117	125	134	142	150	159	168	180	187	194	---	---	---
27	---	---	---	---	96	106	116	126	135	144	153	162	172	182	194	203	210	---	---	---
28	---	---	---	---	104	114	124	135	145	155	165	175	186	197	209	222	227	---	---	---
29	---	---	---	---	112	122	132	144	155	166	177	188	199	211	224	235	244	---	---	---
30	---	---	---	---	120	130	141	153	165	177	189	201	213	225	239	250	262	---	---	---
31	---	---	---	---	127	138	150	163	175	188	201	209	227	240	254	266	279	---	---	---
32	---	---	---	---	135	147	160	173	186	200	214	218	241	255	270	282	296	310	324	---
33	---	---	---	---	---	155	169	183	198	207	227	237	256	271	286	300	314	329	343	---
34	---	---	---	---	---	163	178	194	210	215	240	256	271	287	303	318	333	348	363	---
35	---	---	---	---	---	---	205	221	232	254	271	287	303	319	335	351	366	382	---	---
36	---	---	---	---	---	---	---	216	233	250	268	286	303	319	336	353	370	385	401	---
37	---	---	---	---	---	---	---	---	246	264	283	301	319	335	354	371	389	405	421	---
38	---	---	---	---	---	---	---	---	259	278	298	316	336	352	372	390	408	425	442	---
39	---	---	---	---	---	---	---	---	271	291	312	331	351	370	389	408	427	444	462	---
40	---	---	---	---	---	---	---	---	283	304	326	347	367	387	407	427	446	464	483	503
41	---	---	---	---	---	---	---	---	296	318	341	363	383	403	426	446	465	484	504	526
42	---	---	---	---	---	---	---	---	310	332	356	379	400	420	445	465	485	505	525	550
43	---	---	---	---	---	---	---	---	323	349	371	394	417	437	462	482	505	527	547	572
44	---	---	---	---	---	---	---	---	337	367	387	410	435	455	480	500	525	550	570	595
45	---	---	---	---	---	---	---	---	350	378	401	425	450	472	497	520	545	570	592	617
46	---	---	---	---	---	---	---	---	363	390	415	440	465	490	515	540	565	590	615	640
47	---	---	---	---	---	---	---	---	376	405	430	457	482	507	535	560	585	612	637	665
48	---	---	---	---	---	---	---	---	390	420	445	475	500	525	550	580	605	635	660	690
49	---	---	---	---	---	---	---	---	402	432	460	490	517	545	575	600	625	655	682	712
50	---	---	---	---	---	---	---	---	415	445	475	505	535	565	595	620	645	675	705	735
51	---	---	---	---	---	---	---	---	---	---	490	522	552	582	612	640	667	697	727	760
52	---	---	---	---	---	---	---	---	---	---	505	540	570	600	630	660	690	720	750	785
53	---	---	---	---	---	---	---	---	---	---	522	557	587	617	650	680	712	742	775	810
54	---	---	---	---	---	---	---	---	---	---	540	575	605	635	670	700	735	765	800	835
55	---	---	---	---	---	---	---	---	---	---	555	590	622	652	690	720	755	787	822	860
56	---	---	---	---	---	---	---	---	---	---	570	605	640	670	710	740	775	810	845	885
57	---	---	---	---	---	---	---	---	---	---	585	622	657	690	730	762	797	832	870	907
58	---	---	---	---	---	---	---	---	---	---	600	640	675	710	750	785	820	855	895	930
59	---	---	---	---	---	---	---	---	---	---	615	655	692	725	767	802	837	875	912	955
60	---	---	---	---	---	---	---	---	---	---	630	670	710	740	785	820	855	895	930	980

Species..... *DOUGLAS-FIR* (*Pseudotsuga menziesii*), young-growth
 Unit of measure..... Board-foot
 Variables..... D.b.h. and total height
 Log rule..... Scribner
 Scaling length for logs. 16 feet
 Stump height..... 2 feet
 Top d.i.b..... 8 inches
 Trim allowance per log. 0.3 feet
 Method..... Board-feet per cubic-foot ratios applied to table 12 in U. S. Dept. Agr. Tech. Bul. 201
 Number of trees..... 1,434
 Location of trees..... Western Oregon and western Washington
 Accuracy..... Aggregate deviation 0.1 percent high
 Author..... R. E. Mcardle, Pacific Northwest Forest and Range Expt. Sta.
 Source..... Table 14 in U. S. Dept. Agr. Tech. Bul. 201
 Year..... 1930

D.b.h. (inches)	Board-foot volume when total height of tree in feet is--																							
	50	60	70	80	90	100	110	120	130	140	150	160	170	180	190	200	210	220	230	240				
12	32	50	69	87	105	124	140	155	176	196	225	254	282	310	338	366	394	422	450	478	506	534	562	590
13	39	61	83	107	130	150	170	190	212	238	270	304	338	372	406	440	474	508	542	576	610	644	678	712
14	47	74	101	129	155	175	201	225	252	282	318	354	390	426	462	498	534	570	606	642	678	714	750	786
15		88	118	148	180	205	233	262	290	324	364	410	466	522	584	640	702	768	834	900	966	1032	1098	1164
16		102	136	170	205	233	266	296	330	368	410	466	522	584	640	702	768	834	900	966	1032	1098	1164	1230
17		115	154	193	230	263	296	331	370	412	460	510	564	624	684	744	804	864	924	984	1044	1104	1164	1224
18		129	174	215	257	294	329	367	410	460	510	564	624	684	744	804	864	924	984	1044	1104	1164	1224	1284
19		143	192	235	283	325	363	403	450	508	564	624	684	744	804	864	924	984	1044	1104	1164	1224	1284	1344
20		158	213	262	311	355	397	440	494	558	624	690	756	822	888	954	1020	1086	1152	1218	1284	1350	1416	1482
21		174	233	287	342	388	438	480	538	606	678	750	822	894	966	1038	1110	1182	1254	1326	1398	1470	1542	1614
22		190	252	309	367	420	470	520	584	658	732	810	888	966	1044	1122	1200	1278	1356	1434	1512	1590	1668	1746
23		207	272	331	397	455	507	562	630	708	788	870	954	1038	1122	1206	1290	1374	1458	1542	1626	1710	1794	1878
24		225	294	356	426	489	545	607	676	758	848	936	1026	1116	1206	1296	1386	1476	1566	1656	1746	1836	1926	2016
25		244	317	383	456	522	584	648	724	810	900	990	1080	1170	1260	1350	1440	1530	1620	1710	1800	1890	1980	2070
26		264	341	411	486	556	624	692	770	864	960	1056	1152	1248	1344	1440	1536	1632	1728	1824	1920	2016	2112	2208
27		285	367	441	522	600	672	748	834	930	1032	1134	1236	1338	1440	1542	1644	1746	1848	1950	2052	2154	2256	2358
28		307	394	472	558	642	720	804	894	996	1104	1212	1320	1428	1536	1644	1752	1860	1968	2076	2184	2292	2400	2508
29		330	420	504	594	684	774	864	960	1068	1182	1296	1410	1524	1638	1752	1866	1980	2094	2208	2322	2436	2550	2664
30		354	448	536	630	726	822	918	1020	1128	1236	1344	1452	1560	1668	1776	1884	1992	2100	2208	2316	2424	2532	2640
31		379	478	570	672	774	876	978	1086	1194	1302	1410	1518	1626	1734	1842	1950	2058	2166	2274	2382	2490	2598	2706
32		405	508	606	714	822	924	1026	1134	1242	1350	1458	1566	1674	1782	1890	1998	2106	2214	2322	2430	2538	2646	2754
33		432	540	642	750	858	966	1074	1182	1290	1404	1512	1620	1728	1836	1944	2052	2160	2268	2376	2484	2592	2700	2808
34		460	572	678	792	906	1020	1134	1248	1362	1476	1590	1704	1818	1932	2046	2160	2274	2388	2502	2616	2730	2844	2958
35		489	606	716	834	954	1074	1194	1314	1434	1554	1674	1794	1914	2034	2154	2274	2394	2514	2634	2754	2874	2994	3114
36		519	642	756	876	996	1116	1236	1356	1476	1596	1716	1836	1956	2076	2196	2316	2436	2556	2676	2796	2916	3036	3156
37		550	678	796	924	1044	1164	1284	1404	1524	1644	1764	1884	2004	2124	2244	2364	2484	2604	2724	2844	2964	3084	3204
38		582	714	828	954	1074	1194	1314	1434	1554	1674	1794	1914	2034	2154	2274	2394	2514	2634	2754	2874	2994	3114	3234
39		615	752	864	990	1116	1236	1356	1476	1596	1716	1836	1956	2076	2196	2316	2436	2556	2676	2796	2916	3036	3156	3276
40		649	792	900	1026	1152	1272	1392	1512	1632	1752	1872	1992	2112	2232	2352	2472	2592	2712	2832	2952	3072	3192	3312
41		684	832	936	1062	1188	1314	1440	1566	1692	1818	1944	2070	2196	2322	2448	2574	2700	2826	2952	3078	3204	3330	3456
42		720	872	972	1104	1230	1356	1482	1608	1734	1860	1986	2112	2238	2364	2490	2616	2742	2868	2994	3120	3246	3372	3498
43		756	912	1008	1140	1266	1392	1518	1644	1770	1896	2022	2148	2274	2400	2526	2652	2778	2904	3030	3156	3282	3408	3534
44		792	954	1044	1184	1310	1436	1562	1688	1814	1940	2066	2192	2318	2444	2570	2696	2822	2948	3074	3200	3326	3452	3578
45		828	996	1080	1224	1350	1476	1602	1728	1854	1980	2106	2232	2358	2484	2610	2736	2862	2988	3114	3240	3366	3492	3618
46		864	1036	1124	1272	1404	1530	1656	1782	1908	2034	2160	2286	2412	2538	2664	2790	2916	3042	3168	3294	3420	3546	3672
47		900	1078	1170	1320	1452	1578	1704	1830	1956	2082	2208	2334	2460	2586	2712	2838	2964	3090	3216	3342	3468	3594	3720
48		936	1118	1212	1368	1500	1626	1752	1878	2004	2130	2256	2382	2508	2634	2760	2886	3012	3138	3264	3390	3516	3642	3768
49		972	1158	1254	1416	1548	1674	1800	1926	2052	2178	2304	2430	2556	2682	2808	2934	3060	3186	3312	3438	3564	3690	3816
50		1008	1198	1296	1464	1602	1728	1854	1980	2106	2232	2358	2484	2610	2736	2862	2988	3114	3240	3366	3492	3618	3744	3870
51		1044	1238	1336	1506	1644	1770	1896	2022	2148	2274	2400	2526	2652	2778	2904	3030	3156	3282	3408	3534	3660	3786	3912
52		1080	1278	1378	1552	1692	1818	1944	2070	2196	2322	2448	2574	2700	2826	2952	3078	3204	3330	3456	3582	3708	3834	3960
53		1116	1318	1418	1596	1736	1862	1988	2114	2240	2366	2492	2618	2744	2870	2996	3122	3248	3374	3500	3626	3752	3878	4004
54		1152	1360	1462	1644	1784	1910	2036	2162	2288	2414	2540	2666	2792	2918	3044	3170	3296	3422	3548	3674	3800	3926	4052

APPENDIX 19 – SAMPLE PLOT FORMS

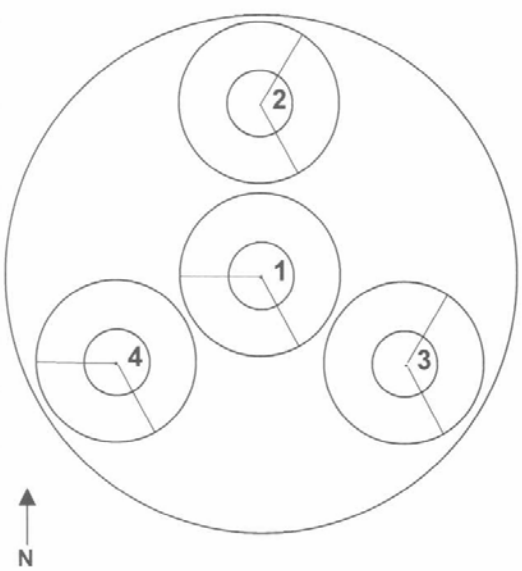
HEX _____ STATE _____ () COUNTY _____ () DATE ____ / ____ / ____ CREW LEADER _____ CREW _____	
<p><u>RP DATA</u></p> Species _____ Diameter _____ in. Azimuth _____ Slope dist. _____ ft. To subplot _____	<p>RP LOCATION AND DESCRIPTION _____</p> _____ _____ _____ _____ _____ _____
<p>PRESENT CONDITION / PAST DISTURBANCE _____</p> _____ _____ _____ _____ _____ _____ _____ _____ _____ _____	
 <p style="text-align: center;">N</p>	<p>LOCATION SKETCH MAP:</p>
<p>ITEMS TO BE FIELD CHECKED _____</p> _____ _____	
<p>IS THE RECORDED OWNER CORRECT? _____</p> _____ _____	

185.1 FT RADIUS CIRCLE
 Total number of dots = 4281
 One dot = 0.02% of 185.1 ft radius circle
 Calculate: % of plot Area = $\frac{\# \text{ of counted dots}}{42.81}$

58.9 FT RADIUS CIRCLE
 Total number of dots = 437
 One dot = 0.23% of 58.9 ft radius circle
 Calculate: % of plot Area = $\frac{\# \text{ of counted dots}}{4.37}$

Dot interval = 5 feet
 Circles = 6.8, 24, 40, 58.9, 185.1 feet

24FT RADIUS CIRCLE
 Total number of dots = 69
 One dot = 1.45% of 24 ft radius circle
 Calculate: % of plot Area = $\frac{\# \text{ of counted dots}}{0.69}$

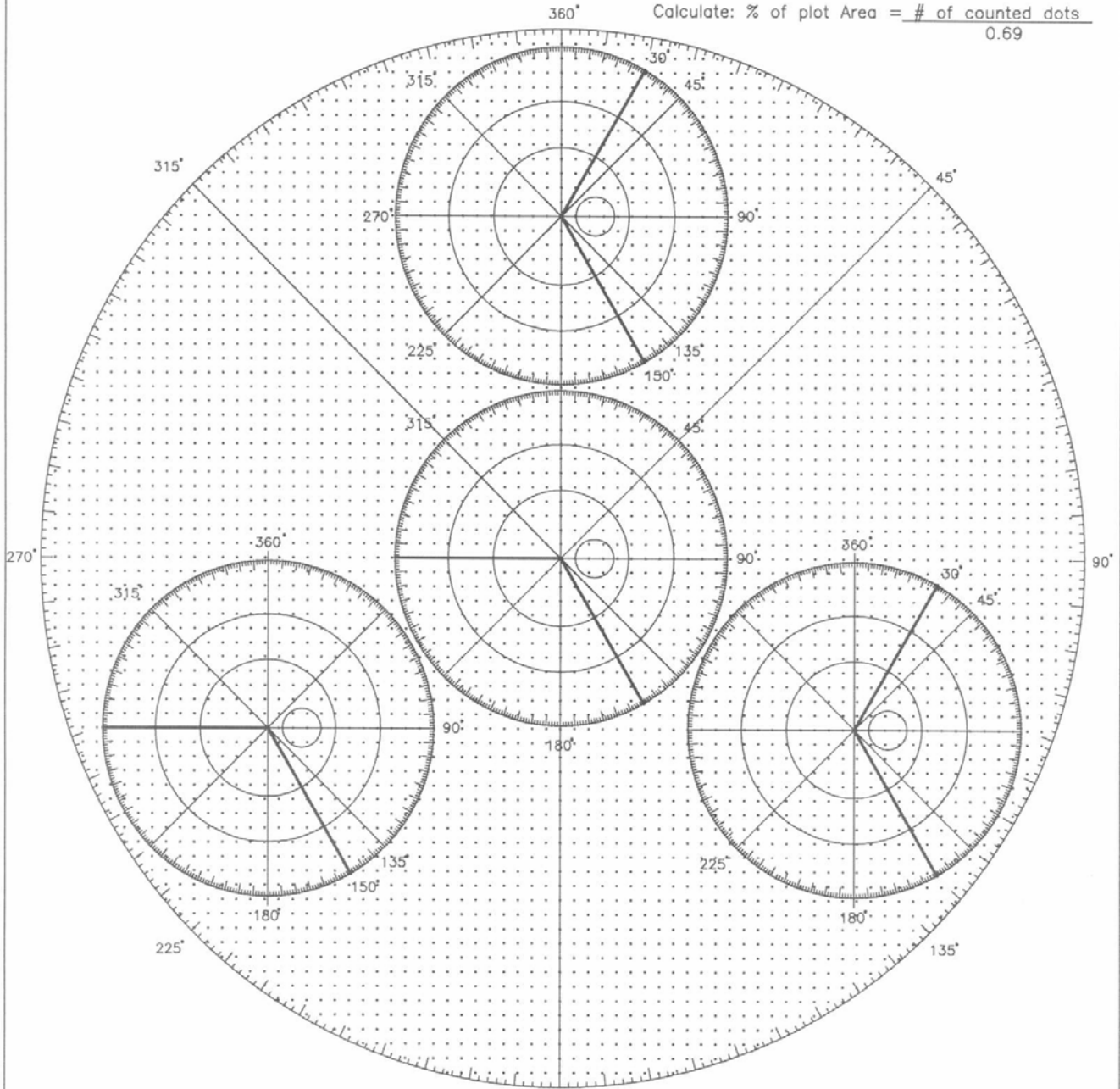

SUBPLOT #	1			2			3			4		
RADIUS	CC	24'	58.9'	CC	24'	58.9'	CC	24'	58.9'	CC	24'	58.9'
NON FOREST INCLUSION MAP												
NON FOREST INCLUSION MAP												
ROOT DISEASE MAP	X			X			X			X		
ROOT DISEASE MAP	X			X			X			X		

Leaf_Updated 1-30-2002

PLOT ATTRIBUTE DATA FORM

HEX # _____

DATE ____/____/____

1	STATE	..
2	COUNTY	...
3	HEX NUMBER
4	NFS PLOT NUMBER
5	OLD PNW-FIA PLOT NUMBER	...
6	PLOT STATUS	.
7	SAMPLE KIND	.
8	CORE FIELD GUIDE VERSION #	
9	PNW DATA RECORDER PROGRAM #	
10	DECLINATION	
11	ELEVATION	
12	PRECIPITATION	
13	HYDROLOGIC UNIT CODE	
14	SPECIAL STUDY 2002A (platform/moss)	.
15	SPECIAL STUDY 2004A (Oregon riparian)	.
16	SPECIAL STUDY 2004b (B & B fire)	
17	HECTARE PLOT?	.
18	CREW TYPE	.
19	QA STATUS	.
20	CREW LEADER	
21	CREW MEMBER	
22	CREW MEMBER	
23	CREW MEMBER	
24	CREW MEMBER	
25	CREW MEMBER	
26	DATE-MONTH	..
27	DATE-DAY	..
28	DATE-YEAR
29	DATE OF PREVIOUS INVENTORY	
30	REMEASUREMENT PERIOD	
31	PREVIOUS GROUND LAND CLASS	..
32	LANDOWNER DATA REQUEST	.
33	OWNER NAME/ADDRESS UPDATE	.
34	TOPOGRAPHIC POSITION	.
35	STRAIGHT LINE DISTANCE TO ROAD	.
36	GPS UNIT TYPE	.
37	GPS UNIT #
38	COORDINATE SYSTEM	2
39	UTM ZONE	...
40	EASTING (X) UTM
41	NORTHING (Y) UTM
42	GPS ELEVATION
43	GPS ERROR	...
44	# OF READINGS	...
45	GPS FILENAME	
46	OFFSET AZIMUTH TO PLOT CENTER	...
47	OFFSET DISTANCE TO PLOT CENTER	...

SUBPLOT ATTRIBUTE DATA FORM

HEX # _____

DATE ____/____/____

1	SUBPLOT #	1	2	3	4
2	SUBPLOT/ANNULAR PLOT STATUS
3	PLOT NONSAMPLED REASON
4	SUBPLOT CENTER CONDITION
5	MICROPLOT CENTER CONDITION
6	ASPECT
7	SLOPE
8	PHYSIOGRAPHIC CLASS
9	WATER ON SUBPLOT
10	WATER PROXIMITY
11	SNOW/WATER DEPTH
---	% NONFOREST INCLUSION
---	% ROOT DISEASE
19	ROOT DISEASE SEVERITY RATING
1	BURN PERCENTAGE
2	MECHANICAL MGT. PERCENTAGE
BOUNDARY #1					
13	PLOT TYPE
14	CONTRASTING CONDITION
15	LEFT AZIMUTH
16	CORNER AZIMUTH
17	CORNER DISTANCE
18	RIGHT AZIMUTH
BOUNDARY #2					
13	PLOT TYPE
14	CONTRASTING CONDITION
15	LEFT AZIMUTH
16	CORNER AZIMUTH
17	CORNER DISTANCE
18	RIGHT AZIMUTH
BOUNDARY #3					
13	PLOT TYPE
14	CONTRASTING CONDITION
15	LEFT AZIMUTH
16	CORNER AZIMUTH
17	CORNER DISTANCE
18	RIGHT AZIMUTH
BOUNDARY #4					
13	PLOT TYPE
14	CONTRASTING CONDITION
15	LEFT AZIMUTH
16	CORNER AZIMUTH
17	CORNER DISTANCE
18	RIGHT AZIMUTH
BOUNDARY #5					
13	PLOT TYPE
14	CONTRASTING CONDITION
15	LEFT AZIMUTH
16	CORNER AZIMUTH
17	CORNER DISTANCE
18	RIGHT AZIMUTH

CONDITION CLASS ATTRIBUTE DATA FORM

HEX # _____

DATE ___/___/___

1	CONDITION CLASS	1	2	3	4	5	6
2	COONDITION CLASS STATUS
3	CONDITION NONSAMPLED REASON
4	RESERVED STATUS
5	OWNER GROUP
6	FOREST TYPE
7	STAND SIZE CLASS
8	REGENERATION STATUS
9	TREE DENSITY
10	GROUND LAND CLASS CURRENT
11	OWNER CLASS
12	PRIVATE OWNER INDUSTRIAL STATUS
13	ARTIFICIAL REGENERATION SPECIES
14	STAND AGE
15	STAND STRUCTURE
16	DISTURBANCE 1
17	DISTURBANCE YEAR 1
18	DISTURBANCE 2
19	DISTURBANCE YEAR 2
20	DISTURBANCE 3
21	DISTURBANCE YEAR 3
22	HISTORICAL DISTURBANCE 1
23	HISTORICAL DISTURBANCE YEAR 1
24	HISTORICAL DISTURBANCE 2
25	HISTORICAL DISTURBANCE YEAR 2
26	HISTORICAL DISTURBANCE 3
27	HISTORICAL DISTURBNACE YEAR 3
28	TREATMENT 1
29	TREATMENT YEAR 1
30	TREATMENT 2
31	TREATMENT YEAR 2
32	TREATMENT 3
33	TREATMENT YEAR 3
34	HISTORICAL TREATMENT 1
35	HISTORICAL TREATMENT YEAR 1
36	HISTORICAL TREATMENT 2
37	HISTORICAL TREATMENT YEAR 2
38	HISTORICAL TREATMENT 3
39	HISTORICAL TREATMENT YEAR 3
40	STUMPS PRESENT
41	FIRE EVIDENCE
42	CC PHYSIOGRAPHIC CLASS
43	SOIL DEPTH
44	STAND CONDITION
45	PLANT ASSOCIATION
46	MIXED CONIFER SITE? (CA ONLY)
47	STOCKABILITY INDICATOR SET
48	PRESENT NONFOREST LAND USE

FINE WOODY MATERIALS ASSESSMENT DATA FORM

HEX # _____

DATE ___/___/___

MICROPLOT FUEL LOADING

SUBPLOT	LIVE SHRUB %	LIVE SHRUB HT (0.1 ft)	DEAD SHRUB %	DEAD SHRUB HT (0.1 ft)	LIVE HERB %	LIVE HERB HT (0.1 ft)	DEAD HERB %	DEAD HERB HT (0.1 ft)	LITTER %
	xx	xx.y	xx	xx.y	xx	xx.y	xx	xx.y	xx
1									
2									
2									
4									

DUFF, LITTER, & FUELBED DEPTHS

SUBPLOT	TRANSECT	DL_SAMP	DUFFLITTER DEPTH (0.1 in)	LITTER DEPTH (0.1 in)	FUELBED DEPTH (0.1 in)
X	XXX	X	xx.Y	xx.Y	xx.Y

FINE WOODY DEBRIS COUNT

SUBPLOT	CONDITION CLASS	SMALL FWD 0.1" TO 0.25"	MED FWD 0.25" TO 1"	LARGE FWD 1" TO 3"	REASON FOR HIGH COUNT	RESIDUE PILE ON TRANSECT?
X	X	xxx	xxx	xxx	X	X

APPENDIX 20 -- INDEX

- 5.0m fixed radius plot
 - % Veg profile in area, 118
- active logging, 9
- additional sources of documentation, 245
- age
 - breast height age, 165
 - on large trees, 166
- agents, 175
- armillaria root rot, 325
- bark beetles, 326
- baseline, 8
- black stain root rot, 326
- clump, 174
- coarse woody debris-CWD
 - length, 199
 - line transects, 190
 - piles, residue, 209
 - tagging and marking, 196
- condition class
 - attributes, 63
 - determining, 65
- Condition class status, 65
- cull other, 171
- cull rot, 172
- damaging agent, 175
- DBH
 - large end-CWD, 199
 - marking DBH, 159
 - point of intersection-CWD, 199
 - small end-CWD, 199
- decay class
 - snags, 180
- double sample, 241
- DRC
 - marking DRC, 159
- elevation, 27
- extrapolated age, 166
- fixed-radius plot, 149
- Forked trees
 - SUBPLOT TREES, 159
- form class, 174
- GPS, 219, 221
 - batteries, 227
- GPS Unit, 222
- ground land class
 - previous, 30
- hardwood clump, 174
- hardwood tree form, 174
- height
 - on leaning trees, 167
- increment, 164, 165
- inventory design, 241
- laminated root rot, 325
- landowner contact, 7
- locating the plot*, 7
- location description, 17
- logs, volume
 - merchantability minimums, 171
 - tree volume charts, 171
- lost plot, 15
- mapping
 - non-forest inclusions, 49
- merchantability minimums, 171
- mistletoe, 170
- moved subplot
 - definition, 242
- non-forest inclusion
 - estimate and record %'s, 51
- non-forest inclusions, 49
- Orange Tags, 240
- permission, 7
- plot layout, 11
 - at OC5, 13
- plot layout Oc3, 241
- POD, 8
- Point of Reference, 17
- present condition/past disturbance
 - site trees, 100
- present conditon/past disturbance
 - site trees, 100
- referencing a plot
 - not visited previously, 15
 - visited previously, 14
- residue piles, 209
- root disease inclusion
 - estimate and record %'s, 54
- RP, 16
 - azimuth, 16
- Sample Unit Establishment, 237
- seedling count, 55
- severity, 175
- site index, 106
- site trees
 - on previously visited plots, 100
 - preferred species, 101
 - selecting, 99
- snag
 - decay class, 180
- soil depth, 88
- species
 - CWD, 197
 - veg, 116
- stage of development, 121
- Stake Position Installation, 238
- Stake Position Reference (SPR), 239
- stand density index "SDI", 99
- stem decays
 - cull rot, 172
- stream
 - proximity, 45
- Subplot Layout, 240
- substituted subplot
 - definition, 242
- suppression, 178

Annual Inventory 2004

APPENDICES

topographic position, 32

tree number, 158

 Previous, 158

tree selection rules, 149

tree tally

 data recording, 155

 seedling selection rules, 150

 tree and snag selection, 149

unknown plants, 122

veg profile

 percent cover, 118

 unknown plants, 122

volume deductions

 cull other, 171

 cull rot, 172

witness trees, 18

APPENDIX 21 -- IMPORTANT PHONE NUMBERS

	Office ext.	Home
PFSL front desk - AST	503 808-2000	fax 503 808-2020
Perry Colclasure - Data Manager	503 808-2054	503 335-3857
Chuck Veneklas - Programming & Husky guru	503 808-2045	503 281-7892
Sue Willits - Program Manager	503 808-2066	503 698-2601
Dale Weyermann - GIS	503 808-2042	503 232-0313
Bruce Hiserote - computer equipment	503 808-2056	
Sue Ferneau - IBM, network 808-2030 local pager	503 938-0036	pager 800 473-6519
Jimmy Ward - computer support 808-2039 local pager	503 229-9829	pager 800 844-3596
Tammy Verhunc - AO / Accident Reporting	503 808-2032	503 223-1625
Margie Sauser - Per Diem	503 808-2029	
Cheryl Holt - Purchasing	503 808-2011	
Bob Rhoads – FIA Data Collection Team Leader	503 808-2022	
Sarah Butler – FIA Pacific Islands Field Coordinator	503 808-2083	503 231-5629
Walter Grabowiecki – FIA	503 808-2023	503 789-8296
Paul Guarnaccia – FIA CA Field Coordinator	503 808-2098	503-297-2662
Brian Daum – FIA CA Asst Coord	503 808-2027	
Robert Poindexter – FIA CA Asst Coord	503-808-2014	
Sam Solano – FIA	503 808-2050	
Melissa Patterson FIA	503-808-2087	
Scott Rash – FIA	503-808-2081	
Voice mail: messages on your phone to call someone in the office	800 327-4706 ext #, password #, get into mailbox (above) then: 0*, ext#	
Lotus notes mail	entra6a.fs.fed.us/webmail.nsf	
Cell Phone Unlock code: 4801		
R6/PNW		
Personnel - Patti Magallanez	360 891-5231	360 891-5235
Shirley Cromwell	360 891-5239	360 891-5235
Accident Reporting	503 891-5239	
Publications - Diane Smith	503 808-2138	
FS Law Enforcement & Investigate 24hr/day, 365/yr	800 370-8732	
Special Agent in Charge R6 Tom Lyons	503 808-2681	
North Zone	503 808-2686	
South Zone	503 808-2687	
Fleet Manager, Mt.Hood NF - John Gilmore	503 668-1774	
GSA Vancouver, WA : Rick DeMorgan	360 573-3424	fax 360 573-3716
**Maintenance Center (All GSA repairs/service)	888 622-6344	
Oregon Department of Forestry		
Alan Kanaskie - Pathologist	503 945-7397	
Dave Overhulser - Entomologist	503 945-7396	
USGS (NAPP photos) EROS Data Center, Customer Service		605 597-6151
WAC Corp. (WAC photos) Eugene, OR		800 845-8088
BLM Districts		
Baker Resource Area	541 523-1256	
Burns District Office	541 573-4400	
Klamath Falls Resource Area	541 883-6916	
Lakeview District Office	541 947-2177	
Prineville District Office	541 416-6700	
Vale District Office	541 473-3144	
California Department of Forestry and Fire Protection		
Jessie Rios - Pathologists	916-	
Forest Health Protection, R5		
John Pronos		
John Dale		

APPENDIX 22-- SUMMARY OF MANUAL CHANGES FROM 2003

INTRODUCTION

- No significant changes

LOCATING THE PLOT

- Changed chapter heading from "Travel Planning and Locating the Plot" to "Locating the Plot"
- Removed much of the text referring to travel, safety, and planning

PLOT LAYOUT AND REFERENCING

- Changed language referring to the cedar stake to account for different units' use of plastic stakes (including Alaska)
- Changed language referring to subplot "reference trees," they will now be called "witness trees"
- Changed monumenting instructions for subplot 1 witness trees
- Added referencing instructions for nonforest plots

PLOT ATTRIBUTES

- Added new item PLOT STATUS
- Clarified definitions of SAMPLE KIND codes
- Deleted item TRAILS OR ROADS
- Deleted item ROAD ACCESS
- Deleted item PUBLIC USE RESTRICTIONS
- Deleted item RECREATION USE 1, 2, AND 3
- Clarified definitions of GPS UNIT TYPE codes 3 and 4
- Added GPS FILENAME to be used by R5 contract crews
- Added instructions for converting collection time on Magellan GPS units to NUMBER OF READINGS
- Added Idaho FIPS codes
- Added Idaho and Nevada counties and declinations
- Updated all declinations
- NFS Plot Number will be recorded on all R5 plots (on and off grid)
- Owner Name/Address update should be recorded if owner information is blank.
- Removed Special Studies 2003a, 2003b, 2003c, 2003d
- Added Special Study 2004a Oregon Riparian
- Added Special Study 2004b B&B Fire
- Record Crew Leader in addition to 5 Crew Members

SUBPLOT ATTRIBUTES

- Added new item SUBPLOT/ANNULAR PLOT STATUS
- Added new item SUBPLOT NONSAMPLED REASON
- SEEDLING COUNT now requires counts above 5, changed tolerances for counts above 5
- Mortality Assessment will be done for plots in WA that were sampled in 2000 western Washington and 2001 eastern Washington
- Record Mechanical Management (R5 NFS chaparral) since last inventory or within the last 5 years on new plots
- Do not map the hectare boundary on SNFP plots
- Added Special Study 2004a Oregon Riparian data items

CONDITION CLASS ATTRIBUTES

- Deleted CONDITION CLASS STATUS codes 6 and 7, and changed definition of code 5 to "nonsampled"
 - Added new item CONDITION NONSAMPLED REASON
 - Added explanation for determining FOREST TYPE when stand size is nonstocked
-

- Changed instructions for determining STAND SIZE CLASS based on crown cover
- Deleted instructions delineating STAND SIZE CLASS based on size combinations
- Deleted phrase that states STAND SIZE CLASS is based on trees “that are not overtopped”
- Changed instructions for determining DISTURBANCE “significant threshold”
- Added new DISTURBANCE codes
- Clarified some TREATMENT codes
- Plant association is now collected on R6 nonforest condition classes

SITE INDEX

- Added and rearranged text to clarify site trees selection methods

VEGETATION PROFILE

- Percent total vegetation cover is recorded regardless of condition class boundaries
- Added 30 species to SW Washington indicator list
- Trees species can be grouped by lifeform

TRACKABLE TREE AND SNAG SELECTION

- Hectare trees will not be recorded within the SNFP

TRACKABLE TREE AND SNAG DATA

- Changed “TREE STATUS” to “PRESENT TREE STATUS”
- Removed code 4 (“missing”, remeasurement plot only) from PRESENT TREE STATUS
- Changed PRESENT TREE STATUS code “0” No Live tally to “N” No Live Tally to eliminate conflict with code “0” No Status which will be used on remeasurement plots
- Deleted Item LEAN ANGLE
- Increased SPECIES field width to 4 digits (throughout manual)
- Added “Tree with curved bole” to DBH instructions
- Added text that changes definition of ROUGH CULL; now record cull for tree form as well as sound dead wood
- No longer record codes 0, 1, 2, and 3 for ROTTEN CULL; changed to 0, 25, 50 and 99
- Incense cedar added as host species for agent 58 broom rust

DOWN WOODY MATERIALS

- “Debris and Fuels” are now referred to as “Materials”
- Added information on marking the transect
- Changed acceptable SLOPE PERCENT values to 0 to 155
- Removed instructions for tallying CWD across multiple condition classes (diagrams remain)
- HOLLOW changed from a Y/N field to a 0/1 field
- Removed FWD, CWD, DUFF, LITTER AND FUELBED, and RESIDUE PILE tally guide tables
- FWD tolerances are now per transect, where they previously applied to the entire plot
- RESIDUE PILE ON TRANSECT changed from a Y/N field to a 0/1 field
- Added information on distinguishing duff from litter and from soil
- DUFF, LITTER, AND FUELBED SAMPLE codes changed from Y/N to 0/1 and 2
- Segmenting item HORIZONTAL DISTANCE removed (will remain in the data recorder)
- Mark the location where depth measurements are taken with flagging
- Removed special study 2003a and 2003b from Percent Log Charred by Fire

- and added 2004b
- Horizontal Distance to Pile will be collected for residue piles on co-located P2/P3 plots

GROUND COVER

- No changes

COORDINATES (GPS)

- Inserted instructions for Magellan Gold units

LASER 200 INSTRUCTIONS

- No changes

APPENDIX 1 -- R6 NATIONAL FOREST PLOTS

- Plant association will be collected on R6 NFS Nonforest condition classes

APPENDIX 2 – R6 OFF NATIONAL FOREST PLOTS

- Previously established Juniper inventory plots will be established in the field in 2004
- Removed list of established Juniper plots

APPENDIX 3 – R5 NATIONAL FOREST PLOTS

- Clarified that hectare plots will be established on BLM plots in the Northwest Forest Plan area

APPENDIX 6 – DETERMINATION OF STOCKING VALUES

- Updated entire chapter, procedures differ significantly from 2003

APPENDIX 8 – FOREST TYPE CODES

- Added new codes

APPENDIX 12 – INTERIM LOCATION CONFIDENTIALITY PLOICY

- Added Confidentiality Certification document regarding plot locations, data storage, and use

APPENDIX 15 – GLOSSARY

- National CORE glossary still under revision

APPENDIX 19 – SAMPLE PLOT FORMS

- Updated sample plot forms

APPENDIX 21 – IMPORTANT PHONE NUMBERS

- Updated phone numbers

APPENDIX 23 -- BLANK PAGE FOR NOTES

BLANK PAGE FOR NOTES

BLANK PAGE FOR NOTES