

PUBLIC WORKS TECHNICAL BULLETIN 200-1-62
1 OCTOBER 2008

**LOW IMPACT DEVELOPMENT FOR
SUSTAINABLE INSTALLATIONS:
STORMWATER DESIGN AND PLANNING
GUIDANCE FOR DEVELOPMENT WITHIN
ARMY TRAINING AREAS**

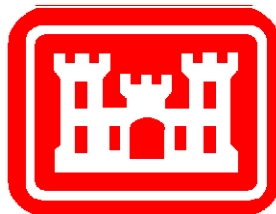

Public Works Technical Bulletins are published by the U.S. Army Corps of Engineers, 441 G Street NW, Washington, DC 20314-1000. They are intended to provide information on specific topics in areas of Facilities Engineering and Public Works. They are not intended to establish new DA policy.

DEPARTMENT OF THE ARMY
U.S. Army Corps of Engineers
441 G Street, NW
Washington, DC 20314-1000

CEMP-CE

Public Works Technical Bulletin
No. 200-1-62

1 October 2008

Facilities Engineering
Environmental

LOW IMPACT DEVELOPMENT FOR SUSTAINABLE
INSTALLATIONS: STORMWATER DESIGN AND
PLANNING GUIDANCE FOR DEVELOPMENT WITHIN
ARMY TRAINING AREAS

1. Purpose.

a. This Public Works Technical Bulletin (PWTB) provides information on techniques and technologies that can be applied in Army training area development and addresses stormwater management and nonpoint source (NPS) pollution control through small, cost-effective landscape features known as Integrated Management Practices (IMPs). The goal of Low Impact Development (LID) is to mimic a site's predevelopment hydrology by using design techniques that infiltrate, filter, store, evaporate, and detain runoff close to the source. The scope includes soil and water conservation, NPS pollution reduction/removal, and enhanced environmental aesthetics.

b. All PWTBs are available electronically (in Adobe® Acrobat® portable document format [PDF]) through the World Wide Web (WWW) at the National Institute of Building Sciences' Whole Building Design Guide web page, which is accessible through URL:

http://www.wbdg.org/ccb/browse_cat.php?o=31&c=215

2. Applicability. This PWTB applies to all U.S. Army facilities engineering activities.

3. References.

a. Army Regulation (AR) 200-1, "Environmental Protection and Enhancement," 28 August 2007.

b. AR 200-3, "Natural Resources - Land, Forest, and Wildlife Management," 20 March 2000.

c. Department of the Army, Commander's Guide: Army Installations Standards. 1 October 2002.

d. Department of the Navy (DON), "Low Impact Development (LID) Policy," 16 November 2007.

e. Clean Water Act of 1972 and Amendments of 1987: National Pollution Discharge Elimination System (NPDES) Phase II Stormwater Management Program.

f. Energy Independence and Security Act of 2007, Section 438, Storm Water Runoff Requirements for Federal Development Projects.

g. Executive Order 13423, "Strengthening Federal Environmental, Energy, and Transportation Management," 24 January 2007.

4. Discussion.

a. "*Sustain the Mission - Secure the Future*" is the Army's stated policy for the protection and enhancement of the environment. Several Army regulations, Executive Orders, national legislation (National Environment Policy Act, Clean Water Act), and State and local ordinances have established policies and procedures to scientifically manage and systematically restore and protect both land and water natural resources for future land use sustainability. The U.S. Environmental Protection Agency (USEPA) recognizes that "NPS pollution, also known as polluted runoff, is the largest cause of water pollution in the United States" and the USEPA is "considering mandatory treatment and control of storm water" (DON 2007). Recognizing increases in volume and flow of stormwater as well as sediment and nutrient loadings to streams, wetlands, and receiving waters, the DON 2007 policy has established a "goal of no net increase in storm water volume and sediment and nutrient loading from major renovation and construction projects ... and this policy directs that LID be considered in the design for all projects that have a storm water element." However, the use of LID practices at Army

facilities is relatively insignificant and, on range and training area development, entirely non-existent.

b. LID is a relatively new concept in stormwater management. This technique seeks to control NPS pollutants "nature's way" through application of plant-soil-water mechanisms that maintain and protect the ecological and biological integrity of receiving waters and wetlands. The use of LID at military facilities and training lands is relatively new and not widespread. Except for a few retrofit demonstration projects on some installations such as Forts Lee, Stewart, and Bragg (described in Appendix A), no LID work based on sound science, especially in the design and development of ranges and training area development, has been undertaken on Army installations. More long-term data and analyses are required to more accurately assess the cost and control effectiveness of LID to scientifically manage and systematically restore and protect the environment and land's natural soil and water resources.

c. Appendix A provides information as to how to use the information provided in this PWTB. The Appendix provides useful information in several areas such as:

- i. the concept of LID technology;
- ii. LID techniques, tools, standard practices and procedures;
- iii. its applications in the development of Army ranges and training area development;
- iv. LID applications and practices that can be used to earn Leadership in Energy and Environmental Design® (LEED®) credits;
- v. NPS pollution prevention;
- vi. soil and water conservation; and the protection and enhancement of environment.

d. Appendix B contains a compilation of 22 Activity and Technology Fact Sheets that can be used in the design and construction of ranges and training area developments. Applicable references for each Activity/Technology Fact Sheet are also provided in the footnotes.

e. Appendix C contains a glossary of extended key LID terms.

f. Appendix D provides a comprehensive list of LID-relevant publications, books, and references.

g. Appendix E contains a "Climate - Lid Technology Compatibility" chart.

PWTB 200-1-62
1 October 2008

h. Appendix F contains some representative "LID Site Plan Examples at Army Installations."

i. Appendix G reproduces the Minimum Requirements section of the Headquarters, U.S. Army Corps of Engineers (HQUSACE) Army LEED® Implementation Guide.

j. Appendix H summarizes the possible LEED® credits for which typical training area projects may qualify.

5. Points of Contact (POCs). HQUSACE is the proponent for this document. The POC at HQUSACE is Malcolm E. McLeod, CEMP-II, 202-761-0632, or e-mail: Malcolm.E.Mcleod@hq02.usace.army.mil.

Questions and/or comments regarding this subject should be directed to the technical POC:

U.S. Army Engineer Research and Development Center
Construction Engineering Research Laboratory
ATTN: CEERD-CN-N (Harold Balbach)
2902 Newmark Drive
Champaign, IL 61822-1072
Tel. (217) 373-6785
FAX: (217) 373-7266
e-mail: hal.e.balbach@usace.army.mil

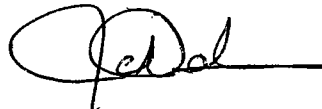

JAMES C. DALTON, P.E
Chief, Engineering and Construction
Directorate of Civil Works

APPENDIX A: Introduction

This technical bulletin has been developed to address the need for a set of Standing Operating Procedures (SOPs) for Stormwater Management on a variety of military range sites. The intent of this PWTB is to provide appropriate guidance for the planning and application of Low Impact Development (LID) technologies and practices in the setting of the Military Range and Training Area Development. The techniques of LID are innovative, site design strategies and practices that work with the biological and physical systems of a site to achieve water and conservation goals. Small scale, close-to-the-source controls provide the means to meet the environmental standards for stormwater management under the auspices of National Pollution Discharge Elimination System (NPDES), Phase II of the Clean Water Act (CWA), and the Sustainable Ranges mission of the Department of Defense (DoD) and the Army.

The LID practices and procedures offer an innovative stormwater management approach for application on military ranges and training and testing lands (Figure A-1). Research has shown that a decentralized LID approach to stormwater management offers superior alternatives compared to conventional stormwater management controls. Lowered costs and multiple environmental benefits are two other strong incentives for the DoD and the Army to integrate LID SOPs on military lands. This document focuses largely on non-urban facilities, including those in areas not connected to the permanent stormwater system.



Figure A-1. Negative impacts of military training on land and environment.

This document is to be a practical field guide to LID Technologies and Practices for Army installations and to provide field personnel with operational information to mitigate the negative environmental impacts of training activities. This PWTB is a field guide to practices that will address both NPDES and a wide range of Natural Resource regulatory issues.

How To Use This Guidance

This PWTB is organized into several major appendices. The first section, Appendix A, contains an overview of LID, its applicability to military installations, and lessons learned from implementation of LID applications and technologies at Army, DoD, and non-DoD facilities. The second section, Appendix B, contains a series of fact and technology sheets designed to be used in the field. The series of fact sheets pertain to military range and other training facility activities and their typical environmental impacts. The fact sheets are to be used by field personnel to assist in the selection of appropriate LID technologies for their activity area. The companion series of LID technology fact sheets has been developed for each of the recommended LID practices for each of the activities. LID practices and technologies are to be selected based on appropriateness to a situation and availability of materials locally. The third section, Appendix C, contains a glossary of LID terms used in this manuscript. Appendix D contains the reference list of sources and publications. Appendix E provides some typical LID construction design specifications and climate adaptation factors. Appendices F and G provide useful information on LID and LEED® relationships and how LID practices can qualify for LEED® credits.

Nine Activity Fact Sheets pertaining to nine different military range and training area development activities have been developed. Fact Sheets are available for Assembly Areas, Bivouac Sites, Drop Zones, Maneuver Corridors, Multi-Purpose Range Complexes, Secondary Roads, Small Weapons Firing Ranges, Tank Trails, and Tracked Vehicle Driver Training Sites. Each fact sheet summarizes the types of site disturbance activities that occur on those sites. Fact sheets identify the site issues that typically occur, pertaining to the environment in general and stormwater in particular, at each type of activity area. Each Activity Fact Sheet includes a list of appropriate LID tools suggested to be used to mitigate the possible negative impacts of military activity on surface and groundwater quality. This range of activities was selected as a representative of training

area development facilities, and the information may be extended to many other types of projects not specifically named, since the principles are widely adaptable across most developments.

Improved parking areas are also treated as a project type, since many of the training area developments proposed will incorporate parking for privately owned vehicles and/or unit vehicles. Since all such development facilities, especially intense-use sites, result in greatly increased stormwater runoff whether the area is paved or not, they deserve special attention even if the project does not carry the title "parking lot."

Urban Operations (UO), also known as Military Operations on Urban Terrain, training facilities are also deserving of application of LID principles. While the building types are unusual and not related to normal Military Construction (MILCON) types, the site development principles within LID are completely applicable. A project type for UO is thus also included in the project table.

A series of 13 Technology Fact Sheets has been developed as a companion to the Activity Fact Sheets. Thirteen LID technologies are detailed so that, with the information given, a project planner could specify the appropriate LID tools. Technology Fact Sheets are available for Bioretention Cells or Rain Gardens, Bioswales, Compost Amendments, Downspout Disconnection/Rain Barrels, Filter Mats, Grassy Swales, Permeable Pavements, Pollution Prevention (P2), Reforestation, Selective Grading, Site Fingerprinting, and Vegetated Swales. Again, the principles of LID may be adapted to numerous settings not specifically named.

The Activity and Technology Fact Sheets are intended to inform planning and design staff so that they may proceed with construction of LID devices in the field. LID Technology Fact Sheets contain a summary of how the technology works, the materials required, tools needed, and environmental benefits of each practice in action. They also include a construction sequence that includes permitting and a list of tools and materials necessary for successful installation. Some LID practices are more appropriate to certain climates than others. Appendix C summarizes the applicability of LID for each climatic area.

Introduction to Low Impact Development

LID is an ecosystem watershed-based approach to site design and development that was initiated in Prince George's County,

Maryland. It was pioneered as a response to the need to solve a variety of water quality problems that were evident in the increasingly urbanized and built environment around Washington, DC. LID tools emphasize source controls and are decentralized in application. The approach of LID is to work with natural systems to achieve environmental improvement. Figure A-2 shows key elements of a typical LID system.

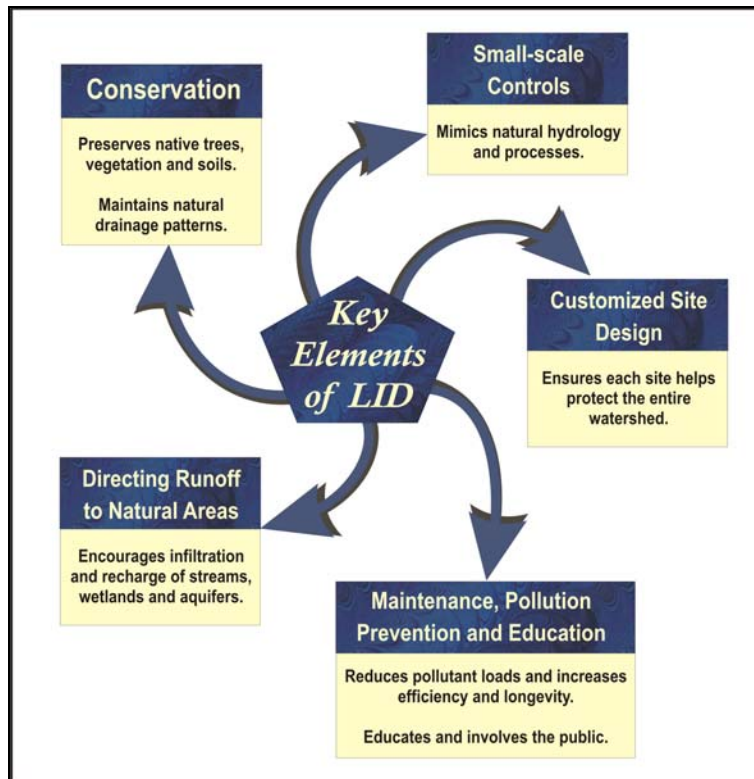

Figure A-2. Key elements of a typical LID system.

The tools used in LID are particularly well suited for the removal of nonpoint source (NPS) pollutants such as sediments (total suspended solids [TSS]), Nitrogen, Phosphorus, and heavy metals such as lead, zinc, and copper. LID practices at the planning level are in conformance with USEPA nonstructural P2 strategies (USEPA 2002). LID technologies are integrated into the environment, and the LID design supports sustainable planning and design initiatives by mimicking natural systems in both installation and design of the source controls for stormwater management.

Use of LID at Army installations represents an environmentally sustainable approach to land and stormwater management that has multiple benefits including lower lifecycle costs. Further, use

of LID technologies meets the mandate of Federal agencies to be the leaders in implementing environmentally sound technologies. Executive Order 13423 stipulated that all Federal land holding agencies are to be environmental leaders on all Federal lands. The DoD is operating to meet that mandate, even as that mandate presents some unique challenges due to the nature of the military's scope of activities, scale of operations, and distribution of lands (UIUC 2007).

The U.S. Army Corps of Engineers (USACE) Army LEED® Implementation Guide (Draft) of 17 December 2007 states the requirement relating to training area facilities, including parking areas, in the following terms:

Section 3.C.(1) HORIZONTAL CONSTRUCTION. Horizontal construction projects, such as ranges, roads and airfields, will be evaluated using LEED-NC® and incorporate sustainable design features to the maximum extent possible, but will be exempt from the minimum score that applies to new construction. Climate-controlled buildings included in horizontal construction projects are not included in this exemption and shall achieve the minimum LEED-NC® rating.

Appendix F includes the full set of minimum LEED® requirements for new construction.

The military has a stated conservation goal to promote compatible multiple uses of resources. This goal is articulated by the National Defense Center for Environmental Excellence (NDCEE) and may be met by the use of LID technologies. The DoD's conservation program is designed to meet the challenge of the need to balance the military mission objectives in the use of air, land, and water resources with the need to manage these same resources for long-term sustainability (Figure A-3) (OSD 1996).



Figure A-3. LID strives to strike a balance between environmental conservation and military mission.

The goal of the Army in following a sustainable mission is summed up in the Commander's Guide: Army Installation Standards (HQDA 2002). Thirteen key installation standards are identified as concepts to be implemented to achieve a higher standard of quality at Army Installations. LID practices fit into most, if not all, of the installation standards as LID Integrated Management Practices (IMPs) are designed to be flexible and adaptable to a variety of needs. At an entry, for example, a need may exist to address stormwater issues. These issues could be solved by a bioretention design that would provide a sense of arrival, of orientation, of order, of completeness, and a simplicity in design, sustainability, energy conservation, and environmental stewardship. With careful design application such as repeating the design motif, bioretention could both meet installation standards for creating a sense of community and create a visually cohesive installation facility.

How LID Works

LID is a site-specific approach to development planning and design. In practice, the local pre-development hydrologic regime is determined. The LID technologies and tools are then chosen to facilitate the process of retaining predevelopment hydrology even as development occurs. LID retrofits to an area may be used to augment and either replace or supplement existing conventional stormwater management approaches such as centralized end-of-pipe controls. The LID approach is to use a range of source control tools that treat and reduce water volume as appropriate to the situation. The tools of LID are characterized by their straightforward constructability, lowered

cost over the infrastructure lifecycle, and multiple environmental benefits beyond stormwater management such as habitat creation, aesthetic enhancement, and air quality benefits.

The hydrologic goal of LID is to develop a stormwater treatment solution so that the project's post-construction time of concentration (T_c) is either the same or nearly the same as the pre-construction T_c . The three main goals of LID are:

1. Reduction of peak flow volume and velocity,
2. Removal and/or reduction of NPS pollution, and
3. Adequate on-site ground water recharge.

These goals are achieved through application of a wide array of techniques and tools. LID practices are a flexible approach to site design with specific solutions tailored to the site. While normally thought to be useful primarily in highly developed, urbanized settings, it is believed that projects sited in many remote areas on Army installations may benefit significantly from application of LID principles. In many cases, zero discharge of stormwater may be achievable.

LID tools are typically easy to construct close to the source, small-scale controls. LID is a decentralized approach to stormwater treatment. Surface runoff is managed close to the source (Figure A-4) when volumes and velocities are smaller and slower than farther downstream where they are larger and faster.

In many cases, especially projects such as drop zones that cover large areas, the appropriate LID features may make close-to-zero discharge achievable (Figure A-5). LID tools, when used comprehensively, promote water storage, infiltration, on-site water harvesting, and water quality improvements all through the watershed. The net effect of a number of LID tools in the same watershed improves the whole watershed, regardless of the order of implementation.

LID tools are particularly well suited to achieving reductions in Nitrates, Phosphorus, and TSS. LID tools may be combined in ways that enhance their overall impact, such as using turf as a pretreatment area for a bioretention facility.

Table A-1 lists LID practices and indicates the areas to which the practices and tools are best applied. LID tools are not used



Figure A-4. Stormwater runoff is controlled close to the source by LID tools that promote water storage, infiltration, on-site water harvesting, and improved water quality.



Figure A-5. Salerno Drop Zone, Fort Bragg, NC: Almost zero discharge is obtained by installing vegetated earth terraces that help retain, infiltrate, and store on-site storm runoff over large areas.

to address hazardous waste or other extreme environmental toxicity problems. LID practices and tools are directed at the majority of places where reductions in peak flow and overall runoff volume, improvement in water quality, and achievement of water conservation goals are paramount. These goals especially describe many, if not most, of the numerous projects experienced in the changes to Army installation infrastructure as mandated to meet Base Realignment and Closure (BRAC) requirements.

Table A-1: LID practices and benefits.

LID Practice / Device	Peak Flow Control	Volume Reduction	Water Quality Improvement	Water Conservation
Bio-retention Cell	•	•	•	
Cistern	•	•		•
Curbless Parking Lot Islands	•	•	•	
Downspout Disconnection	•	•	•	
Grassed Swale	•	•	•	
Green Roof	•		•	
Infiltration Trench	•	•	•	
Narrow Road Design	•	•	•	
Permeable Pavers/Pavement	•	•	•	
Rain Barrel	•	•		•
Rain Garden	•	•	•	
Sand Filter	•		•	
Tree Box Filter	•		•	
Tree Planting	•	•		

Source: WBDG Design Guide: Low Impact Technologies
<http://www.wbdg.org/design/lidtech.php>

LID and the Clean Water Act (CWA)

Regulatory Issues

The LID approach dovetails with the stormwater requirements of the CWA NPDES Phase II. The CWA sets standards for stormwater management, many of which may be met by the use of LID tools and practices. The issues pertaining to stormwater management fall under the authority of the USEPA and the permitting structure for construction and other practices that impact the quality and quantity of water flowing into groundwater, creeks and streams, and bodies of water that comprise the waters of the United States. USEPA maintains the national standards for stormwater permitting. Most states have been authorized by the USEPA, as agents for that agency, to issue Stormwater NPDES and may impose more stringent standards for permits (USEPA 2007a). It is in the reduction and potential elimination of stormwater discharge that LID may be most valuable to the Army.

Guidance for NPDES Phase II of stormwater control under the CWA is provided by the USEPA, Office of Water, in several documents (USEPA 2000). This guidance clarifies the two categories of concern regarding stormwater: runoff quality and runoff quantity. Construction may be permitted either under industrial activity categories or through the USEPA Construction General Permit (CGP). Stormwater controls are required on all sites; construction that disturbs greater or equal to 5 acres are treated under one set of guidelines and for those that disturb less than 5 acres, there is another guideline set (USEPA 2007b).

Energy Independence and Security Act of 2007

Section 438, Storm Water Runoff Requirements for Federal Development Projects, states that "The sponsor of any development or redevelopment project involving a Federal facility with a footprint that exceeds 5,000 sq ft shall use site planning, design, construction, and maintenance strategies for the property in order to maintain or restore, the maximum extent technically feasible, the predevelopment hydrology of the property with regard to the temperature, rate, volume, and duration of flow."

NPS Pollution Prevention

Two categories of NPS P2 controls are defined in the USEPA *Post-Construction Rules* (USEPA 2000). These are non-structural Best Management Practices (BMPs, e.g., planning, education, and strategic measures such as selective grading, buffer protections and site fingerprinting) and structural BMPs (e.g., retention/detention BMPs, infiltration BMPs, and vegetative BMPs). Under these definitions, LID technologies and practices are in both the nonstructural BMP and the structural-infiltration BMP and structural-vegetative BMP categories (USEPA 2000; Figure A-6). Prior to NPDES General Construction permitting, a P2 plan must be developed; this LID practice is inherent in the regulatory structure of the permitting process.



Figure A-6. Roads collect high concentrations of phosphorous, suspended solids, bacteria, and various metals, and generate high volumes of NPS pollution and concentrated runoff.

Peak Flow Reduction

Stormwater Management guidance is directed towards "Appropriate Measurable Goals" (USEPA 2000). LID results may be quantified by installing monitoring stations that measure nutrient load reductions and sediment loads throughout and after the construction process. Another way to measure benefits is to examine life-cycle costs of LID tools versus conventional tools or to adopt practices from similar sites that have been proven through measurement to achieve the desired benefit levels.

On-Site Water Harvesting

Disconnecting downspouts from the conventional stormdrain system and linkage to rain barrels and cisterns is a means of achieving on-site water harvesting. Rooftop collection and drainage into a cistern is another option for on-site water harvesting. Disconnection may be less generally applicable to Army projects, especially those outside the cantonment, but it is a water conservation strategy clearly applicable where water supply concerns are high (Figure A-7).

Low Impact Development Integrated Management Practices

LID IMPs use microscale and distributed management techniques to achieve desired post-development hydrologic conditions that will most closely match pre-development hydrologic conditions (PG County 1999). IMPs address stormwater problems close to the source and significantly reduce the hydrologic impacts of site disturbance. LID IMPs are sized to treat the runoff from typical rain events for an area. Using hydrology as the integrating framework, applied close to the source, LID IMPs are simple, nonstructural methods that solve stormwater management problems and help to create a multi-functional landscape (Figure A-8; PG County 1999). LID IMPs integrate site hydrology into the site planning process with better hydrologic results as a measurable outcome. Runoff and recharge of a site with a full-scale application of IMPs will emulate the pre-development hydrologic conditions of that site. They also serve to reduce flow peaks and to reduce or eliminate stormwater discharge, including discharge into roadside ditches. These ditches have been recognized as major contributors to sediment discharge, and any reductions in flow will thus help to reduce sediment losses.



Figure A-7. James County Courthouse bioretention demonstration project taken during rainfall event (on-site stormwater runoff harvesting).

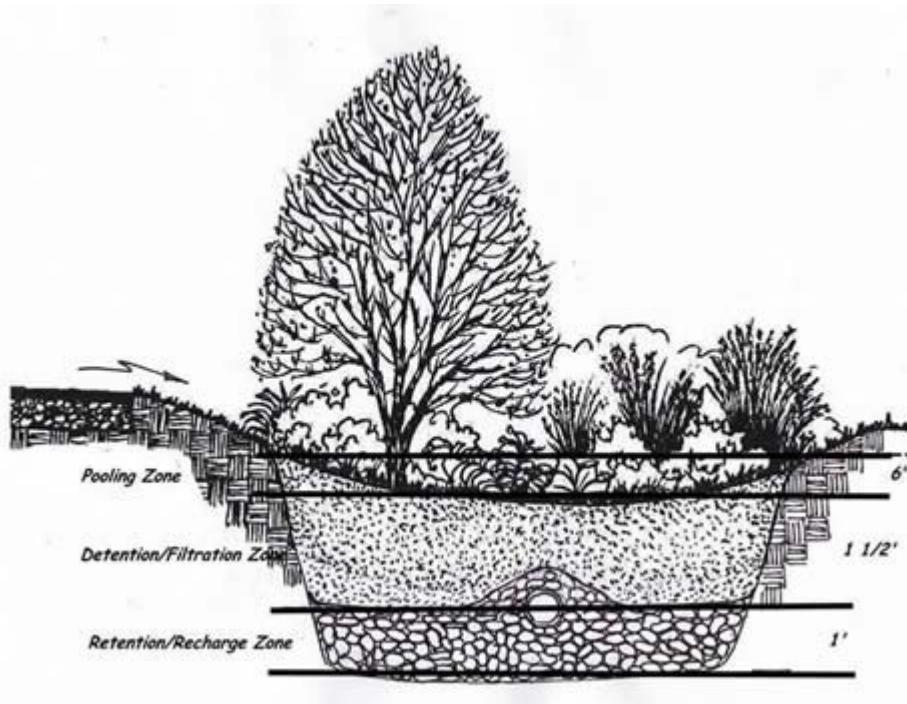

Figure A-8. LID IMPs are sized to capture runoff NPS pollution and reduce stormwater discharge and off-site migration of pollutants.

LID IMPs are a decentralized approach to stormwater management. IMPs may be used in sequence with each other (e.g., a combination of a grassy swale filter mat that leads to a bioretention area via a vegetated swale) or they may be used as stand-alone treatments (e.g., a bioretention cell installed into an otherwise impervious area [Figure A-9]). IMPs have great flexibility in the combinations in which they can be installed and in the sequence in which they can be used to mitigate stormwater.

Any site-based project, whether it is a new, redevelopment, or capital improvement project, may be viewed as a candidate for implementation of LID IMPs (USACE/NAVFAC/AFCEA 2003). They are suitable for use as retrofit solutions in conjunction with existing conventional stormwater systems that are over capacity or in situations where installation of conventional controls is neither feasible nor desirable, such as on a military range.



Figure A-9. A bioretention cell installed within an impervious area is one approach to stormwater management.

The 13 LID practices identified in Appendix B are those best suited for application on military ranges. All of these LID IMPs are easily constructed, low-cost alternatives that may be readily installed with materials typically available in the local area. Figures A-10 and A-11 show an example installation of a typical LID IMP. These LID IMPs may be used to satisfy storage volume requirements as well as meeting water quality benefit requirements.



Figure A-10. The ditch where the rain garden was later constructed (Harrisonburg, VA).



Figure A-11. Rain garden in June 2003, 14 months after construction (Harrisonburg, VA). When used as a LID IMP, this rain garden is an example of a bioswale.

Selection of LID IMPs follows a logical design process whereby a solution to a site is customized to achieve the optimal stormwater management strategy for the greatest hydrologic benefit. LID IMPs should be selected based on the design process (PG County 1999) listed below. Figure A-12 shows these steps.

1. Define hydrologic control required.
2. Evaluate site constraints.
3. Screen for LID IMP choices.
4. Evaluate LID IMPs in various configurations.
5. Select preferred configuration and design.
6. Supplement with conventional controls, if necessary.

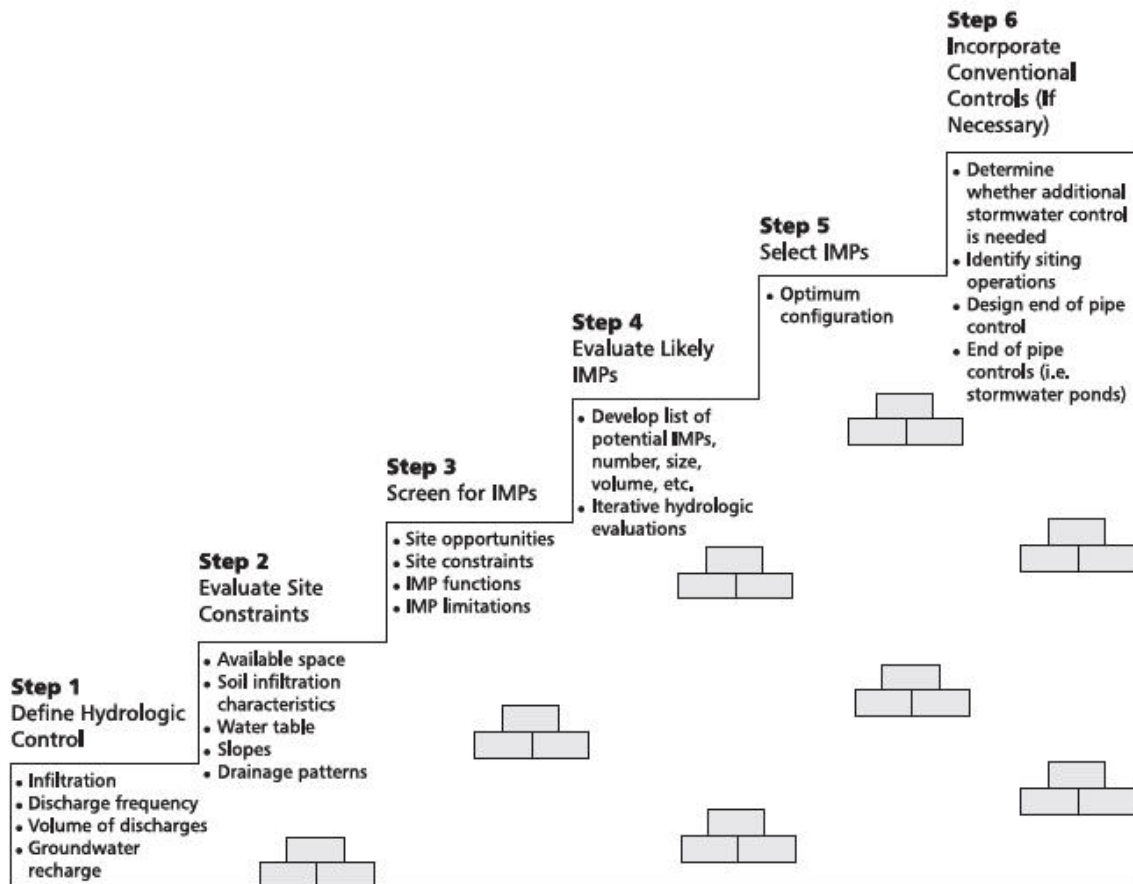

Figure A-12. Key steps in developing stormwater plan using LID practices (Source: PG County 1999).

The goal of LID IMPs is to address the hydrology issues found on a site. The questions shown in Figure A-13 structure the process to aid in the LID technology and practice selection for a given site. The nine Activity Fact Sheets (Appendix B) are a starting point for answering these fundamental questions.

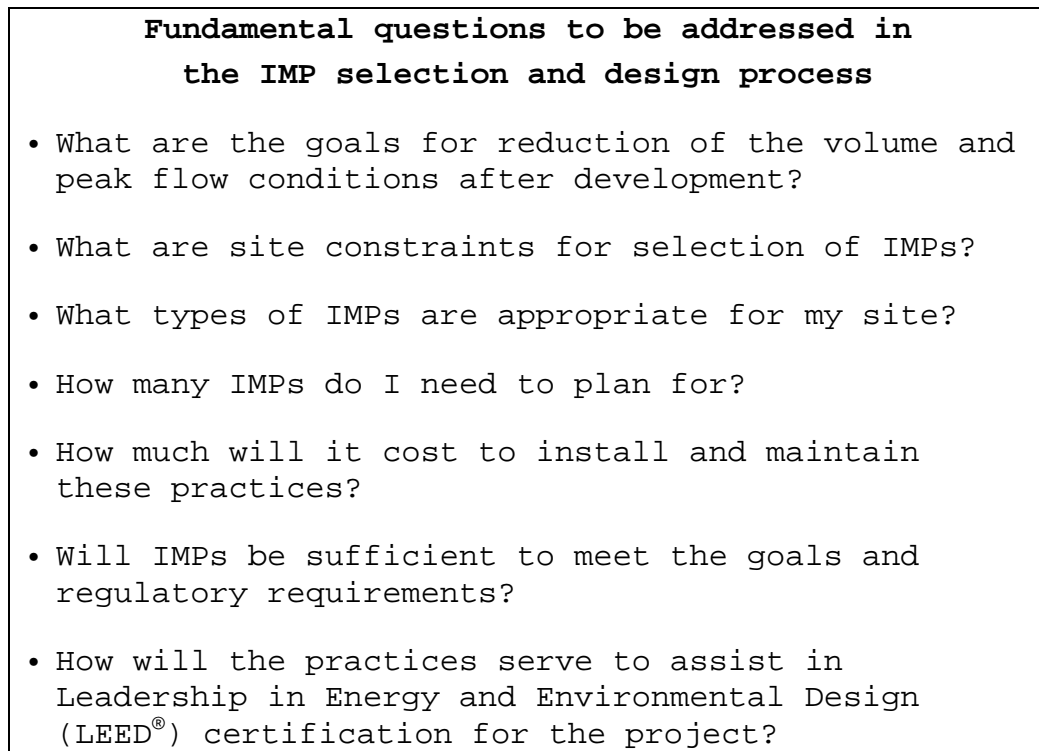

Figure A-13. IMP selection and process questions.

Each IMP is selected based on site suitability. Different practices will have different constraints. Table A-2 lists some summary examples. Each LID Technology Fact Sheet has a summary of conditions for use and each Activity Fact Sheet has a summary of the most appropriate practices for a given activity.

IMP selection is an optimization process that balances site conditions, cost, hydrologic benefits, and other landscape values in the decision process. Use of LID IMPs allows the integration of engineering, planning, and science to achieve not only stormwater benefits but often other benefits such as aesthetic enhancement, habitat enrichment, and multiple land use opportunities.

Table A-2: Site constraints of IMPs.

	Bioretention	Dry Well	Filter/Buffer Strip	Swales: Grass, Infiltration, Wet	Rain Barrels	Cistern	Infiltration Trench
Space Required	Minimum surface area range: 50 to 200 ft ² Minimum width: 5 to 10 ft Minimum length: 10 to 20 ft Minimum depth: 2 to 4 ft	Minimum surface area range: 8 to 20 ft ² Minimum width: 2 to 4 ft Minimum length: 4 to 8 ft Minimum depth: 4 to 8 ft	Minimum length of 15 to 20 ft	Bottom width: 2 ft minimum, 6 ft maximum	Not a factor	Not a factor	Minimum surface area range: 8 to 20 ft ² Minimum width: 2 to 4 ft Minimum length: 4 to 8 ft
Soils	Permeable soils with infiltration rates > 0.27 inches/hour are recommended. Soil limitations can be overcome with use of underdrains	Permeable soils with infiltration rates > 0.27 inches/hour are recommended	Permeable soils perform better, but soils not a limitation	Permeable soils provide better hydrologic performance, but soils not a limitation. Selection of type of swale, grassed, infiltration or wet is influenced by soils	Not a factor	Not a factor	Permeable soils with infiltration rates > 0.52 inches/hour are recommended
Slopes	Usually not a limitation, but a design consideration	Usually not a limitation, but a design consideration. Must locate downgradient of building and foundations	Usually not a limitation, but a design consideration	Swale side slopes: 3:1 or flatter Longitudinal slope: 1.0% minimum; maximum based on permissible velocities	Usually not a limitation, but a design consideration for location of barrel outfall	Not a factor	Usually not a limitation, but a design consideration. Must locate downgradient of buildings and foundations
Water Table/Bedrock	2- to 4-ft clearance above water table/bedrock recommended	2- to 4-ft clearance above water table/bedrock recommended	Generally not a constraint	Generally not a constraint	Generally not a constraint		2- to 4-ft clearance
Proximity to build foundations	Minimum distance of 10 ft downgradient from buildings and foundations recommended	Minimum distance of 10 ft downgradient from buildings and foundations recommended	Minimum distance of 10 ft downgradient from buildings and foundations recommended	Minimum distance of 10 ft downgradient from buildings and foundations recommended	Not a factor		Minimum distance of 10 ft downgradient from buildings and foundations recommended
Max. Depth	2- to 4-ft depth depending on soil type	6- to 10-ft depth depending on soil type	Not applicable	Not applicable	Not applicable		6- to 10-ft depth depending on soil type
Maintenance	Low requirement, property owner can include in normal site landscape maintenance	Low requirement	Low requirement, routine landscape maintenance	Low requirement, routine landscape maintenance	Low requirement		Moderate to high

(Source: PG County 1999)

LID Case Studies - Army Experience

Fort Lee, VA

The Fort Lee LID project was to restore 10 acres that were used as a storage area and auxiliary parking for the post commissary. The area was composed of severely compacted clay and sand soils that were poorly vegetated. The design incorporated LID techniques such as compost amending soils, soil aeration, regrading, reforestation and revegetation, and installation of bioretention swales and cells. The project included the development of a marsh and bird habitat area. Figure A-14 shows a LID retrofit at Fort Lee, VA.

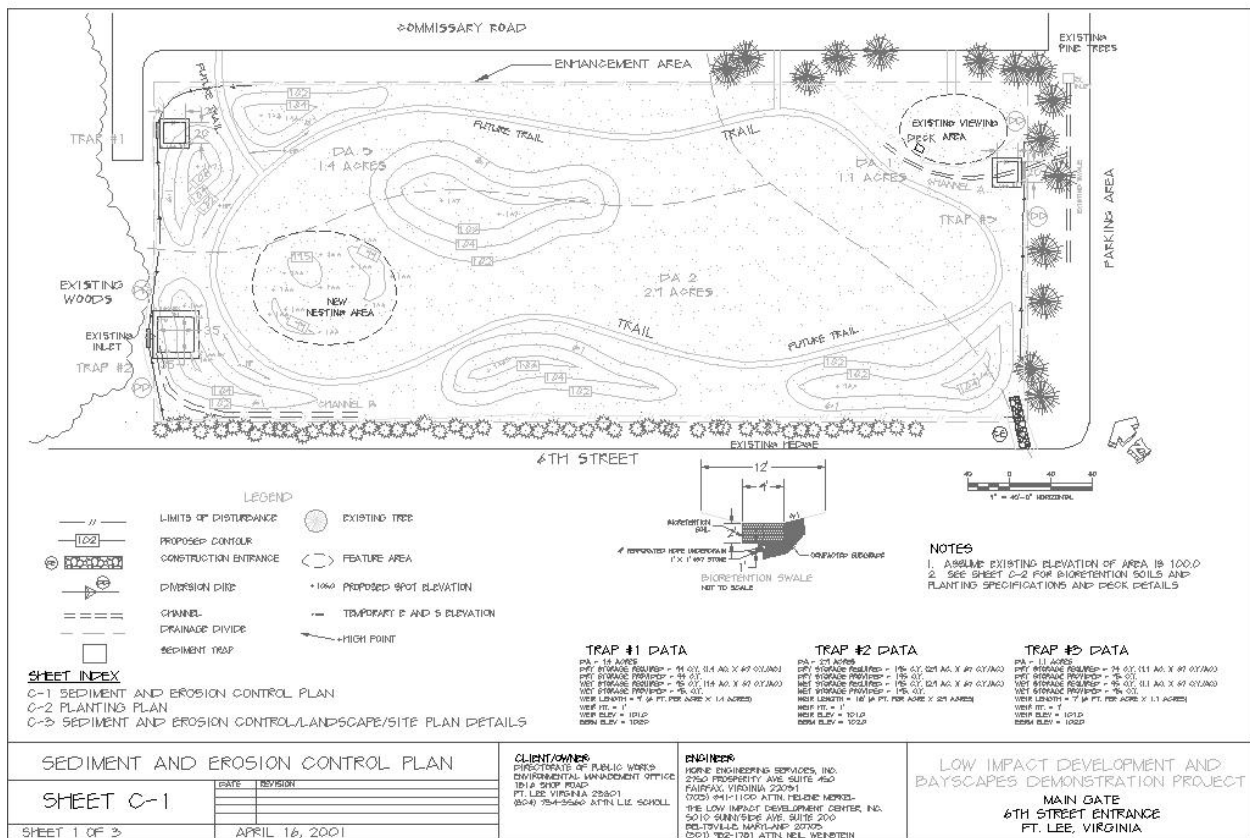

Figure A-14. Site plan of LID retrofit at Fort Lee, VA.

Fort Bragg, NC

Fort Bragg's "Sustainable Fort Bragg" LID projects provide valuable lessons learned on how LID has been and can be further implemented at military installations. A multi-disciplinary team has been assembled as Fort Bragg's Water Resources Team. The base has partnered with local and regional authorities to find long-term water resource goals. Initial steps include developing methods for rapid assessment of stream sediment load, updating the Installation Design Guide, and providing key installation staff with LID training (Fort Bragg 2003). The Fort Bragg approach is to determine the stakeholders in the process and to be inclusive in the problem solving process.

The Sustainable Training Areas Team has been implemented at Fort Bragg also. The Team's duties include serving on the Regional Land Use Advisory Council (RLUAC). This diverse organization includes local, county, and municipal representatives and planners. The RLUAC develops and implements Joint Land Use Studies for the areas directly adjacent to the installation (AEC 2007).

Fort Bragg has also used LID in housing developments and as part of retrofit pilot projects to reduce the impact of runoff on water quality and on the capacity of the storm drainage infrastructure to reduce flooding. Designs have been developed (Figure A-15) to retrofit parking and mobilization areas, loading areas, and driveways (Figure A-16). Low-cost construction and mobilization are the key features of the demonstration projects.

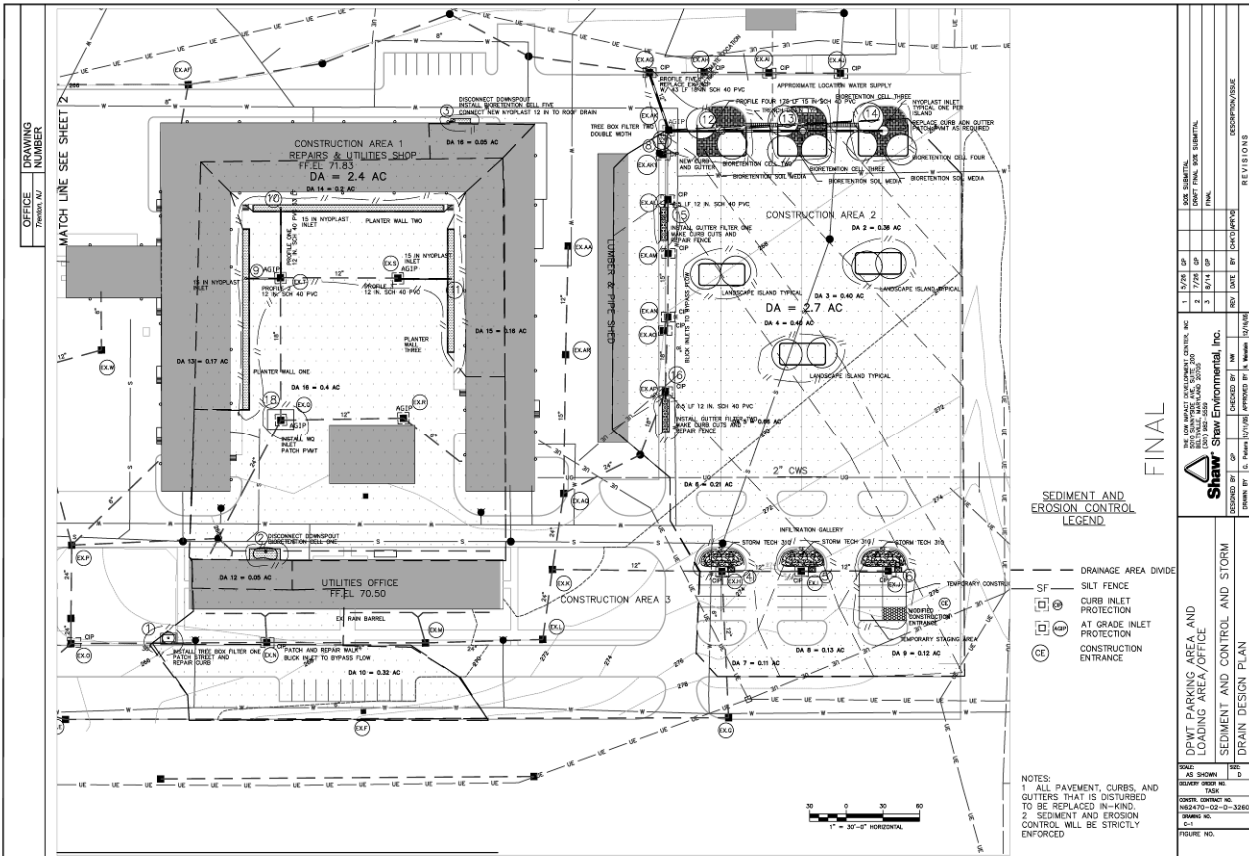

Figure A-15. Fort Bragg LID retrofit site plan.



a.



b.

Figure A-16. Application of a bioretention cell (in construction[a], and finished [b]) to control runoff from the roof of a warehouse at Fort Bragg.

Fort Gordon, GA

Fort Gordon has planned the retrofit of storage yards and maintenance facilities using LID techniques, including disconnection of direct drainage paths, revegetation of buffer areas, and installation of bioretention (Figure A-17). Sediment traps were also planned as long-term measures to reduce sediment loads from parking and storage of vehicles on grassed areas.

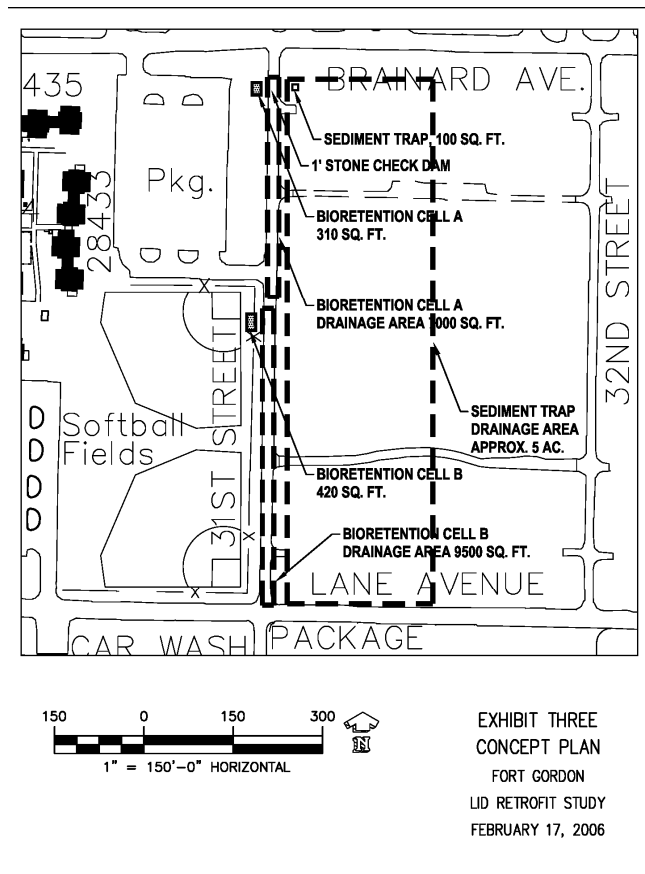

Figure A-17. Some Fort Gordon LID measures.

Fort Stewart, GA

Fort Stewart is also planning for LID facilities along access roads and for a retrofit of housing areas. The installation has highly erodible soils that are subject to traffic loads due to parking along roadways (Figure A-18). LID vegetation techniques are being designed to trap the sediments. Roadway edges will use pavers or permeable pavement blocks to reduce erosion (see Figure A-18) and support traffic and parking. Disconnection, revegetation, and bioretention are being used to reduce pollutant loads and stormwater volume to the storm drain system. Figure A-19 shows a retrofit schematic.



Figure A-18. Parking overflow and erosion at Fort Stewart, GA.

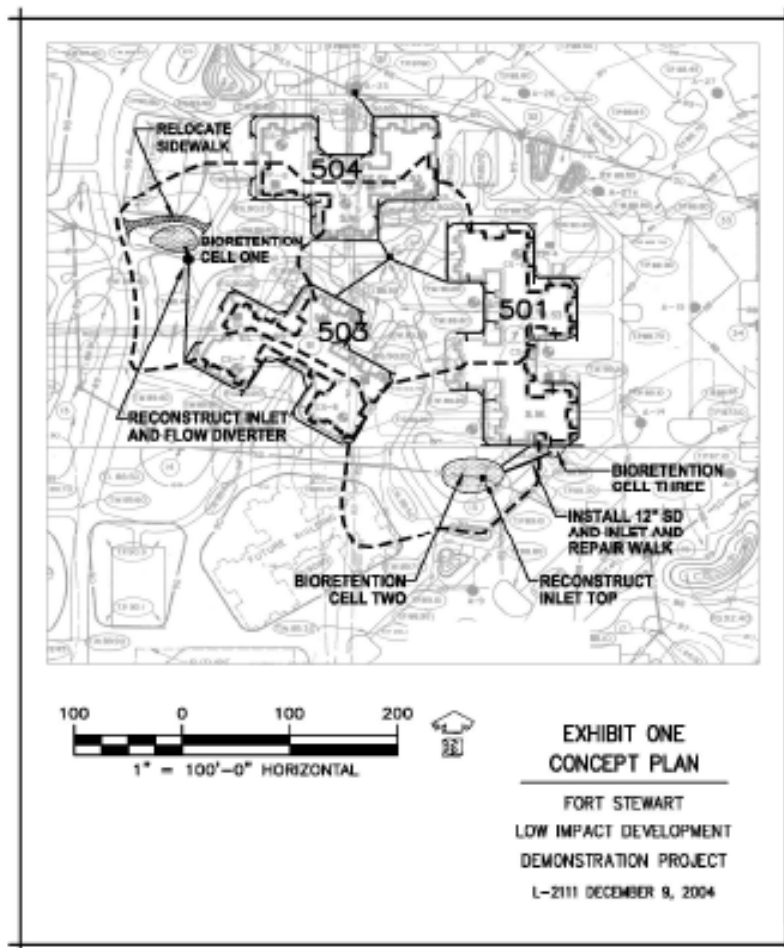

Figure A-19. Housing area retrofit schematic at Fort Stewart.

Other Examples

The U.S. Army Conservation Reimbursable Forestry Program (Lichtenstein 2004) provides existing military program structure for reforestation and afforestation efforts on military ranges. The program is in place for applications on maneuver corridors and bivouac sites. Tree spacing and range construction are part of the mission of "Preserving the Environment ... While Protecting Our Freedom."

LID has been successfully implemented in many non-DoD applications and has been adopted as a BMP by the USEPA, several state departments of natural resources, and the Federal Highway Administration. Seattle, WA, has been a leader in the Pacific Northwest in the implementation of LID retrofits and in redevelopment projects. Two notable projects are the Seattle Street Edge Alternatives (SEA) program and an affordable housing redevelopment project named High Point (SvR 2006). The SEA streets program retrofit LID bioswales and reduced impervious surfaces in a residential area to achieve stormwater quality improvement and volume reduction goals. The High Point case is an example of a LID effort that required collaboration among several city agencies to achieve cost savings and required infrastructure development while maintaining Seattle's high quality of life (Johnson and Staeheli 2005). This effort has been driven by the need to revamp the city's stormwater code so that the Municipal Stormwater NPDES permit could be renewed. The new code includes LID practices and information from the Washington State Puget Sound Action Team's Low Impact Development Manual (Wulkan 2005).

LID Practices for Military Applications

Military-unique circumstances require the development of information to address military needs. The DoD is in a unique land position, with large land areas and military ranges in a wide range of climate zones. A chart that rates the relative effectiveness of a given LID technology in a particular climate (Appendix E) is included as a supplement to the Activity and Technology Fact Sheets. This chart is to be used as a guideline for LID technology selection, but any given technology or practice should be selected with attention to local conditions of plant supply, soil conditions, and appropriate education delivery model as well as climate.

Implementing LID Practices and Receiving LEED® Credits

The act of implementing the recommendations of LID can contribute to becoming a LEED®-certified site (USGBC 2001). LEED® covers five environmental categories; the LID measures referred to in this PWTB relate to the LEED® category of Sustainable Sites. Within the primary focus areas of this PWTB, the areas from which credits are most reliably attained are those relating to Site Selection (Credit 1), Site Development (Credits 5.1 and 5.2), and Stormwater Design (Credits 6.1 and 6.2). Appendix G contains a full table of all potential credits for which typical training area projects may be eligible. Please note that no single project will likely be able to claim all these credits, but that many are possible through careful design and planning.

Summary

LID technologies and practices are effective tools for achieving water quality improvements and stormwater volume reductions that are mandated by Federal regulations such as the CWA NPDES Phase II, and other state and local mandates pertaining to improved environmental protection. LID allows for creative and site-sensitive solutions to be implemented to solve stormwater problems.

Unlike many structural solutions, LID technologies and practices are both relatively inexpensive to install, maintain, and repair in the event of a training exercise or normal course of military activity damaging the LID tool. Further, LID technologies have an advantage over conventional stormwater management as they are easily inspected visually so that repairs may be instituted when the problem is small. Once designed, LID tools are typically more quickly constructed and more easily inspected than are conventional stormwater management structural controls. Adoption of LID SOPs significantly expands the toolbox of environmental solutions that the DoD may use to comply with CWA Phase II regulations.

The use of the LID technologies on military lands adds to the toolbox of stormwater and environmental solutions that are sustainable in character. All of the LID technologies detailed on the Technology Fact Sheets are able to be constructed with well established construction tools and practices, with minimal site disturbance. LID supports the military mission of sustainable ranges by mitigating detrimental environmental effects such as soil disturbance and stormwater runoff and protecting the environmental quality of military ranges. The

sustainable ranges mission is further supported by the secondary benefits of many LID practices: improved habitat, improved aesthetics, and smaller land areas needing to be set aside for stormwater treatment.

References

- Army Environmental Center. Addressing Encroachment with Cooperative Agreements and Conservation.
<http://aec.army.mil/usaec/natural/natural03a04.html>
- Fort Bragg, NC. 2003. Sustainable Fort Bragg, Annual Report.
<http://www.bragg.army.mil/stustainability/library/pdf/annualReportV5.pdf>
- Headquarters, Department of the Army (HQDA). 2002. Commander's Guide: Army Installation Standards, Assistant Chief of Staff for Installation Management Facilities Policy Division, Oct. 1, 2002, Washington, DC.
<http://www.hqda.army.mil/acsimweb/homepage.shtml>
- Headquarters, U.S. Army Corps of Engineers (USACE). 2007. USACE Army LEED® Implementation Guide (Draft). Washington, DC.
- Johnson, Richard L., and Peg Staeheli. 2005. City of Seattle—Stormwater Low Impact Development Practices. Retrieved 5 July 2007 from:
http://www.seattle.gov/util/stellent/groups/public/@spu/@esb/documents/webcontent/spu01_002622.pdf
- Lichtenstein, Mark. 2004. U.S. Army Conservation Reimbursable Forestry Program. U.S. Army Environmental Center, Maryland. Accessed June 2007 from
http://www.masonbruce.com/wfe/2004Program/1C3_Mark_Lichtenstein.pdf
- Office of the Secretary of Defense (OSD). 1996. Chapter 5, 1996 EQ Annual Report.
<https://www.denix.osd.mil/denix/Public/News/OSD/EQ96/TOC.html>
- SvR Design Company. 2006. High Point Community: Right of Way and Open Space Landscape Maintenance Guidelines.
- U.S. Environmental Protection Agency (USEPA). 2000. Office of Water, Stormwater Phase II Final Rule: Post-Construction Runoff Control Minimum Control Measure, EPA 833-F-00-0009, Fact Sheet 2.7, January 2000 (revised December 2005). See also: <http://cfpub.epa.gov/npdes/stormwater/swcats.cfm>, <http://cfpub.epa.gov/npdes/stormwater/const.cfm>, <http://cfpub.epa.gov/npdes/stormwater/swphases.cfm>

_____. 2007a. National Pollutant Discharge Elimination System (NPDES), Stormwater Program.

http://cfpub.epa.gov/npdes/home.cfm?program_id=6

See also: <http://cfpub.epa.gov/npdes/index.cfm>

_____. 2007b. General Construction Permit.

<http://cfpub.epa.gov/npdes/stormwater/cgp.cfm>

U.S. Army Corps of Engineers, Naval Facilities Engineering Command, Air Force Civil Engineering Support Agency (USACE/NAVFAC/AFCEA). 2003. Department of Defense Unified Facilities Criteria, Design: Low Impact Development Manual.

U.S. Green Building Council, LEED: Leadership in Energy & Environmental Design, Reference Guide Version 2.0 (June 2001). www.usgbc.org

University of Illinois at Urbana-Champaign (UIUC). 2007. A Desert Tortoise Model: A Spatially Explicit Simulation.

Retrieved 24 May 2007 from:

http://blizzard.gis.uiuc.edu/dsm_tort_main.htm

Wulkan, B. 2005. Puget Sound Partnership and WSU Extension, Pierce County. Bruce Wulkan (ed.) Low Impact Development Technical Guidance Manual for Puget Sound.

http://www.psp.wa.gov/our_work?stormwater/lid/lid_manual.htm

(accessed 21 November 2007).

PWTB 200-1-62
1 October 2008

PWTB 200-1-62
1 October 2008

APPENDIX B: Activity and Technology Fact Sheets

PWTB 200-1-62
1 October 2008



**US Army Corps
of Engineers®**
Engineer Research and
Development Center

Assembly Areas Draft 05.22.2008

Key Terms

Clearing	Permanent Stabilization	Hydrologic Cycle
Grubbing	Stormwater Runoff	NPDES Permits
Soil Stockpile	Low Impact Development	Temporary Stabilization
Grading	Silt Fence	Topographic Map
Sediment Control	Compost Filter Sock	Soils Map
Wetlands	Bioswale	Compost Amendment
Compost Mat	Tactical Assembly Area	Afforestation

Assembly Areas Site Disturbance Activities

In an assembly area, large groups of soldiers and their equipment are organized and assembled to prepare for further action. The area is typically stripped of the majority of vegetation and heavy vehicles drive throughout the site. The absolute size of the assembly area will vary depending on the size of the force that is typically using the area. Trees and other vegetation on the perimeter of the areas will be cleared as necessary to accommodate a larger force.

Large trees, shrubs and other debris (rocks, trash, etc.) will need to be removed within the assembly area for ease of visual inspection and vehicle movement but selective clearing may be employed to allow for continued vegetative cover in strategic locations throughout the site. Installation of Low Impact Development (LID) tools will cause some temporary site disturbance that is managed through the use of sedimentation and erosion controls throughout the construction process.

The location and size of the LID tools to be used will be determined in the field, based on topography, typical traffic patterns and potential for runoff and erosion.

Assembly areas are subject to extreme compaction and large scale group activities, which may cause compaction, erosion and loss of vegetative cover. In certain regions, the loss of vegetative cover has long-term environmental consequences due to lack of natural rainfall or condition of native soils.

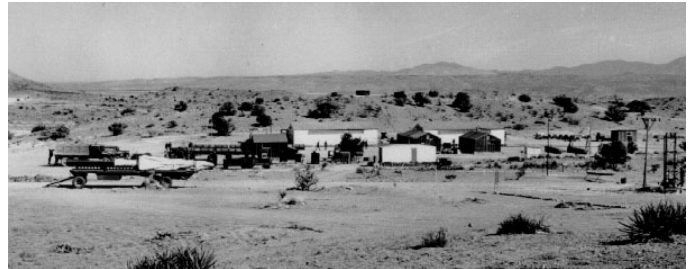

White Sands image of missile assembly area. (Image used courtesy of White Sands Missile Range Public Affairs Office.)

Environmental Impacts of Disturbance Activities

Environmental Impacts

- Compaction
- Increased runoff
- Erosion
- Increased heat locally due to loss of vegetative cover
- Loss of habitat for plants and animals

**Appropriate LID tools for
correcting environmental
problems at Assembly
Areas**

Vegetated LID tools are appropriate for use adjacent to assembly areas. These are small scale stormwater control devices that improve water quality and reduce stormwater runoff volume. They are vegetated with plants that are tolerant of a range of moisture regimes. In some cases, it may be determined that the area for assembly may be reduced and an afforestation strategy may be employed.



Severely eroded assembly area.

Compost amendments may also be a valuable LID tool to employ to improve soil fertility and structure within the planted areas.

Construction Phase:

- Compost Filter Sock.
 - N Used for streambank stabilization and temporary filters to protect inlets to stormdrains.
- Filter Mat.
 - N Used for streambank stabilization and temporary filters to protect inlets to stormdrains.

Post-Construction Phase:

- Bioretention cell.
 - N An area that is designed to treat and infiltrate stormwater from an area no larger than ½ acre using natural processes in engineered soil media and plant roots to remove nutrients and other pollutants.
- Bioretention strip.
 - N Linear features that are used to treat and infiltrate stormwater adjacent to where the stormwater is generated.
- Bioswale.
 - N A swale prepared with bioretention mix designed to convey stormwater; they catch pollutants and nutrients in stormwater; they may also provide for habitat improvements for local small animal populations. Bioswales may be planted as grassy swales or as swales vegetated with wildflowers, shrubs, and small trees.

Site Recovery Phase:

- Compost Amendments:
 - N Amendments used to improve soil fertility and structure to create an improved growing environment for plants.
 - N Afforestation/ Reforestation.
 - N Replanting trees provides vegetative cover and restores hydrologic function to an area.

The volume of water to be stored may be determined through the use of ARMSED (Army Multiple Watershed Storm Water and Sediment Runoff), a Runoff and Sediment Yield Model for Army Training Land Watershed Management. Volume 1. Parameter Estimation Guide.

Permits Required

- Construction phase: Erosion and Sedimentation Control.
- Post-Construction – NPDES.

Construction Materials Needed

Construction materials needed are typically readily available in the field. Hand tools will suffice if there is not access to earthmoving equipment although for larger excavations, heavy equipment such as a bobcat or other digging machine is desirable. In all cases appropriate erosion and sedimentation controls are needed throughout the construction process. Plant materials should be procured from local nurseries and should be selected for their ability to sustain themselves in the environment in which they are being planted – either bioretention or reforestation/afforestation

Equipment Needed:

- Bobcat or Grader
- Hand Tools
- Hose
- Wheelbarrows
- Tarp
- Silt Fence materials
- Stakes
- Marking Flags/ Paint
- Measuring wheel or tape

Installation

Bioretention Cells, Bioretention Strips, Bioswales, Afforestation/Reforestation, Compost Filter Socks, Filter Mats, and Compost Amendments are all easily installed LID tools that address sediment and nutrient problems in stormwater runoff. The sediment and erosion control procedures for installation follows standard operating procedures that are in place for all construction sites. Compliance with erosion and sedimentation rules for site construction must occur. Refer to the LID tools list for appropriate timing of tool application.

Inspection and Monitoring

The job should be checked by the project manager or the project manager's appointee at each point in the construction process:

- Site delineation.
- Excavation.
- Underdrains.
- Planting media (before and after installation).
- Plants (before and after installation).
- Mulch (before and after installation).

Monitoring Stations should be established at the time of installation to measure water quality and volume at the point of entry and at the point of exit from the bioretention area; a monitoring schedule should be established as part of the maintenance scheduling of the bioretention area. Data from the monitoring should be recorded and kept with the environmental officer.

LID tools in practice

Images of Bioretention Strip, Grassy Swale, Vegetated Swale, Bioretention Cell, Afforestation



PWTB 200-1-62
1 October 2008



**US Army Corps
of Engineers®**
Engineer Research and
Development Center

Bivouac

Draft 06.26.2007

Maintenance

- Varies depending on Low Impact Development (LID) tool chosen.
- Periodic basin cleanup keeps the system working – remove debris and cut back herbaceous plants (flowers and grasses) every late winter/early Spring.
- Schedule pipe clean-out maintenance and provide access points to keep the system working as designed.
- Do not fertilize.
- Inspect mulched areas and replace mulch annually.

Further Resources

- Public Works or Environmental Officer.
- See LID Technology Sheets and Appendices.

Key Terms

Bivouac Sites Disturbance Activities

Clearing, Permanent Stabilization, Hydrologic Cycle
Temporary bivouac sites will be less disturbed than hardened bivouac sites; the hardened sites will have more clearing and established structural core areas than a temporary sites. <http://www.globalsecurity.org/military/library/policy/army/fm/3-100-4/appg.htm>

Trees, shrubs, and other debris (rocks, trash, etc.) will need to be removed within the core areas selectively to permit any permanent features to be installed. Dead wood may be gathered and forest floor cover disturbed by repeated firewood harvesting.

Environmental Impacts:

- Compaction
- Increased runoff
- Erosion
- Increased heat locally due to loss of vegetative cover
- Loss of habitat for plants and animals
- Loss of ground layer of plants

Environmental Impacts of Disturbance Activities

Bivouac areas that are used repeatedly are subject to compaction and loss of ground level vegetation and cover. This can lead to increased erosion and loss of habitat for ground dwelling animals and plants.



Hardened bivouac site.



Temporary bivouac site.

**Appropriate LID tools
for correcting
environmental
problems at Bivouac
Sites**

Vegetated LID tools are appropriate for use within and around bivouac areas. These are small scale stormwater control devices that improve water quality and reduce runoff volume. They can be established with or without the use of heavy equipment, are flexible in their shape and placement and are straightforward to construct. They are vegetated with plants that are tolerant of a range of moisture regimes and adapted to local conditions. Site fingerprinting and selective grading are also appropriate LID tools to use. Other LID tools that would be appropriate would be Site Fingerprinting and Selective Grading and Clearing as well as Reforestation and /or Afforestation measures. In some cases, where the bivouac site is near streambanks, compost filter socks and/or filter mats may be an appropriate temporary LID tool.

Construction Phase:

- Site fingerprinting.
 - N Field evaluation of the areas of a site in which the type of necessary development may occur while minimizing the potential for negative environmental consequences.
- Selective grading.
 - N Grading done after a site analysis that selectively reshapes the earth to accommodate the desired development while leaving other areas on the site undisturbed.
- Compost Filter Sock.
 - N Used for streambank stabilization and temporary filters to protect inlets to storm drains.
- Filter Mat.
 - N Used for streambank stabilization and temporary filters to protect inlets to storm drains.

Post-Construction Phase:

- Bioretention cell.
 - N An area that is designed to treat and infiltrate stormwater from an area no larger than ½ acre using natural processes in engineered soil media and plant roots to remove nutrients and other pollutants.
- Bioretention strip.
 - N Linear features that are used to treat and infiltrate stormwater adjacent to where the stormwater is generated.

- Bioswale.
 - N A swale prepared with bioretention mix designed to convey stormwater; they catch pollutants and nutrients in stormwater; they may also provide for habitat improvements for local small animal populations. Bioswales may be planted as grassy swales or as swales vegetated with wildflowers, shrubs, and small trees.
- Vegetated Swales.
- Grass-Lined Swales.
- Site Recovery Phase.
- Compost Amendments.
 - N Amendments used to improve soil fertility and structure to create an improved growing environment for plants.
- Afforestation/ Reforestation.
 - N Replanting trees provides vegetative cover and restores hydrologic function to an area.

The volume of water to be stored may be determined through the use of Army Multiple Watershed Storm Water and Sediment Runoff (ARMSED), a Runoff and Sediment Yield Model for Army Training Land Watershed Management. Volume 1. Parameter Estimation Guide.

Permits Required

- Construction phase: Erosion and Sedimentation Control.
- Post-Construction – National Pollutant Discharge Elimination System (NPDES).

Construction Materials Needed

Construction materials needed are typically readily available in the field. Hand tools will suffice if there is not access to earthmoving equipment although for larger excavations, heavy equipment such as a bobcat or other digging machine is desirable. In all cases appropriate erosion and sedimentation controls are needed throughout the construction process. Plant materials should be procured from local nurseries and should be selected for their ability to sustain themselves in the environment in which they are being planted – either bioretention or reforestation/afforestation.

Equipment Needed:

- Bobcat or Grader
- Hand Tools
- Hose
- Wheelbarrows
- Tarp
- Silt Fence materials
- Stakes
- Marking Flags/ Paint
- Measuring wheel or tape

Installation Procedure

Bioretention Cells, Bioretention Strips, Bioswales, Afforestation/Reforestation, Compost Filter Socks, Filter Mats, and Compost Amendments are all easily installed LID tools that address sediment and nutrient problems in stormwater runoff. The sediment and erosion control procedures for installation follows standard operating procedures that are in place for all construction sites. Compliance with erosion and sedimentation rules for site construction must occur. Refer to the LID tools list for appropriate timing of tool application.

Inspection and Monitoring

The job should be checked by the project manager or the project manager's appointee at each point in the construction process:

- Site delineation.
- Excavation.
- Underdrains.
- Planting media (before and after installation).
- Plants (before and after installation).
- Mulch (before and after installation).

Monitoring Stations should be installed at the time of installation that will measure water quality and volume at the point of entry and at the point of exit from the bioretention area; a monitoring schedule should be established as part of the maintenance scheduling of the bioretention area. Data from the monitoring should be recorded and kept with the environmental officer.

Bioretention Strip
Bioretention Cell
Vegetated Swale
Grassy Swale
Site Fingerprinting
Selective Grading



Example of a bioretention strip

Maintenance

- Periodic basin cleanup keeps the system working – remove debris and cut back herbaceous plants (flowers and grasses) every late winter/early Spring.
- Schedule pipe clean-out maintenance and provide access points to keep the system working as designed.
- Do Not Fertilize.
- Inspect Mulched areas and replace mulch annually.
- Replace dead plant materials as needed.

Program Manager
Further Resources

Public Works or Environmental Officer
See Technology Sheets



US Army Corps
of Engineers®
Engineer Research and
Development Center

Drop Zones

Draft 06.26.2007

Key Terms

Clearing	Permanent Stabilization	Hydrologic Cycle
Grubbing	Stormwater Runoff	Temporary Stabilization
Soil Stockpile	Low Impact Development	Topographic Map
Grading	Silt Fence	Soils Map
Sediment Control	Compost Filter Sock	Compost Amendment
Wetlands	Bioswale	National Pollutant Discharge Elimination System (NPDES)
Compost Mat		Permits

Drop Zone Site Disturbance Activities

In a drop zone, there must be an area for jumpers to land that is clear of large vegetation such as trees and shrubs. First an area is inspected to see that it has the appropriate terrain and location for a drop zone. The typical drop zone would require a clearing of a corridor of a 50m width and at least 320m X 100m for an inverted L pattern (see Figure 1). Eleven environmental permits, such as National Pollutant Discharge Elimination System (NPDES) and Wetlands, must be obtained. Then the perimeter of the area will be marked with

stakes in preparation for site clearing and an erosion and sedimentation control device will be installed around the perimeter. This can be done with a silt fence, compost filter sock, or other approved device from the sediment and erosion control manual. Large trees, shrubs, and other debris (rocks, trash, etc.) will need to be removed within the drop zone and top soil will be scraped and stockpiled as the terrain is graded to the

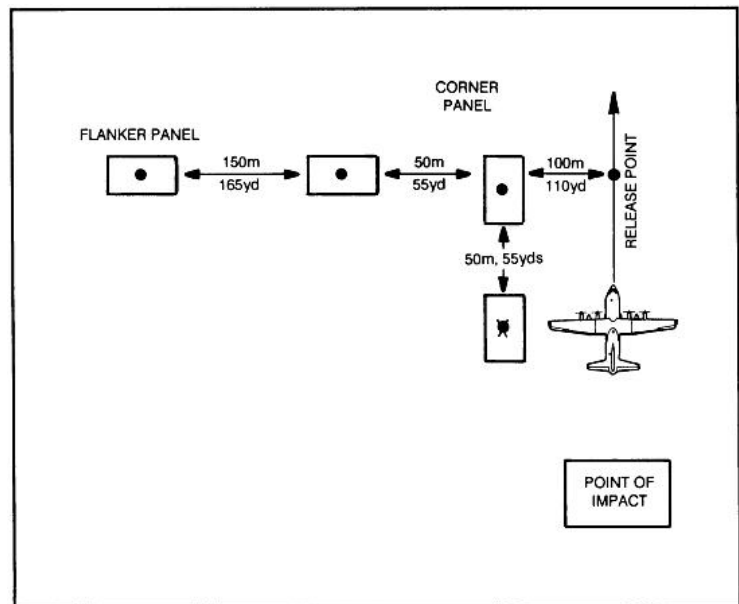

Ground Marked Release System (GMRS), Inverted "L" Pattern.

Image from: Field Manual, No. 90-26, Appendix B
Headquarters, Department of the Army, Washington, DC, 18
December 1990, accessible through URL:
http://www.globalsecurity.org/military/library/policy/army/fm/90-26/Appb.htm#figb_2

**Environmental Impacts
of Disturbance
Activities**

**Appropriate LID tools
for addressing
stormwater impacts
at Drop Zones**

appropriate level. This can be done using a combination of a York Rake to remove large rocks and roots, and a Bulldozer.

If additional grading is required to level the area out, the topsoil should be stockpiled off to the side. The stockpile should be stabilized with a temporary cover crop so that the topsoil is not wasted.

The clearing of vegetation through clearing, grading and compaction of the area with heavy equipment causes the undisturbed area to lose the ability to absorb rainwater. This creates runoff that carries pollutants from vehicles, sediment from unstabilized areas, greater volume of runoff that degrades streams and wetlands, and less groundwater recharge, dust, and dirt, which effect air quality are also generated. To reduce these impacts, vegetative practices can be used to help protect and restore the area.

Vegetated Low Impact Development (LID) tools are appropriate for use adjacent to drop zones because they are constructed of readily available materials, can be designed and constructed in a short amount of time with minimal training and mobilization, and are highly effective at treating or reducing any potential pollutants. They are not to be used as spill prevention or if there is a release of contaminants. Any spill of potential contaminant must be immediately contained and reported. Recommended LID tools that can be used for a drop zone training areas include:

Construction Phase

- Compost Filter Sock.
N Used for streambank stabilization and temporary filters to protect inlets to storm drains.
- Filter Mat.
N Used for streambank stabilization and temporary filters to protect inlets to storm drains.

Post-Construction Phase

- Bioretention cell.
N An area that is designed to treat and infiltrate stormwater from an area no larger than ½ acre using natural processes in engineered soil media and plant roots to remove nutrients and other pollutants.
- Bioretention strip.
N Linear features that are used to treat and infiltrate stormwater adjacent to where the stormwater is generated.
- Bioswale.
N A swale prepared with bioretention mix designed to convey stormwater; they catch pollutants and nutrients in stormwater; they may also provide for habitat improvements for local small animal populations. Bioswales may be planted as grassy swales or as swales vegetated with wildflowers, shrubs, and small trees.

Site Recovery Phase

- Compost Amendments.
N Amendments used to improve soil fertility and structure to create an improved growing environment for plants.
- Afforestation/ Reforestation.

Environmental Impacts:

- Compaction
- Increased runoff
- Erosion
- Increased heat locally due to loss of vegetative cover
- Loss of habitat for plants and animals.

N Replanting trees provides vegetative cover and restores hydrologic function to an area.

Permits Required

- Construction phase: Erosion and Sedimentation Control.
- Post-Construction – National Pollutant Discharge Elimination System (NPDES) permits.

Construction Materials Needed

Construction materials needed are typically readily available in the field. Hand tools will suffice if there is not access to earthmoving equipment although for larger excavations, heavy equipment such as a bobcat or other digging machine is desirable. In all cases appropriate erosion and sedimentation controls are needed throughout the construction process.

Equipment Needed:

- Bobcat or Grader
- Hand Tools
- Hose
- Wheelbarrows
- Tarp
- Silt Fence material
- Stakes
- Marking Flags/ Paint
- Measuring wheel or tape

Installation

Bioretention Cells, Bioretention Strips, Bioswales, Afforestation/Reforestation, Compost Filter Socks, Filter Mats, and Compost Amendments are all easily installed LID tools that address sediment and nutrient problems in stormwater runoff. The procedure for installation follows standard operating procedures that are in place for all construction sites. Compliance with erosion and sedimentation rules for site construction must occur. Refer to the LID tools list for appropriate timing of tool application.

Inspection and Monitoring

The job should be checked by the project manager or the project manager's appointee at each point in the construction process:

- Site delineation.
- Excavation.
- Underdrains.
- Planting media (before and after installation).
- Plants (before and after installation).
- Mulch (before and after installation).

Monitoring Stations should be installed at the time of installation, which will measure water quality and volume at the point of entry and at the point of exit from the bioretention area; a monitoring schedule should be established as part of the maintenance scheduling of the bioretention area. Data from the monitoring should be recorded and kept with the environmental officer.

LID tools in practice



Severely Eroded Drop Zone After Revegetation, Fort Bragg, NC.

Maintenance

- Periodic basin cleanup keeps the system working.

PWTB 200-1-62
1 October 2008

- Schedule pipe clean-out maintenance and provide access points to keep the system working as designed.
- Do Not Fertilize.
- Inspect Mulch and replace mulch annually.

Program Manager
Further Resources

Public Works or Environmental Officer
See Technology Sheets



**US Army Corps
of Engineers®**
Engineer Research and
Development Center

Maneuver Corridors

Draft 06.26.2007

Key Terms

Clearing	Permanent Stabilization	Hydrologic Cycle
Grubbing	Stormwater Runoff	Temporary Stabilization
Soil Stockpile	Low Impact Development	Topographic Map
Grading	Silt Fence	Soils Map
Sediment Control	Compost Filter Sock	Compost Amendment
Wetlands	Bioswale	National Pollutant Discharge Elimination System (NPDES)
Compost Mat		Permits

Maneuver Corridors Site Disturbance Activities

Maneuver corridors are large scale training areas typically covering thousands of acres. In a maneuver corridor, there are a range of training exercises that occur, including impact areas and established target sites. There must be an area for large vehicles to move around unobstructed. Typically large trees, shrubs, and other debris (rocks, trash, etc.) will need to be removed within the maneuver Corridor and some regrading of the terrain may occur.* Due to the dropping of live ordinance, there will be impact areas that may spawn fires in addition to earth disturbances that will disturb vegetation and soil and create erosion opportunities within the corridor. Noise from jets and explosions is another site disturbance that occurs in maneuver corridors. In a maneuver corridor, military units spend time in a Deployment and Initial Staging phase, then move to a Combat Training, and then spend several days on recovery and redeployment activity.†

Environmental Impacts of Disturbance Activities

Maneuver corridors are subject to the compaction and erosion that is caused by large numbers of large vehicles moving through an area. Typical impacts include loss of vegetative cover, increased air-borne particulates, erosion, and compaction. The environmental impact of the types of disturbances in a maneuver corridor. Road networks and heavy tracked vehicle traffic will create areas of compaction and erosion, and will generate dust. Vegetation will be disturbed and removed, and wildlife will be displaced from normal habitat areas.

Environmental Impacts:

- Compaction
- Increased runoff
- Erosion
- Increased heat locally due to loss of vegetative cover
- Loss of habitat for plants and animals

*“The 2002 LURS found that approximately 593,041 net maneuverable acres were needed. The current maneuverable training area on Fort Irwin is 350,304 acres; this leaves a shortfall of 274,167 acres. Net maneuverable acreage is determined by taking all the off-limits areas and unusable terrain and subtracting the total from the total land acreage of the installation.”

<http://www.fortirwinlandexpansion.com/Background.htm#acreage>

† <http://www.fortirwinlandexpansion.com/PDFs/NTC%20Land%20Expansion%20Article.pdf>

Appropriate LID tools for correcting environmental problems in Maneuver Corridors

Vegetated Low Impact Development (LID) tools are appropriate for use adjacent to maneuver corridors because they are constructed of readily available materials, can be designed and constructed in a short amount of time with minimal training and mobilization, and are highly effective at treating or reducing any

potential pollutants. They are not to be used as spill prevention or if there is a release of contaminants. Any spill of potential contaminant must be immediately contained and reported Recommended LID tools that can be used for training areas include:

- Site Fingerprinting.
- Bioretention cells.
- Bioretention strips.
- Vegetated swales.
- Grass-lined swales.
- Reforestation/Afforestation.*

LID tools can be used as stand alone facilities or linked to other LID devices such as surface storage areas (e.g., depressed open field), seepage pits or reforestation areas. Locate close to the source of the water runoff and size for the watershed that is being drained. LID tools are not to be used to mitigate chemical spills or other gross scale hazardous materials contamination problems. Such should be reported and dealt with according to hazardous materials protocols.

Listed below is a description of each technology – how, where, and when it is appropriate to be used.

Construction Phase

- Site fingerprinting.
 - N Field evaluation of the areas of a site in which the type of necessary development may occur while minimizing the potential for negative environmental consequences.



Tank maneuver area is permanently non-vegetated. Runoff from these areas must be managed through LID IMPs surrounding the area.

Equipment Needed:

- Bobcat or Grader
- Hand Tools
- Hose
- Wheelbarrows
- Tarp
- Silt Fence materials
- Stakes
- Marking Flags/ Paint
- Measuring wheel or tape

* http://www.masonbruce.com/wfe/2004Program/1C3_Mark_Lichtenstein.pdf (PowerPoint™ with diagrams re: maneuver corridors in forested areas pp 8-11).

Post-Construction Phase

- Bioretention cell.
 - N An area that is designed to treat and infiltrate stormwater from an area no larger than ½ acre using natural processes in engineered soil media and plant roots to remove nutrients and other pollutants.
- Bioretention strip.
 - N Linear features that are used to treat and infiltrate stormwater adjacent to where the stormwater is generated.
- Bioswale.
 - N A swale prepared with bioretention mix designed to convey stormwater; they catch pollutants and nutrients in stormwater; they may also provide for habitat improvements for local small animal populations. Bioswales may be planted as grassy swales or as swales vegetated with wildflowers, shrubs, and small trees.
- Vegetated swales.
 - N A swale that may or may not have bioretention mix added to the native soils. It is planted with various non-turf plants, including perennials as well as ornamental grasses and woody species.
- Grass-lined swales.
 - N A swale planted with turf type grass that is mowed to a height of no less than 6 in. They filter out silt and other suspended solids and may be used in conjunction with other swales that are vegetated with bioretention cells or with woody plant materials.

Site Recovery Phase

- Afforestation/ Reforestation.
 - N Replanting trees provides vegetative cover and restores hydrologic function to an area.

Permits Required

- Construction phase: Erosion and Sedimentation Control.
- Post-Construction – NPDES.

Construction Materials Needed

Construction materials needed are typically readily available in the field. Hand tools will suffice if there is not access to earthmoving equipment although for larger excavations, heavy equipment such as a bobcat or other digging machine is desirable. In all cases appropriate erosion and sedimentation controls are needed throughout the construction process. Plant materials should be procured from local nurseries and should be selected for their ability to sustain themselves in the environment in which they are being planted – either bioretention or reforestation/ afforestation.

Installation Procedure

Bioretention Cells, Bioretention Strips, Bioswales, Afforestation/Reforestation, Compost Filter Socks, Filter Mats, and Compost Amendments are all easily installed LID tools that address sediment and nutrient problems in stormwater runoff. The sediment and erosion control procedures for installation follows standard operating procedures that are in place for all construction sites. Compliance with erosion and sedimentation rules for site construction must occur. Refer to the LID tools list for appropriate timing of tool application.

Inspection and Monitoring

The job should be checked by the project manager or the project manager's appointee at each point in the construction process:

- Site delineation.
- Excavation.
- Underdrains.

- Planting media (before and after installation).
- Plants (before and after installation).
- Mulch (before and after installation).

Monitoring stations should be installed at the time of installation, which will measure water quality and volume at the point of entry and at the point of exit from the bioretention area; a monitoring schedule should be established as part of the maintenance scheduling of the bioretention area. Data from the monitoring should be recorded and kept with the environmental officer.

Bioretention Strip
Bioretention Cell
Grassy Swale
Vegetated Swale
Site Fingerprinting
Selective Clearing



Harden and seed road shoulders on maneuver corridors and tank trails for stormwater harvesting and controlling erosion (Fort Bragg, NC).

Maintenance

- Periodic cleanup keeps the systems working; remove debris and cut back herbaceous plants (flowers and grasses) every late winter/early Spring.
- Schedule pipe clean-out maintenance and provide access points to keep the system working as designed.
- Inspect irrigation (if installed and monitor for correct performance) Inspect plants annually and remove dead plants; herbaceous plants should be cut back in late winter before the spring growth begins. Replace dead plants as necessary.
- Do Not Fertilize.
- Inspect Mulch and replace mulch annually.

Program Manager
Further Resources

Public Works or Environmental Officer
See attachments



US Army Corps
of Engineers®
Engineer Research and
Development Center

Multi-Purpose Range Complexes

Draft 06.26.2007

Key Terms

Clearing	Permanent Stabilization	Hydrologic Cycle
Grubbing	Stormwater Runoff	Temporary Stabilization
Soil Stockpile	Low Impact Development	Topographic Map
Grading	Silt Fence	Soils Map
Sediment Control	Compost Filter Sock	Compost Amendment
Wetlands	Bioswale	National Pollutant Discharge Elimination System (NPDES)
Compost Mat		Permits

Multi-purpose Range Complexes Site Disturbance Activities

In a multipurpose range complex, there are multiple training activities that occur, many involving large numbers of large equipment and personnel over large tracts of land. These tracts of land may encompass forested and wetland areas that may be disturbed by the training activities that occur on the range.

Trees, shrubs, and other debris (rocks, trash, etc.) will need to be removed within certain areas to facilitate large group gatherings, other areas will need to be cleared as access road and various training activities are set up. Top soil will be scraped and stockpiled as the terrain is graded to the appropriate level and then re-spread and stabilized in appropriate areas.

Oil and gas spills may occur, most likely in areas where vehicles are parked and / or refueled. Noise pollution may cause other environmental disruptions to nesting birds, certain mammals, and surrounding areas.

Certain areas of a multipurpose range complex will be subject to impacts from ordinance and the associated disruptions from impacts and possible fires set from such target activities.

As in the case of plan for Fort Benning, developed utility and road networks may be developed: "The project would include construction of the firing and target area, installation of fiber optics, construction of support facilities, upgrading and construction of associated roadways, installation of utilities to support the site, construction of a helipad, construction of other related equipment and facilities, and operation and maintenance of the DMPRC."*



Plan view of multipurpose range complex.

*Detailed information on the Digital Multi-Purpose Range Complex (DMPRC) is available through URL: <http://www.epa.gov/fedgrstr/EPA-IMPACT/2004/February/Day-13/i2848.htm>

Environmental Impacts of Disturbance Activities

There are multiple environmental impacts that may occur from the establishment and maintenance of a Multi-purpose Range Complex. Road networks will disrupt natural terrain, generate runoff and dust. The areas for truck parking will become compacted and subject to creating runoff during rainstorms. Erosion is likely to occur in both the paved and non-paved areas as the existing site hydrology is disrupted by loss of vegetative cover and increased compaction and soil disturbance from training activities.

Migratory birds and other wildlife may be impacted due to increased pressure on habitats, loss of habitat and increased human and vehicular traffic in an area in addition to the noise generated by range firing practices.

The nature of the Multi-Purpose Training Range (MPTR) at Camp Atterbury in Indiana is typical: "Issues pertaining to noise, water quality and quantity, soil condition, air quality, deposition of hazardous materials and wastes and impacts on the public health of the residents of areas adjacent to the range are likely to occur. The proposed action is to construct and operate at MPTR that would support tanks, attack helicopters, Infantry Fighting Vehicles, and a dismounted infantry platoon battle course."*

Appropriate LID Tools for Correcting Environmental Problems at Multipurpose Range Complexes

Vegetated Low Impact Development (LID) tools are appropriate for use adjacent to Multipurpose Range Complexes. These are linear small scale stormwater control devices, which improve water quality and reduce runoff volume. They are vegetated with plants that are tolerant of a range of moisture regimes. They are flexible in their shape, scale and location and can be quickly constructed to mitigate certain classes of water quality problems.

- Bioretention cells.
- Bioretention strips.
- Vegetated swales.
- Grass-lined swales.
- Afforestation/ Reforestation.

LID tools can be used as stand alone facilities or linked to other LID devices such as surface storage areas (e.g., depressed open field), seepage pits or reforestation areas. Locate close to the source of the water runoff and size for the watershed that is being drained.

Recommended LID tools that can be used for training areas include:

Environmental Impacts:

- Compaction
- Increased runoff
- Erosion
- Increased heat locally due to loss of vegetative cover
- Loss of habitat for plants and animals
- Wetland degradation
- Forest degradation
- Noise
- Air Quality
- Degraded water quality

* <http://www.epa.gov/fedrgstr/EPA-IMPACT/1999/January/Day-21/i1343.htm>

Construction Phase

- Site fingerprinting.
 - N Field evaluation of the areas of a site in which the type of necessary development may occur while minimizing the potential for negative environmental consequences.
- Selective grading.
 - N Grading done after a site analysis that selectively reshapes the earth to accommodate the desired development while leaving other areas on the site undisturbed.
- Compost Filter Sock.
 - N Used for streambank stabilization and temporary filters to protect inlets to storm drains.

Post-Construction Phase

- Bioretention cell.
 - N An area that is designed to treat and infiltrate stormwater from an area no larger than ½ acre using natural processes in engineered soil media and plant roots to remove nutrients and other pollutants.
- Bioretention strip.
 - N Linear features that are used to treat and infiltrate stormwater adjacent to where the stormwater is generated.
- Bioswale.
 - N A swale prepared with bioretention mix designed to convey stormwater; they catch pollutants and nutrients in stormwater; they may also provide for habitat improvements for local small animal populations. Bioswales may be planted as grassy swales or as swales vegetated with wildflowers, shrubs, and small trees.
- Vegetated swales.
 - N A swale that may or may not have bioretention mix added to the native soils. It is planted with various non-turf plants, including perennials as well as ornamental grasses and woody species.
- Grass-lined swales.
 - N A swale planted with turf type grass that is mowed to a height of no less than 6 in. They filter out silt and other suspended solids and may be used in conjunction with other swales that are vegetated with bioretention cells or with woody plant materials.

Equipment Needed:

- Bobcat or Grader
- Hand Tools
- Hose
- Wheelbarrows
- Tarp
- Silt Fence materials
- Stakes
- Marking Flags/ Paint
- Measuring wheel or tape

Site Recovery Phase

- Afforestation/ Reforestation.
 - N Replanting trees provides vegetative cover and restores hydrologic function to an area.*

Permits Required

- Construction phase: Erosion and Sedimentation Control.
- Post-Construction – National Pollutant Discharge Elimination System (NPDES).

*The volume of water to be stored may be determined through the use of ARMSED (Army Multiple Watershed Storm Water and Sediment Runoff), a Runoff and Sediment Yield Model for Army Training Land Watershed Management. Volume 1. Parameter Estimation Guide.

Construction Materials Needed

Construction materials needed are typically readily available in the field. Hand tools will suffice if there is not access to earthmoving equipment although for larger excavations, heavy equipment such as a bobcat or other digging machine is desirable. In all cases appropriate erosion and sedimentation controls are needed throughout the construction process. Plant materials should be procured from local nurseries and should be selected for their ability to sustain themselves in the environment in which they are being planted – either bioretention or reforestation/ afforestation.

Installation Procedure

Bioretention Cells, Bioretention Strips, Bioswales, Afforestation/Reforestation, Compost Filter Socks, Filter Mats, and Compost Amendments are all easily installed LID tools that address sediment and nutrient problems in stormwater runoff. The sediment and erosion control procedures for installation follows standard operating procedures that are in place for all construction sites. Compliance with erosion and sedimentation rules for site construction must occur. Refer to the LID tools list for appropriate timing of tool application.

Inspection and Monitoring

The job should be checked by the project manager or the project manager's appointee at each point in the construction process:

- Site delineation.
- Excavation.
- Underdrains.
- Planting media (before and after installation).
- Plants (before and after installation).
- Mulch (before and after installation).

Monitoring Stations should be installed at the time of installation, which will measure water quality and volume at the point of entry and at the point of exit from the bioretention area; a monitoring schedule should be established as part of the maintenance scheduling of the bioretention area. Data from the monitoring should be recorded and kept with the environmental officer.

- Bioretention Strip
- Bioretention Cell
- Grassy Swale
- Vegetated Swale
- Site Fingerprinting
- Selective Clearing



Newly constructed bioretention cell at Fort Bragg, NC.

Maintenance

- Periodic cleanup keeps the system working; remove debris and cut back herbaceous plants (flowers and grasses) every late winter/early Spring from bioretention and swale areas.

- Schedule pipe clean-out maintenance and provide access points to keep the system working as designed.
- Inspect any irrigation systems implemented on a regular basis.
- Do Not Fertilize.
- Inspect Mulch and replace mulch annually.
- Inspect plant materials annually and maintain as needed; replace dead plants.

Regional Concerns

Impacts on the environment will vary greatly depending on the climate and soils and terrain of a region. Bioretention areas are more or less effective depending on a variety of factors: climate, soil type, correctness of sizing, correctness of construction, level of maintenance. Other LID tools, such as Reforestation, are appropriate for all climate factors, but the particular approach must be adapted to local conditions.

**Program Manager
Further Resources**

Public Works or Environmental Officer
See Technology Sheets

PWTB 200-1-62
1 October 2008



**US Army Corps
of Engineers®**
Engineer Research and
Development Center

Secondary Roads Draft 06.26.2007

Key Terms

Clearing	Permanent Stabilization	Hydrologic Cycle
Grubbing	Stormwater Runoff	Temporary Stabilization
Soil Stockpile	Low Impact Development	Topographic Map
Grading	Silt Fence	Soils Map
Sediment Control	Compost Filter Sock	Compost Amendment
Wetlands	Bioswale	National Pollutant Discharge Elimination System (NPDES)
Compost Mat		Permits

Secondary Roads Site Disturbance Activities

Secondary Roads disturb vegetation, watercourses, and existing grades as they are established. Heavy grading equipment will be used to shape the road bed and shoulders. Trees, shrubs, and other debris (rocks, trash, etc.) will need to be removed within secondary road corridors and top soil will be scraped, stockpiled, and stabilized as the terrain is graded to the appropriate level. Low Impact Development (LID) tools may cause some temporary disturbance to a site during construction if they are those that require excavation or grading.



Environmental Impacts of Disturbance Activities

Road construction requires clearing of all vegetation within the right of way (20 ft min), scraping and grading of the surface and stabilization of the road base. The road creation generates runoff water and causes there to be an increased opportunity for runoff to develop sufficient momentum to create scouring and to erode the earth's surface. Stream crossings and steep slopes create likely areas for soil erosion. After construction, unpaved road surfaces generate dust in dry weather and mud in wet weather, exacerbated by the typical truck traffic on the road.

Environmental Impacts:

- Compaction
- Increased runoff
- Erosion – water and wind caused
- Increased heat locally due to loss of vegetative cover
- Loss of habitat for plants and animals

Appropriate LID Tools for Correcting Environmental Problems along Secondary Roads

Vegetated LID tools are appropriate for use adjacent to secondary roads because they are constructed of readily available materials, can be designed and constructed in a short amount of time with minimal training and mobilization, and are highly effective at treating or reducing any potential pollutants. They are not to be used as spill prevention or if there is a release of contaminants. Any spill of potential contaminant must be immediately contained and reported. Recommended LID tools that can be used for secondary roads include:

- Site fingerprinting.

- Selective grading.
- Compost Filter Sock.
- Bioretention cells.
- Bioretention strips.
- Vegetated swales.
- Grass-lined swales.

Recommended LID tools that can be used for secondary roads include:

Construction Phase

- Site fingerprinting.
 - N Field evaluation of the areas of a site in which the type of necessary development may occur while minimizing the potential for negative environmental consequences.
- Selective grading.
 - N Grading done after a site analysis that selectively reshapes the earth to accommodate the desired development while leaving other areas on the site undisturbed.
- Compost Filter Sock.
 - N Used for streambank stabilization and temporary filters to protect inlets to storm drains.

Post-Construction Phase

- Bioretention cell.
 - N An area that is designed to treat and infiltrate stormwater from an area no larger than ½ acre using natural processes in engineered soil media and plant roots to remove nutrients and other pollutants.
- Bioretention strip.
 - N Linear features that are used to treat and infiltrate stormwater adjacent to where the stormwater is generated.
- Bioswale.
 - N A swale prepared with bioretention mix designed to convey stormwater; they catch pollutants and nutrients in stormwater; they may also provide for habitat improvements for local small animal populations. Bioswales may be planted as grassy swales or as swales vegetated with wildflowers, shrubs, and small trees.
- Vegetated swales.
 - N A swale that may or may not have bioretention mix added to the native soils. It is planted with various non-turf plants, including perennials as well as ornamental grasses and woody species.
- Grass-lined swales.
 - N A swale planted with turf type grass that is mowed to a height of no less than 6 in. They filter out silt and other suspended solids and may be used in conjunction with other swales that are vegetated with bioretention cells or with woody plant materials.

Permits Required

- Construction phase: Erosion and Sedimentation Control.
- Post-Construction – National Pollutant Discharge Elimination System (NPDES).

Equipment Needed:

- Bobcat or Grader
- Hand Tools
- Hose
- Wheelbarrows
- Tarp
- Silt Fence materials
- Stakes
- Marking Flags/ Paint
- Measuring wheel or tape

Construction Materials Needed

Construction materials needed are typically readily available in the field. Hand tools will suffice if there is not access to earthmoving equipment although for larger excavations, heavy equipment such as a bobcat or other digging machine is desirable. In all cases appropriate erosion and sedimentation controls are needed throughout the construction process. Plant materials should be procured from local nurseries and should be selected for their ability to sustain themselves in the environment in which they are being planted, either bioretention or reforestation/afforestation.

Installation Procedure

Bioretention Cells, Bioretention Strips, Bioswales, Vegetated Swales, Grassy Swales and Compost Filter Socks, are all easily installed LID tools that address sediment and nutrient problems in stormwater runoff. The sediment and erosion control procedures for installation follows standard operating procedures that are in place for all construction sites. Compliance with erosion and sedimentation rules for site construction must occur. Refer to the LID tools list for appropriate timing of tool application.

Inspection and Monitoring

The job should be checked by the project manager or the project manager's appointee at each point in the construction process:

- Site delineation.
- Excavation.
- Underdrains.
- Planting media (before and after installation).
- Plants (before and after installation).
- Mulch (before and after installation).

Monitoring Stations should be installed at the time of installation, which will measure water quality and volume at the point of entry and at the point of exit from the bioretention area; a monitoring schedule should be established as part of the maintenance scheduling of the bioretention area. Data from the monitoring should be recorded and kept with the environmental officer.

**Bioretention Strip
Bioretention strips
Vegetated swales
Grass-lined swales**



Example improved secondary roads at Fort Benning, GA.

- Maintenance**
- Periodic cleanup keep systems working; remove debris and cut back herbaceous plants (flowers and grasses) every late winter/early Spring.
 - Schedule pipe clean-out maintenance and provide access points to keep the system working as designed.
 - Do Not Fertilize.
 - Inspect Mulch and replace mulch annually by hand.

Regional Concerns

Impacts on the environment will vary greatly depending on the climate and soils and terrain of a region. Bioretention areas are more or less effective depending on a variety factors: climate, soil type, correctness of sizing, correctness of construction, level of maintenance. Other LID tools, such as Reforestation, are appropriate for all climate factors, but the particular approach must be adapted to local conditions.

See: Climate chart in *Appendix 1*

Program Manager

Public Works or Environmental Officer

Further Resources

See Technology Sheets



**US Army Corps
of Engineers®**
Engineer Research and
Development Center

Small Weapons Firing Ranges

Draft 06.26.2007

Key Terms

Clearing	Permanent Stabilization	Hydrologic Cycle
Grubbing	Stormwater Runoff	Temporary Stabilization
Soil Stockpile	Low Impact Development	Topographic Map
Grading	Silt Fence	Soils Map
Sediment Control	Compost Filter Sock	Compost Amendment
Wetlands	Bioswale	Site Fingerprinting
Compost Mat	Downspout disconnection/rain barrels	National Pollutant Discharge Elimination System (NPDES) Permits

Small Weapons Firing Ranges Site Disturbance Activities

In a Small Weapons Firing Range area, there is an area created for standing target shooting. These galleries, which may be roofed, are cleared areas with stationary targets.

Trees, shrubs, and other debris (rocks, trash, etc.) will need to be removed within the shooting lanes. Other areas within the small weapons firing range site may include field target practice with a series of obstacles. The set up of the range activity requires site grading, shelter construction and target installations. Additional area for parking may be cleared and graded.

Shooting galleries may be cleared up to 2100 meters in length depending on weapons being fired and terrain. A typical rifle range shooting lane is 25m long and 4m wide with a berm at the end of the lane. The automated ranges are larger and typically have 32 firing lanes, each 15m wide with pop-up targets at 75, 175 and 300m. Combat pistol ranges are shorter (31m) and 8m wide with pop-up targets at 7 specified distances. Shotgun ranges have a range of distance covered with shot reaching as far as 770 ft range and fanning out to a possible spread of 250 ft from a single point of firing. Several stations may be set up side by side on a shot-gun firing range. On skeet ranges, the spread is typically between 375-600 ft in distance from the shooter and about 500 ft in width. "The theoretical shot fall zone is approximately 14



Environmental Impacts:

- Compaction
- Increased runoff
- Erosion
- Increased heat locally due to loss of vegetative cover
- Loss of habitat for plants and animals
- Heavy Metal build up in soils
- Dust from impacts repeatedly in the same place

Environmental Impacts of Disturbance Activities

acres with about 2 acres added with each additional overlapping field.”*
Noise is another major concern associated with firing ranges and will vary depending on the type of weapons and number of weapons being fired.

Erosion, dust and compaction are key negative environmental impacts from the practices on Small Weapons Firing Ranges. In addition, lead is a major environmental contaminant to mitigate on firing ranges.[†] Other contaminants potentially found include lead styphanate/lead azide, antimony, antimony sulfide, arsenic, copper, bismuth, tin, zinc, iron, tungsten, nickel, cobalt and chromium, and polycyclic aromatic hydrocarbons (PAHs)[‡] Soil pH will influence contaminant solubility and depth to groundwater will determine the relative risk to the groundwater from the range activities.

Appropriate LID Tools for Correcting Environmental Problems along Secondary Roads

Vegetated Low Impact Development (LID) tools are appropriate for use adjacent to Small Weapons Firing Ranges. LID tools utilize natural processes and are well suited to removing heavy metals as well as other pollutants and nutrients. LID tools are small scale decentralized stormwater control devices that improve water quality and reduce runoff volume. They can be strategically placed close to sources of stormwater generation and are compatible with Small Weapons Firing Range practices. They are vegetated with plants that are tolerant of a range of moisture regimes.

- Bioretention cells.
- Bioretention strips.
- Bioswale.
- Vegetated swales.
- Grass-lined swales.
- Permeable pavement or Geoweb.
- Site Fingerprinting.
- Compost Filter Sock.
- Downspout Disconnection/ Rain Barrels.

LID tools can be used as stand alone facilities or linked to other LID devices such as surface storage areas (e.g., depressed open field), seepage pits or reforestation areas. Locate close to the source of the water runoff and size for the watershed that is being drained.

Recommended LID tools that can be used for Small Weapons Firing Ranges include:

Construction Phase

- Site fingerprinting.
 - N Field evaluation of the areas of a site in which the type of necessary development may occur while minimizing the potential for negative environmental consequences.
- Compost Filter Sock.
 - N Used for streambank stabilization and temporary filters to protect inlets to storm drains.

Post-Construction Phase

- Bioretention cell.

* Environmental Management at Operating Outdoor Small Arms Firing Ranges, pdf, pp 27 -30, <http://www.itrcweb.org/Documents/SMART-2.pdf>

† Environmental Management at Operating Outdoor Small Arms Firing Ranges, pdf, <http://www.itrcweb.org/Documents/SMART-2.pdf>

‡ Environmental Management at Operating Outdoor Small Arms Firing Ranges, pdf, p 16, Table 2.1 “Contaminants potentially found at ranges” <http://www.itrcweb.org/Documents/SMART-2.pdf>

- N An area that is designed to treat and infiltrate stormwater from an area no larger than ½ acre using natural processes in engineered soil media and plant roots to remove heavy metals, nutrients and other pollutants.
- Bioretention strip.
 - N Linear features that are used to treat and infiltrate stormwater adjacent to where the stormwater is generated They are very effective at removing heavy metals in addition to pollutant and nutrient removal.
- Bioswale.
 - N A swale prepared with bioretention mix designed to convey stormwater; they catch pollutants and nutrients in stormwater; they may also provide for habitat improvements for local small animal populations. Bioswales may be planted as grassy swales or as swales vegetated with wildflowers, shrubs, and small trees. They are very effective at removing heavy metals in addition to pollutant and nutrient removal.
- Vegetated swales.
 - N A swale that may or may not have bioretention mix added to the native soils. It is planted with various non-turf plants, including perennials as well as ornamental grasses and woody species. They are very effective at removing pollutants and nutrients.
- Grass-lined swales.
 - N A swale planted with turf type grass that is mowed to a height of no less than 6 in. They filter out silt and other suspended solids and may be used in conjunction with other swales that are vegetated and/or with bioretention cells or with woody plant materials.
- Downspout Disconnection/ Rain Barrels.
 - N A covered small weapons firing range will generate runoff from the roof areas. This runoff may be managed through “disconnecting the downspout” (i.e., routing the water into a specified area that is not a storm drain or waterway) and using a rain barrel to capture the water. Water captured by the rain barrels may be released at a later date either into a bioretention area or other vegetated area.

Permits Required

- Construction phase: Erosion and Sedimentation Control.
- Post-Construction – National Pollutant Discharge Elimination System (NPDES).

Construction Materials Needed

Construction materials needed are typically readily available in the field. Hand tools will suffice if there is not access to earthmoving equipment although for larger excavations, heavy equipment such as a bobcat or other digging machine is desirable. In all cases appropriate erosion and sedimentation controls are needed throughout the construction process. Plant materials should be procured from local nurseries and should be selected for their ability to sustain themselves in the environment in which they are being planted.

Equipment Needed:

- Bobcat or Grader
- Hand Tools
- Hose
- Wheelbarrows
- Tarp
- Silt Fence materials
- Stakes
- Marking Flags/ Paint
- Measuring wheel or tape

Installation Procedure

Bioretention Cells, Bioretention Strips, Bioswales, Afforestation/Reforestation, Compost Filter Socks, Filter Mats, and Compost Amendments are all easily installed LID tools that address sediment and nutrient problems in stormwater runoff. The sediment and erosion control procedures for installation follows standard operating procedures that are in place for all construction sites. Compliance with erosion and

Inspection and Monitoring

sedimentation rules for site construction must occur. Refer to the LID tools list for appropriate timing of tool application. The job should be checked by the project manager or the project manager's appointee at each point in the construction process:

- Site delineation.
- Excavation.
- Underdrains.
- Planting media (before and after installation).
- Plants (before and after installation).
- Mulch (before and after installation).

Monitoring Stations should be installed at the time of installation, which will measure water quality and volume at the point of entry and at the point of exit from the bioretention area; a monitoring schedule should be established as part of the maintenance scheduling of the bioretention area. Data from the monitoring should be recorded and kept with the environmental officer.

Bioretention Strip Bioretention strips Vegetated swales Grass-lined swales



LID practices in place at small weapons firing range.

Maintenance

- Periodic basin cleanup keeps the system working; remove debris and cut back herbaceous plants (flowers and grasses) every late winter/early Spring.
- Schedule pipe clean-out maintenance and provide access points to keep the system working as designed.
- Do Not Fertilize.
- Inspect Mulch and replace mulch annually.

Regional Concerns

Impacts on the environment will vary greatly depending on the climate and soils and terrain of a region. Bioretention areas are more or less effective depending on a variety factors: climate, soil type, correctness of sizing, correctness of construction, level of maintenance. Other LID tools, such as Reforestation, are appropriate for all climate factors, but the particular approach must be adapted to local conditions.

See: Climate Chart in Appendix 1

Program Manager

Public Works or Environmental Officer

Further Resources

See Technology Sheets



**US Army Corps
of Engineers®**
Engineer Research and
Development Center

Tank Trails

Draft 06.26.2007

Key Terms

Clearing	Permanent Stabilization	Hydrologic Cycle
Grubbing	Stormwater Runoff	Temporary Stabilization
Soil Stockpile	Low Impact Development	Topographic Map
Grading	Silt Fence	Soils Map
Sediment Control	Compost Filter Sock	Compost Amendment
Wetlands	Bioswale	National Pollutant Discharge Elimination System (NPDES)
Compost Mat		Permits

Tank Trails Site Disturbance Activities

Tank trails are typically unpaved linear disturbance features in the landscape. The unpaved surface is susceptible to wind erosion as well as water erosion during rainstorms. In addition, low water crossing points are subject to erosion and may severely degrade water quality if not appropriately constructed.*

Trees, shrubs, and other debris (rocks, trash, etc.) will need to be removed at the time of establishment.† In more arid environments, tank trails disrupt the local soil and vegetation conditions and due to lack of water, the environment is slow to recover.

Environmental Impacts of Disturbance Activities

Dust and erosion and ground ruts are typical environmental consequences of tank trail use, particularly in arid environments. Lack of clear delineation of travel ways and intersections promotes wider spread environmental damage as corners are cut and shortcuts are made. Low level crossing areas in streams are another water quality issue as the sediments stirred up and get transported in stream water and other



Environmental Impacts:

- Compaction
- Increased runoff
- Erosion – Wind and water
- Increased heat locally due to loss of vegetative cover
- Loss of habitat for plants and animals
- Stream siltation at crossing points
- Erosion at heavily trafficked intersections
- Noise

* <http://proceedings.ndia.org/JSEM2006/Wednesday/Conway.pdf> – images of tank crossings which are not environmentally sound plus details re: How to fix problem created by tank trails.

† http://www.forester.net/ecm_0211_environmentally.html (article on Fort Bliss)

**Appropriate LID Tools
for Correcting
Environmental
Problems along
Secondary Roads**

runoff that leads to streams. Noise from Tank Traffic can have an impact on the surrounding areas both on wildlife and adjacent human uses.

Vegetated Low Impact Development (LID) tools are appropriate for use adjacent to tank trails. These are linear small scale stormwater control devices that improve air quality, water quality and reduce runoff volume. They are vegetated with plants that are tolerant of a range of moisture regimes.

- Site fingerprinting.
- Compost Filter Sock.
- Bioretention cells.
- Bioretention strips.
- Vegetated swales.
- Grass-lined swales.
- Reforestation.

LID tools can be used as stand alone facilities or linked to other LID devices such as surface storage areas (e.g., depressed open field), seepage pits or reforestation areas. Locate close to the source of the water runoff and size for the watershed that is being drained. Irrigate if necessary (as in an arid environment). The majority of LID tools that are most applicable for Tank Trails would be installed in the post-construction phase of Tank Trail development.

Construction Phase

- Site fingerprinting.
 - N Field evaluation of the areas of a site in which the type of necessary development may occur while minimizing the potential for negative environmental consequences.
- Compost Filter Sock.
 - N Used for streambank stabilization and temporary filters to protect inlets to storm drains.

Post-Construction Phase

- Bioretention cell.
 - N An area that is designed to treat and infiltrate stormwater from an area no larger than ½ acre using natural processes in engineered soil media and plant roots to remove nutrients and other pollutants.
- Bioretention strip.
 - N Linear features that are used to treat and infiltrate stormwater adjacent to where the stormwater is generated.
- Bioswale.
 - N A swale prepared with bioretention mix designed to convey stormwater; they catch pollutants and nutrients in stormwater; they may also provide for habitat improvements for local small animal populations. Bioswales may be planted as grassy swales or as swales vegetated with wildflowers, shrubs, and small trees.
- Vegetated swales.
 - N A swale that may or may not have bioretention mix added to the native soils. It is planted with various non-turf plants, including perennials as well as ornamental grasses and woody species.
- Grass-lined swales.

Equipment Needed:

- Bobcat or Grader
- Hand Tools
- Hose/Water
- Wheelbarrows
- Tarp
- Silt Fence materials
- Stakes
- Marking Flags/ Paint
- Measuring wheel or tape

N A swale planted with turf type grass that is mowed to a height of no less than 6 in. They filter out silt and other suspended solids and may be used in conjunction with other swales that are vegetated with bioretention cells or with woody plant materials.

➤ Reforestation.

N Areas adjacent to the tank trail may require reforestation plantings if there are noise and dust abatement concerns from the tank trails and the climate will permit the establishment of a forested area. For noise buffering, a reduction of 3-5dB(A)/100 ft of depth from a sound source may be achieved with dense plantings of trees and shrubs.*

Site Recovery Phase

➤ Afforestation/ Reforestation.

N Replanting trees provides vegetative cover and restores hydrologic function to an area.

Permits Required

- Construction phase: Erosion and Sedimentation Control.
- Post-Construction – National Pollutant Discharge Elimination System (NPDES).

Construction Materials Needed

Construction materials needed are typically readily available in the field. Hand tools will suffice if there is not access to earthmoving equipment although for larger excavations, heavy equipment such as a bobcat or other digging machine is desirable. In all cases appropriate erosion and sedimentation controls are needed throughout the construction process. Plant materials should be procured from local nurseries and should be selected for their ability to sustain themselves in the environment in which they are being planted, either bioretention or reforestation/ afforestation.

Installation Procedure

Bioretention Cells, Bioretention Strips, Bioswales, Afforestation/Reforestation, Compost Filter Socks, Filter Mats, and Compost Amendments are all easily installed LID tools that address sediment and nutrient problems in stormwater runoff. The sediment and erosion control procedures for installation follows standard operating procedures that are in place for all construction sites. Compliance with erosion and sedimentation rules for site construction must occur. Refer to the LID tools list for appropriate timing of tool application.

Inspection and Monitoring

The job should be checked by the project manager or the project manager's appointee at each point in the construction process:

- Site delineation.
- Excavation.
- Underdrains.
- Planting media (before and after installation).
- Plants (before and after installation).
- Mulch (before and after installation).

Monitoring Stations should be installed at the time of installation, which will measure water quality and volume at the point of entry and at the point of exit from the bioretention area; a monitoring schedule should be established as part of the maintenance scheduling of the bioretention area. Data from the monitoring should be recorded and kept with the environmental officer.

*Harris, Charles and Dines, Nicholas T. (1998) Time Saver Standards for Landscape Architecture, p. 660-7, 6.6, McGraw-Hill, Washington, DC

Bioretention Strip
Bioretention strips
Vegetated swales
Grass-lined swales



Insert pictures of LID tools in practice in DOD installations.

Maintenance

- Periodic cleanup keeps the system working; remove debris and cut back herbaceous plants (flowers and grasses) every late winter/early spring from bioretention and swale areas.
- Schedule pipe clean-out maintenance and provide access points to keep the system working as designed.
- Inspect any irrigation systems implemented on a regular basis.
- Do Not Fertilize.
- Inspect Mulch and replace mulch annually.
- Inspect plant materials annually and maintain as needed; replace dead plants.

Regional Concerns

Impacts on the environment will vary greatly depending on the climate and soils and terrain of a region. Bioretention areas are more or less effective depending on a variety of factors: climate, soil type, correctness of sizing, correctness of construction, level of maintenance. Other LID tools, such as Reforestation, are appropriate for all climate factors, but the particular approach must be adapted to local conditions.

Program Manager

Public Works or Environmental Officer

Further Resources

See Technology Sheets



**US Army Corps
of Engineers®**
Engineer Research and
Development Center

Tracked Vehicle Driver Training Sites Draft 06.26.2007

Key Terms

Clearing	Permanent Stabilization	Hydrologic Cycle
Grubbing	Stormwater Runoff	Temporary Stabilization
Soil Stockpile	Low Impact Development	Topographic Map
Grading	Silt Fence	Soils Map
Sediment Control	Compost Filter Sock	Compost Amendment
Wetlands	Bioswale	National Pollutant Discharge Elimination System (NPDES)
Compost Mat		Permits

Tracked Vehicle Driver Training Sites Disturbance Activities

Large Trees, shrubs, and other debris (rocks, trash, etc.) will need to be removed within the training site and top soil will be scraped and stockpiled as the terrain is graded to the appropriate level. This can be done using a



combination of a York Rake to remove large rocks and roots, and a Bulldozer. If additional grading is required to level the area, the topsoil should be stockpiled to the side and stabilized with a temporary cover crop so that the topsoil is not wasted. Trees, shrubs, and other debris (rocks, trash, etc.) will be disturbed within the training zone above and beyond the area that will initially be cleared and be scraped in preparation for creating a training terrain. Ruts in roads and non road areas will be created, particularly in wet weather. Large tanks, such as the 16-ft wide Battle Tank, can drive over relatively large trees and can cut a swath through an existing forest as drivers learn to handle the machine.

Large trucks bringing trainees to and from an area may spill grease and/or oil in addition to the compaction that repeated driving on the same area causes.

Environmental Impacts of Disturbance Activities

Tracked Vehicle Driver Training Sites are subject to soil surface disruption, compaction, and loss of ground level vegetation and cover. This can lead to increased erosion and loss of habitat for ground dwelling animals and plants. Dirt roads that deliver trainees to and from training exercises may be subject to wind and water erosive forces. Forest disruption occurs if a large vehicle mows down trees and creates opportunities for erosion, loss of infiltration and increased runoff due to the loss of forest cover. Low Impact Development (LID) tools may cause some temporary disturbance to a site during construction if they are those that require excavation or grading.

Environmental Impacts:

- Soil disturbance
- Compaction
- Increased runoff
- Erosion
- Increased heat locally due to loss of vegetative cover
- Loss of habitat for plants and animals
- Noise

**Appropriate LID Tools
for Correcting
Environmental
Problems along
Secondary Roads**

Vegetated LID tools are appropriate for use adjacent to Tracked vehicle Driver Training Sites because they are constructed of readily available materials, can be designed and constructed in a short amount of time with minimal training and mobilization, and are highly effective at treating or reducing any potential pollutants. They are not to be used as spill prevention or if there is a release of contaminants. Any spill of potential contaminant must be immediately contained and reported. Site Fingerprinting and selective grading may be used to effectively zone driving training areas to create a sequence of increasing navigation difficulty for trainees to negotiate while reducing the negative environmental impacts of the training activities. Recommended LID tools that can be used for training areas include:

Construction Phase:

- Site fingerprinting.
 - N Field evaluation of the areas of a site in which the type of necessary development may occur while minimizing the potential for negative environmental consequences.
- Selective grading.
 - N Grading done after a site analysis that selectively reshapes the earth to accommodate the desired development while leaving other areas on the site undisturbed.
- Compost Filter Sock.
 - N Used for streambank stabilization and temporary filters to protect inlets to storm drains.

Post-Construction Phase:

- Bioretention cell.
 - N An area that is designed to treat and infiltrate stormwater from an area no larger than ½ acre using natural processes in engineered soil media and plant roots to remove nutrients and other pollutants.
- Bioretention strip.
 - N Linear features that are used to treat and infiltrate stormwater adjacent to where the stormwater is generated.
- Bioswale.
 - N A swale prepared with bioretention mix designed to convey stormwater; they catch pollutants and nutrients in stormwater; they may also provide for habitat improvements for local small animal populations. Bioswales may be planted as grassy swales or as swales vegetated with wildflowers, shrubs, and small trees.
- Vegetated swales.
 - N A swale that may or may not have bioretention mix added to the native soils. It is planted with various non-turf plants, including perennials as well as ornamental grasses and woody species.
- Grass-lined swales.
 - N A swale planted with turf type grass that is mowed to a height of no less than 6 in. They filter out silt and other suspended solids and may be used in conjunction with other swales that are vegetated with bioretention cells or with woody plant materials.
- Reforestation.
 - N Areas adjacent to the Tracked Vehicle Driver Training Sites may require reforestation plantings if there are noise and dust abatement concerns from the tank trails and the climate will permit the establishment of a forested area. For

noise buffering, a reduction of 3-5dB(A)/100 ft of depth from a sound source may be achieved with dense plantings of trees and shrubs.*

Site Recovery Phase**

- Afforestation/ Reforestation.
 - N Replanting trees provides vegetative cover and restores hydrologic function to an area.

Permits Required

- Construction phase: Erosion and Sedimentation Control.
- Post-Construction – National Pollutant Discharge Elimination System (NPDES).

Construction Materials Needed

Construction materials needed are typically readily available in the field. Hand tools will suffice if there is not access to earthmoving equipment although for larger excavations, heavy equipment such as a bobcat or other digging machine is desirable. In all cases appropriate erosion and sedimentation controls are needed throughout the construction process. Plant materials should be procured from local nurseries and should be selected for their ability to sustain themselves in the environment in which they are being planted, either bioretention or reforestation/ afforestation.

Equipment Needed:

- Bobcat or Grader
- Hand Tools
- Hose
- Wheelbarrows
- Tarp
- Silt Fence materials
- Stakes
- Marking Flags/ Paint
- Measuring wheel or tape

Installation Procedure

Bioretention Cells, Bioretention Strips, Bioswales, Afforestation/Reforestation, Compost Filter Socks, Filter Mats, and Compost Amendments are all easily installed LID tools that address sediment and nutrient problems in stormwater runoff. The sediment and erosion control procedures for installation follows standard operating procedures that are in place for all construction sites. Compliance with erosion and sedimentation rules for site construction must occur. Refer to the LID tools list for appropriate timing of tool application.

Inspection and Monitoring

The job should be checked by the project manager or the project manager's appointee at each point in the construction process:

- Site delineation.
- Excavation.
- Underdrains.
- Planting media (before and after installation).
- Plants (before and after installation).
- Mulch (before and after installation).

Monitoring Stations should be installed at the time of installation, which will measure water quality and volume at the point of entry and at the point of exit from the bioretention area; a monitoring schedule should be established as part of the maintenance scheduling of the bioretention area. Data from the monitoring should be recorded and kept with the environmental officer.

* Harris, Charles and Dines, Nicholas T. (1998) Time Saver Standards for Landscape Architecture, p. 660-7, 6.6, McGraw-Hill, Washington, DC.

Bioretention Strip
Bioretention strips
Vegetated swales
Grass-lined swales



Tracked vehicle training impacts on unimproved site.

Maintenance

- Periodic cleanup keeps the system working; remove debris and cut back herbaceous plants (flowers and grasses) every late winter/early Spring.
- Schedule pipe clean-out maintenance and provide access points to keep the system working as designed.
- Do Not Fertilize.
- Inspect Mulch and replace mulch annually.
- Inspect plant materials annually; replace or prune as needed.

Regional Concerns

Impacts on the environment will vary greatly depending on the climate and soils and terrain of a region. Bioretention areas are more or less effective depending on a variety factors: climate, soil type, correctness of sizing, correctness of construction, level of maintenance. Other LID tools, such as Reforestation, are appropriate for all climate factors, but the particular approach must be adapted to local conditions.

See: Climate Chart in *Appendix E1*.

Program Manager

Public Works or Environmental Officer.

Further Resources

See Technology Sheets.



US Army Corps
of Engineers®
Engineer Research and
Development Center

Bioretention Technology

Draft 06.29.2007

How Bioretention Works

Bioretention areas are useful to treat areas that have high runoff potential and non-point source pollutant loads from vehicles. Bioretention is an Low Impact Development (LID) tool that uses the physical, chemical, and biological processes in plants and soils to absorb and treat pollutants and help maintain the hydrologic, or water balance of an area. The pollutants, such as oil and grease or metals from machinery are absorbed by the soils and plants and treated. The volume of runoff is also absorbed by the soils and plants, which reduces the pollutant loads.

Bioretention can be in the form of cells or swales. The bioswales are designed to collect sheet flow of runoff from small lengths of drainage to help absorb water and then convey the excess runoff from storms. The drainage area to a swale should typically be less than 100 ft in length and no more than 1 acre of drainage. Bioretention cells are designed to treat stormwater from small drainage areas that drain directly to them. The cells are typically 40 x 60 ft to treat an area of pavement or compacted soils of about ½ acre. The cells and bioswales have a specially designed mix of soils and plants that tolerate wet and dry conditions. There is typically an underdrain of stone and perforated drainage pipe that conveys the water that does not get absorbed in the plant and soil mix or does not infiltrate into the ground to an outfall. These pipes are typically 4 in. in size and outlet on the downhill side of a swale or cell onto a vegetated area or into a conventional stormdrain system.

Construction Materials Needed

1. *Planting media* requires local sources of clean topsoil (with no greater than 20 percent clay by volume), American Society for Testing and Materials (ASTM)-33 sand or locally available coarse clean sand, shredded hardwood mulch and organic matter (see attached spec). Clean topsoil is weedseed free and should be available from local landscape contractors if topsoil is not available from the site. ASTM-33 sand is coarse and should have no greater than 10 percent clay; if sand that is available has clay in it, it may be washed to separate the clay and sand prior to using the sand. The high percentage of sand in the planting media ensures good drainage and water treatment by the planting media. The planting media provides good drainage for the plants and helps to store runoff for uptake by plants or infiltration into the surrounding soils.
2. *Perforated drain pipe* for underdrain, filter fabric (see detail).

Bioretention Construction Procedure:

- Inspect area, locate utilities
- Select site for bioretention
- Check and acquire appropriate permits
- Remove trees, brush and debris from bioretention area
- Scrape topsoil and stockpile; stabilize stockpile
- Grade site to appropriate levels
- Size, flag area and install Erosion Control Silt Fence around the bioretention perimeter
- Excavate bioretention area
- Install any underdrains that are to be used
- Install bioretention media
- Layout and install plants
- Install by hand mulch over entire basin to a depth of 3 in.

3. *Underdrain pipe*(Perforated High-density polyethylene [HDPE]). This provides an exit for runoff water when the storm size exceeds the design capacity so that the plants will not be inundated with water longer than they are adapted to be.
4. *Drainage Fabric*.
5. *Gravel material* (57 stone typical) is available through stoneyards; gravel should be washed and have a diameter not greater than 2 in. and not less than 1 in.
6. *4-in. outfall pipe* connects to the perforated HDPE and allows underdrained water to be released from the bioretention area.
7. *Excavation equipment*.
8. *Planting Design*. Choose plants appropriate to region (native).
9. *Plants* should be in #1, #2 or #3 size containers with roots that extend to the pot edges.
10. *Shredded hardwood mulch*. Shredded hardwood mulch is a byproduct of sawmill production and provides organic texture to the planting media; if it is not locally available, coarse textured organic matter may be substituted such as pine bark nuggets or coarse leaf litter. It is important that it not have too fine a texture or it will clog the planting media.

Installation Procedure

1. Locate/Mark any utilities.
2. Check all permits.
3. Mark out area for bioretention; orient length of Bioretention Strip parallel to the slope so that the runoff enters as sheet flow.
4. Allow room for a pre-treatment strip of grass or gravel to be installed along with the bioretention cell.
5. Inspect area and soil test to determine that there are no measurable contaminants (e.g., trinitrotoluene (TNT) >10 percent, perchlorate, etc.) existing in the soils that would require the use of a liner in the bioretention area and a connection to a stormwater pipe system.
6. Install Erosion and Sedimentation fencing to keep soils in the construction area contained.
7. Excavate area as per plans; remove soil as specified on plan.
8. Mix planting media prior to installation in excavated area.
9. Install any requisite underdrains.
10. Install planting media in 1 ft lifts and water each before installing the next layer.
11. Bioretention area should drain all surface water completely in 48 hrs; flood area and monitor for 48 hrs.
12. Bring plants to site and lay out in planting area as per plan.
13. Plant plants; dig each plant hole 2X as wide as the pot width and the same depth as the plant rootball height.
14. Mulch plants by hand with 3 in. of mulch; mulch to within 4 in. of the stem of the plant.
15. Provide 1 in. water/week for the first year if there is no rain during the week.

Typical Maintenance Schedule

First Year:

- Initially, water plants weekly when there has been no rain. Once plants have become established, watering is necessary only under drought conditions.

Monthly:

- Remove accumulated trash and debris.
- Remove unwanted weeds (see note below).

Every Six Months:

- Reapply mulch to a depth of 3 in.

Annually:

- If necessary, remove accumulated sediment from bioretention cell and pretreatment area.
- Water in the facility should infiltrate the system within 4-6 hrs or less, if longer, the underdrain may be clogged. Underdrain systems are built with a clean out pipe, allowing the operator the ability to clean and unclog the system. Flush underdrain if it has become clogged.
- Replace any dead plants.
- Prune plants as appropriate for each plant species used.

Note: Weeding is not necessary for proper functioning. In fact, plants that invade the bioretention facility are often well adapted to site conditions, and will improve performance. However, unwanted plants can be removed if they are invasive or aesthetically unappealing.

The high nutrient loads typical of stormwater runoff usually make fertilization unnecessary.

Regional Considerations

Climate concerns will vary with each locality. Bioretention is more or less effective depending on a variety of climatic factors, primarily temperature and moisture regimes.

Factors to consider:

- In cold climates, bioretention cells may fail to function under freezing conditions.
- In climates that experience high-intensity storms, bioretention may be insufficient to capture large runoff volumes.
- In climates that which experience prolonged drought conditions, regular watering may be required to keep plantings alive.

See also: Climate Chart in *Appendix E1*

Potential Limitations

Certain site conditions may limit the appropriateness of bioretention. Bioretention should not be used where slopes are greater than 20 percent, or where the depth to the water table is less than 6 ft.

In areas with high sediment loads, pretreatment is necessary to avoid clogging the bioretention cell. Grass buffer strips or settling basins should be used to remove sediment from runoff before it enters the bioretention cell.

Effectiveness of Bioretention

Runoff Volume Reduction: Bioretention cells are typically designed to capture the first ½ in. of runoff from a site. In areas with high soil permeability, most or all of the captured runoff will infiltrate into the surrounding soil. In areas with low soil permeability, some of the captured runoff will be slowly released through the underdrain.

Pollutant Removal Effectiveness

Pollutant	Reported Removal Rate
Sediment (total suspended solids [TSS])	29–96%
Oil and Grease	>96%
Total Nitrogen	32–40%
Total Kjeldahl Nitrogen	+4.9–45%
Ammonia	+1–86%
Organic Nitrogen	21%
Nitrate	1–75%
Total Phosphorus	4–85%
Ortho-Phosphorus	+9–69%
Zinc	94–98%
Copper	88–99%
Lead	66–98%
Cadmium	95–98%

References

- Davis, A. P., M. Shokouhian, H. Sharma, and C. Minami. 2006. Water quality improvement through bioretention media: Nitrogen and phosphorus removal. *Water Environment Research* 783:284-293.
- Dietz, M. E., and J. C. Clausen. 2005. A field evaluation of rain garden flow and pollutant treatment. *Water, Air, and Soil Pollution* 167:123-138.
- Hunt, W. F., Jarrett, A. R., Smith, J. T., and Sharkey, L. J. 2006. Evaluating bioretention hydrology and nutrient removal at three field sites in North Carolina. *Journal of Irrigation and Drainage Engineering*, November/December 2006:600-608.
- Hsieh, Chi-hsu, Davis, Allen P. 2005. Evaluation and optimization of bioretention media for treatment of urban storm water runoff, *Journal of Environmental Engineering* 131(11):1521-1531.
- Sun, X., and A. P. Davis. 2007. Heavy metal fates in laboratory bioretention systems. *Chemosphere* 66:1601-1609.
- U.S. Environmental Protection Agency. 1999. Stormwater technology fact sheet: Bioretention. EPA 832-F-99-012. USEPA Office of Water, Washington, DC.



**US Army Corps
of Engineers®**
Engineer Research and
Development Center

Bioswales Technology

Draft 06.29.2007

How Bioretention Works

Bioretention swales, or Bioswales, are modified swales that use bioretention media beneath the swale to improve water quality, reduce the runoff volume, and peak runoff rate. Bioretention can be in the form of cells or swales. The bioswales are designed to collect sheet flow of runoff from small lengths of drainage to help absorb water and then convey the excess runoff from storms. These systems perform the same functions as traditional grassed swales by serving as a conveyance structure and filtering and infiltrating runoff. They differ, however, because the use of bioretention media enhances infiltration, water retention, nutrient, and pollutant removal. Like bioretention cells and basins, bioretention swales encourage infiltration to retain runoff volume and use a variety of physical, chemical, and biological processes to reduce runoff pollutant loadings. Infiltration may be enhanced by adding gravel or other permeable material below the channel bottom. Bioretention areas are useful to treat areas that have high runoff potential and non-point source pollutant loads from vehicles. Bioretention is an Low Impact Development (LID) tool that uses the physical, chemical, and biological processes in plants and soils to absorb and treat pollutants and help maintain the hydrologic, or water balance of an area. The pollutants, such as oil and grease or metals from machinery are absorbed by the soils and plants and treated. The volume of runoff is also absorbed by the soils and plants, which reduces the pollutant loads.

Bioswales may be used in conjunction with pretreatment BMPs such as filter strips, vegetated filters, or other sediment capturing devices to prevent sediments from accumulating in the swale. The enhanced infiltration of bioswales over that of grassed swales and vegetated swales does not preclude the need to discharge to another best management practice (BMP) such as a bioretention cell or a detention basin for a large storm event.

The drainage area to a swale should typically be less than 100 ft in length and no more than 1 acre of drainage. Bioretention cells are designed to treat stormwater from small drainage areas that drain directly to them. The cells are typically 40 x 60 ft to treat an area of pavement or compacted soils of about ½ acre. The cells and bioswales have a

Bioswale Construction Procedure:

- Inspect area, locate utilities
- Select site for bioswale
- Check and acquire appropriate permits
- Remove trees, brush and debris from bioretention area
- Scrape topsoil and stockpile; stabilize stockpile
- Grade site to appropriate levels
- Size, flag area and install Erosion Control Silt Fence around the bioretention perimeter
- Excavate bioretention area
- Install any underdrains that are to be used
- Install bioretention media
- Seed the bioretention media with grass seed if it is to be grassed or plant with bioretention adapted plants if it is to be vegetated with perennials and woody species
- Install mulch by hand (straw cover if grass seed, 3 in. of mulch if plants)

Construction Materials Needed

specially designed mix of soils and plants that tolerate wet and dry conditions. There is typically an underdrain of stone and perforated drainage pipe that conveys the water that does not get absorbed in the plant and soil mix or does not infiltrate into the ground to an outfall. These pipes are typically 4 in. in size and outlet on the downhill side of a swale or cell onto a vegetated area or into a conventional stormdrain system. *Planting media* requires local sources of clean topsoil (with no greater than 20 percent clay by volume), ASTM-33 sand or locally available coarse clean sand, shredded hardwood mulch and organic matter (see attached spec). Clean topsoil is weedseed free and should be available from local landscape contractors if topsoil is not available from the site. ASTM-33 sand is a coarse sand and should have no greater than 10 percent clay; if sand that is available has clay in it, it may be washed to separate the clay and sand prior to using the sand. The high percentage of sand in the planting media ensures good drainage and water treatment by the planting media. The planting media provides good drainage for the plants and helps to store runoff for uptake by plants or infiltration into the surrounding soils.

Perforated drain pipe for underdrain, filter fabric (see detail).

Underdrain pipe (Perforated High-Density Polyethylene [HDPE]). This provides an exit for runoff water when the storm size exceeds the design capacity so that the plants will not be inundated with water longer than they are adapted to be.

Drainage Fabric

Gravel material (57 stone typical) is available through stoneyards; gravel should be washed and have a diameter not greater than 2 in. and not less than 1 in.

4-in. outfall pipe connects to the perforated HDPE and allows underdrained water to be released from the bioretention area.

Excavation equipment

Planting Design. Choose plants appropriate to region (native)

Plants should be in #1, #2 or #3 size containers with roots that extend to the pot edges.

Shredded hardwood mulch is a byproduct of sawmill production and provides organic texture to the planting media; if it is not locally available, coarse textured organic matter may be substituted such as pine bark nuggets or coarse leaf litter. It is important that it not have too fine a texture or it will clog the planting media.

Installation Procedure

1. Locate/Mark any utilities.
2. Check all permits.
3. Mark out area for bioretention; orient length of Bioretention Strip parallel to the slope so that the runoff enters as sheet flow.
4. Allow room for a pre-treatment strip of grass or gravel to be installed along with the bioretention cell.
5. Inspect area and soil test to determine that there are no measurable contaminants (e.g., trinitrotoluene (TNT) >10 percent, perchlorate, etc.) existing in the soils that would require the use of a liner in the bioretention area and a connection to a stormwater pipe system.
6. Install Erosion and Sedimentation fencing to keep soils in the construction area contained.
7. Excavate area as per plans; remove soil as specified on plan.
8. Mix planting media prior to installation in excavated area.
9. Install any requisite underdrains.
10. Install planting media in 1 ft lifts and water each before installing the next layer.
11. Bioretention area should drain all surface water completely in 48 hrs; flood area and monitor for 48 hrs.
12. Bring plants to site and lay out in planting area as per plan.

13. Plant plants; dig each plant hole 2X as wide as the pot width and the same depth as the plant rootball height.
14. Mulch plants by hand with 3 in. of mulch; mulch to within 4 in. of the stem of the plant.
15. Provide 1 in. water/week for the first year if there is no rain during the week.

Typical Maintenance Schedule

First Year:

- Initially, water plants weekly when there has been no rain. Once plants have become established, watering is necessary only under drought conditions.

Monthly:

- Remove accumulated trash and debris.
- Remove unwanted weeds (see note below).
- Every Six Months.
- Reapply mulch to a depth of 3 in.

Annually:

- If necessary, remove accumulated sediment from bioretention cell and pretreatment area.
- Water in the facility should infiltrate the system within 4-6 hrs or less, if longer, the underdrain may be clogged. Underdrain systems are built with a clean out pipe, allowing the operator the ability to clean and unclog the system. Flush underdrain if it has become clogged.
- Replace any dead plants.
- Prune plants as appropriate for each plant species used.

Note: Weeding is not necessary for proper functioning. In fact, plants that invade the bioretention facility are often well adapted to site conditions, and will improve performance. However, unwanted plants can be removed if they are invasive or aesthetically unappealing.

The high nutrient loads typical of stormwater runoff usually make fertilization unnecessary.

Regional Considerations

Climate concerns will vary with each locality. Bioretention Strips are more or less effective depending on a variety of climatic factors, primarily temperature and moisture regimes.

Factors to consider:

- In cold climates, bioswales may fail to function under freezing conditions.
- In climates that experience high-intensity storms, bioretention may be insufficient to capture large runoff volumes.
- In climates that experience prolonged drought conditions, regular watering may be required to keep plantings alive.

See: Climate chart in *Appendix 1*

Potential Limitations

Certain site conditions may limit the appropriateness of bioretention. Bioretention should not be used where slopes are greater than 20 percent, or where the depth to the water table is less than 6 ft.

In areas with high sediment loads, pretreatment is necessary to avoid clogging the bioretention cell. Grass buffer strips or settling basins should be used to remove sediment from runoff before it enters the bioretention cell.

Effectiveness of Bioswales

Runoff Volume Reduction: Bioswales are typically designed to capture the first ½ in. of runoff from a site. In areas with high soil permeability, most or all of the captured

runoff will infiltrate into the surrounding soil. In areas with low soil permeability, some of the captured runoff will be slowly released through the underdrain.

Pollutant Removal Effectiveness.

Pollutant	Reported Removal Rate
Sediment (TSS)	29–96%
Oil and Grease	>96%
Total Nitrogen	32–40%
Total Kjeldahl Nitrogen	+4.9–45%
Ammonia	+1–86%
Organic Nitrogen	21%
Nitrate	1–75%
Total Phosphorus	4–85%
Ortho-Phosphorus	+9–69%
Zinc	94–98%
Copper	88–99%
Lead	66–98%
Cadmium	95–98%

References

Davis, A. P., M. Shokouhian, H. Sharma, C. Minami. 2006. Water quality improvement through bioretention media: Nitrogen and phosphorus removal. *Water Environment Research* 78(3): 284-293.

Dietz, M. E., and J. C. Clausen. 2005. A field evaluation of rain garden flow and pollutant treatment. *Water, Air, and Soil Pollution* 167:123-138.

Hunt, W. F., A. R. Jarrett, J. T. Smith, and L. J. Sharkey. 2006. Evaluating bioretention hydrology and nutrient removal at three field sites in North Carolina. *Journal of Irrigation and Drainage Engineering* November/December:600-608.

Hsieh, Chi-hsu, and Allen P. Davis. 2005. Evaluation and optimization of bioretention media for treatment of urban storm water runoff, *Journal of Environmental Engineering* 131(11):1521-1531.

Sun, X., and A. P. Davis. 2007. Heavy metal fates in laboratory bioretention systems. *Chemosphere* 66:1601-1609.

U.S. Environmental Protection Agency. 1999. Stormwater technology fact sheet: Bioretention. *EPA 832-F-99-012. USEPA Office of Water*, Washington, DC.



US Army Corps
of Engineers®
Engineer Research and
Development Center

Compost Amendments Technology Draft 06.29.2007

How Compost Amendments Work

Compost Amendments are an Low Impact Development (LID) tool typically used during the construction phase of the construction process to improve soil structure and fertility during the establishment phase of planting materials. Amendments are worked into the soil to a depth ranging from 4-8 in. and results in a top layer with which ranges from 1:2 – 1:4 (compost:soil). Compost can be used to rehabilitate soils compacted by heavy use.

Beneficial effects of compost amendments:

- Increased moisture-holding capacity.
- Increased porosity.
- Improved medium for plant growth.
- Reduced need for irrigation.
- Reduced need for fertilizer.
- Reduced erosion.
- Increased infiltration.
- Improved habitat for beneficial soil organisms.
- Improved pollutant removal.
- Reduced runoff.

Compost Amendment Construction Procedure:

- Test soil
- Obtain compost
- Rototill or rip and rototill to 6 in. Depth
- Remove rocks
- Spread compost and other soil conditioners
- Re-rototill
- Fine grade
- Roll
- Water
- Plant

They may be usually used in conjunction with other, more technologically complex and permanent LID tools.

Construction Materials Needed

1. *Compost*. Use only mature compost that has been certified by the U.S. Composting Council's Seal of Testing Assurance Program (www.compostingcouncil.org), and meets the following specifications:

Factor	Acceptable Range
pH	5.0–8.5
Moisture Content	< 60%
Organic Matter	> 25%, dry weight
Particle size	99 % passing 2 in. sieve 30–50% passing 3/8 in. sieve
Physical contaminants	< 1%, dry weight

2. *Compost Quantity*. Use a 2 to 1 ratio of existing soil to compost. Compost is generally to be incorporated into the top 6-in. of soil, so 3-in. of compost must be added over the site. For simplicity, use the following rule of thumb: 1 in. of material spread over 1000 sq ft is equivalent to about 3 cu yd.
3. *Heavy machinery*. Rototiller, ripper if soil is highly compacted, sprinkler or other water source.

4. *Hand tools.* Wheelbarrows, shovels, hoes, flat rakes.
5. *Soil conditioners.* Lime, gypsum, or additional fertilizer as indicated by soil test results.

Installation Procedure

1. Prior to amending soil, have the compost and the soil tested. This analysis will reveal necessary proportions nutrients and other soil conditioners. Allow a 1-month time window for analysis and reporting.
2. Rototill or rip and rototill the subgrade to a depth of at least 6 in.
3. Remove rocks.
4. Distribute compost.
5. Spread lime and nutrients.
6. Re-rototill so that amendments are evenly worked into the soil; tilling should be done in a grid pattern, first in one direction and then in a direction perpendicular to the first.
7. Fine grade or “float”/ rake the site so that it is even and no large clumps persist.
8. Hand roll the site.
9. Water soil and allow to settle for 1 week.
10. Fill and grade depressions until a uniform surface is achieved.
11. Soil should be vegetated immediately after amending to avoid erosion.

Typical Maintenance Schedule Regional Considerations

Routinely inspect amended soils for signs of compaction, waterlogging, or poor cover growth. Take corrective actions when necessary, such as soil aeration, deep tilling, or addition of further soil amendments.

Climate concerns will vary with each locality. The rate and ease of soil restoration will vary depending on a variety of climatic factors, primarily temperature and moisture regimes.

Factors To Consider: Time of year for construction, availability of compost locally
See also: Climate chart, *Appendix E*, p E-1).

Potential Limitations

Local availability of compost that meets the design specification may limit its use. Seasonal conditions may also pose some limitations for use.

Effectiveness of Compost Amendments

Water Quantity. Soil amendments allow the soil to absorb and hold more moisture, greatly decreasing the volume of runoff generated during storm events. Studies have shown decreases in surface runoff of 5 – 10X, and increased soil moisture storage capacity of 65 percent.

Water Quality. Compost amended soils remove pollutants through sorption, precipitation, filtering, and bacterial and chemical degradation.

Pollutant Removal Effectiveness with Grassy Cover

Pollutant	Reported Removal Rate
Sediment (TSS)	65%
Motor Oil Removal	96%
Total Phosphorus	20-76%*
NH ₄ N	54%
Total Kjeldahl Nitrogen (TKN)	72%

Sources:
Filtrexx 2007.
Studies from Univ. of Washington and Texas A&M University

Typical Construction
Details of Compost
Amendment
Installation

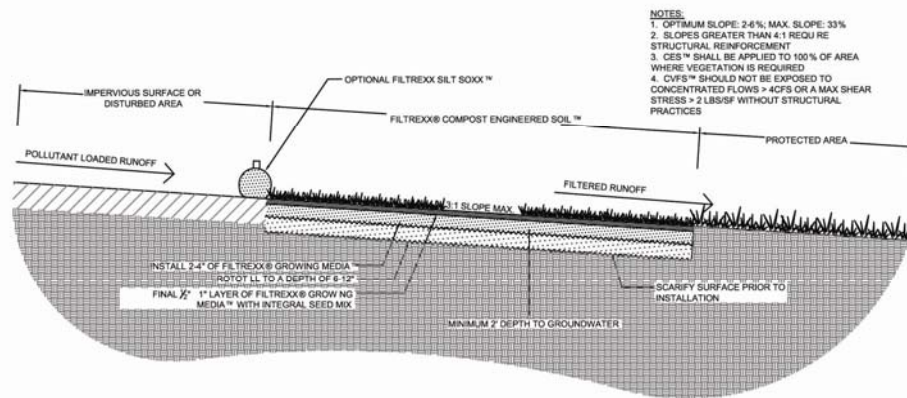

FILTREXX® COMPOST ENGINEERED SOIL™
NOTES

Engineering Design Drawing for Filtrexx Compost Engineered Soil™.

References

Chollak, T., and P. Rosenfeld. 1998. Guidelines for landscaping with compost-amended soils, Redmond, WA. City of Redmond Public Works.

Filtrexx. 2007. Standard specifications and design manual –version 6, updated 5-1-07. Section 2: Stormwater management – post construction, 2.3 Filtrexx Compost Engineered Soil™ (CES™), Infiltration and Pollution Control Technology, <http://www.filtrexx.com/>

Pitt, R., P. E., J. Lantrip, R. Harrison, C. Henry, and D. Xue. 1999. Infiltration through disturbed urban soils and compost amended soil effects on runoff quality and quantity. EPA/600/R-00/016. Cincinnati, OH: National Risk Management Research Laboratory, Office of Research and Development, U.S. Environmental Protection Agency.

PWTB 200-1-62
1 October 2008



US Army Corps
of Engineers®
Engineer Research and
Development Center

Downspout Disconnection/Rain Barrel Technology

Draft 06.29.2007

How Downspout Disconnection and Rain Barrels Work

Downspout disconnection is an Low Impact Development (LID) tool used in the post-construction phase of the construction process to minimize negative environmental impacts from development activities. The term reflects an approach to downspout linkages. Downspouts may be redirected to flow into other LID tools such as grassy swales, vegetated swales, bioretention cells, bioswales and reforestation areas. They may also be linked into either cisterns or rain barrels.

Rain barrels collect water from downspouts and save the water for reuse later. Filter devices on the rain barrel inlets prevent mosquitoes and other insects from populating the rain barrel. One 55-gal rain barrel can accommodate ½ in. of rain from a 1200 sq ft roof.

Construction Materials Needed

Downspout Disconnection

Disconnecting impervious areas requires little construction and few materials:

1. *Modification to downspouts.* Rooftop disconnection will require minimal modification to the downspouts to redirect runoff away from the collection system or other impervious areas.
2. *Curb cuts.* Various other methods are available to disconnect impervious areas, but typical procedures may include curb cuts to encourage stormwater flows away from inlets and open area modifications to enhance the infiltration characteristics of receiving areas.
3. *Flow spreading and leveling devices.* Other modifications include flow spreading and leveling devices, which may be used to encourage shallow sheet flow through vegetated areas.
4. *Soil amendments* increase soil permeability are also a possible design option.

Downspout Disconnection Construction Procedure:

- Evaluate area where downspout drains
- Redirect downspout away from stormdrains either by connecting to a rain barrel or a rain garden or a grassy area

Rain Barrel Construction Procedure

- Level area for rain barrel
- Install blocks
- Cut downspout to proper length
- Install rainbarrel on blocks
- Install downspout fitting for rainbarrel

Rain Barrels

1. One or more 55-gal barrels.
2. Child-resistant top. Allows easy access for cleaning. Screens may be used at the inflow points to strain coarse sediment and reduce the potential for mosquito breeding.
3. Hand Tools: drill, locking pliers, adjustable hole saw.
4. Plumbing Materials: connections to the downspout, runoff pipe, spigot, hoses to connect barrels in series, plumbing sealant.
5. Concrete Blocks.

Installation Procedure

Home made rain barrels are relatively easy to construct from 55-gal drums and a few other basic components. The following is a simple construction sequence:

1. Drill holes for fittings. First drill three holes in the barrel. One for the spigot to connect your garden house to the barrel and the other fittings to allow for more barrels in the future. One of the barrels must have an overflow fitting near the top of the barrel. If you plan on using 3/4 in. fittings use a 1-in. hole saw to cut the holes. If you have an adjustable hole saw make it a little smaller than 1 in.
2. Attach fittings. Place plumbing sealant on a 3/4 in. galvanized metal nipple and its threads. Using a pair of locking pliers, thread the nipple into the barrel hole for the fitting.
3. Cut the down spout at the proper height. You should place the rain barrel on one or two concrete blocks and then determine the proper height. After cutting the down spout attach the necessary elbows and extensions to have the down spout reach the barrel. Attach a 4 X 2-in. acrylonitrile butadiene styrene (ABS) plastic converter to the end of the down spout and attach a fine mesh screen over the converter (you can use a paint sprayer filter that you can get at a hardware store for about \$1).
4. Add additional barrels. If you wish to add more barrels do so at this time. Attach a garden hose Y fitting on the 3/4-in. nipples. Position the barrels on top of the concrete blocks and cut the right length of garden hose to connect the barrels (with male fittings attached to both ends).
5. End product. Attach an overflow line on the first barrel. Place it near the top of the barrel and attach it to hose or tube for any overflow. Note that you must remove one of the two bung fittings on the top of the barrel and cover it with a small screen.

Typical Maintenance Schedule

Downspout Disconnection

- Related maintenance activities are primarily focused on the areas designated to receive stormwater runoff.
- Engineering infiltration areas should be routinely checked to ensure that they are free of debris and trash.
- Both vegetated and constructed infiltration areas should be inspected for sediment accumulation. Additionally, receiving areas should be inspected for signs of channelized flow and signs of compaction.
- Disconnectivity practices may require annual inspection to ensure that the stormwater is still directed to the desired location.

Rain Barrels

- Rain barrels maintenance requirements are minimal.
- The unit and attachments should be inspected for clogging several times a year and after major storms. Inspect rain barrel connections (e.g., inflow and outflow hoses) when removing debris.
- Minor parts such as spigots, screens, downspouts, or leaders may need to be eventually replaced.

Regional Considerations

Climate concerns will vary with each locality and knowledge of climate regimes is an important factor in downspout disconnection. Rain barrels should not be used during freezing conditions.

Factors to consider: Ability to empty rain barrels prior to freezing weather; ability to ensure that rain barrels are checked and drained / water used for local irrigation when it is not raining.

See: Climate Chart in *Appendix 1*

Potential Limitations

Runoff from disconnect impervious areas must not flow toward building foundations or onto adjacent private property.

PWTB 200-1-62
1 October 2008

Rain barrels are often, but not exclusively, used for residential applications. They have been successfully used on small weapons ranges as part of the shooter gallery roof drainage system.

PWTB 200-1-62
1 October 2008



US Army Corps
of Engineers®
Engineer Research and
Development Center

Filter Mats Technology

Draft 06.29.2007

Effectiveness of Downspout Disconnection

Peak flow reduction. Downspout disconnection increases the time of concentration of stormwater runoff, reducing peak flows. Disconnected downspouts may have their drainage directed either towards grassy swales, vegetated swales or bioretention areas if they are not first linked to a rain barrel/cistern.

Volume reduction. The amount of volume stored depends on the size of the rain barrel or cistern. In general, runoff from small storms on small roof areas can be easily stored in a moderately sized rain barrel or cistern. Storing runoff from larger storms requires much larger cisterns.

Pollutant removal effectiveness. The effectiveness of rain barrels comes from preventing the generation of runoff, which picks up pollutants as it runs off impervious surfaces, such as roadways.

How Filter Mats Work

Filter mats are an Low Impact Development (LID) tool typically used during the construction phase of the construction process to facilitate slope and streambank stabilization and to act as temporary filters to protect inlets to stormdrains. They are used to trap the physical, chemical, and biological pollutants in stormwater. Filter mats may be applied to disturbed, bare, or highly erodible soils during land disturbing activities. When seeded and successfully vegetated, they become part of a permanent slope erosion control solution. Seed mixes should be determined to fit local conditions and be predominated by native seeds.

Filter mats are easy to install and particularly effective when used in situations requiring runoff volume reduction, vegetation establishment and in conjunction with other erosion control and slope stabilization measures as a support practice. Filter mats dissipate the energy of falling water, reducing splash erosion. They may be used as a mulch to suppress weeds and to retain moisture to support new vegetation that has been installed.

When properly installed, filter mats can be very effective in removing sediments from sheetflow, particularly when enhanced with a compost growing media. They are designed to collect sheet flow of runoff from small lengths of drainage to help absorb water and then convey the excess runoff from storms. The drainage area to a swale should typically be less than 100 ft in length and no more than 1 acre of drainage.

Filter mats may be usually used in conjunction with other, more technologically complex and permanent LID tools. Filter mats should not be used in areas where there is concentrated flow or where runoff velocities will undermine new vegetation.

Filter Mat Construction Procedure:

- Inspect area, locate and mark utilities
- Select site for filter mat
- Check and acquire appropriate permits
- Install filter mat materials as per construction specification

There are two basic types of filter mats:

1. *Turf Reinforcement Mats* are permanent structures intended to help establish vegetation and hold it in place. They are particularly useful on steep slopes or high-flow channels, where vegetation alone may be insufficient for stabilization.

2. *Erosion Control Blankets* are temporary structures made of biodegradable materials, such as coconut fiber. They are intended to stabilize soils while vegetation is becoming established. They are most appropriate for moderate slopes and low-flow channels.

**Construction
Materials Needed**

Required construction materials are:

1. Blanket/Mat.
2. Hand tools: rakes, shovels.
3. Hydroseeding Machine.*
4. Hydroseed.
5. Staples: 6-in., 11-gauge sod staples.
6. Staple Gun.
7. Water Supply.

Installation Procedure

Proper installation and good contact with the ground are essential to ensure proper performance. If slopes are greater than 4:1, the slope should be vertically tracked to increase the soil roughness and increase soil contact with the mat. Select a locally adapted seed mix and plants in consultation with the Landscape Architect, Natural Resources Conservation Service (NRCS), or cooperative extension personnel associated with the project.

1. Prepare area so that soil is ready for seed; the surface should be free from large clods and debris and raked even to ensure even soil contact with the filter mat.
2. Seed and fertilize prior to applying the mat unless manufactures specifications indicate otherwise (if hand seeded, roll the seeded area to ensure proper seed-soil contact).
3. Roll out mat, starting at the top of the slope and rolling downhill; overlap edges at least 4 in.
4. Overlap ends shingle-style, with upslope ends on top, at least 4 in.
5. Staple in place.
6. Bury the top end of the mat in a 6 in. trench, and backfill (ensures that runoff is forced to run onto the mat, rather than under it).
7. Water.

**Typical Maintenance
Schedule
Regional
Considerations**

Filter mats must be regularly and closely inspected to ensure that soil has not begun to erode beneath the mat.

Climate concerns will vary with each locality. Filter mats are more or less effective depending on a variety of climatic factors, primarily temperature and moisture regimes.

Factors To Consider: Time of year for construction, availability of materials, Volume of water and possible contaminants.

See also: See climate chart in Appendix 1

Potential Limitations

Certain site conditions may limit the appropriateness of filter mats. Filter mats work best in areas where vegetation can be established, but have also been used in arid, semi-arid, and high-altitude regions. In these regions, the filter mat itself acts as the principal erosion control device.

**Effectiveness
of Filter Mats**

Pollutant Removal Effectiveness

Pollutant	Reported Removal Rate
Sediment (TSS)	30-70%

* If the area to have filter mat is small and hydroseeding is not feasible due to equipment availability, seed may be spread either with a handheld spreader or by hand broadcasting. Use live seed with 90% purity and 70% minimum germination rate (if handseeding, roll seed with roller after spreading seed)

Pollutant	Reported Removal Rate
Soil loss reduction	93.5–99%
Runoff volume reduction for Erosion Control Blanket	20–76%*
Runoff volume reduction for Compost Stormwater Blanket	35–76%**
Source: USEPA 1999, Filtrexx 2007	
* The low reduction was for a 4 in./1-hr rain event on a 10:1 sandy clay loam slope; the high reduction was for a 4.4 in./24-hr rain event on a 2:1 silty sand slope.	
** The low reduction was for a 1.8 in./35-min rain event on a 3:1 clay slope; the high reduction was for a 4.4 in./24-hr rain event on a 2:1 silty sand slope	

References

Filtrexx. 2007. Standard specifications and design manual version 6.0 (updated 5/1/07) Section 1: Erosion and sediment control-construction activities, 1.8 Filtrexx Compost Erosion Control Blanket™ (CECB™) slope stabilization and erosion control technology, <http://www.filtrexx.com/>

Filtrexx. 2007. Standard specifications and design manual version 6.0 (updated 5/1/07) Section 2: Storm water management – post-construction, 2.1 Filtrexx Compost Storm Water Blanket™ (CSWB™) runoff reduction & vegetation technology, <http://www.filtrexx.com/>

National Resources Conservation Service (NCRCS). 2003. Broadcast seeding method for burned areas. Fact Sheet. Accessed 30 June 2007, <ftp://ftp-fc.sc.gov.usda.gov/CA/programs/EWP/BroadcastSeeding.pdf>

U.S. Environmental Protection Agency. 1999) Turf reinforcement mats. Stormwater Technology Fact Sheet. EPA 832-F-99-002. Washington, DC: USEPA Office of Water.

Typical Construction Details of Filter Mat Installation

FILTREXX® COMPOST EROSION CONTROL BLANKET™ (CECB)™

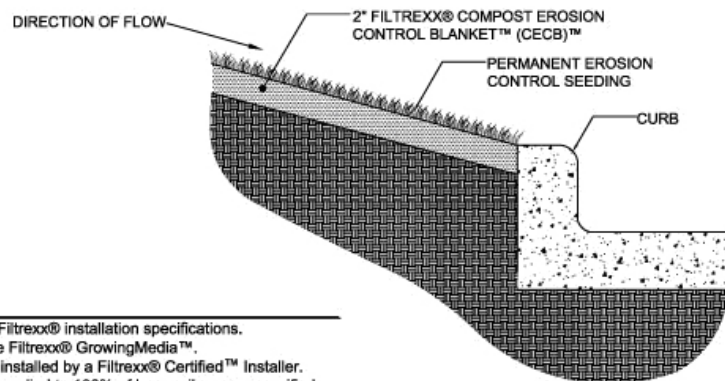

Notes:

1. CECB™ to meet Filtrexx® installation specifications.
2. CECB™ must use Filtrexx® GrowingMedia™.
3. CECB™ must be installed by a Filtrexx® Certified™ Installer.
4. CECB™ shall be applied to 100% of bare soil or area specified.
5. CECB™ shall be installed at least 10 feet over the slope shoulder or into existing vegetation.
6. Erosion control seeding shall meet jurisdictional agency specifications or will be at the discretion of the engineer.
7. CECB™ shall not be installed in areas of concentrated flow where max. flow exceeds 4 CFS or shear stress exceeds 2lbs./sq. ft.
8. CECB™ installed on slopes greater than 2:1 shall use additional slope stabilization practices, such as Filtrexx® Lockdown™ Netting or Filtrexx® ProFloxx™.

CECB™ Section View

Engineering Design Details for Compost Erosion Control Blanket™*.

* Filtrexx. 2007. *Standard Specifications and Design Manual Version 6.0* (updated 5/1/07) Section 1: Erosion and Sediment Control-Construction Activities, 1.8 Filtrexx Compost Erosion Control Blanket™ *Slope Stabilization and Erosion Control Technology*. Available online: <http://www.filtrexx.com/>

PWTB 200-1-62
1 October 2008

Reference

U.S. Environmental Protection Agency. 1999. Flow diversion. Storm Water Technology Fact Sheet. *EPA 832-F-99-014*, Washington, DC: USEPA Office of Water. Accessed June 2007, <http://www.epa.gov/OWM/mtb/fl.pdf>



US Army Corps
of Engineers®
Engineer Research and
Development Center

Filter Socks Technology

Draft 06.29.2007

How Filter Socks Work

Filter socks are an Low Impact Development (LID) tool typically used during the construction phase of the construction process to facilitate streambank stabilization and to act as temporary filters to protect inlets to stormdrains and provide perimeter controls. They are three-dimensional tubular devices used to trap the physical, chemical, and biological pollutants in stormwater. Once installed, they also create a temporary ponding area behind the sock, which facilitates the deposition of suspended solids.

Filter socks are able to be rapidly installed on a construction site area to protect water quality downstream.

They may be usually used in conjunction with other, more technologically complex and permanent LID tools. If runover or damaged, they are easily repaired.

Appropriate for slopes up to 2:1 (1:1 if used in conjunction with slope stabilization/erosion control technology on slopes > 4:1)

Appropriate for high flow areas.

May be used to provide erosion and sediment control in areas that are appropriate for silt fence.

Organic matter in filter socks binds phosphorus, metals, and hydrocarbons that may be in stormwater. The sock may also be directed seeded and left in place as a permanent vegetative feature. If not left in place, it may be incorporated as a soil amendment once construction activity is complete.

The filter media is adjustable to meet specific filtering performance needs as determined by the Engineer or Landscape Architect in charge of the project.

The filter media is adjustable to meet specific filtering performance needs as determined by the Engineer or Landscape Architect in charge of the project.

Required construction materials are:

1. *Handtools*: Shovels, picks, hoses, wheelbarrows.
2. *Marking Materials*: Flagging, flags, or spray paint to delineate area.
3. *Compost*: Use only mature compost that has been certified by the U.S. Composting Council's Seal of Testing Assurance Program (www.compostingcouncil.org), and meets the following specifications:

Factor	Acceptable Range
pH	5.0–8.5
Moisture Content	< 60%
Organic Matter	> 25%, dry weight
Particle size	99 % passing 2-in. sieve 30 – 50% passing 3/8-in. sieve
Physical contaminants	< 1%, dry weight

Filter Sock Construction Procedure:

- Inspect area, locate and mark utilities
- Select site for filter sock
- Check and acquire appropriate permits
- Install filter sock materials as per construction specification

Construction Materials Needed

4. *Filter sock netting.* 5mm thick continuous HDPE filament, tubular knitted mesh with 3/8-in. openings. Use biodegradable plastic if filter sock will not be removed after construction. Use 12-in. diameter netting for most applications. In very high flow areas, use 18-in. diameter netting.
5. *Stakes.* Use 2x2-in. wooden stakes.

Installation Procedure

To install:

1. Locate/Mark any utilities.
2. Check all permits.
3. Obtain compost meeting specifications.
4. Obtain filter sock netting.
5. Fill filter sock netting with compost.
6. Mark out area for filter sock; orient length of sock parallel to the slope so that the runoff enters as sheet flow.
7. In high-flow or steep-slope areas, orient a second sock parallel to the first to dissipate flows.
8. Lay filter sock netting out as planned.
9. Fill filter sock with compost.
10. Stake filter sock every 10 ft. Stakes should be driven through the center of the sock, and 1 ft into the ground.
11. If sock netting must be joined, fit beginning of the new sock over the end of the old sock, overlapping by 1–2 ft. Fill with compost; then stake the join.

Typical Maintenance Schedule

Inspect filter socks periodically, and especially after large storm events. Ensure that the filter sock is intact, and that the area upstream has not filled with sediment. If the upstream area has filled with sediment, or if the filter sock has been overtopped, install additional filter socks further upstream. Sediment behind the sock should be removed when the depth of the sediment reaches 3.25-in. for an 8-in. sock, 4.75-in. for a 12-in. sock and 7.25-in. for an 18-in. sock. For socks with greater diameters, remove sediment behind the sock when the accumulated sediment depth reaches 40 percent of the design diameter of the sock.

Regional Considerations

Climate concerns will vary with each locality. Filter socks are more or less effective depending on a variety of climatic factors, primarily temperature and moisture regimes.

See also: Climate Chart in *Appendix E1*

Potential Limitations

Certain site conditions may limit the appropriateness of filter socks. In very uneven terrain, the area where the filter sock will rest should be leveled to ensure good contact between the sock and the ground.

Compost filter socks are applicable where stormwater runoff occurs as sheet flow.

Drainage areas should not exceed 0.25 acre per 100 ft of device length.

Flow should not exceed 1 cu ft/second.

If compost filter socks are to be used on steeper slopes with faster flows, they must be spaced more closely, stacked beside and/or on top of each other, made in larger diameters, or used in combination with other stormwater BMPs such as compost blankets.

Effectiveness of Filter Socks

Runoff Volume Reduction. Compost filter socks slow the rate of stormwater runoff, reducing peak flows. They do not provide storage. Compost filter socks are easily installed, with low life-cycle costs and offer high levels of durability and sediment control, medium levels of soluble pollutant and runoff volume control. They are approved for American Association of State Highway and Transportation Officials (AASHTO) & USEPA National Pollutant Discharge Elimination System (NPDES)

Phase II. Installation of filter socks does not require trenching or further site disruption and may be installed year round including on frozen ground and on dense and compacted soils as long as stakes can be driven.

Pollutant Removal Effectiveness

Pollutant	Reported Removal Rate
Sediment (TSS)	97-99%
Motor Oil Removal	96%
Phosphorus	34-99%*
Nitrate	25%
Sources: Faucette et al. 2005; Filtrexx 2007. *depending on formulation of filter media	

**Typical Construction
Details of Filter Sock
Installation**

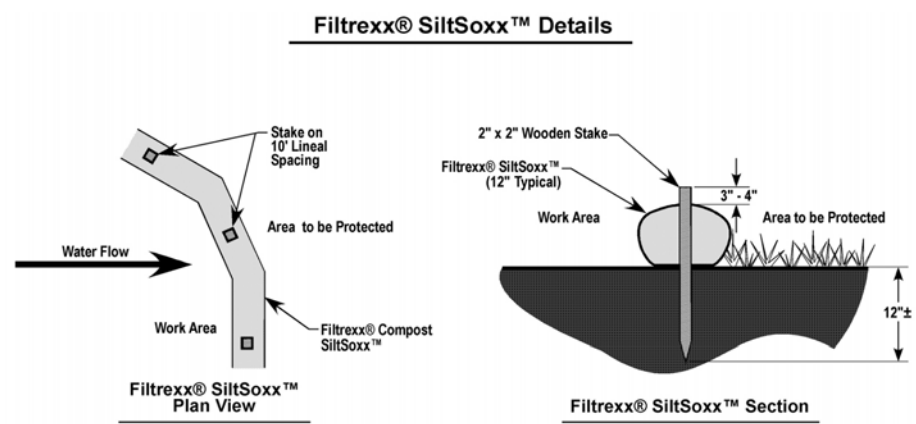

- Notes:**
1. All material to meet Filtrexx® specifications.
 2. SiltSoxx™ compost/soil/rock/seed fill to meet application requirements.
 3. SiltSoxx™ depicted is for minimum slopes. Greater slopes may require larger socks per the Engineer.
 4. Compost material to be dispersed on site, as determined by Engineer.

Engineering Design Drawing for SiltSoxx™*

References

Alexander, R. 2006. Filter berms and filter socks: standard specifications for compost for erosion/sediment control. Apex, NC: R. Alexander Associates, http://www.alexassoc.net/composting_recycling_articles.htm

Faucette, et al. 2005. Evaluation of stormwater from compost and conventional erosion control practices in construction activities, *Journal of Soil and Water Conservation*, 60(6):288-297.

Filtrexx. 2007. Standard specifications and design manual –version 6, updated 5-1-07. Section 1: Erosion and sediment control-construction activities 1.1 Filtrexx SiltSoxx™ sediment & perimeter control technology, <http://www.filtrexx.com/>

U.S. Environmental Protection Agency, National Pollutant Discharge Elimination System (NPDES): Compost filter socks. Accessed June 2007,

* Filtrexx, 2007. Standard Specifications and Design Manual –Version 6, updated 5-1-07. Section 1: Erosion and Sediment Control-Construction Activities 1.1 Filtrexx SiltSoxx™ *Sediment & Perimeter Control Technology*. pdf

PWTB 200-1-62
1 October 2008

<http://cfpub.epa.gov/npdes/stormwater/menuofbmps/index.cfm?action=browse&Rbutton=detail&bmp=120>



US Army Corps
of Engineers®
Engineer Research and
Development Center

Grassy Swales Technology

Draft 06.29.2007

How Grassy Swales Work

Grassy swales are an Low Impact Development (LID) tool that uses the physical, chemical, and biological processes in plants and soils to absorb and treat pollutants and help maintain the hydrologic, or water balance of an area. The pollutants, such as oil and grease or metals from machinery are absorbed by the soils and plants and treated. The volume of runoff is also absorbed by the soils and plants, which reduces the pollutant loads.

Grassy swales are particularly effective in removing sediments from sheetflow. They are designed to collect sheet flow of runoff from small lengths of drainage to help absorb water and then convey the excess runoff from storms. The drainage area to a swale should typically be less than 100 ft in length and no more than 1 acre of drainage. Grassy swales are designed to slow stormwater from small drainage areas that drain directly to them. Grassy swales are not as effective at infiltration, water retention, nutrient, and pollutant removal as bioswales.

The grassy swale may be directed to a culvert (sized to encourage 24-hr ponding) and/or have a series of check dams installed along the course of the swale to further slow the flow of the water along the drainage path. Grass is allowed to be up to a foot tall, with a minimal mowing regime. They may be used as stand alone LID tools or in conjunction with other, more technologically complex LID tools. Flattening the course of the swale and lengthening the distance water has to travel prior to entry into either waterways or stormdrain systems allows for natural processes of infiltration, evaporation, and transpiration to occur all along the flow path.

Grassy Swale Construction Procedure:

- Inspect area, locate and mark utilities
- Select site for grassy swale
- Check and acquire appropriate permits
- Install Erosion Control Silt Fence around perimeter of swale construction area
- Remove trees, brush and debris from grassy swale area
- Grade site to appropriate levels
- Scrape topsoil and stockpile; stabilize stockpile
- Install grassy swale materials as per construction specification

Construction Materials Needed

Required construction materials are:

1. *Excavation equipment:* Grading machinery.
2. *Hand tools:* Shovels, picks, rakes, hoses, wheelbarrows.
3. *Marking Materials:* Flagging, flags or spray paint to delineate area.
4. *Silt Fence* materials for creating and installing an appropriate silt fence.
5. *Grass Seed.* Choose a mix appropriate to region; consult with local horticultural authorities for mix recommendation.
6. *Erosion netting.* Depending on soil conditions, time of year and local laws, some form of erosion netting may be required at the time of installation to protect water quality while the grass seed is getting established.

Installation Procedure

To install:

1. Locate/Mark any utilities.
2. Check all permits.
3. Inspect area and soil test to determine that there are no measurable contaminants (e.g., trinitrotoluene (TNT) >10 percent, perchlorate, etc.) existing in the soils that would require the use of a liner in the swale area and a connection to a stormwater pipe system; if a liner is required, chose another LID technology.
4. Mark out area for grassy swale; orient length of swale parallel to the slope so that the runoff enters as sheet flow.
5. Install Erosion and Sedimentation fencing to keep soils in the construction area contained.
6. Excavate/prepare area as per plans.
7. Install erosion netting if required; spread grass seed; may be by hand or hydroseeded.
8. Provide 1 in. water/week for the first year if there is no rain during the week.

Typical Maintenance Schedule

First Year:

- Water seed weekly when there has been no rain. Once grass has become established, watering is necessary only under drought conditions.

Monthly:

- Remove accumulated trash and debris.
- Remove unwanted weeds (see note below).
- Every 2 Months during growing season.
- Mow; set mower deck to height of 6-8 in.

Annually:

- If necessary, remove accumulated sediment from grassy swale.
- Water in the facility should move through the system within 24 hrs or less.
- Replace any dead plants.
- Prune plants as appropriate for each plant species used.

Note: Weeding is not necessary for proper functioning; most woody species may be controlled by the mowing schedule being frequent enough to prevent their development. However, unwanted plants can be removed if they are invasive or aesthetically unappealing.

The high nutrient loads typical of stormwater runoff usually make fertilization unnecessary.

Regional Considerations

Climate concerns will vary with each locality. Bioretention Strips are more or less effective depending on a variety of climatic factors, primarily temperature and moisture regimes.

Factors to consider:

- In cold climates, bioretention cells may fail to function under freezing conditions.
- In climates that experience high-intensity storms, bioretention may be insufficient to capture large runoff volumes.
- In climates that experience prolonged drought conditions, regular watering may be required to keep plantings alive.

See: Climate Chart in Appendix 1

Potential Limitations

Certain site conditions may limit the appropriateness of grassy swales. Grassy swales should not be used where slopes are greater than 20 percent, or where the depth to the water table is less than 6 ft.

**Effectiveness of
Grassy Swales**

In areas with high sediment loads, grassy swales may be used as a pretreatment area for other LID tools.

Runoff Volume Reduction. Grassy swales are used to convey stormwater to larger storage areas. Their primary function is to slow runoff velocity and reduce peak flows, though they do infiltrate some stormwater and can provide storage during smaller storm events.

Pollutant Removal Effectiveness

Pollutant	Reported Removal Rate
Sediment (TSS)	22–94 %
chemical oxygen demand (COD)	34–63 %
Total Nitrogen	14–45 %
Total Phosphorus	29–99 %
Sources: Deletic and Fletcher 2006; Yu et al. 2001.	

References

Deletic, A., and T. D. Fletcher. 2006. Performance of grass filters used for stormwater treatment: A field and modeling study. *Journal of Hydrology*, 317:261-275.

Yu, S. L., J-T. Kuo, E. A. Fassman, and H. Pan. 2001. Field test of grassed-swale performance in removing runoff pollution. *Journal of Water Resources Planning and Management*, 127(3):168–171.

PWTB 200-1-62
1 October 2008



**US Army Corps
of Engineers®**
Engineer Research and
Development Center

Permeable Pavements Technology

Draft 06.29.2007

How Permeable Pavements Work

Permeable Pavements represent a class of Low Impact Development (LID) tools used in the construction phase of the construction process to minimize negative environmental impacts from development activities. Permeable pavements come in a variety of forms; they may be a modular paving system or poured in place solutions. Permeable pavements treat stormwater and remove sediments, nutrients and some heavy metals. They may be configured to allow for temporary storage of runoff to encourage on-site infiltration or they may be configured strictly as water quality control devices.

Permeable pavement is open graded asphalt or concrete with reduced fines and a special binder that allows for the rapid flow of water. Water is able to pass through the pavement by flowing through voids between the aggregate. Another way to construct a permeable paving surface is to use paver blocks. The paver blocks themselves are not permeable, but are installed with gaps between the pavers to allow stormwater to penetrate into the subsurface. The gap is integrated into the interlocking design of the paver blocks.

Beneath the porous surface is an aggregate subbase underlain with geotextile fabric. The aggregate subbase is typically divided into an upper filter course comprised of fine aggregate, and a lower reservoir course comprised of larger aggregate. The geotextile fabric provides separation between the aggregate and soil beneath and structural stability. Stormwater runoff from the paved surface and adjacent impervious

areas passes through the porous pavement to the aggregate reservoir where it is filtered and stored. The aggregate also serves as the road or parking area's support base and must be sufficiently thick to support traffic loads. Permeable pavement decreases runoff volume and peak discharge, filters pollutants, and may be used to recharge groundwater.

Permeable Pavement Construction Procedure:

- Inspect area, locate utilities.
- Select site for permeable pavement.
- Check and acquire appropriate permits.
- Excavate and grade to design depth of pavement/gravel reservoir system.
- Install gravel layer.
- Cover gravel layer with a permeable geotextile fabric. This fabric separates the rock from the overlying sand layer.
- Install sand layer.
- Wet sand to even out the surface before placement of the pavement grid; level sand with hand tools.
- The concrete block or plastic grid layer goes on top of the sand. This layer can be laid by hand. Or equipment can be used to efficiently lay the interlocking concrete blocks. Certain plastic grid pavers come in spools that are easy to roll
- Fill the voids with material (e.g., pea gravel, larger washed gravel, loamy sand, grass root systems).

Construction Materials Needed

Required construction materials are *Pavers*. Most of the systems are supported by a stone base that has large pore spaces, such as American Association of State Highway and Transportation Officials (AASHTO) #57 Stone. Options for paver systems include:

1. *Porous Concrete*: This pavement has stable air pockets encased within it that allow water to drain uniformly through into the ground below, where it can be naturally filtered. The material becomes stronger and more stable when it gets wet and so does not deteriorate as fast as other paving materials. Its use should be restricted to parking lots and local roads since it supports lighter loads than standard concrete.
2. *Grass Pavers*: Plastic rings in a flexible grid system are placed on a base of blended sand, gravel and topsoil, then filled with a topsoil such as sandy loam and planted with vegetation. This pavement gives designers a turfgrass alternative to asphalt or concrete for such low-traffic areas as firelanes, overflow and event parking, golf cart paths, residential driveways, and maintenance and utility access lanes. The support base and the rings' walls prevent soil compaction and reduce rutting and erosion by supporting the weight of traffic and concentrated loads, while the large void spaces in the rings allow a strong root network to develop.
3. *Gravel Pavers*: This pavement option is intended for high frequency, low speed traffic areas. The same ring structure as with the grass paver is used, but the voids in the rings are filled with gravel to provide greater load bearing support for unlimited traffic volumes and/or parking durations. Manufacturers provide specifications on the sieve analysis that should be used to generate the clean gravel fill for the rings, and a geotextile fabric is used to prevent the gravel infill from migrating to the soil subbase. Gravel pavers can be used for automobile and truck storage yards, high-throughput parking lots, service and access areas, loading docks, boat ramps, and outdoor bulk storage areas.
4. *Interlocking Concrete Paving Blocks*: The unique shape of these interlocking precast units leaves drainage openings that typically comprise approximately 10 percent of the paver's surface area. When properly filled with permeable material, the voids allow for drainage of stormwater through the pavement surface into the layers below. The system is a highly durable, yet permeable pavement capable of supporting heavier vehicular loads than grass or gravel pavers and offering the most flexibility in widespread application. Interlocking concrete paving blocks are resistant to heavy loads, easy to repair, require little maintenance, and are of high quality. These systems also have the highest materials and construction costs.
5. *Sandy or loamy sand in-situ soil*. Soils that contain significant levels of silt or clay or that are highly compressible, lack cohesion, or expand or contract with moisture may not be feasible for permeable pavers without the use of geotextiles to provide support. A detailed analysis of the soils and feasibility should be conducted when these conditions are encountered.
6. Permeable Geotextile Fabric.
7. *Sand*.

Installation Procedure

To install:

1. Locate/Mark any utilities.
2. Check all permits.
3. Verify location, type, installation, and elevations of edge restraints around the perimeter area to be paved.
4. Verify that the subgrade preparation, compacted density, and elevations conform to the specifications.

5. Install edge restraints per the drawings and manufacturer's recommendations at the indicated elevations.
6. Verify that the base is dry, uniform, even, and ready to support sand, pavers, and imposed loads.
7. Beginning of bedding sand and paver installation means acceptance of base and edge restraints. Spread the bedding sand evenly over the base course and screed to a nominal 1 in. (25 mm) thickness, and not to exceed 1 1/2 in. (40 mm) thick. The screeded sand should not be disturbed. Place sufficient sand to stay ahead of the laid pavers. Do not use bedding sand to fill depressions in the base surface.
8. Ensure that pavers are free of foreign material before installation. Install the pavers in the pattern(s) shown on the drawings, maintaining straight pattern lines. Joints between the pavers shall be between 1/16 and 3/16 in. (2-5 mm) wide.
9. Fill gaps at the edges of paved areas with cut pavers or edge units. Cut pavers should be no smaller than one-third of the full unit size along edges subject to vehicular traffic. When required, cut pavers with a paver splitter or masonry saw.
10. Use a low-amplitude, high-frequency plate vibrator capable of 5,000 lb (22kN) compaction at a frequency of 75-100 hz to compact pavers. Vibrate the pavers, sweeping dry joint sand into the joints and vibrating until they are full. This will require 2 to 3 passes with the vibrator. Do not vibrate within 3 ft (1m) of the unrestrained edges of the paving units.
11. When completing work for the day, all pavers to within 3 ft (1m) of the laying edge must be left fully compacted with sand-filled joints.
12. Upon completion, sweep off excess sand.
13. Final surface elevations shall not deviate more than 3/8 in. (10 mm) under a 10 ft (3m) long straight edge. The surface elevation of the pavers shall be 1/8 to 1/4 in. (3 to 6 mm) above adjacent drainage inlets, concrete collars or channels.
14. After removal of excess sand, check final elevations for conformance to the drawings.
15. Upon completion of the work, clean up all work areas by removing any debris, surplus material, and equipment from the site.

Typical Maintenance Schedule

The main goal of a maintenance program for porous or permeable paving surfaces is to prevent clogging by fine sediment particles. Vacuum the pavement three (3) to four (4) times annually, depending on the average sediment loading.

- Inspection of the site should occur monthly for the first few months after construction. Then inspections can occur on an annual basis, preferably after rain events when clogging will be obvious.
- Conventional street sweepers equipped with vacuums, water, and brushes can be used to restore permeability. Vacuum the pavement three (3) to four (4) times annually, depending on the average sediment loading.
- Potholes and cracks can be filled with patching mixes, and spot clogging of porous concrete may be fixed by drilling approximately 0.5-in. holes every few feet. Damaged interlocking paving blocks can be replaced.
- An active street sweeping program in the site's drainage area will also help to prolong the functional life of the pavement.

NOTE: Do not pressure wash the permeable/porous pavements, as this may force particles deeper into the pavement where it can no longer be removed by vacuuming. Abrasive materials for snow treatment, such as sand, should be prohibited to prevent clogging of paving voids. Settlement of paving block systems may require resetting. Cracks and settlement in asphalt or concrete may require cutting and replacing the pavement section.

Regional Considerations

Climate concerns will vary with each locality and knowledge of climate regimes is an important factor in the application of permeable pavements. Construction details should be tailored to the specific soil and climactic conditions that exist on the site receiving the pavement.

Factors to consider:

See Climate Chart in *Appendix 1*

Potential Limitations

Permeable pavement should not be used for roadways with traffic heavier or more frequent than that on residential roads.

Effectiveness of Permeable Pavements

Runoff Volume Reduction. Permeable Pavements effectively eliminate the runoff that would have been generated from the paved area. This can significantly decrease the volume of runoff leaving the site.

Pollutant Removal Effectiveness

Pollutant	Removal Effectiveness
Suspended Solids	82–95%
Total Nitrogen	80–85%
Total Phosphorus	65%
chemical oxygen demand (COD)	82%
Metals	98–99%
Sources: Schueler 1987	

Water Quality Improvement of Various Pavers

Material	Water Quality Effectiveness
Conventional Asphalt/ Concrete	Low
Brick (in a loose configuration)	Medium
Natural Stone	Medium
Gravel	High
Wood Mulch	High
Cobbles	Medium
Source: BASMAA 1997	

References

Bay Area Stormwater Management Agencies Association (BASMAA). 1997. Start at the source: Residential site planning and design guidance manual for stormwater quality protection. San Francisco, CA: BASMAA.

Booth, D. B., J. Leavitt, and K. Peterson. (1996) The University of Washington permeable pavement demonstration project: Background and first-year field results. Accessed June 2007, <http://depts.washington.edu/cwws/Research/Reports/rc3.pdf>

Brattebo, B. O., and D. B. Booth. 2003. Long-term stormwater quantity and quality performance of permeable pavement systems. *Water Research* 37:4369-4376.

Georgia Department of Natural Resources. 2006. Technique 7-permeable paving, *Green Growth Guidelines*. Chapter 3.3.8: 53-58. Accessed 29 June 2006, <http://crd.dnr.state.ga.us/assets/documents/GGG3C.pdf>

Low impact development center, low impact development permeable paver specification, Accessed June 2007, <http://www.lowimpactdevelopment.org/epa03/pavespec.htm>

Low Impact Development Center, *Low impact development urban design tools website*, <http://www.lid-stormwater.net/>

Schueler, T. 1987. Controlling urban runoff: A practical manual for planning and designing urban BMPs. Washington, DC: Metropolitan Washington Council of Governments.

PWTB 200-1-62
1 October 2008

Tennis, P. D., M. L. Lemming, and D. J. Akers. 2004. Pervious concrete pavements. EB302.02. Skokie, IL: Portland Cement Association, and Silver Spring, MD: National Ready Mixed Concrete Association,
http://www.aprmca.com/2006/images/pervious_concrete/pc_EB302_PCA.pdf

ToolBase Resources Technology Inventory, PATH (The Partnership for Advancing Technology in Housing)
<http://www.toolbase.org/Technology-Inventory/Sitework/permeable-pavement>

PWTB 200-1-62
1 October 2008



**US Army Corps
of Engineers®**
Engineer Research and
Development Center

Pollution Prevention Technology

Draft 06.29.2007

How Pollution Prevention Works

Pollution Prevention (P2) is an Low Impact Development (LID) tool used during all phases of the construction process to minimize negative environmental impacts from development activities. The term reflects an approach to both education and to site development that seeks to educate users on the merits of preventing pollution from occurring on a site. Pollution prevention programs are tailored to each activity that needs P2 measures.

P2 may be an educational program that provides information on how to reduce pollution production during normal activity. Such a program provides information on alternative practices, and materials, which, when implemented, will generate less pollution than conventional practices.

P2 in practice is the combination of source controls, conservation measures, site management and materials choices. Examples include installing source control pollution measures that treat small quantities of pollutants and remove them from being able to create larger scale problems. Improved “housekeeping” to prevent spills, runoff or other pollution generation becomes part of site management standard operating procedures. Recycling programs are another example of a P2 program.

Materials Needed

Education materials and knowledge of the waste stream generation of a particular activity provides the necessary information for determining the appropriate P2 strategy. There are several online resources that may be linked to from the USEPA website on P2 (<http://www.epa.gov/p2/>). Recycling programs will require collection bins, transfer stations and a means to collect the materials. Typical P2 fact sheets of use would be those for road construction, lead and other heavy metal removal/prevention, recycling programs and public service announcements geared towards changing individual behaviors. A public service education program requires training materials, brochures and local signs to be created to share information. A web-based set of materials will facilitate information sharing.

P2 Program Procedure:

- Evaluate areas where pollution generation needs to be prevented
- Develop new SOPs which will act to prevent pollution
- Develop educational materials targeted at users of an area/generators of pollution
- Distribute educational materials
- Implement new SOPs
- Monitor results

Installation Procedure

Each P2 effort will have its own installation strategy. If it is a ground mounted sign, the installation may be accomplished using local SOPs for sign installations. Other materials such as brochures and training materials that are delivered live are portable and will require standard copy facilities. Web-based tools are an effective means of distributing P2 practices over a large geographic range and will be administered from a central site. Implementing a P2 strategy requires the development or use of appropriate P2 materials that pertain to the activity.

Typical Maintenance Schedule

Pollution prevention is an ongoing practice. Education materials will need to be updated annually and progress towards reaching P2 goals monitored.

Regional Considerations

Climate concerns will vary with each locality and knowledge of climate regimes is an important factor in the pollution prevention process. One must know how an area rebounds from a site disturbance to make appropriate decisions as to how much of a site can be environmentally sustainably disturbed (and mitigated), and which types of pollution are more critical to control.

Factors to consider:

See: Climate Chart in Appendix 1.

Potential Limitations

Time for training, sources of alternative materials, availability of personnel and vehicles to manage a recycling program, and funding for P2 prevention may occur. In certain areas, materials may need to be prepared in multiple languages so that effective communication may occur.

Effectiveness of Pollution Prevention

P2 measures can be very effective at reducing pollution if the recommended practices are followed.

Typical P2 Information

Policy documents:

Indiana Department of Natural Resources (DNR) internal strategies for P2:

1. [Test P2 Integration in Mercury Policy and Rules.](#)
2. [Improve Office of Air Quality \(OAQ\)/OPPTA Rule Development and Outreach Coordination.](#)
3. [Develop P2 in OAQ Rules and Permits Guidebook.](#)
4. [P2 in Enforcement.](#)
5. [P2 in Waste Inspections.](#)
6. [P2 in Water Inspections.](#)
7. [P2 in Air Inspections.](#)
8. [P2 in Remediation.](#)
9. [Energy Efficiency and Alternative P2 Technologies for Drinking Water Supply.](#)
10. [P2 in Wastewater Treatment Operator Certification.*](#)

Classroom materials:

http://www.epa.gov/superfund/students/clas_act/haz-ed/10chems.htm

Clean Boating Lesson Plan, Morrow, Donna and Elizabeth Fuller Valentine, Feb 1999, updated Oct. 2005, MD Clean Marina Initiative, Maryland Department of Natural Resources. pdf[†]

Ad campaigns:

Recycling programs:

Tax Incentive or Regulatory Incentive programs:

Pollution Prevention in Oklahoma Means, Retrieved June 13, 2007 from <http://www.deq.state.ok.us/csdnew/p2.htm>

* Internal IDEM Pollution Prevention Integration Projects,

http://www.in.gov/idem/prevention/integration/ten_steps.htm

[†] <http://www.dnr.maryland.gov/boating/cleanmarina/lessonplans/Intro05.pdf>

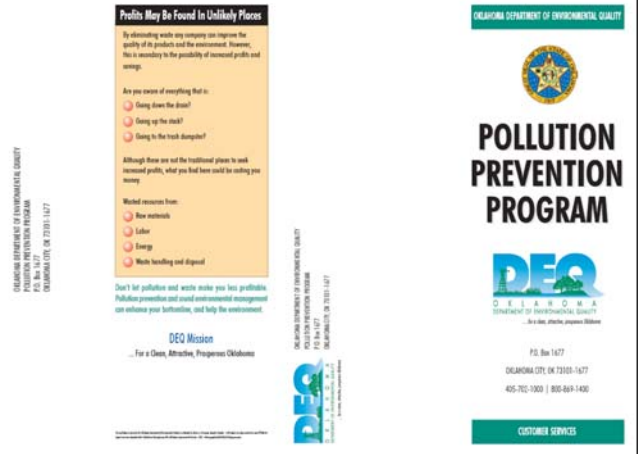

Brochures:

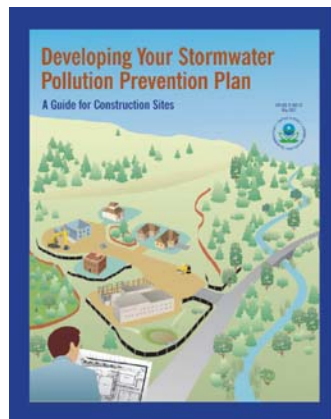

http://www.epa.gov/npdes/pubs/sw_swppp_guide.pdf

USEPA resources:

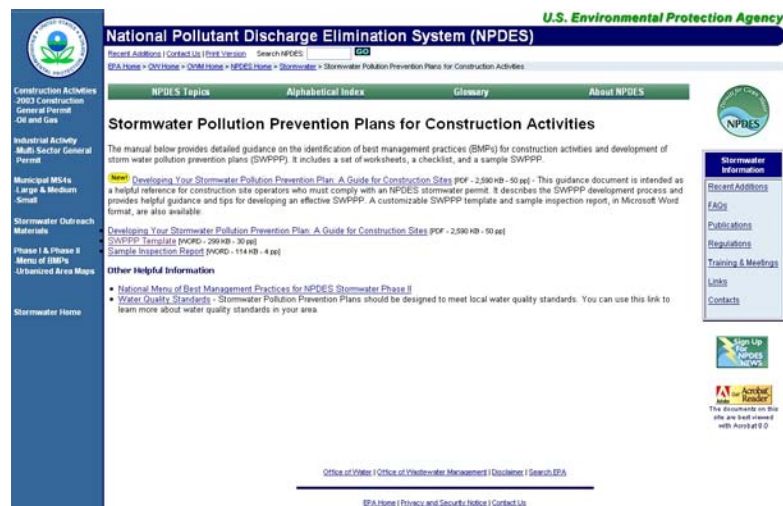

<http://cfpub.epa.gov/npdes/stormwater/swppp.cfm>

References

U.S. Environmental Protection Agency. 2007. Developing your stormwater pollution prevention plan: A guide for construction sites. EPA 833-R-060-04. Accessed June 2007, http://www.epa.gov/npdes/pubs/sw_swppp_guide.pdf

U.S. Environmental Protection Agency, Pollution prevention toolbox. Accessed 13 June 2007, <http://www.epa.gov/reg5rcra/wptdiv/p2pages/p2.pdf>

PWTB 200-1-62
1 October 2008

U.S. Environmental Protection Agency, Pollution prevention (P2). Accessed
13 June 2007, <http://www.epa.gov/p2/>

What is pollution prevention. Accessed 13 June 2007,
http://www.p2.org/about/nppr_p2.cfm

P2 Information – topic hubs™ and sector resources. Accessed 13 June 13 2007,
<http://www.p2rx.org/P2InfoNexpert/sectorInfo.cfm?SectorID=9>

Hazardous chemicals. Handout. Accessed 13 June 2007,
http://www.epa.gov/superfund/students/class_act/haz-ed/10chems.htm



**US Army Corps
of Engineers®**
Engineer Research and
Development Center

Reforestation/Afforestation Technology Draft 06.29.2007

How Reforestation Works

Reforestation and Afforestation are Low Impact Development (LID) tools typically employed after a site has been abandoned. Planting trees serves to improve soil structure and restore a forest hydrologic condition to a site. Runoff is reduced and multiple benefits such as habitat creation, carbon sequestration and cooling are produced as the forest grows.

To see the maximum benefit, the area should be planted densely and allowed to grow into a mature stand of trees with no clearing of undergrowth.

It may be employed in conjunction with other LID tools.

Required construction materials are:

1. Measuring devices.
2. Marking materials.
3. Tree whips (bareroot). Use native species found in adjacent undisturbed areas.
4. Dibble and other digging hand tools.
5. Staking materials.
6. Growing tubes (optional, for areas of heavy grazing predation).
7. Shredded hardwood mulch or other locally available mulch material.
8. Water.

Reforestation Construction Procedure:

- Clear area of debris
- Install erosion control measures if needed
- Mark area for planting
- Rehydrate whips
- Plant whips
- Water

Construction Materials Needed

Installation Procedure

To install:

1. If the area is in a grassy cover, erosion and sedimentation controls may not be necessary due to the small scale disruption of earth to accomplish tree planting. If the area is disturbed then normal erosion and sedimentation controls should be installed prior to planting the afforestation or reforestation areas.
2. The area for tree planting should be marked and flagged or staked in a 10-ft grid. The tree whips will be installed on the grid, in “drifts” (see detail) so that the mix of species is distributed in a naturalistic fashion.
3. Soak whips overnight in water to rehydrate prior to planting.
4. Whip holes should be hand dug and whips should be placed in holes that are 1 ft wide and as deep as the root structure on the whip. The whips should be planted to the same level as they were originally grown (where the base of the whip flares out above the roots).
5. Stake whips with single stake.
6. Water whips after installation.
7. Do not fertilize.

Typical Maintenance Schedule

During the first growing season, provide 1-in. of water/week if there is no normal rainfall.

Remove all stakes after 6–12 months.

Climate concerns will vary with each locality.

**Regional
Considerations**

Factors to consider: Determine best planting for bare root plants for the locality being planted. Consult with local forestry or horticultural authorities or landscape architects for advice on best time to plant. Species selection should be for species indigenous to an area.

See: Climate chart in Appendix 1

Potential Limitations

Reforestation is not appropriate in areas where the native vegetation is not forest, for example, in desert or tall-grass prairie. In these areas, it is preferable to re-establish the native vegetation.

**Effectiveness
of Reforestation
References**

Over time, reforestation can return a previously developed site to its pre-development hydrologic function, effectively eliminating the generation of stormwater runoff.

Fairfax County. 2005. Reforestation/afforestation. LID BMP Fact Sheet,

http://www.lowimpactdevelopment.org/ffxcty/6-3_reforestation_draft.pdf

Puget Sound Action Team. 2005. LID technical guidance manual for Puget Sound: Low impact development. Accessed June 2007,

http://www.psat.wa.gov/Publications/LID_tech_manual05/04_vegetation.pdf



**US Army Corps
of Engineers®**
Engineer Research and
Development Center

Selective Grading Technology

Draft 06.29.2007

How Selective Grading Works

Selective Grading is an Low Impact Development (LID) tool used during the construction phase of the construction process to minimize negative environmental impacts from development activities. The term reflects an approach to site grading that values the existing vegetation and seeks to preserve existing waterways and to minimize site disturbance.

Planning selective grading has historically been done in the field, but could be combined with geographic information system (GIS) data to allow for large area surveys to be completed prior to ground truthing construction planning decisions. GIS mapping of a site would identify relevant waterways and vegetative cover, and would provide terrain information that could be used to map out a grading strategy for the activities that need to occur on a site.

Goals of selective grading:

- Minimize soil disturbance.
- Minimize tree removal.

Selective Grading Construction Procedure:

- Evaluate area where all grading will occur
- Flag out and install protective fencing around areas that are not to be graded
- Install appropriate erosion and sedimentation controls on the perimeter of the grading area

Construction Materials Needed Installation Procedure

Selective grading is an approach to the construction process, and does not require additional materials.

To install:

1. Limit clearing and grading to areas to be actively used.
2. Limit development footprint on steep slopes (slopes greater than or equal to 25 percent).
3. Establish "Tree Protection Zones" around mature trees. Construct fencing around the protection zone to prevent disturbance. Tree Protection Zones typically extend 1.5 ft for each inch of the tree's radius.
4. Align roads with natural topography to minimize cut and fill.
5. Clearly delineate and flag disturbance areas, routes to be used by heavy machinery, and staging areas.

Regional Considerations

Climate concerns will vary with each locality and knowledge of climate regimes is an important factor in the selective grading process. Knowledge of how an area rebounds from a site disturbance is necessary for making appropriate decisions as to how much of a site can be environmentally sustainably disturbed.

Factors to consider: Selective Grading takes into account local conditions and desired outcomes and works to minimize site disturbance. In some areas, due to the long site recovery times, greater emphasis on minimizing disturbance must be made.

See: See Climate chart in Appendix 1

Potential Limitations

Certain site conditions may limit the appropriateness of site fingerprinting.

**Effectiveness of
Site Fingerprinting
References**

Selective grading can significantly decrease the volume of runoff generated onsite, eliminating the need to install additional stormwater treatments.

Zickler, L., and O. Dennison. 2005. Response to Comments on PSAT LID assistance file no. 205247.30, task 34. Accessed June 2007,
<http://www.psat.wa.gov/Programs/LID/assistance/PDF%20Local%20Regulation%20Assistance%20Project%202005/l.%20Technical%20Assistance%20and%20Recommendations/C.%20Issaquah.%20City%20of/3.%20Response%20to%20Comments%20Memo.pdf>

Reining in the storm—one building at a time: A basic guide to low impact development
Accessed June 2007,
<http://www.southportland.org/vertical/Sites/%7B7A5A2430-7EB6-4AF7-AAA3-59DBDCFA30F2%7D/uploads/%7B2CB16D05-6D62-40C1-BD68-4C51A52860EF%7D.PDF>



**US Army Corps
of Engineers®**
Engineer Research and
Development Center

Site Fingerprinting Technology

Draft 06.29.2007

How Site Fingerprinting Works

Site Fingerprinting is an Low Impact Development (LID) tool used during the planning and construction phases of the construction process to assess a site and find the best location for given activities to occur while incurring minimal site disruption or creating opportunities for site restoration through the construction process.

Site fingerprinting has historically been done in the field, but could be combined with geographic information system (GIS) data to allow for large area surveys to be completed prior to ground truthing construction planning decisions.

The site fingerprinting process will typically include identifying areas for location of appropriate LID tools on a site that is going to be disturbed or that has already been disturbed, but needs environmental mitigation.

Materials Needed

Site fingerprinting is a planning process, and does not require additional materials. Tree protection structures and habitat protection measures may be required on site.

Procedure

1. Visit site, or obtain topographic maps of site, showing waterbodies, soils, and key habitat areas.
2. Plan site development so as to minimize disturbance in key areas. Places to avoid disturbance:
3. Streams
4. Floodplains
5. Wetlands
6. Steep slopes
7. High-permeability soils
8. Mature forest
9. Other critical habitat.
10. Reduce grading and compaction, and maintain existing topography to the extent possible.
11. Lay out site development so as to minimize and disconnect impervious areas. Plan to use bioretention or other BMPs to treat runoff from impervious areas.
12. Plan construction activities so as to impact the smallest possible land area. Site stockpiles within the development envelope. Do not drive heavy machinery outside of the development envelope.
13. Clearly delineate and flag areas not to be disturbed.

Site Fingerprinting Construction Procedure:

- Visually evaluate site using topographic maps, GIS, arial photography or other remote sensing information
- Map out sensitive areas to avoid disturbing
- Ground truth map information in the field
- Proceed with space planning for site

Typical Maintenance ~~Signage~~ Considerations

Periodically check signs demarking and indicating non-disturbance areas. Climate concerns will vary with each locality and knowledge of climate regimes is an important factor in the site fingerprinting process. Factors to consider:

See: Climate chart in Appendix 1

Potential Limitations

Site fingerprinting is an integral part of Low Impact Development, and should be used on all sites. Access to GIS resources will improve the ease of using Site

**Effectiveness of Site
Fingerprinting
Reference**

Fingerprinting. Some land uses may require large-scale clearing and compaction, in which case site fingerprinting may not be practical.

Site fingerprinting can significantly decrease the volume of runoff generated onsite, eliminating the need to install additional stormwater treatments.

Georgia Department of Natural Resources. 2006. Site fingerprinting utilizing GIS/GPS technology. Green growth guidelines. Chapter 1: 1-8. Accessed 29 June 2007, <http://crd.dnr.state.ga.us/content/displaycontent.asp?txtDocument=969>



**US Army Corps
of Engineers®**
Engineer Research and
Development Center

Vegetated Swales Technology

Draft 06.26.2007

How Vegetated Swales Work

Vegetated swales are an Low Impact Development (LID) tool that uses the physical, chemical, and biological processes in plants and soils to absorb and treat pollutants and help maintain the hydrologic, or water balance of an area. The pollutants, such as oil and grease or metals from machinery are absorbed by the soils and plants and treated. The volume of runoff is also absorbed by the soils and plants, which reduces the pollutant loads.

Vegetated swales are designed to collect sheet flow of runoff from small lengths of drainage to help absorb water and then convey the excess runoff from storms. The drainage area to a swale should typically be less than 100 ft in length and no more than 1 acre of drainage. Vegetated swales are designed to slow stormwater from small drainage areas with low flow and small populations that drain directly to them. The vegetated swale may be directed to a culvert (sized to encourage 24-hr ponding) and/or have a series of check dams installed along the course of the swale to further slow the flow of the water along the drainage path. Shrubby vegetation provides both habitat creation opportunities and larger root structures, which are capable of processing a large volume of water.

Flattening the course of the swale and lengthening the distance water has to travel prior to entry into either waterways or stormdrain systems allows for natural processes of infiltration, evaporation, and transpiration to occur all along the flow path.

Required construction materials are:

1. *Excavation Equipment*: grading machinery.
2. *Handtools*: shovels, picks, hoses, wheelbarrows.
3. *Marking Materials*: flagging, flags, or spray paint to delineate area.
4. *Silt Fence*: materials for creating and installing an appropriate silt fence.
5. *Planting Design*. Choose plants appropriate to region (native).
6. *Plants* should be in #1, #2 or #3 size containers with roots that extend to the pot edges.
7. *Shredded Hardwood Mulch*. Shredded hardwood mulch is a byproduct of sawmill production and provides organic texture to the planting media; if it is not locally available, coarse textured organic matter may be substituted such as pine bark nuggets or coarse leaf litter.

Vegetated Swale Construction Procedure:

- Inspect area, locate utilities
- Select site for vegetated swale
- Check and acquire appropriate permits
- Install Erosion Control Silt Fence around perimeter of vegetated swale construction area
- Remove trees, brush and debris from vegetated swale area
- Grade site to appropriate levels
- Scrape topsoil and stockpile; stabilize stockpile
- Install vegetated swale materials as per construction specification
- Mulch new plantings with 3" of mulch
- Water

Construction Materials Needed

Installation Procedure

To install:

1. Locate/Mark any utilities.
2. Check all permits.
3. Mark out area for vegetated swale; orient length of swale parallel to the slope so that the runoff enters as sheet flow.
4. Allow room for a pre-treatment strip of grass or gravel to be installed along with the vegetated swale.
5. Inspect area and soil test to determine that there are no measurable contaminants (e.g., trinitrotoluene (TNT) >10 percent, perchlorate, etc.) existing in the soils that would require the use of a liner in the swale area and a connection to a stormwater pipe system.
6. Install Erosion and Sedimentation fencing to keep soils in the construction area contained.
7. Excavate area as per plans; remove soil as specified on plan.
8. Bring plants to site and lay out in planting area as per plan.
9. Plant plants; dig each plant hole 2X as wide as the pot width and the same depth as the plant rootball height.
10. Mulch plants by hand with 3-in. of mulch; mulch to within 4-in. of the plant stem.
11. Provide 1 in. water/week for the first year if there is no rain during the week.

Typical Maintenance Schedule

First Year:

- Initially, water plants weekly when there has been no rain. Once plants have become established, watering is necessary only under drought conditions.

Monthly:

- Remove accumulated trash and debris.
- Remove unwanted weeds (see note below).
- Every Six Months.
- Reapply mulch to a depth of 3 in.

Annually:

- If necessary, remove accumulated sediment from bioretention cell and pretreatment area.
- Water in the facility should infiltrate the system within 4-6 hrs or less, if longer, the underdrain may be clogged. Underdrain systems are built with a clean out pipe, allowing the operator the ability to clean and unclog the system. Flush underdrain if it has become clogged.
- Replace any dead plants.
- Prune plants as appropriate for each plant species used.

Note: Weeding is not necessary for proper functioning. In fact, plants that invade the bioretention facility are often well adapted to site conditions, and will improve performance. However, unwanted plants can be removed if they are invasive or aesthetically unappealing.

The high nutrient loads typical of stormwater runoff usually make fertilization unnecessary.

Regional Considerations

Climate concerns will vary with each locality. Bioretention Strips are more or less effective depending on a variety of climatic factors, primarily temperature and moisture regimes.

Factors to consider:

- In cold climates, bioretention cells may fail to function under freezing conditions.
- In climates that experience high-intensity storms, bioretention may be insufficient to capture large runoff volumes.
- In climates that experience prolonged drought conditions, regular watering may be required to keep plantings alive.

See: Climate Chart in Appendix E1

Potential Limitations

Certain site conditions may limit the appropriateness of vegetated swales. Vegetated swales should not be used where slopes are greater than 20 percent, or where the depth to the water table is less than 6 ft.

In areas with high sediment loads, pretreatment is necessary to avoid clogging the swale. Grass buffer strips or settling basins should be used to remove sediment from runoff before it enters the vegetated swale.

Effectiveness of Vegetated Swales

Runoff Volume Reduction. Vegetated swales are used to convey stormwater to larger storage areas. Their primary function is to slow runoff velocity and reduce peak flows, though they do infiltrate some stormwater and can provide storage during smaller storm events.

Pollutant Removal Effectiveness

Pollutant	Reported Removal Rate
Sediment (TSS)	81%
chemical oxygen demand (COD)	67%
Nitrate	38%
Total Phosphorus	9%
Hydrocarbons	62%
Cadmium	42%
Copper	51%
Lead	67%
Zinc	71%
Sources: USEPA 1999	

Reference

U.S. Environmental Protection Agency. 1999. Vegetated swales, Storm Water Technology Fact Sheet. EPA 832-F-99-006. Accessed 13 June 2007, <http://www.epa.gov/owm/mtb/mtbfact.htm>

PWTB 200-1-62
1 October 2008

APPENDIX C: LID Key Terms

Afforestation - The process of replanting trees to recreate a forested area. Typically a 10-ft grid of whips of native (to a region) tree species is used. Up to a 50% mortality of whips is an acceptable loss rate.

Bioretention - Engineered process to mimic natural hydrologic process so that stormwater runoff is minimized, water quality is improved by nutrient removal and groundwater recharge occurs.

Clearing - removing brush and other vegetative cover to the ground level

Cover Crop - Seed crop, locally appropriate species that are applied after site disturbance to re-establish vegetative cover on a site to prevent soil erosion. Typically fescue, red clover or other grass mix that has a combination of rapidly establishing annual plants and longer lasting perennials

Hydrologic Process - natural interactive process where rainwater is absorbed into soils for groundwater recharge and vegetation growth; minimal natural runoff as it is used close to where it falls

Low Impact Development Tools - A series of vegetated and non-structural engineered techniques and features that improve water quality and reduce stormwater runoff.

NPDES - National Pollutant Discharge Elimination System - a Clean Water Act Federal Permit administered by USEPA; length of Permit typically not longer than 5 years. See USEPA-Headquarters Phase 2 website:
<http://cfpub.epa.gov/npdes/stormwater/swphases.cfm#phase2>

Silt Fence - Fabric fencing trenched in/installed with supporting wooden stakes around a construction area to prevent soil from washing off the area;
<http://www.salixaec.com/siltfence.html>

Site Disturbance - Occurs when the natural cover is removed through normal training activity on site; typically leaves exposed soils likely to erode and cause water quality problems

PWTB 200-1-62
1 October 2008

Site Stabilization - steps taken so that military activities on a site do not cause erosion and water quality problems

Soil Stockpile - scraping of the topsoil of an area and collecting it into an onsite pile

Stormwater runoff - Water that runs across the surface of the earth after a rain; it ends up in streams, rivers, ponds, lakes, bays and the ocean.

Tactical Assembly Area - An area that is generally out of the reach of light artillery and the location where units make final preparations (pre-combat checks and inspections) and rest, prior to moving to the line of departure.

See also assembly area; line of departure.

<http://www.thefreedictionary.com/tactical+assembly+area>
(DOD, NATO) 1. An area in which a command is assembled preparatory to further action. 2. In a supply installation, the gross area used for collecting and combining components into complete units, kits, or assemblies.
<http://usmilitary.about.com/cs/generalinfo/g/assare.htm>

APPENDIX D: References and Resources

- Addressing Encroachment with Cooperative Agreements and Conservation*, Retrieved 5 June 2007 from:
<http://aec.army.mil/usaec/natural/natural03a04.html>
- Anguiana, Gary. Draft. Low Impact Technologies to Reduce Pollution from Storm Water Runoff (SI-0405), due to be complete 2007. Retrieved 24 May 2007 from:
<http://www.estcp.org/Technology/SI-0405-FS.cfm>
- Appendix B: Drop Zone Support Teams*, Retrieved 1 June 2007 from:
<http://www.globalsecurity.org/military/library/policy/army/fm/90-26/Appb.htm>
- Appendix G: Natural Resources - Conservation DEP FY2-6 Annual Report to Congress*, Retrieved 25 May 2007 from:
https://www.denix.osd.mil/denix/Public/News/OSD/DEP2006/App_G_NaturalResources_osd-draft.pdf
- Availability of the Draft Environmental Impact Statement for the Digital Multi-Purpose Range Complex at Fort Benning, GA, *Federal Register Environmental Documents, Feb 13, 2004, Vol. 69, Number 30*. Retrieved 11 June 2007 from:
<http://www.epa.gov/fedrgstr/EPA-IMPACT/2004/February/Day-13/i2848.htm>
- Background Information on National Training Center at Fort Irwin*, Retrieved 11 June 2007 from:
<http://www.fortirwinlandexpansion.com/Background.htm>
- Base Realignment & Closure (BRAC)*. Retrieved 24 May 2007 from:
<https://www.denix.osd.mil/denix/Public/Library/Cleanup/CleanupOfc/brac/index.html>
- Bases into Places*. Retrieved 5 June 2007 from:
http://www.epa.gov/smartgrowth/pdf/bases_into_places.pdf
- Bay Area Stormwater Management Agencies Association (BASMAA). 1997. *Start at the Source: Residential Site Planning and Design Guidance Manual for Stormwater Quality Protection*. San Francisco, CA: BASMAA.
- Booth, D. B., J. Leavitt, and K. Peterson. 1996. *The University of Washington Permeable Pavement Demonstration Project - Background and First-Year Field Results*. Retrieved June 2007 from:
<http://depts.washington.edu/cwvs/Research/Reports/rc3.pdf>
- Brattebo, B. O., and D. B. Booth. 2003. Long-term stormwater quantity and quality performance of permeable pavement systems. *Water Research* 37: 4369-4376.

PWTB 200-1-62
1 October 2008

- Bujang Bin Kim Huat, H. A. Faisal, and S. S. Gue. 2004. Tropical Residual Soils Engineering.
- Bullock, Shana Wales, and Helen K. Merkel. 2007. Low-Impact Development in the Chesapeake Bay Watershed: Army Case Studies, Challenges, and Lessons Learned, *Civil Engineering Database*. Retrieved 24 May 2007 from:
<http://www.pubs.asce.org/WWWdisplay.cgi?0523333>
- Camp Logan National Guard Rifle Range at Illinois Beach State Park, Lake County, Illinois, Retrieved 12 June 2007 from:
<http://dnr.state.il.us/orep/nrrc/cultural/cmpLogan/camplogan.htm>
- Center for Land Use Interpretation, Fort Bragg, Retrieved 24 May 2007 from: <http://ludb.clui.org/ex/i/NC3134/>
- Chollak, T., and P. Rosenfeld. 1998. Guidelines for Landscaping with Compost-Amended Soils, Redmond, WA: City of Redmond Public Works.
- Coffman, Larry. 2007. *Low Impact Development: A New Paradigm for Stormwater Management "Integrated Micro-Scale Management" "Maximizing the Hydrologic Function of the Landscape."* PowerPoint presentation, retrieved 5 June 2007 from:
<http://www.saj.usace.army.mil/projects/StormWater/LID%20Overview%20Florida/sld001.htm>
- Construction Criteria Base, Whole Building Design Guide. 2004. United Facilities Criteria Low Impact Development, UFC 3-210-10, 25 October 2004, Retrieved 24 May 2007 from:
http://www.wbdg.org/ccb/DOD/UFC/ufc_3_210_10.pdf
- Caraco, D., and R. Claytor. 1997. Stormwater BMP Design Supplement for Cold Climates. Retrieved June 2007 from:
<http://www.cwp.org/cold-climates.htm>
- Davis, A. P., M. Shokouhian, H. Sharma, and C. Minami. 2006. Water Quality Improvement through Bioretention Media: Nitrogen and Phosphorus Removal. *Water Environment Research*, 78(3): 284-293.
- Dietz, M. E., and J. C. Clausen. 2005. A Field Evaluation of Rain Garden Flow and Pollutant Treatment. *Water, Air, and Soil Pollution*, 167: 123-138.
- Defense Environmental Network & Information Exchange, Retrieved 24 May 2007 from:
<https://www.denix.osd.mil/denix/denix.html>

- Department of the Army. 2002. *Commander's Guide: Army Installation Standards*, Assistant Chief of Staff for Installation Management Facilities Policy Division, 1 October 2002, Washington, DC. Available online at: <http://www.hqda.army.mil/acsimweb/homepage.shtml>
- Department of the Army. 2007. *Intent to Prepare and Environmental Impact Statement for the Digital Multi-Purpose Range Complex at Fort Benning, GA*, Retrieved 11 June 2007 from: https://www.infantry.army.mil/EMD/program/legal/dmprc/departement_of_defense.htm
- Department of Defense (DoD). 2004. Environmental and Explosives Safety Management on Operational Ranges Within the United States. DoD Directive No. 4715.11, 10 May 2004, certified as current 24 April 2007. Retrieved 24 May 2007 from: <http://www.dtic.mil/whs/directives/corres/pdf/471511p.pdf>
- _____. 2007. Innovative Readiness Training (IRT), FY07 Project Highlights. Retrieved 12 June 2007 from: http://www.defenselink.mil/ra/documents/IRT%20Project%20Overview%20Final_.pdf
- _____. 2007. *Environmental Security*. Retrieved 1 June 2007 from: http://www.dod.mil/execsec/adr95/envir_5.html
- _____. 2006. The Secretary of Defense Environmental Awards 2006. Retrieved 1 June 2007 from: <https://www.denix.osd.mil/denix/Public/News/OSD/SecDef06/ brochure.pdf>
- _____. 2001. Sustainable Design for Military Facilities. Appendix B, Environmental Technical Letter (ETL) 1110-3-491 Retrieved June 2007 from: <http://www.bragg.army.mil/Sustainability/library/pdf/sustainableDesignForMilitaryFacilities.pdf>
- Department of Environmental Quality. 2003. Preliminary Report of The Low Impact Development Assessment Task Force, Richmond, VA, 1 Nov 2003. Retrieved 24 May 2007 from: <http://www.deq.state.va.us/regulations/pdf/lidtd110103.pdf>
- ECOS-DOD Sustainability Work Group. Retrieved 24 May 2007, http://www.ecos.org/section/sustainability_work_group
- Environmental Management at Operating Outdoor Small Arms Firing Ranges. Retrieved 12 June 2007 from: <http://www.itrcweb.org/Documents/SMART-2.pdf>

- Deletic, A., and T. D. Fletcher. 2006. Performance of grass filters used for stormwater treatment - a field and modeling study. *Journal of Hydrology*, 317: 261-275.
- The Environmental Site Closeout Process Guide*, Retrieved 24 May 2007 from:
https://www.denix.osd.mil/denix/Public/Library/Cleanup/CleanupOfc/Documents/Cleanup/SCG_contentsCU.html
<http://isis.hampshire.edu/mil/>
- Fairfax County. 2005. Reforestation/Afforestation. LID BMP Fact Sheet. 28 February 2005.
http://www.lowimpactdevelopment.org/ffxcty/6-3_reforestation_draft.pdf
- Faucette, L. B., C. F. Jordan, L. M. Risse, M. Cabrera, D. C. Coleman, and L. T. West. 2005. Evaluation of Stormwater from: Compost and Conventional Erosion Control Practices in Construction Activities, *Journal of Soil and Water Conservation*, 60(6): 288-297.
- Fifty, William. *Storm Water Guidance, Surface Water and Wastewater Program*, U.S. Army Center for Health Promotion and Preventive Medicine. Retrieved 24 May 2007 from:
<http://chppm-www.apgea.army.mil/swwp/StormWaterGuidance.pdf>
- Filtrexx. 2007. Standard Specifications and Design Manual - Version 6 (updated 5-1-07). Section 1: Erosion and Sediment Control-Construction Activities 1.1 Filtrexx SiltSoxx™. Sediment & Perimeter Control Technology.
<http://www.filtrexx.com/>
- Filtrexx. 2007. Standard Specifications and Design Manual Version 6.0 (updated 5/1/07). Section 1: Erosion and Sediment Control-Construction Activities, 1.8 Filtrexx Compost Erosion Control Blanket™ (CECB™). Slope Stabilization and Erosion Control Technology.
<http://www.filtrexx.com/>
- Filtrexx. 2007. Standard Specifications and Design Manual Version 6.0 (updated 5/1/07) Section 2: Storm Water Management - Post-Construction, 2.1 Filtrexx Compost Storm Water Blanket™ (CSWB™). Runoff Reduction & Vegetation Technology. <http://www.filtrexx.com/>
- Filtrexx. 2007. Standard Specifications and Design Manual - Version 6, updated 5-1-07. Section 2: Stormwater Management - Post Construction, 2.3 Filtrexx Compost Engineered Soil™ (CES™). Infiltration and Pollution Control Technology.
<http://www.filtrexx.com/>

PWTB 200-1-62
1 October 2008

Fort Bragg Breaks Environmental Performance (EPAS) Record, Again! *Sustainable Fort Bragg*, Vol. 5, June 2005. Retrieved 4 June 2007 from:

<http://www.bragg.army.mil/Sustainability/library/newsletters/volume5.pdf>

Fort Bragg Environmental Management System - The Road to A Sustainable Future, *web based presentation*. Retrieved 3 June 2007 from:

http://www.bragg.army.mil/Sustainability/library/presentations/ems_present_files/frame.htm

Georgia Department of Natural Resources. 2006. Site Fingerprinting Utilizing GIS/GPS Technology, *Green Growth Guidelines, Chapter 1*, 1-8., Retrieved 14 June 2007 from:
<http://crd.dnr.state.ga.us/content/displaycontent.asp?txtDocument=969>

Georgia Department of Natural Resources. 2006. Technique 7-Permeable Paving, *Green Growth Guidelines, Chapter 3.3.8*, 53-58. Retrieved 29 June 2006 from:

<http://crd.dnr.state.ga.us/assets/documents/GGG3C.pdf>

Guillette, Ann. 2007. Low Impact Development Technologies, *Whole Building Design Guide*. Retrieved 27 May 2007 from:

<http://www.wbdg.org/design/lidtech.php>

Hunt, W. F., A. R. Jarrett, J. T. Smith, and L. J. Sharkey. 2006. Evaluating Bioretention Hydrology and Nutrient Removal at Three Field Sites in North Carolina. *Journal of Irrigation and Drainage Engineering*, November/December 2006, 600-608.

Hsieh, Chi-hsu, and Allen P. Davis. 2005. Evaluation and Optimization of Bioretention Media for Treatment of Urban Storm Water Runoff. *Journal of Environmental Engineering*, 131(11): 1521-1531.

Hsieh, Chi-hsu. 2004. Engineering Bioretention for Treatment of Urban Stormwater Runoff, Unpublished PhD dissertation, University of Maryland, College Park, MD.

Hydrologic Modeling System (HEC-HMS) for U.S. Army Corps of Engineers. Retrieved 4 June 2007 from:

<http://www.hec.usace.army.mil/software/hec%2Dhms/>

Indiana Department of Environmental Management. 2006. Internal IDEM Pollution Prevention Integration Projects, Retrieved 12 June 2007 from:

http://www.in.gov/idem/prevention/integration/ten_steps.htm

PWTB 200-1-62
1 October 2008

- Inspector General, Department of Defense. 2002. Defense Infrastructure, DoD Environmental Community Involvement Programs at Test and Training Ranges (D-2002-122). Retrieved 1 June 2007 from: <http://stinet.dtic.mil/cgi-bin/GetTRDoc?AD=ADA403131&Location=U2&doc=GetTRDoc.pdf>
- Institute for Science and Interdisciplinary Studies. 2007. Military Waste Cleanup Project <http://isis.hampshire.edu/mil/index.html>
- Johnson, Richard L., and Peg Staeheli. 2005. City of Seattle-Stormwater Low Impact Development Practices. Retrieved 5 July 2007 from: http://www.seattle.gov/util/stellent/groups/public/@spu/@esb/documents/webcontent/spu01_002622.pdf
- Kirts, Richard, and Mark Foreman. 2004. Removal of Toxic Metals from: Stormwater Runoff at Naval Installations, Technical Report TR-2256-ENV. Engineering Service Center, Port Hueneme, CA.
- Loechl, Paul M., Annette L. Stumpf, Eric D. Johnson, Richard J. Scholze, Brian M. Deal, and Michelle J. Hanson. 2003. Design Schematics for a Sustainable Parking Lot, Building 2-2332, ERND Classroom, Fort Bragg, NC. U.S. Army Corps of Engineers, Engineer Research and Development Center. Retrieved 19 June 2007 from: http://www.invisiblestructures.com/Med&tech/WhitePapers/Stumpf_SustainableParkingLot__TR.pdf
- Lichtenstein, Mark. 2004. U.S. Army Conservation Reimbursable Forestry Program. U.S. Army Environmental Center. Retrieved June 2007 from: http://www.masonbruce.com/wfe/2004Program/1C3_Mark_Lichtenstein.pdf
- Lohman, U., R. Sausen, L. Bengtsson, U. Cubasch, J. Perlwitz, and E. Roeckner. 1993. The Koppen climate classification as a diagnostic tool for general circulation models. *Clim. Res.* Vol. 3: 177-193. <http://www.int-res.com/articles/cr/3/c003p177.pdf>
- Low Impact Development Center, Low Impact Development Permeable Paver Specification, Retrieved June 2007 from: <http://www.lowimpactdevelopment.org/epa03/pavespec.htm>
- Low Impact Development Center, Low Impact Development Urban Design Tools website online at: <http://www.lid-stormwater.net/>

PWTB 200-1-62
1 October 2008

- Low Impact Development: Sustainable Solutions for Watershed Development, Retrieved 1 June 2007. http://www.clu-in.org/conf/tio/owlid_101905/prez/lid_final_webcastpdf.pdf
- Massachusetts National Guard Environmental and Readiness Center. 2007. Integrated Natural Resource Management Plan for Camp Edwards. Ch. 3 - Facilities. Retrieved 26 May 2007 from: <http://www.mass.gov/guard/E&RC/INRMP/Chapter%203,%20Facilities.pdf>
- Morrow, Donna, and Elizabeth F. Valentine. 1999 (updated 2005). Clean Boating Lesson Plan. MD Clean Marina Initiative, Maryland Department of Natural Resources. Retrieved 12 June 2007 from: <http://www.dnr.maryland.gov/boating/cleanmarina/lessonplans/Intro05.pdf>
- National Pollution Prevention Roundtable. 2007. What is Pollution Prevention (P2)? Retrieved 13 June 2007 from: http://www.p2.org/about/nppr_p2.cfm
- National Resources Conservation Service (NCRCS) (2003) Fact Sheet: Broadcast Seeding Method for Burned Areas, Retrieved 30 June 2007 from: <ftp://ftp-fc.sc.egov.usda.gov/CA/programs/EWP/BroadcastSeeding.pdf>
- The National Training Center and Fort Irwin Land Expansion.* Retrieved 11 June 2007.
- Navy Environmental Sampling and Testing Programs. 2007. DoD Perchlorate Handbook, Revision 1. Retrieved 24 May 2007 from: <http://www.navylabs.navy.mil/Perchlorate.htm>
- Office of the Deputy Under Secretary of Defense (OPUSD (I&E)). 2001. Management Guidance for the Defense Environmental Restoration Program. Retrieved 24 May 2007 from: <https://www.denix.osd.mil/denix/Public/ES-Programs/Cleanup/guida.html#2>
- Ohio Environmental Protection Agency. 2007. P2 SEPs Pollution Prevention Supplemental Environmental Projects. Retrieved 13 June 2007 from: <http://www.epa.state.oh.us/opp/p2regint/p2sep1.html>
- Oklahoma Department of Environmental Quality, Pollution Prevention (P2). Retrieved 13 June 2007 from: <http://www.deq.state.ok.us/csdnew/p2.htm>
- Oklahoma Department of Environmental Quality. Pollution Prevention in Oklahoma Means. Retrieved 13 June 2007 from: <http://www.deq.state.ok.us/csdnew/p2.htm>

PWTB 200-1-62
1 October 2008

- Oshkosh Truck Corporation. 2002. MTRV Medium Tactical Vehicle Replacement. Retrieved 12 June 2007 from:
http://www.oshkoshtruck.com/pdf/Oshkosh_MTRV_brochure.pdf
- P2 Information - Topic Hubs™ and Sector Resources. Retrieved 13 June 2007 from:
<http://www.p2rx.org/P2InfoNexpert/sectorInfo.cfm?SectorID=9>
- Partnership for Advancing Technology and Housing (PATH), *Low Impact Development (LID) Practices for Storm Water Management*, Upper Marlboro, MD. Retrieved 5 June 2007 from:
<http://www.toolbase.org/Technology-Inventory/Sitework/low-impact-development>
- Pitt, Robert, Shen-En Chen, and Shirley Clark. 2002. Compacted Urban Soils Effects on Infiltration and Bioretention Stormwater Control Designs. Presented at the 9th International Conference on Urban Drainage, IAHR, IWA, EWRI, and ASCE, Portland, OR, 8-13 September 2002.
- Pitt, R., J. Lantrip, R. Harrison, C. Henry, and D. Xue. 1999. Infiltration Through Disturbed Urban Soils and Compost Amended Soil Effects on Runoff Quality and Quantity, EPA/600/R-00/016, February 1999, Cincinnati, OH: National Risk Management Research Laboratory, Office of Research and Development, U.S. Environmental Protection Agency.
- Prince George's County Department of Environmental Resources, Programs and Planning Division. 1999. Low-Impact Development Design Strategies: An Integrated Design Approach, Website. Retrieved 5 June 2007 from:
<http://www.epa.gov/owow/nps/lidnatl.pdf>
- Prince George's County Department of Planning, Bioretention Guidelines Guidance & Helpful Hints for the Use & Implementation of Bioretention Facilities, Prince George's County Bioretention Manual - Appendix A - Bioretention Guidelines.
- Public Works Business Center, Fort Bragg NC, Parsons, U.S. Army Corps of Engineers. 2003. Installation Design Guide for a Sustainable Fort Bragg.
- Puget Sound Action Team. 2005. LID Technical Guidance Manual for Puget Sound, Low Impact Development [Revised May 2005]. Retrieved June 2007 from:
http://www.psat.wa.gov/Publications/LID_tech_manual05/04_vegetation.pdf

PWTB 200-1-62
1 October 2008

Reining in the Storm – One Building at a Time: A Basic Guide to Low Impact Development. Retrieved June 2007 from:
<http://www.southportland.org/vertical/Sites/%7B7A5A2430-7EB6-4AF7-AAA3-59DBDCFA30F2%7D/uploads/%7B2CB16D05-6D62-40C1-BD68-4C51A52860EF%7D.PDF>

Romney Creek Automatic Weapons Firing Range, *Website*. Retrieved 12 June 2007 from:
http://www.atc.army.mil/fac_guide/facilities/romney.html

SvR Design Company. 2006. High Point Community: Right of Way and Open Space Landscape Maintenance Guidelines.

Schueler, T. 1987. Controlling Urban Runoff: A Practical Manual for Planning and Designing Urban BMPs. Metropolitan Washington Council of Governments, Washington, DC.

Schueler, T. R. 2000. Stormwater Strategies for Arid and Semi-Arid Watersheds. Ellicott City, MD, Center for Watershed Protection Article No. 66.

SIRRA - Sustainable Installations Regional Resource Assessment Fort Future, *Website*, Retrieved 24 May 2007 from:
<https://ff.cecer.army.mil/ff/sirra.do>

Soil Ecology and Research Group. 2002. Revegetation and Erosion Control, Manix Tank Trail Site: National Training Center, Fort Irwin, CA, (last update 29 October 2002). Retrieved 11 June 2007 from:
http://www.sci.sdsu.edu/SERG/restorationproj/mojave%20desert/ft_irwin/manix.htm

Steagall, Christine. 2003. Addressing Regional Priorities: Through the DOD Region 4 Pollution Prevention Partnership, *Public Policy & Practice* 2(4), ISSN: 1540-1499, e-Journal, Retrieved 19 June 2007,
<http://www.ipspr.sc.edu/ejournal/addressing.asp>

Storming Media, Environmental Management. Retrieved 5 June 2007 from:
http://www.stormingmedia.us/keywords/environmental_management.html

Strategic Environmental Research and Development Program, Retrieved 24 May 2007 from: <http://www.serdp.org/>

Sullivan, D. 2007. Whole Building Design Guide. Design Disciplines. Landscape Architecture. Retrieved 27 May 2007 from: http://www.wbdg.org/design/dd_landscapearch.php

Sun, X., and A. P. Davis. 2007. Heavy Metal Fates in Laboratory Bioretention Systems. *Chemosphere* 66: 1601-1609.

PWTB 200-1-62
1 October 2008

Sustainable Fort Bragg: Bringing all our resources to bear, to sustain the mission. Goal 1: Water Resources Goal.

Retrieved 24 May 2007 from:

<http://www.bragg.army.mil/sustainability/goal1.htm>

Sustainable Fort Bragg. 2003. Annual Report, 1-12. Retrieved 5 June 2007 from:

<http://www.bragg.army.mil/sustainability/library/pdf/annualReportV5.pdf>

Targeting Low Impact Development Restoration and Retrofit Areas in Impaired Urban Watersheds Using Remote Sensing Analysis, Flier, Retrieved 4 June 2007 from:

http://www.lowimpactdevelopment.org/lid%20articles/flier_print.pdf

Tennis, P. D., M. L. Lemming, and D. J. Akers. 2004. Pervious Concrete Pavements. EB302.02, Portland Cement Association: Skokie, IL, and National Ready Mixed Concrete Association: Silver Spring, MD.

http://www.aprmca.com/2006/images/pervious_concrete/pc_EB302_PCA.pdf

Fort McCoy, WI. 1999. Three cantonment area sites improved for training. Triad Online. Retrieved 24 May 2007 from:

http://www.mccoy.army.mil/vtriad_online/11121999/cantonment.htm

ToolBase Resources Technology Inventory, PATH (The Partnership for Advancing Technology in Housing). NAHB Research Center.

<http://www.toolbase.org/Technology-Inventory/Sitework/permeable-pavement>

University of Illinois at Urbana-Champaign. 2007. A Desert Tortoise Model: A Spatially Explicit Simulation. Retrieved 24 May 2007 from:

http://blizzard.gis.uiuc.edu/dsm_tort_main.htm

U.S. Army Corps of Engineers. 2005. Sustainable Stormwater Storage Alternatives for Army Installations. Public Works Technical Bulletin 200-1-36. Retrieved 15 June 2007 from:

http://www.wbdg.org/ccb/ARMYCOE/PWTB/pwtb_200_1_36.pdf

U.S. Army Corps of Engineers. 2007. Remediation of Metals on Active and Inactive Firing Ranges, Fact Sheet, Retrieved 1 July 2007 from:

http://www.erdc.usace.army.mil/pls/erdcpub/WWW_WELCOME.NAVIGATION_PAGE?tmp_next_page=152984

U.S. Army Corps of Engineers, U.S. Army Assistant Chief of Staff for Installation Management. 2002. *Sustainable Project Rating Tool (SPiRiT)*, version 1.4.1, June 2002.

- U.S. Army Engineer Research and Development Center, Environmental Laboratory., Multi-Scale Assessment of Watershed Integrity (MAWI), Retrieved 24 May 2007 from: <http://el.erd.c.usace.army.mil/projfact.cfm?Id=33&Topic=Res&Code=eco-watersheds>
- U.S. Environmental Protection Agency (USEPA). 2007. Hazardous Chemicals, handout. Retrieved 13 June 2007 from: http://www.epa.gov/superfund/students/clas_act/haz-ed/10chems.htm
- _____. 2007. National Pollutant Discharge Elimination System (NPDES). Retrieved 26 June 2007 from: <http://cfpub.epa.gov/npdes/stormwater/const.cfm>
- _____. *Pollution Prevention (P2)*, Retrieved June 13, 2007 from: <http://www.epa.gov/p2/>
- _____. *Case Studies, Pollution Prevention (P2)*, Retrieved e0 June 2007 from: <http://www.epa.gov/p2/pubs/casestudies/index.htm>
- _____. 2007. Developing Your Stormwater Pollution Prevention Plan: A Guide for Construction Sites, EPA 833-R-060-04, May 2007. Retrieved June 2007 from: http://www.epa.gov/npdes/pubs/sw_swppp_guide.pdf
- _____. 2002. The Environmental Future: Emerging Challenges and Opportunities for EPA, A Report of the National Advisory Council for Environmental Policy and Technology (NACEPT), January 2002. Retrieved June 5, 2007 from: http://www.epa.gov/ocem/nacept/final_report_nacept_jan2002.pdf
- _____. National Pollutant Discharge Elimination System (NPDES): *Compost Filter Socks*, Retrieved June 2007 from: <http://cfpub.epa.gov/npdes/stormwater/menuofbmps/index.cfm?action=browse&Rbutton=detail&bmp=120>
- _____. National Pollutant Discharge Elimination System (NPDES): *National Menu of Stormwater Best Management Practices*. Retrieved June 2007 from: <http://www.epa.gov/npdes/stormwater/menuofbmps>
- _____. *Pollution Prevention Toolbox*. Retrieved 13 June 2007 from: <http://www.epa.gov/reg5rcra/wptdiv/p2pages/p2.pdf>
- _____. 2005. Safety Zone: Camp Rilea Offshore Small Arms Firing Range; Warrenton, OR. Federal Register Environmental Documents. Retrieved 12 June 2007 from: <http://www.epa.gov/fedrgstr/EPA-IMPACT/2005/July/Day-28/i14970.htm>

- _____. 1999. Storm Water Technology Fact Sheet: Bioretention
EPA 832-F-99-012, September 1999, USEPA Office of Water:
Washington, DC. September 1999. Retrieved June 2007 from:
<http://www.epa.gov/owm/mtb/mtbfact.htm>
- _____. 1999. Storm Water Technology Fact Sheet: Flow Diversion.
EPA 832-F-99-014, USEPA Office of Water: Washington, D.C.
September 1999. Retrieved June 2007 from:
<http://www.epa.gov/OWM/mtb/fl.pdf>
- _____. 1999. Storm Water Technology Fact Sheet: Turf
Reinforcement Mats. EPA 832-F-99-002. USEPA Office of
Water: Washington, D.C.
- _____. 1999. Storm Water Technology Fact Sheet: Vegetated
Swales. EPA 832-F-99-006, September 1999. Retrieved 13 June
2007 from: <http://www.epa.gov/owm/mtb/mtbfact.htm>
- Wrege, B. M., and M. Cienek. 2001. Applications of LIDAR data in
the McPherson watershed, Fort Bragg, North Carolina. Poster
for Water Resources Research Institute 2001 Annual
Conference, Raleigh, NC, 29 March 2001. Retrieved 24 May
2007 from:
http://nc.water.usgs.gov/reports/abstracts/poster_LIDARapps.html
- Yu, S. L., J-T. Kuo, E. A. Fassman, and H. Pan. 2001. Field test
of grassed-swale performance in removing runoff pollution.
Journal of Water Resources Planning and Management,
127:3(168-171).
- Zickler, L., and O. Dennison. 2005. Response to Comments, PSAT
LID Assistance File No. 205247.30, Task 34. Retrieved June
2007 from:
<http://www.psat.wa.gov/Programs/LID/assistance/PDF%20Local%20Regulation%20Assistance%20Project%202005/I.%20Technical%20Assistance%20and%20Recommendations/C.%20Issaquah,%20City%20of/3.%20Response%20to%20Comments%20Memo.pdf>

APPENDIX E: Climate - LID Technology Compatibility

Low Impact Development technologies and practices will be used in a variety of climates. LID has been used in a wide array of climate types. The chart below indicates that LID technologies that perform in the five basic climate categories.

		Climate Classification (Köppen-Geiger)					
		A	B	C	D	E	
		Tropical (Megathermal)	Dry (Arid and semiarid)	Temperate (Mesothermal)	Continental (Microthermal)	Polar	
LID technologies	1	Bioretention Cells	●	⊙	●	⊙	○
	2	Bioswales	●	⊙	●	⊙	○
	3	Vegetated Swales	●	⊙	●	⊙	○
	4	Grassy Swales	●	⊙	●	⊙	○
	5	Filter Mats	●	●	⊙	⊙	⊙
	6	Filter Socks	●	●	⊙	⊙	⊙
	7	Compost Amendments	●	⊙	⊙	⊙	○
	8	Reforestation Site	●	○	⊙	⊙	○
	9	Fingerprinting	●	●	●	●	⊙
	10	Selective Grading	●	⊙	●	⊙	○
	11	Pollution Prevention	●	●	●	●	⊙
	12	Downspout Disconnection	●	⊙	⊙	⊙	○
	13	Permeable Pavements	●	⊙	⊙	○	○

KEY

●	High Effectiveness (Recommended)
⊙	Medium Effectiveness (Recommended with Reservation)
○	Low Effectiveness (Not Recommended)

Sources

- Bujang Bin Kim Huat, Faisal Haji Ali, and Gue See Sew. 2004. Tropical Residual Soils Engineering.
- USEPA. 1999. Bioretention. Storm Water Technology Fact Sheet EPA 832-F-99-012, September 1999.
<http://www.epa.gov/owm/mtb/mtbfact.htm>
- USEPA. 1999. Vegetated Swales. Storm Water Technology Fact Sheet EPA 832-F-99-006, September 1999.
<http://www.epa.gov/owm/mtb/mtbfact.htm>
- Lohman, U., et al. 1993. The Koppen climate classification as a diagnostic tool for general circulation models. *Clim. Res.* Vol. 3: 177-193.
<http://www.int-res.com/articles/cr/3/c003p177.pdf>
- Schueler, T.R. 2000. Stormwater Strategies for Arid and Semi-Arid Watersheds. Ellicott City, MD, Center for Watershed Protection, Article No. 66.
- World Biomes, Retrieved May 2007 from:
<http://www.blueplanetbiomes.org/climate.htm>

PWTB 200-1-62
1 October 2008

APPENDIX F: LID Site Plan Examples at Military Installations

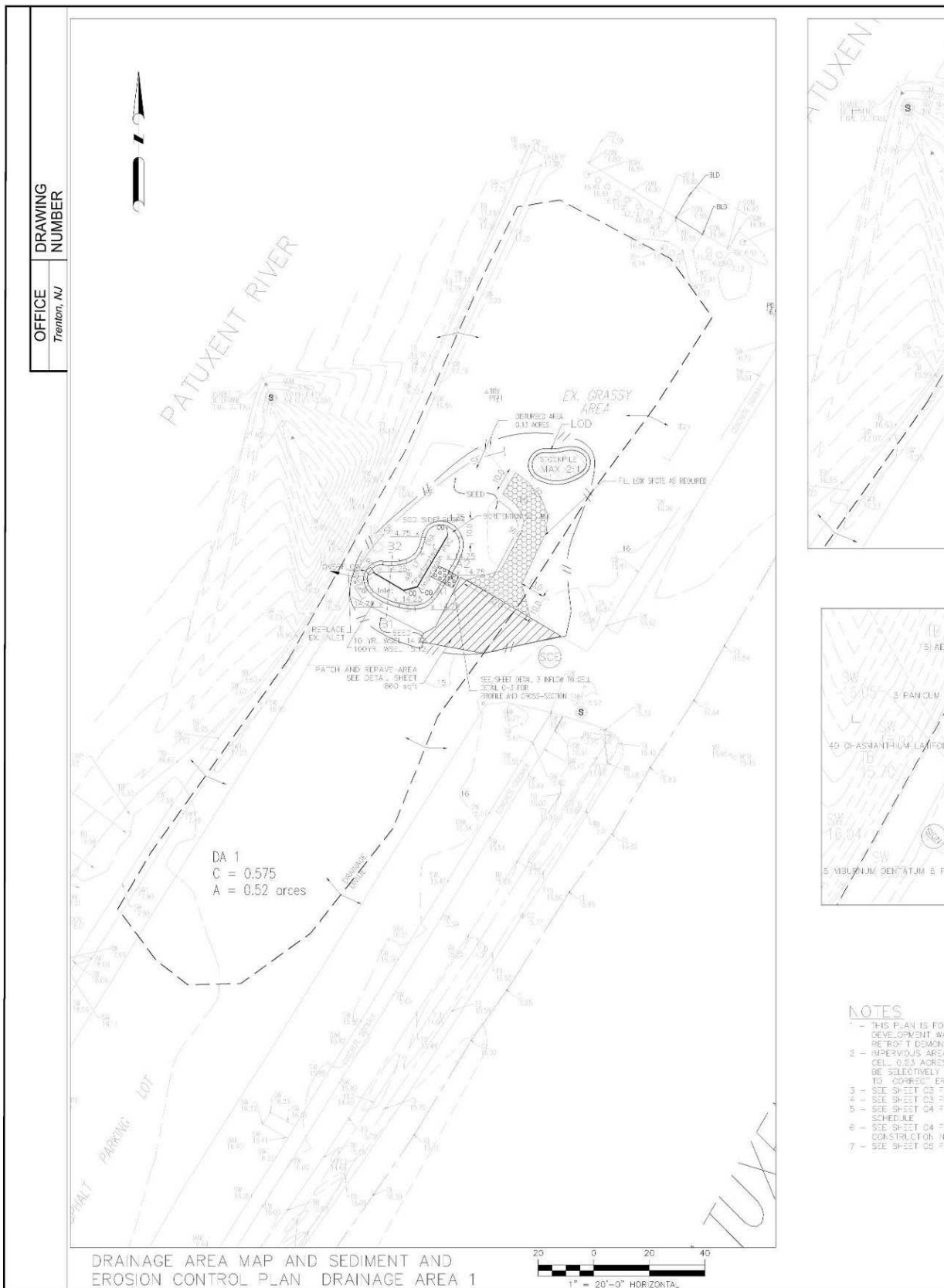

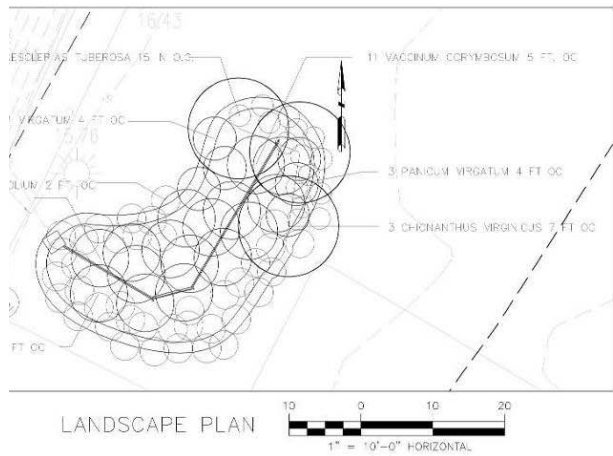
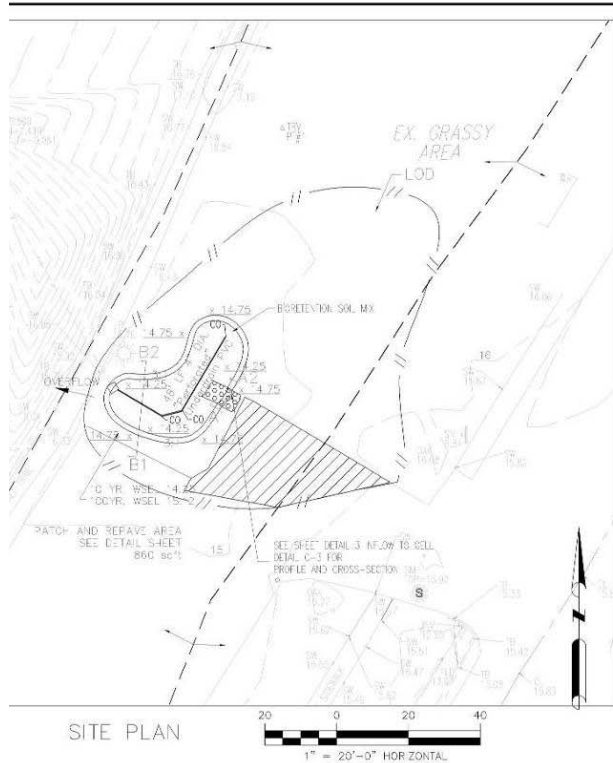

DESCRIPTION AREA 1:

DRAINAGE AREA 1 INCLUDES A SMALL PARTING LOT AND A GRASSY AREA. THIS PROPOSED BIORETENTION CELL WILL FILTER RUN OFF FROM 10136.8 SF OF PAVEMENT. THIS CELL AND ITS PLAN'S WILL PROCESS AND INFILTRATE RUNOFF FROM DRAINAGE AREA 1 AND REDUCE THE PONDING OF STORMWATER AT THE INLET. WE EXPECT TO OUTFIT AND REPAVE A 460 SQUARE FOOT AREA AS WELL AS CUT 2070 CF (777) CY OF SOIL AND IMPORT 945 CF (35 2/3) CY OF BIORETENTION SOIL MEDIA AS FOL-

OR THE LOW IMPACT WATER QUALITY MITIGATION PROJECTS TO BIORETENTION DISTURBED AREA TO BE FILLED AND VEGETATED TO REDUCE EROSION PROBLEMS FOR PROFILES FOR CROSS-SECTIONS FOR LANDSCAPE FOR SEQUENCE OF NOTES FOR CERTIFICATIONS

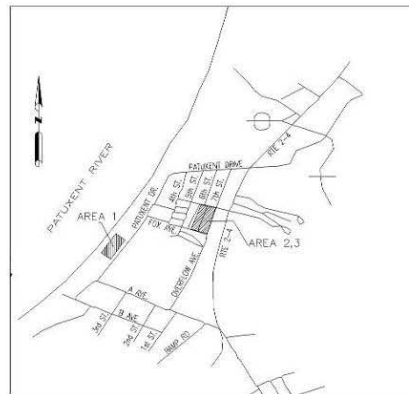

SITE PLAN LEGEND

- ASP ASPHALT
- B.O. BUILDING
- B.M. BENCHMARK
- BSH BUSH
- CCD CLEAR TREE
- C-CHIE CHERRY TREE
- C-TOUR COTONWOOD
- CON CONCRETE
- CON CONCRETE
- CF CONIFEROUS TREE
- CRP CRIPPLE
- EP EDGE OF PAVEMENT
- FLD FLD
- GR GRASS
- GRP GRASS
- H-FC FIRE HYDRANT
- IN INVERT
- LF LOT
- LOD LIMIT OF DISTURBANCE
- OR OR
- S.M. STORM DRAIN
- SF SILT FENCE
- S.M. SLOPE MANHOLE
- SN SN
- SW SW
- TE TELEPHONE
- TOP TOP OF SLOPE
- WF WOOD FENCE
- WSEL WATER SURFACE ELEVATION
- WV WATER VALVE

- LIGHT
- PROPOSED SIGN
- PROPOSED CONTOUR
- EXISTING CONTOUR
- PROPOSED ELEVATION
- EXISTING ELEVATION
- PROPOSED STORM DRAIN
- EXISTING STORM DRAIN
- SLOPE
- PATCH AND REPAVE AREA

SEDIMENT AND EROSION CONTROL LEGEND

- SCE - STANDARD CONSTRUCTION ENTRANCE
- DRAINAGE AREA DIVIDE
- LIMIT OF DISTURBANCE
- SILT FENCE
- SIP - STANDARD INLET PROTECTION
- BIORETENTION AREA
- STOCKPILE

SHEET INDEX

- C1 - DRAINAGE AREA 1: SEDIMENT EROSION CONTROL PLAN, SITE PLAN, LANDSCAPE PLAN
- C2 - DRAINAGE AREA 2,3: SEDIMENT EROSION CONTROL PLAN
- C3 - CROSS-SECTIONS, PROFILES, DETAILS
- C4 - STANDARDS AND SPECIFICATIONS

NOTE:
EROSION AND SEDIMENT CONTROL WILL BE STRICTLY ENFORCED

MDE# 06-SF-0213

THE LOW IMPACT DEVELOPMENT CENTER, INC. 1000 BELLSVILLE ROAD BELLINGHAM, MARYLAND 20705 (301) 932-0009		Shaw Environmental, Inc.	
DESIGNED BY	GP	CHECKED BY	NW
DRAWN BY	C. PETERS	APPROVED BY	N. WAINMAN
DATE	12/11/05	DATE	12/16/05
LOW IMPACT DEVELOPMENT DEMONSTRATION PROJECTS		SOLOMONS ISLAND, MARYLAND	
SOLOMONS ISLAND NAVAL AIR STATION			
SCALE:	AS SHOWN	SIZE:	D
DELIVERY ORDER NO.	TASK	MAPING DRAWING NO.	N62476-D2-D-3260
MDE No.	C6-SF-0214	FIGURE NO.	C-1

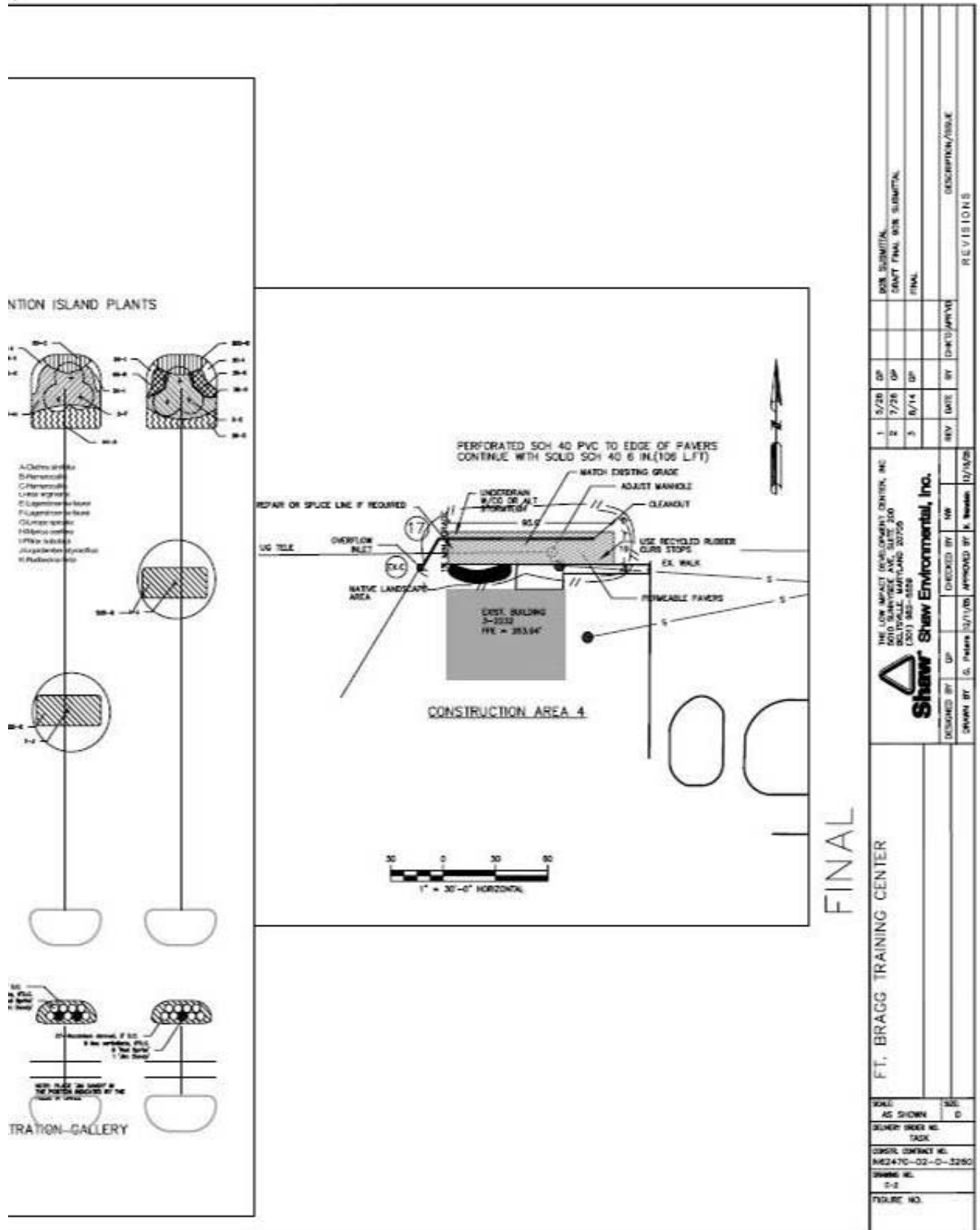

OFFICE DRAWING NUMBER
Pawtucket, NJ

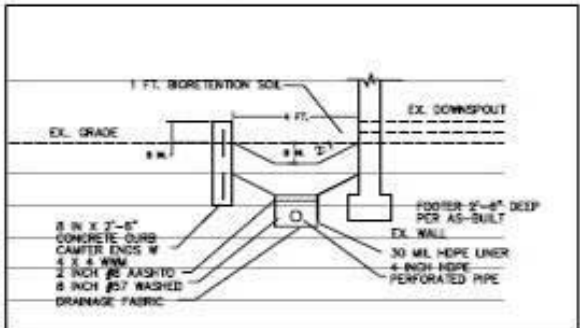

PLANTER WALL DETAIL TYPE A
NOT TO SCALE

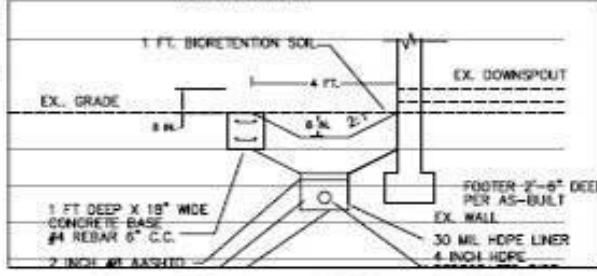

PLANTER WALL DETAIL TYPE B
NOT TO SCALE

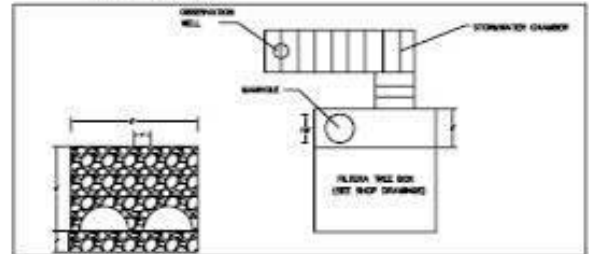

TREE BOX FILTER AND INFILTRATION DETAILS
NOT TO SCALE



GUTTER FILTER AND TRENCH DRAIN
NOT TO SCALE

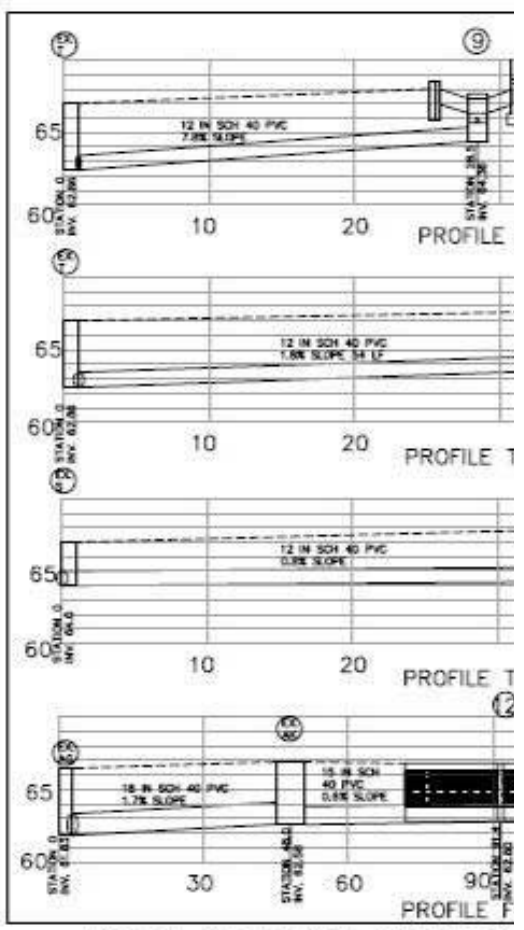

STORM DRAIN PIPE PROFILES

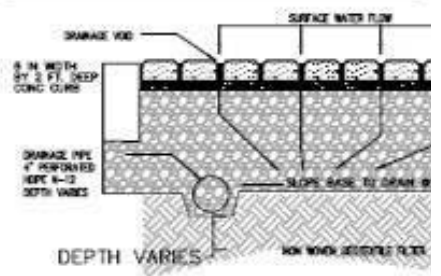

PERMEABLE PAVEMENT
NOT TO SCALE

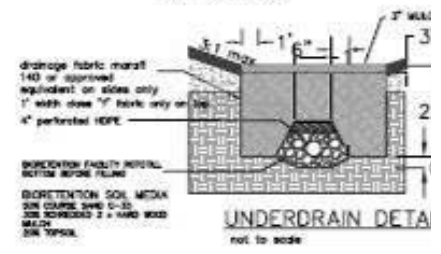

UNDERDRAIN DETAIL
not to scale

Plant Schedule Fort Bragg Parking Lot Bio-retention				
Qty	Quantity	Relative Name	Culture Variety	Common Name
A	40	Galium aparine	Galium Aparine	Galium Aparine
B	40	Hemerocallis	Happy Belland	Overnight Lily
C	40	Hemerocallis	Floral	Overnight Lily
D	40	Asa ageratum	Table Heavy or Spire	Overnight Lily
E	40	Ligularia striolata	Major	Overnight Lily
F	40	Ligularia striolata	Necker	Overnight Lily
G	100	Ligularia striolata	Spreading Carpet	Overnight Lily
H	110	Ligularia striolata	Major	Overnight Lily
I	100	Phlox subulata	Emerald Cushion Blue	Blue Morn
J	30	Ligularia striolata	Necker	Overnight Lily
K	20	Rubus odoratus	Black-eyed Susan	Black-eyed Susan
Fort Bragg Parking Lot South End Shrub Bio-retention				
1	10	Microseris bioretii	Swampy Owl	Swampy Owl
2	10	Asa ageratum	Happy Belland	Overnight Lily
3	10	Asa ageratum	Floral	Overnight Lily
Fort Bragg Raised Bio-retention Cells - Courtyard with Loading docks				
1	10	Asa ageratum	Happy Belland	Overnight Lily
2	10	Asa ageratum	Floral	Overnight Lily
3	10	Asa ageratum	Spreading Carpet	Overnight Lily
4	10	Asa ageratum	Major	Overnight Lily
5	10	Asa ageratum	Necker	Overnight Lily
6	10	Asa ageratum	Spreading Carpet	Overnight Lily
7	10	Asa ageratum	Major	Overnight Lily
8	10	Asa ageratum	Necker	Overnight Lily
9	10	Asa ageratum	Spreading Carpet	Overnight Lily
10	10	Asa ageratum	Major	Overnight Lily
11	10	Asa ageratum	Necker	Overnight Lily
12	10	Asa ageratum	Spreading Carpet	Overnight Lily
13	10	Asa ageratum	Major	Overnight Lily
14	10	Asa ageratum	Necker	Overnight Lily
15	10	Asa ageratum	Spreading Carpet	Overnight Lily
16	10	Asa ageratum	Major	Overnight Lily
17	10	Asa ageratum	Necker	Overnight Lily
18	10	Asa ageratum	Spreading Carpet	Overnight Lily
19	10	Asa ageratum	Major	Overnight Lily
20	10	Asa ageratum	Necker	Overnight Lily

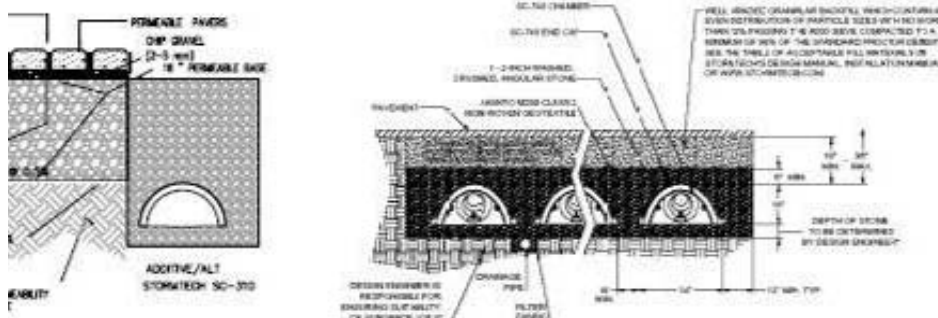
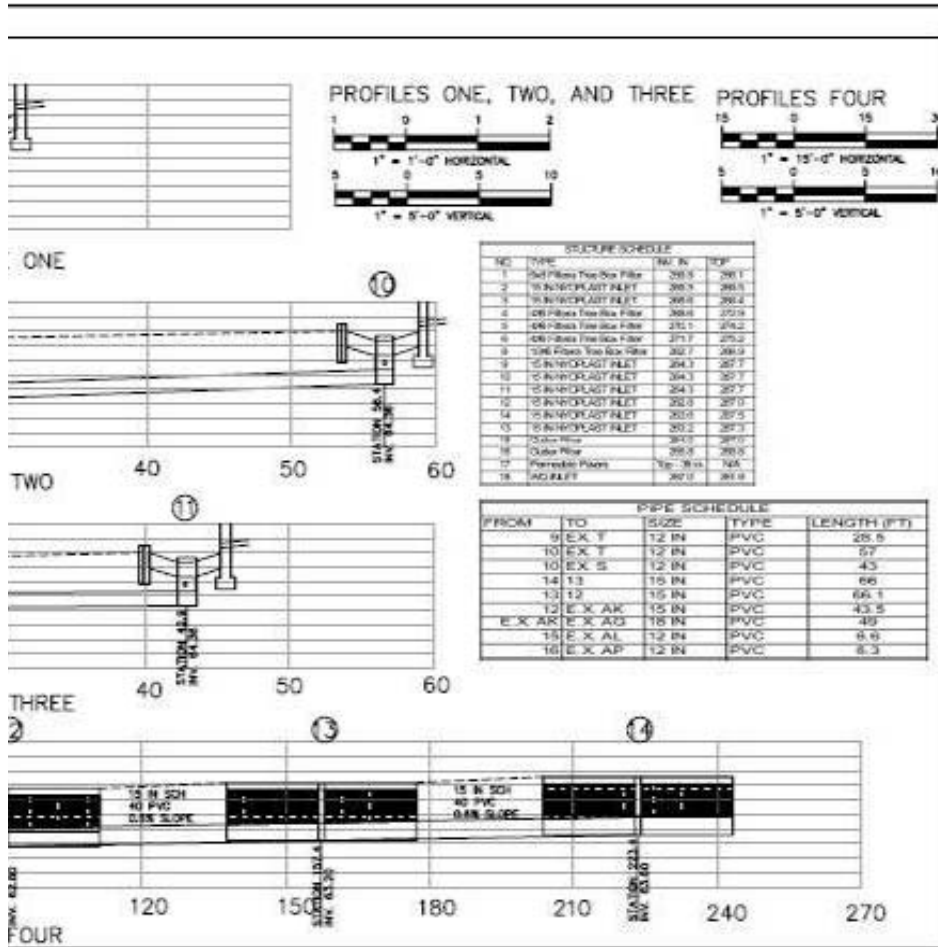

FINAL

NO.	DATE	DESCRIPTION
1	5/26/08	DATE SUBMITTED
2	7/28/08	DATE FINAL FOR SUBMITTAL
3	8/14/08	DATE FINAL

REV	DATE	BY	CHK'D	APP'G	DESCRIPTION/ISSUE
					REVISIONS

DESIGNED BY	GP	CHECKED BY	NW	DATE	12/18/08
DRAWN BY	D. Peters	APPROVED BY	A. Neenan		

THE LOW IMPACT DEVELOPMENT CENTER, INC.
 2610 SHILOH ROAD, SUITE 200
 WASHINGTON, VA 22190
 (541) 386-2559

Shaw Environmental, Inc.

DETAILS FOR TRAINING CENTER
 DPWT PARKING AREA AND
 DPWT LOADING AREA/OFFICE

SCALE	AS SHOWN
DRAWING NO.	182470-02-D-3240
CONTR. CONTRACT NO.	C-2
DRAWING NO.	C-2
FIGURE NO.	

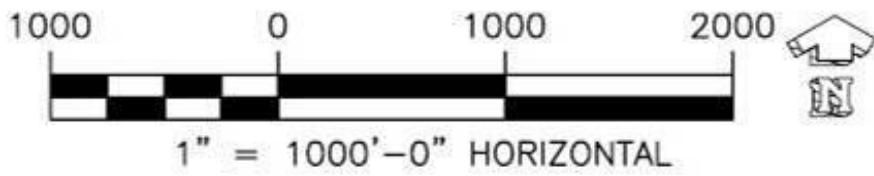
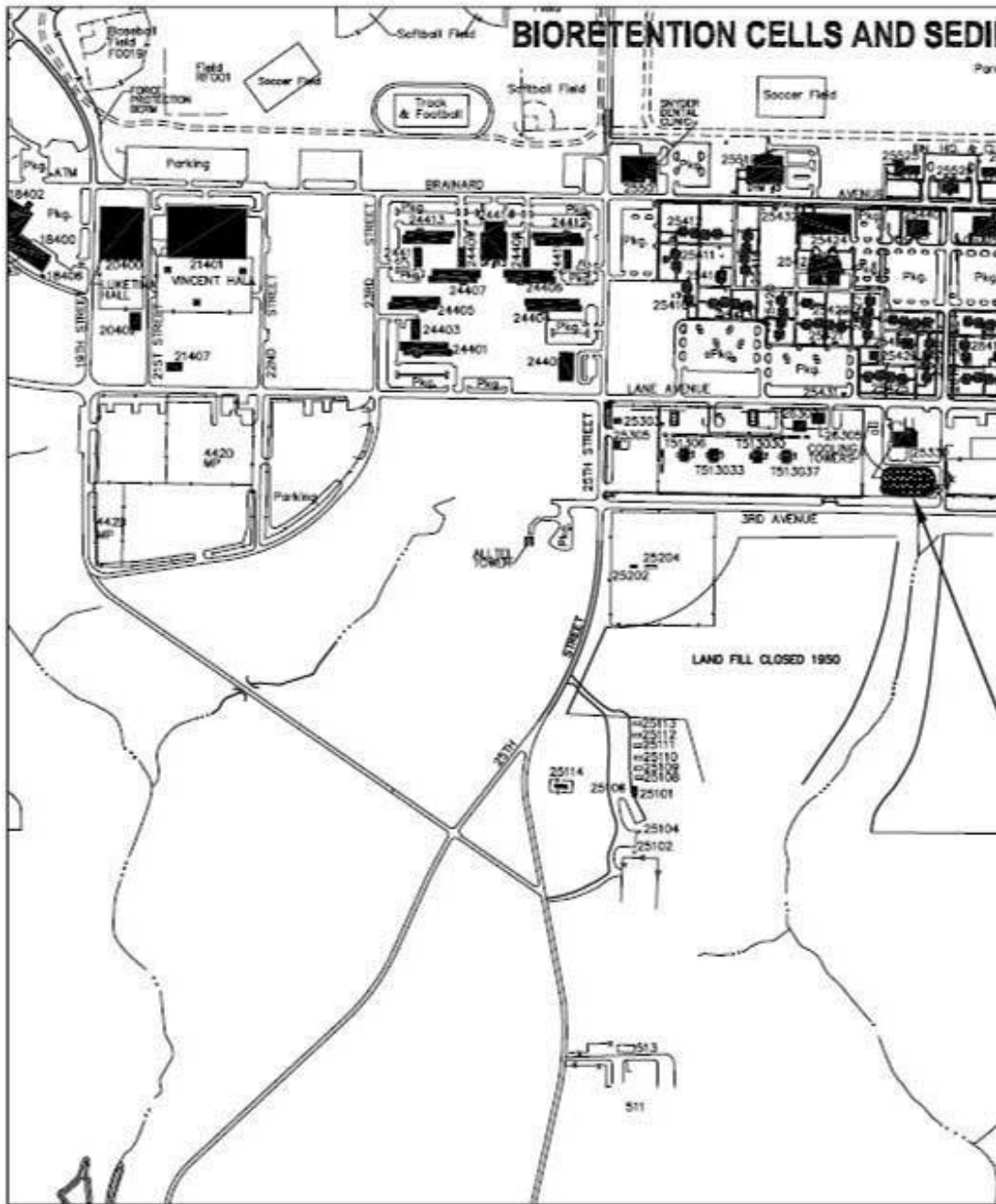

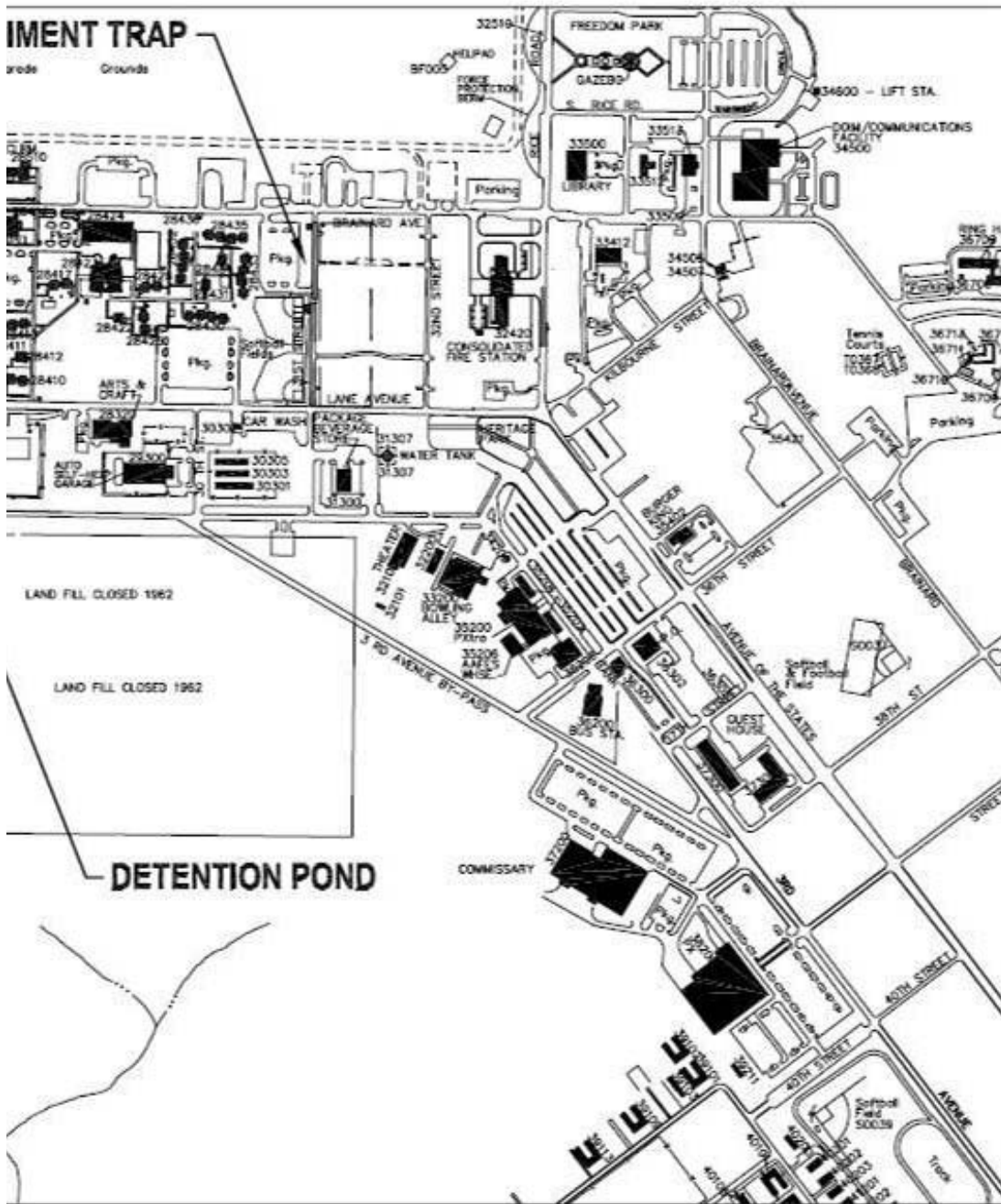

FIGURE A1: OVERVIEW MAP
FORT GORDON
LID RETROFIT STUDY
MARCH 27, 2006



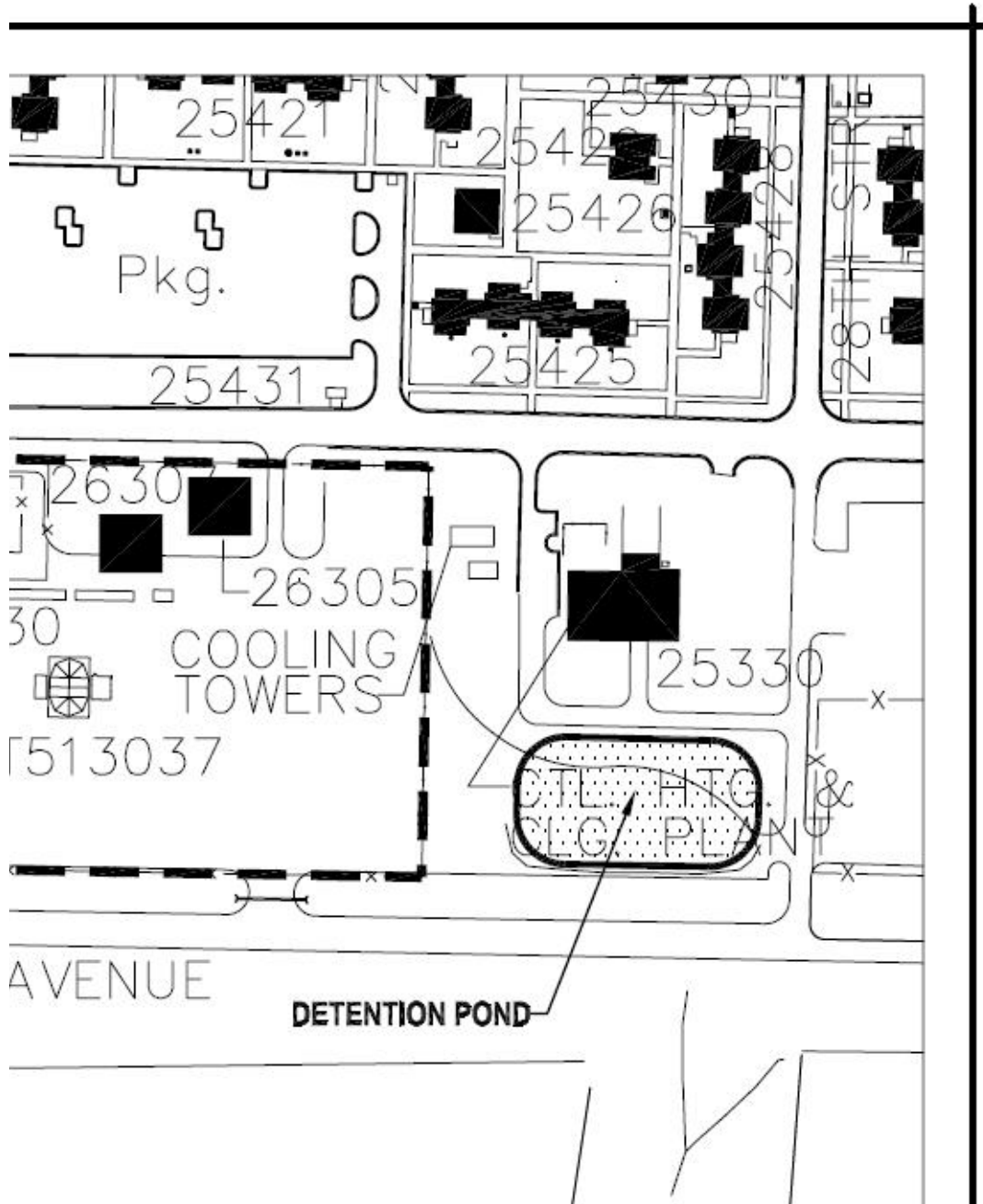

FIGURE A2: STORMWATER POND
FORT GORDON
LID RETROFIT STUDY
MARCH 27, 2006

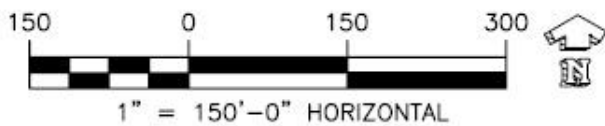
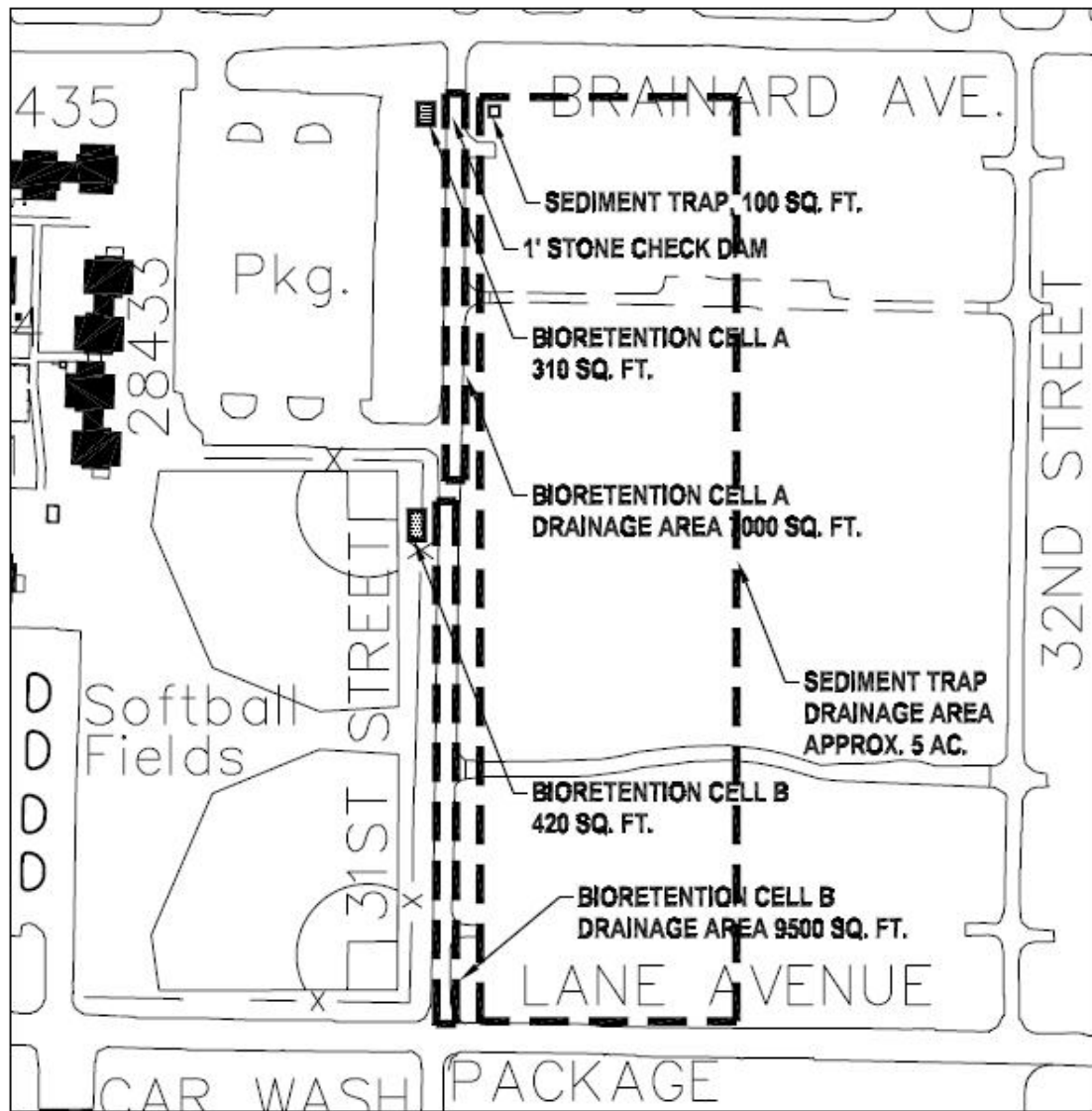
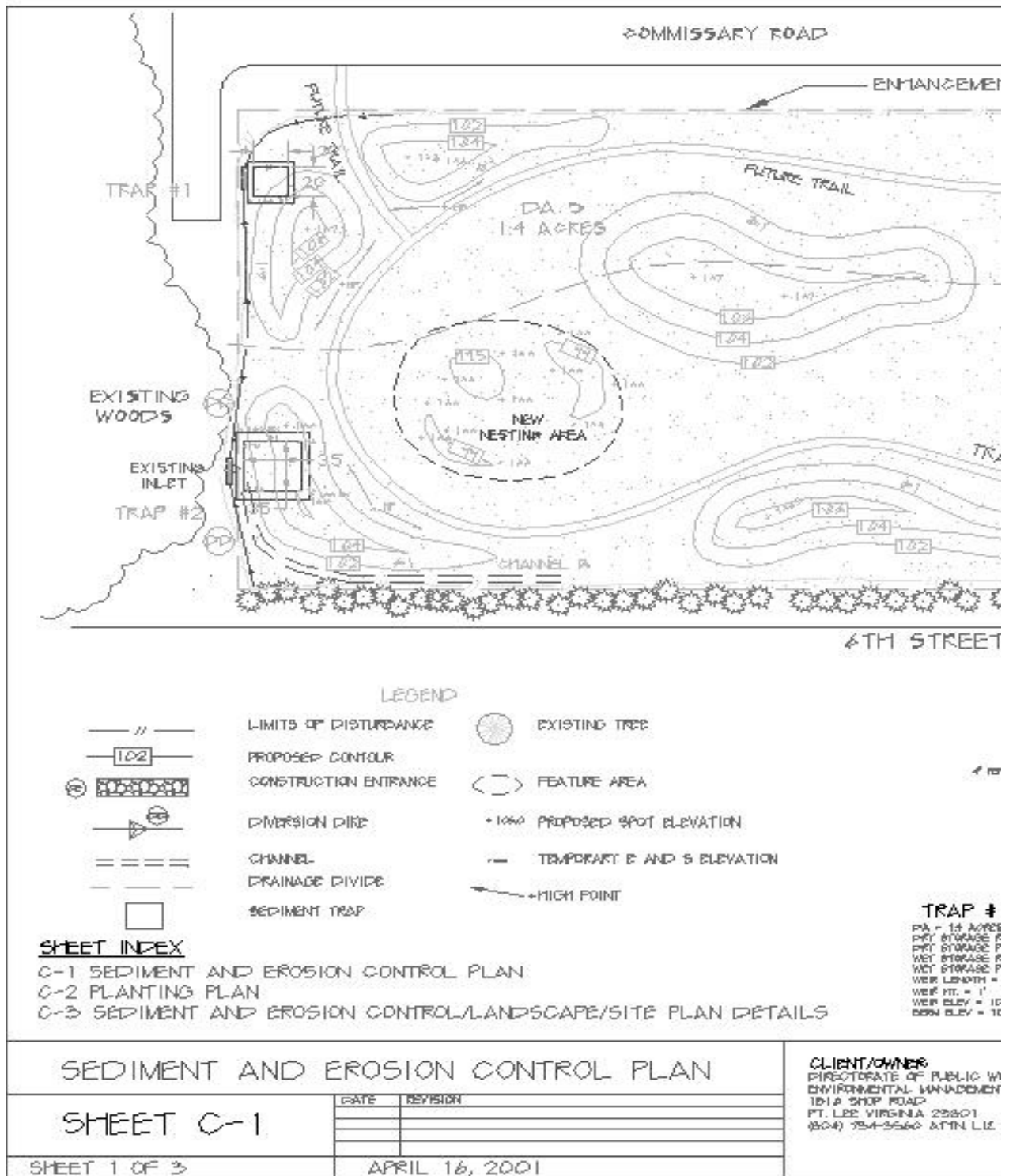
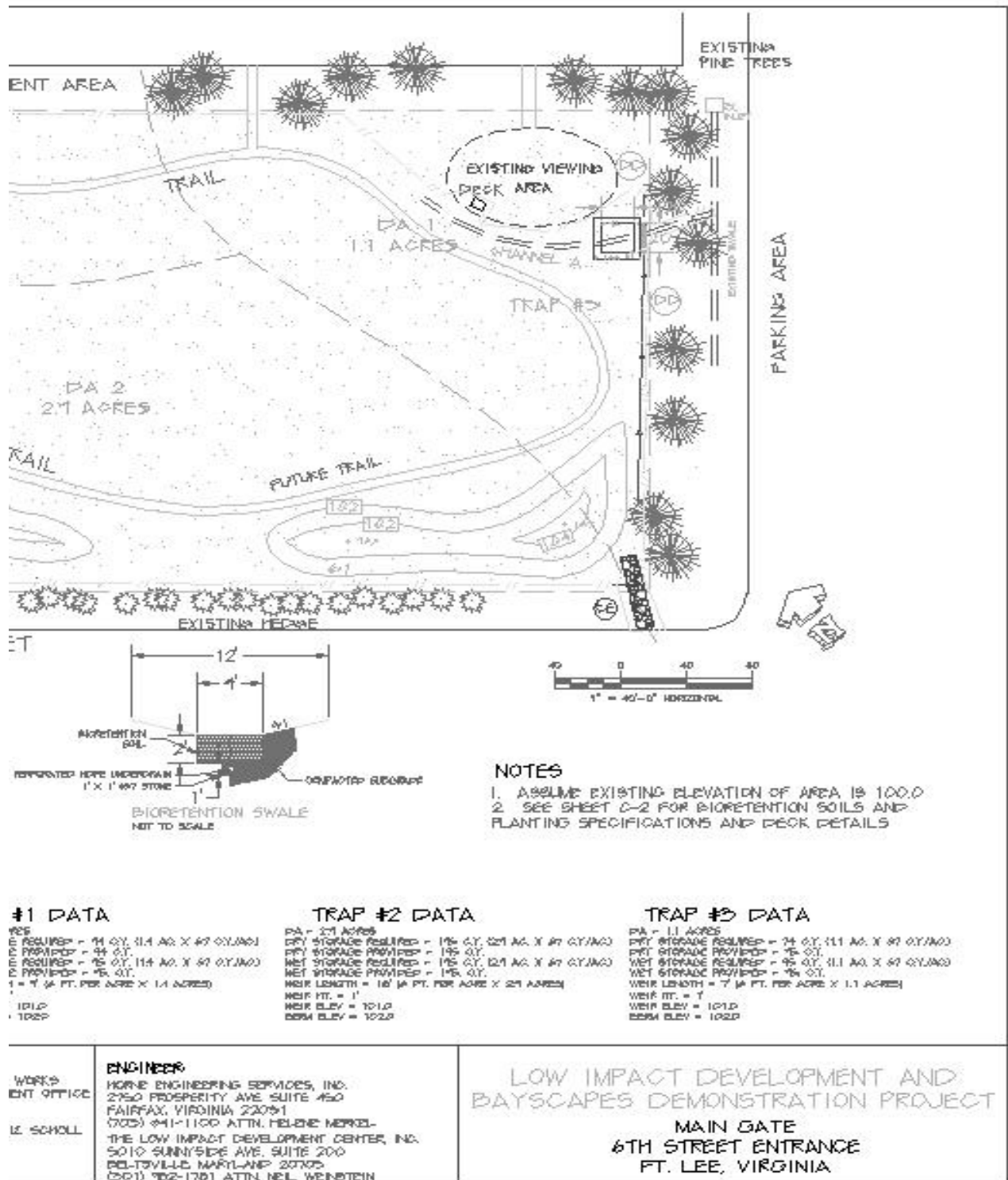
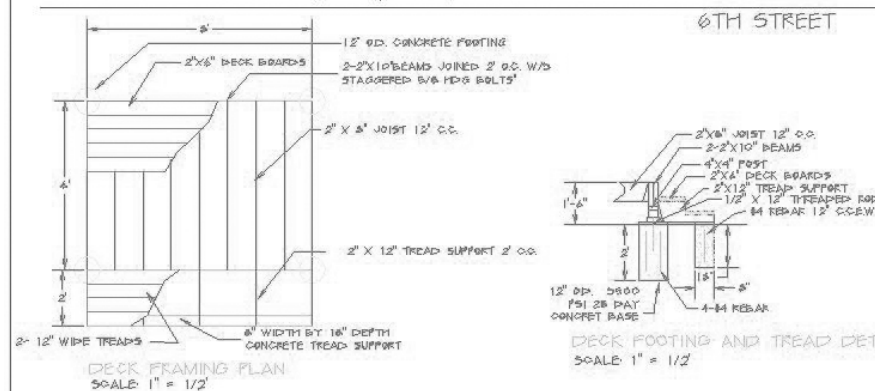
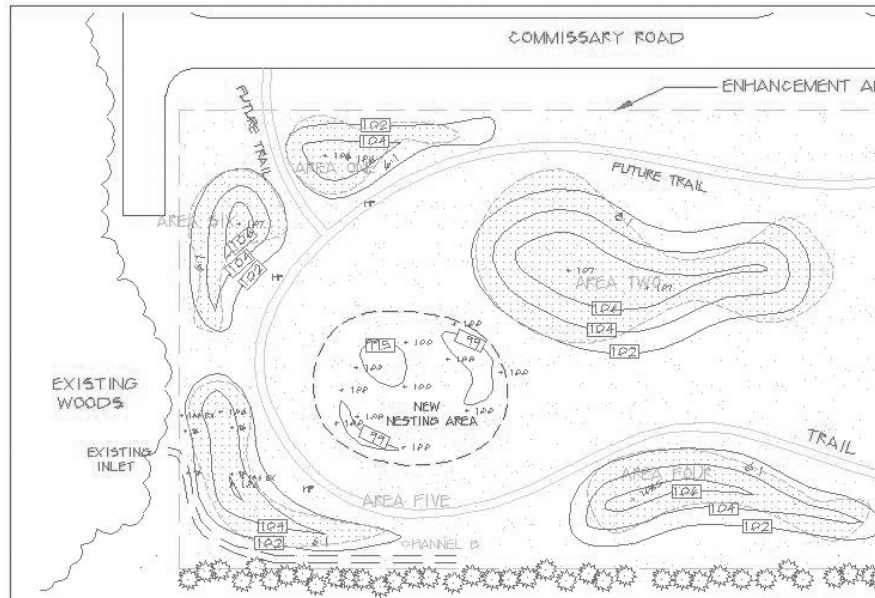

FIGURE A3:
BIORETENTION CELLS
AND SEDIMENT TRAP
FORT GORDON
LID RETROFIT STUDY
MARCH 27, 2006

PWTB 200-1-62
1 October 2008







PLANTING PLAN		CLIENT/OWNER DIRECTORATE OF PUBLIC WORK ENVIRONMENTAL MANAGEMENT 9 1514 SHOF ROAD FT. LEE, VIRGINIA 22041 (804) 784-5660 ATTN: LIZ JOE								
SHEET C-2	<table border="1"> <thead> <tr> <th>DATE</th> <th>REVISION</th> </tr> </thead> <tbody> <tr> <td> </td> <td> </td> </tr> <tr> <td> </td> <td> </td> </tr> <tr> <td> </td> <td> </td> </tr> </tbody> </table>		DATE	REVISION						
DATE	REVISION									
SHEET 2 OF 3	APRIL 16, 2001									

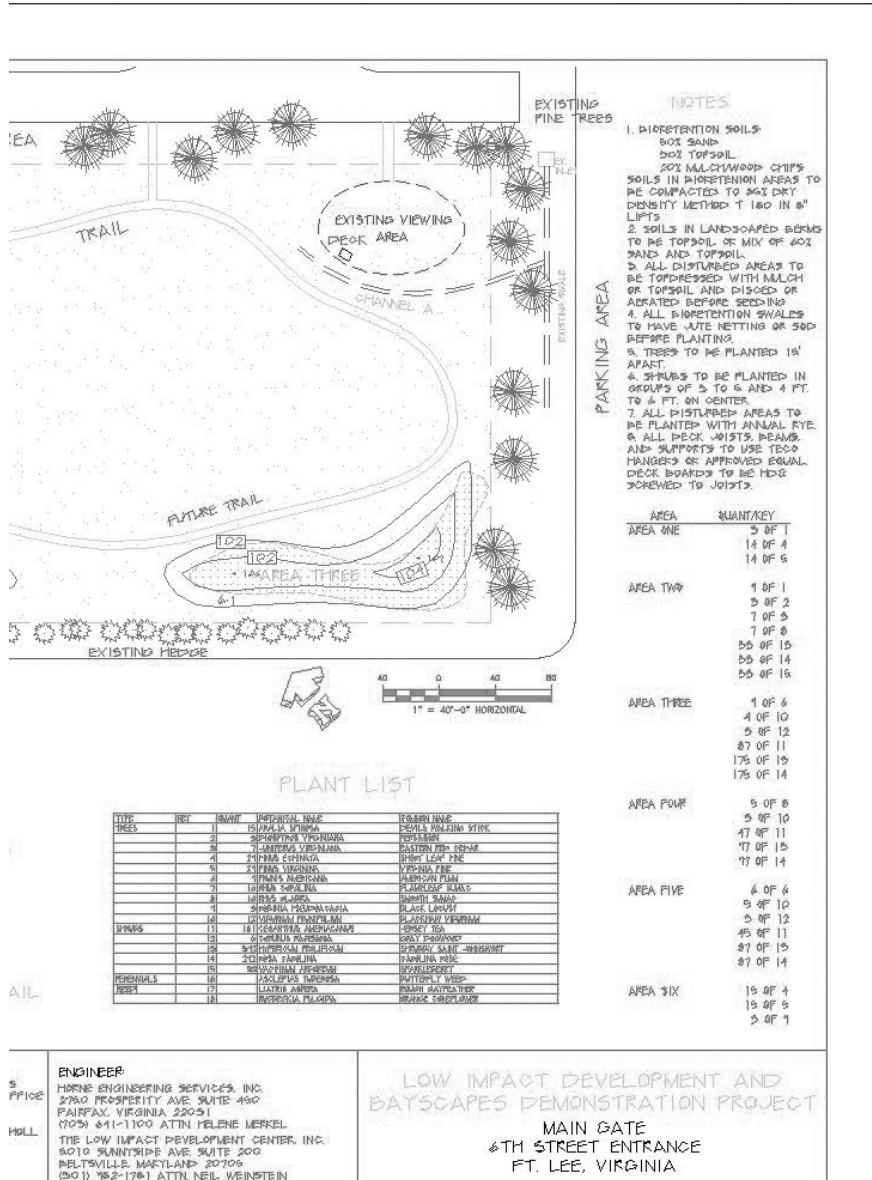

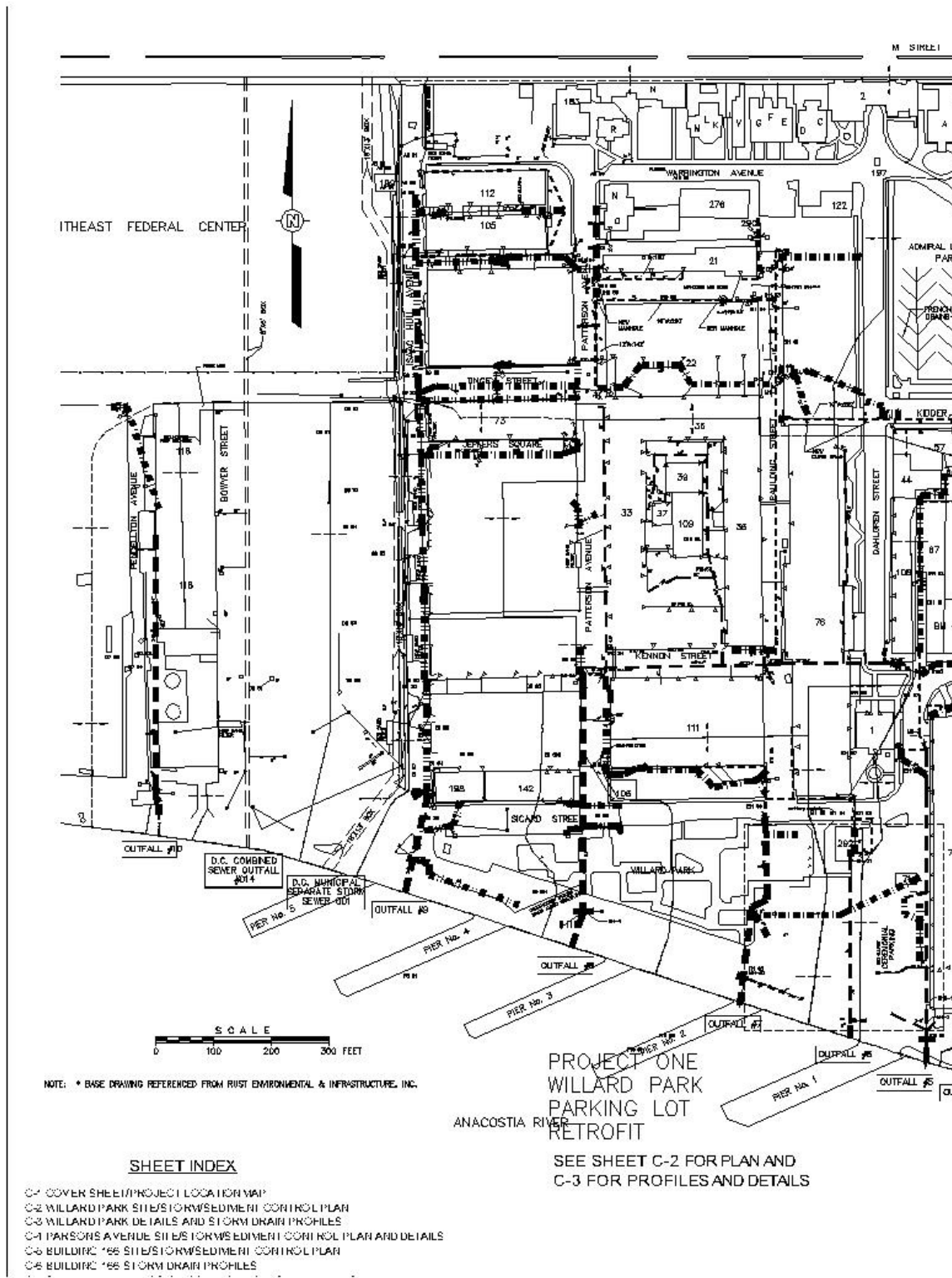

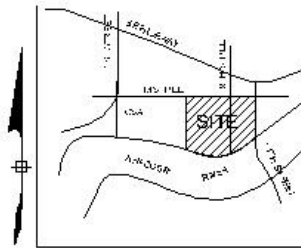
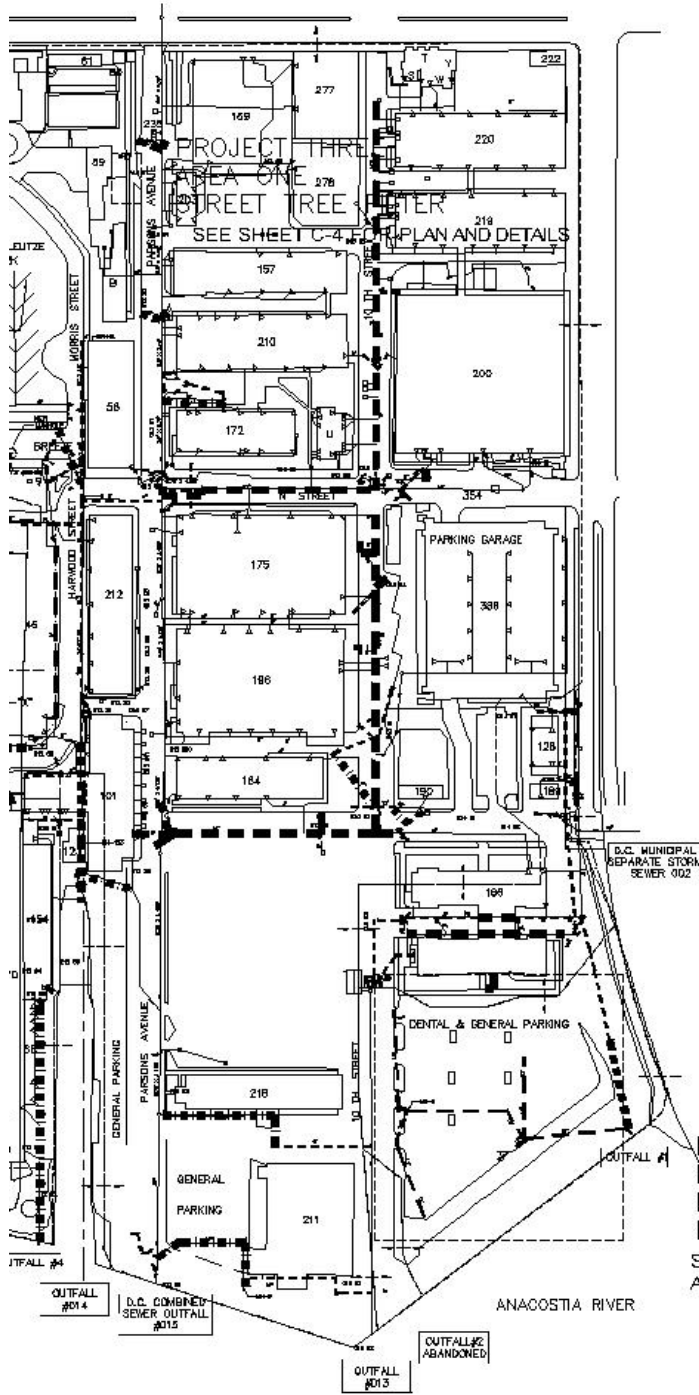

VICINITY MAP
 SCALE 1"=200'

GENERAL NOTES

1. THE WORK IS TO BE ACCORDING TO THE SPECIFICATIONS AND NOTES.
2. THE WORK IS TO BE ACCORDING TO THE SPECIFICATIONS AND NOTES.
3. THE WORK IS TO BE ACCORDING TO THE SPECIFICATIONS AND NOTES.
4. THE WORK IS TO BE ACCORDING TO THE SPECIFICATIONS AND NOTES.
5. THE WORK IS TO BE ACCORDING TO THE SPECIFICATIONS AND NOTES.
6. THE WORK IS TO BE ACCORDING TO THE SPECIFICATIONS AND NOTES.
7. THE WORK IS TO BE ACCORDING TO THE SPECIFICATIONS AND NOTES.
8. THE WORK IS TO BE ACCORDING TO THE SPECIFICATIONS AND NOTES.
9. THE WORK IS TO BE ACCORDING TO THE SPECIFICATIONS AND NOTES.
10. THE WORK IS TO BE ACCORDING TO THE SPECIFICATIONS AND NOTES.
11. THE WORK IS TO BE ACCORDING TO THE SPECIFICATIONS AND NOTES.
12. THE WORK IS TO BE ACCORDING TO THE SPECIFICATIONS AND NOTES.
13. THE WORK IS TO BE ACCORDING TO THE SPECIFICATIONS AND NOTES.
14. THE WORK IS TO BE ACCORDING TO THE SPECIFICATIONS AND NOTES.
15. THE WORK IS TO BE ACCORDING TO THE SPECIFICATIONS AND NOTES.
16. THE WORK IS TO BE ACCORDING TO THE SPECIFICATIONS AND NOTES.
17. THE WORK IS TO BE ACCORDING TO THE SPECIFICATIONS AND NOTES.
18. THE WORK IS TO BE ACCORDING TO THE SPECIFICATIONS AND NOTES.
19. THE WORK IS TO BE ACCORDING TO THE SPECIFICATIONS AND NOTES.
20. THE WORK IS TO BE ACCORDING TO THE SPECIFICATIONS AND NOTES.

**PROJECT TWO
 BUILDING 166
 PARKING AREA
 RETROFIT**
 SEE SHEET C-5 FOR PLAN
 AND C-6 FOR PROFILES AND DETAILS

DC PLAN # 365

OHM Remediation Services Corp.
 200 HORIZON CENTER BOULEVARD
 WASHINGTON, NEW MEXICO 87501

NO.	DATE	DESCRIPTION
1	06/12/00	ADDED DETAILS AND PROFILE
2	02/12/02	AREA DESIGNATIONS

THIS DRAWING SHALL BE USED FOR THE PROJECT ONLY. IT IS NOT TO BE REPRODUCED OR USED FOR ANY OTHER PROJECT WITHOUT THE WRITTEN PERMISSION OF OHM.

UNITED STATES NAVY YARD
 WATER QUALITY
 IMPROVEMENT PROJECT
 COVER SHEET AND PROJECT
 LOCATION MAP

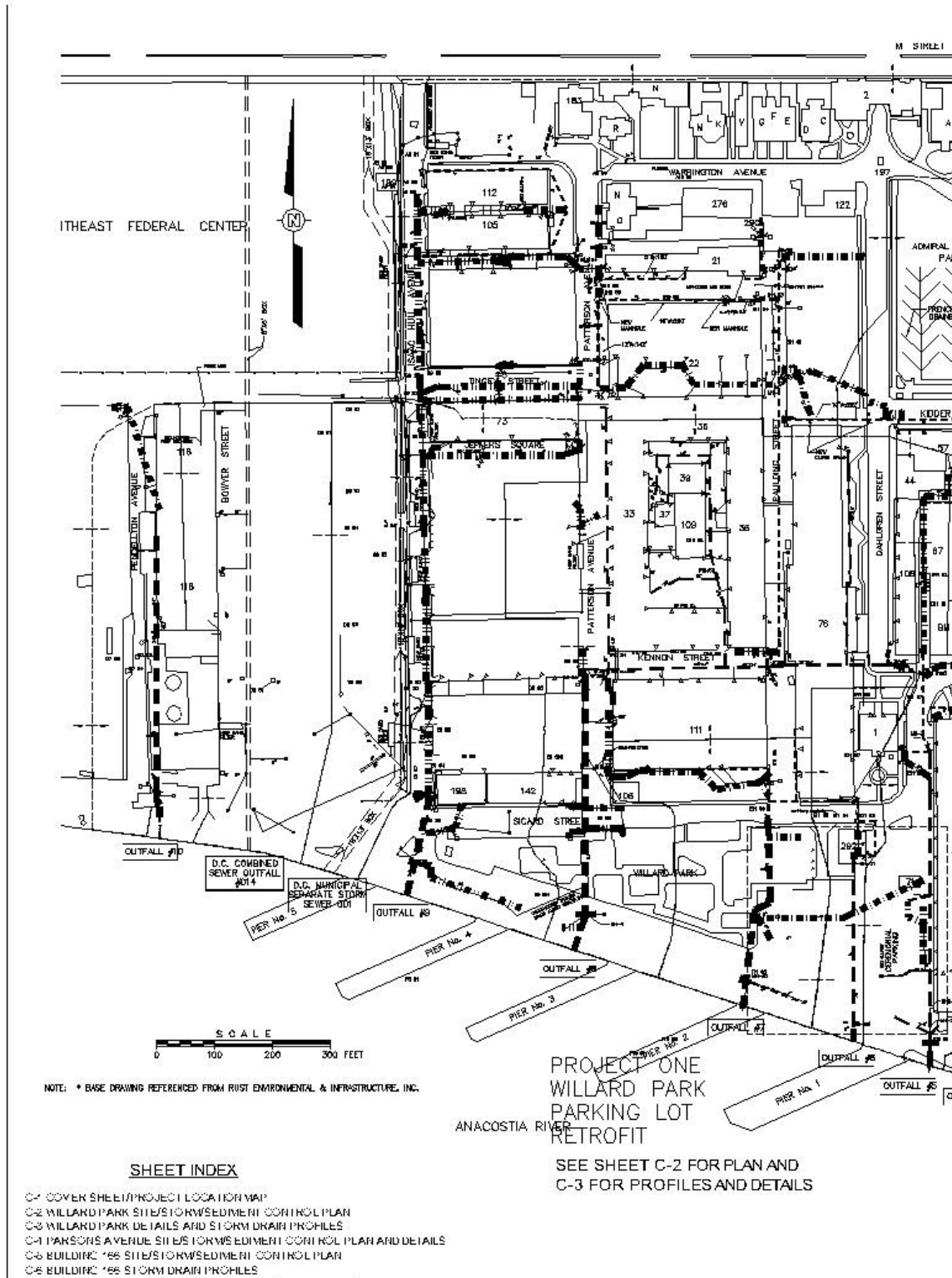

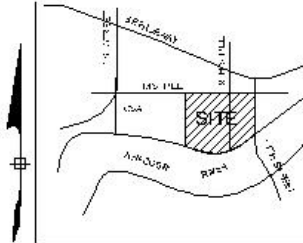
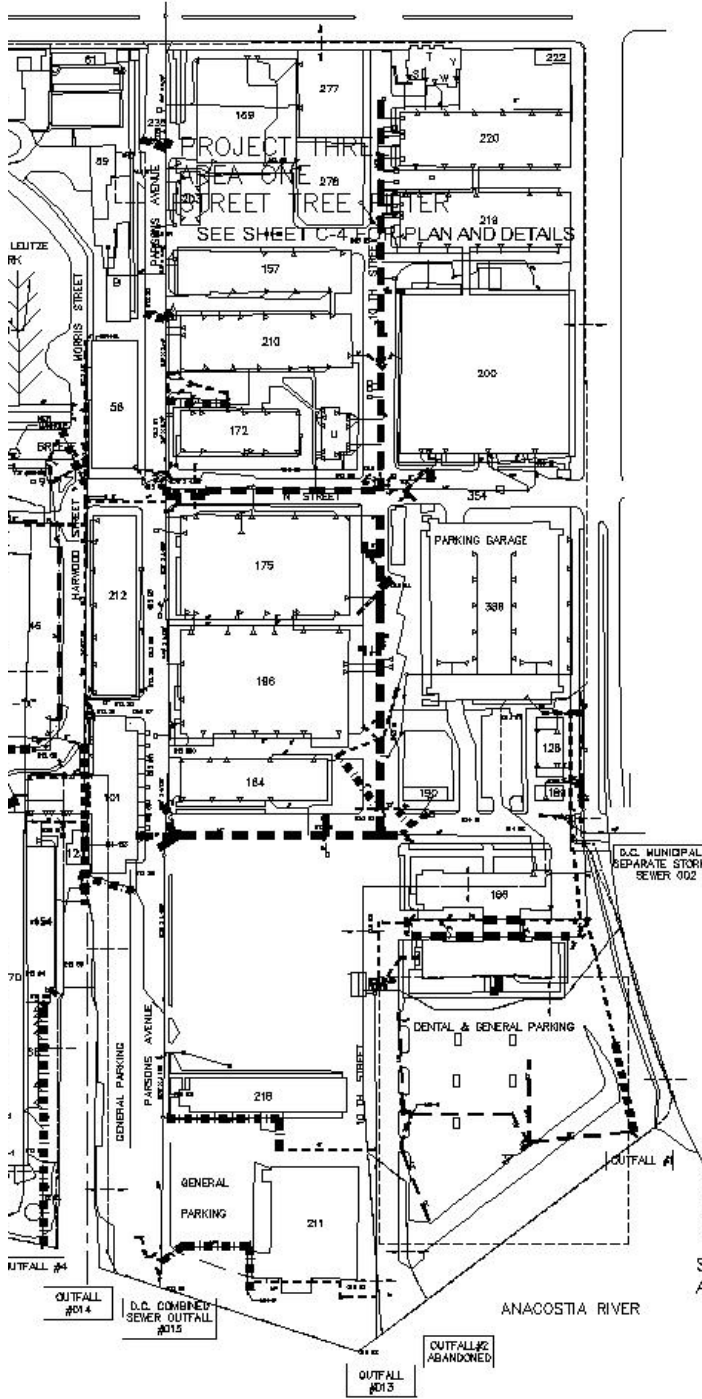

VICINITY MAP
 SCALE: 1"=200'

GENERAL NOTES

1. ALL WORK SHALL BE IN ACCORDANCE WITH THE DISTRICT OF COLUMBIA DEPARTMENT OF PUBLIC WORKS (D.C. DPW) SPECIFICATIONS AND STANDARDS.
2. ALL WORK SHALL BE IN ACCORDANCE WITH THE DISTRICT OF COLUMBIA DEPARTMENT OF PUBLIC WORKS (D.C. DPW) SPECIFICATIONS AND STANDARDS.
3. ALL WORK SHALL BE IN ACCORDANCE WITH THE DISTRICT OF COLUMBIA DEPARTMENT OF PUBLIC WORKS (D.C. DPW) SPECIFICATIONS AND STANDARDS.
4. ALL WORK SHALL BE IN ACCORDANCE WITH THE DISTRICT OF COLUMBIA DEPARTMENT OF PUBLIC WORKS (D.C. DPW) SPECIFICATIONS AND STANDARDS.
5. ALL WORK SHALL BE IN ACCORDANCE WITH THE DISTRICT OF COLUMBIA DEPARTMENT OF PUBLIC WORKS (D.C. DPW) SPECIFICATIONS AND STANDARDS.
6. ALL WORK SHALL BE IN ACCORDANCE WITH THE DISTRICT OF COLUMBIA DEPARTMENT OF PUBLIC WORKS (D.C. DPW) SPECIFICATIONS AND STANDARDS.
7. ALL WORK SHALL BE IN ACCORDANCE WITH THE DISTRICT OF COLUMBIA DEPARTMENT OF PUBLIC WORKS (D.C. DPW) SPECIFICATIONS AND STANDARDS.
8. ALL WORK SHALL BE IN ACCORDANCE WITH THE DISTRICT OF COLUMBIA DEPARTMENT OF PUBLIC WORKS (D.C. DPW) SPECIFICATIONS AND STANDARDS.
9. ALL WORK SHALL BE IN ACCORDANCE WITH THE DISTRICT OF COLUMBIA DEPARTMENT OF PUBLIC WORKS (D.C. DPW) SPECIFICATIONS AND STANDARDS.
10. ALL WORK SHALL BE IN ACCORDANCE WITH THE DISTRICT OF COLUMBIA DEPARTMENT OF PUBLIC WORKS (D.C. DPW) SPECIFICATIONS AND STANDARDS.

**PROJECT TWO
 BUILDING 166
 PARKING AREA
 RETROFIT**
 SEE SHEET C-5 FOR PLAN
 AND C-6 FOR PROFILES AND DETAILS

DC PLAN # 365

OHM Remediation Services Corp.
 200 HORIZON CENTER BOULEVARD
 FORT WASHINGTON, PA 19073-1000

NO.	DATE	DESCRIPTION
1	06/12/00	ADDED DETAILS AND PROFILE
2	02/15/01	AREA DESIGNATIONS

THIS DRAWING SHALL BE USED FOR THE PROJECT DESCRIBED IN THE TITLE BLOCK ONLY AND NOT FOR ANY OTHER PROJECT. IF IT IS USED FOR ANY OTHER PROJECT, THE USER SHALL BE RESPONSIBLE FOR OBTAINING THE NECESSARY PERMISSIONS FROM THE ORIGINAL DRAWING ENGINEER.

UNITED STATES NAVY YARD
 WATER QUALITY
 IMPROVEMENT PROJECT
 COVER SHEET AND PROJECT
 LOCATION MAP

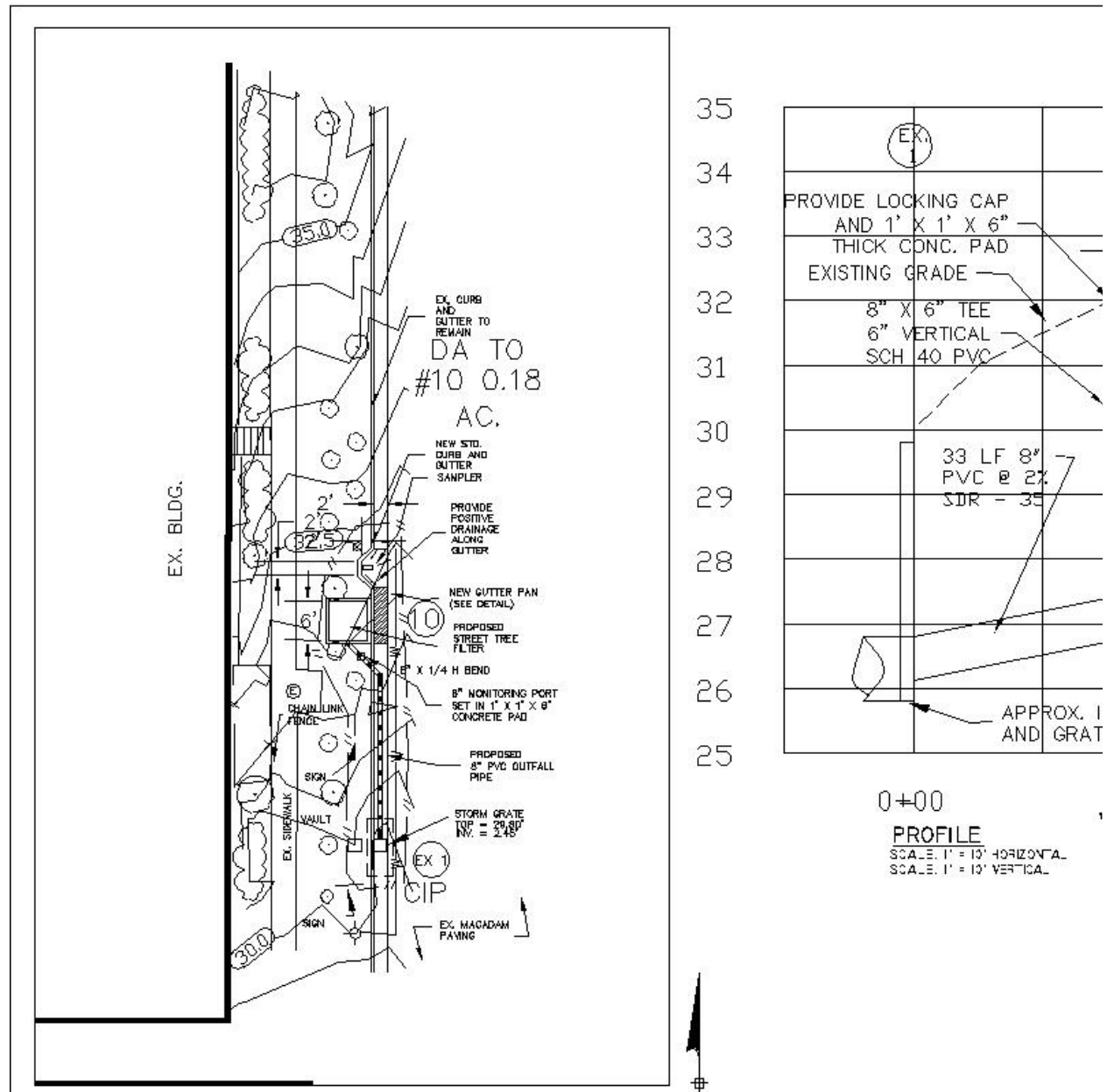

PROJECT THREE
PLAN VIEW
 SCALE: 1" = 10'

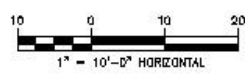

35
 34
 33
 32
 31
 30
 29
 28
 27
 26
 25

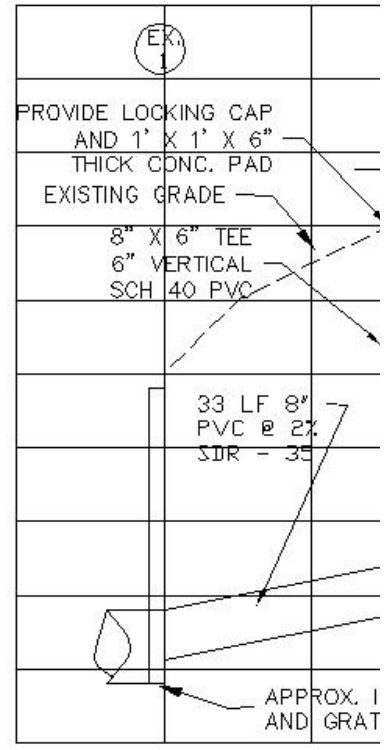

0+00
PROFILE
 SCALE: 1" = 10' HORIZONTAL
 SCALE: 1" = 10' VERTICAL

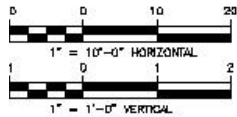
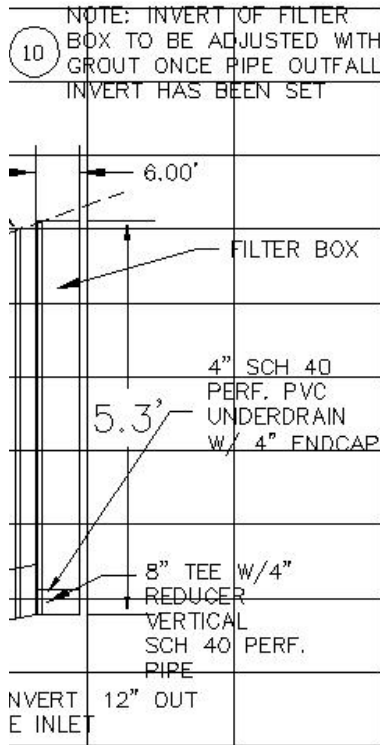

35
34
33
32
31
30
29
28
27
26
25

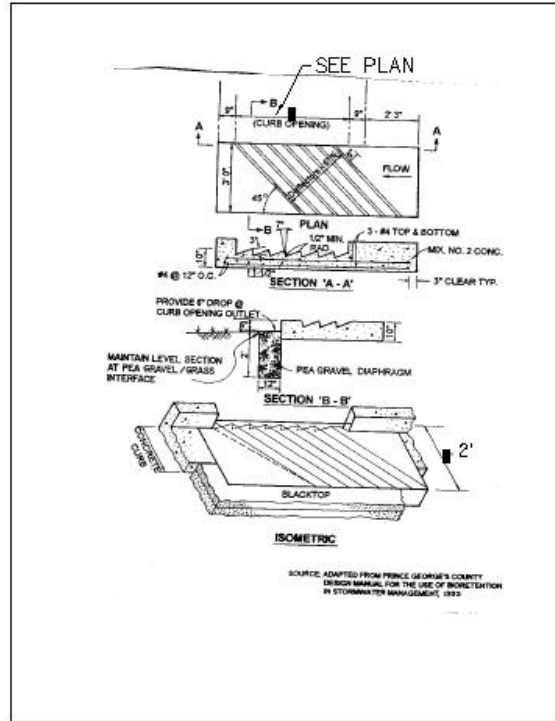

MODIFIED CURB AND GUTTER DETAIL
NOT TO SCALE

0+80



200 HORIZON CENTER BOULEVARD
TRENTON, NEW JERSEY 08691
(609) 584-8900

THE LOW IMPACT
DEVELOPMENT
CENTER, INC.

3 PLAINFIELD AVENUE
PLAINFIELD, NEW JERSEY

NO.	DATE	DESCRIPTION	ISSUE

THIS DRAWING SHALL BE USED FOR THE PROJECT INDICATED IN THE TITLE BLOCK ONLY AND NOT FOR ANY OTHER PROJECT. IF IT IS REPRODUCED FOR ANY OTHER PROJECT, THE USER SHALL BE RESPONSIBLE FOR OBTAINING THE NECESSARY PERMISSIONS FROM THE ORIGINAL DRAWING AUTHOR AND OWNER IN BLUE.

UNITED STATES NAVY YARD
WATER QUALITY
IMPROVEMENT PROJECT

PROJECT THREE: PARSONS AVENUE
WATER QUALITY IMPROVEMENT PROJECT

DATE: 02/03/01	SHEET 4 OF 5
CHECKED BY: [Signature]	PROJECT NUMBER: 9206315
	DRAWING NUMBER: 0-4

NOTES

1. ALL STRUCTURES TO BE H-20 LOADING
2. CONTRACTOR TO VERIFY ALL UTILITY LOCATIONS AND TEST POINT LOCATIONS BY HAND.
3. SEE SHEET 0-7 FOR LEGEND

WHEEL STOP. EPOXY ANCHORS.

2 FT. STRIP NEOPRENE
LINER - CONTINUOUS

30 MIL HDPE LINER W/NON
WOVEN FABRIC. ANCHOR
TO SIDE WALL. PROVIDE
SLACK 2" MIN

1' WIDTH CLASS "F" FABRIC

4" PERFORATED HDPE
#57 STONE W/ 1"
#7 STONE ON TOP
BOTTOM

PROVIDE DEEP CURB
IF REQUIRED
ALONG EDGE

BIORETENTION FACILITY
USE PEA GRAVEL TO LEVEL

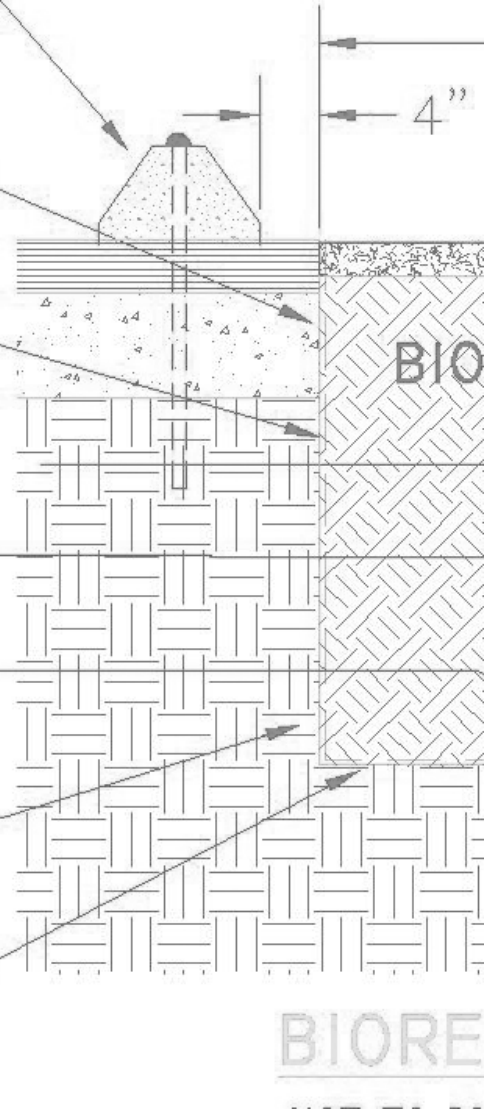

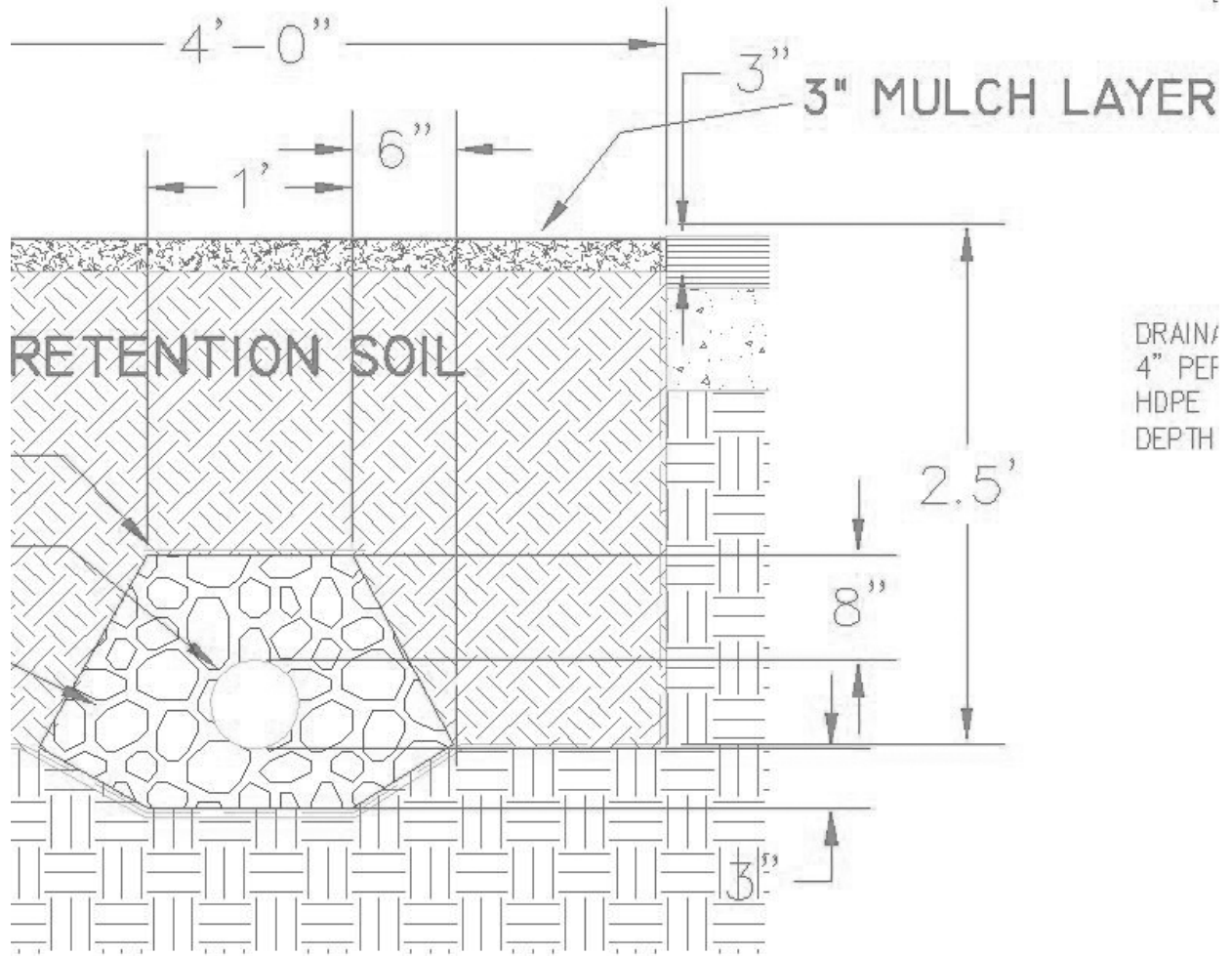

RETENTION TRENCH DETAIL

PWTB 200-1-62
1 October 2008

PWTB 200-1-62
1 October 2008

APPENDIX G: U.S. Army LEED® Implementation Guide

December 17, 2007

Headquarters, U.S. Army Corps of Engineers

The following excerpt from the LEED® Implementation Guide addresses the minimum requirements section from the guide:

3. Requirements

a. MINIMUM REQUIREMENT - NEW CONSTRUCTION. Starting with the FY08 program, all vertical construction projects with climate-controlled facilities will achieve the SILVER level of LEED-NC® (Leadership in Energy and Environmental Design-New Construction). This requirement applies worldwide to all construction on permanent Army installations, Army Reserve, Army Readiness Centers and Armed Forces Reserve Centers, regardless of funding source and including Base Realignment and Closure (BRAC). For tenant projects on Army property, USACE project Master Planner and Project Manager (PM) will make the tenant organization aware of this requirement and advise them to coordinate directly with the installation Directorate of Public Works (DPW) if this requirement cannot be met. Projects prior to the FY 08 program will continue to use Sustainable Project Rating Tool (SPiRiT) and achieve the minimum GOLD rating level. Such projects may be scored using LEED® if the LEED® SILVER rating level can be achieved within the programmed amount.

b. MINIMUM REQUIREMENT - RENOVATION AND REPAIR. Renovation and repair projects are defined as major renovation and shall meet the same requirement as new construction when they:

(1) Exceed the garrison commander authority AND

(2) Have a repair to replacement ratio equal to or greater than 25 percent. Note: Both UFC 3-701-07, DoD Facilities Pricing Guide, and DA Pamphlet 420-11, Project Definition and Work Classification, provide guidance for computing the facility replacement value.

Renovation and repair projects that do not meet the above definition for major renovation will be evaluated using LEED-NC® and incorporate sustainable design features to the maximum extent possible, but will be exempt from the minimum score that applies to new construction.

c. NEW CONSTRUCTION MINIMUM LEED-NC[®] SCORE EXEMPTIONS:

(1) HORIZONTAL CONSTRUCTION. Horizontal construction projects, such as ranges, roads and airfields, will be evaluated using LEED-NC[®] and incorporate sustainable design features to the maximum extent possible, but will be exempt from the minimum score that applies to new construction. Climate-controlled buildings included in horizontal construction projects are not included in this exemption and shall achieve the minimum LEED-NC[®] rating.

(2) BUILDINGS THAT ARE NOT CLIMATE-CONTROLLED. If the building has no climate controlled area, the building will be evaluated using LEED-NC[®] to incorporate sustainable design features to the maximum extent possible, but it is exempt from the minimum score that applies to new construction. A climate-controlled area is an area that is mechanically heated and/or mechanically cooled for human comfort.

(3) ARMY FAMILY HOUSING. SPiRiT will be used to rate all Army Family Housing new construction projects and homes built under the Residential Communities Initiative. These projects will achieve SPiRiT GOLD level.

(4) OVERSEAS CONTINGENCY CONSTRUCTION AND CONUS INTERIM FACILITIES. This requirement applies to permanent facility construction only. Excluded are overseas contingency construction and CONUS interim facilities. An interim facility requirement is a short-term (normally 3 yrs or less) urgent requirement for facilities due to transitory peak military missions, deployments, military contingency operations, disaster relief requirements, or pending approval and construction of real property facilities via normal military construction programs.

d. FAILURE TO MEET REQUIREMENTS. If, after budget lock, a project cannot meet LEED[®] requirements within funds available, the Project Delivery Team (PDT) shall submit a change request per the procedures in Army Regulation (AR) 420-1, Army Facilities Management (chapter 4). This will be done as soon as the failure is known, but no later than the next prescribed reporting point (paragraph 7). If, at project completion, the required level is not achieved, the PM will prepare a lessons learned report and forward it to the Regional Integration Team (RIT) Program Manager and the Engineering and Construction (E&C) cost engineering point of contact (POC) with an explanation as to why this level was not achieved.

PWTB 200-1-62
1 October 2008

PWTB 200-1-62
1 October 2008

APPENDIX H: Potential LEED® Credits as Related to LID Practices

LID, LEED® & Military Training Area Applications

Note: since LEED® credits are earned at the end of a project, the LEED® credit designations shown are to be considered as part of the whole project, this chart is intended to show where, in the construction process for each of the military use areas, credits may potentially be earned.

LID Tool	LEED® Credit	Assembly Areas	Bivouac Areas	Driver Training Sites	Drop Zones	Maneuver Corridors	Urban Operations (MOUT)	Multi-Purpose Range Complex	Parking Areas	Secondary Roads	Small Arms Ranges	Tank Trails		
Construction Phase														
Compost Filter Socks	Sustainable Sites (SS) SS P1 (Erosion and Sedimentation Control P2)	x	x	x	x		x	x	x	x	x	x		
	SS 5.1 (Habitat Protection and Restoration: Minimize site disturbance)	x	x	x	x		x	x	x	x	x	x		
	SS 6.1 (Stormwater Management - Quantity Control)	x	x	x	x		x	x	x	x	x	x		
	SS 6.2 (Stormwater Management - Quality Control)	x	x	x	x		x	x	x	x	x	x		
	MR 5.1 (Regional Materials 10% by total job cost), MR 5.2 (Regional Materials- 20% by total job cost)	x	x	x	x		x	x	x	x	x	x		
	MR 6 (Rapidly Renewable Materials - 2.5% total value of building materials)	x	x	x	x		x	x	x	x	x	x		see note by bio-retention cell
Filter Mats	Sustainable Sites (SS) SS P1 (Erosion and Sedimentation Control P2)	x	x		x									
	SS 5.1 (Habitat Protection and Restoration: Minimize site disturbance)	x	x		x									
	SS 6.1 (Stormwater Management - Quantity Control)	x	x		x									
	SS 6.2 (Stormwater Management - Quality Control)	x	x		x									
	MR 5.1 (Regional Materials 10% by total job cost), MR 5.2 (Regional Materials- 20% by total job cost)	x	x		x									

		Assembly Areas	Bivouac Areas	Driver Training Sites	Drop Zones	Maneuver Corridors	Urban Operations (MOUT)	Multi-Purpose Range Complex	Parking Areas	Secondary Roads	Small Arms Ranges	Tank Trails		
<i>LID Tool</i>	<i>LEED® Credit</i>													
	MR 6 (Rapidly Renewable Materials - 2.5% total value of building materials)	x	x		x									see note by bio-retention cell
Selective Grading	Sustainable Sites (SS) SS P1 (Erosion and Sedimentation Control P2)		x	x		x	x	x	x	x				
	SS 5.1 (Habitat Protection and Restoration:Minimize site disturbance)		x			x	x	x	x	x				
	SS 5.2 (Habitat Protection and Restoration:Maximize Open Space)		x			x	x	x	x	x				
	SS 6.1 (Stormwater Management - Quantity Control)		x			x	x	x	x	x				
	SS 6.2 (Stormwater Management - Quality Control)		x			x	x	x	x	x				
	MR 5.1 (Regional Materials 10% by total job cost), MR 5.2 (Regional Materials- 20% by total job cost)		x				x	x	x	x				
	MR 6 (Rapidly Renewable Materials - 2.5% total value of building materials)		x	x			x	x						
Site Fingerprinting	Sustainable Sites (SS) SS P1 (Erosion and Sedimentation Control P2)		x	x	x	x	x	x	x	x		x		
	SS 1 (Site Selection)		x		x	x	x	x	x	x		x		
	SS 5.1 (Habitat Protection and Restoration:Minimize site disturbance)		x		x	x	x	x	x	x		x		
	SS 5.2 (Habitat Protection and Restoration:Maximize Open Space)		x		x	x	x	x	x	x		x		
Post-Construction Phase														
Bioretention Cell	Sustainable Sites (SS) SS P1 (Erosion and Sedimentation Control P2)	x	x	x	x	x	x	x	x	x	x	x		
	SS 5.1 (Habitat Protection and Restoration:Minimize site disturbance)	x	x	x	x	x	x	x	x	x	x	x		
	SS 6.1 (Stormwater Management - Quantity Control)	x	x	x	x	x	x	x	x	x	x	x		

LID Tool	LEED® Credit	Assembly Areas	Bivouac Areas	Driver Training Sites	Drop Zones	Maneuver Corridors	Urban Operations (MOUT)	Multi-Purpose Range Complex	Parking Areas	Secondary Roads	Small Arms Ranges	Tank Trails		
	SS 6.2 (Stormwater Management - Quality Control)	x	x	x	x	x	x	x	x	x	x	x		
	Water Efficiency (WE) WE 1.1 (Water Efficient Landscaping, Reduce by 50%)	x									x			
	WE 1.2 (Water Efficient Landscaping, no potable water)	x	x	x	x	x	x	x	x	x	x	x		Note: if credit MR 6 is submitted for consideration, it would likely be on the basis of adding to the MR6 project level value — the values here would be based on, e.g., using recyclable pots for plants made from corn, types of geotextile used (if used), or other ag. products made from rapidly renewable building materials and products; recycling plants (i.e., saving and replanting has no specific credit category (they might fall under SS 5.1) but may be submitted for a CIR under innovative design)
	MR 5.1 (Regional Materials 10% by total job cost), MR 5.2 (Regional Materials- 20% by total job cost)	x	x	x	x	x	x	x	x	x	x	x		
Bioretention Cell	MR 6 (Rapidly Renewable Materials - 2.5% total value of building materials)	x	x	x	x	x	x	x	x	x	x	x		
Bioretention Strip	Sustainable Sites (SS) SS P1 (Erosion and Sedimentation Control)	x	x	x	x	x	x	x	x	x	x	x		
	Sustainable Sites (SS) SS 5.2 (Habitat Protection and Restoration:Maximize Open Space)	x	x	x	x	x	x	x	x	x	x	x		
	SS 6.1 (Stormwater Management - Quantity Control)	x	x	x	x	x	x	x	x	x	x	x		
	SS 6.2 (Stormwater Management - Quality Control)	x	x	x	x	x	x	x	x	x	x	x		
Bioretention Strip	Water Efficiency (WE) WE 1.1 (Water Efficient Landscaping, Reduce by 50%)	x					x	x			x			
	WE 1.2 (Water Efficient Landscaping, no potable water)	x	x	x	x	x	x	x	x	x	x	x		
	MR 5.1 (Regional Materials 10% by total job cost), MR 5.2 (Regional Materials- 20% by total job cost)	x	x	x	x	x	x	x	x	x	x	x		
	MR 6 (Rapidly Renewable Materials - 2.5% total value of building materials)	x	x	x	x	x	x	x	x	x	x	x	see note by bio-retention cell	
Bioswale	Sustainable Sites (SS) SS P1 (Erosion and Sedimentation Control)		x	x	x	x	x	x	x	x	x	x	note: some assembly areas may have room for a bioswale	
	Sustainable Sites (SS) SS 5.2 (Habitat		x	x	x	x	x	x	x	x	x	x		

LID Tool	LEED® Credit	Assembly Areas	Bivouac Areas	Driver Training Sites	Drop Zones	Maneuver Corridors	Urban Operations (MOUT)	Multi-Purpose Range Complex	Parking Areas	Secondary Roads	Small Arms Ranges	Tank Trails		
	Protection and Restoration:Maximize Open Space)													
	SS 6.1 (Stormwater Management - Quantity Control)		x	x	x	x	x	x	x	x	x	x		
	SS 6.2 (Stormwater Management - Quality Control)		x	x	x	x	x	x	x	x	x	x		
	Water Efficiency (WE) WE 1.1 (Water Efficient Landscaping, Reduce by 50%)						x	x			x			
	WE 1.2 (Water Efficient Landscaping, no potable water)		x	x	x	x	x	x	x	x	x	x		
	MR 5.1 (Regional Materials 10% by total job cost), MR 5.2 (Regional Materials- 20% by total job cost)		x	x	x	x	x	x	x	x	x	x		
	MR 6 (Rapidly Renewable Materials - 2.5% total value of building materials)		x	x	x	x	x	x	x	x	x	x		see note by bio-retention cell
Downspout Disconnection/ Rain Barrels and Cisterns	Sustainable Sites (SS) SS 6.1 (Stormwater Management - Quantity Control)													Green Roofs may also be an option for Small Weapons Firing Ranges: SS 5.1, SS 6.1, SS 6.2, SS 7.2 (Urban Heat Island- Roof), WE 1.1, WE 1.2, MR 4.1, MR 4.2, MR 6 may all apply to green roofs
	SS 6.2 (Stormwater Management - Quality Control)										x			
	Water Efficiency (WE) WE 1.1 (Water Efficient Landscaping, Reduce by 50%)										x			
	WE 1.2 (Water Efficient Landscaping, no potable water)										x			
	Materials and Reuse (MR) MR 4.1 (Recycled Content - 10%), MR 4.2 (Recycled Content - 20%)											x		
	MR 5.1 (Regional Materials 10% by total job cost), MR 5.2 (Regional Materials- 20% by total job cost)											x		
	MR 6 (Rapidly Renewable Materials - 2.5% total value of building materials)											x		
Grass-lined	Sustainable Sites (SS) SS P1 (Erosion		x	x		x	x	x			x	x		

<i>LID Tool</i>	<i>LEED® Credit</i>	<i>Assembly Areas</i>	<i>Bivouac Areas</i>	<i>Driver Training Sites</i>	<i>Drop Zones</i>	<i>Maneuver Corridors</i>	<i>Urban Operations (MOUT)</i>	<i>Multi-Purpose Range Complex</i>	<i>Parking Areas</i>	<i>Secondary Roads</i>	<i>Small Arms Ranges</i>	<i>Tank Trails</i>		
swale	and Sedimentation Control)													
	Sustainable Sites (SS) SS 5.2 (Habitat Protection and Restoration:Maximize Open Space)		x	x		x	x	x			x	x		
	SS 6.1 (Stormwater Management - Quantity Control)		x	x		x	x	x			x	x		
	SS 6.2 (Stormwater Management - Quality Control)		x	x		x	x	x			x	x		
	Water Efficiency (WE) WE 1.1 (Water Efficient Landscaping, Reduce by 50%)		x			x	x	x						
	WE 1.2 (Water Efficient Landscaping, no potable water)		x	x		x	x	x			x	x		
	MR 5.1 (Regional Materials 10% by total job cost), MR 5.2 (Regional Materials- 20% by total job cost)		x	x		x	x	x			x	x		
Vegetated swale	Sustainable Sites (SS) SS P1 (Erosion and Sedimentation Control)		x	x		x	x	x			x	x		
	Sustainable Sites (SS) SS 5.2 (Habitat Protection and Restoration:Maximize Open Space)		x	x		x	x	x			x	x		
	SS 6.1 (Stormwater Management - Quantity Control)		x	x		x	x	x			x	x		
	SS 6.2 (Stormwater Management - Quality Control)		x	x		x	x	x			x	x		
	Water Efficiency (WE) WE 1.1 (Water Efficient Landscaping, Reduce by 50%)		x	x		x	x	x			x	x		
	WE 1.2 (Water Efficient Landscaping, no potable water)		x	x		x	x	x			x	x		
	MR 5.1 (Regional Materials 10% by total job cost), MR 5.2 (Regional Materials- 20% by total job cost)		x	x		x	x	x			x	x		
	MR 6 (Rapidly Renewable Materials - 2.5% total value of building materials)		x	x		x	x	x			x	x		see note by bio-retention cell
Reforestation	Sustainable Sites (SS) SS P1 (Erosion			x								x		

		Assembly Areas	Bivouac Areas	Driver Training Sites	Drop Zones	Maneuver Corridors	Urban Operations (MOUT)	Multi-Purpose Range Complex	Parking Areas	Secondary Roads	Small Arms Ranges	Tank Trails		
<i>LID Tool</i>	<i>LEED® Credit</i>													
	and Sedimentation Control)													
	Sustainable Sites (SS) SS 5.2 (Habitat Protection and Restoration:Maximize Open Space)			x								x		
	SS 6.1 (Stormwater Management - Quantity Control)			x								x		
	SS 6.2 (Stormwater Management - Quality Control)			x								x		
	Water Efficiency (WE) WE 1.1 (Water Efficient Landscaping, Reduce by 50%)													
	WE 1.2 (Water Efficient Landscaping, no potable water)			x								x		
	MR 5.1 (Regional Materials 10% by total job cost), MR 5.2 (Regional Materials- 20% by total job cost)			x								x		
	MR 6 (Rapidly Renewable Materials - 2.5% total value of building materials)			x								x		see note by bio-retention cell
Site Recovery Phase														
Compost Amendments	Sustainable Sites (SS) SS 6.1 (Stormwater Management - Quantity Control)	x	x		x									
	SS 6.2 (Stormwater Management - Quality Control)	x	x		x									
	Water Efficiency (WE) WE 1.1 (Water Efficient Landscaping, Reduce by 50%)	x	x		x									
	WE 1.2 (Water Efficient Landscaping, no potable water)	x	x		x									
	Materials and Reuse (MR) MR 4.1 (Recycled Content - 10%), MR 4.2 (Recycled Content - 20%)	x	x		x									
	MR 5.1 (Regional Materials 10% by total job cost), MR 5.2 (Regional Materials- 20% by total job cost)													

LID Tool	LEED® Credit	Assembly Areas	Bivouac Areas	Driver Training Sites	Drop Zones	Maneuver Corridors	Urban Operations (MOUT)	Multi-Purpose Range Complex	Parking Areas	Secondary Roads	Small Arms Ranges	Tank Trails				
Afforestation/ Reforestation	Sustainable Sites (SS) SS P1 (Erosion and Sedimentation Control)	x	x	x	x	x	x	x				x				
	Sustainable Sites (SS) SS 5.2 (Habitat Protection and Restoration:Maximize Open Space)	x	x	x	x	x	x	x				x				
	SS 6.1 (Stormwater Management - Quantity Control)	x	x	x	x	x	x	x				x				
	SS 6.2 (Stormwater Management - Quality Control)	x	x	x	x	x	x	x				x				
	Water Efficiency (WE) WE 1.1 (Water Efficient Landscaping, Reduce by 50%)	x	x		x	x	x	x								
	WE 1.2 (Water Efficient Landscaping, no potable water)	x	x	x	x	x	x	x				x				
	MR 5.1 (Regional Materials 10% by total job cost), MR 5.2 (Regional Materials- 20% by total job cost)	x	x	x	x	x	x	x				x		see note by bio-retention cell		

This publication may be reproduced