

**DRAFT  
TOXICOLOGICAL PROFILE FOR  
MANGANESE**

U.S. DEPARTMENT OF HEALTH AND HUMAN SERVICES  
Public Health Service  
Agency for Toxic Substances and Disease Registry

September 2008

## DISCLAIMER

The use of company or product name(s) is for identification only and does not imply endorsement by the Agency for Toxic Substances and Disease Registry.

This information is distributed solely for the purpose of pre dissemination public comment under applicable information quality guidelines. It has not been formally disseminated by the Agency for Toxic Substances and Disease Registry. It does not represent and should not be construed to represent any agency determination or policy.

## UPDATE STATEMENT

A Toxicological Profile for Manganese was released in 2000. This present edition supersedes any previously released draft or final profile.

Toxicological profiles are revised and republished as necessary. For information regarding the update status of previously released profiles, contact ATSDR at:

Agency for Toxic Substances and Disease Registry  
Division of Toxicology and Environmental Medicine/Applied Toxicology Branch  
1600 Clifton Road NE  
Mailstop F-32  
Atlanta, Georgia 30333

This page is intentionally blank.

## FOREWORD

This toxicological profile is prepared in accordance with guidelines developed by the Agency for Toxic Substances and Disease Registry (ATSDR) and the Environmental Protection Agency (EPA). The original guidelines were published in the *Federal Register* on April 17, 1987. Each profile will be revised and republished as necessary.

The ATSDR toxicological profile succinctly characterizes the toxicologic and adverse health effects information for the hazardous substance described therein. Each peer-reviewed profile identifies and reviews the key literature that describes a hazardous substance's toxicologic properties. Other pertinent literature is also presented, but is described in less detail than the key studies. The profile is not intended to be an exhaustive document; however, more comprehensive sources of specialty information are referenced.

The focus of the profiles is on health and toxicologic information; therefore, each toxicological profile begins with a public health statement that describes, in nontechnical language, a substance's relevant toxicological properties. Following the public health statement is information concerning levels of significant human exposure and, where known, significant health effects. The adequacy of information to determine a substance's health effects is described in a health effects summary. Data needs that are of significance to protection of public health are identified by ATSDR and EPA.

Each profile includes the following:

- (A) The examination, summary, and interpretation of available toxicologic information and epidemiologic evaluations on a hazardous substance to ascertain the levels of significant human exposure for the substance and the associated acute, subacute, and chronic health effects;
- (B) A determination of whether adequate information on the health effects of each substance is available or in the process of development to determine levels of exposure that present a significant risk to human health of acute, subacute, and chronic health effects; and
- (C) Where appropriate, identification of toxicologic testing needed to identify the types or levels of exposure that may present significant risk of adverse health effects in humans.

The principal audiences for the toxicological profiles are health professionals at the Federal, State, and local levels; interested private sector organizations and groups; and members of the public. We plan to revise these documents in response to public comments and as additional data become available. Therefore, we encourage comments that will make the toxicological profile series of the greatest use.

Comments should be sent to:

Agency for Toxic Substances and Disease Registry  
Division of Toxicology and Environmental Medicine  
1600 Clifton Road NE  
Mail Stop F-32  
Atlanta, Georgia 30333

### Background Information

The toxicological profiles are developed in response to the Superfund Amendments and Reauthorization Act (SARA) of 1986 (Public Law 99 499) which amended the Comprehensive Environmental Response, Compensation, and Liability Act of 1980 (CERCLA or Superfund). This public law directed ATSDR to prepare toxicological profiles for hazardous substances most commonly found at facilities on the CERCLA National Priorities List and that pose the most significant potential threat to human health, as determined by ATSDR and the EPA. The availability of the revised priority list of 275 hazardous substances was announced in the Federal Register on December 7, 2005 (70 FR 72840). For prior versions of the list of substances, see Federal Register notices dated April 17, 1987 (52 FR 12866); October 20, 1988 (53 FR 41280); October 26, 1989 (54 FR 43619); October 17, 1990 (55 FR 42067); October 17, 1991 (56 FR 52166); October 28, 1992 (57 FR 48801); February 28, 1994 (59 FR 9486); April 29, 1996 (61 FR 18744); November 17, 1997 (62 FR 61332); October 21, 1999 (64 FR 56792); October 25, 2001 (66 FR 54014) and November 7, 2003 (68 FR 63098). Section 104(i)(3) of CERCLA, as amended, directs the Administrator of ATSDR to prepare a toxicological profile for each substance on the list.

This profile reflects ATSDR's assessment of all relevant toxicologic testing and information that has been peer-reviewed. Staff of the Centers for Disease Control and Prevention and other Federal scientists have also reviewed the profile. In addition, this profile has been peer-reviewed by a nongovernmental panel and was made available for public review. Final responsibility for the contents and views expressed in this toxicological profile resides with ATSDR.



Howard Frumkin M.D., Dr.P.H.  
Director  
National Center for Environmental Health/  
Agency for Toxic Substances and  
Disease Registry

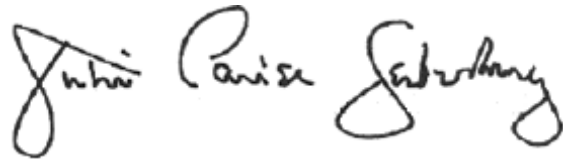

Julie Louise Gerberding, M.D., M.P.H.  
Administrator  
Agency for Toxic Substances and  
Disease Registry

## QUICK REFERENCE FOR HEALTH CARE PROVIDERS

Toxicological Profiles are a unique compilation of toxicological information on a given hazardous substance. Each profile reflects a comprehensive and extensive evaluation, summary, and interpretation of available toxicologic and epidemiologic information on a substance. Health care providers treating patients potentially exposed to hazardous substances will find the following information helpful for fast answers to often-asked questions.

---

### *Primary Chapters/Sections of Interest*

**Chapter 1: Public Health Statement:** The Public Health Statement can be a useful tool for educating patients about possible exposure to a hazardous substance. It explains a substance's relevant toxicologic properties in a nontechnical, question-and-answer format, and it includes a review of the general health effects observed following exposure.

**Chapter 2: Relevance to Public Health:** The Relevance to Public Health Section evaluates, interprets, and assesses the significance of toxicity data to human health.

**Chapter 3: Health Effects:** Specific health effects of a given hazardous compound are reported by type of health effect (death, systemic, immunologic, reproductive), by route of exposure, and by length of exposure (acute, intermediate, and chronic). In addition, both human and animal studies are reported in this section.

**NOTE:** Not all health effects reported in this section are necessarily observed in the clinical setting. Please refer to the Public Health Statement to identify general health effects observed following exposure.

**Pediatrics:** Four new sections have been added to each Toxicological Profile to address child health issues:

**Section 1.6**     **How Can (Chemical X) Affect Children?**  
**Section 1.7**     **How Can Families Reduce the Risk of Exposure to (Chemical X)?**  
**Section 3.7**     **Children's Susceptibility**  
**Section 6.6**     **Exposures of Children**

### **Other Sections of Interest:**

**Section 3.8**     **Biomarkers of Exposure and Effect**  
**Section 3.11**   **Methods for Reducing Toxic Effects**

---

### *ATSDR Information Center*

**Phone:** 1-800-CDC-INFO (800-232-4636) or **Fax:** (770) 488-4178  
1-888-232-6348 (TTY)

**E-mail:** [cdcinfo@cdc.gov](mailto:cdcinfo@cdc.gov)                      **Internet:** <http://www.atsdr.cdc.gov>

The following additional material can be ordered through the ATSDR Information Center:

*Case Studies in Environmental Medicine: Taking an Exposure History*—The importance of taking an exposure history and how to conduct one are described, and an example of a thorough exposure history is provided. Other case studies of interest include *Reproductive and Developmental Hazards*; *Skin Lesions and Environmental Exposures*; *Cholinesterase-Inhibiting Pesticide Toxicity*; and numerous chemical-specific case studies.

*Managing Hazardous Materials Incidents* is a three-volume set of recommendations for on-scene (prehospital) and hospital medical management of patients exposed during a hazardous materials incident. Volumes I and II are planning guides to assist first responders and hospital emergency department personnel in planning for incidents that involve hazardous materials. Volume III—*Medical Management Guidelines for Acute Chemical Exposures*—is a guide for health care professionals treating patients exposed to hazardous materials.

*Fact Sheets (ToxFAQs)* provide answers to frequently asked questions about toxic substances.

---

### ***Other Agencies and Organizations***

*The National Center for Environmental Health (NCEH)* focuses on preventing or controlling disease, injury, and disability related to the interactions between people and their environment outside the workplace. Contact: NCEH, Mailstop F-29, 4770 Buford Highway, NE, Atlanta, GA 30341-3724 • Phone: 770-488-7000 • FAX: 770-488-7015.

*The National Institute for Occupational Safety and Health (NIOSH)* conducts research on occupational diseases and injuries, responds to requests for assistance by investigating problems of health and safety in the workplace, recommends standards to the Occupational Safety and Health Administration (OSHA) and the Mine Safety and Health Administration (MSHA), and trains professionals in occupational safety and health. Contact: NIOSH, 200 Independence Avenue, SW, Washington, DC 20201 • Phone: 800-356-4674 or NIOSH Technical Information Branch, Robert A. Taft Laboratory, Mailstop C-19, 4676 Columbia Parkway, Cincinnati, OH 45226-1998 • Phone: 800-35-NIOSH.

*The National Institute of Environmental Health Sciences (NIEHS)* is the principal federal agency for biomedical research on the effects of chemical, physical, and biologic environmental agents on human health and well-being. Contact: NIEHS, PO Box 12233, 104 T.W. Alexander Drive, Research Triangle Park, NC 27709 • Phone: 919-541-3212.

---

### ***Referrals***

*The Association of Occupational and Environmental Clinics (AOEC)* has developed a network of clinics in the United States to provide expertise in occupational and environmental issues. Contact: AOEC, 1010 Vermont Avenue, NW, #513, Washington, DC 20005 • Phone: 202-347-4976 • FAX: 202-347-4950 • e-mail: AOEC@AOEC.ORG • Web Page: <http://www.aoec.org/>.

*The American College of Occupational and Environmental Medicine (ACOEM)* is an association of physicians and other health care providers specializing in the field of occupational and environmental medicine. Contact: ACOEM, 25 Northwest Point Boulevard, Suite 700, Elk Grove Village, IL 60007-1030 • Phone: 847-818-1800 • FAX: 847-818-9266.



## CONTRIBUTORS

### CHEMICAL MANAGER(S)/AUTHOR(S):

Malcolm Williams, DVM, Ph.D.

G. Daniel Todd, Ph.D.

Nickolette Roney, M.P.H.

Jewell Crawford, M.D.

Charleton Coles, Ph.D.

ATSDR, Division of Toxicology and Environmental Medicine, Atlanta, GA

Peter R. McClure, Ph.D., DABT

Joan D. Garey, Ph.D.

Mario Citra, Ph.D.

Syracuse Research Corporation, North Syracuse, NY

### THE PROFILE HAS UNDERGONE THE FOLLOWING ATSDR INTERNAL REVIEWS:

1. Health Effects Review. The Health Effects Review Committee examines the health effects chapter of each profile for consistency and accuracy in interpreting health effects and classifying end points.
2. Minimal Risk Level Review. The Minimal Risk Level Workgroup considers issues relevant to substance-specific Minimal Risk Levels (MRLs), reviews the health effects database of each profile, and makes recommendations for derivation of MRLs.
3. Data Needs Review. The Applied Toxicology Branch reviews data needs sections to assure consistency across profiles and adherence to instructions in the Guidance.
4. Green Border Review. Green Border review assures the consistency with ATSDR policy.

This page is intentionally blank.

## PEER REVIEW

A peer review panel was assembled for manganese. The panel consisted of the following members:

1. David Dorman, D.V.M., Ph.D., Associate Dean for Research and Graduate Studies, College of Veterinary Medicine, Professor of Toxicology, Department of Molecular Biomedical Sciences, North Carolina State University, Raleigh, North Carolina 27606,
2. Donald Smith, Ph.D., Professor of Environmental Toxicology, University of California, Santa Cruz, California 95064, and
3. Wei Zheng, Ph.D., Director of Graduate Studies, School of Health Sciences, Purdue University, West Lafayette, Indiana 47907.

These experts collectively have knowledge of manganese's physical and chemical properties, toxicokinetics, key health end points, mechanisms of action, human and animal exposure, and quantification of risk to humans. All reviewers were selected in conformity with the conditions for peer review specified in Section 104(I)(13) of the Comprehensive Environmental Response, Compensation, and Liability Act, as amended.

Scientists from the Agency for Toxic Substances and Disease Registry (ATSDR) have reviewed the peer reviewers' comments and determined which comments will be included in the profile. A listing of the peer reviewers' comments not incorporated in the profile, with a brief explanation of the rationale for their exclusion, exists as part of the administrative record for this compound.

The citation of the peer review panel should not be understood to imply its approval of the profile's final content. The responsibility for the content of this profile lies with the ATSDR.

This page is intentionally blank.

## CONTENTS

|  |      |
|--|------|
| DISCLAIMER .....   | ii   |
| UPDATE STATEMENT .....   | iii  |
| FOREWORD .....   | v    |
| QUICK REFERENCE FOR HEALTH CARE PROVIDERS.....   | vii  |
| CONTRIBUTORS .....   | ix   |
| PEER REVIEW .....  | xi   |
| CONTENTS.....  | xiii |
| LIST OF FIGURES .....  | xvii |
| LIST OF TABLES .....   | xix  |
| <br>   |      |
| 1. PUBLIC HEALTH STATEMENT.....  | 1    |
| 1.1    WHAT IS MANGANESE?.....   | 2    |
| 1.2    WHAT HAPPENS TO MANGANESE WHEN IT ENTERS THE ENVIRONMENT?.....                          | 3    |
| 1.3    HOW MIGHT I BE EXPOSED TO MANGANESE? .....  | 3    |
| 1.4    HOW CAN MANGANESE ENTER AND LEAVE MY BODY? .....  | 4    |
| 1.5    HOW CAN MANGANESE AFFECT MY HEALTH? .....   | 5    |
| 1.6    HOW CAN MANGANESE AFFECT CHILDREN? .....  | 6    |
| 1.7    HOW CAN FAMILIES REDUCE THE RISK OF EXPOSURE TO MANGANESE? .....                        | 7    |
| 1.8    IS THERE A MEDICAL TEST TO DETERMINE WHETHER I HAVE BEEN<br>EXPOSED TO MANGANESE? ..... | 8    |
| 1.9    WHAT RECOMMENDATIONS HAS THE FEDERAL GOVERNMENT MADE TO<br>PROTECT HUMAN HEALTH?.....   | 8    |
| 1.10   WHERE CAN I GET MORE INFORMATION? .....   | 9    |
| <br>   |      |
| 2. RELEVANCE TO PUBLIC HEALTH .....  | 11   |
| 2.1    BACKGROUND AND ENVIRONMENTAL EXPOSURES TO MANGANESE IN THE<br>UNITED STATES.....        | 11   |
| 2.2    SUMMARY OF HEALTH EFFECTS .....   | 14   |
| 2.3    MINIMAL RISK LEVELS (MRLs) .....  | 19   |
| <br>   |      |
| 3. HEALTH EFFECTS .....  | 37   |
| 3.1    INTRODUCTION.....   | 37   |
| 3.2    DISCUSSION OF HEALTH EFFECTS BY ROUTE OF EXPOSURE .....                                 | 39   |
| 3.2.1  Inhalation Exposure .....   | 40   |
| 3.2.1.1  Death .....   | 58   |
| 3.2.1.2  Systemic Effects .....  | 59   |
| 3.2.1.3  Immunological and Lymphoreticular Effects.....  | 65   |
| 3.2.1.4  Neurological Effects .....  | 65   |
| 3.2.1.5  Reproductive Effects .....  | 88   |
| 3.2.1.6  Developmental Effects .....   | 91   |
| 3.2.1.7  Cancer.....   | 91   |
| 3.2.2  Oral Exposure.....  | 92   |
| 3.2.2.1  Death .....   | 92   |
| 3.2.2.2  Systemic Effects .....  | 133  |
| 3.2.2.3  Immunological and Lymphoreticular Effects.....  | 142  |
| 3.2.2.4  Neurological Effects .....  | 143  |
| 3.2.2.5  Reproductive Effects .....  | 165  |
| 3.2.2.6  Developmental Effects .....   | 170  |
| 3.2.2.7  Cancer.....   | 179  |

|         |  |     |
|---------|--|-----|
| 3.2.3   | Dermal Exposure.....   | 180 |
| 3.2.3.1 | Death .....  | 180 |
| 3.2.3.2 | Systemic Effects .....   | 180 |
| 3.2.3.3 | Immunological and Lymphoreticular Effects.....                                 | 182 |
| 3.2.3.4 | Neurological Effects .....   | 182 |
| 3.2.3.5 | Reproductive Effects .....   | 183 |
| 3.2.3.6 | Developmental Effects .....  | 183 |
| 3.2.3.7 | Cancer.....  | 183 |
| 3.2.4   | Diagnostic Uses.....   | 183 |
| 3.2.4.1 | Death.....   | 184 |
| 3.2.4.2 | Systemic Effects .....   | 185 |
| 3.2.4.3 | Immunological and Lymphoreticular Effects .....                                | 189 |
| 3.2.4.4 | Neurological Effects .....   | 189 |
| 3.2.4.5 | Reproductive Effects.....  | 191 |
| 3.2.4.6 | Developmental Effects.....   | 192 |
| 3.3     | GENOTOXICITY .....   | 194 |
| 3.4     | TOXICOKINETICS .....   | 199 |
| 3.4.1   | Absorption.....  | 200 |
| 3.4.1.1 | Inhalation Exposure.....   | 200 |
| 3.4.1.2 | Oral Exposure.....   | 203 |
| 3.4.1.3 | Dermal Exposure .....  | 207 |
| 3.4.2   | Distribution .....   | 207 |
| 3.4.2.1 | Inhalation Exposure.....   | 210 |
| 3.4.2.2 | Oral Exposure .....  | 220 |
| 3.4.2.3 | Dermal Exposure .....  | 223 |
| 3.4.2.4 | Other Routes of Exposure .....   | 223 |
| 3.4.3   | Metabolism.....  | 229 |
| 3.4.4   | Elimination and Excretion.....   | 231 |
| 3.4.4.1 | Inhalation Exposure.....   | 233 |
| 3.4.4.2 | Oral Exposure.....   | 235 |
| 3.4.4.3 | Dermal Exposure .....  | 236 |
| 3.4.4.4 | Other Routes of Exposure .....   | 236 |
| 3.4.5   | Physiologically Based Pharmacokinetic (PBPK)/Pharmacodynamic (PD) Models ..... | 237 |
| 3.5     | MECHANISMS OF ACTION .....   | 257 |
| 3.5.1   | Pharmacokinetic Mechanisms.....  | 257 |
| 3.5.2   | Mechanisms of Toxicity.....  | 260 |
| 3.5.3   | Animal-to-Human Extrapolations .....   | 267 |
| 3.6     | TOXICITIES MEDIATED THROUGH THE NEUROENDOCRINE AXIS .....                      | 269 |
| 3.7     | CHILDREN'S SUSCEPTIBILITY .....  | 271 |
| 3.8     | BIOMARKERS OF EXPOSURE AND EFFECT .....  | 282 |
| 3.8.1   | Biomarkers Used to Identify or Quantify Exposure to Manganese .....            | 283 |
| 3.8.2   | Biomarkers Used to Characterize Effects Caused by Manganese.....               | 288 |
| 3.9     | INTERACTIONS WITH OTHER CHEMICALS .....  | 290 |
| 3.10    | POPULATIONS THAT ARE UNUSUALLY SUSCEPTIBLE .....                               | 292 |
| 3.11    | METHODS FOR REDUCING TOXIC EFFECTS.....  | 297 |
| 3.11.1  | Reducing Peak Absorption Following Exposure .....                              | 297 |
| 3.11.2  | Reducing Body Burden .....   | 298 |
| 3.11.3  | Interfering with the Mechanism of Action for Toxic Effects.....                | 300 |

|         |  |     |
|---------|--|-----|
| 3.12    | ADEQUACY OF THE DATABASE.....                            | 301 |
| 3.12.1  | Existing Information on Health Effects of Manganese..... | 301 |
| 3.12.2  | Identification of Data Needs .....                       | 302 |
| 3.12.3  | Ongoing Studies .....                                    | 320 |
| 4.      | CHEMICAL AND PHYSICAL INFORMATION.....                   | 323 |
| 4.1     | CHEMICAL IDENTITY.....                                   | 323 |
| 4.2     | PHYSICAL AND CHEMICAL PROPERTIES.....                    | 323 |
| 5.      | PRODUCTION, IMPORT/EXPORT, USE, AND DISPOSAL.....        | 331 |
| 5.1     | PRODUCTION .....   | 331 |
| 5.2     | IMPORT/EXPORT .....                                      | 337 |
| 5.3     | USE.....   | 337 |
| 5.4     | DISPOSAL.....  | 339 |
| 6.      | POTENTIAL FOR HUMAN EXPOSURE.....                        | 341 |
| 6.1     | OVERVIEW.....  | 341 |
| 6.2     | RELEASES TO THE ENVIRONMENT .....                        | 343 |
| 6.2.1   | Air .....  | 348 |
| 6.2.2   | Water.....   | 350 |
| 6.2.3   | Soil .....   | 351 |
| 6.3     | ENVIRONMENTAL FATE.....                                  | 351 |
| 6.3.1   | Transport and Partitioning.....                          | 351 |
| 6.3.2   | Transformation and Degradation .....                     | 354 |
| 6.3.2.1 | Air.....   | 354 |
| 6.3.2.2 | Water .....  | 354 |
| 6.3.2.3 | Sediment and Soil.....                                   | 355 |
| 6.4     | LEVELS MONITORED OR ESTIMATED IN THE ENVIRONMENT .....   | 355 |
| 6.4.1   | Air .....  | 355 |
| 6.4.2   | Water.....   | 358 |
| 6.4.3   | Sediment and Soil .....                                  | 361 |
| 6.4.4   | Other Environmental Media.....                           | 362 |
| 6.5     | GENERAL POPULATION AND OCCUPATIONAL EXPOSURE .....       | 364 |
| 6.6     | EXPOSURES OF CHILDREN .....                              | 368 |
| 6.7     | POPULATIONS WITH POTENTIALLY HIGH EXPOSURES .....        | 372 |
| 6.8     | ADEQUACY OF THE DATABASE.....                            | 375 |
| 6.8.1   | Identification of Data Needs .....                       | 375 |
| 6.8.2   | Ongoing Studies .....                                    | 379 |
| 7.      | ANALYTICAL METHODS.....                                  | 381 |
| 7.1     | BIOLOGICAL MATERIALS .....                               | 382 |
| 7.2     | ENVIRONMENTAL SAMPLES.....                               | 384 |
| 7.3     | ADEQUACY OF THE DATABASE.....                            | 388 |
| 7.3.1   | Identification of Data Needs .....                       | 389 |
| 7.3.2   | Ongoing Studies .....                                    | 390 |
| 8.      | REGULATIONS, ADVISORIES, AND GUIDELINES.....             | 391 |
| 9.      | REFERENCES .....   | 397 |
| 10.     | GLOSSARY .....   | 485 |

APPENDICES

A. ATSDR MINIMAL RISK LEVELS AND WORKSHEETS ..... A-1

B. USER’S GUIDE..... B-1

C. ACRONYMS, ABBREVIATIONS, AND SYMBOLS..... C-1

D. INDEX ..... D-1



## LIST OF FIGURES

|  |     |
|--|-----|
| 3-1. Levels of Significant Exposure to Inorganic Manganese – Inhalation .....  | 55  |
| 3-2. Levels of Significant Exposure to Inorganic Manganese – Oral .....  | 123 |
| 3-3. Levels of Significant Exposure to Organic Manganese-MMT – Oral.....   | 130 |
| 3-4. Metabolism of MnDPDP .....  | 232 |
| 3-5. Conceptual Representation of a Physiologically Based Pharmacokinetic (PBPK) Model for a Hypothetical Chemical Substance.....  | 239 |
| 3-6. Qualitative PBPK Model for Manganese .....  | 241 |
| 3-7. Schematic Structures of Nong et al. (2008) PBPK Models A and B for Manganese in CD Rats ....  | 243 |
| 3-8. Schematic of Models for Nasopharyngeal and Lung Deposition of Manganese and Transport to Blood in the Nong et al. (2008) PBPK Models A and B for Manganese in CD Rats .....                             | 244 |
| 3-9. Schematic of the Leavens et al. (2007) Model to Describe Olfactory and Blood Delivery of Manganese to the Left Side of the Brain Isilateral to the Olfactory Mucosa (OM) in the Left Nasal Cavity ..... | 252 |
| 3-10. Existing Information on Health Effects of Inorganic Manganese .....  | 303 |
| 6-1. Frequency of NPL Sites with Manganese Contamination.....  | 342 |

This page is intentionally blank.

## LIST OF TABLES

|  |     |
|--|-----|
| 2-1. Adequate Intake (AI) for Manganese .....  | 13  |
| 3-1. Levels of Significant Exposure to Inorganic Manganese – Inhalation.....   | 41  |
| 3-2. Levels of Significant Exposure to Inorganic Manganese – Oral.....   | 93  |
| 3-3. Levels of Significant Exposure to Organic Manganese-MMT – Oral.....   | 128 |
| 3-4. Scores on Intelligence Tests .....  | 149 |
| 3-5. Genotoxicity of Manganese <i>In Vitro</i> .....   | 195 |
| 3-6. Genotoxicity of Manganese <i>In Vivo</i> .....  | 198 |
| 3-7. Manganese Levels in Human and Animal Tissues.....   | 208 |
| 3-8. Manganese Levels in Human Serum/Plasma.....   | 211 |
| 3-9. Terminal Mean ( $\pm$ Standard Error on the Mean) Tissue Manganese Concentrations ( $\mu\text{g}$ Manganese/g Tissue Wet Weight) in Maternal CD Rats Exposed to Aerosols of Manganese Sulfate 6 Hours/Day, 7 Days/Week Starting 28 Days Prior to Breeding Through Postnatal Day 18..... | 215 |
| 3-10. Mean ( $\pm$ Standard Error on the Mean) Tissue Manganese Concentrations ( $\mu\text{g}$ Manganese/g Tissue Wet Weight) in Young Male Rhesus Monkeys Exposed to Aerosols of Manganese Sulfate ( $1.5 \text{ mg Manganese/m}^3$ ) 6 Hours/Day, 5 Days/Week for Up to 65 Days .....      | 216 |
| 3-11. Manganese Concentrations in Brain Tissues of Lactating CD Rats and Offspring Exposed to Aerosols of Manganese Sulfate.....   | 219 |
| 3-12. Manganese Levels in Rat Tissue After Oral Exposure.....  | 221 |
| 3-13. Levels of Manganese in Exposed and Non-Exposed Workers.....  | 234 |
| 3-14. Parameter Values in the Teeguarden et al. (2007c) PBPK Model for Manganese in CD Rats (Nong et al. 2008) Model A .....   | 245 |
| 3-15. Refined Parameter Values in Nong et al. (2008) Model A.....  | 249 |
| 3-16. Parameter Values in Nong et al. (2008) Model B.....  | 251 |
| 3-17. Parameter Values for Manganese Chloride in the Leavens et al. (2007) PBPK Model for Olfactory Transport of Manganese in Rats .....   | 253 |
| 3-18. Parameter Values for Manganese Phosphate in the Leavens et al. (2007) PBPK Model for Olfactory Transport of Manganese in Rats .....  | 254 |
| 3-19. Parameter Values for Describing Blood Concentrations in the Leavens et al. (2007) PBPK Model for Olfactory Transport of Manganese in Rats .....  | 256 |

|  |     |
|--|-----|
| 3-20. Ongoing Studies on Manganese .....   | 321 |
| 4-1. Chemical Identity of Manganese and Compounds .....  | 324 |
| 4-2. Physical and Chemical Properties of Manganese and Compounds .....   | 327 |
| 5-1. Facilities that Produce, Process, or Use Manganese.....   | 332 |
| 5-2. Facilities that Produce, Process, or Use Manganese Compounds .....  | 334 |
| 5-3. Manganese Import/Export Data for 2003–2007 .....  | 338 |
| 6-1. Releases to the Environment from Facilities that Produce, Process, or Use Manganese .....                                       | 344 |
| 6-2. Releases to the Environment from Facilities that Produce, Process, or Use Manganese<br>Compounds .....                          | 346 |
| 6-3. Average Levels of Manganese in Ambient Air .....  | 356 |
| 6-4. Levels of PM <sub>2.5</sub> and PM <sub>10</sub> in Indoor and Outdoor Air in Toronto, Canada and Indianapolis,<br>Indiana..... | 359 |
| 6-5. Manganese Detections and Concentrations in Surface Water and Groundwater in the United<br>States .....                          | 360 |
| 6-6. Mean Concentrations of Manganese for FDA’s Total Diet Study Market Baskets 1991<br>through 1997 .....                           | 363 |
| 6-7. Summary of Typical Human Exposure to Manganese .....  | 365 |
| 6-8. Levels of PM <sub>2.5</sub> in Personal Air Samples Collected in Toronto, Canada and Indianapolis,<br>Indiana.....              | 369 |
| 7-1. Analytical Methods for Determining Manganese in Biological Materials.....   | 383 |
| 7-2. Analytical Methods for Determining Manganese in Environmental Samples .....   | 385 |
| 8-1. Regulations, Advisories, and Guidelines Applicable to Manganese .....   | 393 |

## 1. PUBLIC HEALTH STATEMENT

This public health statement tells you about manganese and the effects of exposure to it.

The Environmental Protection Agency (EPA) identifies the most serious hazardous waste sites in the nation. These sites are then placed on the National Priorities List (NPL) and are targeted for long-term federal clean-up activities. Manganese has been found in at least 869 of the 1,699 current or former NPL sites. Although the total number of NPL sites evaluated for this substance is not known, the possibility exists that the number of sites at which manganese is found may increase in the future as more sites are evaluated. This information is important because these sites may be sources of exposure and exposure to this substance may harm you.

When a substance is released either from a large area, such as an industrial plant, or from a container, such as a drum or bottle, it enters the environment. Such a release does not always lead to exposure. You can be exposed to a substance only when you come in contact with it. You may be exposed by breathing, eating, or drinking the substance, or by skin contact.

If you are exposed to manganese, many factors will determine whether you will be harmed. These factors include the dose (how much), the duration (how long), and how you come in contact with it. You must also consider any other chemicals you are exposed to and your age, sex, diet, family traits, lifestyle, and state of health.

## 1. PUBLIC HEALTH STATEMENT

## 1.1 WHAT IS MANGANESE?

|  |  |
|--|--|
| <b>Description</b>   | Manganese is a naturally occurring substance found in many types of rocks and soil. Pure manganese is a silver-colored metal; however, it does not occur in the environment as a pure metal. Rather, it occurs combined with other substances such as oxygen, sulfur, and chlorine. Manganese is a trace element and is necessary for good health.   |
| <b>Uses</b> <ul style="list-style-type: none"> <li>• <b>Manufacturing</b></li> <br/> <li>• <b>Consumer products</b></li> </ul> | <p>Manganese is used principally in steel production to improve hardness, stiffness, and strength. It is used in carbon steel, stainless steel, high-temperature steel, and tool steel, along with cast iron and superalloys.</p> <p>Manganese occurs naturally in most foods and may be added to food or made available in nutritional supplements. Manganese is also used in a wide variety of other products, including:</p> <ul style="list-style-type: none"> <li>• fireworks</li> <li>• dry-cell batteries</li> <li>• fertilizer</li> <li>• paints</li> <li>• a medical imaging agent</li> <li>• cosmetics</li> </ul> <p>It may also be used as an additive in gasoline to improve the octane rating of the gas.</p> <p>Small amounts of manganese are used in a pharmaceutical product called mangafodipir trisodium (MnDPDP) to improve lesion detection in magnetic resonance imaging of body organs.</p> |

Chapters 4, 5, and 6 have more information on the properties and uses of manganese and how it behaves in the environment.

## 1. PUBLIC HEALTH STATEMENT

## 1.2 WHAT HAPPENS TO MANGANESE WHEN IT ENTERS THE ENVIRONMENT?

|                  |   |
|------------------|---|
| <b>Sources</b>   | Manganese is a normal constituent of air, soil, water, and food. Additional manganese can be found in air, soil, and water after release from the manufacture, use, and disposal of manganese-based products.   |
| <b>Breakdown</b> | <p>As with other elements, manganese cannot break down in the environment. It can only change its form or become attached or separated from particles. The chemical state of manganese and the type of soil determine how fast it moves through the soil and how much is retained in the soil. In water, most of the manganese tends to attach to particles in the water or settle into the sediment.</p> <p>The manganese-containing gasoline additive may degrade in the environment quickly when exposed to sunlight, releasing manganese.</p> |

For more information on manganese in the environment, see Chapter 6.

## 1.3 HOW MIGHT I BE EXPOSED TO MANGANESE?

|  |  |
|--|--|
| <b>Food – primary source of exposure</b> | The primary way you can be exposed to manganese is by eating food or manganese-containing nutritional supplements. Vegetarians who consume foods rich in manganese such as grains, beans and nuts, as well as heavy tea drinkers, may have a higher intake of manganese than the average person.   |
| <b>Workplace air</b>                     | Certain occupations like welding or working in a factory where steel is made may increase your chances of being exposed to high levels of manganese.   |
| <b>Water and soil</b>                    | Because manganese is a natural component of the environment, you are always exposed to low levels of it in water, air, soil, and food. Manganese is routinely contained in groundwater, drinking water and soil at low levels. Drinking water containing manganese or swimming or bathing in water containing manganese may expose you to low levels of this chemical. |
| <b>Air</b>                               | <p>Air also contains low levels of manganese, and breathing air may expose you to it. Releases of manganese into the air occur from:</p> <ul style="list-style-type: none"> <li>• industries using or manufacturing products containing manganese</li> <li>• mining activities</li> <li>• automobile exhaust</li> </ul>  |

See Chapter 6 for more information on how you might be exposed to manganese or its compounds.

## 1. PUBLIC HEALTH STATEMENT

**1.4 HOW CAN MANGANESE ENTER AND LEAVE MY BODY?**

|  |  |
|--|--|
| <p><b>Enter your body</b></p> <ul style="list-style-type: none"> <li>• <b>Inhalation</b></li> <br/> <li>• <b>Ingestion</b></li> <br/> <li>• <b>Dermal contact</b></li> </ul> | <p>When you breathe air containing manganese, a small amount of the manganese will enter your body through your lungs and the remainder can become trapped in your lungs. Some of the manganese in your lungs can also be trapped in mucus which you may cough up and swallow into your stomach.</p> <p>Manganese in food or water may enter your body through the digestive tract to meet your body's needs for normal functioning.</p> <p>Only very small amounts of manganese can enter your skin when you come into contact with liquids containing manganese.</p> |
| <p><b>Leave your body</b></p>  | <p>Once in your body, manganese-containing chemicals can break down into other chemicals. However, manganese is an element that cannot be broken down. Most manganese will leave your body in feces within a few days.</p>   |

For more information on how manganese enters and leaves the body, see Chapter 3.



## 1. PUBLIC HEALTH STATEMENT

**1.5 HOW CAN MANGANESE AFFECT MY HEALTH?**

This section looks at studies concerning potential health effects in human and animal studies.

|  |   |
|--|---|
| <b>General population</b>                        | Manganese is an essential nutrient, and eating a small amount of it each day is important to stay healthy.  |
| <b>Workers</b><br>• <b>Inhalation</b>            | <p>The most common health problems in workers exposed to high levels of manganese involve the nervous system. These health effects include behavioral changes and other nervous system effects, which include movements that may become slow and clumsy. This combination of symptoms when sufficiently severe is referred to as “manganism.” Other less severe nervous system effects such as slowed hand movements have been observed in some workers exposed to lower concentrations in the work place.</p> <p>The inhalation of a large quantity of dust or fumes containing manganese may cause irritation of the lungs which could lead to pneumonia.</p> <p>Loss of sex drive and sperm damage has also been observed in men exposed to high levels of manganese in workplace air.</p> <p>The manganese concentrations that cause effects such as slowed hand movements in some workers are approximately twenty thousand times higher than the concentrations normally found in the environment. Manganism has been found in some workers exposed to manganese concentrations about a million times higher than normal air concentrations of manganese.</p> |
| <b>Laboratory animals</b><br>• <b>Inhalation</b> | Respiratory effects, similar to those observed in workers, have been observed in laboratory monkeys exposed to high levels of manganese.  |
| <b>Laboratory animals</b><br>• <b>Oral</b>       | <p>Manganese has been shown to cross the blood-brain barrier and a limited amount of manganese is also able to cross the placenta during pregnancy, enabling it to reach a developing fetus.</p> <p>Nervous system disturbances have been observed in animals after very high oral doses of manganese, including changes in behavior.</p> <p>Sperm damage and adverse changes in male reproductive performance were observed in laboratory animals fed high levels of manganese. Impairments in fertility were observed in female rodents provided with oral manganese before they became pregnant.</p> <p>Illnesses involving the kidneys and urinary tract have been observed in laboratory rats fed very high levels of manganese. These illnesses included inflammation of the kidneys and kidney stone formation.</p>  |
| <b>Cancer</b>                                    | The EPA concluded that existing scientific information cannot determine whether or not excess manganese can cause cancer.   |

## 1. PUBLIC HEALTH STATEMENT

Further information on the health effects of manganese in humans and animals can be found in Chapters 2 and 3.

**1.6 HOW CAN MANGANESE AFFECT CHILDREN?**

This section discusses potential health effects in humans from exposures during the period from conception to maturity at 18 years of age.

|                            |  |
|----------------------------|--|
| <b>Effects in children</b> | <p>Studies in children have suggested that extremely high levels of manganese exposure may produce undesirable effects on brain development, including changes in behavior and decreases in the ability to learn and remember. In some cases, these same manganese exposure levels have been suspected of causing severe symptoms of manganism disease (including difficulty with speech and walking). We do not know for certain that these changes were caused by manganese alone. We do not know if these changes are temporary or permanent. We do not know whether children are more sensitive than adults to the effects of manganese, but there is some indication from experiments in laboratory animals that they may be.</p> |
| <b>Birth defects</b>       | <p>Studies of manganese workers have not found increases in birth defects or low birth weight in their children.</p> <p>No birth defects were observed in animals exposed to manganese</p> <p>In one human study where people were exposed to very high levels of manganese from drinking water, infants less than 1 year of age died at an unusually high rate. It is not clear, however, whether these deaths were attributable to the manganese level of the drinking water. The manganese toxicity may have involved exposures to the infant that occurred both before (through the mother) and after they were born.</p>  |

## 1. PUBLIC HEALTH STATEMENT

**1.7 HOW CAN FAMILIES REDUCE THE RISK OF EXPOSURE TO MANGANESE?**

|  |  |
|--|--|
| <b>Avoid inhalation of manganese at work</b>                                       | High levels of airborne manganese are observed in certain occupational settings such as steel factories or welding areas. You should take precautions to prevent inhalation of manganese by wearing an appropriate mask to limit the amount of manganese you breathe.  |
| <b>Avoid wearing manganese dust-contaminated work clothing in your home or car</b> | Workers exposed to high levels of airborne manganese in certain occupational settings may accumulate manganese dust on their work clothes. Manganese-contaminated work clothing should be removed before getting into your car or entering your home to help reduce the exposure hazard for yourself and your family.  |
| <b>Avoid inhalation of welding fumes at home</b>                                   | If you weld objects around your home, do so in a well-ventilated area and use an appropriate mask to decrease your risk of inhaling manganese-containing fumes. Children should be kept away from welding fumes.   |
| <b>Diet</b>  | Children are not likely to be exposed to harmful amounts of manganese in the diet. However, higher-than-usual amounts of manganese may be absorbed if their diet is low in iron. It is important to provide your child with a well-balanced diet.  |
| <b>Water</b>   | While tap and bottled water generally contain safe levels of manganese, well water may sometimes be contaminated with sufficiently high levels of manganese to create a potential health hazard. If drinking water is obtained from a well water source, it may be wise to have the water checked for manganese to ensure the level is below the current guideline level established by the EPA. |
| <b>Smoking</b>   | Manganese is a minor constituent of tobacco smoke. Avoiding tobacco smoke may reduce your family's exposure to manganese.  |

## 1. PUBLIC HEALTH STATEMENT

**1.8 IS THERE A MEDICAL TEST TO DETERMINE WHETHER I HAVE BEEN EXPOSED TO MANGANESE?**

|                           |   |
|---------------------------|---|
| <b>Detecting exposure</b> | <p>Several tests are available to measure manganese in blood, urine, hair, or feces. Because manganese is normally present in our body, some is always found in tissues or fluids.</p> <p>Normal ranges of manganese levels are about 4–15 µg/L in blood, 1–8 µg/L in urine, and 0.4–0.85 µg/L in serum (the fluid portion of the blood).</p>   |
| <b>Measuring exposure</b> | <p>Because excess manganese is usually removed from the body within a few days, past exposures are difficult to measure with common laboratory tests.</p> <p>A medical test known as magnetic resonance imaging, or MRI, can detect the presence of increased amounts of manganese in the brain. However, this type of test is qualitative, and has not been shown to reliably reflect or predict toxicologically meaningful exposures.</p> |

Information about tests for detecting manganese in the body is given in Chapters 3 and 7.

**1.9 WHAT RECOMMENDATIONS HAS THE FEDERAL GOVERNMENT MADE TO PROTECT HUMAN HEALTH?**

The federal government develops regulations and recommendations to protect public health. Regulations *can* be enforced by law. The EPA, the Occupational Safety and Health Administration (OSHA), and the Food and Drug Administration (FDA) are some federal agencies that develop regulations for toxic substances. Recommendations provide valuable guidelines to protect public health, but *cannot* be enforced by law. The Agency for Toxic Substances and Disease Registry (ATSDR) and the National Institute for Occupational Safety and Health (NIOSH) are two federal organizations that develop recommendations for toxic substances.

Regulations and recommendations can be expressed as “not-to-exceed” levels, that is, levels of a toxic substance in air, water, soil, or food that do not exceed a critical value that is usually based on levels that affect animals; they are then adjusted to levels that will help protect humans. Sometimes these not-to-exceed levels differ among federal organizations because they used different exposure times (an 8-hour workday or a 24-hour day), different animal studies, or other factors.

## 1. PUBLIC HEALTH STATEMENT

Recommendations and regulations are also updated periodically as more information becomes available. For the most current information, check with the federal agency or organization that provides it. Some regulations and recommendations for manganese include the following:

|                       |  |
|-----------------------|--|
| <b>Drinking water</b> | The EPA has established that exposure to manganese in drinking water at concentrations of 1 mg/L for 1 or 10 days is not expected to cause any adverse effects in a child.<br><br>The EPA has established that lifetime exposure to 0.3 mg/L manganese is not expected to cause any adverse effects. |
| <b>Bottled water</b>  | The FDA has established that the manganese concentration in bottled drinking water should not exceed 0.05 mg/L.  |
| <b>Workplace air</b>  | OSHA set a legal limit of 5 mg/m <sup>3</sup> manganese in air averaged over an 8-hour work day.   |

For more information on regulations and advisories, see Chapter 8.

**1.10 WHERE CAN I GET MORE INFORMATION?**

If you have any more questions or concerns, please contact your community or state health or environmental quality department, or contact ATSDR at the address and phone number below.

ATSDR can also tell you the location of occupational and environmental health clinics. These clinics specialize in recognizing, evaluating, and treating illnesses that result from exposure to hazardous substances.

Toxicological profiles are also available on-line at [www.atsdr.cdc.gov](http://www.atsdr.cdc.gov) and on CD-ROM. You may request a copy of the ATSDR ToxProfiles™ CD-ROM by calling the toll-free information and technical assistance number at 1-800-CDCINFO (1-800-232-4636), by e-mail at [cdcinfo@cdc.gov](mailto:cdcinfo@cdc.gov), or by writing to:

Agency for Toxic Substances and Disease Registry  
 Division of Toxicology and Environmental Medicine  
 1600 Clifton Road NE  
 Mailstop F-32  
 Atlanta, GA 30333  
 Fax: 1-770-488-4178

## 1. PUBLIC HEALTH STATEMENT

Organizations for-profit may request copies of final Toxicological Profiles from the following:

National Technical Information Service (NTIS)  
5285 Port Royal Road  
Springfield, VA 22161  
Phone: 1-800-553-6847 or 1-703-605-6000  
Web site: <http://www.ntis.gov/>

## 2. RELEVANCE TO PUBLIC HEALTH

### 2.1 BACKGROUND AND ENVIRONMENTAL EXPOSURES TO MANGANESE IN THE UNITED STATES

Manganese is a naturally occurring element and an essential nutrient. Comprising approximately 0.1% of the earth's crust, it is the twelfth most abundant element and the fifth most abundant metal. Manganese does not exist in nature as an elemental form, but is found mainly as oxides, carbonates, and silicates in over 100 minerals with pyrolusite (manganese dioxide) as the most common naturally-occurring form. As an essential nutrient, several enzyme systems have been reported to interact with or depend on manganese for their catalytic or regulatory function. As such, manganese is required for the formation of healthy cartilage and bone and the urea cycle; it aids in the maintenance of mitochondria and the production of glucose. It also plays a key role in wound-healing.

Manganese exists in both inorganic and organic forms. An essential ingredient in steel, inorganic manganese is also used in the production of dry-cell batteries, glass and fireworks, in chemical manufacturing, in the leather and textile industries and as a fertilizer. The inorganic pigment known as manganese violet (manganese ammonium pyrophosphate complex) has nearly ubiquitous use in cosmetics and is also found in certain paints. Organic forms of manganese are used as fungicides, fuel-oil additives, smoke inhibitors, an anti-knock additive in gasoline, and a medical imaging agent.

The erosion of crustal rocks to create soil results in average manganese soil concentrations in the United States of 40–900 mg/kg. Its presence in soil results in vegetable and animal foods reliably containing varying amounts of the mineral. As an essential nutrient, manganese is added to certain foods and nutritional supplements. Vegetarians often have diets richer in manganese than those who select omnivorous diets.

The most important source of manganese in the atmosphere results from the air erosion of dusts or soils. The mean concentration of manganese in ambient air in the United States is 0.02  $\mu\text{g}/\text{m}^3$ ; however, ambient levels near industrial sources can range from 0.22 to 0.3  $\mu\text{g}/\text{m}^3$ . Manganese is released into waterways mainly through the erosion of rocks and soils, mining activities, and industrial waste, or by the leaching of manganese from anthropogenic materials discarded in landfills or soil, such as dry-cell batteries. Surface waters in the United States contain a median manganese level of 16  $\mu\text{g}/\text{L}$ , with 99<sup>th</sup> percentile concentrations of 400–800  $\mu\text{g}/\text{L}$ . Groundwater in the United States contains median

## 2. RELEVANCE TO PUBLIC HEALTH

manganese levels of 5 to 150 µg/L, with the 99<sup>th</sup> percentile at 2,900 or 5,600 µg/L in rural or urban areas, respectively.

The general population is exposed to manganese through consumption of food and water, inhalation of air, and dermal contact with air, water, soil, and consumer products that contain manganese. The primary source of manganese intake is through diet. The Food and Nutrition Board (FNB) of the Institute of Medicine (IOM) has set adequate intake (AI) levels for manganese for humans. These levels are presented in Table 2-1.

The inhalation of air contaminated with particulate matter containing manganese is the primary source of excess manganese exposure for the general population in the United States. Populations living in close proximity to mining activities and industries using manganese may be exposed by inhalation to high levels of manganese in dust. Workers in these industries are especially vulnerable to exposure to manganese dust. Manganese concentrations in soil may be elevated when the soil is in close proximity to a mining source or industry using manganese and may therefore pose a risk of excess exposure to children who ingest contaminated soil. Manganese is ubiquitous in drinking water in the United States. Although certain water sources in the United States are contaminated with excess manganese, there is little risk of excessive exposure to manganese through ingestion of fish or shellfish emanating from contaminated waters, unless the manganese levels in the fish are extremely high and/or the fish are eaten as subsistence. Although many forms of manganese are water-soluble, there is little evidence that dermal contact with manganese results in significant absorption through the skin. Thus, dermal contact with manganese is not generally viewed as an important source of exposure to the population at large.

Excess exposure to manganese may be revealed by tests to detect heightened levels in body fluids as well as in hair samples. Normal ranges of manganese levels in body fluids are 4–15 µg/L in blood, 1–8 µg/L in urine, and 0.4–0.85 µg/L in serum. Excess manganese in the body characteristically accumulates in the brain region known as the basal ganglia. This accumulation can be revealed by magnetic resonance imaging (MRI) as a distinctive symmetrical high-signal lesion in the globus pallidus region of the basal ganglia on T1- but not T2-weighted MRI.



## 2. RELEVANCE TO PUBLIC HEALTH

**Table 2-1. Adequate Intake (AI) for Manganese**

| Life stage  | Age                | Males (mg/day) | Females (mg/day) |
|-------------|--------------------|----------------|------------------|
| Infants     | 0–6 Months         | 0.003          | 0.003            |
| Infants     | 7–12 Months        | 0.6            | 0.6              |
| Children    | 1–3 Years          | 1.2            | 1.2              |
| Children    | 4–8 Years          | 1.5            | 1.5              |
| Children    | 9–13 Years         | 1.9            | 1.6              |
| Adolescents | 14–18 Years        | 2.2            | 1.6              |
| Adults      | 19 Years and older | 2.3            | 1.8              |
| Pregnancy   | All ages           | —              | 2.0              |
| Lactation   | All ages           | —              | 2.6              |

Source: FNB/IOM 2001

## 2. RELEVANCE TO PUBLIC HEALTH

**2.2 SUMMARY OF HEALTH EFFECTS**

Although low levels of manganese intake are necessary for human health, exposure to high manganese levels are toxic. Reports of adverse effects resulting from manganese exposure in humans are associated primarily with inhalation in occupational settings. Inhaled manganese is often transported directly to the brain before it is metabolized by the liver. The symptoms of manganese toxicity may appear slowly over months and years. Manganese toxicity can result in a permanent neurological disorder known as manganism with symptoms that include tremors, difficulty walking, and facial muscle spasms. These symptoms are often preceded by other lesser symptoms, including irritability, aggressiveness, and hallucinations. Some studies suggest that manganese inhalation can also result in adverse cognitive effects, including difficulty with concentration and memory problems. Although the workplace is the most common source of excess inhalation of manganese, frequent inhalation of fumes from welding activities in the home can produce a risk of excess manganese exposure leading to neurological symptoms. Environmental exposures to airborne manganese have been associated with similar preclinical neurological effects and mood effects as are seen in occupational studies. Acute or intermediate exposure to excess manganese also affects the respiratory system. Inhalation exposure to high concentrations of manganese dusts (specifically manganese dioxide [MnO<sub>2</sub>] and manganese tetroxide [Mn<sub>3</sub>O<sub>4</sub>]) can cause an inflammatory response in the lung, which, over time, can result in impaired lung function. Lung toxicity is manifested as an increased susceptibility to infections such as bronchitis and can result in manganic pneumonia. Pneumonia has also been observed following acute inhalation exposures to particulates containing other metals. Thus, this effect might be characteristic of inhalable particulate matter and might not depend solely on the manganese content of the particle.

Many reports indicate that oral exposure to manganese, especially from contaminated water sources, can produce significant health effects. These effects have been most prominently observed in children and are similar to those observed from inhalation exposure. An actual threshold level at which manganese exposure produces neurological effects in humans has not been established. However, children consuming the same concentration of manganese in water as adults are ultimately exposed to a higher mg/kg-body weight ratio of manganese than adults (as a consequence of the lower body weight of children as well as their higher daily consumption volume and greater retention of manganese). Children are also potentially more sensitive to manganese toxicity than adults. A study conducted in infant monkeys suggests that soy-based infant formula, which contains a naturally higher concentration of manganese than human or cow's milk, may produce mild effects on neurological development, although such effects have not been documented in humans. While many of the studies reporting oral effects of

## 2. RELEVANCE TO PUBLIC HEALTH

excess manganese have limitations that preclude firm conclusions about the potential for adverse effects, these studies collectively suggest that ingestion of water and/or foodstuffs containing increased concentrations of manganese may result in adverse neurological effects.

There is indirect evidence that reproductive outcomes might be affected (decreased libido, impotence, and sexual dysfunction have been observed in manganese-exposed men). The available studies on the effect that manganese has on fertility (as measured by birthrate) is inconclusive. Two studies in men occupationally exposed to manganese show adverse effects on reproductive parameters: one found increased sexual dysfunction and the other found reduced sperm quality, but neither measured birthrate in wives of affected workers. Impaired sexual function in men may be one of the earliest clinical manifestations of manganese toxicity, but no dose-response information is currently available, so it is not possible to define a threshold for this effect. There is a lack of information regarding effects in women since most data are derived from studies of male workers. Developmental data in humans exposed to manganese by inhalation are limited and consist mostly of reports of adverse pulmonary effects from inhaling airborne manganese dust and adverse neurological effects in offspring following ingestion exposure. Animal studies indicate that manganese is a developmental toxin when administered orally and intravenously, but inhalation data concerning these effects are scarce and not definitive. Some studies in children suggest that routine exposures to high levels of manganese from contaminated drinking water may ultimately impair intellectual performance and behavior.

The few available inhalation and oral studies in humans and animals indicate that inorganic manganese exposure does not cause significant injury to the heart, stomach, blood, muscle, bone, liver, kidney, skin, or eyes. However, if manganese is in the (VII) oxidation state (as in potassium permanganate), then ingestion may lead to severe corrosion at the point of contact. Studies in pigs have revealed a potential for adverse coronary effects from excess manganese exposure.

There is no evidence that manganese causes cancer in humans. Although no firm conclusions can be drawn from the mixed results in animal studies, there are little data to suggest that inorganic manganese is carcinogenic. The EPA has provided manganese with a weight-of-evidence classification D—not classifiable as to human carcinogenicity.

It should be noted that individuals with cirrhosis of the liver, as well as children with a congenital venous anomaly known as a portosystemic shunt, may be at heightened risk of health deficits from exposure to dietary and environmental sources of manganese. Manganese is ordinarily eliminated from the body

## 2. RELEVANCE TO PUBLIC HEALTH

through bile, but cirrhosis and portosystemic shunts impair the normal functioning of the liver and thus limit the ability of the body to excrete manganese, which then can accumulate in the blood and, eventually, the brain.

A more detailed discussion of the critical targets of manganese toxicity (i.e., the nervous system, respiratory system, reproductive system, and development), follows.

**Neurological Effects.** There is clear evidence from studies of humans exposed to manganese dusts in mines and factories that inhalation of high levels of manganese can lead to a series of serious and ultimately disabling neurological effects in humans. This disease, termed manganism, typically begins with feelings of weakness and lethargy. As the disease progresses, a number of other neurological signs may become manifest. Although not all individuals develop identical signs, the most common are a slow and clumsy gait, speech disturbances, a masklike face, and tremors. The neurological symptoms may improve when exposure ceases; however, in most cases, the symptoms are found to persist for many years post-exposure. In addition, a syndrome of psychological disturbances (hallucination, psychosis) frequently emerges, although such symptoms are sometimes absent. As the disease progresses, patients develop severe muscle tension and rigidity and may be completely and permanently disabled. Workplace inhalation exposure levels producing overt symptoms of manganism have been on the order of 2–22 mg manganese/m<sup>3</sup>. Subclinical neurological effects have been observed in several occupational studies. These effects include decreased performance on neurobehavioral tests; significantly poorer eye-hand coordination, hand steadiness, and reaction time; poorer postural stability; and lower levels of cognitive flexibility. Manganese air concentrations producing these effects in chronically exposed workers range from about 0.07 to 0.97 mg manganese/m<sup>3</sup>. In addition, a study on environmental manganese sources indicated that both men and women were adversely affected by non-occupational exposure to manganese as evidenced by performance on neurobehavioral tests and increased neuropsychiatric disturbances. In these studies, a blood manganese level-age interaction was observed, with the poorest performance occurring among those older than 50 years who had the highest blood manganese levels. While manganese neurotoxicity has clinical similarities to Parkinson's disease, it can be clinically distinguished from Parkinson's. Manganism patients present a hypokinesia and tremor that is different from Parkinson's patients. In addition, manganism patients sometimes have psychiatric disturbances early in the disease, a propensity to fall backward when pushed, less frequent resting tremor, more frequent dystonia, a "cock-walk", and a failure to respond to dopaminomimetics.

## 2. RELEVANCE TO PUBLIC HEALTH

While there is limited evidence that oral exposure to manganese leads to neurological effects similar to those reported for inhalation exposure, an accumulating body of evidence suggests that when children are exposed to excess levels of manganese in drinking water ( $\geq 0.2$  mg/L), subtle learning and behavioral deficits may follow (see developmental effects below). Other studies have revealed cases of apparent manganism in both children and adults where exposures to high levels of manganese in drinking water were implicated as the probable cause. The symptoms in these cases are similar to those of individuals inhaling high levels of the mineral.

**Respiratory Effects.** Inhalation exposure to manganese dusts often leads to an inflammatory response in the lungs of both humans and animals. This generally leads to an increased incidence of cough and bronchitis and can lead to mild-to-moderate injury of lung tissue along with minor decreases in lung function. In addition, susceptibility to infectious lung disease may be increased, leading to increased pneumonitis and pneumonia in some manganese-exposed worker populations. These effects have been reported primarily in workers exposed to fairly high concentrations of manganese dusts in the workplace, although there are some data that indicate that, in populations living and attending school near ferromanganese factories, there was an increased prevalence of respiratory effects. The risk of lung injury in people exposed to the levels of manganese typically found in the general environment is expected to be quite low. However, exposure to manganese-containing dusts from factories, mining operations, automobile exhaust, or other sources may be of concern. It should be noted that these effects on the lung are not unique to manganese-containing dusts but are produced by a variety of inhalable particulate matter. On this basis, it seems most appropriate to evaluate the risk of inflammatory effects on the lung in terms of total suspended particulate matter (TSP) or particulate matter  $<10$   $\mu\text{m}$  in diameter ( $\text{PM}_{10}$ ), as well as the concentration of manganese in the air. Studies involving controlled inhalation exposures in humans or animals to methylcyclopentadienyl manganese tricarbonyl (MMT), a gasoline additive that improves combustion efficiency, are not available because the compound breaks down readily in light to form inorganic manganese compounds. Rats exposed to high concentrations of car exhaust containing oxidation products from MMT-containing fuel exhibited labored breathing.

**Reproductive Effects.** Impotence and loss of libido are common symptoms in male workers afflicted with clinically identifiable signs of manganism. These symptoms could lead to reduced reproductive success in men. Impaired fertility (measured as a decreased number of children/married couple) has been observed in male workers exposed for 1–19 years to manganese dust ( $0.97$   $\text{mg}/\text{m}^3$ ) at levels that did not produce frank manganism. This suggests that impaired sexual function in men may be one of the earliest clinical manifestations of manganese toxicity, but no dose-response information is

## 2. RELEVANCE TO PUBLIC HEALTH

available; therefore, it is not possible to define a threshold for this effect. Evidence obtained in laboratory mammals indicates that exposure to high levels of manganese may adversely effect sperm quality, produce decreased testicular weights, and impair development of the male reproductive tract.

No direct effect of manganese toxicity has been observed on fertility in women. Although many studies in laboratory mammals have attempted to detect effects of manganese on female fertility, only one study demonstrated the possibility that excess manganese exposure outside of pregnancy may impair future fertility (decreased number of offspring).

**Developmental Effects.** There is evidence to suggest that children exposed to high levels of manganese in drinking water may develop a variety of adverse developmental effects, particularly relevant to their behaviors and ability to learn and remember. Some studies suggest that children exposed to particularly high levels of manganese over a long period of time (months or years) will eventually develop one or more symptoms, including diminished memory, attention deficit, aggressiveness, and/or hyperactivity. However, it is not clear from any of these studies whether other factors, perhaps environmental or genetic, are responsible for these changes in the presence of manganese, or whether manganese alone can produce these effects.

A potentially serious developmental effect of manganese was suggested by the results of a study where high infant mortality in a Bangladesh community was reported in conjunction with the presence of a local drinking water supply containing high levels of manganese (concentration up to 8.31 mg/L). Infants exposed to levels of manganese equal to or greater than those recommended by the World Health Organization (WHO) were at the highest risk of mortality prior to 1 year of age. The nature of this epidemiological study, with nutritional deficits in the population anticipated but not documented, prevents a determination that manganese alone was responsible for the high rate of infant mortality.

Developmental studies involving the use of laboratory animals have detected subtle changes in growth; (e.g., diminished body weight, in animals provided with relatively high doses of manganese). These changes have been observed both when the animals were exposed while *in utero* or postpartum when the animals have already been born.

## 2. RELEVANCE TO PUBLIC HEALTH

**2.3 MINIMAL RISK LEVELS (MRLs)**

Estimates of exposure levels posing minimal risk to humans (MRLs) have been made for manganese. An MRL is defined as an estimate of daily human exposure to a substance that is likely to be without an appreciable risk of adverse effects (noncarcinogenic) over a specified duration of exposure. MRLs are derived when reliable and sufficient data exist to identify the target organ(s) of effect or the most sensitive health effect(s) for a specific duration within a given route of exposure. MRLs are based on noncancerous health effects only and do not consider carcinogenic effects. MRLs can be derived for acute, intermediate, and chronic duration exposures for inhalation and oral routes. Appropriate methodology does not exist to develop MRLs for dermal exposure.

Although methods have been established to derive these levels (Barnes and Dourson 1988; EPA 1990), uncertainties are associated with these techniques. Furthermore, ATSDR acknowledges additional uncertainties inherent in the application of the procedures to derive less than lifetime MRLs. As an example, acute inhalation MRLs may not be protective for health effects that are delayed in development or are acquired following repeated acute insults, such as hypersensitivity reactions, asthma, or chronic bronchitis. As these kinds of health effects data become available and methods to assess levels of significant human exposure improve, these MRLs will be revised.

A User's Guide has been provided at the end of this profile (see Appendix B). This guide should aid in the interpretation of the tables and figures for Levels of Significant Exposure and the MRLs.

**Inhalation MRLs for Inorganic Manganese**

*Acute and Intermediate Inhalation Exposure.* MRL values were not derived for acute- or intermediate-duration inhalation exposures to manganese. The available data on the toxicity of inhaled manganese were considered inadequate for derivation of acute- or intermediate-duration inhalation MRLs. Data are lacking on whether exposure to inhaled manganese across these durations has any significant adverse effects on numerous end points including reports on developmental and reproductive effects.

Reports of human exposure at acute and intermediate durations (i.e., 15–364 days) indicate adverse respiratory and neurological effects, but these reports consist of anecdotal case studies and lack quantitative exposure values.

## 2. RELEVANCE TO PUBLIC HEALTH

A few animal studies for these durations also evaluated respiratory effects in rodents and monkeys and reported no-observed-adverse-effect levels (NOAELs). Inhalation of particulate manganese compounds such as manganese dioxide or manganese tetroxide leads to an inflammatory response in the lungs of animals, although inhalation of  $\text{MnCl}_2$  did not cause lung inflammation in rabbits (Camner et al. 1985). Several acute- and intermediate-duration studies in animals report various signs of lung inflammation following periods ranging from 1 day to 10 months at manganese concentrations ranging from 0.7 to 69  $\text{mg}/\text{m}^3$  (Bergstrom 1977; Camner et al. 1985; Shiotsuka 1984; Suzuki et al. 1978; Ulrich et al. 1979a, 1979b). Bergstrom (1977) and Ulrich et al. (1979a, 1979b) determined NOAELs, which are reported in the levels of significant exposure (LSE) table and figure. Increased susceptibility to lung infection by bacterial pathogens following inhalation of manganese dusts has been noted in acute animal studies (Maigetter et al. 1976). Conversely, Lloyd Davies (1946) reported no increase in the susceptibility of manganese-treated mice to pneumococci or streptococci.

More recently, reversible inflammation (pleocellular inflammatory infiltrates and fibrinonecrotic debris) in the nasal respiratory epithelium (but not the olfactory epithelium) was observed in young adult male Cr1:CD(SD)BR rats following 13 weeks of inhalation exposure to 0.5  $\text{mg}/\text{m}^3$  as manganese sulfate, but not in rats exposed to 0.1  $\text{mg}/\text{m}^3$  as manganese sulfate or manganese phosphate (hureaulite) (Dorman et al. 2004b). The lesions were not apparent in groups of rats assessed 45 days after the end of exposure, indicating their transient nature. In studies with young male rhesus monkeys exposed to 0, 0.06, 0.3, or 1.5  $\text{mg}/\text{m}^3$  as manganese sulfate 6 hours/day, 5 days/week for 65 days, no nasal histological effects were found in exposed monkeys, but the high exposure level induced lesions in the lower respiratory tract (mild subacute bronchiolitis, alveolar duct inflammation, and proliferation of bronchus-associated lymphoid tissue) (Dorman et al. 2005b). The lower airway lesions from intermediate-duration exposure appear to have been transient, because they were not found in monkeys assessed 45 days after the end of exposure (Dorman et al. 2005b). These findings in rats and monkeys are consistent with the understanding that inflammation of respiratory tissues from high-level exposure to inhaled manganese particulates is likely a consequence of the inhaled particulate matter.

Bredow et al. (2007) reported that nose-only inhalation exposure to 2  $\text{mg}/\text{m}^3$  as manganese chloride aerosols 6 hours/day for 5 consecutive days did not cause lung lesions in female GVB/N mice, but induced a 2-fold increase in pulmonary levels of mRNA for vascular endothelial growth factor (VGEF), a regulator of proliferation, migration, and formation of new capillaries. Elevated levels of VGEF have been associated with respiratory diseases, but current understanding is inadequate to understand if this pulmonary gene expression response to manganese is adverse or benign.



## 2. RELEVANCE TO PUBLIC HEALTH

There are limited evaluations of neurological end points in animals following intermediate-duration inhalation exposure to manganese. Neurological effects comparable to those observed in humans have been reported in monkeys exposed to manganese by parenteral routes (intravenous) for intermediate duration (Newland and Weiss 1992), but no reports of the application of sensitive neurobehavioral test batteries to animals following acute or intermediate-duration inhalation exposure to inorganic manganese were located.

In monkeys exposed to manganese oxide aerosol concentrations as high as 1.1 mg manganese/m<sup>3</sup> 24 hours/day for 9 months, no exposure-related effects on limb tremor or electromyograms were observed, even though blood manganese levels were 5-fold higher in exposed compared with control monkeys (Ulrich et al. 1979a, 1979b, 1979c). No gross signs of neurological impairment were observed in rats exposed by the same protocol to manganese oxide aerosol concentrations as high as 1.1 mg manganese/m<sup>3</sup> (Ulrich et al. 1979a, 1979b, 1979c).

More recent studies of monkeys exposed to concentrations up to 0, 0.06, 0.3, or 1.5 mg manganese/m<sup>3</sup> as manganese sulfate 6 hours/day for 65 days reported: (1) no obvious signs of gross toxicity in the exposed monkeys; (2) about 2-fold higher manganese concentrations in most brain regions at 1.5 mg manganese/m<sup>3</sup>, except for the globus pallidus which showed manganese concentrations 6-fold greater than control concentrations; and (3) a spectrum of exposure-related changes in biochemical markers of neurotoxicity in various regions of the exposed monkeys, compared with control monkeys (Dorman et al. 2006a, 2006b; Erikson et al. 2007). No published accounts of the application of sensitive neurobehavioral test batteries to these animals are available and there are no studies in monkeys reporting NOAELs and lowest-observed-adverse-effect level (LOAELs) for neurological effects following chronic-duration exposure.

Increased locomotor activity has been observed in Sprague-Dawley rats exposed for 90 days (6 hours/day, 5 days/week) to a manganese phosphate/manganese sulfate mixture at concentrations  $\geq 0.03$  mg manganese/m<sup>3</sup> (Salehi et al. 2003) and to manganese sulfate at concentrations  $\geq 0.009$  mg manganese/m<sup>3</sup> (Tapin et al. 2006), but this effect was not observed with exposure to hureaulite (manganese phosphate) at aerosol concentrations as high as 1 mg manganese/m<sup>3</sup> (Normandin et al. 2002). Significant neuronal cell loss in the globus pallidus and caudate putamen was also observed in Sprague-Dawley rats exposed for 90 day (6 hours/day, 5 days/week) to the manganese phosphate/manganese sulfate mixture at an aerosol

## 2. RELEVANCE TO PUBLIC HEALTH

concentration of 3 mg manganese/m<sup>3</sup>; these changes, however, were not accompanied with signs of tremor as assessed with electromyographic techniques (Salehi et al. 2006).

MRL values for acute or intermediate durations based on animal studies were not derived, because an MRL based on animal data would be lower than the proposed chronic-duration inhalation MRL that is based on effects observed in humans. It is uncertain if this is due to species differences in susceptibility to the neurotoxic properties of inhaled manganese or to the testing of humans with sensitive neurobehavioral tests that have not been applied to animals following inhalation exposures to manganese.

- An MRL of 0.0003 mg manganese/m<sup>3</sup> (manganese in respirable dust; 0.3 µg manganese/m<sup>3</sup>) has been derived for chronic inhalation exposure (365 days or more) to manganese.

The study chosen to derive the MRL is from an investigation of an occupational cohort involving 92 male workers in a dry alkaline battery plant (Roels et al. 1992). They and the 101 age- and area-matched controls (with no industrial exposure to manganese) were observed for performance on a battery of neurobehavioral tests. Manganese workers were exposed for an average (geometric mean) of 5.3 years (range: 0.2–17.7 years) to a respirable dust concentration of 215 µg manganese/m<sup>3</sup> and a total dust concentration of 948 µg manganese/m<sup>3</sup>. Manganese concentrations were measured with personal samplers, with respirable dust being <5 microns in diameter. The authors noted that plant exposure conditions had not changed considerably in the last 15 years, suggesting that past exposures were consistent with those measured at the time of the study. Performance in measured neurobehavioral tests, especially on measures of simple reaction time, eye-hand coordination, and hand steadiness, was significantly worse in manganese-exposed workers than in the comparison group.

Manganese-exposed workers performed significantly worse than the controls on the neurobehavioral tests, with particular differences in simple reaction time, eye-hand coordination, and hand steadiness. Dr. Harry Roels provided the data on the manganese-exposed group evaluated in this study. These data included individual exposure levels and whether the individual had an abnormal performance in the neurobehavioral tests (scores below the 5<sup>th</sup> percentile score of the control group). Percent precision score in the eye-hand coordination test was the most sensitive end point among the end points showing statistically significantly elevated incidences of abnormal scores and was selected as the basis of the MRL. Average exposure concentration for each worker was calculated by dividing the individual lifetime integrated respirable concentration (LIRD; calculated by Dr. Roels from occupational histories and measurements of workplace air manganese concentrations) by the individual's total number of years working in the factory. Individuals were grouped into eight exposed groups and the control group, and

## 2. RELEVANCE TO PUBLIC HEALTH

the average of the range in each group was used in benchmark modeling of the incidence data for number of workers with abnormal percent precision eye-hand coordination scores (see Table A-1 in Appendix A).

Available dichotomous models in the EPA Benchmark Dose Software (version 1.4.1c) were fit to the incidence data for abnormal eye-hand coordination scores in workers exposed to respirable manganese (Roels et al. 1992, Table A-1). Results from the modeling are shown in Table A-2 in Appendix A. Based on the chi-square and Akaike Information Criterion (AIC) measures of fit, all of the models provided adequate and comparable fits to the data (the quantal linear and Weibull models had the same parameter values). The model with the lowest AIC, the logistic model, was selected as the best fitting model, and the  $BMCL_{10}$  from the logistic model,  $142 \mu\text{g respirable manganese}/\text{m}^3$ , was selected as the point of departure for the chronic inhalation MRL. An alternative approach to selecting a point of departure (averaging  $BMCL_{10}$  values across all models in Table A-2) arrived at a similar point of departure of  $105 \mu\text{g respirable manganese}/\text{m}^3$ , which would yield an identical MRL value.

The MRL of  $0.3 \mu\text{g manganese}/\text{m}^3$  was derived by adjusting the point of departure to a continuous exposure basis ( $142 \times 5/7 \times 8/24$ ) and dividing by an uncertainty factor of 100:

- 10 for uncertainty about human variability including possibly enhanced susceptibility of the elderly, infants, and children; individuals with chronic liver disease or diminished hepatobiliary function; and females and individuals with iron deficiency; and
- 10 for limitations/uncertainties in the database including the lack of epidemiological data for humans chronically exposed to soluble forms of manganese and the concern that the general population may be exposed to more soluble forms of manganese than most of the manganese-exposed workers in the principal and supporting studies and the uncertainty that a factor of 10 for human variability will provide enough protection for manganese effects on brain development in children. In addition, data on developmental toxicity for this route and duration of exposure are lacking. There is limited information on reproductive effects in females (one study in rat dams) and reported effects on male reproductive organs have not been clearly associated with decreased reproductive function. Though it is clear that the neurological system is the target organ for effects from chronic-duration inhalation exposure to manganese, data are lacking to fully characterize the potential risk for all organ systems from chronic inhalation exposure.

Neurological effects from repeated inhalation exposure to manganese are well recognized as effects of high concern based on case reports and epidemiological studies of groups of occupationally exposed people and results from animal inhalation studies. A number of epidemiological studies have used batteries of neurobehavioral tests of neuromotor, cognition, and mood states to study the psychological or neurological effects of exposure to low levels of manganese in the workplace (Bast-Pettersen et al. 2004; Beuter et al. 1999; Blond and Netterstrom 2007; Blond et al. 2007; Bouchard et al. 2003, 2005, 2007a, 2007b; Chia et al. 1993a, 1995; Crump and Rousseau 1999; Deschamps et al. 2001; Gibbs et al. 1999;

## 2. RELEVANCE TO PUBLIC HEALTH

Iregren 1990; Lucchini et al. 1995, 1999; Mergler et al. 1994; Myers et al. 2003a, 2003b; Roels et al. 1987a, 1992, 1999; Wennberg et al. 1991) or in environmental media close to manganese-emitting industries (Lucchini et al. 2007; Mergler et al. 1999; Rodríguez-Agudelo et al. 2006). Some of these studies have found statistically significant differences between exposed and non-exposed groups or significant associations between exposure indices and neurological effects (Bast-Pettersen et al. 2004; Chia et al. 1993a; Iregren 1990; Lucchini et al. 1995, 1999; Mergler et al. 1994; Roels et al. 1987a, 1992; Wennberg et al. 1991), whereas others have not found significant associations (Deschamps et al. 2001; Gibbs et al. 1999; Myers et al. 2003a, 2003b; Young et al. 2005). Table A-3 in Appendix A summarizes results from these studies. The neurological effects associated with prolonged low-level manganese exposure generally have been subtle changes including deficits in tests of neuromotor or cognitive functions and altered mood states; they have been referred to by various authors as preclinical or subclinical neurological effects. Manganese air concentrations associated with these effects in chronically exposed workers range from about 0.07 to 1.59 mg manganese/m<sup>3</sup> (manganese in total or inhalable dust measurements; values for manganese in respirable dust are noted in parentheses in Table A-3). Comparison of the effect levels in these studies provides support for selection of the Roels et al. (1992) as the basis of the MRL; the advantage of the Roels et al. (1992) study is that individual worker data were available to support a benchmark dose analysis.

Several benchmark analyses of results from other epidemiological data for neurobehavioral deficits in manganese-exposed workers provide support for the MRL.

Dr. Anders Iregren provided ATSDR with individual worker data on total dust manganese exposure and performance on neurobehavioral tests for the occupational cohort that participated in his study (Iregren 1990; Wennberg et al. 1991). A benchmark analysis was also performed with these data (Clewell and Crump 1999) and the BMCL<sub>10</sub> value derived from this evaluation was 0.071 mg manganese/m<sup>3</sup> based upon the reported observation that the respirable fraction ranged upwards to 80% of the total dust measured. This BMCL<sub>10</sub> value is similar to that estimated for the Roels et al. (1992) study (0.105 mg manganese/m<sup>3</sup>), thus giving support to the value obtained for the current MRL study.

Clewell et al. (2003) conducted benchmark analyses on data from three neuromotor tests in the Roels et al. (1992) study (visual reaction time, eye-hand coordination, and hand steadiness) and from five neuromotor tests in the Gibbs et al. (1999) study (hole 6 of the hand steadiness test, percent precision of the eye-hand coordination test, reaction time in the complex reaction test, RMS amplitude in the steady test, and tap time). Exposure measures in these analyses were recent measures of manganese

## 2. RELEVANCE TO PUBLIC HEALTH

concentrations in respirable dust. BMCL<sub>10</sub> values were 0.257, 0.099, and 0.202 mg manganese/m<sup>3</sup>, respectively, for the visual reaction time, eye-hand coordination, and hand steadiness data from the Roels et al. (1992) study. BMCL<sub>10</sub> values from the analyses of outcomes from the Gibbs et al. (1999) study ranged from 0.09 to 0.27 mg manganese/m<sup>3</sup> (averaging the BMCLs within end points across different benchmark dose models applied to the data). Clewell et al. (2003) did not have individual worker data from the Iregren (1990) or Mergler et al. (1994) studies, but, based on some assumptions about exposures (e.g., all exposed workers were exposed to average concentrations for the facilities and respirable manganese concentrations were calculated for the Iregren workers based on an assumption that 50% of total dust manganese was respirable), they calculated BMCL<sub>10</sub> values for six end points from the Mergler et al. (1994) study and the simple reaction time end point in the Iregren (1990) study. BMCL<sub>10</sub> values ranged from 0.1 to 0.3 mg manganese/m<sup>3</sup> from the Mergler et al. (1994) study end points to 0.1 mg manganese/m<sup>3</sup> for the reaction time end point in the Iregren (1990) study.

Health Canada (2008) recently prepared a draft document in which benchmark dose analyses were conducted on data for neurobehavioral end points from the study of manganese alloy workers by Lucchini et al. (1999). Using the average manganese concentrations in respirable dust over the 5-year period before testing as the dose metric, dose-response data for six tests of fine motor control, two aspects of memory tests, and one test of mental arithmetic were fit to linear models, which were used to calculate BMCL<sub>05</sub> values ranging from about 0.019 to 0.0588 mg manganese/m<sup>3</sup>. After adjustment to convert from occupational exposure (5 days/week, 8 hours/24 hours) to continuous exposure, adjusted BMCL<sub>05</sub> values were divided by a total uncertainty factor of 100 to arrive at prospective reference concentrations. The uncertainty factor was comprised of a factor of 10 to account for interindividual variability in response to manganese to protect possibly enhanced susceptibility of the elderly, infants and children, individuals with asymptomatic pre-parkinsonism, individuals with chronic liver disease or parenteral nutrition, and females and individuals with iron deficiency and a second factor of 10 to account for limitations/uncertainties in the database including: (1) the general population may be exposed to more soluble forms of manganese than most of the manganese-exposed workers; (2) the lack of extensive studies of the effect of prenatal exposure to manganese; and (3) the potential effects that manganese exposure early in life may have on health outcomes later in life. The prospective reference concentrations ranged from about 0.05 to 0.08 µg manganese/m<sup>3</sup>.

## 2. RELEVANCE TO PUBLIC HEALTH

**Oral MRLs for Inorganic Manganese**

**Overview.** No oral MRLs were derived for acute-, intermediate-, or chronic-duration oral exposure to manganese, even though the limited human data and extensive animal data clearly identify neurobehavioral changes as the most sensitive effect from intermediate- and chronic-duration oral exposure to excess inorganic manganese. However, inconsistencies in the dose-response relationship information across studies evaluating different neurological end points under different experimental conditions in different species, as well as a lack of information concerning all intakes of manganese (e.g., dietary intakes plus administered doses), make it difficult to derive intermediate- or chronic-duration MRLs using standard MRL derivation methodology from the animal studies. New reports of neurobehavioral effects in children associated with elevated concentrations of manganese in drinking water were evaluated as the possible basis of an oral MRL for intermediate and/or chronic durations of exposure. However, the data were assessed to be unsuitable for MRL derivation due to uncertainties about other possible confounding exposures to neurotoxic agents in the drinking water or via food, and the lack of information about dietary intakes of manganese by the children. An interim guidance value of 0.16 mg manganese/kg/day, based on the Tolerable Upper Intake Level for 70 kg adults of 11 mg manganese/day (established by the U.S. Food and Nutrition Board/Institute of Medicine [FNB/IOM 2001]) is recommended to be used for ATSDR public health assessments of oral exposure to inorganic forms of manganese.

**Acute Oral Exposure.** Quantitative data are not available to derive acute-duration oral MRLs. The only new acute-duration study reported that a single dose of 50 mg manganese chloride/kg (13.9 mg manganese/kg) to a group of 10 white rats caused worsened acquisition of an avoidance reaction in response to unconditioned and condition stimuli, increased latent period of a conditioned reflex activity, and increased numbers of errors and time taken to navigate a maze (compared with controls), beginning on day 5 after dose administration and lasting until day 10–15 (Shukakidze et al. 2003). Although neurobehavioral impairment from acute oral exposure to manganese is plausible based on results from studies of manganese-exposed workers and repeatedly exposed animals, there are no corroborating data from other acute-duration studies to confirm this finding of impaired neurobehavior following a single oral dose of 13.9 mg manganese/kg.

Other acute-duration oral studies found only decreased liver and body weight and decreased leukocyte and neutrophil counts in rats at dietary doses of 1,300 mg manganese/kg/day and no effects in mice at dietary doses up to 2,600 (males) or 3,900 (females) mg manganese/kg/day after 14 days of exposure to

## 2. RELEVANCE TO PUBLIC HEALTH

manganese sulfate in the diet (NTP 1993). No signs of developmental or maternal toxicity were observed in a standard developmental toxicity study of pregnant rats given daily gavage doses of 2,200 mg manganese/kg/day as manganese chloride on gestation days 6–17 (Grant et al. 1997a). With intermediate-duration, no exposure-related effects on fetal body weight or skeletal development or anomalies were found in pregnant rabbits exposed to 33 mg manganese/kg/day on gestation days 6–20, but some evidence for delayed fetal skeletal development was found in pregnant Sprague-Dawley rats exposed to the same dose of manganese chloride on gestation days 0–21 (Szakmáry et al. 1995).

***Intermediate Oral Exposure.*** With intermediate-duration oral exposure, effects on neurobehavior are expected to be the most sensitive effects from excessive manganese, particularly during early developmental periods, based on findings for subtle neurobehavioral effects in epidemiological studies on manganese-exposed workers (see Section 3.1), higher brain manganese levels and altered brain dopamine levels in neonatal rats, compared with adult rats, due to immaturity of the blood-brain barrier and the lack of biliary excretion in preweanling rats (Aschner et al. 2005; Dorman et al. 2000, 2005a; Kontur and Fechter 1985, 1988), and results from studies of the effects of intermediate-duration oral exposure on systemic toxicity end points and neurobehavioral, neurochemical, and neurodevelopmental end points in adult and young laboratory animals (Calibresi et al. 2001; Reichel et al. 2006; Tran et al. 2002a, 2002b).

The discussion that follows provides evidence that, while systemic effects of manganese are not typically the most sensitive end point of action, some evidence exists to support adverse cardiovascular effects of manganese at relatively low dose levels, followed by a review of the large number of studies that most consistently support neurobehavior effects as the most sensitive effects from excessive oral manganese exposure.

In standard toxicity studies of intermediate-duration oral exposure to inorganic manganese, marginal evidence for systemic toxicity was found in rats at doses  $\geq 33$  mg manganese/kg/day (increased neutrophil count and decreased liver weight in males; decreased body weights at higher doses) and in mice at the highest administered dose of 1,950 mg manganese/kg/day (decreased hemoglobin, mild hyperplasia of forestomach, decreased liver and body weight) (NTP 1993). Corroborative evidence comes from reports of decreased red blood cell counts and body weight in mice following 100 days of dietary exposure to one of several forms of inorganic manganese (manganese acetate, carbonate, oxide, or chloride) at a dose level of 284 mg manganese/kg/day (Komura and Sakamoto 1991).

## 2. RELEVANCE TO PUBLIC HEALTH

However, other animal studies indicate that excessive oral intake of manganese may present a cardiovascular hazard. Under magnesium deficiency conditions (4.1 mmol Mg/kg diet), swine fed moderately elevated levels of manganese (about 500 mg manganese/kg diet) died suddenly within 5 weeks and showed necrosis and mineralization of the heart (Miller et al. 2000). This finding was supported with subsequent findings of myocardial necrosis and mitochondrial swelling in magnesium-deficient pigs fed a diet high in manganese (500 mg manganese/kg diet) for 8 weeks (Miller et al. 2004) and of depressed heart muscle mitochondrial O<sub>2</sub> consumption and decreased red blood cells in rats consuming a high manganese diet (250 mg manganese/kg diet) under marginal magnesium dietary conditions; the manganese-induced effects on hematological end points in rats were absent when adequate dietary magnesium was provided (Miller et al. 2006). In another study involving rats supplied with adequate and excessive Mn in the diet (10–15 and 45–50 mg manganese/kg diet), aortas from rats with excessive dietary manganese showed less expression and sulfation of heparin sulfate glycosaminoglycans, compared with the adequate condition (Kalea et al. 2006). The results from these studies suggest that excessive intermediate-duration oral intake of manganese may present a cardiovascular hazard, especially under magnesium-deficient dietary conditions, but their use as the basis of an intermediate-duration oral MRL for inorganic manganese is limited due to the lack of reported information to accurately calculate daily intakes. Myocardial lesions were not found in rats or mice provided manganese sulfate in the diet for 2 years at dose levels up to 232 or 731 mg manganese/kg/day, respectively (NTP 1993).

Numerous studies support the sensitivity of neurobehavioral end points to intermediate-duration oral doses of manganese. In humans and nonhuman primates exposed orally for intermediate durations, neurobehavioral end points have been examined in healthy adult female subjects given low (0.01 mg manganese/kg/day) or high (0.3 mg manganese/kg/day) manganese diets for 8 weeks (Finley et al. 2003) and in infant monkeys fed either a commercial cow's milk formula (17.5 mg manganese/kg/day), a commercial soy formula (107.5 mg manganese/kg/day), or a soy formula with added magnesium chloride (328 mg manganese/kg/day) for 4 months with monkeys tested through 18 months of age (Golub et al. 2005). No differences between the low and high dietary-intake states were found in the adult females on scores for hand-steadiness and self-reported traits such as assertiveness and anger (Finley et al. 2003). Monkeys provided the highest manganese dose level showed no marked differences from the cow's milk controls in gross motor maturation, growth, cerebrospinal fluid levels of dopamine or serotonin metabolites, or performance on tests of cognitive end points, but showed decreased activity during sleep at 4 months and decreased play activity between 1 and 1.5 months. These results suggest that daily intakes of 328 mg manganese/kg/day (but not 107.5 mg manganese/kg/day) during neonatal periods may cause subtle neurobehavioral changes in primates.



## 2. RELEVANCE TO PUBLIC HEALTH

In neurobehavioral assessments of rodents orally exposed to inorganic manganese for intermediate durations during neonatal periods, subtle neurobehavioral effects have been observed at supplemental dose levels as low as about 10–20 mg manganese/kg/day (Brenneman et al. 1999; Dorman et al. 2000; Kristensson et al. 1986; Pappas et al. 1997; Reichel et al. 2006; Tran et al. 2002a, 2002b). Although there are some inconsistencies in the results obtained in these studies (e.g., Brenneman et al. [1999] found increased motor activity with exposure to 22 mg manganese/kg/day after exposure on postnatal days 1–49, but Dorman et al. [2000] found no effects of the same dose level on motor activity after exposure on postnatal days 1–21), the weight of evidence suggests that subtle neurobehavioral effects can occur in rats with intermediate-duration neonatal exposures at doses  $\geq$ 10–20 mg manganese/kg/day.

Findings for histopathological changes in the rat brain following intermediate-duration oral exposure to inorganic manganese during neonatal periods are less consistent than the findings for subtle neurobehavioral effects. Chandra and Shukla (1978) reported neuronal degeneration in cortical and cerebellar sections from the brains of young rats orally exposed to 0.3 mg manganese/kg/day as manganese chloride between postnatal days 21 and 51. In contrast, Kristensson et al. (1986) reported no adverse histological changes in cerebellum or hippocampus in rats exposed to a much higher dose level of manganese chloride (150 mg manganese/kg/day) between postnatal days 3 and 44. Pappas et al. (1997) reported a decreased cortical thickness in the offspring of rat dams exposed to 120 or 650 mg manganese/kg/day from gestation day 1 through postnatal day 30, but found no immunohistological evidence for increased glial fibrillary acidic protein in the cortex, caudate, or hippocampus. Dorman et al. (2000) reported that no adverse histological changes were found in sections of the following brain regions in Sprague-Dawley rats exposed to 11 or 22 mg manganese/kg/day on postnatal days 1–21: olfactory bulbs, cerebral cortex, hippocampus, basal ganglia, thalamus, hypothalamus, midbrain, and cerebellum. The weight of evidence from these studies indicates that subtle neurobehavioral effects in neonatally exposed rats are not consistently associated with histological changes in the brain.

Neurobehavioral effects have also been observed in adult rats orally exposed to inorganic manganese for intermediate durations. In several studies, doses inducing these effects were higher than those inducing subtle neurobehavioral effects after neonatal exposure (Calabresi et al. 2001; Centonze et al. 2001; Torrente et al. 2005), but in two other studies, neurobehavioral effects were observed at doses as low as 5.6 mg manganese/kg/day (Shukakidze et al. 2003) and 6.5 mg manganese/kg/day (Vezér et al. 2005, 2007). Increased open field activity, increased interest in a novel object, and increased signs of fear were observed in adult male Wistar rats exposed to drinking water containing 20 mg manganese chloride/L for

## 2. RELEVANCE TO PUBLIC HEALTH

10 weeks (estimated doses of 1,310 mg manganese/kg/day), but no effects on radial maze performance, numbers of neuronal cells or levels of glial fibrillary acidic protein in striatum, or intrinsic electrophysiological membrane properties of striatal neurons with the exception of a manganese-induced increase in the frequency and amplitude of spontaneous excitatory postsynaptic potentials (Calabresi et al. 2001; Centonze et al. 2001). In an earlier study of adult male Wistar rats exposed to 20 mg manganese chloride/L for 13 weeks, no neuronal loss or gliosis was evident in the globus pallidus by either histological or immunohistochemical examination (Spadoni et al. 2000). Decreased open field activity and impaired spatial learning were observed in restraint stressed adult male Sprague-Dawley rats exposed to 153 mg manganese/kg/day (but not 76 mg manganese/kg/day) as manganese chloride in drinking water for 19 weeks (Torrente et al. 2005). No changes in motor activity or performance in a passive avoidance test were observed in adult male Sprague-Dawley rats exposed to 11 or 22 mg manganese/kg/day for 21 days; these doses induced increased pulse-elicited acoustic startle response with neonatal exposure, but exposure during adulthood did not (Dorman et al. 2000). The lowest intermediate-duration daily dose associated with neurobehavioral effects in adult rats is 5.6 mg manganese/kg/day for severely impaired cognitive performance in a maze test following a 30-day exposure of white rats to manganese chloride in the diet (strain not otherwise indicated) (Shukakidze et al. 2003). In another study, decreased open-field locomotor activity and acoustic startle response and impaired performance in maze learning (a test of spatial memory) were observed in male adult Wistar rats exposed to gavage doses of 6.5 or 25.9 mg manganese/kg/day for 10 weeks, compared with controls (Vezér et al. 2005, 2007). Decreased acoustic startle response and impaired spatial memory were still evident in exposed rats, compared with controls, after 5–7 weeks without exposure (Vezér et al. 2005, 2007).

Several types of reproductive effects have been reported for manganese. A study by Hafeman et al. (2007) reported a high mortality rate among infants <1 year of age in a Bangladesh community where manganese levels in drinking water were high, but the actual association between the manganese levels in drinking water and infant mortality is difficult to make with certainty. The average level of manganese intake was calculated to be 0.26 mg manganese/kg/day. Other reproductive effects reported for manganese in intermediate-duration animal studies include 25% decreased pregnancy rate in Long-Evans rats (males and females) exposed to manganese oxide in the diet at 180 mg manganese/kg/day (but not 55 mg manganese/kg/day) for 100–224 days (Laskey et al. 1982), increased incidence of testicular degeneration in male Sprague-Dawley rats exposed to manganese acetate at gavage doses of 137 (but not 69) mg manganese/kg/day for 63 days (Ponnappakkam et al. 2003c), and delayed growth of testes and sex accessory glands in CD-1 mice exposed to manganese oxide in the diet at 205 mg manganese/kg/day (Gray and Laskey 1980). In Swiss mice exposed for 12 weeks to manganese chloride in drinking water,

## 2. RELEVANCE TO PUBLIC HEALTH

impaired fertility was observed in males at 309 mg manganese/kg/day (but not a 154 mg manganese/kg/day) and in females at 277 mg manganese/kg/day (Elbetieha et al. 2001). Decreased sperm motility and sperm counts were observed in CD-1 mice exposed to 4.8 or 9.6 mg manganese/kg/day as manganese acetate, but no effects on the ability of exposed males to impregnate unexposed female mice were found at these doses (Ponnappakkam et al. 2003a). The results from the intermediate-duration animal studies suggest that oral exposure to manganese may produce adverse effects on reproduction, but at much higher doses than those inducing subtle neurobehavioral effects in adult or neonatal rats.

In summary, results from animal studies identify subtle neurobehavioral effects as the critical effect in rodents from intermediate-duration oral exposure to inorganic manganese. Potential points of departure for an intermediate-duration oral MRL include LOAEL values of 5.6 mg manganese/kg/day for severely impaired cognitive performance in a maze test following 30-day dietary exposure of adult white rats (Shukakidze et al. 2003); 6.5 mg manganese/kg/day for decreased open-field locomotor activity and acoustic startle response and impaired performance in maze learning (a test of spatial memory) in male adult Wistar rats exposed for 10 weeks by gavage (Vezér et al. 2005, 2007); and 11 mg manganese/kg/day for increased pulse-initiated acoustic startle response in Sprague-Dawley rats exposed (orally by pipette) on postnatal days 1–21 (Dorman et al. 2000). In contrast, hand steadiness or self-reported scales for assertiveness or anger were not different in adult female subjects following 8 weeks of exposure to dietary doses of 0.01 or 0.3 mg manganese/kg/day (Finley et al. 2003). In young monkeys, decreased activity during sleep at 4 months and decreased play activity between 1 and 1.5 months were observed following daily intakes of 328 mg manganese/kg/day (but not 107.5 mg manganese/kg/day), but no effects on gross motor maturation or performance in cognitive tests were observed at either dose level compared with controls (Golub et al. 2005).

The effects noted in the rat study by Shukakidze et al. (2003) are much more severe than effects noted in adult rats at reportedly higher dose levels of 1,310 mg manganese/kg/day (Calabresi et al. 2001; Centonze et al. 2001) or 153 mg manganese/kg/day (Torrente et al. 2005) or in adult rats at comparable reported doses of 6.5 mg manganese/kg/day (Vezér et al. 2005, 2007). Shukakidze et al. (2003) reported that the exposed rats “showed increased aggressivity, frequently fell from the platform in the maze, and were unable to perform the maze test.” Because the reporting of the experimental conditions in the Shukakidze et al. (2003) study is sparse and the severity of effects is so unusual, the results are considered to be outlying results that are not consistent with the rest of the database and not appropriate as the basis of an MRL.

## 2. RELEVANCE TO PUBLIC HEALTH

If the LOAEL of 6.5 mg manganese/kg/day for decreased open-field locomotor activity and acoustic startle response and impaired performance in maze learning in male adult Wistar rats exposed for 10 weeks by gavage (Vezér et al. 2005, 2007) was used as the point of departure for the intermediate-duration oral MRL, a value of 0.007 mg manganese/kg/day would be derived if an uncertainty factor of 1,000 were used (10 for use of a LOAEL, 10 for extrapolating across species, and 10 for human variability). However, this rodent-based value of 0.007 mg manganese/kg/day would be about 4-fold below the FNB/IOM (2001) recommended AI of 1.8 and 2.3 mg manganese/day for women and men, respectively (approximately 0.03 mg manganese/kg/day) and about 23-fold below the FNB/IOM (2001) recommended Tolerable Upper Intake Level (UL) of 11 mg/day for adults  $\geq 19$  years of age (approximately 0.16 mg manganese/kg/day). Part of the apparent discrepancy between this prospective MRL and the recommended dietary intakes is that the MRL is based only on manganese intakes above the normal dietary intakes. Unfortunately, the dietary intakes of manganese by the rats in the Vezér et al. study (2005, 2007) cannot be estimated from the information provided in the published report.

Alternatively, using the monkey NOAEL of 107 mg manganese/kg/day for decreased activity during sleep at 4 months and decreased play activity between 1 and 1.5 months in formula-fed infant monkeys provided soy-based formula from birth to 4 months of age (Golub et al. 2005), a value of 1 mg manganese/kg/day would be derived if an uncertainty factor of 100 were used (10 for extrapolating across species and 10 for human variability). The monkey-based value would be about 6-fold higher than the FNB/IOM (2001) UL of 11 mg manganese/day for adults (0.16 mg manganese/kg/day assuming a 70-kg body weight). The formulas fed to the infant monkeys in this study are expected to have been the principal source of manganese.

For children and adolescents, FNB/IOM (2001) scaled the adult UL values according to reference body weights for children and adolescents, noting that there were no reports of manganese toxicity in children and adolescents and that it was not possible to establish UL values for infants (0–12 months).

Based on several surveys, FNB/IOM (2001) reported that average intakes of adults with typical “Western-type” and vegetarian diets ranged from 0.7 to 10.9 mg/day (0.01–0.156 mg manganese/kg/day, assuming a 70-kg body weight). WHO (2004b) recently calculated an estimated daily intake of about 0.0003 mg manganese/kg/day for 70-kg subjects drinking 2 L of water per day at a concentration of 0.010 mg manganese/L, the median of a survey of manganese in drinking water.

## 2. RELEVANCE TO PUBLIC HEALTH

**Chronic Oral Exposure.** Data on the effects of manganese following chronic oral exposure are less extensive than intermediate-duration data, but these reports do suggest that neurological effects similar to those seen after intermediate-duration exposure may be anticipated following chronic oral exposure to excess manganese. In the reports of neurological effects in humans following chronic oral exposure, there is either uncertainty regarding the exposure level (He et al. 1994; Zhang et al. 1995) or uncertainty that the effects observed were solely attributable to manganese (Bouchard et al. 2007c; Holzgraefe et al. 1986; Kawamura et al. 1941; Kilburn 1987; Kondakis et al. 1989; Wasserman et al. 2006; Wright et al. 2006). However, there is no clear understanding of the threshold for manganese deficiency/sufficiency or toxicity. Males consuming 0.35 and 0.11 mg manganese/day exhibited symptoms of manganese deficiency (Doisy 1973; Friedman et al. 1987, respectively). But Davis and Greger (1992) did not report any deficiency symptoms among female subjects, 20% of whom consumed <1 mg manganese/day and Finley et al. (2003) did not observe signs of manganese deficiency or toxicity in adult females with dietary intakes of 0.8 or 20 mg manganese/day for 8 weeks. Authors of a case study suspected abuse of vitamin and mineral preparations to be the source for excess manganese and neurological symptoms observed in their patient (Banta and Markesbery 1977).

Four reports of manganese neurotoxicity in children have been published recently including: (1) severe manganese-like neurotoxic symptoms (inability to stand independently, tendency to fall backward, and development of a “cock-like” walk) in a previously healthy 6-year-old female that were associated with elevated drinking water concentrations of manganese (1.7–2.4 mg manganese/L), pica, a diet high in manganese-rich foods, and elevated levels of plasma manganese (Sahni et al. 2007); (2) inattentiveness and lack of focus in the classroom and low-percentile performance in tests of memory in a 10-year-old male with no history of learning problems associated with elevated manganese in drinking water (1.21 mg manganese/L) (Woolf et al. 2002); (3) a statistically significant relationship for decreasing intelligence scores with increasing manganese levels in drinking water in a cross-sectional epidemiological study of 142 10-year-old children in Bangladesh (Wasserman et al. 2006); and (4) a statistically significant relationship between increased levels of oppositional behaviors and hyperactivity and increased levels of manganese in drinking water in an epidemiological study of 46 children (ages 6–15 years) in Quebec, Canada (Bouchard et al. 2007c). Although these recent reports cannot causally link the observed neurotoxic effects to excessive manganese intakes, they provide added weight to the evidence for the neurotoxic potential of excessive manganese in children.

As shown in the chronic exposure section of the oral LSE table and figure in Chapter 3, estimated daily intakes from drinking water were calculated as 0.103 mg manganese/kg/day for the 6-year-old female

## 2. RELEVANCE TO PUBLIC HEALTH

(Sahni et al. 2007), 0.06 mg manganese/kg/day for the 10-year-old male (Woolf et al. 2002), 0.11 mg manganese/kg/day based on the mean manganese drinking water concentration for the fourth quartile group of Bangladesh 10-year-old children (1.923 mg manganese/L), reference daily water intakes (1.3 L/day) and average body weights (22.4 kg) (Wasserman et al. 2006), and 0.02 mg manganese/kg/day for the high-manganese intake children in Quebec (0.5 mg manganese/L), reference daily water intakes (1.3 L/day) and reference body weights (37.2 kg) (Bouchard et al. 2007c).

To derive an oral MRL for intermediate and chronic durations, an average of the drinking water LOAELs for neurobehavioral effects in the two case reports (Sahni et al. 2007; Woolf et al. 2002), the cross-sectional study of 10-year-olds in Bangladesh (Wasserman et al. 2006), and the study of children in Quebec (Bouchard et al. 2007c) could potentially serve as a point of departure for the MRL. However, the following uncertainties associated with these studies of children preclude their use as the basis for an intermediate- or chronic-duration MRL: (1) whether or not the observed effects were solely due to excess manganese alone or could have been influenced by other drinking water or dietary components; (2) the lack of information about manganese levels in food and air; and (3) the small sample sizes.

***Interim Guidance Value for Oral Exposure to Inorganic Manganese.*** As discussed in the preceding sections, no oral MRLs were derived for acute-, intermediate-, or chronic-duration exposure to inorganic manganese, but it is recommended that an interim guidance value of 0.16 mg manganese/kg/day be used for ATSDR public health assessments. The interim guidance value is based on the Tolerable Upper Intake Level for adults of 11 mg manganese/day established by the U.S. Food and Nutrition Board/Institute of Medicine (FNB/IOM 2001) based on a NOAEL for Western diets (0.16 mg manganese/kg/day assuming an adult body weight of 70 kg). The interim guidance value is well above the FNB/IOM Adequate Intake (AI) value for manganese for men and women of 2.3 and 1.8 mg manganese/day, respectively (for 70-kg individuals, this would result in exposures of 0.033 and 0.026 mg manganese/kg/day, respectively). The interim guidance value is necessary because of the prevalence of manganese at hazardous waste sites and the fact that manganese is an essential nutrient. It is recommended that this value be used until more information on actual intake levels across environmental media can be obtained.

**MRLs for MMT**

Inhalation and oral MRL values for acute, intermediate, or chronic exposures to MMT have not been derived. There are currently insufficient data regarding the systemic toxicity and carcinogenicity of this

## 2. RELEVANCE TO PUBLIC HEALTH

compound via inhalation or oral exposures and no reliable data concerning current environmental or occupational exposures with appropriate dose-response information.

### **MRLs for Mangafodipir**

MRL values for mangafodipir are not believed to be warranted. This compound is used in a clinical environment, is administered intravenously only, and is restricted to a very limited population. Thus, it is believed unlikely that this compound would be found at hazardous waste sites or other environmental settings.

2. RELEVANCE TO PUBLIC HEALTH

This page is intentionally blank.



### 3. HEALTH EFFECTS

#### 3.1 INTRODUCTION

The primary purpose of this chapter is to provide public health officials, physicians, toxicologists, and other interested individuals and groups with an overall perspective on the toxicology of manganese. It contains descriptions and evaluations of toxicological studies and epidemiological investigations and provides conclusions, where possible, on the relevance of toxicity and toxicokinetic data to public health.

A glossary and list of acronyms, abbreviations, and symbols can be found at the end of this profile.

Manganese is a naturally occurring element found in rock, soil, water, and food. In humans and animals, manganese is an essential nutrient that plays a role in bone mineralization, protein and energy metabolism, metabolic regulation, cellular protection from damaging free radical species, and formation of glycosaminoglycans (Wedler 1994). Manganese acts as both a constituent of metalloenzymes and an enzyme activator. Enzymes that contain manganese include arginase, pyruvate carboxylase, and manganese-superoxide dismutase (MnSOD) (Keen and Zidenberg-Cher 1990; NRC 1989; Wedler 1994). Manganese, in its activating capacity, can bind either to a substrate (such as adenosine triphosphate, ATP), or to a protein directly, thereby causing conformational changes (Keen and Zidenberg-Cher 1990). Manganese has been shown to activate numerous enzymes involved with either a catalytic or regulatory function (e.g., transferases, decarboxylases, hydrolases) (Wedler 1994). The nutritional role of manganese is discussed in Section 3.4. Although manganese is an essential nutrient, exposure to high levels via inhalation or ingestion may cause some adverse health effects.

It has been suggested that these adverse health effects, especially neurologic effects, are occurring on a “continuum of ...dysfunction” that is dose-related (Mergler et al. 1999). In other words, mild or unnoticeable effects may be caused by low, but physiologically excessive, amounts of manganese, and these effects appear to increase in severity as the exposure level or duration of exposure increases. Case reports and occupational studies address this continuum of nervous system dysfunction and help to characterize the apparent dose-response relationship. It is clear that chronic exposure to manganese at very high levels results in permanent neurological damage, as is seen in former manganese miners and smelters. Chronic exposure to much lower levels of manganese (as with occupational exposures) has been linked to deficits in the ability to perform rapid hand movements and some loss of coordination and balance, along with an increase in reporting mild symptoms such as forgetfulness, anxiety, or insomnia.

## 3. HEALTH EFFECTS

**Chemical Forms of Concern.** Manganese can exist in both inorganic and organic forms. This profile will discuss key manganese compounds in both forms, with inorganic compounds discussed first.

The inorganic forms include manganese chloride ( $\text{MnCl}_2$ ), manganese sulfate ( $\text{MnSO}_4$ ), manganese acetate ( $\text{MnOAc}$ ), manganese phosphate ( $\text{MnPO}_4$ ), manganese dioxide ( $\text{MnO}_2$ ), manganese tetroxide ( $\text{Mn}_3\text{O}_4$ ), and manganese carbonate ( $\text{MnCO}_3$ ). Emphasis has been placed on the health effects of compounds containing inorganic manganese in the Mn(II), Mn(III), or Mn(IV) oxidation states, since these are the forms most often encountered in the environment and the workplace. There is evidence in animals and humans that adverse neurological effects can result from exposure to different manganese compounds; much of this information on toxicity differences between species of manganese is from reports and experiments of acute exposures to very high doses. Results from animal studies indicate that the solubility of inorganic manganese compounds can influence the bioavailability of manganese and subsequent delivery of manganese to critical toxicity targets such as the brain; however, the influence of manganese oxidation state on manganese toxicity is not currently well understood. Manganese in the form of permanganate produces toxic effects primarily through its oxidizing capacity. However, because of its tendency to oxidize organic material, the permanganate ion is not stable in the environment; thus, the probability of exposure to this species around waste sites is considered very low. For this reason, data on exposures to permanganate are only briefly discussed.

The organic compounds that will be discussed are methylcyclopentadienyl manganese tricarbonyl (MMT) and mangafodipir. The latter is a chelate of Mn(II) and an organic ligand, dipyridoxyl diphosphate (MnDPDP; Mn(II) *N,N'*-dipyridoxylethylenediamine-*N,N'*-diacetate 5,5'-bis(phosphate)). These compounds were chosen for this profile because their toxicity is expected to be mediated by excess exposure to elemental manganese. Organic fungicides containing manganese, such as maneb, were not chosen for discussion in this profile, because their critical toxic effects are expected to be mediated by the organic moieties of their chemical structure, not by excessive elemental manganese.

MMT is a fuel additive developed in the 1950s to increase the octane level of gasoline and thus improve the antiknock properties of the fuel (Davis 1998; Lynam et al. 1999). Additional information on the chemical, physical, and environmental properties of MMT is included in Chapter 4. Exposure to MMT is expected to be primarily through inhalation or oral pathways, although occupational exposure for gasoline attendants or mechanics may be more significant via dermal absorption. Engines using MMT-containing gasoline and equipped with catalytic converters primarily emit manganese in inorganic phosphate and sulfate forms and smaller amounts of manganese dioxides can be detected (Mölders et al. 2001; Ressler et

### 3. HEALTH EFFECTS

al. 2000; Zayed et al. 1999a, 1999b). These findings and observations that MMT is very unstable in light and degrades quickly in air (Garrison et al. 1995) suggest that human exposure to manganese from the use of MMT in gasoline is most likely to occur in inorganic forms as a result of the combustion of MMT, with the exception of people occupationally exposed to uncombusted gasoline containing MMT. However, despite this evidence, there are some reports that MMT levels in the environment increase with traffic density (Garrison et al. 1995; Zayed et al. 1999a, 1999b); therefore, inhalation and/or ingestion exposures to the parent compound are possible. Exposure and resultant toxicity from MMT's inorganic combustion products are covered under the inorganic subsections, while toxicity attributable to MMT is covered under the organic subsections.

Mangafodipir is a contrast agent for magnetic resonance imaging (MRI) used primarily (after intravenous administration) to detect and characterize neoplastic liver lesions; it has also been found to aid in the identification of kidney and pancreatic tumors (Federle et al. 2000; Grant et al. 1997a, 1997b; Ni et al. 1997). The compound is only used in the diagnosis of organ-specific cancers and is found exclusively in a clinical setting. Mangafodipir is injected intravenously; therefore, inhalation, oral, and dermal pathways of exposure are not a concern. Because exposure to this compound is pathway-specific and the exposure population is inherently limited, toxicity arising from exposure to mangafodipir will be discussed in a separate subsection to Section 3.2.4, Diagnostic Uses.

## 3.2 DISCUSSION OF HEALTH EFFECTS BY ROUTE OF EXPOSURE

To help public health professionals and others address the needs of persons living or working near hazardous waste sites, the information in this section is organized first by route of exposure (inhalation, oral, and dermal) and then by health effect (death, systemic, immunological, neurological, reproductive, developmental, genotoxic, and carcinogenic effects). These data are discussed in terms of three exposure periods: acute (14 days or less), intermediate (15–364 days), and chronic (365 days or more).

Levels of significant exposure for each route and duration are presented in tables and illustrated in figures. The points in the figures showing no-observed-adverse-effect levels (NOAELs) or lowest-observed-adverse-effect levels (LOAELs) reflect the actual doses (levels of exposure) used in the studies. LOAELs have been classified into "less serious" or "serious" effects. "Serious" effects are those that evoke failure in a biological system and can lead to morbidity or mortality (e.g., acute respiratory distress or death). "Less serious" effects are those that are not expected to cause significant dysfunction or death, or those whose significance to the organism is not entirely clear. ATSDR acknowledges that a

### 3. HEALTH EFFECTS

considerable amount of judgment may be required in establishing whether an end point should be classified as a NOAEL, "less serious" LOAEL, or "serious" LOAEL and that, in some cases, there will be insufficient data to decide whether the effect is indicative of significant dysfunction. However, the Agency has established guidelines and policies that are used to classify these end points. ATSDR believes that there is sufficient merit in this approach to warrant an attempt at distinguishing between "less serious" and "serious" effects. The distinction between "less serious" effects and "serious" effects is considered to be important because it helps the users of the profiles to identify levels of exposure at which major health effects start to appear. LOAELs or NOAELs should also help in determining whether or not the effects vary with dose and/or duration and place into perspective the possible significance of these effects to human health.

The significance of the exposure levels shown in the Levels of Significant Exposure (LSE) tables and figures may differ depending on the user's perspective. Public health officials and others concerned with appropriate actions to take at hazardous waste sites may want information on levels of exposure associated with more subtle effects in humans or animals (LOAELs) or exposure levels below which no adverse effects (NOAELs) have been observed. Estimates of levels posing minimal risk to humans (Minimal Risk Levels or MRLs) may be of interest to health professionals and citizens alike.

A User's Guide has been provided at the end of this profile (see Appendix B). This guide should aid in the interpretation of the tables and figures for Levels of Significant Exposure and the MRLs.

#### 3.2.1 Inhalation Exposure

Inorganic manganese compounds are not volatile, but they can exist in the air as aerosols or suspended particulate matter. Table 3-1 and Figure 3-1 summarize the available quantitative information on the health effects that have been observed in humans and animals following inhalation exposure to various inorganic manganese compounds. All exposure levels are expressed as milligrams of manganese per cubic meter (mg manganese/m<sup>3</sup>).

Many of the studies, especially those dealing with occupational exposures, make the distinction between respirable and total manganese dust. Respirable dust is usually defined by a particular dust particle size that varies from study to study. It is typically defined as those particles  $\leq 5$  microns; these smaller dust particles can enter the lower areas of the lungs, including the bronchioles and the alveoli. These particles can be absorbed by the lung and will enter the bloodstream immediately, thus avoiding clearance by the

Table 3-1 Levels of Significant Exposure to Inorganic Manganese - Inhalation

| Key to Figure <sup>a</sup> | Species (Strain)     | Exposure/Duration/Frequency (Route)           | System | NOAEL (mg/m <sup>3</sup> ) | LOAEL                             |  | Reference Chemical Form                 | Comments  |   |
|----------------------------|----------------------|---|--------|----------------------------|-----------------------------------|--|---|---|---|
|                            |                      |   |        |                            | Less Serious (mg/m <sup>3</sup> ) | Serious (mg/m <sup>3</sup> )                                   |   |   |   |
| <b>ACUTE EXPOSURE</b>      |                      |   |        |                            |                                   |  |   |   |   |
| <b>Systemic</b>            |                      |   |        |                            |                                   |  |   |   |   |
| 1                          | Rat (Sprague-Dawley) | 10 d<br>6 hr/d                                | Resp   |                            |                                   | 43   | (pneumonitis and increased lung weight) | Shiotsuka 1984<br>MnO <sub>2</sub>                    |   |
|                            |                      |   | Hemato | 138                        |                                   |  |   |   |   |
| 2                          | Mouse (CD-1)         | 2 hr  | Resp   | 2.8 F                      |                                   |  |   | Adkins et al. 1980b<br>Mn <sub>3</sub> O <sub>4</sub> |   |
| 3                          | Mouse (FVB/N)        | 5 d<br>6 h/d                                  | Resp   | 2 F                        |                                   |  |   | Bredow et al. 2007<br>(MnCl <sub>2</sub> )            | No significant treatment-related histopathic lesions in lungs.  |
| 4                          | Gn Pig (NS)          | 1 hr<br>24 hr/d                               | Resp   | 14                         |                                   |  |   | Bergstrom 1977<br>MnO <sub>2</sub>                    |   |
| <b>Immuno/ Lymphoret</b>   |                      |   |        |                            |                                   |  |   |   |   |
| 5                          | Mouse (CD-1)         | 1-4 d<br>3 hr/d                               |        |                            | 69 M                              | (increased susceptibility to pneumonia)                        |   | Maigetter et al. 1976<br>MnO <sub>2</sub>             |   |
| <b>Neurological</b>        |                      |   |        |                            |                                   |  |   |   |   |
| 6                          | Rat (Sprague-Dawley) | Gd 9-10 or pnd 37-47 or Gd 9-10 and pnd 37-47 |        |                            | 0.71                              | (decreased APP, COX-2, nNOS, GFAP, TGF-beta mRNA in the brain) |   | HaMai et al. 2006<br>(MnSO <sub>4</sub> )             | Increased transcription of genes related to oxidative stressor inflammation in brain of rats exposed during gestation or early adulthood. |

\*\*\*DRAFT FOR PUBLIC COMMENT\*\*\*

Table 3-1 Levels of Significant Exposure to Inorganic Manganese - Inhalation

(continued)

| Key to Figure <sup>a</sup>   | Species (Strain)     | Exposure/Duration/Frequency (Route)           | System  | NOAEL (mg/m <sup>3</sup> ) | LOAEL                             |  | Reference Chemical Form                  | Comments  |
|------------------------------|----------------------|---|---------|----------------------------|-----------------------------------|--|--|---|
|                              |                      |   |         |                            | Less Serious (mg/m <sup>3</sup> ) | Serious (mg/m <sup>3</sup> )   |  |   |
| <b>Developmental</b>         |                      |   |         |                            |                                   |  |  |   |
| 7                            | Rat (Sprague-Dawley) | Gd 9-10 or pnd 37-47 or Gd 9-10 and pnd 37-47 |         |                            | 0.71                              | (decreased APP, COX-2, nNOS, and GFAP mRNA)                                | HaMai et al. 2006 (MnSO <sub>4</sub> )   | Increased transcription of genes related to oxidative stressor inflammation in brain of rats exposed during gestation or early adulthood. |
| <b>INTERMEDIATE EXPOSURE</b> |                      |   |         |                            |                                   |  |  |   |
| <b>Systemic</b>              |                      |   |         |                            |                                   |  |  |   |
| 8                            | Monkey (Rhesus)      | 90 d 6 h/d 5 d/wk                             | Resp    | 0.3 M                      | 1.5 M                             | (increased incidence of subacute bronchiolitis/alveolar duct inflammation) | Dorman et al. 2005b (MnSO <sub>4</sub> ) |   |
| 9                            | Monkey               | 90 d 6 h/d 5 d/wk                             | Resp    | 1.5 M                      |                                   |  | Dorman et al. 2006a (MnSO <sub>4</sub> ) | Only absolute and relative organ weights were examined for the pituitary, liver, lung, kidney, heart, pancreas, hematocrit.               |
|                              |                      |   | Cardio  | 0.3 M                      | 1.5 M                             | (17% decrease in relative heart weight 90 days post-exposure)              |  |   |
|                              |                      |   | Hemato  | 0.3 M                      | 1.5 M                             | (decreased total bilirubin concentrations)                                 |  |   |
|                              |                      |   | Hepatic | 1.5 M                      |                                   |  |  |   |
|                              |                      |   | Renal   | 1.5 M                      |                                   |  |  |   |
|                              |                      |   | Endocr  | 1.5 M                      |                                   |  |  |   |
|                              |                      |   | Bd Wt   | 1.5 M                      |                                   |  |  |   |

\*\*\*DRAFT FOR PUBLIC COMMENT\*\*\*

Table 3-1 Levels of Significant Exposure to Inorganic Manganese - Inhalation

(continued)

| Key to Figure <sup>a</sup> | Species (Strain)     | Exposure/Duration/Frequency (Route) | System | NOAEL (mg/m <sup>3</sup> ) | LOAEL  |                              | Reference Chemical Form                                   | Comments  |
|----------------------------|----------------------|-------------------------------------|--------|----------------------------|--|------------------------------|---|---|
|                            |                      |                                     |        |                            | Less Serious (mg/m <sup>3</sup> )  | Serious (mg/m <sup>3</sup> ) |   |   |
| 10                         | Monkey (Rhesus)      | 10 mo<br>22 hr/d                    | Resp   |                            | 0.7 F (mild inflammation)  |                              | Suzuki et al. 1978<br>MnO <sub>2</sub>                    |   |
| 11                         | Monkey (NS)          | 9 mo<br>(continuous)                | Resp   | 1.1                        |  |                              | Ulrich et al. 1979a<br>Mn <sub>3</sub> O <sub>4</sub>     | No histopathological changes in lung or brain and no pulmonary function changes.            |
| 12                         | Rat (CD)             | 13 wk<br>6 h/d<br>5 d/wk            | Resp   | 0.1 M                      | 0.5 M (transient inflammatory changes in the nasal respiratory epithelium) |                              | Dorman et al. 2004b<br>(MnSO <sub>4</sub> )               | Inflammatory changes were no longer present 45 days after exposure period was over.         |
| 13                         | Rat (CD)             | 13 wk<br>6 h/d<br>5 d/wk            | Resp   | 0.1 M                      |  |                              | Dorman et al. 2004b<br>MnPO <sub>4</sub>                  | There were no lesions or inflammation observed in the nasal respiratory epithelium of rats. |
| 14                         | Rat (Sprague-Dawley) | 12 wk<br>6 h/d<br>5 d/wk            | Bd Wt  |                            | 0.11 M (12% decreased body weight)   |                              | El-Rahman 2004<br>hureaulite                              |   |
| 15                         | Rat (Sprague-Dawley) | 90 d<br>5 d/wk<br>6 hr/d            | Bd Wt  | 0.03 M                     | 0.3 M (10% decreased body weight)  |                              | Salehi et al. 2003<br>manganese phosphate/sulfate mixture |   |
| 16                         | Rat (Sprague-Dawley) | 90 d<br>5 d/wk<br>6 h/d             | Bd Wt  | 0.9 M                      |  |                              | Tapin et al. 2006<br>manganese sulfate dihydrate          |   |

\*\*\*DRAFT FOR PUBLIC COMMENT\*\*\*

3. HEALTH EFFECTS

MANGANESE

Table 3-1 Levels of Significant Exposure to Inorganic Manganese - Inhalation

(continued)

| Key to Figure <sup>a</sup> | Species (Strain)              | Exposure/Duration/Frequency (Route) | System  | NOAEL (mg/m <sup>3</sup> ) | LOAEL                             |   | Reference Chemical Form        | Comments   |
|----------------------------|-------------------------------|-------------------------------------|---------|----------------------------|-----------------------------------|---|--------------------------------|--|
|                            |                               |                                     |         |                            | Less Serious (mg/m <sup>3</sup> ) | Serious (mg/m <sup>3</sup> )  |                                |  |
| 17                         | Rat (NS)                      | 9 mo (continuous)                   | Resp    | 1.1                        |                                   |   | Ulrich et al. 1979b<br>Mn3O4   |  |
|                            |                               |                                     | Hemato  | 1.1                        |                                   |   |                                |  |
|                            |                               |                                     | Hepatic | 1.1                        |                                   |   |                                |  |
| 18                         | Rabbit (NS)                   | 4 wk<br>5 d/wk<br>6 hr/d            | Resp    | 3.9 M                      |                                   |   | Camner et al. 1985<br>MnCl2    |  |
| 19                         | Pigeon                        | 5 d/wk<br>5, 9, or 13 wk (IC)       | Hemato  |                            | 0.167                             | (decrease in total blood proteins (p<= 0.05) at 13 weeks of exposure that persisted 2 weeks after exposure ended) | Sierra et al. 1998<br>Mn3O4    |  |
| <b>20</b>                  | <b>Neurological</b><br>Monkey | 90 d<br>6 h/d<br>5 d/wk             |         | 1.5 M                      |                                   |   | Dorman et al. 2006a<br>(MnSO4) | Only absolute and relative brain weight were examined. |
| 21                         | Monkey (Rhesus)               | 90 d<br>6 h/d<br>5 d/wk             |         |                            | 0.06 M                            | (altered levels of GS, GLT-1 mRNA, GLAST, TH mRNA, GLT-1 mRNA, GLAST mRNA, and TH mRNA in the brain)              | Erikson et al. 2007<br>(MnSO4) |  |
| 22                         | Monkey (NS)                   | 9 mo (continuous)                   |         | 1.1                        |                                   |   | Ulrich et al. 1979a<br>Mn3O4   |  |

\*\*\*DRAFT FOR PUBLIC COMMENT\*\*\*



Table 3-1 Levels of Significant Exposure to Inorganic Manganese - Inhalation

(continued)

| Key to Figure <sup>a</sup> | Species (Strain)     | Exposure/Duration/Frequency (Route)  | System | NOAEL (mg/m <sup>3</sup> ) | LOAEL  |                               | Reference Chemical Form                  | Comments   |
|----------------------------|----------------------|--------------------------------------|--------|----------------------------|--|-------------------------------|--|--|
|                            |                      |                                      |        |                            | Less Serious (mg/m <sup>3</sup> )  | Serious (mg/m <sup>3</sup> )  |  |  |
| 23                         | Rat (CD)             | 13 wk<br>6 h/d<br>5 d/wk             |        | 0.5 M                      |  |                               | Dorman et al. 2004b (MnSO <sub>4</sub> ) | No changes in GFAP levels in the olfactory bulb, cerebellum, and striatum. |
| 24                         | Rat (CD)             | 13 wk<br>6 h/d<br>5 d/wk             |        | 0.1 M                      |  |                               | Dorman et al. 2004b MnPO <sub>4</sub>    | No changes in GFAP levels in the olfactory bulb, cerebellum, and striatum. |
| 25                         | Rat (Sprague-Dawley) | 12 wk<br>6 h/d<br>5 d/wk             |        |                            | 0.11 M (increased free amino acid contents; focal glial cell proliferation; astrocytic nodules)                          | 1.1 M (neuronal degeneration) | Ei-Rahman 2004 MnPO <sub>4</sub>         |  |
| 26                         | Rat (CD)             | Gd 0-19, pnd 1-18<br>6 h/d<br>7 d/wk |        |                            | 0.05 (decreased brain GS mRNA, MT mRNA and GSH levels in F1 females and decreased brain MT mRNA and GSH levels F1 males) |                               | Erikson et al. 2005 (MnSO <sub>4</sub> ) |  |

\*\*\*DRAFT FOR PUBLIC COMMENT\*\*\*

Table 3-1 Levels of Significant Exposure to Inorganic Manganese - Inhalation

(continued)

| Key to Figure | Species (Strain)     | Exposure/Duration/Frequency (Route)  | System | NOAEL (mg/m <sup>3</sup> ) | LOAEL                             |  | Reference Chemical Form                                | Comments  |
|---------------|----------------------|--------------------------------------|--------|----------------------------|-----------------------------------|--|--|---|
|               |                      |                                      |        |                            | Less Serious (mg/m <sup>3</sup> ) | Serious (mg/m <sup>3</sup> )   |  |   |
| 27            | Rat (CD)             | Gd 0-19, pnd 1-18<br>6 h/d<br>5 d/wk |        |                            | 0.05                              | (decreased brain GS and TH protein and mRNA, MT, and GSH and increased GSSG levels in F1 rats) | Erikson et al. 2006 (MnSO <sub>4</sub> )               |   |
| 28            | Rat (Sprague-Dawley) | 90 d<br>5 d/wk<br>6 h/d              |        | 1 M                        |                                   |  | Normandin et al. 2002 hureaulite                       | No differences in neuronal cell counts compared to controls, and no changes in locomotor and tremor assessments.                      |
| 29            | Rat (Sprague-Dawley) | 90 d<br>5 d/wk<br>6 hr/d             |        |                            | 0.03 M                            | (increased locomotor activity)   | Salehi et al. 2003 manganese phosphate/sulfate mixture | There was a significant increase in distance traveled, but not in rest time; increased exposure did not result in increased response. |
| 30            | Rat (Sprague-Dawley) | 90 d<br>5 d/wk<br>6 h/d              |        |                            | 3 M                               | (significant neuronal cell loss in the globus pallidus and caudate putamen)                    | Salehi et al. 2006 manganese phosphate/sulfate mixture |   |
| 31            | Rat (Sprague-Dawley) | 90 d<br>5 d/wk<br>6 h/d              |        |                            | 0.009 M                           | (increased locomotor activity)   | Tapin et al. 2006 manganese sulfate dihydrate          |   |

\*\*\*DRAFT FOR PUBLIC COMMENT\*\*\*

Table 3-1 Levels of Significant Exposure to Inorganic Manganese - Inhalation

(continued)

| Key to Figure        | Species <sup>a</sup> (Strain) | Exposure/Duration/Frequency (Route)  | System | NOAEL (mg/m <sup>3</sup> ) | LOAEL  |                              | Reference Chemical Form        | Comments                          |
|----------------------|-------------------------------|--------------------------------------|--------|----------------------------|--|------------------------------|--------------------------------|-----------------------------------|
|                      |                               |                                      |        |                            | Less Serious (mg/m <sup>3</sup> )  | Serious (mg/m <sup>3</sup> ) |                                |                                   |
| 32                   | Rat (NS)                      | 9 mo (continuous)                    |        | 1.1                        |  |                              | Ulrich et al. 1979b<br>Mn3O4   |                                   |
| 33                   | Mouse (Swiss ICR)             | 18 wk<br>5 d/wk<br>7 hr/d            |        |                            | 61 F (decreased maternal pup retrieval latency)  |                              | Lown et al. 1984<br>MnO2       |                                   |
| 34                   | Mouse (Swiss ICR)             | 16-32 wk<br>5 d/wk<br>7 hr/d         |        |                            | 72 M (increased open-field behavior)   |                              | Morganti et al. 1985<br>MnO2   |                                   |
| <b>Reproductive</b>  |                               |                                      |        |                            |  |                              |                                |                                   |
| 35                   | Monkey (Rhesus)               | 90 d<br>6 h/d<br>5 d/wk              |        | 1.5 M                      |  |                              | Dorman et al. 2006a<br>(MnSO4) | Only testes weight was examined.  |
| 36                   | Mouse (Swiss ICR)             | 18 wk<br>5 d/wk<br>7 hr/d            |        | 61 F                       |  |                              | Lown et al. 1984<br>MnO2       | No effect on number of pups born. |
| <b>Developmental</b> |                               |                                      |        |                            |  |                              |                                |                                   |
| 37                   | Rat (CD)                      | Gd 0-19, pnd 1-18<br>6 h/d<br>7 d/wk |        |                            | 0.05 (decreased brain GS mRNA, MT mRNA and GSH levels in F1 females and decreased brain MT mRNA and GSH levels F1 males) |                              | Erikson et al. 2005<br>(MnSO4) |                                   |

\*\*\*DRAFT FOR PUBLIC COMMENT\*\*\*

Table 3-1 Levels of Significant Exposure to Inorganic Manganese - Inhalation

(continued)

| Key to Figure <sup>a</sup> | Species (Strain) | Exposure/Duration/Frequency (Route)          | System | NOAEL (mg/m <sup>3</sup> ) | LOAEL                             |  | Reference Chemical Form                 | Comments                                 |
|----------------------------|------------------|--|--------|----------------------------|-----------------------------------|--|---|--|
|                            |                  |  |        |                            | Less Serious (mg/m <sup>3</sup> ) | Serious (mg/m <sup>3</sup> )   |   |  |
| 38                         | Rat (CD)         | Gd 0-19, pnd 1-18 6 h/d 5 d/wk               |        |                            | 0.05                              | (decreased brain GS and TH protein and mRNA, MT, and GHS and increased GSSG levels in F1 rats) |   | Erikson et al. 2006 (MnSO <sub>4</sub> ) |
| <b>CHRONIC EXPOSURE</b>    |                  |  |        |                            |                                   |  |   |  |
| <b>Systemic</b>            |                  |  |        |                            |                                   |  |   |  |
| 39                         | Human            | 7.5 yr (average duration in Mn mine) (occup) | Resp   |                            | 90 M                              | (increased respiratory symptoms and prevalence of subjects with impaired pulmonary function)   |   | Boojar and Goodarzi 2002                 |
| 40                         | Human            | NS (occup)                                   | Resp   |                            |                                   |  | 3.6 M (pneumonia)                       | Lloyd Davies 1946 MnO <sub>2</sub>       |
| 41                         | Human            | 1-19 yr (occup)                              | Resp   |                            |                                   |  | 0.97 M (cough, decreased lung function) | Roels et al. 1987a Mn salts and oxides   |
|                            |                  |  | Hemato | 0.97 M                     |                                   |  |   |  |
| 42                         | Human            | 5.3 yr (occup)                               | Resp   | 0.18                       |                                   |  |   | Roels et al. 1992 MnO <sub>2</sub>       |
|                            |                  |  | Endocr | 0.18                       |                                   |  |   |  |

\*\*\*DRAFT FOR PUBLIC COMMENT\*\*\*

Table 3-1 Levels of Significant Exposure to Inorganic Manganese - Inhalation

(continued)

| Key to Figure <sup>a</sup> | Species (Strain) | Exposure/Duration/Frequency (Route)                    | System | NOAEL (mg/m <sup>3</sup> ) | LOAEL   |                              | Reference Chemical Form    | Comments   |
|----------------------------|------------------|--|--------|----------------------------|---|------------------------------|----------------------------|--|
|                            |                  |  |        |                            | Less Serious (mg/m <sup>3</sup> )   | Serious (mg/m <sup>3</sup> ) |                            |  |
| 43                         | Monkey (Rhesus)  | 66 wk  | Hemato | 0.1                        |   |                              | EPA 1977<br>Mn3O4          |  |
| <b>Neurological</b>        |                  |  |        |                            |   |                              |                            |  |
| 44                         | Human            | 24 yr (median employment in steel plant) (occup)       |        |                            | 0.07 M (longitudinal analysis showed impaired ability to perform fast pronation/supination of the hands and fast finger tapping compared with controls) |                              | Blond and Netterstrom 2007 | No impairments of slow hand and finger movements or increased tremor intensity were observed compared with controls. |
| 45                         | Human            | 24 yr (median employment in steel plant)               |        | 0.07 M                     |   |                              | Blond et al. 2007          | Cognitive function could not be distinguished between Mn-exposed steel workers and controls.                         |
| 46                         | Human            | 19.3 yr (average employment in Mn alloy plant) (occup) |        |                            | 0.23 M (increased Mn impairment with age in 1/9 neuromotor tests, 3/12 cognitive tests, and 1 or 4 sensory tests)                                       |                              | Bouchard et al. 2005       |  |

\*\*\*DRAFT FOR PUBLIC COMMENT\*\*\*

MANGANESE

3. HEALTH EFFECTS

Table 3-1 Levels of Significant Exposure to Inorganic Manganese - Inhalation

(continued)

| Key to Figure <sup>a</sup> | Species (Strain) | Exposure/Duration/Frequency (Route)                            | System | NOAEL (mg/m <sup>3</sup> ) | LOAEL  |                                     | Reference Chemical Form              | Comments   |
|----------------------------|------------------|--|--------|----------------------------|--|-------------------------------------|--------------------------------------|--|
|                            |                  |  |        |                            | Less Serious (mg/m <sup>3</sup> )  | Serious (mg/m <sup>3</sup> )        |                                      |  |
| 47                         | Human            | 15.7 yr (average employment) (occup)                           |        |                            | 0.23 M (significantly higher scores for 2 [depression, anxiety] of 9 neuropsychiatric symptoms)                          |                                     | Bouchard et al. 2007a                |  |
| 48                         | Human            | 15.3 yr (average employment) (Occup)                           |        |                            | 0.23 M (impaired performance on 1/5 neuromotor tests and enhanced score for 1 [confusion-bewilderment] of 6 mood states) |                                     | Bouchard et al. 2007b                | Follow-up to Mergler et al. 1994; no significant (p<0.05) differences between exposed and controls in 9 cognitive tests. |
| 49                         | Human            | 1.1-15.7 yr (occup)  |        |                            | 1.59 M (postural sway with eyes closed)  |                                     | Chia et al. 1995<br>MnO <sub>2</sub> |  |
| 50                         | Human            | NS (occup)   |        |                            |  | 22 M (bradykinesia, mask-like face) | Cook et al. 1974<br>NS               |  |
| 51                         | Human            | 19.87 yr; mean (SD±9) employment in enamels production (occup) |        | 2.05                       |  |                                     | Deschamps et al. 2001                | No significant effects on blood levels of Mn or tests of cognition. Tests of neuromotor functions were not conducted.    |

\*\*\*DRAFT FOR PUBLIC COMMENT\*\*\*

Table 3-1 Levels of Significant Exposure to Inorganic Manganese - Inhalation

(continued)

| Key to Figure <sup>a</sup> | Species (Strain) | Exposure/Duration/Frequency (Route) | System | NOAEL (mg/m <sup>3</sup> ) | LOAEL   |                              | Reference   | Chemical Form | Comments |
|----------------------------|------------------|-------------------------------------|--------|----------------------------|---|------------------------------|---|---------------|----------|
|                            |                  |                                     |        |                            | Less Serious (mg/m <sup>3</sup> )   | Serious (mg/m <sup>3</sup> ) |   |               |          |
| 52                         | Human            | 12.7 yr (mean) (occup)              |        | 0.051                      |   |                              | Gibbs et al. 1999<br>NS   |               |          |
| 53                         | Human            | 1-35 yr (2.6 median) (occup)        |        |                            | 0.14 M (decreased reaction time, finger tapping)  |                              | Iregren 1990<br>MnO <sub>2</sub>  |               |          |
| 54                         | Human            | 1-28 yr                             |        |                            | 0.149 M (decreased neurobehavioral performance finger tapping, symbol digit, digit span, additions) |                              | Lucchini et al. 1995<br>(primarily MnO <sub>2</sub> ) (MnOx - Mn oxides)  |               |          |
| 55                         | Human            | 11.5 yr (mean) (occup)              |        |                            | 0.0967 M (decreased performance on neurobehavioral exams)   |                              | Lucchini et al. 1999<br>MnO <sub>2</sub> , Mn <sub>3</sub> O <sub>4</sub> |               |          |
| 56                         | Human            | 16.7 yr (mean) (occup)              |        |                            | 0.032 M (decreased motor function)  |                              | Mergler et al. 1994<br>NS   |               |          |

\*\*\*DRAFT FOR PUBLIC COMMENT\*\*\*

Table 3-1 Levels of Significant Exposure to Inorganic Manganese - Inhalation

(continued)

| Key to Figure <sup>a</sup> | Species (Strain) | Exposure/Duration/Frequency (Route)                       | System | NOAEL (mg/m <sup>3</sup> ) | LOAEL   |                              | Reference Chemical Form                                       | Comments  |
|----------------------------|------------------|---|--------|----------------------------|---|------------------------------|---|---|
|                            |                  |   |        |                            | Less Serious (mg/m <sup>3</sup> )   | Serious (mg/m <sup>3</sup> ) |   |   |
| 57                         | Human            | 10.8 yr (mean employment in Mn mines) (occup)             |        | 0.21                       |   |                              | Myers et al. 2003a  | No associations between measures of exposure and neurobehavioral endpoints were found: 3 motor function and 3 cognitive tests.                      |
| 58                         | Human            | 18.2 yr; mean (SD 7.6) employment in a Mn smelter (occup) |        | 0.85                       |   |                              | Myers et al. 2003b  | Neurobehavioral test batteries showed significant effects, only in a few endpoints and little evidence of positive exposure-response relationships. |
| 59                         | Human            | 1-19 yr (occup)   |        |                            | 0.97 M (altered reaction time, short-term memory, decreased hand steadiness)          |                              | Roels et al. 1987a<br>Mn salts and oxides                     |   |
| 60                         | Human            | 5.3 yr (occup)  |        |                            | 0.179 <sup>b</sup> (impaired visual time, eye-hand coordination, and hand steadiness) |                              | Roels et al. 1992<br>MnO <sub>2</sub>                         |   |
| 61                         | Human            | NS (occup)  |        |                            |   |                              | 2.6 M (tremor, decreased reflexes)<br>Saric et al. 1977<br>NS |   |

\*\*\*DRAFT FOR PUBLIC COMMENT\*\*\*



Table 3-1 Levels of Significant Exposure to Inorganic Manganese - Inhalation

(continued)

| Key to Figure <sup>a</sup> | Species (Strain) | Exposure/Duration/Frequency (Route) | System | NOAEL (mg/m <sup>3</sup> ) | LOAEL                             |                              | Reference Chemical Form  | Comments                                    |
|----------------------------|------------------|-------------------------------------|--------|----------------------------|-----------------------------------|------------------------------|--|---|
|                            |                  |                                     |        |                            | Less Serious (mg/m <sup>3</sup> ) | Serious (mg/m <sup>3</sup> ) |  |   |
| 62                         | Human            | 1-9 yr (occup)                      |        |                            |                                   |                              | 6 M (psychomotor disturbances, weakness, pain)   | Schuler et al. 1957<br>MnO <sub>2</sub>     |
| 63                         | Human            | NS (occup)                          |        |                            |                                   |                              | 5 M (weakness, ataxia, pain)   | Tanaka and Lieben 1969<br>NS                |
| 64                         | Human            | 1 yr (occup)                        |        |                            |                                   |                              | 3.5 M (weakness, anorexia, ataxia)   | Whitlock et al. 1966<br>NS                  |
| 65                         | Monkey (Rhesus)  | 2 yr<br>5 d/wk<br>6 hr/d            |        |                            | 30 F (altered DOPA levels)        |                              |  | Bird et al. 1984<br>MnO <sub>2</sub>        |
| 66                         | Monkey (Rhesus)  | 66 wk                               |        | 0.1                        |                                   |                              |  | EPA 1977<br>Mn <sub>3</sub> O <sub>4</sub>  |
| <b>Reproductive</b>        |                  |                                     |        |                            |                                   |                              |  |   |
| 67                         | Human            | 1-19 yr (occup)                     |        |                            |                                   |                              | 0.97 M (decreased fertility in males as assessed by number of observed vs expected children) | Lauwerys et al. 1985<br>Mn salts and oxides |
| 68                         | Human            | at least 1 yr (occup)               |        |                            |                                   |                              | 2.82 M (abnormal sperm)  | Wu et al. 1996<br>(MnO <sub>2</sub> )       |

\*\*\*DRAFT FOR PUBLIC COMMENT\*\*\*

Table 3-1 Levels of Significant Exposure to Inorganic Manganese - Inhalation

(continued)

| Key to Figure | Species (Strain) | Exposure/Duration/Frequency (Route) | System | NOAEL (mg/m <sup>3</sup> ) | LOAEL                             |                              | Reference Chemical Form | Comments                  |
|---------------|------------------|-------------------------------------|--------|----------------------------|-----------------------------------|------------------------------|-------------------------|---------------------------|
|               |                  |                                     |        |                            | Less Serious (mg/m <sup>3</sup> ) | Serious (mg/m <sup>3</sup> ) |                         |                           |
| 69            | Human            | at least 1 yr (occup)               |        |                            |                                   |                              | 44.4 M (abnormal sperm) | Wu et al. 1996 (Mn fumes) |

All doses expressed as mg manganese/m<sup>3</sup>.

a The number corresponds to entries in Figure 3-1.

b The chronic-duration inhalation minimal risk level (MRL) of 0.0003 mg manganese/m<sup>3</sup> was derived by using a benchmark dose analysis BMDL10 (surrogate NOAEL) of 0.142 mg manganese/m<sup>3</sup> for performance deficits in several neurobehavioral tests. This value was adjusted using the following uncertainty and modifying factors: 10 for human variability, 5/7 for intermittent exposure (5 days/week), 8/24 for intermittent exposure (8 hours/day), and 10 for potential differences in toxicity due to the different forms of manganese and other limitations in the database.

APP = amyloid precursor protein; Bd Wt = body weight; Cardio = cardiovascular; COX = cyclooxygenase; d = day(s); DOPA = dihydroxyphenylalanine; Endocr = endocrine; F = Female; Gd = gestational day; GFAP = glial fibrillary acidic protein; GLAST = glutamate/aspartate transporter; GLT-1= glutamate transporter-1; Gn pig = guinea pig; GS = glutamine synthetase; GSH = reduced glutathione; GSSG = oxidized glutathione; Hemato = hematological; hr = hour(s); Immuno/Lymphoret = immunological/lymphoreticular; LOAEL = lowest-observed-adverse-effect level; M = male; mo = month(s); mRNA = messenger ribonucleic acid; MT = metallothionein; nNOS = neuronal nitric oxide synthase; NOAEL = no-observed-adverse-effect level; NS = not specified; occup = occupational; pnd = post-natal day; Resp = respiratory; TGF-beta = transforming growth factor beta; TH = tyrosine hydroxylase; wk = week(s); yr = year(s)

\*\*\*DRAFT FOR PUBLIC COMMENT\*\*\*

Figure 3-1 Levels of Significant Exposure to Inorganic Manganese - Inhalation  
Acute (≤14 days)

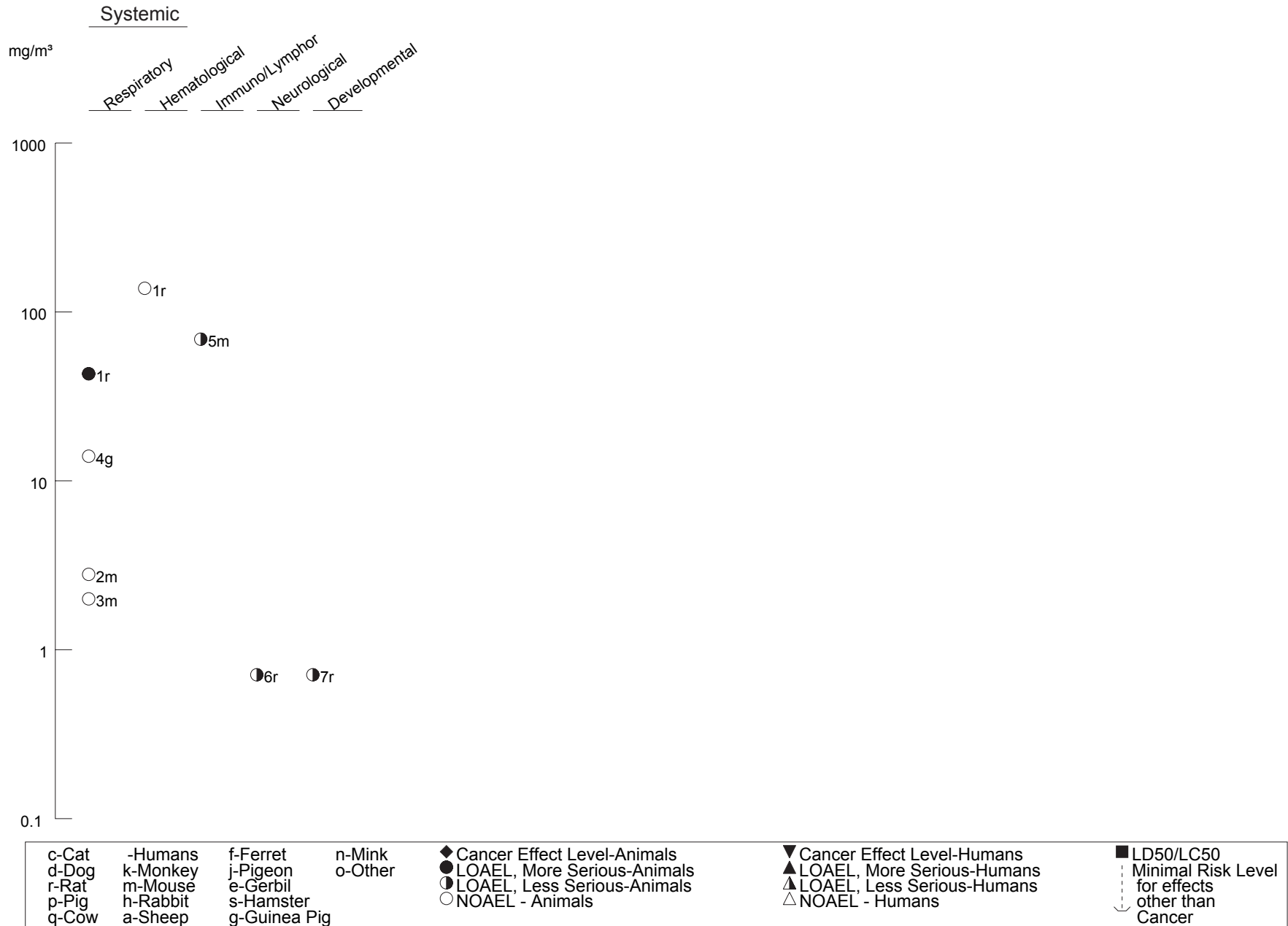

\*\*\*DRAFT FOR PUBLIC COMMENT\*\*\*

Figure 3-1 Levels of Significant Exposure to Inorganic Manganese - Inhalation (Continued)

Intermediate (15-364 days)

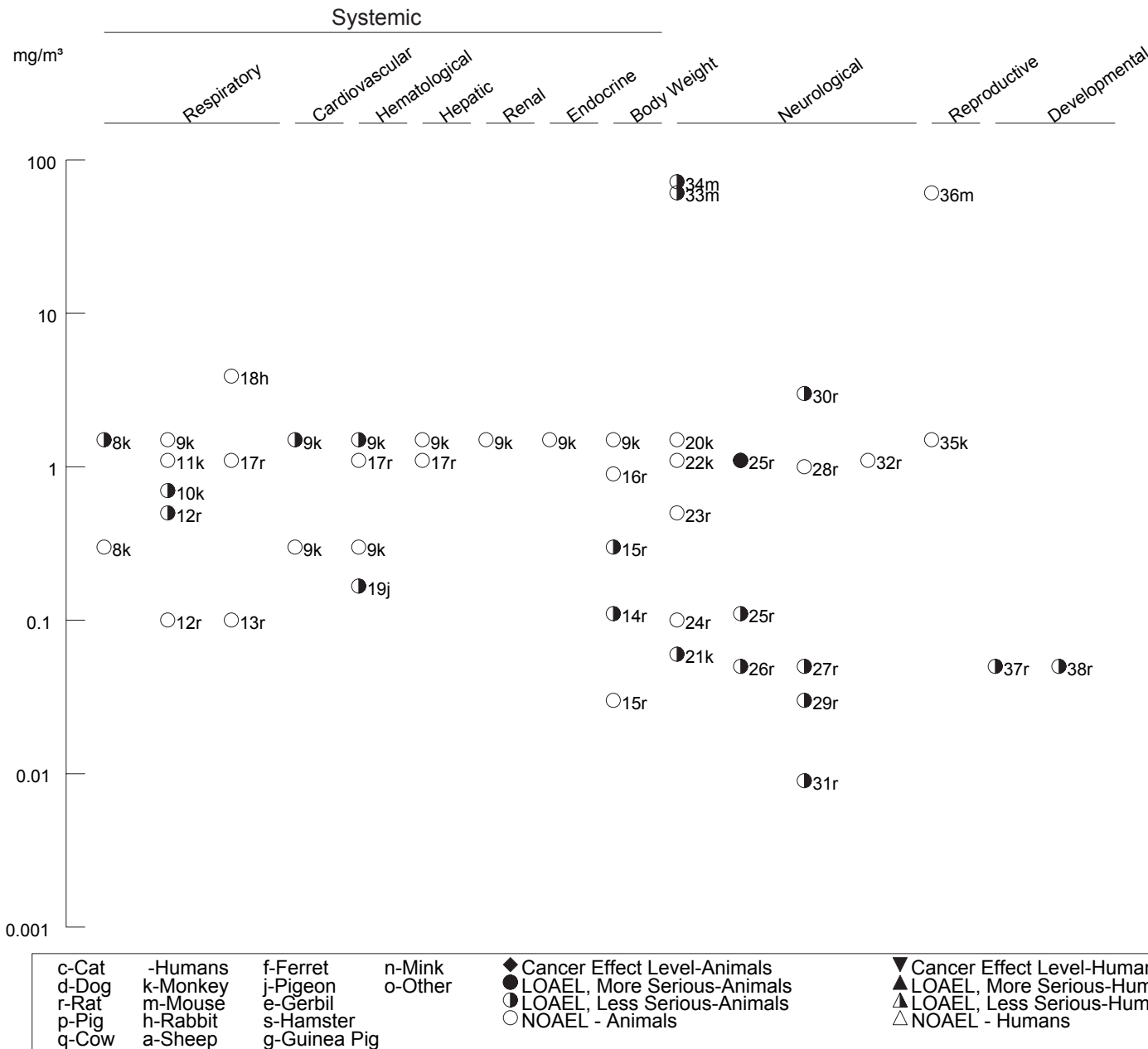

\*\*\*DRAFT FOR PUBLIC COMMENT\*\*\*

Figure 3-1 Levels of Significant Exposure to Inorganic Manganese - Inhalation (Continued)

Chronic (≥365 days)

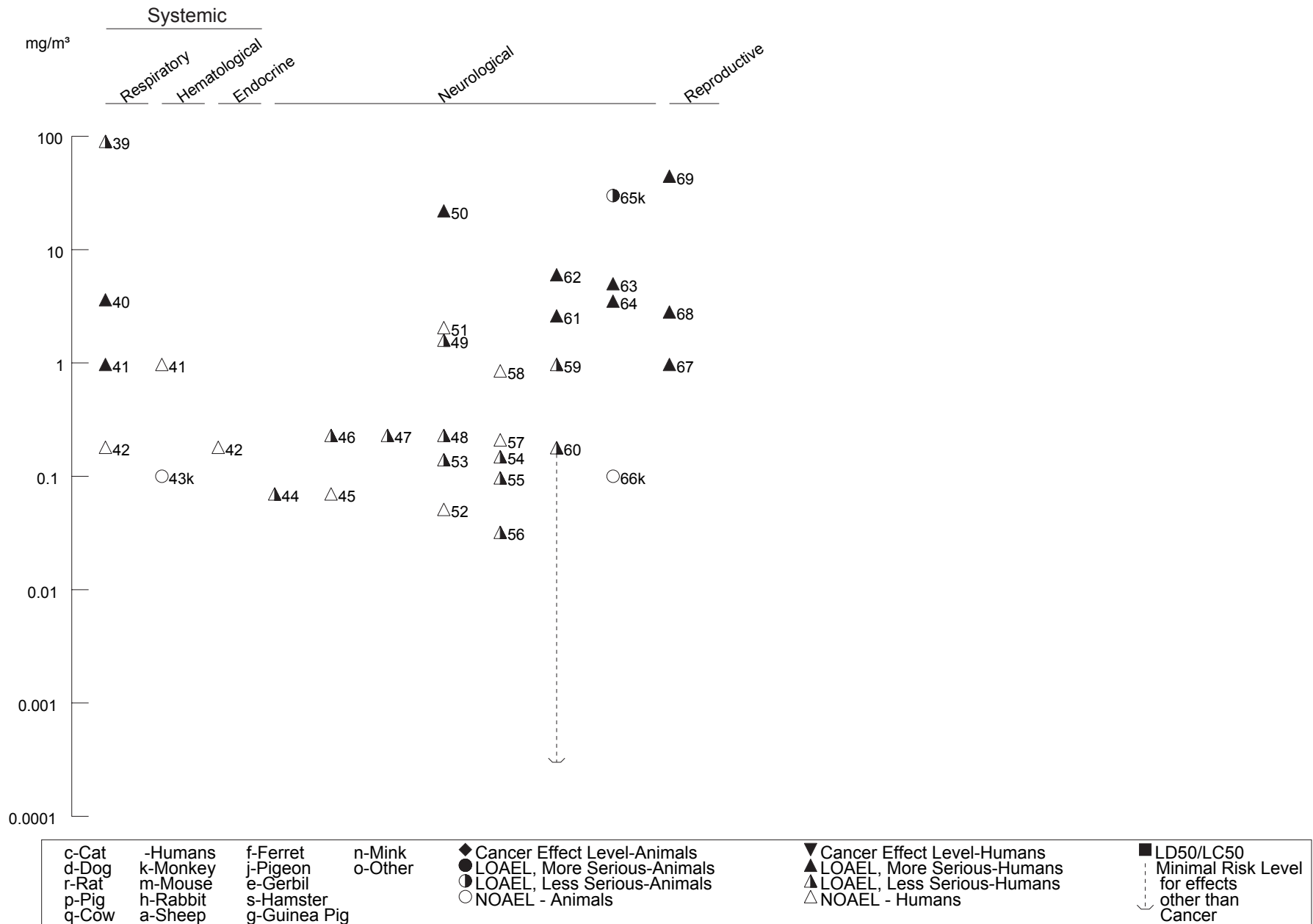

### 3. HEALTH EFFECTS

liver. Total dust represents larger particles that cannot travel as deeply into the lungs as respirable dust, and will largely be coughed up and swallowed. Although many of the recent occupational studies have provided information on the size of the respirable particles that are associated with the exposure levels documented, some of the occupational studies and historical studies in miners only measure total dust. The profile provides, where possible, the different exposure levels in terms of respirable and total dust, but does not make a further distinction between particle sizes of the respirable dust.

#### 3.2.1.1 Death

No conclusive studies have been located that show inhalation exposure of humans to manganese resulting in death. Hobbesland et al. (1997a) investigated nonmalignant respiratory diseases as a cause of death in male ferromanganese and silicomanganese workers. The authors found a slight excess in the numbers of deaths caused by pneumonia for manganese furnace workers, but could not discount other work-related exposures as potential causes of the pneumonia.

In analyses performed several years ago, MMT in gasoline was found to combust primarily to manganese tetroxide, but in the low levels currently used in gasolines, it is primarily combusted to manganese phosphate and manganese sulfate (Lynam et al. 1999). Therefore, inhalation exposures to exhaust from gasoline containing MMT will be discussed with inorganic manganese exposures. No deaths were observed in male outbred albino rats and male golden hamsters exposed to the exhaust (either irradiated or non-irradiated) from automobiles that were fueled with MMT-containing gasoline (Moore et al. 1975).

No other studies were located regarding death in humans or animals after inhalation exposure to inorganic manganese.

MMT has been used in very few inhalation studies due to the photolability of the compound; its short half-life in air makes it a very difficult compound to administer to laboratory animals in exposure chambers or nose-cones. Hinderer (1979) evaluated the toxicity of various unspecified MMT concentrations administered to 10 male Sprague-Dawley rats per exposure group during 1- and 4-hour exposure periods. The inhalation LD<sub>50</sub> was determined to be 62 mg manganese/m<sup>3</sup> (247 mg MMT/m<sup>3</sup>\*55 mg manganese/218.1 mg MMT=62 mg manganese/m<sup>3</sup>) for a 1-hour exposure and 19 mg manganese/m<sup>3</sup> for a 4-hour exposure. No mention was made in the report of steps taken to prevent MMT photodegradation during the experiment.

## 3. HEALTH EFFECTS

**3.2.1.2 Systemic Effects**

The highest NOAEL values and all LOAEL values from each reliable study for (systemic effects in each species and duration category) are recorded in Table 3-1 and plotted in Figure 3-1.

**Respiratory Effects.** In humans, inhalation of particulate manganese compounds such as manganese dioxide or manganese tetroxide can lead to an inflammatory response in the lung. This is characterized by an infiltration of macrophages and leukocytes, which phagocytize the deposited manganese particles (Lloyd Davies 1946). Damage to lung tissue is usually not extensive, but may include local areas of edema (Lloyd Davies 1946). Symptoms and signs of lung irritation and injury may include cough, bronchitis, pneumonitis, and minor reductions in lung function (Abdel-Hamid et al. 1990; Akbar-Khanzadeh 1993; Boojar and Goodarzi 2002; Lloyd Davies 1946; Roels et al. 1987a); occasionally, pneumonia may result (Lloyd Davies 1946). These effects have been noted mainly in people exposed to manganese dust under occupational conditions, although there is some evidence that respiratory effects may also occur in residential populations near ferromanganese factories (Kagamimori et al. 1973; Nogawa et al. 1973; WHO 1987). The frequency of effects has been shown to decrease in at least one population when concentrations of total manganese in falling dust declined (Kagamimori et al. 1973). It is likely that the inflammatory response begins shortly after exposure and continues for the duration of the exposure.

It is important to note that an inflammatory response of this type is not unique to manganese-containing particles, but is characteristic of nearly all inhalable particulate matter (EPA 1985d). This suggests that it is not the manganese *per se* that causes the response, but more likely the particulate matter itself.

An increased prevalence of pneumonia has also been noted in some studies of workers with chronic occupational exposure to manganese dust (Lloyd Davies 1946) and in residents near a ferromanganese factory (WHO 1987). It seems likely that this increased susceptibility to pneumonia is mainly secondary to the lung irritation and inflammation caused by inhaled particulate matter, as discussed above.

Inhalation of particulate manganese compounds such as manganese dioxide or manganese tetroxide also leads to an inflammatory response in the lungs of animals, although inhalation of manganese chloride did not cause lung inflammation in rabbits (Camner et al. 1985). Several acute- and intermediate-duration studies in animals report various signs of lung inflammation following periods ranging from 1 day to 10 months at manganese concentrations ranging from 0.7 to 69 mg/m<sup>3</sup> (Bergstrom 1977; Camner et al.

## 3. HEALTH EFFECTS

1985; Shiotsuka 1984; Suzuki et al. 1978; Ulrich et al. 1979a, 1979b). Bergstrom (1977) and Ulrich et al. (1979a, 1979b) determined NOAELs, which are reported in Table 3-1. Increased susceptibility to lung infection by bacterial pathogens following inhalation of manganese dusts has been noted in acute animal studies (Maigetter et al. 1976). Conversely, Lloyd Davies (1946) reported no increase in the susceptibility of manganese-treated mice to pneumococci or streptococci. Bredow et al. (2007) reported that nose-only inhalation exposure to 2 mg manganese/m<sup>3</sup> as manganese chloride aerosols 6 hours/day for 5 consecutive days did not cause lung lesions in female GVB/N mice, but induced a 2-fold increase in pulmonary levels of mRNA for vascular endothelial growth factor (VGEF), a regulator of proliferation, migration, and formation of new capillaries. Elevated levels of VGEF have been associated with respiratory diseases, but current understanding is inadequate to know if this pulmonary gene expression response to manganese is adverse or benign.

Moore et al. (1975) exposed male golden hamsters and outbred albino rats to automobile exhaust from a car that burned MMT-containing fuel. The animals were exposed to non-irradiated exhaust or irradiated exhaust; the irradiation served to convert hydrocarbon gases and vapors to particulate form. Controls for each species were exposed to clean air. The animals were exposed for 8 hours/day for 56 consecutive days. While the hamsters were fed a diet containing an adequate amount of manganese for normal development, the rats were divided into two groups: one group was fed a manganese-sufficient diet (42.2 µg manganese/g diet) and the other group was fed a manganese-deficient diet (5 µg manganese/g diet). After the exposure, the authors observed a thickening of the cuboidal epithelium at the level of the terminal bronchiole in the golden hamsters. The lesion was not classified as severe and only affected one to two sites per lung section. Further, the lesions did not increase with length of exposure to the exhaust products (from 1 to 9 weeks). The incidence of lesions in the lung was 21% after exposure to irradiated exhaust, 14% after exposure to non-irradiated exhaust, and 6% after exposure to clean air.

More recently, reversible inflammation (pleocellular inflammatory infiltrates and fibrinonecrotic debris) in the nasal respiratory epithelium (but not the olfactory epithelium) was observed in young adult male CrI:CD(SD)BR rats following 13 weeks of inhalation exposure to 0.5 mg manganese/m<sup>3</sup> as manganese sulfate, but not in rats exposed to 0.1 mg manganese/m<sup>3</sup> as manganese sulfate or manganese phosphate (hureaulite) (Dorman et al. 2004b). The lesions were not apparent in groups of rats assessed 45 days after the end of exposure, indicating their transient nature. In studies with young male Rhesus monkeys exposed to 0, 0.06, 0.3, or 1.5 mg manganese/m<sup>3</sup> as manganese sulfate 6 hours/day, 5 days/week for 65 days, no nasal histological effects were found in exposed monkeys, but the high exposure level induced lesions in the lower respiratory tract (mild subacute bronchiolitis, alveolar duct inflammation,



## 3. HEALTH EFFECTS

and proliferation of bronchus-associated lymphoid tissue) (Dorman et al. 2005b). The lower airway lesions from intermediate-duration exposure appear to have been transient, because they were not found in monkeys assessed 45 days after the end of exposure (Dorman et al. 2005b). These findings in rats and monkeys are consistent with the understanding that inflammation of respiratory tissues from high-level exposure to inhaled manganese particulates is likely a consequence of the inhaled particulate matter.

No studies were located concerning respiratory effects in humans following inhalation exposure to MMT.

Male rats exposed to high concentrations of MMT (exposure doses not reported) via inhalation exhibited labored breathing during and after 1- and 4-hour exposures (Hinderer 1979). Gross necropsy or histopathological analyses on these animals were not performed.

**Cardiovascular Effects.** Three studies reported adverse cardiovascular effects after occupational exposure to manganese. Saric and Hrustic (1975) observed a lower mean systolic blood pressure in male workers at a ferromanganese plant. Manganese concentrations in the plant ranged from 0.4 to 20 mg/m<sup>3</sup>, but specific data on exposure levels were lacking. More recently, Jiang et al. (1996a) studied the potential cardiotoxicity of manganese dioxide exposure in 656 workers (547 males, 109 females) involved in manganese milling, smelting, and sintering. The authors took 181 samples of airborne manganese (not specified if respirable or total dust), with a geometric mean of 0.13 mg/m<sup>3</sup>. The workers, whose work tenure ranged from 0 to 35 years, had a greater incidence of low diastolic blood pressure. The incidence of this effect was highest in young workers with the lowest tenure in the plant. There was no increase of abnormal electrocardiograms between workers and their matched controls. The authors surmised that manganese's ability to lower the diastolic blood pressure weakens with age as the elasticity of the blood vessels deteriorates.

Hobbesland et al. (1997b) reported a significantly increased incidence in sudden death mortality for workers in ferromanganese/silicomanganese plants during their employment period (standardized mortality ratio [SMR]=2.47). The sudden deaths included cardiac deaths and other natural causes. More specifically, among furnace workers, who are more likely to be exposed to manganese fumes and dusts than non-furnace workers, the mortality during active-person time was statistically significantly elevated (38.7%) compared to non-furnace workers (23.3%; p<0.001). However, the authors caution that the association of increased death and manganese exposure is speculative and the increase in sudden death could also be caused by common furnace work conditions (heat, stress, noise, carbon monoxide, etc.).

## 3. HEALTH EFFECTS

No studies on cardiovascular effects from inhalation exposure to MMT in humans or animals were located.

**Gastrointestinal Effects.** There are no reports of gastrointestinal effects following inhalation exposure to inorganic manganese in humans or animals.

There are no reports concerning the gastrointestinal effects following inhalation exposure to MMT in humans or animals.

**Hematological Effects.** Examination of blood from persons chronically exposed to high levels of manganese in the workplace has typically not revealed any significant hematological effects (Mena et al. 1967; Roels et al. 1987a; Smyth et al. 1973; Whitlock et al. 1966). The effect of manganese exposure on erythrocyte superoxide dismutase activity remains inconsistent; some investigators observed increased activity among male manganese smelters (Yiin et al. 1996), while others reported decreased activity in male welders (Li et al. 2004). However, an increased plasma malondialdehyde level is consistent between manganese-exposed smelters (Yiin et al. 1996) and welders (Li et al. 2004). Malondialdehyde is a product of lipid peroxidation; lipid peroxidation is believed to be a mechanism for cell toxicity. The authors observed that plasma malondialdehyde and manganese levels were strongly correlated in exposed workers and interpreted this response to be an indicator of manganese toxicity via lipid peroxidation.

No studies on hematological effects from inhalation exposure to MMT in humans or animals were located.

**Hepatic Effects.** Even though the liver actively transports manganese from blood to bile (see Section 3.4.4), there is no information to indicate that the liver is adversely affected by manganese; however, there are few specific studies on this subject. In a study by Mena et al. (1967), workers chronically exposed to manganese dust in the workplace exhibited no abnormalities in serum levels of alkaline phosphatase. Of 13 patients who were hospitalized with chronic manganese poisoning, 1 had a 20% sulfobromophthalein (SBP) retention and 1 had a 12% SBP retention, although histological examination of a liver biopsy from the latter revealed no abnormal tissue (Mena et al. 1967). No significance was ascribed to the elevated SBP retention.

## 3. HEALTH EFFECTS

Rats exposed to manganese tetroxide dusts for 9 months exhibited no adverse effects or histopathological lesions; however, slight increases in liver weights were noted (Ulrich et al. 1979b). These data, although limited, indicate that the liver is not significantly injured by manganese.

No studies on hepatic effects from inhalation exposure to MMT in humans or animals were located.

**Musculoskeletal Effects.** No studies were located concerning musculoskeletal effects from inhalation exposure to inorganic manganese.

No studies were located concerning musculoskeletal effects from inhalation exposure to MMT in humans or animals.

**Renal Effects.** The kidney is not generally considered to be a target for manganese, but specific studies are rare. No abnormalities in urine chemistry were detected in workers chronically exposed to manganese dusts in the workplace (Mena et al. 1967), but other more sensitive tests of renal function were not performed.

No studies were located regarding renal effects in animals after inhalation exposure to inorganic manganese.

No studies on renal effects from inhalation exposure to MMT in humans or animals were located.

**Endocrine Effects.** Few studies have measured endocrine effects in humans exposed to inorganic manganese. Two studies measured hormonal levels after exposure to manganese. The first study (Alessio et al. 1989) involved chronic exposure of foundry workers to manganese for approximately 10 years. The exposure levels were reported as 0.04–1.1 mg manganese/m<sup>3</sup> (particulate matter) and 0.05–0.9 mg/m<sup>3</sup> as fumes. These levels overlap the current American Congress of Governmental Industrial Hygiene (ACGIH) threshold limit value-time weighted average (TLV-TWA) of 0.2 mg/m<sup>3</sup> for particulate, but are less than the limit of 1 mg/m<sup>3</sup> for manganese fumes. The study reported both elevated prolactin levels and elevated cortisol levels; however, no changes in the levels of follicle stimulating hormone (FSH) and luteinizing hormone (LH) were noted.

Smargiassi and Mutti (1999) reported effects in a group of workers from a ferroalloy plant who were exposed occupationally to elevated levels of airborne manganese. Serum prolactin levels in these workers

## 3. HEALTH EFFECTS

were evaluated in a 1992 study and again in a 1997 study. Serum prolactin levels, which were significantly elevated in the earlier analysis, had also increased significantly over the earlier measurement ( $p < 0.001$ ). This difference was especially noticeable in those with abnormally high prolactin levels. During the five year period between studies, exposure levels were consistent and were not reduced; therefore, it is unclear whether prolactin levels reflect current or cumulative exposure.

Other elements of endocrine function (reproductive function, etc.) are discussed elsewhere in the text.

No studies were located regarding endocrine effects in animals after inhalation exposure to inorganic manganese.

No studies on endocrine effects from inhalation exposure to MMT in humans or animals were located.

**Dermal Effects.** No studies have been located concerning dermal effects in humans or animals following inhalation exposure to inorganic or organic manganese.

**Ocular Effects.** No studies have been located concerning ocular effects in humans or animals following inhalation exposure to inorganic manganese.

There are no studies reporting ocular effects following inhalation exposure of humans to MMT. One- and 4-hour exposures to doses of MMT used in lethality studies resulted in conjunctivitis in rats (Hinderer 1979).

**Body Weight Effects.** No studies were located regarding body weight effects in humans following exposures to inorganic manganese.

No studies were located regarding body weight effects in humans following inhalation exposure to MMT. Hinderer (1979) observed a decrease in weight gain in Sprague-Dawley rats during the first 7 days following a 1- or 4-hour exposure to unspecified MMT concentrations in an acute toxicity test. The rats resumed their normal weight gain by 14 days post-exposure.

**Metabolic Effects.** No studies were located concerning metabolic effects from inhalation of inorganic manganese in humans or animals.

### 3. HEALTH EFFECTS

No studies were located concerning metabolic effects following inhalation exposure to MMT in humans or animals.

#### **3.2.1.3 Immunological and Lymphoreticular Effects**

One study on immunological effects in humans following inhalation to inorganic manganese was located. Male welders exposed to manganese (0.29–0.64 mg/m<sup>3</sup> for an unspecified duration), vibration, and noise exhibited suppression of the T and B lymphocytes characterized by reductions in serum immunoglobulin G (IgG) and total E-rosette-forming cells (Boshnakova et al. 1989). However, the welders in this study were exposed to numerous other compounds, including cobalt, carbon dioxide, and nitric oxide. Therefore, it is impossible to determine whether exposure to manganese caused the effects. It is not known whether any of these changes are associated with significant impairment of immune system function. No studies were located on lymphoreticular effects in humans exposed to manganese by the inhalation route.

No studies were located on immunological or lymphoreticular effects in animals exposed to inorganic manganese by the inhalation route.

As noted above, inhalation exposure to particulate manganese compounds can lead to an inflammatory response in the lung (i.e., pneumonitis), and this is accompanied by increased numbers of macrophages and leukocytes in the lung (Bergstrom 1977; Lloyd Davies 1946; Shiotsuka 1984; Suzuki et al. 1978). However, this is an expected adaptive response of the immune system to inhaled particulates, and these data do not indicate that the immune system is injured. Conflicting data are reported concerning increased susceptibility to bacterial infection after exposure to airborne manganese. Lloyd Davies (1946) indicated that manganese exposure did not increase the susceptibility of mice to bacterial infection, whereas Maigetter et al. (1976) reported that exposure to aerosolized manganese dioxide altered the resistance of mice to bacterial and viral pneumonias.

No studies on immunological or lymphoreticular effects from inhalation exposure to MMT in humans or animals were located.

#### **3.2.1.4 Neurological Effects**

Neurological effects from repeated inhalation exposure to manganese are well recognized as effects of high concern based on case reports and epidemiological studies of groups of occupationally exposed

## 3. HEALTH EFFECTS

people and results from animal inhalation studies. The highest NOAEL values and all LOAEL values from each reliable study for neurological effects in each species and duration category are recorded in Table 3-1 and plotted in Figure 3-1.

***Manganism from High Level Occupational Exposure to Inorganic Manganese.*** There is conclusive evidence from studies in humans that inhalation exposure to high levels of manganese compounds (usually manganese dioxide, but also compounds with Mn(II) and Mn(III)) can lead to a disabling syndrome of neurological effects referred to as ‘manganism’. Manganism is a progressive condition that usually begins with relatively mild symptoms, but evolves to include dull affect, altered gait, fine tremor, and sometimes psychiatric disturbances. Some of these symptoms also occur with Parkinson’s disease, which has resulted in the use of terms such as “Parkinsonism-like disease” and “manganese-induced Parkinsonism” to describe those symptoms observed with manganese poisoning. Despite the similarities, significant differences between Parkinsonism and manganism do exist (Barbeau 1984; Calne et al. 1994; Chu et al. 1995). Barbeau (1984) reported that the hypokinesia and tremor present in patients suffering from manganism differed from those seen in Parkinson’s disease. Calne et al. (1994) noted other characteristics that distinguish manganism from Parkinson’s disease: psychiatric disturbances early in the disease (in some cases), a “cock-walk,” a propensity to fall backward when displaced, less frequent resting tremor, more frequent dystonia, and failure to respond to dopaminomimetics (at least in the late stages of the disease).

Manganism and Parkinson’s disease also differ pathologically. In humans and animals with chronic manganese poisoning, lesions are more diffuse, found mainly in the pallidum, caudate nucleus, the putamen, and even the cortex with no effects on the substantia nigra and no Lewy bodies (Pal et al. 1999; Perl and Olanow 2007). In people with Parkinson’s disease, lesions are found in the substantia nigra and other pigmented areas of the brain (Barbeau 1984). Moreover, Lewy bodies are usually not found in substantia nigra in manganism cases, but are almost always found in cases of Parkinson’s disease (Calne et al. 1994; Perl and Olanow 2007). Manganese appears to affect pathways that are post-synaptic to the nigrostriatal system, most likely the globus pallidus (Chu et al. 1995). MRI of the brain reveals accumulation of manganese in cases of manganism, but few or no changes in people with Parkinson’s disease; fluorodopa positron emission tomography (PET) scans are normal in cases of manganism, but abnormal in people with Parkinson’s disease (Calne et al. 1994). Other studies suggest that manganese produces a syndrome described as parkinsonism, distinct from Parkinson’s Disease or manganism (Lucchini et al. 2007, Racette et al. 2005). It is likely that the terms Parkinson-like-disease and manganese-induced-Parkinsonism will continue to be used by those less knowledgeable about the

## 3. HEALTH EFFECTS

significant differences between the two. Nonetheless, comparison with Parkinson's disease and the use of these terms may help health providers and health surveillance workers recognize the effects of manganese poisoning when encountering it for the first time.

Typically, the clinical effects of high-level inhalation exposure to manganese do not become apparent until exposure has occurred for several years, but some individuals may begin to show signs after as few as 1–3 months of exposure (Rodier 1955). The first signs of the disorder are usually subjective, often involving generalized feelings of weakness, heaviness or stiffness of the legs, anorexia, muscle pain, nervousness, irritability, and headache (Mena et al. 1967; Nelson et al. 1993; Rodier 1955; Tanaka and Lieben 1969; Whitlock et al. 1966). These signs are frequently accompanied by apathy and dullness along with impotence and loss of libido (Abdel-Hamid et al. 1990; Emara et al. 1971; Mena et al. 1967; Nelson et al. 1993; Rodier 1955; Schuler et al. 1957). Early clinical symptoms of the disease include a slow or halting speech without tone or inflection, a dull and emotionless facial expression, and slow and clumsy movement of the limbs (Mena et al. 1967; Nelson et al. 1993; Rodier 1955; Schuler et al. 1957; Shuqin et al. 1992; Smyth et al. 1973; Tanaka and Lieben 1969). In a study by Wolters et al. (1989), 6-fluorodopa (6-FD) and <sup>18</sup>F-2-fluoro-2-deoxyglucose (FDG) PET were used to investigate the neurochemistry of four patients with "early manganism." FDG PET demonstrated decreased cortical glucose metabolism. No anomalies were noted in the 6-FD scans. This led the authors to suggest that, in early manganism, damage may occur in pathways that are postsynaptic to the nigrostriatal system, and most likely involve striatal or pallidal neurons.

As the disease progresses, walking becomes difficult and a characteristic staggering gait develops. Muscles become hypertonic, and voluntary movements are accompanied by tremor (Mena et al. 1967; Rodier 1955; Saric et al. 1977a; Schuler et al. 1957; Smyth et al. 1973). Few data are available regarding the reversibility of these effects. They are thought to be largely irreversible, but some evidence indicates that recovery may occur when exposure ceases (Smyth et al. 1973). Manganism has been documented in welders and in workers exposed to high levels of manganese dust or fumes in mines or foundries. Extreme examples of psychomotor excitement have been observed in manganese miners and, to a lesser extent, in industrial workers (Chu et al. 1995; Mena et al. 1967; Nelson et al. 1993). The behavior, known as "manganese madness" (Mena 1979) includes nervousness, irritability, aggression, and destructiveness, with bizarre compulsive acts such as uncontrollable spasmodic laughter or crying, impulses to sing or dance, or aimless running (Emara et al. 1971; Mena et al. 1967; Rodier 1955; Schuler et al. 1957). Patients are aware of their irregular actions, but appear incapable of controlling the behavior.

## 3. HEALTH EFFECTS

The reports of frank manganism (Rodier 1955; Schuler et al. 1957; Smyth et al. 1973) observed in manganese miners clearly indicate that the onset of manganism results from chronic exposure to high concentrations of the metal. Documented cases indicate that the most important route of exposure is inhalation of manganese dusts or fumes, while other pathways such as ingestion of the metal from mucociliary transport of larger particles and hand-to-mouth activity, may contribute a smaller amount. Based on the data provided by Rodier (1955) and Schuler et al. (1957), it appears that the frequency of manganism cases increased with prolonged exposure, suggesting that the seriousness of the symptoms presented increases with cumulative exposure. For example, Rodier (1955) reports that the highest percentage of manganism cases (28, or 24.4%) occurred in miners with 1–2 years experience. Only six cases of manganism (5.2%) were reported in males with 1–3 months exposure, and 68% of the cases reported occurred after exposures >1–2 years in length. Rodier did not present statistics on the number of men in the mine who were employed for comparable durations who did not suffer from manganism. Schuler et al. (1957) studied fewer manganism cases, but showed that the number of men with manganism increased with time spent mining, with the average time delay before onset of the disease being 8 years, 2 months. In fact, the minimum duration of exposure to the metal was 9 months before signs of manganism became recognizable, and the maximum exposure was 16 years. However, Schuler et al. (1957) point out that their study was not intended to “suggest incidence rates” and of the 83 miners selected for examination of potential manganism, only 9 were chosen as actually suffering from manganese poisoning. As with the Rodier (1955) study, the Schuler et al. (1957) study did not discuss the exposure duration or symptomatology of those men not displaying “frank manganism;” therefore, these collective data, although suggestive of a cumulative effect of manganism neurotoxicity, must be interpreted with caution.

Huang et al. (1998) documented the progression of clinical symptoms of manganism in five surviving workers (from an original six) chronically exposed to manganese in a ferroalloy plant. These men were exposed from 3 to 13 years and were examined 9–10 years after manganese exposure had ceased. Neurologic examination revealed a continuing deterioration of health exhibited in gait disturbance, speed of foot tapping, rigidity, and writing. The men had high concentrations of manganese in blood, urine, scalp, and pubic hair at the time of the original neurologic evaluation. Follow-up analyses revealed a drastic drop in manganese concentrations in these fluids and tissues (e.g., 101.9 µg/g manganese in blood from patient 1 in 1987; 8.6 µg/g manganese in blood in 1995). Further, T1-weighted MRI analysis did not reveal any high-signal intensity areas. These data support the progression and permanence of clinical effects from excess manganese exposure, even when tissue levels of the metal had returned to normal. Further, it shows that this neurotoxicity can continue in the absence of continuing manganese exposure



## 3. HEALTH EFFECTS

and that a spectrum of responses to excess manganese exposure can be seen depending upon dose, duration of exposure, and timing of the observation. While some subclinical manifestations of manganese neurotoxicity will resolve, once neuropathology has occurred (in the form of loss of dopaminergic neurons), then reversal becomes more limited and is restricted to functional compensation.

As shown in Table 3-1 and Figure 3-1, cases of frank manganism have been associated with workplace exposure levels ranging from about 2 to 22 mg manganese/m<sup>3</sup> (Cook et al. 1974; Rodier 1955; Saric et al. 1977; Schuler et al. 1957; Tanaka and Lieben 1969; Whitlock et al. 1966). For example, Tanaka and Lieben (1969) reported that no cases of frank manganism were diagnosed in 38 workers from Pennsylvania industrial plants in which estimated air concentrations were below 5 mg manganese/m<sup>3</sup>, whereas 7 cases were diagnosed in 117 workers from plants with air concentrations exceeding 5 mg/m<sup>3</sup>. Whitlock et al. (1966) reported on two cases of frank manganism in workers who were exposed to estimated air concentrations ranging from 2.3 to 4.7 mg manganese/m<sup>3</sup>.

***Neurological Assessments of Workers Exposed to Low Levels of Inorganic Manganese.*** Studies estimating the impact of low-level exposure to manganese on neurological health have employed a number of sensitive tests designed to detect signs of neuropsychological and neuromotor deficits in the absence of overt symptoms (Iregren 1990, 1994, 1999). These analyses allow the comparison of discrete performance values that are associated with either biological levels of manganese or approximations of exposure levels. Thus, they allow for the comparison of one exposure group to another without the subjective description of neurological symptoms that were prevalent in the studies with miners and others with frank manganism. A number of epidemiological studies have used these techniques to study the psychological or neurological effects of exposure to low levels of manganese in the workplace (Bast-Pettersen et al. 2004; Beuter et al. 1999; Blond and Netterstrom 2007; Blond et al. 2007; Bouchard et al. 2003, 2005, 2007a, 2007b; Chia et al. 1993a, 1995; Crump and Rousseau 1999; Deschamps et al. 2001; Gibbs et al. 1999, Iregren 1990; Lucchini et al. 1995, 1999; Mergler et al. 1994; Myers et al. 2003a, 2003b; Roels et al. 1987a, 1992, 1999; Wennberg et al. 1991) or in environmental media close to manganese-emitting industries (Lucchini et al. 2007; Mergler et al. 1999; Rodríguez-Agudelo et al. 2006). Some of these studies have found statistically significant differences between exposed and non-exposed groups or significant associations between exposure indices and neurological effects (Bast-Pettersen et al. 2004; Chia et al. 1993a; Iregren 1990; Lucchini et al. 1995, 1999; Mergler et al. 1994; Roels et al. 1987a, 1992; Wennberg et al. 1991), whereas others have not found significant associations (Deschamps et al. 2001; Gibbs et al. 1999, Myers et al. 2003a, 2003b; Young et al. 2005). The neurological effects associated with prolonged low-level manganese exposure generally have been subtle changes, including

## 3. HEALTH EFFECTS

deficits in tests of neuromotor or cognitive functions and altered mood states; they have been referred to by various authors as preclinical or subclinical neurological effects. As shown in Table 3-1 and Figure 3-1, manganese air concentrations associated with these effects in chronically exposed workers range from about 0.07 to 0.97 mg manganese/m<sup>3</sup> (manganese in total or inhalable dust measurements). For several of these work environments, values of concentrations of manganese in respirable dust (generally particulate diameters <10 µm) represented <20–80% of the total dust values.

In a cross-sectional epidemiological study of 141 male workers in a manganese dioxide and salt producing plant, Roels et al. (1987a) detected preclinical neurological effects (alterations in simple reaction time, audioverbal short-term memory capacity, and hand tremor) in workers exposed to 0.97 mg manganese (median concentration in total dust)/m<sup>3</sup> as manganese dioxide, manganese tetroxide, manganese sulfate, manganese carbonate, and manganese nitrite for a group average of 7.1 years. End points in exposed workers were compared with end points in a matched control group of 104 non-exposed male workers from a nearby chemical plant. The prevalences of subjective symptoms were similar in exposed and control workers, except for the elevation of nonspecific symptoms (such as fatigue, tinnitus, trembling of fingers, and increased irritability) in the exposed workers. Statistically significant mean deficits were found in exposed workers (compared with controls) in tests of simple reaction time (visual), audioverbal short-term memory capacity, eye-hand coordination, and hand steadiness. The prevalence of abnormal values in the neurological tests were not statistically significantly correlated with manganese levels in blood or urine or duration of employment, with the exception that blood levels of manganese were correlated with prevalence of abnormal responses in tests of eye-hand coordination and hand steadiness.

Iregren (1990) used neurobehavioral tests (simple reaction time, digit span, finger tapping, verbal ability, hand dexterity, and finger dexterity tests from the Swedish Performance Evaluation System, SPES) to study adverse effects in 30 male workers from two different manganese foundries exposed to an estimated median concentration of 0.14 mg manganese (in total dust)/m<sup>3</sup> as manganese dioxide for 1–35 years (mean, 9.9 years). The exposed workers had below-average scores on a number of the tests, such as reaction time and finger tapping, when compared to matched controls with no occupational manganese exposure.

Roels et al. (1992) provided similar results to these earlier reports. Workers in a dry alkaline battery factory exhibited impaired visual reaction time, hand-eye coordination, and hand steadiness when exposed to concentrations of manganese dioxide in total dust ranging from 0.046 to 10.840 mg

## 3. HEALTH EFFECTS

manganese/m<sup>3</sup> and in respirable dust from 0.021 to 1.32 mg manganese/m<sup>3</sup> (exposure ranged from 0.2 to 17.7 years). A lifetime integrated exposure (LIE) for both total manganese dust and respirable manganese was estimated for each of the exposed workers ( $LIE = \sum((C_{\text{job } 1} \times T_1) + (C_{\text{job } 2} \times T_2) + \dots (C_{\text{job } n} \times T_n))$ , where C is concentration, T is years of exposure, and LIE is expressed as mg manganese/m<sup>3</sup> times year). Based on the analysis of data by a logistic regression model, it was suggested that there was an increased risk (odds ratio [OR]=6.43, 95% confidence interval [CI]=0.97–42.7) of decreased hand steadiness at a lifetime integrated exposure level of 3.575 mg/m<sup>3</sup>\*year for total dust or 0.730 mg/m<sup>3</sup>\*year for respirable dust. It should be noted that the LIE at which an increased risk of abnormal neurological function occurs is based on exposures in an occupational setting. Therefore, periods of exposures would be followed by periods that would be relatively free of manganese inhalation. Presumably, during these “rest” periods the homeostatic mechanism would excrete excess manganese to maintain the manganese concentration within physiologic limits. Further, the LIE for deleterious neural effects may be biased in favor of a higher concentration due to the “healthy worker effect” (i.e., the most susceptible individuals are not incorporated into the study).

Crump and Rousseau (1999) performed a follow-up study of 213 men occupationally exposed to manganese, 114 of whom were subjects in the Roels et al. (1987a, 1987b) studies. Exposure data were unavailable during the 11 years of study (1985–1996) during which blood and urine samples were taken and neurological tests (short-term memory, eye-hand coordination, and hand steadiness) were administered as in the Roels studies. Yearly blood and urine manganese levels remained fairly consistent throughout the study period, and were comparable to the levels reported in the previous studies. The authors suggest that the consistency of these data on manganese levels indicates that the airborne manganese concentrations to which the subjects were exposed during the study period were likely comparable to those at the time of the Roels studies. The average age and exposure duration of the subjects increased from 36 and 7 years, respectively, in 1985, to 41 and 14 years, respectively, in 1996. Variations in year-to-year test results were observed that were not attributable to age of the subject or exposure to manganese. The authors observed decreases in errors in the short-term memory test (number of repeated words and number of errors). During 1987, 1988, and 1989, the average number of words remembered on the memory test was lower than in any other year. However, there was a progressive improvement in percent precision and percent imprecision on the eye-hand coordination test during 1985–1988 (after 1991, the design of the test was modified and percent imprecision was lower in that year and all subsequent testing years). The authors suggest several reasons for the inter-year variability in test results (Crump and Rousseau 1999), including variations in test conditions, different groups of workers being tested in different years, the mood of the workers following a plant restructuring, and increased

## 3. HEALTH EFFECTS

caution on the part of the subjects when answering test questions. When data analysis was controlled for year of testing, older workers performed significantly worse than younger workers on total words recalled in the memory test, and on percent precision and percent sureness in the eye-hand coordination test. Further, blood and urine manganese levels were not significantly associated with performance on memory or eye-hand coordination tests, but blood manganese was negatively associated with performance on the hand steadiness test ( $p < 0.05$ ). Age was not a factor in hand steadiness when the year of test was controlled for in the analysis. Crump and Rousseau (1999) investigated whether individual test scores worsened with time by studying the group of 114 men from the original Roels et al. (1987a, 1987b) studies and a subset of 44 long-term employees who had been given both memory and hand steadiness tests on two occasions, 8 years apart. These analyses revealed decreases in performance over time for a particular hole in the hand steadiness test and improvements in repetitions and errors on the memory test, both of which were statistically significant. The authors suggest that the improvements in the memory test were likely the result of increased caution on the part of the subject. The changes in performance over time could not be attributed solely to manganese exposure because it was impossible to control for age and year of testing in all of the analyses. The authors noted the lack of an age-matched control group with which to compare test results and the absence of data caused by workers ending their terms of employment. Some have questioned whether inter-year variability in test results, potentially caused by different test administrators over time, would affect interpretation of the findings. While this may contribute to the changes in performance over time seen in the Crump and Rousseau (1999) study, this factor will potentially impact any study of this type. The lack of a control group precludes the determination of a reliable NOAEL or LOAEL based on the results of this study.

A study by Mergler et al. (1994) also supports the work of Iregren and Roels. This epidemiologic study included 115 (95% of the total) male workers from a ferromanganese and silicomanganese alloy factory who were matched to other workers from the region with no history of exposure. The groups were matched on the following variables: age, sex, educational level, smoking, and number of children. These workers were exposed to both manganese dioxide dusts and manganese fumes. Environmental levels of manganese in total dust were measured at 0.014–11.48  $\text{mg}/\text{m}^3$  (median, 0.151  $\text{mg}/\text{m}^3$ ; arithmetic mean, 1.186  $\text{mg}/\text{m}^3$ , geometric mean, 0.225  $\text{mg}/\text{m}^3$ ), while manganese levels in respirable dust were 0.001–1.273  $\text{mg}/\text{m}^3$  (median, 0.032  $\text{mg}/\text{m}^3$ ; arithmetic mean, 0.122  $\text{mg}/\text{m}^3$ ; geometric mean, 0.035  $\text{mg}/\text{m}^3$ ), and mean duration of exposure was 16.7 years. The exposed workers had significantly greater blood manganese levels, but urinary manganese did not differ between groups. Manganese workers showed decreased performance on tests of motor function (including those from the SPES) as compared to matched control workers with no manganese exposure. Using test results obtained from performance of

## 3. HEALTH EFFECTS

the groups on the Luria-Nebraska Neuropsychological Battery and other tests, the authors reported that manganese-exposed workers performed more poorly than controls on tests of motor function, particularly on tests that required alternating and/or rapid hand movements and hand steadiness. The exposed workers also differed significantly from the controls in cognitive flexibility and emotional state. They also exhibited significantly greater levels of tension, anger, fatigue, and confusion. Further, these workers had a significantly lower olfactory threshold than controls; this is the first study to report this effect following inhalation exposure to manganese. Several follow-up studies of the workers from this manganese alloy plant are described later in this section (Bouchard et al. 2005, 2007a, 2007b).

Similar effects to those observed in the Mergler et al. (1994) study were observed by Chia et al. (1993a). Workers in a manganese ore milling plant exposed to 1.59 mg manganese (mean concentration in total dust)/m<sup>3</sup> exhibited decreased scores in several neurobehavioral function tests including finger tapping, digit symbol, and pursuit aiming. Further, the workers exhibited an increased tendency for postural sway when walking with their eyes closed (Chia et al. 1995).

An epidemiologic study (Lucchini et al. 1995) also supports findings of these studies concerning the preclinical neurological effects of manganese exposure. This study, which evaluated performance on neuromotor tests (seven tests from the SPES, including simple reaction time, finger tapping, digit span, additions, symbol digit, shapes comparison, and vocabulary) involved 58 male workers from a ferroalloy plant. The workers had been exposed for 1–28 years (mean, 13; standard deviation [SD], 7) to geometric mean airborne concentrations of manganese, as manganese dioxide, in total dust as high as 0.070–1.59 mg/m<sup>3</sup> (geometric means in different areas). These concentrations had decreased in the last 10 years to a range of 0.027–0.270 mg manganese (in total dust)/m<sup>3</sup>. At the time of the study, the exposed workers were undergoing a forced cessation from work of 1–48 days. Blood and urine manganese levels were analyzed. A cumulative exposure index (CEI) was calculated for each subject by multiplying the average annual airborne manganese concentration in respirable dust characteristic of each job by the number of years for which this activity was performed. Significant correlations were found between the log value of blood manganese concentrations in exposed workers and the tests of additions, digit span, finger tapping, and symbol digit (log values for the last two tests); between the log value of urinary manganese levels and the performance on the additions test; and between the log value of the CEI and the log value of the symbol digit score. Further, a significant correlation on an individual basis was found between external exposure, represented by CEI, and blood and urine manganese levels. These results are unique in that they are the first to suggest that blood and urine manganese concentrations are indicative of exposure on an individual basis. As suggested by Lucchini et al. (1995), the correlations may be observable in this

## 3. HEALTH EFFECTS

study, when they have not existed in past studies (Roels et al. 1987a, 1992), because the workers were assessed at a time when they were not currently being exposed to manganese. In support of this possibility, the correlation coefficients between the urine and manganese levels and the CEI increased with time elapsed since the last exposure to airborne manganese (Lucchini et al. 1995).

Roels et al. (1999) performed an 8-year prospective study with 92 subjects exposed to manganese dioxide at a dry-alkaline battery plant (Roels et al. 1992) to determine if poor performance on tests measuring visual reaction time, eye-hand coordination, and hand steadiness could be improved if occupational manganese exposure were decreased. The workers were divided into “low” (n=23), “medium” (n=55), and “high” (n=14) exposure groups depending on location within the plant and job responsibility. At the end of the 1987 study, technical and hygienic improvements had been implemented within the plant to decrease atmospheric manganese concentrations. Yearly geometric mean values for airborne total manganese dust (MnT) in the “low,” “medium,” and “high” exposure areas decreased in the following manner, respectively: ~0.310~0.160; ~0.900~0.250; and ~3~1.2 mg/m<sup>3</sup>. The cohort decreased from 92 subjects in 1987 to 34 subjects in 1995 due to turnover, retirement, or dismissal, but no worker left due to neurological signs or symptoms. A separate group of workers was selected who had prior manganese exposure (ranging from 1.3 to 15.2 years). These subjects had left the manganese processing area of the plant prior to the end of 1992, and therefore, their exposure to manganese had ceased at that time; these workers were still employed in other areas of the plant. The control group consisted of 37 workers employed at the same polymer factory that had provided the control population in the previous study (Roels et al. 1992). This group, with an average age of 38.5 (range, 32–51 years) allowed for the analysis of age as a confounder. Exposure data (respirable manganese and total manganese dust, MnT) were taken with personal air samplers. Time-trend analysis of air sampler data revealed a significant decrease in total manganese from 1987 to 1995, with a more pronounced decline from 1992 forward. From 1987 to 1990, the authors observed that the precision of the hand-forearm movement (PN1) in the eye-hand coordination test for the whole cohort worsened, but then got progressively better. Hand steadiness and visual simple reaction time variables were inconsistent over time, and time-trends were not observed. When the cohort was divided into exposure groups, and analyzed for performance on the eye-hand coordination test, it was revealed that in general, the performance on the PN1 aspect of the test improved from 1987 to 1995, especially after 1991. The performance of the “low-dose” group was comparable to that of the control group in 1987 (Roels et al. 1992) and to that of the control group in 1997. The performance of the “medium-dose” group was intermediate between the “low-dose” and “high-dose” group. The only significant differences in performance were in the “high-dose” group as compared to the “low-dose” group during the years 1988–1990 (test scores of 49–51 for the high-dose group and 63–65 for the “low-

## 3. HEALTH EFFECTS

dose” group). However, it was noted that performance on the eye-hand coordination test for the “medium” and “high-dose” groups was considerably poorer than the controls.

Significant differences were noted in variables in the hand steadiness test between the exposure groups during 1987–1992 (data not reported), when manganese concentrations were at their highest. However, no readily identified temporal changes in performance among the groups on this test was found, nor with the visual reaction time test. When the authors performed separate time-trend analysis on MnT levels and PN1 (eye-hand coordination test) values, a significant time effect was present for each variable. An analysis of covariance was performed for each exposure group (low, medium, and high) in which log MnT was considered as covariate in order to adjust for estimation of PN1 variations as log MnT changed over time. The resultant data suggested that a reduction in log MnT was associated with an improvement in PN1 for each group. The authors also found that when time was also considered with log MnT as an interaction term, it did not influence PN1 variations over the years and the effect of time on PN1 values disappeared when log MnT was maintained as an ordinary covariate. The authors interpreted this to mean that performance on the eye-hand coordination tests were only related, and inversely so, to the exposure to manganese. In other words, when manganese exposure was increased, test performance decreased and vice versa (Roels et al. 1999). However, in the high-exposure group, the performance increased from 71 to 83% of that of the control group, and leveled off at this point, despite decreased manganese exposure occurring from 1991/1992 with most dramatic improvements occurring in 1994. The authors suggest that this leveling off of performance by the high-exposure group may be indicative of a permanent effect of manganese on eye-hand coordination. The authors tested PN1 values in exposed subjects 3 years following a cessation of exposure. They found that in 20/24, the PN1 values were below the mean PN1 values of the control group, but 16 of these individuals showed an improvement in 1996 (percent improvement unspecified). The remaining four subjects (three “low-exposure” and one “medium-exposure” subjects) had PN1 values that exceeded the mean value of the control group. However, these data indicate that although there was improvement in performance on the coordination test, the vast majority of the exposed group still could not perform to the level of an unexposed worker 3 years after manganese exposure ceased. In addition, the exposed workers who did perform as well or better than the control subjects were among the least exposed workers while at the plant. As discussed previously, performance of the “low-exposure” group on eye-hand coordination tests during 1992–1995 was comparable to that of the control groups from 1987 and 1997, indicating that manganese exposure of these individuals during that time did not severely impact their ability to perform this neurobehavioral test. Comparable performance on the tests by the same control group in 1987 and 10 years later, in 1997, indicates that age was not a confounder in this study. None of the variables except visual reaction time

## 3. HEALTH EFFECTS

was significantly correlated with age, and the existing correlation in the visual reaction time test only represented a 3% difference (Roels et al. 1999).

Lucchini et al. (1999) also investigated differences in neurobehavioral test performance over time as exposure to manganese (manganese dioxide and manganese tetroxide) decreased. The study group consisted of 61 men who worked in different areas of a ferroalloy plant. The plant was divided into three exposure areas with total manganese dust (geometric mean) values decreasing from 1981 to 1995: “high-exposure” values decreased from 1.6 to 0.165 mg/m<sup>3</sup>; “medium-exposure” values decreased from 0.151 to 0.067 mg/m<sup>3</sup>; and “low-exposure” values decreased from 0.57 to 0.012 mg/m<sup>3</sup>. The authors estimated that the annual average manganese concentration in the “medium-exposure” group was 0.0967 mg manganese in total dust/m<sup>3</sup>. Respirable dust constituted 40–60% of the total dust value. Control subjects consisted of 87 maintenance and auxiliary workers from a nearby hospital who had not been exposed to neurotoxins. The study and control groups were well matched except for years of education and the percentage of subjects working night shifts. The study groups answered a questionnaire concerning neuropsychological and Parkinsonian symptoms and underwent testing to determine the effect of manganese on neuromotor performance. Four tests were from the SPES (addition, digit span, finger tapping, symbol digit) and five timed tasks were from the Luria Nebraska Neuropsychological Battery (open-closed dominant hand—Luria 1, open-closed non-dominant hand—Luria 2, alternative open-closed hands—Luria 3, thumb-fingers touch dominant hand—Luria 4, and thumb-fingers touch non-dominant hand—Luria 5). Individual scores were taken from these subtests, and the sum of the Luria tests was taken (Luria sum). Postural tremor was also measured, as was visual reaction time and coordination ability via the hand pronation/supination test. Manganese levels in blood and urine, as well as blood lead levels were analyzed prior to each neurobehavioral test. Manganese levels in both blood and urine were significantly elevated in exposed workers compared to controls ( $p < 0.0001$ ). Blood lead levels were also significantly higher in the ferroalloy workers ( $p = 0.0002$ ). The authors noted that the study groups did not report as many complaints as those reported in the Mergler et al. (1994) study.

After correcting for age, education, alcohol, smoke, coffee, shift work, and blood lead levels, an analysis of test results indicated that performance of the exposed workers was significantly different than that of controls on all tests except for Luria 5 and Luria sum (Lucchini et al. 1999). A comparison of SPES test results from workers tested in 1990 or 1991 and those from this study did not indicate any difference in paired t-test values; this indicates that performance did not improve over time or with decreasing exposure to manganese. CEI values were calculated (in the same manner as in Lucchini et al. [1995]) for each exposure group and performance on the neurobehavioral tests was analyzed for correlation to these



## 3. HEALTH EFFECTS

values and to manganese levels in body fluids. Significant differences were found between those with low CEI values of  $<0.5 \text{ mg/m}^3\cdot\text{years}$ , mid CEI values of  $0.5\text{--}1.8 \text{ mg/m}^3\cdot\text{years}$ , and high CEI values of  $>1.8 \text{ mg/m}^3\cdot\text{years}$  and performance on the following tests: symbol digit, finger tapping, dominant and non-dominant hand, and digit span. A positive correlation was observed between the log CEI value and these tests, indicating that performance decreased as exposure increased. No correlations were found between CEI values and manganese levels in blood and urine; these results differ from the correlation between CEI and manganese levels in fluids from the previous study (Lucchini et al. 1995). Lucchini et al. (1995) estimated a manganese dose (total dust) that would represent the annual airborne manganese concentration indicative of neurobehavioral deficit in this study by dividing the geometric mean CEI of the mid-exposure subgroup,  $1.1 \text{ mg/m}^3\cdot\text{years}$ , by the geometric mean value of years of exposure for this same subgroup, 11.51, yielding a value of  $0.096 \text{ mg/m}^3$ . A comparable respirable dust value would be  $0.038 \text{ mg/m}^3$  ( $0.096\cdot 0.40$ ).

Gibbs et al. (1999) studied a population of workers in a U.S. plant that produces electrolytic manganese metal. These 75 workers and a well-matched group of control workers with no manganese exposure were administered a computerized questionnaire concerning neurological health issues (including mood, memory, fatigue, and other issues) and were analyzed for performance on several neurobehavioral tests including hand steadiness (Movemap steady, Movemap square, and tremor meter), eye-hand coordination (orthokinisimeter), and rapidity of motion (four-choice reaction time and finger tapping). The Movemap test is a relatively recent test that has not undergone widespread use, and it has not been validated by other researchers. Further, although technically sophisticated, the test has not been observed to discriminate between exposure groups any better than simpler current methods (Iregren 1999). Airborne levels of total and respirable manganese were obtained using personal samplers and were not available for years prior to 1997. Using the arithmetic mean of samples collected in 12 different job categories, exposure was estimated for the years prior to 1997. Cumulative exposure values for each worker were estimated for the 30-day and 12-month exposure periods just prior to neurobehavioral testing. Multiple regressions of the test scores were performed using age and each of the following manganese exposure variables individually as explanatory variables: duration of exposure; 30-day cumulative exposure; 1-year cumulative exposure; and cumulative occupational exposure to either respirable or total manganese. Shift work was also used as a variable in conjunction with age and cumulative 30-day exposure to respirable or total manganese. The authors threw out outlying data points if they were  $>3$  times the SD of the residual after a model fit. Exposures to respirable and total dust were highly correlated ( $r^2$ , 0.62–0.75), as were cumulative exposures over the previous 30 days and the previous year ( $r^2$ , 0.72–0.82); however, lifetime integrated exposure was not correlated with either 30-day or 12-month exposure values. The average

## 3. HEALTH EFFECTS

exposure value for manganese-exposed workers was estimated at  $0.066 \pm 0.059$  mg/m<sup>3</sup> (median, 0.051 mg/m<sup>3</sup>) for respirable dust, and  $0.18 \pm 0.21$  mg/m<sup>3</sup> for total dust.

Responses to the questionnaire and performance on the neurobehavioral tests did not differ significantly between exposed and control groups (Gibbs et al. 1999). Cumulative years of exposure had an effect on tapping speed—speed increased with increased exposure, but only when outliers were included in the analysis. The authors also reported an inverse correlation between age and performance on tests measuring eye-hand coordination but positively correlated between age and complex reaction time. The study by Gibbs et al. (1999) is the first to report a lack of poorer performance on neurobehavioral tests by workers chronically exposed to manganese. Interestingly, the median exposure estimates for respirable dust in this population (0.051 mg/m<sup>3</sup>) is slightly higher than the lowest level of respirable dust at which preclinical neurological effects have been seen (0.032 mg/m<sup>3</sup>) as reported by Mergler et al. (1994).

Gorell et al. (1999) noted a high OR of 10.51 for the development of Parkinson's disease in individuals >50 years old who were occupationally exposed to manganese for >20 years, but not for those exposed for <20 years. However, the numbers of individuals with a >20-year exposure was rather small (n=4), and occupational exposures to other metals (copper, and lead-iron, lead-copper, and iron-copper combinations) for >20 years were also associated with increased risk for the disease.

In a cross-sectional study of 138 (114 male and 34 female) enamels-production workers, Deschamps et al. (2001) administered a questionnaire about neurological symptoms; evaluated performance on psychological tests of similarity recognition, vocabulary (oral word association), geometrical figure recognition (visual gestalts), and short-term memory (digit span); and measured levels of manganese in blood samples. Results were compared with a control group of 137 nonexposed workers matched for age, educational level, and ethnic group. Exposed workers were employed for a mean duration of 19.87 years (SD±9) in enamels production. Mean manganese levels in 15 personal air samples and 15 stationary air samples collected at the plant during the year preceding the tests were 2.05 mg manganese/m<sup>3</sup> (SD 2.52; range 0.5–10.2) for total dust and 0.035 mg manganese/m<sup>3</sup> for respirable manganese (SD 0.063; range 0.01–0.293). Symptoms of asthenia, sleep disturbance, and headache were significantly elevated in exposed workers, compared with controls, but no significant differences in blood levels of manganese or performance on the administered tests were found between the exposed and control groups of workers. Clinical examination of the exposed subjects revealed no cases of obvious neurological impairment, but sensitive psychomotor tests of simple reaction times and motor functions were not administered in this study.

## 3. HEALTH EFFECTS

In a cross-sectional study, Myers et al. (2003a) evaluated results from a health questionnaire and a battery of neurobehavioral tests administered to 489 workers employed as office workers, miners, surface processors, engineers, and other service workers from two South African manganese mines. Cumulative exposure indices for each subject were calculated based on total dust measurements and job history. Workers were employed in the mines for a mean of 10.8 years (SD=5.5 years; range 1–41 years), had an average cumulative exposure index of 2.2 (mg manganese/m<sup>3</sup> per year, SD=2.2; range=0–20.8), an average exposure intensity of 0.21 mg manganese/m<sup>3</sup> (SD=0.14; range, 0–0.99), and an average blood manganese concentration of 8.5 µg/L (SD=2.8; range, 2.2–24.1). Neurobehavioral end points included three tests of motor function in the Luria-Nebraska battery (tests 1, 2, and 23), mean reaction time in the SPES, and three cognitive tests (forward and backward digit span and digit-symbol score). Multiple linear regression analysis revealed no significant (p<0.05) associations between any measure of exposure and questionnaire or test battery outcomes.

In another cross-sectional study, Myers et al. (2003b) evaluated neurobehavioral end points in a group of 509 workers at a South African manganese smelter, compared with a group of unexposed workers from an electrical fittings assembly plant (remote from the manganese smelter). Workers were employed for a mean of 18.2 years (SD 7.6), compared with 9.4 years (SD 7.0) in the control group. Exposure was assessed from manganese determinations in dust from personal air samples, blood samples, and urine samples. Cumulative exposure indices were calculated for each exposed worker based on manganese concentrations in “inhalable” dust from personal air samples and job histories. Mean values for exposed workers were 16.0 mg manganese/m<sup>3</sup> per year (SD 22.4) for cumulative exposure index, 0.82 mg manganese/m<sup>3</sup> (SD 1.04) for average intensity of exposure, 12.5 µg manganese/L (SD 5.6) for blood manganese, and 10.5 µg manganese/L (SD 20.3) for urine manganese. Control workers had mean values of 6.4 µg manganese/L (SD 1.7) for blood manganese and 0.96 µg manganese/L (SD 0.81) for urine manganese. Neurobehavioral end points included the Swedish nervous system questionnaire and the following neurobehavioral test batteries: World Health Organization (WHO) neurobehavioral core test battery, SPES, Luria-Nebraska tests, and Danish product development tests (tests of hand steadiness, tremor, and body sway). Information collected for potential confounders included age, educational level, alcohol and tobacco consumption, neurotoxic exposures in previous work, past medical history, and previous head injury. Multiple linear and logistic regression analyses were conducted to examine possible exposure-response relationships. Several tests showed significant (p<0.05) differences between exposed and control workers, but no evidence of exposure-response relationships including the following: the Santa Ana, Benton and digit span WHO tests; hand tapping and endurance tapping SPES tests; one

## 3. HEALTH EFFECTS

Luria-Nebraska test (item 2L); several self-reported symptoms (e.g., tiredness, depressed, irritated); and increased sway under two conditions (eyes open with or without foot insulation). Results from two other tests (WHO digit-symbol test and Luria-Nebraska item 1R) showed differences between exposed and control groups and some evidence for increased deficits with increasing exposure, but the change with increasing exposure was greater at lower exposure levels than at higher exposure levels. Results from all of the remaining tests showed no significant adverse differences between the exposed and control groups. The authors concluded that “the most likely explanation for few, weak and inconsistent findings with implausible or counterintuitive exposure-response relationships is chance, and it is concluded that this is essentially a negative study.”

Young et al. (2005) reanalyzed the data collected by Myers et al. (2003b) on the basis of estimated exposures to manganese in “respirable” dust. Exposure estimates for each worker (cumulative exposure indices in mg manganese/m<sup>3</sup> per year and average intensity of exposure in mg manganese/m<sup>3</sup>) were recalculated based on manganese determinations in personal air samplings of respirable dust (collected on 37 mm, 5 µm MCEP membrane filters, as opposed to inhalable dusts of larger particle sizes used to estimate exposure in the earlier analyses by Myers et al. [2003b]). Results from comparisons of mean performances of exposed and control groups in the neurobehavioral tests and regression analyses to assess exposure-response relationships were similar to results from the earlier analyses by Myers et al. (2003b) based on manganese determinations in inhalable dust. The authors concluded that the results did not provide evidence that exposure estimates based on respirable dust provide a more sensitive method to detect manganese neurobehavioral effects.

Bast-Pettersen et al. (2004) cross-sectionally examined neurobehavioral end points in a group of 100 male workers in manganese alloy plants and a group of 100 control workers (paired matched for age) from two plants, one producing silicon metal and microsilica and another titanium oxide slag and pig iron. Manganese alloy workers were employed for a mean of 20.2 years (SD 8.6; range 2.1– 41.0 years); comparable statistics were not reported for the control workers. Exposure was assessed from manganese determinations in dust from personal air samples (collected on 3 days for each subject closely before the neurobehavioral assessment), blood samples, and urine samples. Arithmetic means for manganese workers were 0.753 mg manganese/m<sup>3</sup> inhalable dust for work room air (geometric mean 0.301; range 0.009–11.5 mg manganese/m<sup>3</sup>), 189 nmol manganese/L in blood (range 84–426 nmol/L), and 3.9 nmol manganese/mmol urine creatinine (range 0.1–126.3). The Institute of Occupational Medicine (IOM) personal samplers used in this study are expected to provide estimates that are approximately 2-fold higher than estimates using 25- or 37-mm plastic Millipore personal air samplers used in many earlier

## 3. HEALTH EFFECTS

studies to measure “total dust”. Mean levels of manganese in blood (166 nmol manganese/L) and urine (0.9 nmol manganese/mmol creatinine) of control workers were significantly lower than levels in exposed workers. Neurobehavioral end points included: two self-administered neuropsychiatric questionnaires; six tests of cognitive functions (Weschlers adult intelligence scale, digit symbol, trail making test, Stroop color-word recognition, digit span, and Benton visual retention); and eight tests of motor functions (static hand steadiness, “TREMOR” test, finger tapping, foot tapping, supination/pronation of hand, Luria-Nebraska thumb/finger sequential touch, simple reaction time, and hand-eye coordination). Information collected for potential confounders included age, years of education, alcohol and tobacco consumption, and prevalence of previous brain concussions. Multiple linear regression analyses were conducted to examine the influence of potential confounders and exposure-response relationships for test results. No significant ( $p<0.05$ ) effect of exposure was found in tests for cognitive functions, reaction time, or symptom reporting. No statistically significant ( $p<0.05$ ) differences were found in tests of motor speed, grip strength, or reaction time. Postural tremor as measured in the hand steadiness test was significantly ( $p<0.05$ ) increased in the exposed group compared with the controls and showed an exposure-response relationship when the exposed group was regrouped into three groups of increasing duration of employment. Results from an alternative test of tremor (“TREMOR”) did not distinguish between the manganese alloy group and the control group. The results indicate that the manganese-exposed group of workers had increased hand tremor compared with the control group, but were indistinguishable from the control group in other tests of motor function, cognitive function, or symptom reporting.

Bouchard et al. (2005) reanalyzed results from neurobehavioral tests administered by Mergler et al. (1994) to 74 male workers in a manganese alloy plant to examine the influence of age on the tests. At the time of testing, workers had been employed an average of 19.3 years (range 1–27 years) and 71 of the workers were employed for >10 years. Based on personal air and stationary air samples 8-hour time-weighted average manganese concentrations ranged from 0.014 to 11.48 mg manganese/m<sup>3</sup> total dust (geometric mean=0.225 mg manganese/m<sup>3</sup>) and from 0.001 to 1.273 mg manganese/m<sup>3</sup> respirable dust (geometric mean=0.035 mg manganese/m<sup>3</sup>). The referent group contained 144 workers with no history of occupational exposure to neurotoxicants who were matched for age, educational level, smoking status, and number of children. Mean blood manganese levels were  $11.9\pm 5.3$   $\mu\text{g/L}$  (range 4.4–25.9  $\mu\text{g/L}$ ) in exposed workers and  $7.2\pm 0.3$   $\mu\text{g/L}$  (range 2.8–15.4  $\mu\text{g/L}$ ) in controls. Paired differences between exposed and control workers increased significantly ( $p<0.05$ ) with age for one of nine tests of neuromotor domain (nine-hole hand steadiness test); 3 of 12 tests of cognitive domain (trail making B [test of visual conception and visuomotor tracking], delayed word recall [test of learning, recall and attention], and cancellation H [test of visuomotor tracking and concentration]); and 1 of 4 sensory domain tests

## 3. HEALTH EFFECTS

(vibratometer–vibrotactile perception of the index and toe). The results suggest that older workers may be more slightly more susceptible to the neurological effects of low-level manganese exposure than younger workers.

Bouchard et al. (2007a) examined neuropsychiatric symptoms in a group of 71 male workers in a manganese alloy plant, 14 years after cessation of exposure, and in a group of 71 unexposed referents of similar age and education levels from the same geographical region. Based on personal air and stationary air samples during the operation of the plant, 8-hour time-weighted average manganese concentrations were 0.014–11.48 mg manganese/m<sup>3</sup> total dust (geometric mean=0.225 mg manganese/m<sup>3</sup>) and 0.001–1.273 mg manganese/m<sup>3</sup> respirable dust (geometric mean=0.035 mg manganese/m<sup>3</sup>). The mean number of years of occupational exposure to manganese was 15.7 (range, 7.4–17.3 years). The exposed workers were participants in the earlier study by Mergler et al. (1994). Neuropsychiatric symptoms were assessed by a self-administered questionnaire, the Brief Symptom Inventory, from which scores were determined for somatization (psychological distress from perception of bodily dysfunction), obsessive-compulsive behavior, interpersonal sensitivity (feeling of personal inadequacy), depression, anxiety, hostility, phobic anxiety, paranoid ideation, and psychoticism. Former, manganese workers showed significantly ( $p<0.05$ ) higher scores (after adjustment for age, education, and alcohol consumption) for two of the nine neuropsychiatric symptoms (depression, anxiety), compared with controls.

In a follow-up to the Mergler et al. (1994) study, Bouchard et al. (2007b) evaluated neurobehavioral end points in a group of 77 male former workers in a manganese alloy plant, 14 years after cessation of employment, and in a group of 81 nonexposed referents group-matched for age, education and alcohol consumption. The groups were initially assessed in 1990 and, for the present study in 2004, in five neuromotor tests, nine cognitive tests, and six mood state tests. Based on personal air and stationary air samples during the operation of the plant, 8-hour time-weighted average manganese concentrations were 0.014–1.48 mg manganese/m<sup>3</sup> total dust (geometric mean=0.225 mg manganese/m<sup>3</sup>) and 0.001–1.273 mg manganese/m<sup>3</sup> respirable dust (geometric mean=0.035 mg manganese/m<sup>3</sup>). Mean years of occupational exposure to manganese was reported as 15.3 years (maximum=17.3 years). In the 1994 assessment, significant ( $p<0.05$ ) differences between exposed and control workers were found in scores for one of five neuromotor tests (Luria Motor Scale), three of nine cognitive tests (cancellation H, digit span, color-word test), and one (tension-anxiety) of six mood state tests. In 2004, significant ( $p<0.05$ ) differences between the exposed and control workers persisted for one (Luria Motor Scale) of five neuromotor tests, none of the nine cognitive tests, and one (confusion-bewilderment) of the six mood states. These results

## 3. HEALTH EFFECTS

indicate that exposure-related effects observed initially in the manganese alloy workers did not progress in a 14-year period following cessation of employment.

***Neurological Assessments of Environmentally Exposed Populations Exposed to Inorganic Manganese.***

Mergler et al. (1999) studied environmental exposure to manganese and its possible effect on mood (Bowler et al. 1999), neuromotor function (Beuter et al. 1999), and levels of the metal in biological fluids (Baldwin et al. 1999). The study group was a community in southwest Quebec, Canada, near which a former manganese alloy production plant served as a point source for environmental manganese pollution. Due to the presence of MMT in gasoline in Canada, inhaled manganese from car exhaust is a potential contributor to manganese exposures experienced in the population studied. A total of 273 persons comprised the test population. These individuals were selected using a stratified random sampling strategy from the Quebec Health Plan Register, which includes all residents. This strategy helped to ensure that no selection bias was introduced. These individuals were administered a test battery including a computerized neuromotor test, blood sampling, visual function tests from the Neurobehavioral Evaluation System-2, an extensive neuropsychological test battery, and diverse tests covering such areas as olfactory threshold, finger tapping, digit span, and postural sway. Blood sampling data for the study subjects (Baldwin et al. 1999) indicated that manganese levels in women (geometric mean=7.5 µg/L) were significantly higher than in men (6.75 µg/L). No relationship was found between the overall level of manganese in blood and those of lead or iron in serum. However, blood manganese levels were negatively correlated with serum iron in women and had a tendency to decrease with increasing age. Serum iron levels in men were higher than in women. The authors analyzed manganese in drinking water from the study subjects' residences and analyzed air samples from four different locations for total manganese particulates and PM<sub>10</sub> values. The geometric mean value for manganese in drinking water was 4.11 µg/L; there was no correlation between individual values in drinking water manganese and manganese blood levels. Intersite differences in manganese values in total particulate were not observed in the air samples, but intersite differences did exist for manganese in PM<sub>10</sub> values. Two geographical areas were identified where manganese in air contributed to blood manganese levels; serum iron was negatively related to blood manganese levels in this analysis (Baldwin et al. 1999).

The Profile of Moods State and Brief Symptom Inventory self-report scales were used to assess condition of mood in the study population (Bowler et al. 1999). The results from these analyses indicated that men who are older (>50 years) and have higher blood manganese levels ( $\geq 7.5$  µg/L) showed significant disturbances in several mood symptoms with significantly increased values for anxiety, nervousness, and irritability; emotional disturbance; and aggression and hostility when compared to those with lower levels

## 3. HEALTH EFFECTS

of blood manganese. Neuromotor, neurological, and neurobehavioral analyses revealed that subjects with higher blood manganese levels ( $\geq 7.5 \mu\text{g/L}$ ) performed significantly worse on a test for coordinated upper limb movements, with poorest performance in older men (Mergler et al. 1999). Also in men, proximal events on the qualified neurological examination, involving arm movements were significantly slower for those with higher blood manganese, and hand movements (distal events) tended to be in the same direction. No correlation was observed in women. Other measures of motor performance (e.g., hand-arm tremor and tapping movements) were not related to blood manganese levels, although a significant decrease in tremor frequency dispersion was observed with log MnB (manganese blood level). For both men and women, performance on the learning and memory tests was inversely correlated with manganese blood level values, although performance on individual portions of the overall test varied significantly with gender. For men, higher levels of manganese in blood were associated with poorer performance on list acquisition, delayed auditory recall, and visual recognition following a distracter. Females, in contrast, tended to recall fewer geometric shapes, made more errors on the visual reproduction test, but remembered more numbers on the digit span forward test. This study is unique in that it is the first to study both males and females in an exposed population, and it shows an association between elevated manganese blood levels linked to elevated environmental manganese and poor performance on neurobehavioral and neuropsychiatric tests. This study also reported that neurological effects associated with higher levels of blood manganese were more likely to be observed in persons  $>50$  years of age. In contrast, Roels et al. (1999) reported that age was a significant factor only in performance of the visual reaction time test, but not for the eye-hand coordination test or the measure of hand steadiness used in their longitudinal studies. However, Crump and Rousseau (1999) reported that older age was a significant factor in poor performance in tests of short-term memory and eye-hand coordination. Although there were no statistically significant neurological effects associated with manganese exposure among workers of a metal-producing plant evaluated by Gibbs et al. (1999), these investigators also noted that test performance in eye-hand coordination and reaction time decreased with increasing age.

Rodriguez-Agudelo et al. (2006) examined neurobehavioral end points in 168 women and 120 men from eight communities at various distances from manganese extraction or processing plants in the district of Molango, Mexico. Manganese levels in  $\text{PM}_{10}$  dust in air samples collected from 28 houses were determined, and the values obtained from the closest monitor were assigned to each of the 288 participants (values ranged from 0 to  $5.86 \mu\text{g manganese/m}^3$ ). Concentrations of manganese in samples of drinking water and maize grain were mostly below detection limits, whereas soil concentrations ranged from about 6 to 280 mg manganese/kg, with the largest concentrations noted in samples collected close to the manganese industrial sites. Blood samples were collected from each



## 3. HEALTH EFFECTS

participant and used for manganese and lead determinations. Neuromotor tests (which were a Spanish adaptation of Luria diagnostic procedures) were administered, and odds ratios (ORs) were calculated for 24 different end points involving hand motor functions using dichotomous assessments of performance (e.g., normal and poor) after grouping the participants based on associated manganese concentrations in air or blood manganese levels. No associations were found between neuromotor performance and blood levels of manganese or lead. After grouping the participants into those associated with air concentrations between 0 and 0.1  $\mu\text{g manganese/m}^3$  and those with concentrations between 0.1 and 5.86  $\mu\text{g manganese/m}^3$  (approximate midpoint=3  $\mu\text{g manganese/m}^3$ ), significantly ( $p<0.05$ ) elevated ORs for poor performance were calculated for only 3 of the 24 neuromotor end points (two movement coordination, left hand performance [OR=1.99, 95% CI 1.15–3.43]; change of hand position, left hand performance [OR=1.98, 95% CI 0.99–3.95], and conflictive reaction, a test of verbal regulation of movement [OR=2.08, 95% CI 1.17–3.71]). Although the authors concluded that the results indicate that “there is an incipient motor deficit in the population environmentally exposed to large manganese levels,” a more likely explanation for the few and inconsistent findings is chance. This explanation is supported by the finding that no statistically significant associations were found between any neuromotor function end points and blood manganese levels. In addition, the lack of air monitoring data for individual participants in the study precludes assigning the “high” air concentration exposure level as a reliable LOAEL or NOAEL.

In a community-based study, Lucchini et al. (2007) examined possible associations between prevalence of Parkinsonian disorders and levels of manganese in settled dust collected from communities in the vicinities of manganese ferroalloy industrial plants in the province of Brescia, Italy. Parkinsonian patients were identified from clinical registers from local hospitals, area neurologists, and records of exemption from prescription payments, as well as from records of L-Dopa prescriptions; a total of 2,677 Parkinsonian cases were identified among 903,997 residents. SMRs for each of 206 municipalities were calculated based on national rates standardized for age and gender. Municipalities with the highest SMRs were located within 20 km and/or downwind of three manganese alloy industrial plants in the Valcamonica region of Brescia. An average standardized prevalence of 492 cases/100,000 residents was observed in the 37 municipalities of the Valcamonica region. Crude and standardized prevalence rates for the Valcamonica municipalities were significantly ( $p<0.05$ ) higher than rates for the other 169 municipalities of Brescia. Municipality-based SMRs for Parkinsonian disorders were significantly ( $p<0.05$ ) associated with manganese levels in settled dust, and manganese levels in settled dust samples from the 37 municipalities in Valcamonica were significantly ( $p<0.05$ ) higher than levels in samples for the other 169 municipalities. The results suggest that prolonged environmental exposure to excessive

## 3. HEALTH EFFECTS

manganese in the Valcamonica region of Brescia may increase the risk for Parkinsonian disorders, but the results do not identify a reliable NOAEL or LOAEL that can be expressed in units of manganese air concentrations. The authors speculated that, even though manganese-induced and Parkinsonian neurological disorders are expected to have two distinct target areas in the brain (the globus pallidus and the substantia nigra, respectively), structural and chemical interconnections between the brain areas may interact to cause increased risk for Parkinsonian disorders as suggested by Weiss (2006).

***Neurological Studies of Animals Exposed by Inhalation to Inorganic Manganese.*** In several early animal studies, intermediate or chronic inhalation exposure of monkeys and rats to manganese dusts has not produced neurological signs similar to those seen in humans (Bird et al. 1984; EPA 1983c; Ulrich et al. 1979a, 1979b). For example, Ulrich et al. (1979a) reported that monkeys continually exposed for 9 months to aerosols of manganese dioxide at concentrations as high as 1.1 mg manganese/m<sup>3</sup> showed no obvious clinical signs of neurotoxicity, no histopathological changes in brain tissues, and no evidence for limb (leg) tremor or electromyographic effects on flexor and extensor muscles in the arm. However, in a chronic study with Rhesus monkeys, decreased levels of dopamine were found in several regions of the brain (caudate and globus pallidus) (Bird et al. 1984). Behavioral tests detected signs of neurological effects in mice (increased open-field activity and decreased maternal pup retrieval latency), although these are only seen at relatively high exposure levels (60–70 mg manganese/m<sup>3</sup>) (Lown et al. 1984; Morganti et al. 1985).

Several studies provide evidence for associations between decreased neuronal cell counts in the globus pallidus and neurobehavioral changes (increased locomotor activity) in rats exposed by inhalation for 13 weeks to a mixture of manganese phosphate/sulfate (at 1.05 mg manganese/m<sup>3</sup>) or manganese sulfate alone (at concentration between 0.009 and 0.9 mg manganese/m<sup>3</sup>), but not to manganese phosphate alone at concentrations up to 1.1 mg manganese/m<sup>3</sup> (Normandin et al. 2002; Salehi et al. 2003, 2006; Tapin et al. 2006). Other 13-week rat inhalation exposure studies reported increased brain manganese concentrations and increased locomotor activity after exposure to 3.75 mg manganese/m<sup>3</sup> as metallic manganese (St-Pierre et al. 2001) and increased brain manganese concentrations with no increases in olfactory bulb, cerebellar, or striatal concentrations of glial fibrillary acidic protein (GFAP) after exposure to 0.5 mg manganese/m<sup>3</sup> as manganese sulfate or 0.1 mg manganese/m<sup>3</sup> as manganese phosphate (Dorman et al. 2004b). GFAP is a widely acknowledged marker of damage to astrocytes.

In male Sprague-Dawley rats, increased locomotor activity (increased distance traveled, but no change in resting time) was observed after up to 13 weeks of exposure to 0.03 or 3 mg of a manganese

## 3. HEALTH EFFECTS

phosphate/sulfate mixture/m<sup>3</sup> (6 hours/day, 5 days/week), but not at 0.3 mg/m<sup>3</sup> (Salehi et al. 2003). These exposure concentrations correspond to 0.01, 0.11, and 1.05 mg manganese/m<sup>3</sup>. Assessment of brain manganese levels, hind limb tremor, and neuropathology of the brain (counts of neuronal cells) found no evidence for tremor at any exposure level, but rats at the highest exposure level showed significantly ( $p < 0.05$ ) increased concentrations of manganese in the frontal cortex, globus pallidus, and caudate putamen, as well as significantly ( $p < 0.05$ ) decreased neuronal cell counts in the globus pallidus and caudate putamen, compared with control values or to values for rats in the lower exposure groups (Salehi et al. 2006).

In similar experiments with male Sprague-Dawley rats exposed to 0, 0.03, 0.3, or 3 mg manganese sulfate/m<sup>3</sup> (Tapin et al. 2006) or 0, 0.03, 0.3, or 3 mg manganese phosphate/m<sup>3</sup> (Normandin et al. 2002) for 13 weeks by the same exposure protocol, some differences in results were obtained. These exposure levels correspond to 0.009, 0.09, or 0.9 mg manganese/m<sup>3</sup> for manganese sulfate and 0.01, 0.11, or 1.1 mg manganese/m<sup>3</sup> for manganese phosphate. With exposure to manganese phosphate, manganese levels were significantly ( $p < 0.05$ ) elevated (at 3 mg/m<sup>3</sup>) in the olfactory bulb, frontal cortex, globus pallidus, caudate putamen, and cerebellum regions of the brain, but no exposure-related effects were found on neuronal cell counts or locomotor activity (Normandin et al. 2002). In contrast, manganese sulfate exposure significantly ( $p < 0.05$ ) increased manganese levels in all regions of the brain, and decreased neuronal counts in the globus pallidus at 0.3 and 3 mg manganese sulfate/m<sup>3</sup>, compared with controls (Tapin et al. 2006). In addition, the two highest exposure levels of manganese sulfate were associated with significantly ( $p < 0.05$ ) increased locomotor activity (distance traveled), increased resting time, and decreased total ambulatory counts; the lowest exposure level, 0.03 mg manganese sulfate/m<sup>3</sup> also increased the distance traveled end point of locomotor activity (Tapin et al. 2006). As with the manganese phosphate/sulfate mixture, neither manganese phosphate nor manganese sulfate exposure was associated with hind limb tremors in the rats. Earlier studies by the same research group, found that Sprague-Dawley rats exposed to 3.75 mg aerosols of metallic manganese/m<sup>3</sup> (6 hours/day, 5 days/week for 13 weeks) showed significantly ( $p < 0.05$ ) higher manganese concentrations in various regions of the brain, and higher distance traveled and lower resting time in locomotor tests, compared with controls; neuronal counts were not assessed in this earlier study (St-Pierre et al. 2001).

Several studies have examined the influence of inhalation exposure to manganese sulfate on biochemical end points associated with oxidative stress or inflammation in the brain of rats (Erikson et al. 2005, 2006; HaMai et al. 2006; Taylor et al. 2006) and monkeys (Erikson et al. 2007). Erikson et al. (2005, 2006) exposed neonatal rats to manganese sulfate (0, 0.05, or 1 mg manganese/m<sup>3</sup>) during gestation and

### 3. HEALTH EFFECTS

postnatal days (PNDs) 1–18 and examined five brain regions for several biochemical end points associated with oxidative stress either on PND 19 (Erikson et al. 2006) or after 3 weeks without exposure (Erikson et al. 2005). End points included levels of glutamine synthase (GS) protein and mRNA, metallothionein (MT) mRNA, tyrosine hydroxylase (TH) protein and mRNA, and total reduced glutathione. At PND 9, increased manganese concentrations in the striatum (the most consistently affected region) were associated with decreases in GS, MT, and TH mRNA, and significantly decreased levels of glutathione (Erikson et al. 2006), but these were not apparent 3 weeks after cessation of exposure (Erikson et al. 2005). However, other end points (such as decreased GS protein) were changed, compared with control values, 3 weeks after cessation of exposure (Erikson et al. 2005). Similar end points, as well as levels of mRNA and protein for glutamate transporters, were examined in six brain regions of young male Rhesus monkeys exposed to 0, 0.06, 0.3, or 1.5 mg manganese/m<sup>3</sup> as manganese sulfate for 65 days (Erikson et al. 2007). Exposure-related changes included decreased MT mRNA in most regions, decreased TH protein levels in the caudate and globus pallidus, increased GSH in the frontal cortex, and decreased GSH in the caudate. In another study, HaMai et al. (2006) exposed three groups of rats to 0 or 0.71 ng manganese/m<sup>3</sup> (2 hours/day) as manganese sulfate on gestation days (GDs) 9 and 10, on PNDs 37–47, or on GDs 9 and 10 plus PNDs 37–47 and measured brain levels of mRNA for gene products related to oxidative stress or inflammation. Gestational exposure was associated with decreased mRNA for amyloid precursor (APP), cyclooxygenase-2 (COX-2), neuronal nitric oxide synthetase (nNOS), and GFAP, whereas adult exposure was associated with greater transcriptional decreases for the same gene products as well as transcriptional growth factor beta (HaMai et al. 2006). The results from these studies indicate that acute- or intermediate-duration inhalation exposure to manganese sulfate concentrations ranging from about 0.1 to 1 mg manganese/m<sup>3</sup> can differentially affect brain biochemical markers of neurotoxicity, but understanding of the neurotoxic mechanism of manganese is inadequate to confidently define any one of the observed changes as biologically adverse.

No studies on neurological effects from inhalation exposure to MMT in humans or animals were located.

#### **3.2.1.5 Reproductive Effects**

As discussed earlier (see Section 3.2.1.4), impotence and loss of libido are common symptoms in male workers afflicted with clinically identifiable signs of manganism attributed to occupational exposure to manganese for 1–21 years (Emara et al. 1971; Mena et al. 1967; Rodier 1955; Schuler et al. 1957). These symptoms could lead to reduced reproductive success in men. Impaired fertility (measured as a decreased number of children/married couple) has been observed in male workers exposed for 1–19 years to

## 3. HEALTH EFFECTS

manganese dust ( $0.97 \text{ mg/m}^3$ ) at levels that did not produce frank manganism (Lauwerys et al. 1985). This suggests that impaired sexual function in men may be one of the earliest clinical manifestations of manganism, but no dose-response information was presented so it is not possible to define a threshold for this effect. Jiang et al. (1996b) performed a reproductive epidemiological study on 314 men in a manganese plant. The men, from six different factories, performed milling, smelting, and sintering duties for up to 35 years. The geometric mean airborne manganese concentration (assumed to be total dust) was  $0.145 \text{ mg/m}^3$  as manganese dioxide. The researchers found no significant differences in reproductive outcomes between exposed and control workers (controls were matched for several factors, including age, smoking, personal hygiene, living habits, and cultural background). The incidences of sexual dysfunction were evaluated through researchers' questions and judged by the occurrence of two positive responses to three potential conditions: impotence, abnormal ejaculation (early ejaculation or nonejaculation), and lack of sexual desire. Impotence and lack of sexual desire were higher in the exposed group than in the controls (Jiang et al. 1996b). Wu et al. (1996) reported increased semen liquefaction time and decreased sperm count and viability in three groups of men occupationally exposed to manganese: 63 miners or ore processors, 38 electric welders in mechanical fields, and 110 electric welders in shipbuilding. Matched controls consisted of 99 men who were employed in the same occupation and from the same area, but were not exposed to manganese or other reproductive toxins. The men had been exposed to manganese for  $\geq 1$  year. Geometric means of total manganese dust (as manganese dioxide) ranged from  $0.14 \text{ mg/m}^3$  for mining operations to  $5.5 \text{ mg/m}^3$  for manganese powder processing. Manganese fume concentrations varied; the mechanical welders were exposed to a concentration of  $0.25 \text{ mg/m}^3$  (geometric mean), while the shipbuilding area concentrations ranged from geometric means of  $6.5\text{--}82.3 \text{ mg/m}^3$ , depending on the location within the ship. The miners had a significant percentage (14.3%;  $p < 0.01$ ) of samples with increased liquefaction time, decreased sperm count (34.9%;  $p < 0.01$ ), and decreased percentage of total viable sperm (33.3% had abnormal counts;  $p < 0.01$ ) compared to controls. Welders in shipbuilding had decreased sperm viability levels that were significantly different from controls ( $p < 0.01$ ). Manganese concentrations in semen were significantly increased compared to controls in the mechanical welders; copper, nickel, chromium, and iron concentrations were also elevated in semen in welders in both mechanical and shipbuilding careers. Further, stepwise regression analysis of the impact of these other metals on the measured reproductive parameters indicated that the higher the nickel concentration, the lesser the semen volume and the greater the number of deformed sperm. Copper in the seminal fluid was also positively linked with the viable sperm percentage, sperm viability and number of sperm. Although this study indicates that manganese exposure can cause sperm toxicity, the presence of other metals prevents any conclusive statements concerning its importance. Gennart et al. (1992) performed a reproductive study on 70 male workers

## 3. HEALTH EFFECTS

exposed to manganese dioxide at a median concentration of 0.71 mg manganese/m<sup>3</sup> in total dust for an average of 6.2 years in a dry alkaline battery plant. Results from a questionnaire answered by the workers and controls in the study and from analysis of birthrates of exposed and control workers revealed no difference in birthrates between the groups.

These results in human studies reveal conflicting evidence for whether occupational exposure to manganese causes adverse reproductive effects. Effects reported may occur as a secondary result of neurotoxicity but do not provide information on any direct effect manganese may have on the reproductive organs. No information was found regarding reproductive effects in women.

Intratracheal instillation studies in rabbits indicate that single high doses of manganese (158 mg/kg, as manganese dioxide) can cause severe degenerative changes in the seminiferous tubules and lead to sterility (Chandra et al. 1973; Seth et al. 1973). This effect did not occur immediately, but developed slowly over the course of 4–8 months following the exposure. Direct damage to the testes has not been reported in humans occupationally exposed for longer periods, suggesting that this effect may not be of concern under these exposure circumstances. However, it is unclear if specific studies to investigate possible testicular damage have been performed.

None of the studies located reported adverse effects in female animals following inhalation exposure to manganese. In a study with female mice (Lown et al. 1984), the average number of pups born to exposed females was increased when dams were exposed to manganese dioxide before conception through gestation. In a report of a study of tissue manganese concentrations in lactating rats and their offspring following exposure to manganese sulfate aerosols at 0, 0.05, 0.5, or 1 mg manganese/m<sup>3</sup> starting 28 days prior to breeding through PND 18, no mention was made of reproductive performance variables such as the percentage of dams that delivered or the number of pups per litter (Dorman et al. 2005a).

The highest NOAEL values and all LOAEL values from each reliable study for reproductive effects in each species and duration category are recorded in Table 3-1 and plotted in Figure 3-1.

No studies were located concerning reproductive effects following inhalation exposure to organic manganese compounds in humans or animals.

## 3. HEALTH EFFECTS

**3.2.1.6 Developmental Effects**

Very little information is available on the developmental effects of inorganic manganese from inhalation exposure. The incidences of neurological disorders, birth defects, and stillbirths were elevated in a small population of people living on an island where there were rich manganese deposits (Kilburn 1987).

However, no conclusions could be reached on the causes of either the neurological effects or the increased incidence of birth defects and stillbirths because there were insufficient exposure data. Control data were not provided, and the study population was too small for meaningful statistical analysis.

Although inhalation exposure was not ruled out, the route of exposure was assumed to be primarily oral.

Lown et al. (1984) evaluated the developmental effects of inhaled manganese in mice. The study involved exposing dams and non-pregnant female mice to either filtered air or manganese at an average concentration of 61 mg/m<sup>3</sup> (as manganese dioxide) 7 hours/day, 5 days/week, for 16 weeks prior to conception. The authors then exposed the mice to either air or manganese post-conception, irrespective of preconception exposure. Once delivered, six pups (three of each sex) were distributed to foster mothers and then nursed in the absence of exposure to manganese. The pups were then evaluated on postpartum day 7 for weight gain and gross locomotor activity and on day 45 for different behavioral parameters and learning performance. The authors observed that pups raised by foster mothers that had been exposed to manganese preconception and filtered air postconception had reduced weights compared to pups raised by foster mothers exposed only to filtered air. The activity data indicated that there were no observable differences in activity between pups who had been exposed to manganese *in utero* and those that had not. Therefore, the data did not provide evidence that manganese exposure resulted in adverse neurological developmental effects.

No studies were located concerning developmental effects in humans or animals following inhalation exposure to organic manganese.

**3.2.1.7 Cancer**

No studies were located regarding carcinogenic effects in humans or animals after inhalation exposure to inorganic or organic manganese.

## 3. HEALTH EFFECTS

**3.2.2 Oral Exposure**

Although humans are often exposed to significant quantities of inorganic manganese compounds in food and water (see Sections 6.4 and 6.5), reports of adverse effects in humans from ingestion of excess manganese are limited. Most information on the effects of oral exposure to inorganic manganese is derived from studies in animals. These studies are summarized in Table 3-2 and Figure 3-2, and the findings are discussed below. All doses are expressed as mg manganese/kg/day.

Health effects following oral exposure to the organic manganese compound, MMT, were observed in animals. Studies involving oral exposure of animals to MMT are summarized in Table 3-3 and Figure 3-3. As discussed previously, because inhalation, oral, and dermal pathways are not a concern regarding exposure to mangafodipir, this compound's studies are not presented in an LSE table or figure; instead, they are discussed in Section 3.2.4.

**3.2.2.1 Death**

Two studies have been located in which death in humans may have been caused by the ingestion of manganese-contaminated water (Hafeman et al. 2007; Kawamura et al. 1941). Kawamura et al. (1941) reported death from "emaciation" in two adults who ingested drinking water contaminated with high levels of manganese. Hafeman et al. (2007) reported high mortality among infants <1 year of age in a Bangladesh population where the drinking water supplied by certain local wells contained high levels of manganese. As discussed in detail in Sections 3.2.2.4 (Kawamura et al. 1941) and 3.2.2.5 (Hafeman et al. 2007), several aspects of these two reports suggest that factors other than, or in addition to, high levels of manganese in drinking water may have been responsible for the deaths.

In animals, most studies indicate that manganese compounds have low acute oral toxicity when provided in feed. In rats, daily doses of 1,300 mg manganese/kg/day (as manganese sulfate in the feed) for 14 days did not affect survival (NTP 1993). Survival was decreased in male rats fed 200 mg manganese/kg/day (as manganese sulfate) for 2 years (NTP 1993). The cause of death was attributed to increased severity of nephropathy and renal failure; however, female rats fed 232 mg manganese/kg/day (as manganese sulfate) for 2 years were not affected in this manner (NTP 1993). Similarly, doses as high as 2,251 mg manganese/kg/day (as manganese chloride) in the diet were tolerated by male mice (females were not tested) for 6 months without lethality (Gianutsos and Murray 1982). The survival of both male and female mice was also unaffected by feeding as much as 731 mg manganese/kg/day (as manganese sulfate) for 2 years (NTP 1993).



Table 3-2 Levels of Significant Exposure to Inorganic Manganese - Oral

| Key to Figure         | Species <sup>a</sup> (Strain) | Exposure/Duration/Frequency (Route) | System | NOAEL (mg/kg/day) | LOAEL                    |   | Reference                         | Comments |
|-----------------------|-------------------------------|-------------------------------------|--------|-------------------|--------------------------|---|-----------------------------------|----------|
|                       |                               |                                     |        |                   | Less Serious (mg/kg/day) | Serious (mg/kg/day)                               |                                   |          |
| <b>ACUTE EXPOSURE</b> |                               |                                     |        |                   |                          |   |                                   |          |
| <b>Death</b>          |                               |                                     |        |                   |                          |   |                                   |          |
| 1                     | Rat (Sprague-Dawley)          | once (GW)                           |        |                   |                          | 412 M (LD50)                                      | Holbrook et al. 1975<br>MnCl2     |          |
| 2                     | Rat (albino)                  | once (GW)                           |        |                   |                          | 351 M (LD50)                                      | Kostial et al. 1978<br>MnCl2      |          |
| 3                     | Rat (Wistar)                  | once (GW)                           |        |                   |                          | 342 M (LD50)<br>331 F (LD50)<br>275 (LD50 - pups) | Kostial et al. 1989<br>MnCl2      |          |
| 4                     | Rat (Swiss albino)            | once (G)                            |        |                   |                          | 642 M (LD50)                                      | Singh and Junnarkar 1991<br>MnCl2 |          |
| 5                     | Rat (Swiss albino)            | once (G)                            |        |                   |                          | 782 M (LD50)                                      | Singh and Junnarkar 1991<br>MnSO4 |          |
| 6                     | Rat (Wistar)                  | once (GW)                           |        |                   |                          | 1082 (LD50)                                       | Smyth et al. 1969<br>MnOAc        |          |

\*\*\*DRAFT FOR PUBLIC COMMENT\*\*\*

Table 3-2 Levels of Significant Exposure to Inorganic Manganese - Oral

(continued)

| Key to Figure   | Species (Strain) | Exposure/Duration/Frequency (Route) | System  | NOAEL (mg/kg/day) | LOAEL  |  | Reference Chemical Form | Comments |
|-----------------|------------------|-------------------------------------|---------|-------------------|--|--|-------------------------|----------|
|                 |                  |                                     |         |                   | Less Serious (mg/kg/day)                           | Serious (mg/kg/day)                                  |                         |          |
| <b>Systemic</b> |                  |                                     |         |                   |  |  |                         |          |
| 7               | Rat (F344/N)     | 14 d (F)                            | Resp    | 1300              |  |  | NTP 1993<br>MnSO4       |          |
|                 |                  |                                     | Cardio  | 1300              |  |  |                         |          |
|                 |                  |                                     | Hemato  | 650 M<br>1300 F   | 1300 M (decreased leukocyte and neutrophil counts) |  |                         |          |
|                 |                  |                                     | Hepatic | 650 M<br>1300 F   | 1300 M (reduced liver weight)                      |  |                         |          |
|                 |                  |                                     | Renal   | 1300              |  |  |                         |          |
|                 |                  |                                     | Endocr  | 1300              |  |  |                         |          |
|                 |                  |                                     | Bd Wt   | 650               | 1300   | (57% decreased body weight in males; 20% in females) |                         |          |

\*\*\*DRAFT FOR PUBLIC COMMENT\*\*\*

Table 3-2 Levels of Significant Exposure to Inorganic Manganese - Oral

(continued)

| Key to Figure <sup>a</sup> | Species (Strain) | Exposure/Duration/Frequency (Route) | System  | LOAEL             |  | Reference Chemical Form     | Comments |
|----------------------------|------------------|-------------------------------------|---------|-------------------|--|-----------------------------|----------|
|                            |                  |                                     |         | NOAEL (mg/kg/day) | Less Serious (mg/kg/day)   |                             |          |
| 8                          | Mouse (B6C3F1)   | 14 d (F)                            | Resp    | 2600 M            |  | NTP 1993<br>MnSO4           |          |
|                            |                  |                                     |         | 3900 F            |  |                             |          |
|                            |                  |                                     | Cardio  | 2600 M            |  |                             |          |
|                            |                  |                                     |         | 3900 F            |  |                             |          |
|                            |                  |                                     | Hemato  | 2600 M            |  |                             |          |
|                            |                  |                                     |         | 3900 F            |  |                             |          |
|                            |                  |                                     | Hepatic | 2600 M            |  |                             |          |
|                            |                  |                                     |         | 3900 F            |  |                             |          |
|                            |                  |                                     | Renal   | 2600 M            |  |                             |          |
|                            |                  |                                     |         | 3900 F            |  |                             |          |
|                            |                  |                                     | Endocr  | 2600 M            |  |                             |          |
|                            |                  |                                     |         | 3900 F            |  |                             |          |
| <b>Neurological</b>        |                  |                                     |         |                   |  |                             |          |
| 9                          | Rat (Wistar)     | 6 d (GW)                            |         |                   | 22 M (increase in dihydroxyphenylacetic acid and uric acid in striatum)  | Desole et al. 1994<br>MnCl2 |          |
| 10                         | Rat (Wistar)     | 2 x/d<br>6 d<br>1 x (d 7)<br>(GW)   |         |                   | 8.8 M (decreased concentrations of dopamine in brainstem; glutathione depletion potentiated Mn effects on dopamine as well as concentrations of DOPAC and HVA) | Desole et al. 1997<br>MnCl2 |          |

\*\*\*DRAFT FOR PUBLIC COMMENT\*\*\*

Table 3-2 Levels of Significant Exposure to Inorganic Manganese - Oral

(continued)

| Key to Figure                | Species <sup>a</sup> (Strain) | Exposure/Duration/Frequency (Route) | System | LOAEL             |   | Reference  | Comments   |
|------------------------------|-------------------------------|-------------------------------------|--------|-------------------|---|--|--|
|                              |                               |                                     |        | NOAEL (mg/kg/day) | Less Serious (mg/kg/day)                              |  |  |
| 11                           | Rat (F344/N)                  | 14 d (F)                            |        | 1300              |   |  | NTP 1993<br>MnSO <sub>4</sub>                                  |
| 12                           | Rat (albino)                  | 1 d (GW)                            |        |                   | 13.9 (decreased acquisition of an avoidance reaction) |  | Shukakidze et al. 2003<br>MnCl <sub>2</sub> *4H <sub>2</sub> O |
| <b>Reproductive</b>          |                               |                                     |        |                   |   |  |  |
| 13                           | Rat (Sprague-Dawley)          | Gd 6-17 (GW)                        |        | 2200 F            |   |  | Grant et al. 1997<br>MnCl <sub>2</sub>                         |
| 14                           | Rat (Fischer- 344)            | 14 d (F)                            |        | 1300 M            |   |  | NTP 1993<br>MnSO <sub>4</sub>                                  |
| <b>Developmental</b>         |                               |                                     |        |                   |   |  |  |
| 15                           | Rat (Sprague-Dawley)          | Gd 6-17 (GW)                        |        | 2200              |   |  | Grant et al. 1997<br>MnCl <sub>2</sub>                         |
| <b>INTERMEDIATE EXPOSURE</b> |                               |                                     |        |                   |   |  |  |
| <b>Death</b>                 |                               |                                     |        |                   |   |  |  |
| 16                           | Rat (Long- Evans)             | 21 d (GW)                           |        |                   |   | 225 (LD50 - 21 days)   | Rehnberg et al. 1980<br>Mn <sub>3</sub> O <sub>4</sub>         |
| <b>Systemic</b>              |                               |                                     |        |                   |   |  |  |
| 17                           | Rat (Long- Evans)             | 224 d (F)                           | Hemato | 180 M             |   |  | Carter et al. 1980<br>Mn <sub>3</sub> O <sub>4</sub>           |
| 18                           | Rat (Wistar)                  | 1 x/d 28 d (F)                      | Bd Wt  |                   |   | 6 M (rats gained only 44% of amount gained by control rats with normal food consumption) | Exon and Koller 1975<br>Mn <sub>3</sub> O <sub>4</sub>         |

\*\*\*DRAFT FOR PUBLIC COMMENT\*\*\*

MANGANESE

3. HEALTH EFFECTS

96

Table 3-2 Levels of Significant Exposure to Inorganic Manganese - Oral

(continued)

| Key to Figure | Species (Strain) | Exposure/Duration/Frequency (Route) | System  | NOAEL (mg/kg/day) | LOAEL                               |                     | Reference Chemical Form | Comments |
|---------------|------------------|-------------------------------------|---------|-------------------|-------------------------------------|---------------------|-------------------------|----------|
|               |                  |                                     |         |                   | Less Serious (mg/kg/day)            | Serious (mg/kg/day) |                         |          |
| 19            | Rat (F344/N)     | 13 wk (F)                           | Resp    |                   | 40 F (reduced lung weight)          |                     | NTP 1993<br>MnSO4       |          |
|               |                  |                                     | Cardio  | 520 M             |                                     |                     |                         |          |
|               |                  |                                     |         | 618 F             |                                     |                     |                         |          |
|               |                  |                                     | Gastro  | 520 M             |                                     |                     |                         |          |
|               |                  |                                     |         | 618 F             |                                     |                     |                         |          |
|               |                  |                                     | Hemato  |                   | 33 M (increased neutrophil count)   |                     |                         |          |
|               |                  |                                     |         |                   | 155 F (decreased leukocyte count)   |                     |                         |          |
|               |                  |                                     | Hepatic |                   | 33 M (decreased liver weight)       |                     |                         |          |
|               |                  |                                     |         |                   | 618 F (decreased liver weight)      |                     |                         |          |
|               |                  |                                     | Renal   | 520 M             |                                     |                     |                         |          |
|               |                  |                                     |         | 618 F             |                                     |                     |                         |          |
|               |                  |                                     | Endocr  | 520 M             |                                     |                     |                         |          |
|               |                  |                                     |         | 618 F             |                                     |                     |                         |          |
|               |                  |                                     | Bd Wt   | 77 F              | 155 F (11% decrease in body weight) |                     |                         |          |

\*\*\*DRAFT FOR PUBLIC COMMENT\*\*\*

Table 3-2 Levels of Significant Exposure to Inorganic Manganese - Oral

(continued)

| Key to Figure | Species (Strain)     | Exposure/Duration/Frequency (Route) | System  | NOAEL (mg/kg/day) | LOAEL  |                     | Reference Chemical Form                 | Comments  |
|---------------|----------------------|-------------------------------------|---------|-------------------|--|---------------------|---|---|
|               |                      |                                     |         |                   | Less Serious (mg/kg/day)   | Serious (mg/kg/day) |   |   |
| 20            | Rat (Sprague-Dawley) | 63 d (GW)                           | Renal   |                   | 87 M (increased incidence of glomerulosclerosis/ glomerulonephritis or urolithiasis [i.e., bile stone formation] in males) |                     | Ponnapakkam et al. 2003b<br>MnOAc       | Rats sacrificed immediately after last day of dosing. No urolithiasis observed in females of any treatment group. |
| 21            | Rat (Sprague-Dawley) | Gd 0-21 (GW)                        | Endocr  | 33 F              |  |                     | Szakmary et al. 1995<br>MnCl2           | No effect on secretion or peripheral blood levels of progesterone or 17b-estradiol.                               |
|               |                      |                                     | Metab   |                   | 11 F (increased cytochrome P450)   |                     |   |   |
| 22            | Rat (white)          | 10 wk (W)                           | Hepatic | 12 M              |  |                     | Wassermann and Wassermann 1977<br>MnCl2 | Only ultrastructural changes in liver cells were noted.   |
| 23            | Mouse Swiss          | 12 wk (W)                           | Bd Wt   | 277 F             |  |                     | Elbetieha et al. 2001<br>MnCl2          |   |
| 24            | Mouse (CD-1)         | 90 d (F)                            | Hepatic | 205 M             |  |                     | Gray and Laskey 1980<br>Mn3O4           | No clinical signs or changes in body, kidney or liver weights.  |
|               |                      |                                     | Renal   | 205 M             |  |                     |   |   |

\*\*\*DRAFT FOR PUBLIC COMMENT\*\*\*

Table 3-2 Levels of Significant Exposure to Inorganic Manganese - Oral

(continued)

| Key to Figure | Species (Strain) | Exposure/Duration/Frequency (Route) | System | NOAEL (mg/kg/day) | LOAEL   |                     | Reference Chemical Form           | Comments |
|---------------|------------------|-------------------------------------|--------|-------------------|---|---------------------|-----------------------------------|----------|
|               |                  |                                     |        |                   | Less Serious (mg/kg/day)  | Serious (mg/kg/day) |                                   |          |
| 25            | Mouse (ddY)      | 100 d (F)                           | Hemato |                   | 284 M (decreased red blood cell count and white blood cell count) |                     | Komura and Sakamoto 1991<br>MnOAc |          |
|               |                  |                                     | Bd Wt  |                   | 284 M (10% decrease in body weight gain)                          |                     |                                   |          |
| 26            | Mouse (ddY)      | 100 d (F)                           | Hemato |                   | 284 M (decreased hematocrit)                                      |                     | Komura and Sakamoto 1991<br>MnCO3 |          |
| 27            | Mouse (ddY)      | 100 d (F)                           | Hemato |                   | 284 M (decreased white blood cell count)                          |                     | Komura and Sakamoto 1991<br>MnO2  |          |
| 28            | Mouse (ddY)      | 100 d (F)                           | Hemato |                   | 284 M (decreased red blood cell count and white blood cell count) |                     | Komura and Sakamoto 1991<br>MnCl2 |          |
|               |                  |                                     | Bd Wt  |                   | 284 M (10% decrease in body weight gain)                          |                     |                                   |          |

\*\*\*DRAFT FOR PUBLIC COMMENT\*\*\*

Table 3-2 Levels of Significant Exposure to Inorganic Manganese - Oral

(continued)

| Key to Figure | Species (Strain) | Exposure/Duration/Frequency (Route) | System  | NOAEL (mg/kg/day) | LOAEL  |                     | Reference Chemical Form        | Comments |
|---------------|------------------|-------------------------------------|---------|-------------------|--|---------------------|--------------------------------|----------|
|               |                  |                                     |         |                   | Less Serious (mg/kg/day)   | Serious (mg/kg/day) |                                |          |
| 29            | Mouse (B6C3F1)   | 13 wk (F)                           | Resp    | 1950              |  |                     | NTP 1993<br>MnSO4              |          |
|               |                  |                                     | Cardio  | 1950              |  |                     |                                |          |
|               |                  |                                     | Gastro  | 975 M<br>1950 F   | 1950 M (mild hyperplasia and hyperkeratosis of the forestomach)                  |                     |                                |          |
|               |                  |                                     | Hemato  | 975               | 1950 (decreased hematocrit, hemoglobin, and erythrocyte count)                   |                     |                                |          |
|               |                  |                                     | Hepatic | 975 M<br>1950 F   | 1950 M (reduced liver weight)  |                     |                                |          |
|               |                  |                                     | Renal   | 1950              |  |                     |                                |          |
|               |                  |                                     | Endocr  | 1950              |  |                     |                                |          |
|               |                  |                                     | Bd Wt   | 975 M<br>1950 F   | 1950 M (13% lower body weight compared to controls)                              |                     |                                |          |
| 30            | Gn Pig           | 30 d; 1 d (G)                       | Gastro  |                   | 4.4 M (patchy necrosis, decreased ATPase, GTPase in stomach and small intestine) |                     | Chandra and Imam 1973<br>MnCl2 |          |

\*\*\*DRAFT FOR PUBLIC COMMENT\*\*\*

MANGANESE

3. HEALTH EFFECTS



Table 3-2 Levels of Significant Exposure to Inorganic Manganese - Oral

(continued)

| Key to<br>Figure         | Species<br>(Strain)         | Exposure/<br>Duration/<br>Frequency<br>(Route) | System | NOAEL<br>(mg/kg/day) | LOAEL   |                        | Reference<br>Chemical Form     | Comments   |
|--------------------------|-----------------------------|--|--------|----------------------|---|------------------------|--------------------------------|--|
|                          |                             |  |        |                      | Less Serious<br>(mg/kg/day)   | Serious<br>(mg/kg/day) |                                |  |
| <b>Immuno/ Lymphoret</b> |                             |  |        |                      |   |                        |                                |  |
| 31                       | Rat<br>(F344/N)             | 13 wk<br>(F)                                   |        |                      | 33 M (increased neutrophil<br>count)  |                        | NTP 1993<br>MnSO4              |  |
|                          |                             |  |        |                      | 155 F (decreased leukocyte<br>count)  |                        |                                |  |
| <b>Neurological</b>      |                             |  |        |                      |   |                        |                                |  |
| 32                       | Human                       | 1 x/d<br>8 wk<br>varying dose<br>(IN)          |        | 0.3 F                |   |                        | Finley et al. 2003<br>MnSO4    | The high Mn diet did<br>not influence<br>neuropsychological<br>variables (interpersonal<br>behavior survey and<br>state-trait anger<br>expression) or<br>handsteadiness. |
| 33                       | Monkey<br>(Rhesus)          | 4 mo during<br>infancy<br>(F)                  |        |                      | 107.5 M (minimally adverse<br>behavioral effects in soy<br>and soy+Mn groups:<br>decreased activity during<br>sleep at 4 months and<br>decreased play activity<br>between 1-1.5 months) |                        | Golub et al. 2005<br>MnCl2     | No marked differences<br>from controls in gross<br>motor maturation,<br>growth, or cognitive<br>tests. No effect of Mn<br>on CSF DA, HVA or<br>5-HIAA.                   |
| 34                       | Rat<br>(Sprague-<br>Dawley) | 6 wk<br>(W)                                    |        |                      | 71.1 (decreased Fe levels in<br>caudate putamen and<br>substantia nigra;<br>decreased GABA uptake<br>activity in striatal<br>synaptosomes)  |                        | Anderson et al. 2007a<br>MnCl2 |  |

\*\*\*DRAFT FOR PUBLIC COMMENT\*\*\*

MANGANESE

3. HEALTH EFFECTS

101

Table 3-2 Levels of Significant Exposure to Inorganic Manganese - Oral

(continued)

| Key to Figure | Species <sup>a</sup> (Strain) | Exposure/Duration/Frequency (Route) | System | NOAEL (mg/kg/day) | LOAEL   |                     | Reference Chemical Form          | Comments |
|---------------|-------------------------------|-------------------------------------|--------|-------------------|---|---------------------|----------------------------------|----------|
|               |                               |                                     |        |                   | Less Serious (mg/kg/day)  | Serious (mg/kg/day) |                                  |          |
| 35            | Rat (Sprague-Dawley)          | 2 mo (W)                            |        |                   | 594 M (increased gamma-aminobutyric acid levels)  |                     | Bonilla 1978b<br>MnCl2           |          |
| 36            | Rat (Sprague-Dawley)          | 8 mo (W)                            |        |                   | 392.5 M (increased L-tyrosine hydroxylase activity in neostriatum, midbrain, hippocampus, and hypothalamus) |                     | Bonilla 1980<br>MnCl2            |          |
| 37            | Rat (Sprague-Dawley)          | 8 mo (W)                            |        |                   | 13 M (decreased norepinephrine levels)  |                     | Bonilla and Prasad 1984<br>MnCl2 |          |
| 38            | Rat (CD)                      | pnd 1-49 (GW)                       |        | 11                | 22 (increased spontaneous motor activity)   |                     | Brenneman et al. 1999<br>MnCl2   |          |

\*\*\*DRAFT FOR PUBLIC COMMENT\*\*\*

Table 3-2 Levels of Significant Exposure to Inorganic Manganese - Oral

(continued)

| Key to Figure <sup>a</sup> | Species (Strain) | Exposure/Duration/Frequency (Route) | System | NOAEL (mg/kg/day) | LOAEL  |                     | Reference Chemical Form                    | Comments  |
|----------------------------|------------------|-------------------------------------|--------|-------------------|--|---------------------|--|---|
|                            |                  |                                     |        |                   | Less Serious (mg/kg/day)   | Serious (mg/kg/day) |  |   |
| 39                         | Rat (Wistar)     | 10 wk (W)                           |        |                   | 1310 M (significantly increased open field activity, significantly elevated, continued interest in a novel object and increased fear; enhanced dopaminergic inhibitory control of corticostriatal excitatory transmission) |                     | Calabresi et al. 2001<br>MnCl <sub>2</sub> | No effects on radial maze performance, neuronal numbers in striatum, levels of GFAP and TH in striatum, or membrane properties of striatal neurons. |
| 40                         | Rat (Wistar)     | 10 wk (W)                           |        |                   | 1310 M (increased frequency and amplitude of spontaneous excitatory membrane potentials in corticostriatal slices from Mn-treated rats compared with control rats)   |                     | Centonze et al. 2001<br>MnCl <sub>2</sub>  |   |
| 41                         | Rat (albino)     | 30 d (W)                            |        |                   | 146.7 M (increased activity and aggression, turnover of striatal dopamine, tyrosine and homovanillic acid, altered neurotransmitter levels)  |                     | Chandra 1983<br>MnCl <sub>2</sub>          |   |

\*\*\*DRAFT FOR PUBLIC COMMENT\*\*\*

Table 3-2 Levels of Significant Exposure to Inorganic Manganese - Oral

(continued)

| Key to<br>Figure <sup>a</sup> | Species<br>(Strain)  | Exposure/<br>Duration/<br>Frequency<br>(Route) | System | NOAEL<br>(mg/kg/day) | LOAEL  |   | Reference<br>Chemical Form                                      | Comments   |
|-------------------------------|----------------------|--|--------|----------------------|--|---|---|--|
|                               |                      |  |        |                      | Less Serious<br>(mg/kg/day)  | Serious<br>(mg/kg/day)  |   |  |
| 42                            | Rat<br>(ITRC albino) | 60 d<br>(GW)                                   |        |                      |  | 0.31 M (increased monoamine oxidase activity in the brain, neuronal degeneration in cerebral and cerebellar cortex and caudate nucleus) | Chandra and Shukla 1978<br>MnCl <sub>2</sub> *4H <sub>2</sub> O | No evidence of behavioral changes or locomotor disturbances; exposure started at 21 days of age. |
| 43                            | Rat<br>(ITRC albino) | 360 d<br>(W)                                   |        |                      | 40 M (increase of dopamine, norepinephrine, and homovanillic acid above control levels in striatum observed at 15-60 days of treatment, followed by a decrease of all three compounds below control levels at 300-360 days of treatment) |   | Chandra and Shukla 1981<br>MnCl <sub>2</sub>                    |  |
| 44                            | Rat<br>(CD Neonatal) | 24 d<br>(GW)                                   |        | 1 M                  | 10 M (decreased dopamine levels in the hypothalamus, significant decrease in hypothalamic tyrosine hydroxylase activity, significant increase in hypothalamic monoamine oxidase activity)  |   | Deskin et al. 1980<br>MnCl <sub>2</sub>                         |  |

\*\*\*DRAFT FOR PUBLIC COMMENT\*\*\*

Table 3-2 Levels of Significant Exposure to Inorganic Manganese - Oral

(continued)

| Key to Figure | Species (Strain)     | Exposure/ Duration/ Frequency (Route) | System | NOAEL (mg/kg) | LOAEL  |                 | Reference Chemical Form        | Comments |
|---------------|----------------------|---------------------------------------|--------|---------------|--|-----------------|--------------------------------|----------|
|               |                      |                                       |        |               | Less Serious (mg/kg)   | Serious (mg/kg) |                                |          |
| 45            | Rat (CD)             | pnd 0-24 (GW)                         |        | 15            | 20 M (increased serotonin in hypothalamus, decreased acetylcholinesterase in striatum)   |                 | Deskin et al. 1981<br>MnCl2    |          |
| 46            | Rat                  | 21 d 1 x/d (GW)                       |        |               | 11 (significant increase in pulse elicited startle reflex at pnd 21)   |                 | Dorman et al. 2000<br>MnCl2    |          |
| 47            | Rat                  | 100-265 d (W)                         |        |               | 390 M (increased dopamine and dopamine metabolite levels)  |                 | Eriksson et al. 1987a<br>MnCl2 |          |
| 48            | Rat (Sprague-Dawley) | Gd 7- pnd 21 (F)                      |        |               | 8 (hematological changes indicative of Fe deficiency in dams and pups; increased levels of the inhibitory neurotransmitter, GABA, in pup brains) |                 | Garcia et al. 2006<br>NS       |          |

\*\*\*DRAFT FOR PUBLIC COMMENT\*\*\*

Table 3-2 Levels of Significant Exposure to Inorganic Manganese - Oral

(continued)

| Key to Figure <sup>a</sup> | Species (Strain)      | Exposure/ Duration/ Frequency (Route) | System | NOAEL (mg/kg/day) | LOAEL  |                     | Reference Chemical Form                      | Comments  |
|----------------------------|-----------------------|---------------------------------------|--------|-------------------|--|---------------------|--|---|
|                            |                       |                                       |        |                   | Less Serious (mg/kg/day)   | Serious (mg/kg/day) |  |   |
| 49                         | Rat (Long- Evans)     | 20 d Gd 0-20 (W)                      |        | 1248              |  |                     | Kontur and Fechter 1985<br>MnCl <sub>2</sub> | No effect on dopamine or norepinephrine turnover in the forebrain or hindbrain and no effect on development of acoustic startle response. |
| 50                         | Rat (Long- Evans)     | 14-21 d (GO)                          |        | 13.8              |  |                     | Kontur and Fechter 1988<br>MnCl <sub>2</sub> | No effect on monoamine levels or their metabolites in the striatum, hypothalamus or nucleus accumbens.                                    |
| 51                         | Rat                   | 44 d (GW)                             |        |                   |  | 150 (ataxia)        | Kristensson et al. 1986<br>MnCl <sub>2</sub> |   |
| 52                         | Rat (Sprague- Dawley) | 30 d (GW)                             |        |                   | 2.2 M (redistribution of iron in body fluids associated with upregulation of transferrin receptor mRNA and downregulation of ferritin mRNA from the choroid plexus and striatum) |                     | Li et al. 2006<br>MnCl <sub>2</sub>          | Observed effects likely to be marginally to minimally adverse.  |

\*\*\*DRAFT FOR PUBLIC COMMENT\*\*\*

MANGANESE

3. HEALTH EFFECTS

106

Table 3-2 Levels of Significant Exposure to Inorganic Manganese - Oral

(continued)

| Key to Figure <sup>a</sup> | Species (Strain)     | Exposure/ Duration/ Frequency (Route) | System | NOAEL (mg/kg/day) | LOAEL  |                     | Reference Chemical Form                                     | Comments   |
|----------------------------|----------------------|---------------------------------------|--------|-------------------|--|---------------------|---|--|
|                            |                      |                                       |        |                   | Less Serious (mg/kg/day)   | Serious (mg/kg/day) |   |  |
| 53                         | Rat (Sprague-Dawley) | 30 d (GO)                             |        | 10 M              | 20 M (significant [p < 0.05] body weight decrease [~9%] and significant [p < 0.05] increase in aspartate, glutamate, glutamine, taurine and GABA in the cerebellum [~20-50%, depending upon the amino acid] of adult rats) |                     | Lipe et al. 1999<br>MnCl <sub>2</sub>                       |  |
| 54                         | Rat (Wistar)         | 4 wk (W)                              |        | 15.1 M            | 26.7 M (increases in striatal Mn levels in cirrhotic rats, striatal neurotransmitter [dopamine or homovanillic acid] increased with or without cirrhosis)  |                     | Montes et al. 2001<br>MnCl <sub>2</sub> *4H <sub>2</sub> O  | No effect on bilirubins, alanine aminotransferase or collagen at either dose with or without bile duct ligation. |
| 55                         | Rat (Wistar)         | 13 wk (W)                             |        |                   | 611 M (33% reduction in immunoreactive cells with glutamine synthetase in the globus pallidus)   |                     | Morello et al. 2007<br>MnCl <sub>2</sub> *4H <sub>2</sub> O |  |

\*\*\*DRAFT FOR PUBLIC COMMENT\*\*\*

MANGANESE

3. HEALTH EFFECTS

107

Table 3-2 Levels of Significant Exposure to Inorganic Manganese - Oral

(continued)

| Key to<br>Figure <sup>a</sup> | Species<br>(Strain)         | Exposure/<br>Duration/<br>Frequency<br>(Route) | System | NOAEL<br>(mg/kg/day) | LOAEL  |                        | Reference<br>Chemical Form      | Comments  |
|-------------------------------|-----------------------------|--|--------|----------------------|--|------------------------|---------------------------------|---|
|                               |                             |  |        |                      | Less Serious<br>(mg/kg/day)  | Serious<br>(mg/kg/day) |                                 |   |
| 56                            | Rat<br>(F344/N)             | 13 wk<br>(F)                                   |        | 520 M<br><br>618 F   |  |                        | NTP 1993<br>MnSO4               |   |
| 57                            | Rat<br>(Sprague-<br>Dawley) | Gd 1- pnd 30<br>(W)                            |        |                      | 120 M (significant decrease in<br>cortical thickness; with<br>high dose rats<br>demonstrating evidence<br>of hyperactivity<br>[significantly increased<br>locomotor activity and<br>increased rearing in an<br>open field] on pnd 17)                      |                        | Pappas et al. 1997<br>MnCl2     |   |
| 58                            | Rat<br>(Sprague-<br>Dawley) | 50 d<br>(NS)                                   |        |                      | 74.9 M (increased serum levels<br>of dopamine sulfate,<br>L-Dopa, and L-p-tyrosine<br>and decreased levels of<br>dopamine)   |                        | Ranasinghe et al. 2000<br>MnSO4 |   |
| 59                            | Rat<br>(Sprague-<br>Dawley) | 21 d<br>(NS)                                   |        | 4.4 M                | 13.1 M (subtle behavioral effects<br>[altered balance in the<br>neonatal period and<br>diminished locomotor<br>response to cocaine in<br>adulthood] and<br>neurochemical effects in<br>adulthood [decreased<br>dopamine binding sites in<br>the striatum]) |                        | Reichel et al. 2006<br>MnCl2    | No change in negative<br>geotaxis performance;<br>no change in motor<br>activity, coordination, or<br>olfactory orientation<br>tasks. |

\*\*\*DRAFT FOR PUBLIC COMMENT\*\*\*

MANGANESE

3. HEALTH EFFECTS

108



Table 3-2 Levels of Significant Exposure to Inorganic Manganese - Oral

(continued)

| Key to Figure | Species (Strain)     | Exposure/Duration/Frequency (Route) | System | NOAEL (mg/kg/day) | LOAEL  |                     | Reference Chemical Form                           | Comments   |  |
|---------------|----------------------|-------------------------------------|--------|-------------------|--|---------------------|---|--|--|
|               |                      |                                     |        |                   | Less Serious (mg/kg/day)   | Serious (mg/kg/day) |   |  |  |
| 60            | Rat (albino)         | 30 d (F)                            |        |                   |  | 5.6                 | (severely impaired cognitive performance in maze) | Shukakidze et al. 2003<br>MnCl <sub>2</sub> *4H <sub>2</sub> O |  |
| 61            | Rat (Wistar)         | 13 wk (W)                           |        |                   | 3311 M (impaired ability of globus pallidus neurons to survive mechanical dissociation)  |                     |   | Spadoni et al. 2000 (NS)                                       | No neuronal loss or gliosis (GFAP accumulation) was evident in globus pallidus by either histological or immunohistochemical examination).           |
| 62            | Rat (albino)         | 90 d (W)                            |        |                   | 11.8 M (altered brain regional dopamine and serotonin levels and monoamine oxidase activity)   |                     |   | Subhash and Padmashree 1991<br>MnCl <sub>2</sub>               |  |
| 63            | Rat (Sprague-Dawley) | 21 wk (GW, W)                       |        | 76 M              | 153 M (significantly decreased open field activity among restrained rats, impaired spatial learning with or without restraint in a water maze) |                     |   | Torrente et al. 2005<br>MnCl <sub>2</sub> *4H <sub>2</sub> O   | All MnCl <sub>2</sub> *4H <sub>2</sub> O rats received 38 mg Mn/kg/d for the first 2 weeks. Other groups at these doses were restrained 2 hours/day. |

\*\*\*DRAFT FOR PUBLIC COMMENT\*\*\*

MANGANESE

3. HEALTH EFFECTS

109

Table 3-2 Levels of Significant Exposure to Inorganic Manganese - Oral

(continued)

| Key to Figure <sup>a</sup> | Species (Strain)     | Exposure/ Duration/ Frequency (Route) | System | NOAEL (mg/kg/day) | LOAEL                    |   | Reference Chemical Form               | Comments   |
|----------------------------|----------------------|---------------------------------------|--------|-------------------|--------------------------|---|---------------------------------------|--|
|                            |                      |                                       |        |                   | Less Serious (mg/kg/day) | Serious (mg/kg/day)   |                                       |  |
| 64                         | Rat (Sprague-Dawley) | 20 d (GO)                             |        | 3.8               | 7.5                      | (olfactory discrimination [homing test], and performance on a passive avoidance task; striatal dopamine concentrations were about 50% lower than control values)    | Tran et al. 2002a<br>MnCl2            | No significant (p <0.05) exposure-related effects on righting test conducted on pnd 6.                               |
| 65                         | Rat (Sprague-Dawley) | 20 d (GO)                             |        | 7.5 M             |                          |   | Tran et al. 2002b<br>MnCl2            | No statistically significant effects in either burrowing detour task or passive avoidance task.                      |
| 66                         | Rat (Wistar)         | 22 wk (GW)                            |        |                   | 6.5 M                    | (significant decreases in spatial memory performance, open field locomotor activity and acoustic startle responses; increased latency of sensory evoked potentials) | Vezer et al. 2005, 2007<br>MnCl2*4H2O | Impairment of spatial memory performance and acoustic startle response persisted through 5-7 weeks without exposure. |
| 67                         | Rat (CD)             | 21 d (IN)                             |        | 13.8              |                          |   | Weber et al. 2002<br>MnCl2*4H2O       | No important changes observed on endpoints of oxidative stress in the brain.   |

\*\*\*DRAFT FOR PUBLIC COMMENT\*\*\*

Table 3-2 Levels of Significant Exposure to Inorganic Manganese - Oral

(continued)

| Key to Figure <sup>a</sup> | Species (Strain) | Exposure/Duration/Frequency (Route) | System | NOAEL (mg/kg/day) | LOAEL  |                     | Reference Chemical Form   | Comments |
|----------------------------|------------------|-------------------------------------|--------|-------------------|--|---------------------|---|----------|
|                            |                  |                                     |        |                   | Less Serious (mg/kg/day)   | Serious (mg/kg/day) |   |          |
| 68                         | Mouse (CD-1)     | 6 mo (F)                            |        |                   | 2250.7 M (decreased dopamine levels)   |                     | Gianutsos and Murray 1982<br>MnCl <sub>2</sub>  |          |
| 69                         | Mouse (CD-1)     | 90 d (F)                            |        |                   | 205 M (decreased locomotor activity)   |                     | Gray and Laskey 1980<br>Mn <sub>3</sub> O <sub>4</sub>                                      |          |
| 70                         | Mouse (ddY)      | 100 d (F)                           |        |                   | 284 M (decreased motor activity)   |                     | Komura and Sakamoto 1991<br>MnCl <sub>2</sub> , MnOAc, MnCO <sub>3</sub> , MnO <sub>2</sub> |          |
| 71                         | Mouse (C57BL/6N) | 1 x/d<br>8 wk (GW)                  |        |                   | 43.7 F (increased locomotor activity in Mn-treated mice; increased Mn content of striatum and substantia nigra; decreased striatal dopamine; increased apoptotic neurons expressing nitric oxide synthase, choline acetyltransferase and enkephalin in striatum and globus pallidus; increased astrocytes expressing evidence of nitric oxide formation) |                     | Liu et al. 2006<br>MnCl <sub>2</sub>  |          |
| 72                         | Mouse (B6C3F1)   | 13 wk (F)                           |        | 1950              |  |                     | NTP 1993<br>MnSO <sub>4</sub>   |          |

\*\*\*DRAFT FOR PUBLIC COMMENT\*\*\*

Table 3-2 Levels of Significant Exposure to Inorganic Manganese - Oral

(continued)

| Key to Figure <sup>a</sup> | Species (Strain)     | Exposure/Duration/Frequency (Route) | System | LOAEL             |  |   | Reference Chemical Form                              | Comments   |
|----------------------------|----------------------|-------------------------------------|--------|-------------------|--|---|--|--|
|                            |                      |                                     |        | NOAEL (mg/kg/day) | Less Serious (mg/kg/day)   | Serious (mg/kg/day)                                   |  |  |
| <b>Reproductive</b>        |                      |                                     |        |                   |  |   |  |  |
| 73                         | Rat (Long- Evans)    | 20 d Gd 0-20 (W)                    |        | 624 F             | 1248 F (decreased litter weight)                                       |   | Kontur and Fechter 1985<br>MnCl <sub>2</sub>         |  |
| 74                         | Rat (Long- Evans)    | 100-224 d (F)                       |        | 20 M<br>55 F      | 55 M (significantly decreased testicular weight with low-Fe diet)      | 180 F (significantly decreased [~25%] pregnancy rate) | Laskey et al. 1982<br>Mn <sub>3</sub> O <sub>4</sub> | No effect on litter size, ovulations, resorptions, preimplantation deaths or mean fetal weights. No effect on testosterone or LH levels. |
| 75                         | Rat (Sprague-Dawley) | Gd 1- pnd 30 (W)                    |        | 620 F             |  |   | Pappas et al. 1997<br>MnCl <sub>2</sub>              | Mn exposure of pregnant dams did not affect litter sizes or sex ratios of pups at delivery.  |
| 76                         | Rat (Sprague-Dawley) | 63 d (GW)                           |        | 68.6 M            | 137.2 M (increased incidences of testicular degeneration in male rats) |   | Ponnapakkam et al. 2003c<br>MnOAc*4H <sub>2</sub> O  |  |
| 77                         | Rat (Sprague-Dawley) | Gd 0-21 (GW)                        |        |                   | 22 F (increase in relative weight of liver, thymus, and brain)         | 33 F (post implantation loss)                         | Szakmary et al. 1995<br>MnCl <sub>2</sub>            |  |

\*\*\*DRAFT FOR PUBLIC COMMENT\*\*\*

Table 3-2 Levels of Significant Exposure to Inorganic Manganese - Oral

(continued)

| Key to Figure <sup>a</sup> | Species (Strain) | Exposure/Duration/Frequency (Route) | System | LOAEL             |   | Reference Chemical Form   | Comments   |
|----------------------------|------------------|-------------------------------------|--------|-------------------|---|---|--|
|                            |                  |                                     |        | NOAEL (mg/kg/day) | Less Serious (mg/kg/day)                                  |   |  |
| 78                         | Mouse Swiss      | 12 wk (W)                           |        | 154 M             |   | 309 M (statistically significantly impaired male fertility)   | Elbetieha et al. 2001<br>MnCl <sub>2</sub>   |
| 79                         | Mouse Swiss      | 12 wk (W)                           |        |                   | 44 F (increased uterine weights relative to body weight)  | 277 F (implantation number reduced by 17% and the number of viable fetuses reduced by 19% from the control value) | Elbetieha et al. 2001<br>MnCl <sub>2</sub>   |
| 80                         | Mouse (CD-1)     | 90 d (F)                            |        |                   | 205 M (delayed growth of testes and sex accessory glands) |   | Gray and Laskey 1980<br>Mn <sub>3</sub> O <sub>4</sub>   |
| 81                         | Mouse (B6C3F1)   | 13 wk (F)                           |        | 1950              |   |   | NTP 1993<br>MnSO <sub>4</sub>  |
| 82                         | Mouse (CD-1)     | 1 x/d<br>43 d (GW)                  |        | 2.4 M             | 4.8 M (decreased sperm motility and sperm counts)         |   | Ponnapakkam et al. 2003a<br>MnOAc<br><br>No effects on fertility at 9.6 mg/kg/day when treated males were mated with unexposed females.  |
| 83                         | Mouse (CD-1)     | 1 x/d<br>43 d (GW)                  |        | 9.6 M             |   |   | Ponnapakkam et al. 2003a<br>MnOAc<br><br>Fertility endpoints were not affected at 9.6 mg Mn/kg/day. Fertility was not affected when exposed males mated with nonexposed females. |

\*\*\*DRAFT FOR PUBLIC COMMENT\*\*\*

MANGANESE

3. HEALTH EFFECTS

113

Table 3-2 Levels of Significant Exposure to Inorganic Manganese - Oral

(continued)

| Key to<br>Figure     | Species<br>(Strain)     | Exposure/<br>Duration/<br>Frequency<br>(Route) | System | NOAEL<br>(mg/kg) | LOAEL  |                    | Reference<br>Chemical Form                 | Comments   |
|----------------------|-------------------------|--|--------|------------------|--|--------------------|--|--|
|                      |                         |  |        |                  | Less Serious<br>(mg/kg)  | Serious<br>(mg/kg) |  |  |
| 84                   | Rabbit<br>(New Zealand) | Gd 6-20<br>(GW)                                |        | 33 F             |  |                    | Szakmary et al. 1995<br>MnCl <sub>2</sub>  |  |
| <b>Developmental</b> |                         |  |        |                  |  |                    |  |  |
| 85                   | Monkey<br>(Rhesus)      | 4 mo<br>(F)                                    |        |                  | 107.5 M (minimally adverse effects in soy and soy+Mn groups: decreased activity during sleep at 4 months and decreased play activity between 1-1.5 months) |                    | Golub et al. 2005<br>MnCl <sub>2</sub>     | No marked differences from controls in gross motor maturation, growth, or cognitive tests. No effect of Mn on CSF DA, HVA or 5-HIAA. |
| 86                   | Rat<br>(CD)             | pnd 1-49<br>(W)                                |        | 11               | 22 (~20% decrease in body weight at pnd 49)  |                    | Brenneman et al. 1999<br>MnCl <sub>2</sub> |  |
| 87                   | Rat<br>(CD)             | pnd 1-49<br>(GW)                               |        | 11               | 22 (increased spontaneous motor activity)  |                    | Brenneman et al. 1999<br>MnCl <sub>2</sub> |  |
| 88                   | Rat                     | 21 d<br>1 x/d<br>(GW)                          |        |                  | 11 (significant increase in pulse elicited startle reflex at pnd 21)   |                    | Dorman et al. 2000<br>MnCl <sub>2</sub>    |  |

\*\*\*DRAFT FOR PUBLIC COMMENT\*\*\*

MANGANESE

3. HEALTH EFFECTS

114

Table 3-2 Levels of Significant Exposure to Inorganic Manganese - Oral

(continued)

| Key to Figure <sup>a</sup> | Species (Strain)     | Exposure/ Duration/ Frequency (Route) | System | NOAEL (mg/kg/day) | LOAEL                    |  | Reference Chemical Form                      | Comments   |
|----------------------------|----------------------|---------------------------------------|--------|-------------------|--------------------------|--|--|--|
|                            |                      |                                       |        |                   | Less Serious (mg/kg/day) | Serious (mg/kg/day)  |  |  |
| 89                         | Rat (Sprague-Dawley) | Gd 7- pnd 21 (F)                      |        |                   | 8                        | (hematological changes indicative of Fe deficiency in dams and pups; increased levels of the inhibitory neurotransmitter, GABA, in pup brains)   | Garcia et al. 2006<br>NS                     |  |
| 90                         | Rat (Sprague-Dawley) | 17 d (F)                              |        | 8                 |                          |  | Garcia et al. 2007<br>NS                     |  |
| 91                         | Rat                  | 44 d (GW)                             |        |                   |                          | 150 (ataxia)   | Kristensson et al. 1986<br>MnCl <sub>2</sub> |  |
| 92                         | Rat (Sprague-Dawley) | Gd 1- pnd 30 (W)                      |        | 120 M             | 620 M                    | (transient decrease (~20%) in pup body weight on pnd 9-24; difference not apparent on pnd 90)  | Pappas et al. 1997<br>MnCl <sub>2</sub>      | No maternal toxicity from Mn; brain Mn not significantly elevated at 120 mg/kg/day; no effects on brain levels of serotonin or 5-HIAA. |
| 93                         | Rat (Sprague-Dawley) | 21 d (NS)                             |        | 4.4 M             | 13.1 M                   | (subtle behavioral effects [altered balance in the neonatal period and diminished locomotor response to cocaine in adulthood] and neurochemical effects in adulthood [decreased dopamine binding sites in the striatum]) | Reichel et al. 2006<br>MnCl <sub>2</sub>     | No change in negative geotaxis performance; no change in motor activity, coordination, or olfactory orientation tasks.                 |

\*\*\*DRAFT FOR PUBLIC COMMENT\*\*\*

Table 3-2 Levels of Significant Exposure to Inorganic Manganese - Oral

(continued)

| Key to Figure | Species <sup>a</sup> (Strain) | Exposure/Duration/Frequency (Route) | System | NOAEL (mg/kg) | LOAEL                |   | Reference | Chemical Form   | Comments   |
|---------------|-------------------------------|-------------------------------------|--------|---------------|----------------------|---|-----------|---|--|
|               |                               |                                     |        |               | Less Serious (mg/kg) | Serious (mg/kg)   |           |   |  |
| 94            | Rat (Sprague-Dawley)          | Gd 0-21 (GW)                        |        |               | 33                   | (increased retardation in skeletal/organ development)   |           | Szakmary et al. 1995<br>MnCl <sub>2</sub>                 |  |
| 95            | Rat (Sprague-Dawley)          | 20 d (GO)                           |        | 3.8           | 7.5                  | (decreased performance in the olfactory discrimination [homing test] and passive avoidance task; striatal dopamine concentrations were about 50% lower than control values) |           | Tran et al. 2002a<br>MnCl <sub>2</sub>                    |  |
| 96            | Rat (Sprague-Dawley)          | 20 d (GO)                           |        | 7.5 M         |                      |   |           | Tran et al. 2002b<br>MnCl <sub>2</sub>                    | No statistically significant (p < 0.05) effects in either burrowing detour task pnd 50-56) or passive avoidance task (pnd 60-69).                |
| 97            | Rat (CD)                      | 21 d (IN)                           |        | 13.8          |                      |   |           | Weber et al. 2002<br>MnCl <sub>2</sub> *4H <sub>2</sub> O | No obvious effect of oral exposure during pnd 1-21 on biochemical measures related to oxidative stress in cerebrocortical or cerebellar regions. |

\*\*\*DRAFT FOR PUBLIC COMMENT\*\*\*



Table 3-2 Levels of Significant Exposure to Inorganic Manganese - Oral

(continued)

| Key to Figure           | Species (Strain)     | Exposure/Duration/Frequency (Route) | System | NOAEL (mg/kg)  | LOAEL   |   | Reference Chemical Form       | Comments  |
|-------------------------|----------------------|-------------------------------------|--------|----------------|---|---|-------------------------------|---|
|                         |                      |                                     |        |                | Less Serious (mg/kg)  | Serious (mg/kg)   |                               |   |
| 98                      | Rabbit (New Zealand) | Gd 6-20 (GW)                        |        | 33             |   |   | Szakmary et al. 1995<br>MnCl2 | No effect on fetal body weights or skeletal anomalies in fetuses. |
| <b>CHRONIC EXPOSURE</b> |                      |                                     |        |                |   |   |                               |   |
| <b>Death</b>            |                      |                                     |        |                |   |   |                               |   |
| 99                      | Human                | <= 1 yr (W)                         |        |                |   | 0.26 (increased fatality among children <1 year of age) | Hafeman et al. 2007<br>NS     |   |
| 100                     | Rat (F344/N)         | 2 yr (F)                            |        |                |   | 200 M (14% survival compared to 49% in controls)        | NTP 1993<br>MnSO4             |   |
| <b>Systemic</b>         |                      |                                     |        |                |   |   |                               |   |
| 101                     | Rat (F344/N)         | 2 yr (F)                            | Resp   | 200 M<br>232 F |   |   | NTP 1993<br>MnSO4             |   |
|                         |                      |                                     | Cardio | 65 M           |   |   |                               |   |
|                         |                      |                                     | Gastro | 200 M<br>232 F |   |   |                               |   |
|                         |                      |                                     | Hemato | 65 M           |   |   |                               |   |
|                         |                      |                                     | Renal  |                | 200 M (increased severity of chronic progressive nephropathy) |   |                               |   |
|                         |                      |                                     | Bd Wt  |                | 200 M (body weight 10% lower than controls)                   |   |                               |   |

\*\*\*DRAFT FOR PUBLIC COMMENT\*\*\*

Table 3-2 Levels of Significant Exposure to Inorganic Manganese - Oral

(continued)

| Key to Figure <sup>a</sup> | Species (Strain) | Exposure/Duration/Frequency (Route)                   | System    | LOAEL             |  |  | Reference Chemical Form | Comments |
|----------------------------|------------------|---|-----------|-------------------|--|--|-------------------------|----------|
|                            |                  |   |           | NOAEL (mg/kg/day) | Less Serious (mg/kg/day)   | Serious (mg/kg/day)                                    |                         |          |
| 102                        | Mouse (B6C3F1)   | 2 yr (F)  | Resp      | 585 M             |  |  | NTP 1993<br>MnSO4       |          |
|                            |                  |   |           | 731 F             |  |  |                         |          |
|                            |                  |   | Cardio    | 585 M             |  |  |                         |          |
|                            |                  |   |           | 731 F             |  |  |                         |          |
|                            |                  |   | Gastro    | 177 M             | 585 M (hyperplasia, erosion)                                     | 732 F (ulceration and inflammation of the forestomach) |                         |          |
|                            |                  |   |           | 226 F             |  |  |                         |          |
|                            |                  |   | Hemato    | 177 M             | 585 M (increased hematocrit, hemoglobin, and erythrocyte counts) |  |                         |          |
|                            |                  |   |           | 731 F             |  |  |                         |          |
|                            |                  |   | Musc/skel | 585 M             |  |  |                         |          |
|                            |                  |   |           | 731 F             |  |  |                         |          |
|                            |                  |   | Hepatic   | 585 M             |  |  |                         |          |
|                            |                  |   |           | 731 F             |  |  |                         |          |
|                            |                  |   | Renal     | 585 M             |  |  |                         |          |
|                            |                  |   |           | 731 F             |  |  |                         |          |
| Endocr                     |                  | 585 M (thyroid follicular hyperplasia and dilatation) |           |                   |  |  |                         |          |
|                            |                  | 64 F (thyroid follicular hyperplasia)                 |           |                   |  |  |                         |          |
| Dermal                     | 584 M            |   |           |                   |  |  |                         |          |
|                            | 732 F            |   |           |                   |  |  |                         |          |
| Bd Wt                      | 584 M            | 732 F (13% lower body weight than controls)           |           |                   |  |  |                         |          |
|                            | 223 F            |   |           |                   |  |  |                         |          |

\*\*\*DRAFT FOR PUBLIC COMMENT\*\*\*

Table 3-2 Levels of Significant Exposure to Inorganic Manganese - Oral

(continued)

| Key to Figure            | Species <sup>a</sup> (Strain) | Exposure/Duration/Frequency (Route) | System | LOAEL             |                                 |  | Reference Chemical Form    | Comments |
|--------------------------|-------------------------------|-------------------------------------|--------|-------------------|---------------------------------|--|----------------------------|----------|
|                          |                               |                                     |        | NOAEL (mg/kg/day) | Less Serious (mg/kg/day)        | Serious (mg/kg/day)  |                            |          |
| <b>Immuno/ Lymphoret</b> |                               |                                     |        |                   |                                 |  |                            |          |
| 103                      | Rat (F344/N)                  | 2 yr (F)                            |        | 200 M<br>232 F    |                                 |  | NTP 1993<br>MnSO4          |          |
| 104                      | Mouse (B6C3F1)                | 2 yr (F)                            |        | 585 M<br>731 F    |                                 |  | NTP 1993<br>MnSO4          |          |
| <b>Neurological</b>      |                               |                                     |        |                   |                                 |  |                            |          |
| 105                      | Human                         | 50 yr (W)                           |        | 0.0048            | 0.059 (mild neurological signs) |  | Kondakis et al. 1989<br>NS |          |
| 106                      | Human                         | ~68 d intermittently x 5 yr (W)     |        |                   |                                 | 0.103 F (pica, emotional lability, personality changes, speech impairments, loss of balance and coordination, inability to walk) | Sahni et al. 2007<br>NS    |          |
| 107                      | Human                         | 10 yr or more (W)                   |        | 0.009             |                                 |  | Vieregge et al. 1995<br>NS |          |

\*\*\*DRAFT FOR PUBLIC COMMENT\*\*\*

Table 3-2 Levels of Significant Exposure to Inorganic Manganese - Oral

(continued)

| Key to Figure | Species <sup>a</sup> (Strain) | Exposure/Duration/Frequency (Route) | System | NOAEL (mg/kg/day) | LOAEL                    |  | Reference Chemical Form   | Comments  |  |
|---------------|-------------------------------|-------------------------------------|--------|-------------------|--------------------------|--|---|---|--|
|               |                               |                                     |        |                   | Less Serious (mg/kg/day) | Serious (mg/kg/day)  |   |   |  |
| 108           | Human                         | 10 yr (W)                           |        | 0.04              | 0.07                     | (significantly reduced performance on Full-Scale IQ test, performance and verbal tests in children)  | Wasserman et al. 2006<br>NS   | No statistically significant effects on Full-Scale IQ testing, performance or verbal tests. |  |
| 109           | Human                         | 5 yr (W)                            |        |                   | 0.06 M                   | (Mn possibly producing deficit in free retrieval skills, affecting general, verbal and visual memory and learning skills; inattentiveness; lack of focus in classroom) | Woolf et al. 2002<br>NS   |   |  |
| 110           | Monkey (Rhesus)               | 18 mo (GW)                          |        |                   |                          |  | 6.9 M (weakness, rigidity, neuronal loss and depigmentation of the substantia niagra) | Gupta et al. 1980<br>MnCl <sub>2</sub>  |  |
| 111           | Rat (Wistar)                  | 2 yr (W)                            |        |                   | 40                       | (altered neurotransmitter uptake)  |   | Lai et al. 1984<br>MnCl <sub>2</sub>  |  |
| 112           | Rat (Sprague-Dawley)          | 65 wk (W)                           |        |                   | 40 M                     | (increased activity)   |   | Nachtman et al. 1986<br>MnCl <sub>2</sub>   |  |
| 113           | Mouse (ddY)                   | 3 gen (W)                           |        |                   |                          |  | 10.6 (altered gait)   | Ishizuka et al. 1991<br>MnCl <sub>2</sub> *4H <sub>2</sub> O                                |  |

\*\*\*DRAFT FOR PUBLIC COMMENT\*\*\*

MANGANESE

3. HEALTH EFFECTS

120

Table 3-2 Levels of Significant Exposure to Inorganic Manganese - Oral

(continued)

| Key to<br>Figure <sup>a</sup> | Species<br>(Strain) | Exposure/<br>Duration/<br>Frequency<br>(Route) | System | NOAEL<br>(mg/kg/day) | LOAEL   |                        | Reference<br>Chemical Form                     | Comments |
|-------------------------------|---------------------|--|--------|----------------------|---|------------------------|--|----------|
|                               |                     |  |        |                      | Less Serious<br>(mg/kg/day)   | Serious<br>(mg/kg/day) |  |          |
| 114                           | Mouse<br>(ddY)      | 12 mo<br>(F)                                   |        |                      | 275 M (decreased locomotor activity)  |                        | Komura and Sakamoto 1992a<br>MnOAc             |          |
| 115                           | Mouse<br>(ddY)      | 12 mo<br>(F)                                   |        |                      | 275 M (decreased locomotor activity)  |                        | Komura and Sakamoto 1992a<br>MnCO <sub>3</sub> |          |
| 116                           | Mouse<br>(ddY)      | 12 mo<br>(F)                                   |        |                      | 275 M (decreased dopamine and increased homovanillic acid in brain; decreased norepinephrine and epinephrine; decreased locomotor activity) |                        | Komura and Sakamoto 1992a<br>MnO <sub>2</sub>  |          |
| 117                           | Mouse<br>(ddY)      | 12 mo<br>(F)                                   |        |                      | 275 M (decreased locomotor activity)  |                        | Komura and Sakamoto 1992a<br>MnCl <sub>2</sub> |          |
| 118                           | Mouse<br>(ddY)      | 12 mo<br>(F)                                   |        |                      | 45 M (significant [p < 0.05] decreases in dopamine and homovanillic acid levels in the corpus striatum)                                     |                        | Komura and Sakamoto 1994<br>MnCl <sub>2</sub>  |          |

\*\*\*DRAFT FOR PUBLIC COMMENT\*\*\*

Table 3-2 Levels of Significant Exposure to Inorganic Manganese - Oral

(continued)

| Key to Figure <sup>a</sup> | Species (Strain) | Exposure/Duration/Frequency (Route) | System | NOAEL (mg/kg/day) | LOAEL                                   |                     | Reference Chemical Form       | Comments |
|----------------------------|------------------|-------------------------------------|--------|-------------------|---|---------------------|-------------------------------|----------|
|                            |                  |                                     |        |                   | Less Serious (mg/kg/day)                | Serious (mg/kg/day) |                               |          |
| 119                        | Mouse (B6C3F1)   | 2 yr (F)                            |        | 585 M<br>731 F    |   |                     | NTP 1993<br>MnSO4             |          |
| <b>Reproductive</b>        |                  |                                     |        |                   |   |                     |                               |          |
| 120                        | Rat (F344/N)     | 2 yr (F)                            |        | 200 M<br>232 F    |   |                     | NTP 1993<br>MnSO4             |          |
| 121                        | Mouse (B6C3F1)   | 2 yr (F)                            |        | 585 M<br>731 F    |   |                     | NTP 1993<br>MnSO4             |          |
| <b>Developmental</b>       |                  |                                     |        |                   |   |                     |                               |          |
| 122                        | Rat (ITRC)       | 1 gen (W)                           |        |                   | 420 M (altered neurotransmitter levels) |                     | Ali et al. 1985<br>MnCl2*4H2O |          |

<sup>a</sup> The number corresponds to entries in Figure 3-2.

ATPase = adenosine triphosphatase; Bd Wt = body weight; Cardio = cardiovascular; CSF = cerebrospinal fluid; d = day(s); DA = dopamine; DOPAC = dihydroxyphenylacetic acid; Endocr = endocrine; F = Female; (F) = feed; (G) = gavage; GABA = gamma-aminobutyric acid; Gastro = gastrointestinal; Gd = gestational day; GFAP = glial fibrillary acidic protein; Gn pig = guinea pig; (GO) = gavage in oil; (GW) = gavage in water; GTPase = glucose-6-phosphatase; Hemato = hematological; 5-HIAA = 5-hydroxy-indoleacetic acid; HVA = homovanillic acid; Immuno/Lymphoret = immunological/lymphoreticular; (IN) = ingestion; LD50 = lethal dose, 50% kill; LH = luteinizing hormone; LOAEL = lowest-observed-adverse-effect level; M = male; Metab = metabolic; mo = month(s); Musc/skel = musculoskeletal; NOAEL = no-observed-adverse-effect level; NS = not specified; Resp = respiratory; TH = tyrosine hydroxylase (W) = drinking water; wk = week(s); x = time(s); yr = year(s)

\*\*\*DRAFT FOR PUBLIC COMMENT\*\*\*

MANGANESE

3. HEALTH EFFECTS

122

Figure 3-2 Levels of Significant Exposure to Inorganic Manganese - Oral  
Acute (≤14 days)

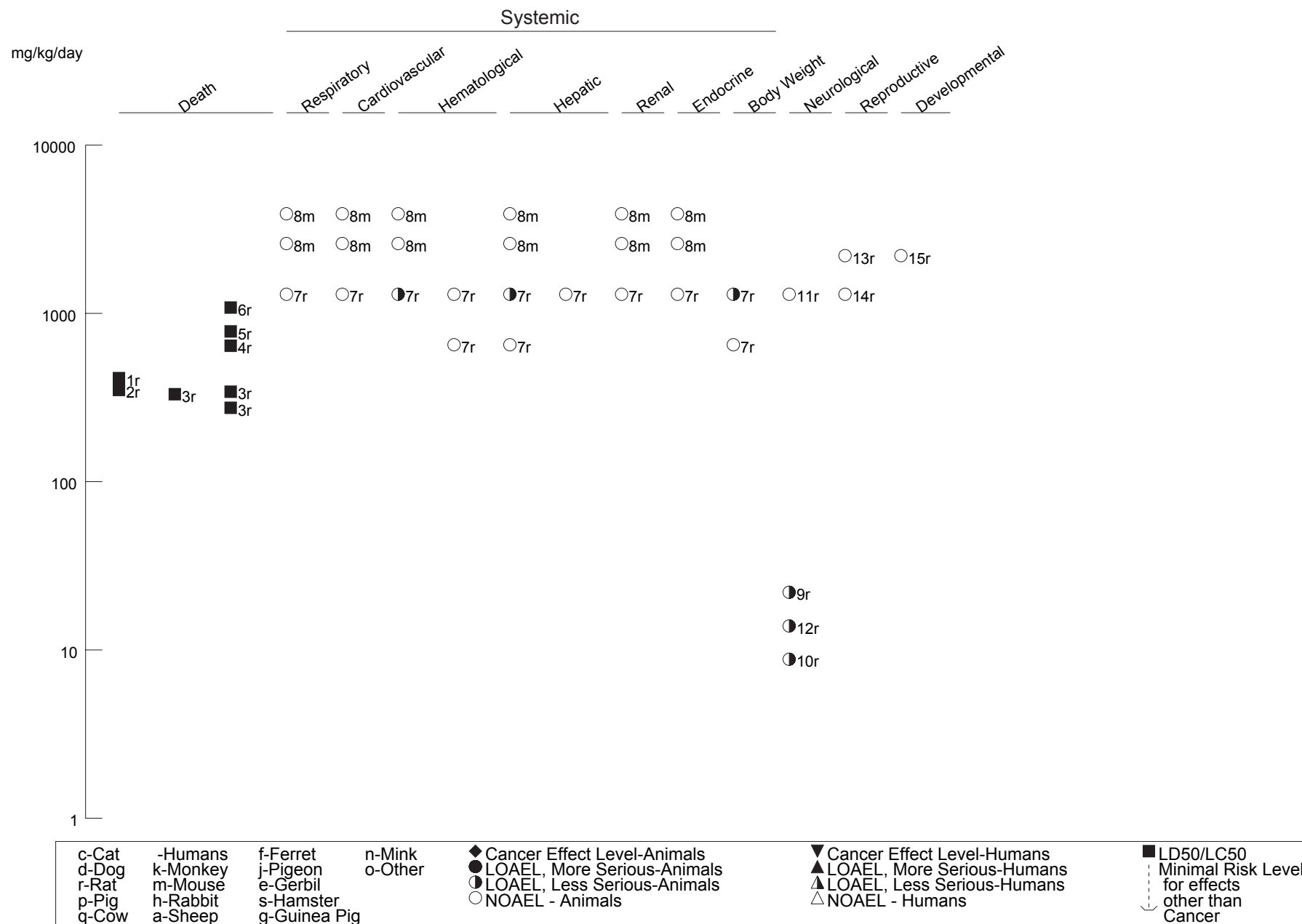

\*\*\*DRAFT FOR PUBLIC COMMENT\*\*\*

Figure 3-2 Levels of Significant Exposure to Inorganic Manganese - Oral (Continued)  
Intermediate (15-364 days)

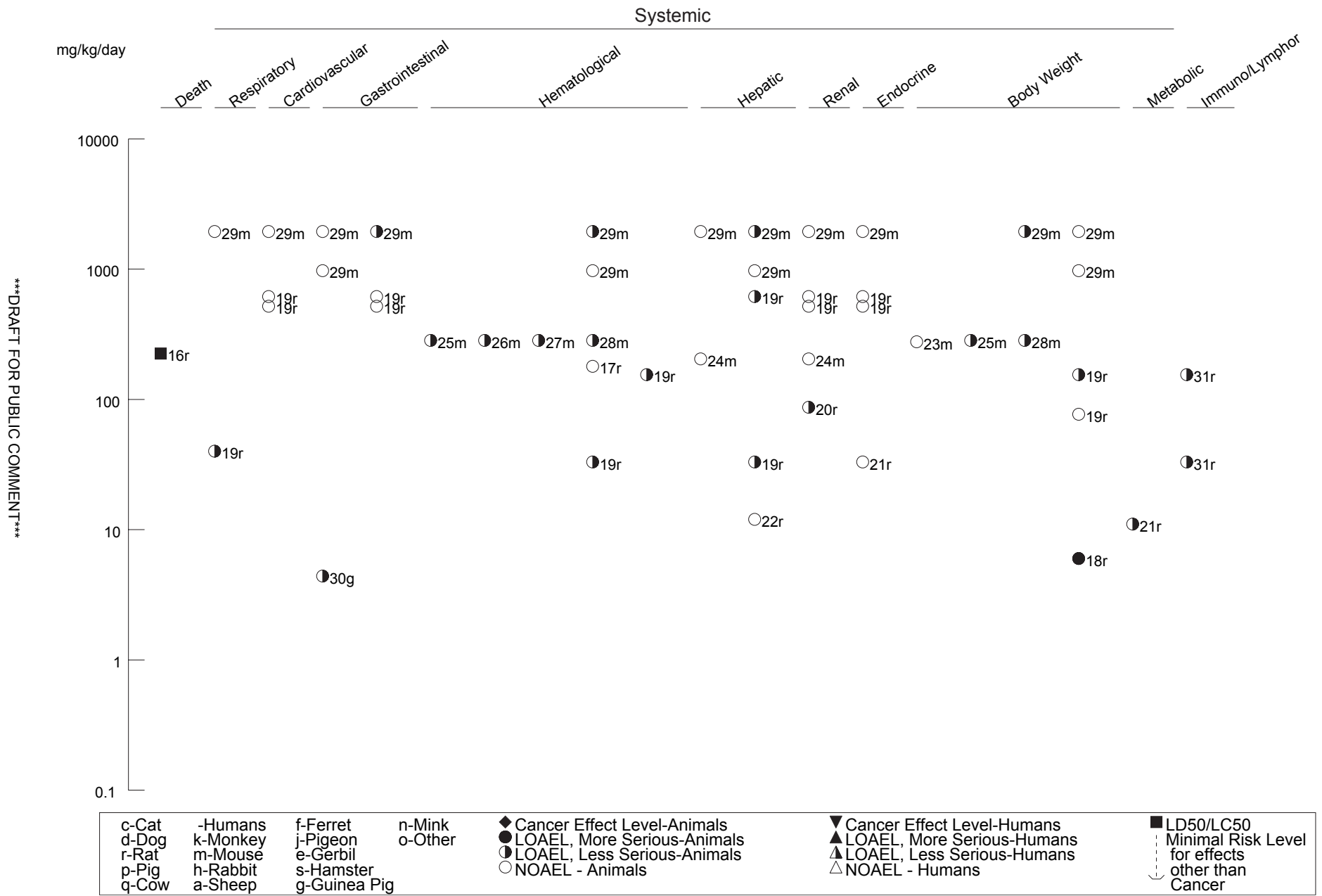

\*\*\*DRAFT FOR PUBLIC COMMENT\*\*\*



Figure 3-2 Levels of Significant Exposure to Inorganic Manganese - Oral (Continued)

Intermediate (15-364 days)

\*\*\*DRAFT FOR PUBLIC COMMENT\*\*\*

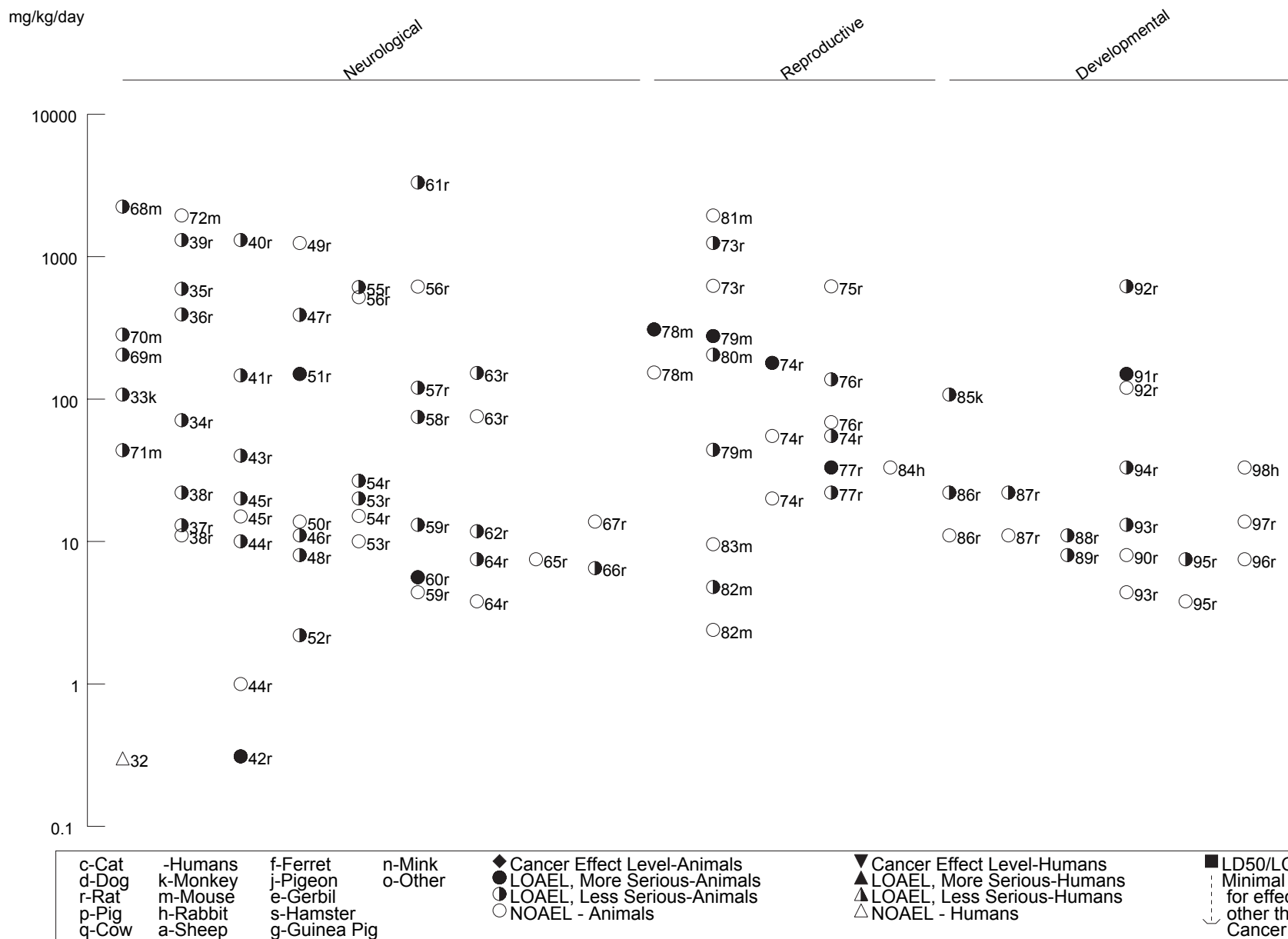
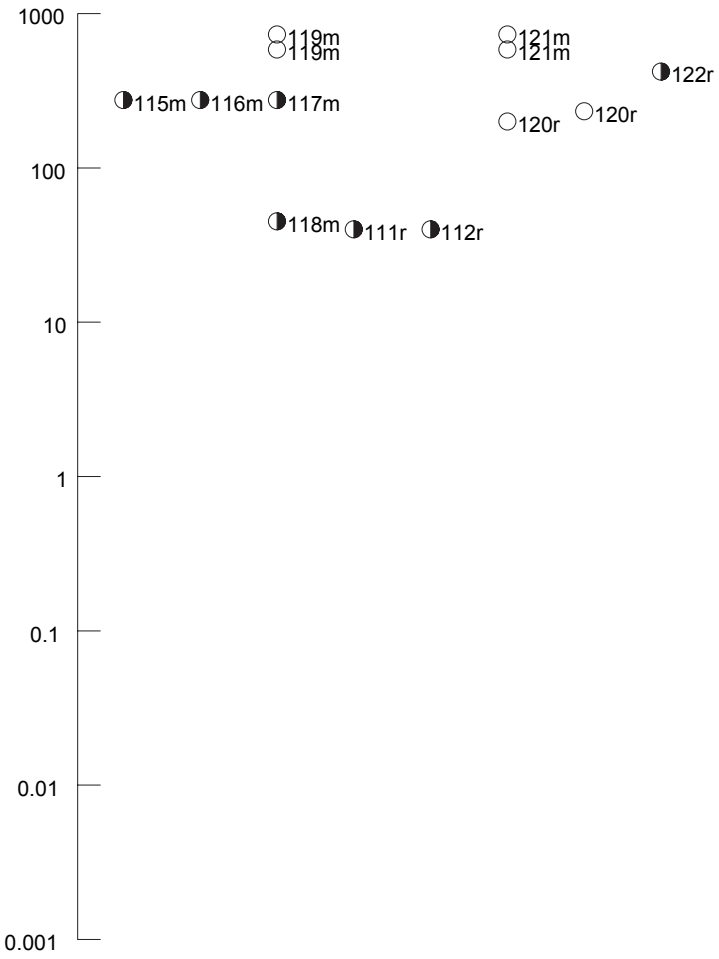



Figure 3-2 Levels of Significant Exposure to Inorganic Manganese - Oral (Continued)  
Chronic (≥365 days)

mg/kg/day

Neurological      Reproductive      Developmental



\*\*\*DRAFT FOR PUBLIC COMMENT\*\*\*

|       |          |              |         |                               |                              |                      |
|-------|----------|--------------|---------|-------------------------------|------------------------------|----------------------|
| c-Cat | -Humans  | f-Ferret     | n-Mink  | ◆ Cancer Effect Level-Animals | ▼ Cancer Effect Level-Humans | ■ LD50/LC50          |
| d-Dog | k-Monkey | j-Pigeon     | o-Other | ● LOAEL, More Serious-Animals | ▲ LOAEL, More Serious-Humans | ⋮ Minimal Risk Level |
| r-Rat | m-Mouse  | e-Gerbil     |         | ◐ LOAEL, Less Serious-Animals | △ LOAEL, Less Serious-Humans | ⋮ for effects        |
| p-Pig | h-Rabbit | s-Hamster    |         | ○ NOAEL - Animals             | △ NOAEL - Humans             | other than           |
| q-Cow | a-Sheep  | g-Guinea Pig |         |                               |                              | Cancer               |

Table 3-3 Levels of Significant Exposure to MMT - Oral

| Key to Figure         | Species <sup>a</sup> (Strain) | Exposure/Duration/Frequency (Route) | System  | NOAEL (mg/kg) | LOAEL                |   | Reference Chemical Form | Comments   |
|-----------------------|-------------------------------|-------------------------------------|---------|---------------|----------------------|---|-------------------------|--|
|                       |                               |                                     |         |               | Less Serious (mg/kg) | Serious (mg/kg)   |                         |  |
| <b>ACUTE EXPOSURE</b> |                               |                                     |         |               |                      |   |                         |  |
| <b>Death</b>          |                               |                                     |         |               |                      |   |                         |  |
| 1                     | Rat (Sprague-Dawley)          | once (GO)                           |         |               |                      | 12.5 M (increase in mortality, LD50=50 mg MMT/kg or 13 mg Mn/kg)                      | Hanzlik et al. 1980a    |  |
| 2                     | Rat (Sprague-Dawley)          | 1 x                                 |         |               |                      | 15 (LD50)   | Hinderer 1979           |  |
| 3                     | Rat (COBS)                    | 1 x (GO)                            |         |               |                      | 14.6 (LD50)   | Hysell et al. 1974      |  |
| 4                     | Mouse (CD-1)                  | 1 x (GO)                            |         |               |                      | 58 F (LD50)   | Hinderer 1979           |  |
| <b>Systemic</b>       |                               |                                     |         |               |                      |   |                         |  |
| 5                     | Rat (Sprague-Dawley)          | once (GO)                           | Resp    |               |                      | 30 M (distended lungs with bloody fluid, hemorrhage, perivascular and alveolar edema) | Hanzlik et al. 1980a    |  |
| 6                     | Rat (COBS)                    | 1 x (GO)                            | Resp    | 7.6           |                      | 11.3 (severe fibrinopurulent pneumonia with prominent macrophage infiltrate of lungs) | Hysell et al. 1974      | All rats from 3.8 and 7.6 mg Mn/kg bw/d groups survived and appeared normal 14 days post-exposure. |
|                       |                               |                                     | Hepatic | 7.6           |                      | 11.3 (hepatic parenchymal necrosis and leukocytic infiltration)                       |                         |  |

\*\*\*DRAFT FOR PUBLIC COMMENT\*\*\*

Table 3-3 Levels of Significant Exposure to MMT - Oral

(continued)

| Key to Figure <sup>a</sup> | Species (Strain) | Exposure/Duration/Frequency (Route) | System | NOAEL (mg/kg) | LOAEL   |                 | Reference Chemical Form   | Comments |
|----------------------------|------------------|-------------------------------------|--------|---------------|---|-----------------|---------------------------|----------|
|                            |                  |                                     |        |               | Less Serious (mg/kg)                                    | Serious (mg/kg) |                           |          |
| <b>CHRONIC EXPOSURE</b>    |                  |                                     |        |               |   |                 |                           |          |
| <b>Systemic</b>            |                  |                                     |        |               |   |                 |                           |          |
| 7                          | Mouse (ddY)      | 1 x/d<br>12 mo<br>(F)               | Bd Wt  |               | 11 M (>10% decrease in body weight in exposed group)    |                 | Komura and Sakamoto 1992b |          |
| <b>Neurological</b>        |                  |                                     |        |               |   |                 |                           |          |
| 8                          | Mouse (ddY)      | 1 x/d<br>12 mo<br>(F)               |        |               | 11 M (increase in spontaneous motor activity on day 80) |                 | Komura and Sakamoto 1992b |          |
| 9                          | Mouse (ddY)      | 12 mo<br>(F)                        |        |               | 11 M (changes in brain neurochemistry)                  |                 | Komura and Sakamoto 1994  |          |

<sup>a</sup> The number corresponds to entries in Figure 3-3.

Bd Wt = body weight; d = day(s); (F) = feed; F = Female; GO = gavage in oil; LD50 = lethal dose, 50% kill; LOAEL = lowest-observed-adverse-effect level; M = male; mo = month(s); NOAEL = no-observed-adverse-effect level; pnd = post-natal day; Resp = respiratory; x = time(s)

\*\*\*DRAFT FOR PUBLIC COMMENT\*\*\*

Figure 3-3 Levels of Significant Exposure to MMT - Oral  
Acute (≤14 days)

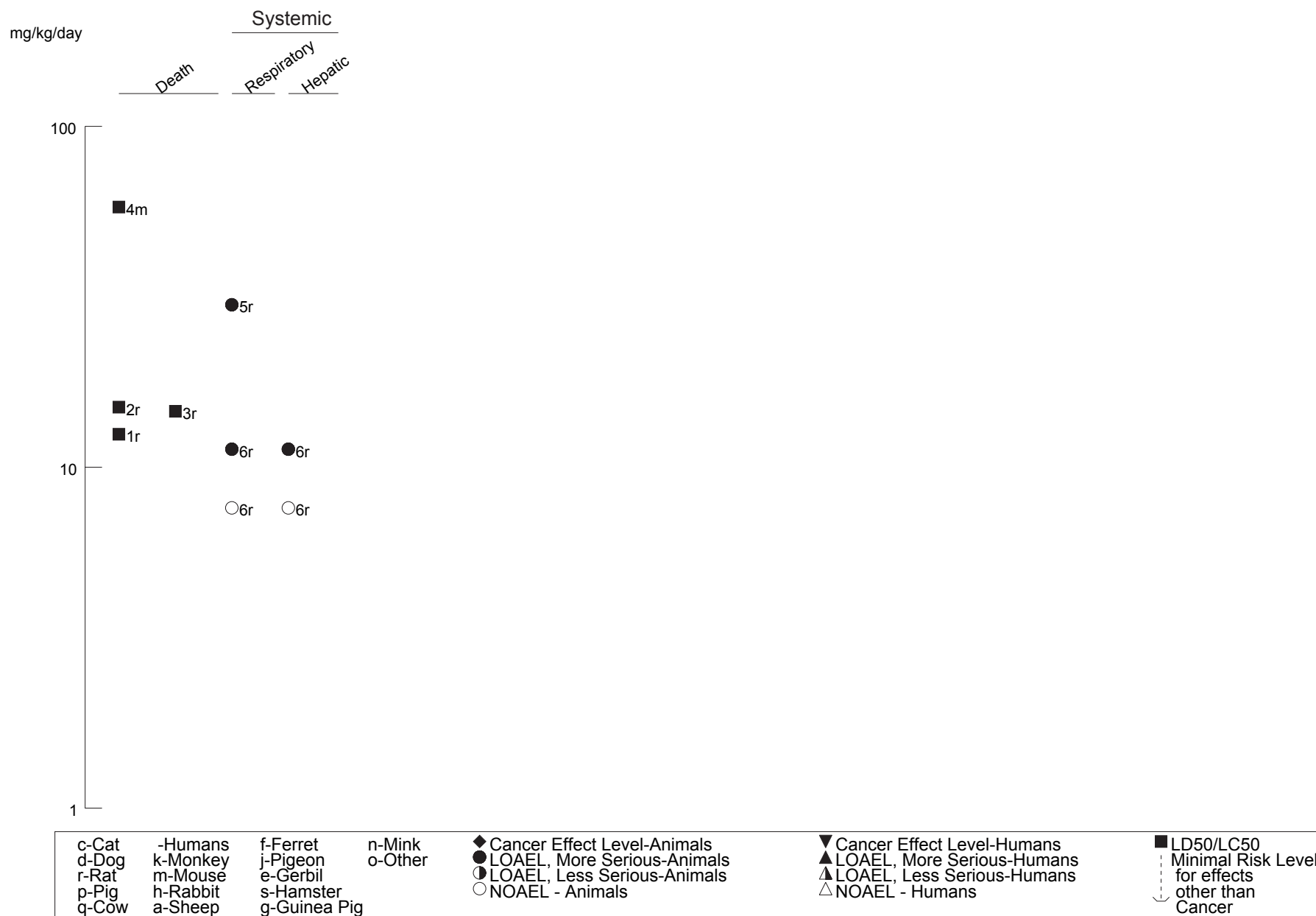

\*\*\*DRAFT FOR PUBLIC COMMENT\*\*\*

Figure 3-3 Levels of Significant Exposure to MMT - Oral (Continued)

Chronic (≥365 days)

Systemic  
mg/kg/day  
Body Weight  
Neurological

100

10

7m 8m 9m

\*\*\*DRAFT FOR PUBLIC COMMENT\*\*\*

|       |          |              |         |                               |                              |                      |
|-------|----------|--------------|---------|-------------------------------|------------------------------|----------------------|
| c-Cat | -Humans  | f-Ferret     | n-Mink  | ◆ Cancer Effect Level-Animals | ▼ Cancer Effect Level-Humans | ■ LD50/LC50          |
| d-Dog | k-Monkey | j-Pigeon     | o-Other | ● LOAEL, More Serious-Animals | ▲ LOAEL, More Serious-Humans | ⋮ Minimal Risk Level |
| r-Rat | m-Mouse  | e-Gerbil     |         | ◐ LOAEL, Less Serious-Animals | △ LOAEL, Less Serious-Humans | ⋮ for effects        |
| p-Pig | h-Rabbit | s-Hamster    |         | ○ NOAEL - Animals             | △ NOAEL - Humans             | other than           |
| q-Cow | a-Sheep  | g-Guinea Pig |         |                               |                              | Cancer               |

## 3. HEALTH EFFECTS

In contrast to these studies, when exposure is by gavage (usually as highly concentrated solutions of manganese chloride in water), measured LD<sub>50</sub> values for 1–21 days of exposure range from 225 to 1,082 mg manganese/kg/day in mice and rats (Holbrook et al. 1975; Kostial et al. 1978, 1989; Rehnberg et al. 1980; Singh and Junnarkar 1991; Smyth et al. 1969). These results suggest that gavage dosing with a bolus of a concentrated soluble manganese compound in water may not be a good model for determining the toxic effects of manganese ingested by humans from environmental sources. Bolus dosing produced death in animals at concentrations near the daily dose levels tolerated in food or drinking water by the same strains and species of animals subjected to longer durations of exposure. It is possible that bolus dosing circumvents the homeostatic control of manganese absorption. It should be noted that the concentrations used in the bolus dosing studies are much higher than even excess levels to which certain humans are typically exposed.

In a study where young pigs were fed a diet moderately high (1.7 mg manganese/kg/day) in manganese but deficient in magnesium, all eight pigs consuming the high manganese diet died within 5 weeks following convulsive seizures; only two of the pigs in a group without supplemental manganese died (Miller et al. 2000). Further studies suggested that high dietary manganese could exacerbate magnesium deficiency in heart muscle, thus creating a complicating factor in the deaths of the magnesium-deficient pigs (Miller et al. 2000).

In conclusion, route of exposure and animal species and strain differences, as well as sex, may account for some of the observed variations in the lethality of manganese. In addition, deficiencies in certain essential nutrients, such as magnesium, may increase the lethal potential of excess manganese.

No studies were located concerning death in humans following ingestion of MMT.

MMT, dissolved in oil and administered by gavage, was found to have LD<sub>50</sub> values of 15 mg manganese/kg in the male and female Sprague-Dawley rat and 58 mg manganese/kg in the adult female CD-1 mouse (Hinderer 1979).

Hysell et al. (1974) administered via gavage increasing amounts of MMT (dissolved in oil) to adult COBS rats, 10 animals/group. No lethality was observed at the lowest two doses of 3.8 and 7.5 mg manganese/kg, but 5/10 rats died within 2–6 days postdosing at a dose of 11.3 mg manganese/kg. Increasing numbers of rats died at higher doses, with decreasing times of death post-dosing; complete



### 3. HEALTH EFFECTS

mortality occurred at the highest dose of 37.5 mg manganese/kg. The survivors appeared normal by 14 days. The LD<sub>50</sub> (14-day) was estimated at 14.6 mg manganese/kg.

Hanzlik et al. (1980a) determined the 14-day LD<sub>50</sub> for purified MMT administered in corn oil via gavage to adult male Sprague-Dawley rats to be 12.5 mg manganese/kg (95% confidence interval, 9.5–16.8 mg manganese/kg). The animals survived similar times post-dosing as those in the Hysell et al. (1974) study.

All LD<sub>50</sub> values from each reliable study for death in each species and duration category are recorded in Table 3-3 and plotted in Figure 3-3.

#### 3.2.2.2 Systemic Effects

In general, there is a lack of data concerning systemic toxic effects in humans who have ingested manganese. This is likely due to the strong homeostatic control the body exerts on the amount of manganese absorbed following oral exposure; this control protects the body from the toxic effects of excess manganese. Studies in humans and animals provide limited data regarding the effects of manganese ingestion on systemic target tissues. This information is discussed below and is organized by target tissue. Table 3-3 and Figure 3-3 present the highest NOAEL and all LOAEL values from each reliable study for these effects for each species and each duration category.

**Respiratory Effects.** No studies were located regarding respiratory effects in humans after oral exposure to inorganic manganese.

No respiratory effects were reported in mice fed up to 3,900 mg manganese/kg/day (as manganese sulfate) or rats fed 1,300 mg manganese/kg/day (as manganese sulfate) for 14 days (NTP 1993). Male rats fed manganese sulfate for 13 weeks showed no respiratory effects at 520 mg manganese/kg/day; however, females exhibited decreased lung weight at 40–618 mg manganese/kg/day (NTP 1993). No respiratory effects were noted in mice of either sex fed 122–1,950 mg manganese/kg/day (as manganese sulfate) for 13 weeks (NTP 1993), in rats fed up to 232 mg manganese/kg/day (as manganese sulfate), or in mice fed up to 731 mg manganese/kg/day (as manganese sulfate) for 2 years (NTP 1993).

The lungs of adult male Sprague-Dawley rats administered one dose of MMT via gavage in corn oil (31.25 mg manganese/kg) showed signs of hemorrhage and alveolar and perivascular edema, with an accumulation of proteinaceous material in the alveoli. As early as 12 hours following gavage

## 3. HEALTH EFFECTS

administration of this same dose, the lung/body weight ratio increased to 2.5 times the control value (Hanzlik et al. 1980). Hinderer (1979) observed dark red lungs in Sprague-Dawley rats and CD-1 mice administered sublethal doses (values unspecified) of MMT in an acute toxicity study. Gross necropsy of the lungs of COBS rats administered one dose of MMT in Wesson oil (dose range, 20–37.5 mg manganese/kg) revealed severe congestion and the release of a serosanguinous fluid upon sectioning; histopathology of lungs from rats dying within 24 hours post-exposure showed severe congestion, perivascular and alveolar edema, and alveolar hemorrhage (Hysell et al. 1974). Sections of lungs from rats surviving until 14 days post-exposure revealed extensive areas of consolidation, thickened alveolar septa and focal areas of alveolar macrophage activity.

**Cardiovascular Effects.** No studies were located regarding cardiovascular effects in humans after oral exposure to inorganic manganese.

In a 1993 National Toxicology Program (NTP) study, no cardiovascular effects (pathological lesions) were observed in mice or rats fed 3,900 or 1,300 mg manganese/kg/day, respectively, for 14 days. No cardiovascular effects were observed in rats or mice exposed for 13 weeks to doses as high as 1,950 mg manganese/kg/day (as manganese sulfate) or for 2 years to doses as high as 731 mg manganese/kg/day (as manganese sulfate) (NTP 1993).

In a study of weanling male Sprague-Dawley rats provided with a diet supplemented with 55 mg manganese/kg/day for 14 weeks, Kalea et al. (2006) found that the level of uronic acid in aortas of the manganese-supplemented group was significantly ( $p < 0.05$ ) higher than in a group of rats fed a diet with adequate manganese (5.5 mg manganese/kg/day). Among heparan sulfate glycosaminoglycans, aortas from manganese-supplemented rats contained higher concentrations of total galactosaminoglycans and decreased concentration of hyaluronan and heparan sulfate (50% less heparan sulfate) when compared to aortas from rats consuming diets with adequate manganese. Heparan sulfate chains of aortas from manganese-supplemented rats contained 41% higher concentration of non-sulfated units compared to those of rats fed the adequate manganese diet (Kalea et al. 2006). These results raise concern about the potential for manganese to influence vascular chemistry in deleterious ways, creating increased vulnerability to cardiovascular events.

In the course of investigating a mechanism to explain the sudden deaths in pigs from high doses of manganese (Miller et al. 2000), studies were conducted in which pigs were fed either low (3.4 mg/kg/day) or adequate dietary magnesium (6.8 mg/kg/day) along with high (55 mg/kg/day) or low doses

## 3. HEALTH EFFECTS

(5.5 mg/kg/day) of manganese (Miller et al. 2004). No differences in heart muscle ultrastructure were observed; however, marked myocardial necrosis and mitochondrial swelling were observed in pigs fed high dietary manganese in combination with low magnesium (13.9 mg magnesium/kg/day; Miller et al. 2004). In pigs fed high manganese and adequate magnesium, no swelling of myocardial mitochondria was observed. These results suggest that high manganese, when fed in combination with low magnesium, disrupts mitochondrial ultrastructure (Miller et al. 2004). In another related study, when rats were provided with high dietary manganese (13.8 mg manganese/kg/day as manganese carbonate) for 8 weeks, heart muscle oxygen consumption was depressed, although no effects of manganese on hematologic variables were observed (Miller et al. 2006). No effects of manganese were observed on heart muscle activities for  $\text{Ca}^{+2}$  ATPase, liver glutathione peroxidase, or brain glutathione peroxidase at doses as high as 55 mg manganese/kg/day (Miller et al. 2006). The depression in heart muscle oxygen consumption produced by high dietary manganese presents yet another possible mechanism by which high doses of manganese can produce adverse cardiovascular events.

No studies were located regarding the cardiotoxic effects of MMT in either humans or animals following oral exposure.

**Gastrointestinal Effects.** No studies were located regarding gastrointestinal effects in humans after oral exposure to manganese, except for one case report of a child who accidentally ingested some potassium permanganate (Southwood et al. 1987). This led to severe local corrosion of the mouth, esophagus, and stomach due to the caustic effects of potassium permanganate on the tissue, but there was no evidence of systemic toxicity.

Adverse gastrointestinal effects have been reported in guinea pigs and mice but not in rats. Guinea pigs administered 4.4 mg manganese/kg/day (as manganese chloride by gavage) did not suffer any gross abnormalities in either the stomach or small or large intestines as a result of treatment but did have patchy necrosis and decreased adenosine triphosphatase and glucose 6-phosphatase levels in both the stomach and small intestine (Chandra and Imam 1973). This study differs from the others in its delivery of manganese (by gavage); the gavage treatment may have partially or completely contributed to the adverse effects seen in the stomach and small intestine of the guinea pigs. No gastrointestinal effects were observed in female mice fed 1,950 mg manganese/kg/day (as manganese sulfate in food) or rats fed up to 618 mg manganese/kg/day (as manganese sulfate in food) for 13 weeks, but male mice exhibited mild hyperplasia and hyperkeratosis of the forestomach at 1,950 mg manganese/kg/day, also in food (NTP 1993).

## 3. HEALTH EFFECTS

In a 1993 NTP study, rats fed as much as 232 mg manganese/kg/day (as manganese sulfate) for 2 years showed no gastrointestinal effects; however, mice treated with manganese sulfate for 2 years exhibited hyperplasia, erosion, and inflammation of the forestomach at 585 mg manganese/kg/day for males and 731 mg manganese/kg/day for females. The acanthosis was judged by the authors to be a result of direct irritation of the gastrointestinal epithelium and to be of minor consequence.

No studies were located concerning gastrointestinal effects following oral exposure to MMT in humans. Hinderer (1979) observed discolored intestinal tracts in Sprague-Dawley rats and fluid-filled intestines and spotting of the intestine in CD-1 mice dosed by gavage with high concentrations (values not provided) of MMT in a 14-day toxicity study. Hysell et al. (1974) observed that single lethal doses of 20–37.5 mg manganese/kg (as MMT, given by gavage) produced small intestines that were distended with clear watery contents and thin, friable walls.

**Hematological Effects.** In a dietary study with female subjects (Davis and Greger 1992), no changes in hematocrit, serum transferrin, or serum ferritin were reported following supplementation with 0.25 mg manganese/kg/day for 119 days. Vieregge et al. (1995) found no effects on hemoglobin, ceruloplasmin, or copper and iron levels in serum for a population of 40-year-old people who had ingested at least 0.3 mg manganese/L in drinking water for a minimum of 10 years. These data indicate that exposure to increased manganese in water did not result in observable hematological toxicity.

Alterations in hematological parameters have been reported in rats and mice, although they were found to vary depending on species, duration, and the form of manganese administered. No conclusive evidence regarding a significant functional deficit has been reported. In mice fed 284 mg manganese/kg/day for 100 days, red blood cell count was decreased by manganese acetate and manganese chloride; white blood cell count was decreased by manganese acetate, manganese chloride, and manganese dioxide; and hematocrit was decreased by manganese carbonate (Komura and Sakamoto 1991). However, manganese carbonate had no effect on red blood cells or white blood cells, manganese dioxide had no effect on red blood cells or total hematocrit, and manganese acetate and manganese chloride had no effect on total hematocrit. It has been suggested that the manganese-related effects on red blood cells may be related to the displacement of iron by manganese. The significance of the other hematological effects was not noted. In a study in rats and mice dosed with manganese sulfate for 14 days, 13 weeks, or 2 years, minor changes in hematology parameters were reported; these changes varied depending on species, dose, and duration, and the study authors did not consider them to be clearly related to compound administration

## 3. HEALTH EFFECTS

(NTP 1993). No significant hematological effects were observed in mice exposed to 180 mg manganese/kg/day (as manganese tetroxide) for 224 days (Carter et al. 1980). In a study where male Sprague-Dawley rats were fed 55 mg manganese/kg/day as manganese carbonate for 8 weeks, significantly decreased hematocrit and hemoglobin levels were observed (Miller et al. 2006). However, an even lower level of dietary manganese carbonate (35.8 mg manganese/kg/day) fed to male Sprague-Dawley rats in a diet containing a relatively low concentration of magnesium (200 mg magnesium/kg feed/day) for 4 weeks also produced significantly decreased hematocrit and hemoglobin levels (Miller et al. 2006). Thus, the potential for dietary manganese to produce adverse effects on red blood cells may be further modulated by the relative availability of magnesium in the diet.

No studies were located concerning hematological effects following oral exposure to MMT in humans or animals.

**Musculoskeletal Effects.** No studies were located regarding musculoskeletal effects in humans after oral exposure to inorganic manganese.

In young rats, high concentrations of manganese chloride in the diet (218–437 mg manganese/kg/day) led to rickets (Svensson et al. 1985, 1987); however, this was found to be due to a phosphate deficiency stemming from precipitation of manganese phosphate salt ( $\text{MnHPO}_4$ ) in the intestine rather than to a direct biological effect of manganese on bone formation. No significant musculoskeletal effects were observed in mice or rats fed up to 731 mg manganese/kg/day for 2 years (NTP 1993).

No studies were located concerning musculoskeletal effects following oral exposure to MMT in humans or animals.

**Hepatic Effects.** A single study of human oral exposure of manganese investigated potential hepatotoxicity by analyzing liver enzymes in serum. Vieregge et al. (1995) reported no effects on bilirubin, alkaline phosphatase, glutamic pyruvic transaminase, glutamic oxalacetic transaminase, or gamma glutamyl transferase in humans,  $\geq 40$  years old, who had ingested well water containing  $\geq 0.30$  mg/L for at least 10 years. These limited data indicate that chronic exposure to elevated levels of manganese did not result in observable liver toxicity in this population.

In animals, a variety of histological changes in subcellular organelles (e.g., rough and smooth endoplasmic reticulum, Golgi apparatus) were observed in the livers of rats exposed to 12 mg

## 3. HEALTH EFFECTS

manganese/kg/day for 10 weeks (as manganese chloride) (Wassermann and Wassermann 1977). However, these changes were not considered to be adverse but to be adaptive, possibly in response to increased manganese excretion in the bile (see Section 3.4.4). Reductions in liver weight have also been reported in male Fischer 344 rats fed 1,300 mg manganese/kg/day (as manganese sulfate) for 14 days. However, these effects were not seen in B6C3F<sub>1</sub> mice fed dosages up to 3,900 mg manganese/kg/day (as manganese sulfate) for 14 days (NTP 1993). In rats fed up to 618 mg manganese/kg/day (as manganese sulfate) for 13 weeks, decreased liver weights were reported in males at  $\geq 33$  mg manganese/kg/day and females at 618 mg manganese/kg/day (NTP 1993). When mice were fed 122–1,950 mg manganese/kg/day (as manganese sulfate) for 13 weeks, the females showed no hepatic effects; however, the males exhibited both relative and absolute reduced liver weights at 1,950 mg manganese/kg/day (NTP 1993). In CD-1 mice, no hepatic changes were seen in males fed 205 mg manganese/kg/day (as manganese tetroxide) (Gray and Laskey 1980). No significant hepatic histological changes were observed in either mice or rats exposed for 2 years, with rats fed up to 232 mg manganese/kg/day (as manganese sulfate), and mice fed up to 731 mg manganese/kg/day (as manganese sulfate) (NTP 1993).

There are no studies concerning hepatic effects following oral exposure to MMT in humans.

Hinderer (1979) observed mottling of the liver in CD-1 mice administered high doses (unspecified) of MMT via gavage in a 14-day acute toxicity study. Histological evaluation of livers of adult male Sprague-Dawley rats administered 31.3 mg manganese/kg/day (as MMT) revealed scattered hepatocytes throughout the lobule that contained cytoplasmic vacuoles (Hanzlik et al. 1980b). Twelve hours after administration of the same dose, no changes in plasma glutamic pyruvic transaminase (GPT) or liver glucose 6-phosphatase (G6P) activities were observed. After the death of 8/14 animals at this dose level (24 hours post-dosing), there were still no changes in plasma GPT, liver G6P, or hepatic triglycerides (Hanzlik et al. 1980b). Hysell et al. (1974) observed that COBS rats that were gavage-dosed with 20–37.5 mg manganese/kg (as MMT) once and died within 24 hours post-dosing had livers with acute centrilobular passive congestion. This damage progressed to hepatic parenchymal necrosis and leukocytic infiltration in those rats surviving 48–72 hours (15–37.5 mg manganese/kg/day), and extensive cytoplasmic vacuolar change in rats surviving to 14 days.

**Renal Effects.** No studies were located regarding renal effects in humans after oral exposure to inorganic manganese.

## 3. HEALTH EFFECTS

In animal studies, no significant renal histopathological changes were observed in any of the following: mice and rats fed up to 3,900 or 1,300 mg manganese/kg/day (as manganese sulfate) for 14 days (NTP 1993); mice exposed to 205 mg manganese/kg/day (as manganese tetroxide) in their diet for 90 days (Gray and Laskey 1980); mice or rats fed up to 1,950 mg manganese/kg/day for 13 weeks (NTP 1993); or mice fed up to 731 mg manganese/kg/day for 2 years and female rats fed 232 mg manganese/kg/day (as manganese sulfate) (NTP 1993). Contrary to these findings, increased severity of chronic progressive nephropathy was noted in male rats fed 200 mg manganese/kg/day (as manganese sulfate) for 2 years (NTP 1993). In addition, glomerulosclerosis/nephritis and urolithiasis (kidney stones) were observed in male, but not female, Sprague-Dawley rats exposed to dietary doses  $\geq 87$  mg manganese/kg/day for 63 days (Ponnappakkam et al. 2003b).

No studies were located concerning renal effects in humans following oral exposure to MMT.

Hanzlik et al. (1980b) observed occasional vacuolar degeneration of proximal convoluted tubules of the kidney in Sprague-Dawley rats administered a single gavage dose of 31.3 mg manganese/kg (as MMT). Histopathologic renal effects observed within 24 hours of a gavage dose of 20–37.5 mg manganese/kg (Hysell et al. 1974) included hyaline droplet change, cytoplasmic vacuolation of the proximal convoluted tubules, and distention of the glomerular space and tubule lumens with a finely granular material that stained lightly basophilic. Within 48 hours post-dosing, there was severe tubular degeneration in the form of nuclear pyknosis and cell lysis. Animals surviving the administration of 3.75–25 mg manganese/kg did not have any adverse renal effects.

**Endocrine Effects.** No studies were located regarding endocrine effects in humans after oral exposure to inorganic manganese; however, other elements of endocrine function (e.g., reproductive effects) following oral exposure to inorganic manganese are discussed elsewhere.

In mice fed up to 3,900 mg manganese/kg/day (as manganese sulfate) and rats fed 1,300 mg manganese/kg/day (as manganese sulfate) for 14 days, no endocrine effects (pathological lesions) were observed (NTP 1993). The adrenal gland was assessed for atypical cells and hyperplasia. In the pituitary gland, the pars distalis was assessed for cyst, hyperplasia, and hypertrophy. The pars intermedia was checked for cysts. C-cells and hyperplasia were examined in the thyroid gland. No endocrine effects were observed in mice or rats fed up to 1,950 mg manganese/kg/day (as manganese sulfate) for 13 weeks. A 2-year study in rats fed up to 232 mg manganese/kg/day (as manganese sulfate) reported no endocrine effects (NTP 1993). However, in a 2-year mouse study, thyroid follicular hyperplasia and dilatation were

## 3. HEALTH EFFECTS

observed in males fed 584 mg manganese/kg/day, and thyroid follicular hyperplasia was observed in females fed 64 mg manganese/kg/day (NTP 1993).

No studies were located regarding endocrine effects in humans or animals following oral exposure to MMT.

**Dermal Effects.** No studies were located regarding dermal effects in humans after oral exposure to inorganic manganese.

In animals, no significant dermal histopathological changes were observed in mice or rats exposed for 2 years to doses up to 731 or 232 mg manganese/kg/day, respectively, (NTP 1993).

No studies were located regarding dermal effects following oral exposure to organic manganese.

**Ocular Effects.** No studies were located regarding ocular effects in humans after oral exposure to inorganic manganese.

In animals, no significant ocular histopathological changes were observed in mice or rats exposed for 2 years to average oral doses of 731 or 232 mg manganese/kg/day (as manganese sulfate), respectively (NTP 1993).

No studies were located regarding ocular effects in humans or animals after oral exposure to organic manganese.

**Body Weight Effects.** No studies were located regarding body weight effects in humans after oral exposure to inorganic manganese.

In some animal studies, lower body weights were observed in rats and mice in manganese-dosed groups. For example, an NTP study (1993) reported decreases in body weight gain of 57% in male rats and 20% in female rats fed 1,300 mg manganese/kg/day (as manganese sulfate in food) for 14 days. Exon and Koller (1975) reported that rats fed daily doses of manganese tetroxide as low as 6 mg manganese/kg/day (mean ingestion value over the duration of the experiment) for 28 days gained only 44% as much weight over the course of the study as control rats. No changes in eating habits in this lowest dose group were observed, although rats in the highest dose group at 4,820 mg manganese/kg/day did exhibit decreased



## 3. HEALTH EFFECTS

weight gain due to starvation and the effects of the manganese. No histopathological changes were reported in the exposed animals. The authors suggested that the decrease in weight gain might have been due to manganese interference in metabolism of calcium, phosphorous, and iron.

In chronic studies, a similar sex-related difference in the response to this effect was reported. By the end of a 2-year exposure to the maximum daily dose of 200 mg manganese/kg/day (as manganese sulfate in food), male rats had a final mean body weight that was 10% lower than that of controls; however, females' mean body weights were not significantly different from those of controls throughout the study at all dose levels (232 mg manganese/kg/day was the maximum dose for female rats) (NTP 1993). Food intake (as mg/kg/day) was similar for exposed groups and control groups and for males and females (NTP 1993).

Laskey et al. (1982) investigated body weight changes in a study of adverse reproductive toxicity in male and female Long-Evans rats exposed to manganese. Pregnant dams were fed 0, 350, 1,050, and 3,500 mg manganese/kg/day (in conjunction with a low-iron diet [20 mg iron/kg/day] or a diet adequate in iron [200 mg iron/kg/day]); the pups were continued on their respective diets from day 14 to 15 postpartum to the end of the study (224 days). Manganese treatment did not have any effect on body weight, in either sex fed adequate iron. In iron-deficient male rats, however, body weights were significantly decreased from controls at 24 days postpartum in the 1,050 mg manganese/kg/day diet and at all doses at 40- and 60-day time points. Interestingly, body weight was not significantly different in iron-deficient male rats fed manganese at 350 mg/kg/day at 100 days and at 224 days (no dose group had weight values significantly different from control at day 224). Female body weights were only significantly different in the highest dose at day 24 and in the remaining two manganese doses at day 60. Body weights were not significantly different from controls for the remainder of the study. Significant mortality in both sexes from the highest manganese group fed an iron-deficient diet limited the available data.

No studies were located concerning body weight effects following oral exposure to MMT in humans. Hanzlik et al. (1980b) observed no significant differences in acutely exposed rats at a dose of 31.3 mg manganese/kg as MMT. Hinderer (1979) also observed normal weight gain in surviving Sprague-Dawley rats and CD-1 mice administered doses of MMT ranging from 7 to 159 mg manganese/kg in a one-dose 14-day lethality study.

In a chronic study, Komura and Sakamoto (1992b) administered 11 mg manganese/kg/day (as MMT) in chow to male ddY mice for 12 months. A 12% decrease in weight gain was observed at 9 months

## 3. HEALTH EFFECTS

between exposed mice and mice fed unmodified chow, increasing to a 17% difference at 12 months. All differences in these time points were statistically significant. There was no observed difference in food intake between the exposed and control groups.

**Metabolic Effects.** No studies were located regarding metabolic effects following oral exposure to inorganic manganese in humans or animals.

No studies were located regarding metabolic effects following oral exposure to MMT in humans or animals.

### 3.2.2.3 Immunological and Lymphoreticular Effects

No studies were located regarding immunological or lymphoreticular effects in humans after oral exposure to inorganic manganese.

Alterations in white blood cell counts have been reported in rats and mice following oral exposure to manganese. One NTP study reported immunological effects in rodents treated for 13 weeks, but not in those treated for 2 years (NTP 1993). Mice were fed 122–1,950 mg manganese/kg/day (as manganese sulfate) for 13 weeks. Males exhibited decreased leukocyte counts at  $\geq 975$  mg manganese/kg/day; however, these effects may not have been treatment-related; females were unaffected. For 13 weeks, rats were fed 33–520 mg manganese/kg/day (males) and 40–618 mg manganese/kg/day (females); neutrophil counts were increased in males at  $\geq 33$  mg manganese/kg/day, lymphocytes were decreased in males at  $\geq 130$  mg manganese/kg/day, and total leukocytes were decreased in females at  $\geq 155$  mg manganese/kg/day (NTP 1993). Rats fed up to 232 mg manganese/kg/day (as manganese sulfate) and mice fed up to 731 mg manganese/kg/day (as manganese sulfate) for 2 years exhibited no gross or histopathological changes or organ weight changes in the lymph nodes, pancreas, thymus, or spleen (NTP 1993). Komura and Sakamoto (1991) reported decreased white blood cell counts in mice following dosing at 284 mg manganese/kg/day with manganese acetate, manganese chloride, or manganese dioxide for 100 days. It is not known if any of these changes are associated with significant impairment of immune system function.

No studies were located regarding immunological or lymphoreticular effects following oral exposure to MMT in humans or animals.

## 3. HEALTH EFFECTS

**3.2.2.4 Neurological Effects**

Although inhalation exposure to high levels of manganese is known to result in a syndrome of profound neurological effects in humans (see Section 3.2.1.4, above), there is only limited evidence that oral exposure leads to neurological effects in humans.

An outbreak of a disease with manganism-like symptoms was reported in a group of six Japanese families (about 25 people) exposed to high levels of manganese in their drinking water (Kawamura et al. 1941). Noted symptoms included a masklike face, muscle rigidity and tremors, and mental disturbance. Five people were severely affected (2 died), 2 were moderately affected, 8 were mildly affected, and 10 were not affected. These effects were postulated to be due to the contamination of well water with manganese (14 mg/L) that leached from batteries buried near the well. Although many of the symptoms reported were characteristic of manganese toxicity, several aspects of this outbreak suggest that factors in addition to manganese may have contributed to the course of the disease. First, symptoms appeared to have developed very quickly. For example, two adults who came to tend the members of one family developed symptoms within 2–3 weeks. Second, the course of the disease was very rapid, in one case progressing from initial symptoms to death in 3 days. Third, all survivors recovered from the symptoms even before the manganese content of the well had decreased significantly after removal of the batteries. Thus, while there is no doubt that these people were exposed to manganese, there is considerable doubt that all of the features of this outbreak (particularly the deaths) were due to manganese alone.

A manganism-like neurological syndrome has been noted in an aboriginal population living on an island near Australia where environmental levels of manganese are high (Kilburn 1987). Symptoms included weakness, abnormal gait, ataxia, muscular hypotonicity, and a fixed emotionless face. Although it seems likely that excess manganese exposure is an etiologic factor in this disease (based on occupational exposure data from a study where exposure was assumed to be primarily by inhalation although oral exposure was not ruled out), absence of data on dose-response correlations and absence of data from a suitable control group preclude a firm conclusion on the precise role of manganese (Cawte et al. 1987). It is possible that other factors besides manganese exposure may have contributed to the neurological effects, including genetic factors, dietary deficiencies in antioxidants and calcium, and excess alcohol consumption (Cawte et al. 1989). Also, it should be noted that if manganese intake is a causal factor for neurological damage, exposure of the population evaluated in this study could occur not only through the oral route (e.g., food, water, soil), but also by inhaling manganese-containing dusts in environmental or workplace air (Cawte et al. 1987).

## 3. HEALTH EFFECTS

In another study, Kondakis et al. (1989) reported that chronic intake of drinking water containing elevated levels of manganese (1.8–2.3 mg/L) led to an increased prevalence of neurological signs in the elderly residents (average age, 67 years) of two small towns in Greece. Effects in these residents were compared with effects in similarly aged residents in a town where manganese levels were 0.004–0.015 and 0.082–0.25 mg/L. These levels are within and slightly above levels found in U.S. drinking water, respectively (see Section 6.4.2). Over 30 different neurological signs and symptoms were evaluated, each being weighted according to its diagnostic value for Parkinsonism. Based on this system, the average neurological scores for the residents of the control town (0.004–0.015 mg manganese/L), the town with mid-range levels (0.08–0.25 mg manganese/L), and the town with elevated manganese (1.8–2.3 mg manganese/L) were 2.7, 3.9, and 5.2, respectively. Results from this study suggest that higher-than-usual oral exposure to manganese might contribute to an increased prevalence of neurological effects in the aged population.

However, there are a number of limitations to this study that make this conclusion uncertain. First, no details were reported regarding which neurological signs or symptoms were increased, so it is difficult to judge if the differences were due to effects characteristic of manganism or to nonspecific parameters. Second, the weighting factors assigned to each neurological symptom were based on the symptom's diagnostic value for Parkinsonism; however, there are clinically significant differences between manganism and Parkinsonism. Therefore, the weighting scheme should have placed more weight on those symptoms (e.g., sleep disorders, emotional lability, weakness, fatigue, and irritability) reported in humans with manganism, such as manganese-exposed miners. The report does not indicate whether efforts were made to avoid bias in the examiner or in the study populations. Nonetheless, the use of the weighting scheme does strengthen the authors' assertion of an association between elevated manganese concentration in the water source and increased susceptibility to neurological symptoms in older populations. Although the subjective parameters included in this scoring are indicative of alterations in mood or emotional state, and affective disorders often accompany other more objective nervous system effects, the authors did not state whether individuals who experienced neurological signs did, in fact, ingest higher levels of manganese than unaffected individuals. The authors reported that the populations in the towns were very similar to each other, but they provided few data to substantiate this. In this regard, even small differences in age, occupational exposures, or general health status could account for the small differences observed. Thus, this study suggests, but does not prove, that chronic oral intake of high levels of manganese can lead to neurological changes in humans.

## 3. HEALTH EFFECTS

A study by Vieregge et al. (1995) reported no difference in performance on neurological function studies by people who had ingested well water with high concentrations of manganese. These individuals (high-exposure group), ages  $\geq 40$  years, were exposed to manganese at a minimum concentration of 300  $\mu\text{g}$  manganese/L in water for at least 10 years. The controls consisted of a matched group of people who ingested well water with a manganese concentration no higher than 0.05 mg/L. Mean blood manganese concentrations in the high-concentration group were  $8.5 \pm 2.3$   $\mu\text{g}/\text{L}$  compared to the control value of  $7.7 \pm 2.0$   $\mu\text{g}/\text{L}$ . Performance on motor coordination tests in the 'high-exposure' group was no different than the performance of the control group. The authors noted that they could not control for the ingestion of water from sources other than the wells described. Ingestion of manganese in food is also a major contributor, but the authors did not report an estimate of manganese levels ingested from foodstuffs. However, these possible confounders were considered negligible because no differences between groups were revealed in a risk factor analysis for nutritional factors performed by the authors and because manganese concentrations in the blood were not statistically different between the two groups. Manganese drinking water levels for the 'control group' in this study were within the range of levels reported in U.S. drinking water (see Section 6.4.2). As with the report by Kondakis et al. (1989), a limitation of this study is the use of a neurological assessment scale for 'Parkinsonian signs' rather than an evaluation of symptoms associated with manganism, though the authors observed no 'detectable' neurological impairment.

Goldsmith et al. (1990) investigated a cluster of Parkinson's disease in the southern region of Israel. They reported an increased prevalence of Parkinsonism particularly among those 50–59 years old, which suggested early onset of the disease. The authors believed that a potential environmental cause was the water source common to residents in the region where the cluster of Parkinson's disease was observed. Although the authors reported that the water samples examined showed a "substantial excess of aluminum and a smaller excess of iron and manganese," the concentrations were not reported. Soil samples were reported to contain excess concentrations of manganese as well as beryllium, chromium, europium, and ytterbium, though no quantitative values were provided. The residents were connected to a national water system, so it could not be determined when the water supply may have become contaminated with excess levels of manganese and other metals. Moreover, there was no clear evidence that persons living in the region were actually exposed to a contaminated water supply. Although identified as a cluster of Parkinson's disease rather than manganism, the authors suggested that the disease cluster might be related to an environmental source. However, the limitations in this study make it difficult to make any clear association between chronic oral intake of excess levels of manganese and the prevalence of neurological disease.

## 3. HEALTH EFFECTS

Iwami et al. (1994) studied the metal concentrations in rice, drinking water, and soils in Hohara, a small town on the Kii peninsula of Japan. This town reportedly had a high incidence of motor neuron disease. The researchers observed that a significantly increased manganese content in local rice and a decreased concentration of magnesium in drinking water were positively correlated with the incidence of motor neuron disease in Hohara ( $r^2=0.99$ ).

Evidence of neurological effects following oral manganese exposure has been noted in case studies of adults, as well. For example, in a case report of a man who accidentally ingested low doses of potassium permanganate (about 1.8 mg manganese/kg/day) for 4 weeks, the man began to notice weakness and impaired mental capacity after several weeks (Holzgraefe et al. 1986). Although exposure was stopped after 4 weeks, the authors reported that a syndrome similar to Parkinson's disease developed after about 9 months. Though suggested by the appearance of a syndrome resembling Parkinsonism, it is difficult to prove that these neurological effects were only caused by exposure to the manganese compound. The authors speculated that the ingested  $MnO_4^-$  was reduced to Mn(II) or Mn(III); however, while this would be expected, it was not measured. Since  $MnO_4^-$  is a corrosive agent, it seems likely that it may have caused significant injury to the gastrointestinal tract (the patient did experience marked stomach pain), perhaps leading to a larger-than-normal gastrointestinal absorption of manganese.

In another study, Banta and Markesbery (1977) reported on a case involving a 59-year-old man with no occupational or environmental exposure to manganese. The man exhibited dementia and neuromuscular deficiencies including bradykinesia, shuffling gait, retropulsion, and rigidity in the upper extremities. Masked faces with infrequent blinking and stooped posture were also observed. Manganese concentrations were significantly elevated in serum, urine, hair, feces, and cerebrum. Although the authors posit that the man may have had Alzheimer's disease as well as manganese toxicity, they question how the individual could build up significant body stores of manganese in the absence of occupational exposure or any other known source of excess manganese. The authors suggest that the manganese overload may have been caused by abuse of vitamins and minerals.

Several studies have documented the potential for adverse neurological outcomes from childhood exposure to manganese-contaminated drinking water and/or food. Two studies (He et al. 1994; Zhang et al. 1995) have reported adverse neurological effects in children (aged 11–13) who were exposed to excess manganese in well water and in foods fertilized with sewage water. However, these two studies have several flaws that preclude their use as substantial support for the link between ingestion of excess

## 3. HEALTH EFFECTS

manganese and the incidence of preclinical neurological effects in children. These studies utilized a group of 92 children pair-matched to 92 controls who lived in a nearby region. The pairs were matched for age, sex, grade, family income level, and parental education level; in addition, all children lived on farms. Although the groups were well matched, the duration and amount of manganese uptake from the flour (from wheat fertilized with sewage) and drinking water containing excess levels was not well characterized. Moreover, the studies did not indicate if nutritional status, such as low iron or calcium intake, which could greatly enhance manganese uptake, were evaluated as potential confounding factors.

The exposed population drank water with average manganese levels of 0.241 mg/L (He et al. 1994; Zhang et al. 1995). The control group drank water containing 0.04 mg manganese/L. These values were measured over 3 years, although it was not stated if the children were exposed during the entire 3 years, or what the children's daily manganese intakes were. The exposed children performed significantly more poorly ( $p < 0.01$ ) in school and on neurobehavioral exams than control students. School performance was measured as mastery of the native language and other subjects; neurobehavioral performance was measured using the WHO core test battery. However, the report did not state what measures, if any, were taken to ensure that the individuals administering the tests were blind to the exposure status of the subject. Such safeguards would be necessary to prevent the introduction of bias in measurement and analysis of the performance data of the subjects. The exposed children's hair, blood, and urine manganese levels were significantly increased relative to controls. A simple correlation analysis indicated the performance of exposed children on five of the six of the neurobehavioral tests administered (digit span, Santa Ana manual dexterity, digit symbol, Benton visual retention test, and pursuit aiming test) was inversely correlated with hair manganese levels. Although the authors reported that iron, copper, and zinc were measured in blood and hair, no other metals were measured in these tissues. Because the exposed group presumably ingested food from sources irrigated with sewage, the children may have been exposed to increased levels of other metals, such as lead or mercury. The authors indicate that the children were exposed to increased manganese in their diet from excess levels in foodstuffs and drinking water. Of the foodstuffs evaluated (cabbage, spinach, potatoes, eggplant, sorghum, and flour), only wheat flour contained excess manganese compared to that from the control area. Although the total amount of manganese ingested from the wheat flour and drinking water was not estimated, the authors suggest that the elevated manganese level in drinking water was the key factor contributing to the observed effects. The authors report that children ingesting food and water containing elevated manganese showed poor performance in neurobehavioral tests and poorer school performance when compared to children from a control area. Because exposure levels and duration were not well defined, these studies as reported are not rigorous enough to establish causality between ingestion of excess manganese and preclinical

## 3. HEALTH EFFECTS

neurological effects in children. Nonetheless, these studies are strongly suggestive that subclinical neurobehavioral effects often seen in industrial workers exposed to excess manganese via inhalation are observed in children.

In a recent study, a cross-sectional investigation of intellectual function was conducted on 142 10-year-old children in Araihasar, Bangladesh, who had consumed tube-well water with an average concentration of 793  $\mu\text{g}$  manganese/L and 3  $\mu\text{g}$  arsenic/L (Wasserman et al. 2006). The children received a medical examination and their weight, height, and head circumferences were measured. Intellectual function was assessed on tests drawn from the Wechsler Intelligence Scale for Children, version III, by summing weighted items across domains to create verbal, performance, and full-scale raw scores (the tests were adapted for use in this particular population). Maternal intelligence was assessed with Raven's Standard Progressive Matrices, a non-verbal test considered relatively free of cultural influences. Children provided urine specimens for measuring urinary arsenic and creatinine and provided blood samples for measuring blood lead, arsenic, manganese, and hemoglobin concentrations. To assess the dose-response relationship between manganese in well water and intellectual function, children were stratified into four approximately equal sized groups, based on well water manganese levels. The results of the intelligence tests are displayed in Table 3-4.

The results indicated that, unadjusted for other contributors, children in group 1 (i.e., those with estimated mean dose of 0.006 mg manganese/kg bw/day), when compared with the other three groups, had higher full-scale scores; groups 2 (estimated mean dose of 0.02 mg manganese/kg bw/day) and 4 (estimated mean dose of 0.07 mg manganese/kg bw/day) were significantly different. The unadjusted result for performance scores revealed that group 2 had a significantly lower score than group 1. In the verbal test, group 4 had a significantly lower unadjusted score than group 1.

After adjustment for sociodemographic factors, groups 1 and 4 were significantly different on all three tests, with group 4 performing more poorly (Table 3-4). Although groups 2 and 3 (estimated mean dose of 0.04 mg manganese/kg bw/day) performed more poorly on average than group 1, the averages from groups 2 and 3 were not statistically significantly different from group 1. Therefore, children consuming the largest amounts of manganese from well water, estimated to be on average 0.07 mg manganese/kg bw/day, did show significant decrements in all forms of intellectual performance tested.

There are also individual case reports that supply further evidence of potential neurological effects from exposure to manganese-contaminated drinking water. Sahni et al. (2007) report a case history of a



## 3. HEALTH EFFECTS

**Table 3-4. Scores on Intelligence Tests**

| Test type   | Quartiles by mean calculated dose of manganese (mg/kg bw/day) <sup>a</sup> |          |          |                       |
|-------------|--|----------|----------|-----------------------|
|             | 0.006  | 0.02     | 0.04     | 0.07                  |
| Full-scale  | 81.7±3.1   | 73.0±4.1 | 74.0±3.7 | 60.7±5.2 <sup>b</sup> |
| Performance | 64.6±2.7   | 56.4±3.2 | 56.9±2.8 | 45.6±4.8 <sup>b</sup> |
| Verbal      | 17.6±0.8   | 16.6±0.9 | 17.0±1.0 | 14.3±1.3 <sup>b</sup> |

<sup>a</sup>Adjusted scores by four groups of water manganese for full-scale, performance, and verbal raw scores. In each case, adjustments were made for maternal education and intelligence, type of housing, child height, head circumference, and access to TV. Scores represent mean ± standard error on the mean.

<sup>b</sup>Adjusted score significantly different from lowest dose group,  $p < 0.05$ .

Source: Wasserman et al. 2006

## 3. HEALTH EFFECTS

previously healthy Canadian 6-year-old girl who lived with her family in an urban center in Canada. Since 2000, the child's family had spent summers at their nearby cottage, characterized as weekend visits in June, followed by full-time residence in July and August. While the municipal water used at the primary residence of the family had non-detectable levels of manganese, the cottage well used between 2000 and 2003 was found to have manganese concentrations of 1.7–2.4 mg/L. A neighboring cottage well used in 2004 had 1.7–2.2 mg manganese/L, while spring water used in 2004 had non-detectable levels. The child's estimated intake from well water exposure was 0.103 mg manganese/kg/day. In 2005, municipal water was brought to the cottage for drinking, but well water was used for washing and cooking. A food history demonstrated that the family consumed more manganese-rich foods, such as pineapples and leafy green vegetables, than a typical Canadian family. However, the family was not vegetarian. The patient and her 7-year-old, asymptomatic sister had very similar diets, with the exception that the sister consumed soy milk due to lactose intolerance. No inhalation exposures to manganese were identified. No industrial releases of manganese were reported in the vicinity of either residence. No other possible source of manganese involving occupational exposures, hobbies among family members, etc., was identified. The patient presented with pica and emotional lability in August 2004. Over the following months, she developed progressive behavioral and neurologic symptoms. She became withdrawn and less verbal, with stuttered and slurred speech. Her balance, coordination, and fine motor skills declined; eventually (in November 2004), she could no longer stand independently, tended to fall backward, and demonstrated a high steppage "cock-like" gait. An MRI indicated hyperintensity in the basal ganglia, indicative of high manganese accumulation. The patient demonstrated high levels of manganese in whole blood (39.7 µg/L). The patient also had severe iron deficiency and polycythemia, which was attributed to elevated cobalt. Her blood levels of lead were normal. While her liver manganese was elevated, her liver function was normal, as was her blood copper level. Other members of the family had elevated blood levels of manganese (1.9–2.8 µg/L) when tested between March and June 2005. The patient's symptoms abated to a large degree when she was treated with phlebotomies for the polycythemia and ethylene-diamine tetraacetic acid chelation for the manganese overload and iron therapy. These treatments occurred from November 2004 through July 2005, when her iron supplementation stopped. By August 2005, the patient's condition had deteriorated, with her pica returning; she fell frequently and needed assistance where she was previously independent. Phlebotomies and oral iron therapy were resumed in October 2005. The authors concluded that a metabolic disorder involving divalent metals (manganese, iron, and cobalt) interacting with environmental exposures was the most likely explanation for the patient's symptoms.

## 3. HEALTH EFFECTS

Woolf et al. (2002) describe the case of a 10-year-old boy whose sole source of drinking water at home over a 5-year period was from a well on the family's property in a Boston, Massachusetts suburb. The well water tested after 5 years of use had a manganese concentration of 1.21 ppm (estimated intake: 0.06 mg manganese/kg/day). The child had elevated blood levels of manganese (serum concentration of 0.90  $\mu\text{g}/100\text{ mL}$ , compared to reference normal of  $<0.265\ \mu\text{g}/100\text{ mL}$ ) and whole-blood manganese concentration of 3.82  $\mu\text{g}/100\text{ mL}$  (reference normal:  $<1.4\ \mu\text{g}/100\text{ mL}$ ). The child's urinary excretion of manganese was found to be 8.5  $\mu\text{g}/\text{L}$  over a 24-hour period (reference normal:  $<1.07\ \mu\text{g}/\text{L}$ ). Although no other member of the family exhibited elevated blood concentrations of manganese, the child and his brother each had elevated manganese levels in hair samples (the patient's level was 3,091 ppb; the brother's was 1,988 ppb; reference normal:  $<260\text{ ppb hair}$ ). At this time, the family switched to bottled drinking water, but continued to use the well water for other purposes (bathing, etc.). The child exhibited no evidence of illness or tremors. A detailed neurologic examination was normal. His balance with his eyes closed was good, but he did not coordinate rapid alternating motor movement well. His fine motor skills were normal and he had no sensory deficits. A battery of neuropsychologic tests revealed that while the child's global cognitive skills were intact, he had striking difficulties in both visual and verbal memory (14<sup>th</sup> and 19<sup>th</sup> percentiles, respectively), suggesting a deficit in free retrieval skills, and had a general memory index at the 13th percentile and learning index at the 19th percentile. The child was in 5<sup>th</sup> grade at the time of testing and had no history of learning problems, although teachers had persistently reported difficulties with listening skills and following directions. The authors report that the findings from the neuropsychological testing are consistent with the toxic effects of manganese, although the authors indicate that a causal relationship cannot be inferred in this case.

Though limited, these case reports also provide further evidence for a link between ingestion of elevated levels of manganese and learning problems. Other studies have found that manganese levels in hair are higher in learning-disabled children than in normal-functioning children (Collipp et al. 1983; Pihl and Parkes 1977). The route of excess exposure is not known, but is presumed to be mainly oral. These observations are consistent with the possibility that excess manganese ingestion could lead to learning or behavioral impairment in children as suggested by the results of He et al. (1994) and Zhang et al. (1995). However, an association of this sort is not sufficient to establish a cause-effect relationship because a number of other agents, including lead, might also be involved (Pihl and Parkes 1977). Moreover, other potentially confounding factors (e.g., health and nutritional status) must be taken into consideration in interpreting such studies.

## 3. HEALTH EFFECTS

However, a pilot study conducted by Bouchard et al. (2007c) found significant associations between hair levels of manganese and certain behavioral end points. The study involved a group of children (24 boys and 22 girls) from Quebec, Canada whose homes received drinking water from one of two wells; one well provided water with a relatively high level of manganese (610 µg/L; W1) and the second well provided water with a much lower level of manganese (160 µg/L; W2). The children, aged 9–13, had estimated average exposure levels of 0.02 mg manganese/kg/day (W1) and 0.007 mg manganese/kg/day (W2). The children with exposure to water from the high-manganese well had significantly higher ( $p < 0.05$ ) levels of manganese in their hair than those children exposed to water from the low-manganese well. Moreover, the children with high concentrations of manganese in their hair demonstrated significantly more ( $p < 0.05$ ) oppositional behaviors (e.g., breaking rules, getting annoyed or angered) and more hyperactivity than children with lower manganese hair concentrations (after adjustment of scores for age, sex, and income). No manganese-related differences were observed for tests related to cognitive problems (disorganization, slow learning, lack of concentration). Although this report is a pilot study, it nonetheless suggests the possibility that exposure to relatively high levels of manganese in water can influence behavior in children.

Several studies report the link between hepatic encephalopathy and an increased manganese body burden following chronic liver disease in adults (Hauser et al. 1994; Pomier-Layrargues et al. 1998; Spahr et al. 1996) and children (Devenyi et al. 1994) and in individuals with surgically-induced portacaval shunts (PCS) (Hauser et al. 1994). The manganese exposure in these studies was assumed to originate from a normal diet. Hepatic encephalopathy comprises a spectrum of neurological symptoms commonly occurring in individuals with chronic liver disease; these symptoms include varying degrees of mental dysfunction, although extrapyramidal symptoms may also be identified during a clinical examination (Spahr et al. 1996). In the Hauser et al. (1994) study, two men aged 49 and 65 years, both with chronic liver disease, and one 56-year-old man with cirrhosis of the liver and a portacaval shunt, showed a variety of neurological symptoms including bradykinesia, postural tremor of the upper extremities, and gait disturbances, as well as a decrease in cognitive function. These men all had significant elevations ( $p < 0.05$ ) in blood manganese as compared to healthy male and female controls, and had hyperintense signals in the basal ganglia bilaterally as measured by T1-weighted MRI. Similar elevations of blood manganese were reported in a population of 57 cirrhotic patients with an absence of clinical encephalopathy (Spahr et al. 1996). Blood manganese was elevated in 67% of the patients and was significantly higher in those patients with previous portacaval anastomoses or transjugular intrahepatic portosystemic shunt. MRI signal hyper intensity was observed in the globus pallidus; the elevated blood manganese levels were significantly correlated with the intensity of the signal in affected patients.

## 3. HEALTH EFFECTS

Neurological evaluation of extrapyramidal symptoms using the Columbia rating scale indicated a significant incidence of tremor, rigidity, or akinesia in ~89% of the patients, although there was no significant correlation between blood manganese level and these symptoms.

Similar results were observed in a young girl with Alagille's syndrome (involving neonatal cholestasis and intrahepatic bile duct paucity) with end-stage cholestatic liver disease who exhibited several neurological dysfunctions including dystonia, dysmetria, propulsion, retropulsion, and poor check response bilaterally (Devenyi et al. 1994). The girl had elevated blood manganese (27 µg/L compared to normal value of ~9.03 µg/L) and exhibited hyperintense MRI signal in the basal ganglia. After a liver transplant, the MRI signal abated and the blood manganese level returned to normal. This study and those in adults indicate that the increased manganese body burden (as evidenced by increased manganese blood and brain levels) may contribute to the resultant neurological symptoms and encephalopathy in individuals with cirrhosis or chronic liver disease.

Rose et al. (1999) evaluated brain manganese levels in 12 autopsied cirrhotic individuals who died from hepatic coma and 12 control subjects with no history of hepatic, neurological, or psychiatric disorders at time of death. Neutron activation analysis of the brain tissue revealed an increase in manganese content in the cirrhotic individuals, particularly in the globus pallidus, which had 186% more manganese than that of controls (significant at a level of  $p < 0.001$ ). Significant, although less extreme, increases in manganese were also found in the putamen and caudate nucleus from cirrhotic patients. However, the increased brain manganese did not correlate with patient age, the etiology of the cirrhosis, or the history of recurrent hepatic encephalopathy (reported in 6 patients).

An association has been suggested between violent behavior and excess manganese exposure; this was investigated by measuring the correlation between the manganese content in hair and violent behavior in prison subjects and controls (Gottschalk et al. 1991). The prisoners did have significantly higher hair manganese content than controls, but further research was indicated to determine whether manganese was a causative factor in violent behavior. The highest concentrations of manganese demonstrated in the hair samples (1.8–2.5 ppm) were, however, within the control ranges reported by Kondakis et al. (1989) (0–13 ppm) and Huang et al. (1989) (0.1–2.2 ppm for scalp and 0.3–9.8 ppm for pubic hair). Another factor to be considered in the interpretation of these results is the hair color composition within the samples evaluated. At least one study (Cotzias et al. 1964) has reported that manganese content was greater in dark hair when compared to that found in lighter colored hair. Another study showed that manganese accumulated in melanin-containing tissues including the melanin from human hair (Lydén et al. 1984). In

## 3. HEALTH EFFECTS

their study of inhabitants living in Angurugu on Groote Eylandt, Australia, Stauber et al. (1987) found that samples of grey hair from one elderly Aborigine participant had the same manganese content as the individual's black hair. The white hairs of a local dog also had the same manganese content as the dog's black hairs. Based on this evidence, these investigators stated that there was no evidence to support previous reports that dark colored hair concentrated more manganese than light hair. The average manganese content in scalp hair among male and female Aborigine residents was 3.5–5-fold greater than the average scalp hair manganese in male and female Caucasian residents, respectively. The authors cautioned that interpretation of data on manganese content in scalp hair should take into consideration endogenous as well as potential exogenous sources. Moreover, long-term manganese exposure that may be associated with adverse effects may not be represented by manganese content in hair growth from only a few months (Stauber et al. 1987). Thus, further investigations are needed to determine whether manganese content can vary significantly due to hair color pigment alone.

Manganese has also been associated with amyotrophic lateral sclerosis (ALS). In a human study, spinal cord samples from ALS patients were found to have higher manganese concentrations in the lateral fasciculus and anterior horn than in the posterior horn (Kihira et al. 1990). Also, ALS patients exhibited a positive correlation between manganese and calcium spinal cord content, whereas controls exhibited a negative correlation. It was suggested that an imbalance between manganese and calcium in ALS patients plays a role in functional disability and neuronal death. There was also some indication from previous studies that an excess intake of manganese in drinking water may have caused this imbalance, although data to support this were not presented. While this is suggestive of an association between manganese and ALS, it is equally plausible that ALS leads to an imbalance in manganese-calcium metabolism.

No neuropsychological effects were found in a recent study by Finley et al. (2003) of healthy, nonsmoking, premenopausal women were studied in a research project using a crossover design to determine the combined effects of very low or high dietary manganese with foods containing either saturated or unsaturated fats on measures of neuropsychological and basic metabolic function. Women were fed for 8 weeks at one of two doses of manganese (0.01 or 0.3 mg manganese/kg/day), with one-half of the subjects receiving 15% energy as cocoa butter and the other half receiving 15% energy as corn oil. Blood draws and neuropsychological tests (involving tests of steadiness and ability to control muscular tremor, signs of Parkinson's and related neurologic diseases, as well as tests to determine a range of components related to hostility and anger) were given at regular intervals during the dietary periods. Manganese intake did not affect any neurological measures and only marginally affected psychologic variables.

## 3. HEALTH EFFECTS

There are significantly more studies on the neurological effects of manganese ingestion in animals as compared to humans. A few of these report observed effects that were comparable to clinical signs seen in people. Gupta et al. (1980) reported that monkeys given 25 mg manganese/kg/day (as manganese chloride) for 18 months developed weakness and muscular rigidity (however, no data were provided to support these observations).

Rats dosed with 150 mg manganese/kg/day (as manganese chloride) developed a rigid and unsteady gait after 2–3 weeks, but this was a transient condition that was not apparent by 7 weeks (Kristensson et al. 1986). In addition, in two separate studies, the authors reported a decrease in spontaneous activity, alertness, muscle tone, and respiration in mice dosed once with 58 mg manganese/kg/day by gavage (Singh and Junnarkar 1991) and staggered gait and histochemical changes in two third-generation mice treated with 10.6 mg manganese/kg/day (as manganese chloride) in drinking water (Ishizuka et al. 1991). As shown in Table 3-3 and Figure 3-3, changes of this sort have been reported at oral exposure levels that ranged from 1 to 2,270 mg manganese/kg/day (as manganese chloride, manganese acetate, or manganese tetroxide) (e.g., Bonilla 1978b; Bonilla and Prasad 1984; Chandra 1983; Eriksson et al. 1987a; Gianutsos and Murray 1982; Gray and Laskey 1980; Komura and Sakamoto 1991, 1992b; Lai et al. 1984; Nachtman et al. 1986; Subhash and Padmashree 1991). Thus, the database on neurological effects in adult animals ingesting high levels of manganese does not provide a clear picture of manganese-induced effects and the significance of these results is difficult to interpret.

Rose et al. (1999) reported the effects on manganese body burden (exclusively from the diet) in rats with either induced cirrhosis of the liver, acute liver failure (induced by portacaval anastomosis followed by hepatic artery ligation), or a surgically-administered portacaval shunt (PCS). Brain manganese levels in these three groups of rats were compared to control rats and sham-operated rats. PCS and sham-operated rats were evaluated 4 weeks following surgery, while cirrhotic rats were studied 6 weeks following surgery. Rats with acute liver failure were studied 15–18 hours following devascularization at coma stage of encephalopathy. Manganese levels were statistically significantly increased as compared to non-treated controls and sham-operated controls in both cirrhotic and PCS rats in the frontal cortex, globus pallidus, and caudate/putamen; manganese levels were highest in the globus pallidus. For example, in the globus pallidus, brain manganese was increased 57% in the PCS rats as compared to the control rats ( $p < 0.0001$ ). However, the level of manganese in the globus pallidus in the PCS rats was significantly elevated as compared to cirrhotic rats, indicating that shunting is a strong determinant of manganese deposition in the brain.

## 3. HEALTH EFFECTS

Montes et al. (2001) also explored the potential for hepatic disease to potentiate the toxic effects of manganese by observing effects on levels of specific neurotransmitters. Groups of male Wistar rats were assigned to one of six treatments: (1) sham operated; (2) bile duct ligated (BDL); (3) sham operated with 15.1 mg manganese/kg/day supplied as manganese chloride in drinking water; (4) BDL with 15.1 mg manganese/kg/day in drinking water; (5) sham operated with 26.7 mg manganese/kg/day in drinking water; or (6) BDL with 26.7 mg manganese/kg/day in drinking water. The BDL condition models a cirrhotic-type condition in the rats. Rats received this treatment for 4 weeks beginning at surgery. At the end of treatment, rats were weighed and killed. Total bilirubins (as well as conjugated and unconjugated forms) increased over control in all BDL groups, but there was no significant effect of manganese treatment. There was also no effect of manganese on alanine aminotransferase levels or on collagen, although these measures were significantly increased by BDL. However, the combination of BDL and manganese exposure produced 2- and 4-fold increases ( $p < 0.001$ ) of striatal manganese content at the 15.1 and 26.7 mg manganese/kg/day doses, respectively, while BDL alone did not produce changes. Striatal DA content was significantly decreased compared to control in BDL rats; the addition of 26.7 mg manganese/kg/day to BDL produced an approximate 33% increase in dopamine (DA) content over BDL alone. The highest dose of manganese produced 2-fold striatal homovanillic acid (HVA) increases over control in both sham-operated and BDL rats. BDL and manganese treatment at 15.1 mg manganese/kg/day each individually produced 2-fold increases over control levels in striatal DA turnover, measured as HVA/DA; the combination of BDL with manganese at 15.1 mg manganese/kg/day produced the same result as each condition individually. The sham-operated and BDL high dose rats each had HVA/DA levels of nearly 3 times the control level; all of these differences were significant ( $p < 0.05$ ). These results suggest that hepatic dysfunction can, indeed, potentiate the neurotoxicity of manganese.

In another study, Montes et al. (2006) explored the potential role of hepatic dysfunction as a potentiator of the toxic effects of manganese on neuronal damage produced by oxidative stress. Groups of male Wistar rats were assigned to one of four treatments ( $n=6-9$  in each group): (1) sham operated; (2) BDL; (3) sham operated with 26.7 mg manganese/kg/day (as manganese chloride) in drinking water; or (4) BDL with 26.7 mg manganese/kg/day in drinking water. Rats received this treatment for 4 weeks beginning at time of surgery. Compared with sham-operated controls, BDL treatment with or without manganese caused significant ( $p < 0.05$ ) increases ( $>2$ -fold) in gamma glutamyltranspeptidase and alanine aminotransferase activities, collagen, and glycogen levels, but manganese alone did not increase these indices of liver damage. Manganese or BDL treatments alone caused moderate, statistically significant ( $p < 0.05$ ) increases ( $\sim 20\%$ ) in manganese content in the striatum and globus pallidus. Manganese contents



## 3. HEALTH EFFECTS

in both regions were further and markedly increased by the BDL and manganese treatment (300–400% increase). Levels of nitric oxide (NO) were not consistently changed in either brain region in manganese-alone or BDL plus manganese-treated rats compared with sham-operated controls, with the exception that the NO levels in the globus pallidus were decreased ( $p < 0.05$ ) by ~25% in BDL and BDL plus manganese rats. Constitutive nitric oxide synthetase (NOS) activities in the globus pallidus were decreased (but not to a statistically significant degree) in BDL and BDL plus manganese-treated rats.

Many studies in animals have explored the interplay between iron deficiency and manganese supplementation and its ultimate potential for modulating neurotransmission in the brain. In a study by Li et al. (2006) groups of 7–8-week-old male Sprague-Dawley rats were dosed by gavage with sterile saline (control) or manganese chloride dissolved in sterile saline at 2.2 or 6.6 mg manganese/kg/day; rats were dosed daily for 5 consecutive days/week (weekdays only) for 30 days. The study was conducted to determine the mechanism by which iron is regulated at the blood-brain barrier and the blood-cerebrospinal fluid (B-CSF) barrier and how manganese may alter these processes. Serum iron concentrations were found to be significantly decreased ( $p < 0.05$ ) at 2.2 and 6.6 mg manganese/kg/day (50 and 66% of control value, respectively). In contrast, iron concentrations in the cerebrospinal fluid (CSF) were significantly ( $p < 0.05$ ) increased at 2.2 and 6.6 mg manganese/kg/day (136 and 167% of control values). Manganese produced a dose-dependent increase of binding of IRP1 to iron-responsive element-containing RNA in (percentage increase of high-dose group over control indicated in parentheses): the choroid plexus (+70%); in capillaries of striatum (+39%), hippocampus (+56%), and frontal cortex (+49%); and in brain parenchyma of striatum (+67%), hippocampus (+39%), and cerebellum (+28%). Manganese exposure significantly increased the expression of TfR mRNA in choroid plexus and striatum with a reduction in the expression of Ft mRNA. The results indicate that intermediate-duration oral exposure to excess manganese decreased serum iron concentrations and increased iron concentrations in the CSF. These changes were associated with: (1) increased binding of iron regulatory proteins and mRNA containing iron responsive element in several brain regions and (2) upregulation of transferritin receptor mRNA and down-regulation of ferritin mRNA in choroid plexus and striatum.

In a recent study by Anderson et al. (2007a), male and female PND 1 Sprague-Dawley rats were divided into groups receiving either a control diet (35 mg iron/kg, 10 mg manganese/kg diet and drinking water) or a diet with manganese supplementation (same as control diet with 1 g/L of manganese chloride added to drinking water for a final dose of 71.1 mg manganese/kg/day). Rats were sacrificed after 6 weeks of treatment. Additional females and males ( $n=6$  per group) were provided with an iron-deficient diet

## 3. HEALTH EFFECTS

(4 mg/kg iron, 10 mg manganese/kg diet and drinking water) and an iron deficient/manganese supplemented diet (same iron-deficient diet plus 1 g manganese chloride/L water). Manganese exposure significantly ( $p < 0.05$ ) reduced iron concentrations in the caudate putamen and the substantia nigra from male and female rats. In female rats, manganese exposure also significantly reduced iron levels in the caudate putamen. The largest decrease was seen in the female caudate putamen, where iron levels dropped by approximately 66% compared to controls and the female substantia nigra, where iron levels dropped by approximately 75% compared to controls. Manganese concentrations in the brain were seen to increase over controls most prominently in the female globus pallidus (approximately 60%). A significant negative correlation ( $p < 0.05$ ) was observed between synaptosomal manganese concentration and 3H-GABA uptake in rats of both sexes. 3H-GABA levels were significantly reduced from controls in both males and females (by approximately 50%). In rats provided with an iron-deficient diet, few differences were observed between the iron-deficiency condition and the iron-deficiency plus manganese condition. In males, iron levels were approximately 10 times higher in the caudate putamen of iron-deficient animals than in the animals that were iron-deficient and manganese-supplemented.

Some studies have explored the relation between high dietary manganese and nitrous oxide synthesis as a means of exploring the impact of manganese on oxidative stress and, hence, neuronal injury.

Liu et al. (2006) studied 12-week-old female C57Bl/6 mice, paired as littermates from timed pregnant dams, that received by gavage either water or 43.7 mg manganese/kg/day as manganese chloride for 8 weeks prior to sacrifice. Manganese-treated mice had significantly ( $p < 0.05$ ) increased levels of manganese in the striatum and decreased locomotor activity and striatal dopamine content. Neuronal injury in the striatum and globus pallidus was observed, especially in regions proximal to the microvasculature. Neuropathological assessment revealed marked perivascular edema, with hypertrophic endothelial cells and diffusion of serum albumin into the perivascular space. Immunofluorescence studies revealed the presence of apoptotic neurons expressing neuronal NOS choline acetyltransferase, and enkephalin in both the striatum and globus pallidus. Soma and terminals of dopaminergic neurons were morphologically unaltered in either the substantia nigra or striatum. Regions with neuronal injury contained increased numbers of reactive astrocytes that coexpressed inducible NOS2 and localized with areas of increased neuronal staining for 3-nitrotyrosine protein adducts, a marker of NO formation. The data suggest a possible role for astrocyte-derived NO in injury to striatal-pallidal interneurons from manganese intoxication.

## 3. HEALTH EFFECTS

In a study by Weber et al. (2002), Charles River CD rat pups were dosed (by mouth with micropipette) according to average pup weight for each litter starting on PND 1 and continuing until PND 21 at doses of 0 (nanopure water vehicle), 6.9, or 138 mg manganese/kg/day. Pups were sacrificed on PND 21, and samples of cerebellum and cerebral cortex were collected and frozen in liquid nitrogen, with manganese concentrations evaluated in brain tissue. Also evaluated were cerebrocortical and cerebellar metallothionein (MT) mRNA levels, glutamine synthetase (GS) activity, GS protein levels, and total glutathione (GSH) levels. High-dose manganese exposure significantly increased ( $p < 0.05$ ) total cerebrocortical GSH when compared to control without changes observed in any of the other measures. The same change was apparent with the high-dose manganese exposure on cerebellar GSH, although slight differences in the standard error of the mean prevented reaching statistical significance. However, it should be noted that these measures actually decreased with respect to the control in the low dose manganese group. Overall, data do not appear to support an effect of manganese exposure on measured biochemical variables indicative of oxidative stress.

In a study by Lipe et al. (1999), groups of 30-day-old and 90-day-old male Sprague-Dawley rats were exposed to 10 or 20 mg manganese/kg/day as manganese chloride for 30 days. A dose-dependent decrease in body weight gain was found in the adult, but not the weanling rats. Significant ( $p < 0.05$ ) increases were observed in concentrations of aspartate, glutamate, glutamine, taurine, and gamma-aminobutyric acid (GABA) in the cerebellum of the adult rats dosed with 20 mg manganese/kg/day; this increase also appeared to be dose dependent. A significant ( $p < 0.05$ ) decrease in the concentration of glutamine was observed in caudate nucleus and hippocampus of weanling rats dosed with 10 mg manganese/kg/day. A significant ( $p < 0.05$ ) increase in GABA concentration in the caudate nucleus of weanlings was observed in the 20 mg manganese/kg/day group. A significant ( $p < 0.05$ ) decrease in the concentration of glutamine in the caudate nucleus and hippocampus was found in weanlings of the 10 mg manganese/kg group.

In a study by Morello et al. (2007), groups of adult male Wistar rats had free access to either normal drinking water or to a water solution providing 611 mg manganese/kg/day as manganese chloride, with treatment lasting for 13 weeks. A significant reduction in the number of immunoreactive cells for glutamine synthetase was observed in the globus pallidus for manganese-treated animals compared to controls (33% reduction). No effect of manganese was observed in the sensorimotor cortex or striatum, nor was there any effect observed for other manganoproteins tested.

## 3. HEALTH EFFECTS

In a study by Ranasinghe et al. (2000), groups of male Sprague-Dawley rats were provided daily with 0 (n=2), 74.9 (n=4), or 149.8 mg (n=4) mg manganese/kg/day, administered as manganese sulfate; another control group of two rats received 20 mg sodium/day. All animals were treated for 50 days. Mean manganese concentrations in liver, brain, heart, and kidney were elevated in the low- and high-dose groups, compared with untreated sodium controls, but statistical analyses of these data were not performed. A decrease was observed in dopamine serum levels in manganese-treated rats compared to controls; the sulfated form was increased in both dose groups compared to controls (12–13 times; from 0.014 nmol/mL in controls to 0.179 nmol/mL in the 20 mg manganese group). Increases were also observed in L-dopa and L-dopa sulfate in both treatment groups. No treatment-related differences were observed in serum levels of L-P tyrosine or its L-P tyrosine sulfate.

In a study by Desole et al. (1997), groups of 3-month-old male Wistar rats were given gavage doses of 0 or 8.8 mg manganese/kg/day as manganese chloride in water for 6 days. Other groups of control or manganese-treated rats received 20 mg/kg buthionine (S,r) sulfoximine0ethyl ester (BSO-E) by intraperitoneal injection twice daily (1 hour before gavage treatment) on days 4, 5, 6, and 7. Rats were sacrificed on day 7, and brainstem samples were extracted for determination of concentrations of dopamine, dihydroxyphenylacetic acid (DOPAC), HVA, and noradrenaline (NA), as well as concentrations of reduced glutathione, ascorbic acid, dehydroascorbic acid, and uric acid (the latter being indicators of oxidative stress potential). Compared with controls, manganese treatment alone increased concentrations of GSH (10–14%) and uric acid (28–45%) in striatum and brainstem, without affecting ascorbic acid concentrations, increased concentrations of DOPAC and HVA in striatum, without affecting dopamine, and decreased brainstem concentrations of dopamine. As expected, BSO-E treatment alone decreased GSH concentrations in striatum (23%) and brainstem (35%), without affecting striatal or brainstem concentrations of ascorbic acid, dehydroascorbic acid, or uric acid or striatal concentrations of dopamine, DOPAC, or HVA; however, brainstem concentrations of dopamine were decreased by this treatment. Compared with controls, manganese plus BSO-E treatment decreased concentrations of GSH and ascorbic acid in striatum (42 and 22%, respectively) and brainstem (23 and 22%, respectively) and increased concentrations of dihydroxyascorbic acid and uric acid; these results are indicative of a heightened oxidative stress condition. In addition, manganese plus BSO-E treatment decreased striatal concentrations of dopamine, DOPAC, and HVA and brainstem concentrations of dopamine and noradrenaline. The magnitude of the manganese plus BSO-E treatment changes were mostly larger than changes seen in all other experimental groups. The results indicate that the manganese treatment decreased brainstem concentrations of dopamine without affecting neurochemical indicators of oxidative

## 3. HEALTH EFFECTS

stress and that a glutathione depleted condition potentiated the effects of manganese on brainstem and striatal concentrations of dopamine, DOPAC, and HVA.

The effects of manganese on a variety of behavioral assessments in rats have been conducted; these studies have found changes in measures related to fear, locomotor activity, and cognitive performance (Calabresi et al. 2001; Shukakidze et al. 2003; Torrente et al. 2005; Vezér et al. 2005, 2007). In some of these studies, electrophysiological changes in the brain have been associated with the behavioral changes (Calabresi et al. 2001; Spadoni et al. 2000; Vezér et al. 2005, 2007).

Measures of locomotor activity, fear, and learning and memory were made on male Wistar rats treated with either tap water as drinking water or a solution of magnesium chloride (1,310 mg manganese/kg/day) as drinking water for 10 weeks (Calabresi et al. 2001). Brain manganese levels ranged from 3 to approximately 4 times higher than controls. Manganese-treated rats were significantly ( $p < 0.001$ ) more active than control rats in the open field. Manganese-treated rats showed progressively and significantly more interest in the "novel" object over three trials than the control rats ( $p < 0.001$ ; an average of four contacts for manganese-treated animals compared to an average of  $< 2$  for controls on the third trial). Manganese-treated animals also produced significantly ( $p < 0.05$ ) more fecal boluses (indicative of heightened fearfulness) in the open field than control rats over the three trials. No major differences were observed between treatment groups in the eight-arm radial maze test, with the manganese-treated animals taking significantly ( $p < 0.01$ ) more 45 degree angle turns than the control rats. An enhanced dopaminergic inhibitory control of the corticostriatal excitatory transmission via presynaptic D2-like dopamine receptors in corticostriatal slices obtained from the manganese-treated rats was observed. The use of agonists acting on presynaptic purinergic, muscarinic, and glutamatergic metabotropic receptors revealed normal sensitivity. Membrane responses recorded from single dopaminergic neurons following activation of D2 dopamine autoreceptors were also unchanged following manganese intoxication. The authors suggest that the behavioral symptoms described in the "early" clinical phase of manganism may be produced by an abnormal dopaminergic inhibitory control on corticostriatal inputs (Calabresi et al. 2001).

Spadoni et al. (2000) studied groups of male, PND 20 Wistar rats provided with either access to drinking water or 3311 mg manganese/kg/day in drinking water, with treatment lasting for 13 weeks. No neuronal loss or gliosis was detected in the globus pallidus with either treatment. However, the majority of GP neurons from manganese-treated rats died following brief incubation in standard dissociation media. Patch-clamp recordings in the whole-cell configuration were not tolerated by surviving GP neurons from

## 3. HEALTH EFFECTS

manganese-treated rats. Manganese-treated GP cells, but not striatal cells, demonstrated an unusual response to glutamate, since repeated applications appeared to produce irreversible cell damage.

Another factor that could potentiate the neurotoxicity of manganese was explored by Torrente et al. (2005), with rats subjected to restraint stress along with manganese exposure. Groups of 15 adult male Sprague-Dawley rats (250–300 g) were dosed for 2 weeks with either plain drinking water or drinking water providing 38.2 mg manganese/kg/day as manganese chloride. The manganese chloride group was then split into two groups, with drinking water doses of 76 and 153 mg manganese/kg/day provided for another 19 weeks. One-half of the animals in each group were subjected to restraint stress for 2 hours daily by placing them in metacrilate cylindrical holders. Animals treated with 153 mg manganese/kg/day with restraint traveled a significantly shorter distance than control restraint animals (38% decrease;  $p < 0.05$ ). Manganese concentrations in brain and cerebellum were significantly elevated in exposed groups, compared with controls. Body weight and food consumption were significantly decreased ( $p < 0.05$ ) in the exposed groups, compared with control values. Terminal body weights were 86 and 51% of control values in the low- and high-dose unrestrained groups and 90 and 56% in the respective restrained groups. Open field activity was significantly decreased ( $p < 0.05$ ) in the high-dose restrained groups. Spatial learning was also impaired in high-dose rats with or without restraint); for example, unrestrained high-dose rats showed significantly ( $p < 0.05$ ) increased latency to find a hidden platform in the water maze test on days 1, 2, 3, 4, and 5 of testing.

In a study by Shukakidze et al. (2003), groups of white rats were tested for cognitive performance in a multipath maze. Group I served as a control group, which was trained in the maze for 10 days, fed normal feed for 30 days, and then retested. Groups II and III, instead of receiving normal feed, received dosed feed at 5.6 or 13.9 mg manganese/kg/day (as manganese chloride). Groups IV and V were dosed the same doses as Groups II and III, respectively, but received the doses for 30 days prior to maze training. Groups II and III received normal feed for the next 90 days prior to retesting for 10 days. An additional group of animals received a single dose (undefined route) prior to 10 days of training in the maze. Both groups of rats dosed after training (Groups II and III) showed moderate disruption of their acquired skill in the maze compared to controls. Group III also demonstrated increased "aggressivity". Both groups that were exposed prior to training (Groups IV and V) were entirely unable to learn the maze. When these rats were reassessed after a 3-month period without excess manganese, they remained unable to learn the maze. After training, 8/12 rats in the group with the single dose (Group VI) mastered the maze; 4/12 required assistance from the experimenter to orient themselves. Groups of 9 (control) and 10 (manganese-treated) rats were tested in an active avoidance of conditioned and unconditioned stimuli

## 3. HEALTH EFFECTS

paradigm. Manganese-treated rats received by mouth 13.9 mg manganese/kg/day (as manganese chloride) in water 1 hour prior to the experiment on day 1. Rats were tested over 16–17 days. Manganese treatment resulted in significant and reversible behavioral change, with manganese exposure leading to worsened acquisition of the avoidance reaction in response to unconditioned and conditioned stimuli, increased latent period of conditioned reflex activity, and increased numbers of errors and time taken to navigate a maze, beginning on day 5 of the experimental period and lasting until day 10–15, depending on the end point.

Tran et al. (2002b) studied Sprague-Dawley rat pups that received dietary supplementation in the form of 0, 0.7, 3.8, or 7.5 mg manganese/kg/day (as manganese chloride). Male and female pups were sacrificed during infancy and at weaning (18–24 per treatment group) for tissue analyses of trace elements. Twenty-four rats were sacrificed at PND 35 for dopamine analysis (Tran et al. 2002a). The 32 remaining rats, all males, no longer received treatment. Behavioral testing began with a burrowing detour test (PNDs 50–56) and ended with a passive avoidance test (PNDs 60–64). No statistically significant results for any individual treatment group for any behavioral task or striatal dopamine levels. A statistically significant positive trend was observed for passive avoidance (approximately 50% more footshocks in highest dose group compared with control). The control had approximately 2 times the striatal dopamine levels of the two highest dose groups on animals sacrificed on PND 65. Striatal dopamine increase observed in Tran et al. (2002a) at an earlier timepoint (PND 40).

Vezér et al. (2005, 2007) examined neurobehavioral end points in young adult male Wistar rats treated by water gavage with 0, 6.5, or 25.9 mg manganese/kg/day for 10 weeks. Rats were tested in an eight-arm radial maze test (spatial learning and memory test) and an open field test (locomotor ability). Rats were also tested for amphetamine-induced locomotor activity, acoustic startle response, and prepulse inhibition. At 5 and 10 weeks of treatment, as well as at the end of the post-treatment period 8 weeks later, electrophysiological testing was performed, including recording of cortical evoked potentials as well as spontaneous electrical activity in the hippocampus. Immunohistochemistry was performed to detect changes in density of glial fibrillary acid protein (GFAP) immunoreactive structures in the hippocampal CA1 region. Blood and tissue samples (from the cortex and hippocampus) were collected in the 5th and 10th treatment and 12 post-treatment week. Blood and tissue levels of manganese were determined. Manganese accumulation was first seen in blood and then in brain of high-dose rats. Decreased short- and long-term spatial memory performance (at least  $p < 0.05$ ) and decreased spontaneous open field activity ( $p < 0.05$ ) were observed in both low- and high-dose groups compared with controls. The number of acoustic startle responses, as well as their associated prepulse inhibition of the acoustic startle

## 3. HEALTH EFFECTS

responses, were decreased in manganese-treated animals. The latency of sensory evoked potentials increased and their duration decreased. Manganese levels returned to normal at the end of the post-treatment period, but impairment of long-term spatial memory remained, as well as the decrease in number of acoustic startle responses in high-dose rats. Prepulse inhibition responses returned to normal. Open field activity returned to normal at the end of post-treatment, but a residual effect could be observed under the influence of D-amphetamine. The electrophysiological effects partially returned to normal during post-treatment. Significantly ( $p < 0.05$ ) high percentages of area showing GFAP immunoreactivity were observed in the dentate gyrus (but not in the striatum radiatum or striatal oriens) in the low- and high-dose groups, compared with controls.

No studies regarding neurological effects following oral exposure to MMT by humans were identified.

Komura and Sakamoto (1992b) administered 11 mg manganese/kg/day (as MMT) to ddY mice in food for 12 months. To measure differences in behavior between exposed and control mice that were fed normal chow, spontaneous motor activity was measured at regular intervals during exposure to determine differences in behavior between exposed and control mice fed normal chow. The authors observed a significant increase in spontaneous activity at day 80; no other significant differences were noted. In a separate study (Komura and Sakamoto 1994), the authors analyzed brain levels of different neurotransmitters and metabolites after identical MMT treatment. MMT resulted in a 66% decrease in dopamine (DA;  $p < 0.05$ ) and a 95% decrease in normetanephrine (NMN;  $p < 0.01$ ) in the hypothalamus; in the hippocampus, DA was unchanged, while the level of 3,4-dihydroxyphenylacetic acid (DOPAC) was reduced 41% ( $p < 0.05$ ), and the 3-methoxytyramine (3MT) level increased 3.5-fold ( $p < 0.01$ ). In the midbrain, the only significant changes noted were an almost 6-fold increase in 3MT ( $p < 0.01$ ) and a 1.75-fold increase of homovanillic acid (HVA), a metabolite of DOPAC via conjugation by catechol-*o*-methyl transferase ( $p < 0.05$ ). In the cerebral cortex, HVA was decreased by 61%, norepinephrine (NE) by 64%, and epinephrine by 43% (all were  $p < 0.05$ ) due to MMT administration. In the cerebellum, DOPAC was decreased 51% ( $p < 0.05$ ), while NMN was increased 7.7-fold ( $p < 0.01$ ). Finally, in the medulla oblongata, DOPAC was decreased by 45% ( $p < 0.05$ ), HVA was decreased by 55% ( $p < 0.01$ ), and serotonin (5HT) was decreased 81% ( $p < 0.01$ ); metanephrine was increased approximately 2.75-fold in the medulla ( $p < 0.05$ ).

Through analysis of the distribution of manganese in the different brain regions of the mice, the authors observed relationships between manganese content and neurotransmitter levels. For example, a weak relationship was found between the manganese level in the corpus striatum and the level of NE. There



### 3. HEALTH EFFECTS

was no relationship between the increase in HVA and the manganese levels in this same region. The relationship between the increase in 3MT and manganese levels in the midbrain was weak, as was the relationship between DOPAC and manganese levels in the cerebellum. There were no relationships between amines and manganese levels in the hippocampus, cerebral cortex, or medulla oblongata, although some changes were found. A significant correlation was found between the level of NMN and manganese in the cerebellum. As discussed more fully in Section 3.4.2, the cerebellum contained the most manganese of any brain region following MMT administration (Komura and Sakamoto 1994).

#### 3.2.2.5 Reproductive Effects

Potential reproductive effects of manganese were suggested by the results of a study by Hafeman et al. (2007), where high infant mortality in a Bangladesh community was reported in conjunction with the presence of a local drinking water supply containing high levels of manganese. The Health Effects of Arsenic Longitudinal Study (HEALS) was conducted on 11,749 participants 18–70 years of age living in Araihaazar, Bangladesh. Data on the reproductive history of the 6,707 women in this population were collected and samples were taken of drinking water from all of the wells in the study region. Manganese concentrations were determined for a total of 1,299 wells, representing the drinking water supply of 3,824 infants <1 year old. Eight-four percent of infants were exposed, directly or through maternal intake, to water manganese levels above 0.4 mg/L with manganese concentrations ranging from 0 to 8.61 mg/L, for an average calculated daily intake of 0.26 mg manganese/kg/day. Of the 3,837 children born to women who reported to drink from the same well for most of their childbearing years, 335 of them died before reaching 1 year of age. Infants exposed to greater than or equal to the 0.4 mg/L WHO (2004b) standard for manganese in drinking water had an elevated mortality risk during the first year of life compared to unexposed infants (OR=1.8; 95% CI, 1.2–2.6). Adjustment for water arsenic indicators of social class and other variables and potential confounders did not appreciably alter the results. When the population was restricted to infants born to recently married parents (marriage year 1991 or after), the elevation was larger (OR=3.4; 95% CI, 1.5–7.9). Although the results of the study suggest that the presence of high levels of manganese in the water may be responsible for the high infant mortality observed here, information provided by the authors on mechanism of manganese exposure suggests that infant exposure to the high levels of manganese in the water may be complex (i.e., would likely require direct rather than indirect or fractionated exposure, such as that occurring through breast milk or by *in utero* exposure). The authors also indicate that it is not possible to infer that the manganese is solely responsible for the high rate of infant mortality documented in this study

## 3. HEALTH EFFECTS

In a 14-day study in rats, no changes in testicular weight were reported at 1,300 mg manganese/kg/day (NTP 1993). However, several intermediate-duration studies in rats and mice indicate that manganese ingestion can lead to delayed maturation of the reproductive system in males. One study investigated the effect of 1,050 mg manganese (as manganese tetroxide)/kg/day, provided to weanling mice and their dams starting when the pups were 15 days old (Gray and Laskey 1980). On day 30, the mice were weaned and maintained on the high-manganese diet until killed for analysis at 58, 73, or 90 days old. The growth and general appearance of the weanling rats appeared normal. At time of death, preputial gland, seminal vesicle, testes, and body weights were measured. The high-manganese diet resulted in a significant decrease in growth of these reproductive tissues but no growth retardation of the body and no change in liver or kidney weights.

A later study by Laskey et al. (1982) evaluated the reproductive functioning of male and female Long-Evans rats that had been exposed to 0, 350, 1,050, and 3,500 mg manganese/kg/day (in conjunction with a low-iron diet [20 mg iron/kg/day] or a diet adequate in iron [200 mg iron/kg/day]) while *in utero* (dams were fed the described diets during gestation) and from day 14 to 15 postpartum. The rats were maintained on the diet throughout the remainder of the study (224 days). The rats were mated at 100 days postpartum and the reproductive success of these matings was evaluated.

In males, manganese treatment resulted in decreased testes weights (testes weights analyzed with body weight as a covariable) observed at 40 days (at the 1,050 and 3,500 mg manganese/kg/day dose levels) and 100 days (at the 1,050 mg manganese/kg/day dose level) of age, only when administered with the low-iron diet. Hormone levels in male rats were also evaluated. No treatment-related effect was seen in 40-day-old males. At 60 and 100 days of age, however, dose-related decreases in serum testosterone were observed, while serum LH (luteinizing hormone) levels remained relatively unchanged. Luteinizing hormone (LH) is secreted by the pituitary to stimulate testosterone production in the Leydig cells. Testosterone levels control LH production through a negative feedback loop. An increase in testosterone would normally be associated with a subsequent decrease in LH. The decrease in testosterone simultaneous with a stable LH levels suggests that manganese is targeting the Leydig cells. Manganese treatment in both iron regimens prevented the normal decrease in serum follicle-stimulating hormone (FSH) from 60 to 100 days. In addition, manganese only negatively affected epididymal sperm counts at 100 days in the iron-deficient group. When serum concentrations of LH, FSH, and testosterone and epididymal sperm counts from the 60- and 100-day-old rats were used to predict the reproductive age of the males, the 60-day old animals were predicted correctly. Of the 100-day-old animals, 2/12 controls, 7/12 at 350 mg manganese/kg, and 12/12 at 1,050 mg manganese/kg were classified as 60 days old.

## 3. HEALTH EFFECTS

These data indicate that manganese induced a significant maturational delay in the reproductive organs of the male rat (Laskey et al. 1982).

To further assess the mechanism of toxicity of manganese in the pre-weanling rat, Laskey et al. (1985) dosed rats from birth to 21 days of age with particulate manganese tetroxide in 50% sucrose solution by gavage at doses of 0, 71, or 214 mg manganese/kg/day. They then assessed the hypothalamic, pituitary, and testicular functions in the rat by measuring the endogenous or stimulated serum concentrations of FSH, LH, and testosterone at 21 or 28 days of age. LH-releasing hormone (LH-RH) was used to stimulate the pituitary-testicular axis to secrete FSH, LH, and subsequently testosterone; human chorionic gonadotropin (hCG) was used to stimulate acutely (2-hour time period) the testicular secretion of testosterone and repeatedly (7-day time period) to assess the ability of the Leydig cells to maintain maximal testosterone synthesis and secretion. Some rats from both control and manganese-dosed groups were castrated to determine the effect this would have on the study end points. Manganese treatment had only a slight effect on body and testes weights, while no effects were observed on unstimulated or stimulated FSH or LH serum levels. In addition, manganese did not affect endogenous or acute hCG-stimulated serum testosterone concentrations, but did decrease serum testosterone level following repeated hCG stimulation. Liver manganese at the 71 mg/kg/day manganese dose was significantly elevated over controls in both castrated ( $8.42 \pm 7.23$  mg/kg for treated vs.  $1.96 \pm 0.22$  mg/kg for controls) and noncastrated ( $3.36 \pm 0.91$  mg/kg for treated vs.  $1.81 \pm 0.11$  mg/kg for controls) rats. In addition, hypothalamic manganese concentrations were significantly increased at the 71 mg/kg/day dose in both castrated ( $6.10 \pm 3.0$  mg/kg in treated vs.  $0.59 \pm 0.11$  mg/kg in controls) and noncastrated ( $3.73 \pm 1.18$  mg/kg in treated vs.  $0.65 \pm 0.057$  mg/kg in controls) rats. The authors speculate that since their earlier results had shown changes in male reproductive development in postpubertal animals with minimal manganese concentrations in tissues (Gray and Laskey 1980; Laskey et al. 1982), it seemed likely that the changes in this later study (Laskey et al. 1985) would result from high manganese concentrations in the hypothalamus, pituitary, or testes, with the tissue with the highest manganese concentration being the site of the toxic reproductive effect. However, the results from this latest study reveal that manganese had no effect on the hypothalamus or pituitary to produce LH or FSH in pre-weanling rats, despite the increased manganese concentrations. Rather, the data indicate that it is delayed production of testosterone, shown by the inability of the Leydig cells to maintain maximum serum concentrations of the hormone, which results in the delayed sexual maturation. This delay in testosterone was not significant enough, however, to impair rodent fertility at manganese doses as high as 1,050 mg/kg/day (Laskey et al. 1982).

## 3. HEALTH EFFECTS

A slight decrease in pregnancy rate was observed in rats exposed to 3,500 mg manganese/kg/day (as manganese tetroxide) in the diet for 90–100 days prior to breeding (Laskey et al. 1982). Since both sexes were exposed, it is not possible to conclude whether the effect was in males, females, or both. However, this exposure regimen did not have significant effects on female reproductive parameters such as ovary weight, litter size, ovulations, or resorptions (Laskey et al. 1982).

Manganese was found to affect sperm formation and male reproductive performance in other intermediate-duration oral studies (Elbetieha et al. 2001; Joardar and Sharma 1990; Ponnappakkam et al. 2003a, 2003c). Joardar and Sharma (1990) administered manganese to mice, as potassium permanganate or manganese sulfate, at 23–198 mg/kg/day by gavage for 21 days. The treatment resulted in sperm head abnormalities, and the percentage of abnormal sperm was significantly elevated in all exposed mice as compared to controls. Increased incidences of testicular degeneration occurred in male Sprague-Dawley rats exposed for 63 days to doses  $\geq 137.2$  mg manganese/kg/day as manganese acetate, but not at 68.6 mg/kg/day (Ponnappakkam et al. 2003c). Impaired male fertility was observed in male mice exposed to manganese chloride in drinking water for 12 weeks before mating with unexposed females at a daily dose level of 309 mg manganese/kg/day, but not at doses  $\leq 154$  mg manganese/kg/day (Elbetieha et al. 2001). In the 309-mg/kg/day group, 17 pregnancies occurred in 28 mated females, compared with 26 pregnancies out of 28 females mated with controls. At lower dose levels in another study, decreased sperm motility and sperm counts were observed in male CD-1 mice after 43 days of exposure to manganese acetate at doses of 4.6 or 9.6 mg manganese/kg/day, but these doses did not impair the ability of these males to impregnate unexposed females (Ponnappakkam et al. 2003a).

In another intermediate feeding study, Jarvinen and Ahlström (1975) administered varying doses of manganese sulfate, from nutritionally deficient levels to excess amounts, to Sprague-Dawley female rats for 8 weeks prior to mating. The rats were continued on manganese diet (0.75, 4.5, 10, 29, 94, or 187 mg manganese/kg/day) until GD 21. The authors found no effect of manganese on maternal weight gain, implantation number, resorptions, or percentage of dead fetuses. The authors did observe that manganese doses of 94 mg manganese/kg/day and higher resulted in significant increases in liver manganese concentrations, whereas nonpregnant females had liver manganese concentrations that were unchanged, irrespective of dose. These data suggest that pregnancy allows the female to develop significant liver manganese stores, and it is possible these stores may be mobilized during gestation or at a future time. The authors also noted that pregnant rats had consistent liver iron concentrations, whereas nonpregnant rats developed a dose-dependent decrease in liver iron concentrations. Further, the highest dose in dams caused a significant increase in fetal manganese content.

## 3. HEALTH EFFECTS

Szakmáry et al. (1995) studied the reproductive effects of manganese chloride, administered by gavage to pregnant rabbits and rats at concentrations of 0, 11, 22, and 33 mg manganese/kg/day on GDs 6–20 in the rabbit and throughout gestation in the rat. Manganese did not result in any reproductive effect in the rabbit, but the highest manganese dose did cause an increase in postimplantation loss in the rat. In 13-week dietary studies, no gross or histopathological lesions or organ weight changes were observed in reproductive organs of rats fed up to 618 mg manganese/kg/day or mice fed 1,950 mg manganese/kg/day, but the reproductive function was not evaluated (NTP 1993).

More recent oral studies indicate that ingested manganese does not result in female reproductive toxicity when rat dams were exposed during pregnancy, but impaired female fertility was observed when female mice were exposed to manganese in drinking water for 12 weeks before mating with unexposed males. The first study involved a dose of 22 mg manganese/kg/day administered as manganese chloride by gavage to female rats on days 6–17 of gestation (Grant et al. 1997a). No treatment-related mortality, clinical signs, changes in food or water intake, or body weights were observed in the dams. In the second study (Pappas et al. 1997), manganese chloride was provided to pregnant rats in drinking water at doses up to 620 mg manganese/kg/day throughout gestation. The manganese did not adversely affect the health of the dams, litter size, or sex ratios of the pups. More extensive analyses of female reproductive organs were not performed. Similarly, Kontur and Fechter (1985) found no significant effect on litter size in female rats exposed to manganese chloride in drinking water except at concentrations so high (1,240 mg manganese/kg/day) that water intake by the dams was severely reduced. In contrast, Elbetieha et al. (2001) reported that decreased numbers of implantations and viable fetuses were observed in female Swiss mice exposed to manganese chloride in drinking water at a dose level of 277 mg manganese/kg/day for 12 weeks before mating with unexposed males.

In a 2-year NTP study, no adverse reproductive effects (lesions in reproductive organs) from manganese sulfate exposure were reported for rats at up to 232 mg manganese/kg/day or mice at up to 731 mg manganese/kg/day (NTP 1993).

The highest NOAEL values and all LOAEL values from each reliable study for reproductive effects in each species and duration category are recorded in Table 3-3 and plotted in Figure 3-3.

No studies were located regarding reproductive effects in humans or animals following oral exposure to MMT.

## 3. HEALTH EFFECTS

**3.2.2.6 Developmental Effects**

Very little information is available on the developmental effects of manganese in humans. The incidences of neurological disorders and the incidences of birth defects and stillbirths were elevated in a small population of people living on an island where there were rich manganese deposits (Kilburn 1987); however, the lack of exposure data, the small sample sizes, and the absence of a suitable control group preclude ascribing these effects to manganese. The route of exposure was assumed to be primarily oral, but inhalation exposure was not ruled out.

As discussed in Section 3.2.2.4, two studies have evaluated adverse neurological results in children exposed to increased manganese concentrations in both water and food. The first study (He et al. 1994), evaluated 92 children, aged 11–13, who drank water containing manganese at average levels of at least  $0.241 \pm 0.051$  mg/L for 3 years or more and who also ate foodstuffs (wheat flour) with excess manganese (due to the high concentration of the metal in sewage water used to irrigate/fertilize the fields). These children were compared to 92 children from a nearby village whose manganese concentration in water did not exceed  $0.040 \pm 0.012$  mg/L (controls). The children who consumed higher manganese concentrations performed more poorly on the WHO neurobehavioral core tests (the emotional status test was omitted) than the control children. Further, the blood and hair manganese concentrations of exposed children were significantly higher than those of the control population. The negative results on the tests were correlated with hair manganese concentration. Zhang et al. (1995) reported that the children with increased manganese exposure also performed more poorly in school (as measured by mastery of their native language, mathematics, and overall grade average), and their serum levels of serotonin, norepinephrine, dopamine, and acetylcholinesterase were significantly decreased compared to controls. In the second study, Wasserman et al. (2006) cross-sectionally evaluated intellectual function in 142 10-year old children in Bangladesh who had been consuming well water with an average concentration of 793  $\mu\text{g}$  manganese/L and 3  $\mu\text{g}$  arsenic/L. Intellectual function was assessed using Weschler's Intelligence Scale for Children, from which raw scores for verbal, performance, and full scale were calculated. After grouping children into four groups based on manganese concentrations in the wells (<200, 200–499, 500–999, and  $\geq 1,000$   $\mu\text{g}/\text{L}$ ), regression analyses indicated that children in the highest exposure group (with estimated daily intakes of 0.07 mg manganese/kg/day in drinking water) had statistically significantly lower verbal, performance, and full scale scores compared with children in the lowest exposure group.

## 3. HEALTH EFFECTS

In animals, classical developmental toxicity studies have not found distinct effects on fetal survival, gross fetal malformations, or skeletal or visceral malformations or alterations. For example, acute administration of manganese chloride by gavage to pregnant rats at a dose of 22 mg manganese/kg/day on GDs 6–17 resulted in no adverse fetal developmental effects, measured as weight gain, gross malformations, or skeletal malformations (Grant et al. 1997a). In another study, Szakmáry et al. (1995) studied the developmental toxicity of manganese in the rabbit and rat. The metal, as manganese chloride, was administered by gavage during the whole period of gestation in the rat, and during organogenesis (day 6–20) in the rabbit at concentrations of 0, 11, 22, and 33 mg/kg/day. In the rabbit, manganese treatments did not result in decreases in fetal weights, skeletal retardation, or extra ribs, or in an increase in fetuses afflicted with major anomalies. In the rat, the highest dose resulted in retardation of development of the skeleton and internal organs. In addition, manganese at the highest dose caused a significant increase in external malformations, such as clubfoot. However, when pups from dams treated at the same dose were allowed to grow for 100 days after birth, no external malformations were observed, indicating that these effects were self-corrected. No significant differences were found in any of the groups concerning the development of the ears, teeth, eyes, forward motion, clinging ability, body posture correction reflex, or negative geotaxis reflex.

Many developmental toxicity studies in animals orally exposed to excessive manganese have focused on possible effects on development of reproduction functions and neurological functions.

Several animal studies of the effects of manganese on reproductive development show developmental effects.

One study involved pre-weanling mice (Gray and Laskey 1980) that were fed 1,050 mg manganese/kg/day (as manganese tetroxide) beginning on PND 15. On days 58, 73, and 90, mice were sacrificed and reproductive organ (preputial gland, seminal vesicle, and testes) weights and body weights were measured. The manganese decreased the growth of these reproductive organs, but had no effect on body growth or liver or kidney weights.

In another study, Laskey et al. (1982) evaluated the effect of dietary manganese exposure on rats during gestation and continued during nursing and after weaning at doses of 0, 350, 1,050 or 3,500 mg manganese/kg/day. The manganese was given in combination with either 20 or 200 mg iron/kg/day (the former is deficient in iron, the latter is adequate). Manganese treatment was lethal at the highest dose in the iron-deficient diet, but had no effect on male or female body weight at any age in animals receiving an

## 3. HEALTH EFFECTS

iron-sufficient diet. In the iron-poor diet, body weights of males were significantly depressed ( $p < 0.05$ ) through day 100 of the study, whereas the females' body weights were depressed only through day 60. Select females and males were mated at day 90–100 of the study and the reproductive outcomes were analyzed. The manganese treatment did not have any significant adverse effects at any dose except to significantly decrease the number of pregnancies at the highest dose ( $p < 0.05$ ). Litter size, ovulations, resorptions, preimplantation deaths, and fetal weights were unaffected by the metal. Testes weights in males were significantly decreased from controls only when administered manganese in conjunction with an iron-poor diet: at day 40 at 1,050 and 3,500 mg manganese/kg/day and at day 100 at 1,050 mg/kg/day. Hormone levels in male rats were also evaluated. No effect was seen from manganese treatment in 40-day-old male rats. At 60–100 days of age, however, dose-related decreases in serum testosterone were observed, when age-related increases were expected and no increase in serum LH was observed. Manganese given in both iron regimens prevented the normal decrease in serum follicle-stimulating hormone (FSH) from 60 to 100 days. Manganese decreased epididymal sperm count only when given with the iron-poor diet as measured at 100 days.

A third study involved gavage administration of 0, 71, or 214 mg manganese/kg/day (as manganese tetroxide) to pre-weanling rats from birth to 21 days of age (Laskey et al. 1985). Functioning of the hypothalamus, pituitary, and testicular tissues were measured by assaying endogenous or stimulated serum concentrations of FSH, LH, and testosterone at days 21 or 28. No manganese-related effects were observed on unstimulated or stimulated FSH or LH serum levels. In addition, manganese did not affect endogenous or acute hCG-stimulated serum testosterone concentrations but did decrease serum testosterone level following chronic hCG stimulation. Liver and hypothalamic manganese concentrations were significantly increased in treated rats given the 71 mg/kg/day dose over controls. The authors hypothesized that the manganese had an unknown affect on the testicular Leydig cell that resulted in the delayed production of testosterone. This delayed production was presumably causing the delayed reproductive maturation seen in the earlier study (Gray and Laskey 1980), but was not enough to affect fertility outcomes at doses as high as 1,050 mg/kg/day (Laskey et al. 1982).

Many animal studies have examined neurological end points in animals repeatedly exposed during gestations and/or neonatal or juvenile stages of life. End points evaluated have included brain chemistry, neurobehaviors, and neuropathology.

Studies of manganese in Rhesus monkeys by Golub et al. (2005) were prompted by the observation that soy-based formulas provided to human infants contain relatively high levels of manganese and thus may



## 3. HEALTH EFFECTS

pose a potentially toxic hazard to early neurological development. Groups of eight male infant Rhesus monkeys were fed a commercial cow's milk based formula (Similac containing 50 µg manganese/L as control, providing 17.5 mg manganese/kg/day), a commercial soy protein based formula (soy containing 300 µg manganese/L, providing 107.5 mg manganese/kg/day), or the same soy formula with added manganese chloride for a final concentration of 1,000 µg manganese/L (soy plus manganese, providing 328 mg manganese/kg/day). Formulas were exclusively fed to infants starting on the day of birth and extending through 4 months of age, at which time monkeys were transitioned to standard laboratory diet. A behavioral test battery was administered over an 18-month period. The battery included measures of motor, cognitive, and social skills, as well as tests related to the dopamine system (reward delay, fixed interval dopamine drug response). Infants that did not generate sufficient data in each test to permit evaluation were excluded from data analyses. Growth and levels of the dopamine metabolite HVA and the serotonin metabolite 5-hydroxyindolacetic acid (5-HIAA) in CSF at 4, 10, and 12 months of age were also measured. No significant differences between groups were observed for body weights and levels of dopamine and serotonin metabolites in cerebrospinal fluid.

Monkeys fed soy supplemented with manganese were consistently more active during 12 weekly 7-minute observation periods, compared with control and soy monkeys. "Motor behaviors" were observed in seven of eight soy plus manganese monkeys, compared with three of eight in soy monkeys and three of eight in control monkeys. Assessment of gross motor maturation during these observation periods did not detect clear differences between the groups. Both soy and soy plus manganese groups showed some changes in activity/sleep patterns. Compared with controls at 4 months, the 4-month monkeys fed soy plus manganese showed 50% less activity ( $p < 0.05$ ) during the sleep portion of the sleep/wake cycle (this change was not seen at 8 months). At 8 months (but not at 4 months), both soy and soy plus manganese monkeys showed significantly ( $p < 0.05$ ) longer sleep periods and shorter longest time inactive during awake periods than controls. Social interactions were assessed during 16 sessions in which each monkey was paired with another monkey in the study. In these sessions, both soy and soy plus manganese monkeys demonstrated ~66% less time ( $p < 0.05$ ) in chase or rough play and more time in clinging activity compared with control monkeys.

Significant group differences were not consistently observed in more highly structured tests to assess cognitive functions including learning, memory, and attention than controls ( $p < 0.05$  for 328 mg manganese/kg/day and  $p < 0.01$  for 107.5 mg manganese/kg/day). For example, a response latency decrease was observed in a reward delay response task in the soy group by 50% compared to control, but no significant difference (although a 20% reduction) was observed in the soy plus manganese group. The

## 3. HEALTH EFFECTS

authors noted that more formal tests of cognitive functions would be most appropriately administered at more mature ages.

Other studies in neonatal animals have detected neurostructural and neurochemical changes at doses similar to or slightly above dietary levels (1–10 mg manganese/kg/day) (Chandra and Shukla 1978; Deskin et al. 1980), suggesting that young animals might be more susceptible to manganese than adults.

Kristensson et al. (1986) investigated the developmental effects of manganese chloride on 3-day-old male rat pups. The authors dosed the pups with 150 mg manganese/kg/day by gavage in water for 41 days. The pups developed a transient ataxia on days 15–22, which was resolved by the end of the dosing period. The exposed pups also had increased levels of manganese in the blood and the brain (7–40-fold increase in 15- and 20-day-old rats, with cortex and striatum concentrations being relatively equal). In 43-day-old rats, the increases in brain manganese levels were less than those observed in younger rats (i.e., approximately 3 times the control levels), but the striatal levels were higher than in the cortex. Manganese treatment decreased the concentration of homovanillic acid (metabolite of dopamine) in the striatum and the hypothalamus, but not in other brain regions. No other monoamines and metabolites were affected. In a similar study, neonatal rats given bolus doses of manganese chloride in water of 0.31 mg manganese/kg/day for 60 days suffered neuronal degeneration and increased brain monoamine oxidase on days 15 and 30 of the study, but did not show any clinical or behavioral signs of neurotoxicity (Chandra and Shukla 1978).

Deskin et al. (1980, 1981) also found changes in brain chemistry in rat pups dosed with manganese. In the first study, male rat pups were administered 0, 1, 10, or 20 mg manganese/kg/day (as manganese chloride) via gavage in 5% sucrose solution for 24 days postnatal. The authors observed that the two highest doses resulted in decreased dopamine levels in the hypothalamus, while the highest dose resulted in a significant decrease in brain tyrosine hydroxylase activity and a significant increase in monoamine oxidase activity in the hypothalamus. Hypothalamic norepinephrine was unaffected by any manganese dose, and no significant changes in neurochemistry were noted in the corpus striatum. The authors suggested that the observed effects were probably due to decreased activity of tyrosine hydroxylase and increased levels of monoamine oxidase.

The second study (Deskin et al. 1981) involved dosing male rat pups with 0, 10, 15 or 20 mg manganese/kg/day (as manganese chloride) via gavage in 5% sucrose solution, for 24 days starting at birth. The authors performed neurochemical analyses of hypothalamus and corpus striatum as before and

## 3. HEALTH EFFECTS

observed that serotonin was increased in the hypothalamus at the highest dose, but was not elevated significantly in the striatum. Acetylcholinesterase levels were significantly decreased in the striatum at the highest dose, but were unchanged in the hypothalamus. The authors believed that the decrease in acetylcholinesterase to be of minor functional significance given that other mechanisms can also regulate acetylcholine metabolism.

Lai et al. (1984) studied the effect of chronic dosing of 40 mg manganese/kg/day (as manganese tetroxide given in drinking water) to neonatal rats that were exposed from conception, throughout gestation, and up to 2 years of age. The authors found that manganese treatment led to small decreases in choline acetyltransferase activities in cerebellum and midbrain of 2-month-old rats. The regional distribution of glutamic acid decarboxylase or acetylcholinesterase was unchanged.

An intermediate drinking water study in pregnant rats (Pappas et al. 1997) investigated the developmental neurotoxicity of manganese chloride doses of either 120 or 620 mg manganese/kg/day given on GDs 1–21. Following birth, the dams were continued on manganese until weaning at PND 22. When the dams were removed, the pups were continued on the same manganese doses until PND 30. Male pups were observed on several days subsequent to exposure in a number of behavioral tests that measured spontaneous motor activity, memory, and cognitive ability. The manganese-treated rats' performance was not significantly different from control rats. Pups from the highest-dose group exhibited a significantly decreased weight gain on several days post-dosing, as well as an increased activity level on PND 17 that was no longer evident by PND 30. The high-dose rats were not overactive on other days, and the decreased weight gain was resolved by PND 90. Neurochemical analyses of the brains from treated pups indicated that brain manganese concentrations were significantly elevated in the high-dose group, as compared to controls. Brain enzyme and dopamine concentrations were not significantly different between groups, but cortical manganese concentrations were significantly elevated in the high-dose group. Cortical thickness was significantly different in several areas of the brains of pups in the high-dose group but was only found to be significantly different in one area of the low-dose group. The significance of the cortical thinning is not clear.

While the Szakmáry et al. (1995) and Pappas et al. (1997) studies did not observe any changes in behavior due to manganese, many other studies have explored the potential for oral manganese exposure during early development to produce effects on later behavior and have frequently observed subtle changes in behavior attributable to manganese exposure (Ali et al. 1983a; Kontur and Fechter 1988; Reichel et al. 2006; Tran et al. 2002a).

## 3. HEALTH EFFECTS

A study by Kontur and Fechter (1988) reported no difference in levels of monoamines and related metabolites in neonatal rats at 22 mg manganese/kg/day as manganese chloride (14–21 days), although Dorman et al. (2000) reported elevated striatal DA and DOPAC in 21-day-old rats administered the same high daily dose used by Kontur and Fechter (1988) from PND 1 to 21. Effect of manganese treatment on neurobehavior was also evaluated in this study. There was a significant decrease in body weight gain in pups at the highest manganese exposure dose. Although there were no statistically significant effects on motor activity or performance in the passive avoidance task in the neonates, manganese treatment induced a significant increase in amplitude of the acoustic startle reflex at PND 21. However, in adult rats, the amplitude of the acoustic startle reflex was significantly decreased compared to the control at the lowest dose tested.

Reichel et al. (2006) studied the effects of manganese in male Sprague-Dawley rats that were born and dosed daily with an oral dose of 0, 4.4 or 13.1 mg manganese/kg/day as manganese chloride on postpartum days 1–21. Locomotor activity was assessed (distance traveled horizontally; PNDs 10–14), as was olfactory orientation (PNDs 9–13), negative geotaxis (PNDs 8–12) and balance and coordination (PND 90). Day of eye opening, pinna detachment, and incisor eruptions was also evaluated. Mean body weights at PND 21 were decreased by about 2 and 3% in the low- and high-dose groups, respectively, compared with controls. Manganese concentrations in striatum were elevated in the high dose group, compared with control, at PND 14 (~4-fold) and PND 21 (~2-fold), but not at PND 90. Manganese levels were not measured in the low-dose group. No exposure-related effects were noted on developmental landmarks (eye opening, pinna detachment, incisor eruption), basal motor activity during the neonatal period (PNDs 10–14) and adulthood (PND 90), or olfactory discrimination of home cage bedding during the neonatal period. The only behavioral end point affected during the neonatal period was a significant ( $p < 0.05$ ) increase in mean latencies to rotate 180° on the inclined plane of a negative geotaxis task. At PND 90, dopamine transporter binding sites in the striatum were decreased by about 20 and 60% in the low- and high-dose groups, respectively; only the high-dose value was significantly different ( $p < 0.05$ ) from the control. At PND 90, the locomotor activating effects of 20 mg/kg cocaine were significantly ( $p < 0.05$ ) decreased in the neonatally exposed manganese high dose group, compared with controls. The results indicate that neonatal exposure of rats to excess manganese caused subtle behavioral effects (altered balance in the neonatal period and diminished locomotor response to cocaine in adulthood) and neurochemical effects in adulthood (decreased dopamine binding sites in the striatum).

## 3. HEALTH EFFECTS

In a study by Tran et al. (2002a), Sprague-Dawley PND 1 litters were culled to 10–12 pups per dam and then were supplemented from PNDs 1–20 with 0, 0.7, 3.8, or 7.5 mg manganese/kg/day as manganese chloride provided by mouth. Male and female pups were used. Righting test (PND 6), homing test (olfactory discrimination; PND 10), and passive avoidance (PND 32) were performed. Striatal dopamine levels were also determined after sacrifice on PND 40. Tissue analyses (on brain, liver, kidneys, spleen, and small intestine) for iron, copper, zinc, and manganese content were performed on animals sacrificed on PNDs 14, 21, and 40. Animals were not dosed after PND 20. The two highest dose groups of rats took approximately twice as long (2 seconds) as control and 0.7 mg manganese/kg/d (approximately 1 second) to right themselves; this result was not statistically significant. In the homing test of olfactory discrimination, the 7.5 mg manganese/kg/day group took significantly longer to reach their goal compared to controls and the 3.8 mg manganese/kg/day group (the 0.7 mg manganese/kg/day group performed similarly to the control). The control group required approximately 40 seconds; the high-dose group required 75 seconds (an 88% increase in the high-dose group over the control). In the passive avoidance task, there was a positive linear trend, with the highest dose group showing a 3-fold increase in the number of footshocks received over the control. The 3.8 mg manganese/kg/d group showed a 2-fold increase in the number of footshocks over the control. A negative linear relationship was also observed in striatal dopamine concentrations, with the high-dose group having approximately half the dopamine concentration of the control. No dose-related trends over time points were observed in manganese content of tissues. The highest dose group showed some statistically significant ( $p < 0.05$ ) increases in manganese in body tissues (brain, small intestine, kidney) at different time points. An increase ( $p < 0.05$ ) was observed in the high dose group for iron in the small intestine on PND 40. No changes were seen in copper or zinc tissue concentration. Both males and females were used in behavioral tests since ANOVAs showed no interactive effects of treatment or sex.

Ali et al. (1983a) conducted a gestational study investigating the neurological effects of excess manganese in drinking water on rats maintained on either a normal or low-protein diet. Manganese exposure originated 90 days prior to mating and continued throughout gestation and nursing. The offspring of rats who drank the equivalent of 240 mg manganese as manganese chloride/kg/day had pups with delayed air righting reflexes. No treatment-related effects were observed in body weight or brain weight in pups from dams fed the normal amount of protein. Significant delays in age of eye opening and development of auditory startle were observed only in the pups of dams fed protein-deficient diets. In a recent study, Dorman et al. (2000) evaluated the effects of oral manganese treatment in neonatal CD rats. Pups were administered manganese chloride in water at 11 or 22 mg manganese/kg for 21 days by mouth with a micropipette and were dosed starting after birth (PND 1) until weaning (PND 21). At PND 21, the

## 3. HEALTH EFFECTS

effect of manganese treatment on motor activity, learning and memory (passive avoidance task), evoked sensory response (acoustic startle reflex), brain neurochemistry, and brain pathology was evaluated. Manganese treatment at the highest dose was associated with decreased body weight gain in pups, although the authors indicated that absolute brain weight was not significantly altered. There were no statistically significant effects on motor activity or performance in the passive avoidance task. However, manganese treatment induced a significant increase in amplitude of the acoustic startle reflex. Significant increases in striatal DA and DOPAC concentrations were also observed in the high-dose treated neonates. No pathological lesions were observed in the treated pups. The authors indicated that these results suggest that neonatal rats are at greater risk than adults for manganese-induced neurotoxicity when compared under similar exposure conditions.

In a longer-duration intermediate study, Jarvinen and Ahlström (1975) fed female rats up to 187 mg manganese/kg/day (as manganese sulfate) for 8 weeks prior to conception. The rats were continued on manganese treatment until the 21st day of gestation. The unborn pups from dams administered 94 mg manganese/kg/day had significantly decreased weights as compared to the other groups. No gross malformations were observed in the fetuses, and alizarin-stained bone preparations revealed no abnormalities in any dose group. However, fetuses from dams fed the highest manganese dose had significantly higher concentrations of manganese in their bodies than fetuses from the other groups. These data indicate that a level of 187 mg manganese/kg/day overwhelmed the rat's homeostatic control of manganese and the metal accumulated in the fetus. The highest manganese dose also resulted in a significant decrease in the iron content of the fetuses.

Garcia et al. (2006, 2007) studied the relationship between dietary manganese and dietary iron on brain chemistry and neurotransmission. In one study, groups of 5–7 dams were fed diets containing 35 ppm iron (control) or 8 mg manganese/kg/day and 35 ppm iron (manganese-supplemented) from GD 7 through PND 7 (Garcia et al. 2006). On PND 4, pups born to control dams were pooled and randomly cross-fostered to dams fed one of the two diets such that initial mean litter weights were equivalent. Pups were exposed to each of these diets via maternal milk from PND 4 to 21 as well as via direct ingestion of chow (beginning around PND 11) and were euthanized on PND 21. In the dams, the high manganese diet induced changes in hematological parameters similar to those seen with iron-deficiency: 50% decrease in plasma iron (without significant decreases in hemoglobin) and increased plasma transferrin and total iron binding capacity. Compared with controls, manganese-exposed pups showed decreased hemoglobin (about 20%), decreased plasma levels of iron (about 70%), increased plasma transferrin and total iron binding capacity (about 10%), increased brain concentrations of manganese, chromium, and zinc,

### 3. HEALTH EFFECTS

decreased brain iron levels, increased protein expression of divalent metal transporter-1 (DMT-1) and transferrin receptor (TfR) in all brain regions, increased GABA concentrations, and increased ratios of GABA to glutamate concentrations. Because GABA is an inhibitory amino acid and glutamate is an excitatory amino acid, the authors suggested that the manganese treatment induced enhanced inhibitory transmission in the brain of the pups. The results indicate that manganese treatment altered transport and distribution of iron in developing rat pups and induced perturbations in brain levels of the neurotransmitter, GABA.

In a further study by Garcia et al. (2007), groups of 5–7 GD7 timed–pregnant Sprague-Dawley rats were fed one of three experimental diets: control (35 mg Fe/kg diet; 10 mg manganese/kg diet), low iron (3 mg Fe/kg diet; 10 mg manganese/kg diet), or low iron with supplemented manganese (3 mg Fe/kg diet, 100 mg manganese/kg diet). On PND 4, pups born to the control dams were pooled and randomly cross-fostered to dams fed one of the two iron-deficient diets, such that initial mean litter weights were approximately equivalent. The pups received these diets via maternal milk from PND 4 to 21, at which time the pups were sacrificed. Levels of essential metals in the brain were measured (in cerebellum, cortex, hippocampus, striatum, and midbrain) by inductively coupled plasma-mass spectrometry. Increases in brain levels in low iron/manganese-treated rats (compared to control and low iron) were seen for the following metals: copper, manganese (~50%), chromium (~150%), cobalt (~150%), molybdenum (~25%), zinc (~130%), aluminum (~130), and vanadium (~150%). A decrease in brain iron levels was observed for low iron animals; low iron/manganese-treated rats had iron levels significantly higher than the low iron animals.

No studies of developmental effects following oral exposure to MMT in humans or animals were located.

#### **3.2.2.7 Cancer**

No studies were located regarding carcinogenic effects in humans after oral exposure to inorganic manganese.

Chronic (2-year) feeding studies in rats and mice have yielded equivocal evidence for the carcinogenic potential of manganese. For example, rats exposed to up to 232 mg manganese/kg/day as manganese sulfate for 2 years showed no increases in tumor incidence (NTP 1993). Mice fed up to 731 mg manganese/kg/day as manganese sulfate for 2 years had a marginally increased incidence of thyroid gland follicular cell adenomas (high-dose animals) and a significantly increased incidence of follicular cell

### 3. HEALTH EFFECTS

hyperplasia (NTP 1993); this was considered by NTP to be "equivocal evidence of carcinogenic activity of Mn(II) sulfate monohydrate in male and female B6C3F<sub>1</sub> mice" (there was "no evidence of carcinogenic activity" in rats in this study).

No studies were located regarding carcinogenic effects in humans or animals following oral exposure to MMT.

#### 3.2.3 Dermal Exposure

For inorganic manganese compounds, dermal exposure is not a typical pathway of exposure because manganese does not penetrate the skin readily. For organic manganese, dermal exposure is a possibility with all compounds discussed in this profile. This exposure pathway is most likely, however, with MMT, where occupational workers (mechanics, workers in the gasoline industry, pesticide manufacturers and sprayers) are likely to handle large quantities of these compounds.

No studies were located regarding the any health effects in humans or animals after dermal exposure to inorganic manganese.

##### 3.2.3.1 Death

No studies were located regarding death in humans from dermal exposure to MMT.

Hinderer (1979) reported LD<sub>50</sub> values for rabbits (strain and sex were unreported) that were administered varying doses of "neat" commercial MMT on abraded skin in the trunk area for 24 hours. These values, generated by four different laboratories, ranged from 140 to 795 mg/kg. Although this dose range is wide, the author reported that it was analogous to the wide oral LD<sub>50</sub> range given for the compound in other reports.

##### 3.2.3.2 Systemic Effects

**Respiratory Effects.** No studies were located regarding respiratory effects in humans or animals following dermal exposure to MMT.

**Cardiovascular Effects.** No studies concerning cardiovascular effects following dermal exposure to MMT in humans or animals were located.



## 3. HEALTH EFFECTS

**Gastrointestinal Effects.** No studies were located regarding gastrointestinal effects in humans following dermal exposure to MMT. Hinderer (1979) observed bloody diarrhea in rabbits exposed dermally to MMT; the compound was obtained as commercial grade, “neat,” and applied to shaved skin for 24 hours. No histopathology was performed to ascertain the presence of lesions on the gastrointestinal tract.

**Hematological Effects.** No studies were located regarding hematological effects in humans or animals following dermal exposure to MMT.

**Musculoskeletal Effects.** No studies regarding musculoskeletal effects in humans or animals following dermal exposure to MMT were located.

**Hepatic Effects.** Hinderer (1979) observed that rabbits that underwent dermal application of a commercial “neat” solution of MMT for 24 hours on shaved skin had discoloration of the liver and swollen liver. No histopathology was performed.

**Renal Effects.** Hinderer (1979) observed that rabbits that underwent dermal application of a commercial “neat” solution of MMT for 24 hours on shaved skin had discoloration of the kidneys and swollen and congested kidneys. No histopathology was performed.

**Endocrine Effects.** No studies were located regarding endocrine effects in humans or animals following dermal exposure to MMT.

**Dermal Effects.** No studies were located regarding dermal effects in humans following dermal exposure to MMT. Hinderer (1979) observed that rabbits exposed dermally to commercial “neat” MMT on shaved skin for 24 hours developed edema and erythema. Further dermal irritation tests performed showed that MMT is a moderate skin irritant. Campbell et al. (1975) exposed male albino rats dermally to MMT for 24 hours on closely clipped dorsolateral aspects of the trunk that were either abraded or allowed to remain intact; skin reactions were evaluated and scored at 24 hours and again 48 hours later. By comparing skin reactions following exposure to a test rating that categorized irritancy levels, MMT was determined to be safe for intact or abraded skin contact. However, the authors note that MMT in concentrated form is absorbed through the skin, and dermal absorption or interactions with other materials or factors were not incorporated into their study.

### 3. HEALTH EFFECTS

**Ocular Effects.** No studies were located regarding ocular effects in humans or animals following dermal exposure to inorganic manganese.

Hinderer (1979) performed a standard Draize irritation test with commercial “neat” MMT in rabbits and found the compound not to be an eye irritant.

**Body Weight Effects.** No studies were located regarding body weight effects in humans or animals following dermal exposure to inorganic manganese.

Rabbits exposed dermally to commercial “neat” MMT exhibited slight body weight loss, although the actual amount was not reported (Hinderer 1979).

**Metabolic Effects.** No studies were located regarding metabolic effects in humans or animals following dermal exposure to inorganic manganese.

No studies were located regarding metabolic effects in humans or animals following dermal exposure to MMT.

#### 3.2.3.3 Immunological and Lymphoreticular Effects

No studies were located regarding immunological and lymphoreticular effects following dermal exposure to inorganic manganese in either humans or animals.

No studies regarding immunological and lymphoreticular effects following dermal exposure to MMT in humans or animals were located.

#### 3.2.3.4 Neurological Effects

No studies were located regarding neurological effects following dermal exposure to inorganic manganese in either humans or animals.

Rabbits exposed to “neat” commercial grade MMT on shaved areas of their trunks for 24 hours experienced the following reported symptoms: polypnea, vocalization, excitation, ataxia, tremors, cyanosis, and convulsions (Hinderer 1979).

## 3. HEALTH EFFECTS

**3.2.3.5 Reproductive Effects**

No studies were located regarding reproductive effects in humans or animals following dermal exposure to inorganic manganese.

No studies were located regarding reproductive effects in humans or animals following dermal exposure to organic manganese.

**3.2.3.6 Developmental Effects**

No studies were located regarding reproductive effects in humans or animals after dermal exposure to inorganic manganese.

No studies were located in humans or animals concerning developmental effects following dermal exposure to MMT.

**3.2.3.7 Cancer**

No studies were located regarding carcinogenic effects in humans or animals after dermal exposure to inorganic manganese.

No studies were located regarding carcinogenic effects in humans or animals after dermal exposure to MMT.

**3.2.4 Diagnostic Uses**

Manganese is a paramagnetic element that can contain up to five unpaired electrons in its ionic form. The unpaired electrons can facilitate T1 relaxation (in MRI) by interacting with hydrogen nuclei of water molecules (Earls and Bluemke 1999). This T1 relaxation provides a contrast in signal during MRI from normal cells and tumor cells because normal cells will take up the metal, whereas the cancerous cells take up little or no manganese (Toft et al. 1997a). The  $Mn^{2+}$  ion is the ion of choice because it is most readily found in the body. However, because increased amounts of other sources of  $Mn^{2+}$ , especially manganese chloride, were found to have a high acute toxicity (as discussed in the previous sections), it is necessary to chelate the  $Mn^{2+}$  ion with another molecule that might decrease the toxic nature of the free ion. One such

## 3. HEALTH EFFECTS

chelate is the fodipir molecule, or dipyridoxal diphosphate. The result is mangafodipir, Mn(II)-*N,N'*-dipyridoxylethylendiamino-*N,N'*-diacetate-5,5'-bis(phosphate), or manganese dipyridoxal diphosphate (MnDPDP). This clinical imaging agent is primarily used in the detection of hepatobiliary tumors, as it is preferentially taken up by parenchymatous cells. However, as other organs have parenchymatous cells, the compound is also useful in the detection of kidney, pancreas, and adrenal gland tumors (Earls and Bluemke 1999).

This section will discuss the adverse effects of administration of mangafodipir. This section will not discuss the efficacy of mangafodipir as a contrast agent in the identification of abdominal cancer. Because this compound is used primarily in the detection of liver and other parenchymatous tumors, it is found exclusively in hospitals and other clinical settings. It is only administered intravenously; therefore, all subsequent studies discussed entail an intravenous exposure route. Because the toxicity of mangafodipir is mediated by manganese, the doses will be in mg manganese/kg body weight, rather than in terms of the parent compound.

#### 3.2.4.1 Death

There are no reports of lethality in humans following administration of mangafodipir.

Administration of mangafodipir can occur either all at once (bolus) or over a specific timed period necessary to give the entire amount of a precalculated dose (slow infusion). The latter method has been found to be better tolerated in a clinical setting (Bernardino et al. 1992; Lim et al. 1991; Padovani et al. 1996).

Mangafodipir was found to cause lethality in both sexes of Swiss-Webster mice with an LD<sub>50</sub> of 2,916 mg manganese/kg after slow infusion of 15 seconds (Larsen and Grant 1997). The compound had an LD<sub>50</sub> of 103 mg/kg in both sexes of the same rodent when administered in a bolus dose (Larsen and Grant 1997), showing the increased toxicity in the bolus administration. When given as a slow infusion over 5 minutes in both sexes of the CD-1 mouse, the compound had an LD<sub>50</sub> value of 157 mg/kg, and when given at a rate of 1.2 mL/second in BOM:NMRI male mice, the LD<sub>50</sub> was 211 mg/kg. In another study, the LD<sub>50</sub> in both sexes of the Swiss-Webster mouse was found to be 290 mg/kg, when given as a slow infusion over approximately 2.5 minutes (Elizondo et al. 1991). One male and one female beagle dog given a single slow infusion (lasting ~110 seconds) of 160 mg/kg mangafodipir, as well as the one male given 120 mg/kg, died prior to the second day of the experiment; the remaining female given 120 mg/kg was

## 3. HEALTH EFFECTS

sacrificed due to a moribund condition on day 3 of the experiment (Larsen and Grant 1997). Dogs of both sexes given 83 or 99 mg/kg survived the 14-day observation period. A single slow infusion (lasting 5 minutes) at a dose of 160 mg/kg did not result in lethality in the Sprague-Dawley rat (Larsen and Grant 1997).

Death was not observed in Sprague-Dawley rats administered nine doses of 16 mg manganese/kg/day (as mangafodipir) given over 3 weeks (Elizondo et al. 1991; Larsen and Grant 1997). Moribund condition prompted the sacrifice of one male and one female beagle dog on days 12 and 21, respectively, of a 21-day exposure period in which the animals were administered 5.4 mg/kg/day manganese (as mangafodipir), whereas a lower dose of 1.6 mg/kg/day did not result in death or sacrifice of any treated dogs (Larsen and Grant 1997). Moribund condition also prompted the sacrifice of a single male Cynomolgus monkey on day 18 of a mangafodipir-dosing regimen involving 16 mg manganese/kg/day doses also given 3 times/week for 3 weeks (Larsen and Grant 1997). The authors did not indicate the precise cause of lethality in the sacrificed dogs; however, they noted the dogs' livers showed histological signs of cholangiohepatitis, fibroplasia, bile duct proliferation, and hepatocyte necrosis, with cortical tubular necrosis in the kidneys. The sacrificed monkey had a serum chemistry profile indicative of renal failure and associated liver toxicity.

#### 3.2.4.2 Systemic Effects

**Respiratory Effects.** No reports were located concerning respiratory effects in humans following dosing with mangafodipir.

A single dose of 160 mg manganese/kg as mangafodipir in Sprague-Dawley rats of both sexes resulted in dyspnea (Larsen and Grant 1997).

**Cardiovascular Effects.** Mangafodipir, when administered to humans in timed doses in clinical studies has resulted in transient facial flushing and increased blood pressure at doses as low as 0.2 mg manganese/kg (facial flushing) (Bernardino et al. 1992; Lim et al. 1991; Padovani et al. 1996; Wang et al. 1997).

Slow infusion of mangafodipir at doses of 16.5 mg manganese/kg resulted in no cardiotoxicity in mongrel dogs of either sex (Karlsson et al. 1997). The dogs suffered from medically-induced acute ischaemic heart failure; cardiotoxicity was measured as the depression of cardiovascular function, with specific

## 3. HEALTH EFFECTS

measured end points being aortic pressure, pulmonary artery pressure, right atrial pressure, cardiac output, and heart rate (Karlsson et al. 1997). Sprague-Dawley rats suffered no cardiotoxicity (as measured by histomorphological evaluation) after a single administration of mangafodipir at doses as high as 63 mg/kg (Larsen and Grant 1997).

Rats administered nine doses (3 times/week for 3 weeks) of 16 mg manganese/kg did not suffer any adverse cardiovascular effects as measured by histomorphological analyses (Larsen and Grant 1997). Twenty-one days of daily administration of 5.4 mg manganese/kg in beagle dogs resulted in reduced heart rate by the end of the treatment (Larsen and Grant 1997). Cynomolgus monkeys administered 16 mg/kg for 3 days/week for 3 weeks resulted in flushing of the face, but no other measured cardiovascular effects (Larsen and Grant 1997).

**Gastrointestinal Effects.** Incidences of gastrointestinal effects in humans following injection with mangafodipir have been limited to rare complaints of nausea or vomiting that are short-lived (15 seconds to 5 minutes in length) and not dose- or administration rate-dependent (bolus vs. infusion) (Bernardino et al. 1992; Lim et al. 1991; Padovani et al. 1996; Wang et al. 1997). A dose of 81 mg manganese/kg as mangafodipir in beagle dogs of both sexes resulted in vomiting, diarrhea, and decreased food consumption (Larsen and Grant 1997).

Vomiting was observed in Cynomolgus monkeys of both sexes after administration of nine doses of 16 mg manganese/kg, given 3 times/week for 3 weeks (Larsen and Grant 1997). No other gastrointestinal effects in animals were reported.

**Hematological Effects.** No hematological changes (versus pretreatment values) were noted in three different studies that included 13 healthy males (Wang et al. 1997), 54 healthy males (Lim et al. 1991), or 96 human volunteers of both sexes with known or suspected focal liver tumors (Bernardino et al. 1992) administered up to 1.4 mg manganese/kg as mangafodipir (either via bolus or slow infusion).

A single dose of 63 mg manganese/kg as mangafodipir in both sexes of Sprague-Dawley rats resulted in no adverse hematological effects (Larsen and Grant 1997). Intermediate studies of adverse effects were also negative. Doses as high as 16 mg/kg given 3 times/week for 3 weeks to Sprague-Dawley rats (Elizondo et al. 1991; Larsen and Grant 1997) or Cynomolgus monkeys, or 5.4 mg/kg in beagle dogs dosed daily for 21 days, failed to induce any adverse hematological effects (Larsen and Grant 1997).

## 3. HEALTH EFFECTS

**Musculoskeletal Effects.** No reports of musculoskeletal effects in humans or animals following mangafodipir administration were located.

**Hepatic Effects.** Blood chemistry analyses revealed no significant changes in liver enzymes in several volunteers, either with or without tumors, given mangafodipir at doses up to 1.4 mg manganese/kg (Bernardino et al. 1992; Lim et al. 1991; Wang et al. 1997). Three individuals dosed with 0.55 mg manganese/kg and one dosed with 1.4 mg/kg had increased serum alanine aminotransferase; however, there was no dose response with these results and the maximum increase in the enzyme was to 70 International Units (IU)/l (the upper limit of the normal range is 45 IU/l) (Lim et al. 1991).

A single dose of up to 63 mg manganese/kg administered to both sexes of Sprague-Dawley rats did not produce any adverse hepatic effects as observed by histomorphological analyses (Larsen and Grant 1997). The administration of nine total doses of mangafodipir, three per week, at 16 mg manganese/kg/day per dose, resulted in an increased incidence (relative amount unreported) in hepatic microgranulomas in female Sprague-Dawley rats, but no effect on liver enzymes as measured by serum chemistry (Elizondo et al. 1991; Larsen and Grant 1997). Twenty-one daily doses of 1.6 mg/kg/day resulted in an increase in serum enzymes (alanine aminotransferase, ornithine carbamyl transferase, glutamine dehydrogenase, alkaline phosphatase, gamma-glutamyl transferase), as well as bilirubin and cholesterol, in both sexes of beagle dogs, while a higher dose of 5.5 mg/kg/day resulted in increased liver enzymes and liver weight and changes in liver pathology (cholangiohepatitis, fibroplasia, bile duct proliferation, and hepatocyte necrosis) (Larsen and Grant 1997). The authors noted that altered serum albumin:globulin ratios and increased prothrombin time were indicative of decreased liver protein synthesis. When dogs at this high dose were allowed a 4-week recovery period, healing of the liver was observed; specific measures of healing were not provided, although resolution of lesions in other affected organs, such as the kidneys, was mentioned. The authors also noted that increased serum levels of liver enzymes and decreased liver protein synthesis were reversible effects in dogs allowed a recovery period. Doses of 0.54 mg/kg/day did not have any effect on the liver (Larsen and Grant 1997). In both sexes of the Cynomolgus monkey, nine total doses of 16 mg/kg/day given 3 times/week for 3 weeks, resulted in increases in liver enzymes (alanine aminotransferase, gamma-glutamyl transferase), as well as increases in bilirubin and relative liver weights in males, and focal hepatitis/cholangiolitis in one male at the end of the dosing period. When the monkeys were given a 2-week recovery period following a 3-week administration of the highest dose, only one male had a liver lesion, which was in the process of healing. Doses of 1.6 mg/kg/day in this primate did not cause any adverse hepatic effects (Larsen and Grant 1997).

## 3. HEALTH EFFECTS

**Renal Effects.** Administration of mangafodipir at up to 1.4 mg manganese/kg in a few human studies has not resulted in any adverse renal effects as measured by blood chemistry or urinalysis (Bernardino et al. 1992; Wang et al. 1997).

Single doses of mangafodipir up to 63 mg manganese/kg given to Sprague-Dawley rats did not cause renal effects as measured by blood chemistry, urinalysis, gross necropsy, and histopathology (Larsen and Grant 1997). Sprague-Dawley rats of both sexes given nine doses (thrice weekly for 3 weeks) of 16 mg/kg manganese did not show any adverse renal effects as measured by urinalysis, blood chemistry, and histomorphological analysis (Elizondo et al. 1991; Larsen and Grant 1997). Daily administration of mangafodipir over 21 days in both sexes of the beagle dog at concentrations up to 6 mg/kg resulted in cortical tubular necrosis of the kidneys at this highest dose, as well as decreased glomerular filtration rate, as indicated by high serum carbamide and creatinine levels. There were no measurable effects at  $\leq 1.6$  mg/kg (Larsen and Grant 1997). Administration of nine doses of mangafodipir, also given thrice weekly for 3 weeks, at individual concentrations of 16 mg manganese/kg to Cynomolgus monkeys of both sexes resulted in increased kidney weights and enzymes, as well as creatinine, urea, and other inorganic ions. Doses of 1.6 mg/kg over the same time period did not result in any adverse effect (Larsen and Grant 1997).

**Endocrine Effects.** No studies were located regarding endocrine effects in humans or animals following administration of mangafodipir.

**Dermal Effects.** No studies were located regarding dermal effects in humans or animals following intravenous administration of mangafodipir.

**Ocular Effects.** No studies were located concerning ocular effects in humans following administration of mangafodipir.

Cynomolgus monkeys administered nine individual doses at 16 mg/kg over 3 weeks and beagle dogs given up to 6 mg/kg daily for 21 days did not have any adverse ocular effects from the mangafodipir treatment (Larsen and Grant 1997).

**Body Weight Effects.** No reports were located concerning body weight effects in humans following mangafodipir dosing.



### 3. HEALTH EFFECTS

Mice given acute doses of mangafodipir as high as 275 mg manganese/kg and rats administered a dose of 160 mg/kg did not suffer any body weight effects (Larsen and Grant 1997).

Rats (Elizondo et al. 1991; Larsen and Grant 1997) and monkeys (Larsen and Grant 1997) administered nine doses of mangafodipir over 3 weeks at doses as high as 16 mg manganese/kg did not have any treatment-related effects on body weight. Dogs administered 21 daily doses of the compound suffered decreased body weight (unspecified decrease) at 5.4 mg/kg, but no effect at 1.6 mg/kg (Larsen and Grant 1997). There were no significant treatment-related adverse effects on body weight of male and female rats or female rabbits used in reproductive studies with mangafodipir (Blazak et al. 1996; Grant et al. 1997a; Treinen et al. 1995), except for a transient decrease in body weight during weeks 2–5, 9, and 10 in male rats administered 6 mg manganese/kg/day for 85 days (Grant et al. 1997a). The authors noted that the decrease was significant when compared to controls, but did not report actual data.

**Metabolic Effects.** No studies were located regarding metabolic effects in humans or animals following administration of mangafodipir.

#### 3.2.4.3 Immunological and Lymphoreticular Effects

No studies were located regarding immunological or lymphoreticular effects in humans following exposure to mangafodipir.

Injection of mangafodipir 3 times/week for 3 weeks in Sprague Dawley rats at doses of 1.6, 6.3, or 16 mg manganese/kg resulted in eosinophilia in females only at the highest dose, but had no effect in males. The authors stated they are unsure of the clinical importance of this effect as it was only seen at repeated high doses (Larsen and Grant 1997). Daily dosing of mangafodipir in beagle dogs of both sexes at doses of 1.6 mg manganese/kg for 21 days resulted in a decrease in eosinophils and an increase in toxic neutrophils (absolute amounts not reported) (Larsen and Grant 1997). A lower dose of 0.54 mg/kg had no immunological effect.

#### 3.2.4.4 Neurological Effects

No statistically significant increases in adverse neurological effects in humans following mangafodipir administration were reported. In one study, four subjects given doses ranging from a low of 0.17 mg/kg to a high of 1.4 mg/kg complained of light-headedness or dizziness (Lim et al. 1991). Five of 96 patients administered mangafodipir complained of a headache following dosing; only two of these five, given

## 3. HEALTH EFFECTS

varying doses of mangafodipir ranging from 0.17 to 1.4 mg manganese/kg, could be attributed to the contrast agent (Bernardino et al. 1992). No other neurological effects were reported in human studies.

Single doses of mangafodipir ranging from 8.3 to 275 mg manganese/kg in mice and a single dose of 160 mg/kg in rats, resulted in decreased activity and abnormal gait and stance (Larsen and Grant 1997). Mongrel dogs infused once with mangafodipir at doses of 0.55, 3.3, or 16.5 mg manganese/kg did not have any treatment-related changes in plasma catecholamines or physiological signs of sympathetic activation as compared to the undosed controls (Karlsson et al. 1997). In a separate study, beagle dogs receiving either single doses ranging from 83 to 160 mg/kg or 21 daily doses at 5.4 mg manganese/kg suffered decreased appetite as measured by decreased food consumption; when the dogs were allowed a recovery period following the repeated dosing, the food consumption normalized within the first 2–3 days (Larsen and Grant 1997).

Rats and monkeys administered nine doses of up to 16 mg/kg each did not have any observable neurotoxic effects (Larsen and Grant 1997).

Grant et al. (1997a) did observe behavioral changes in the pups of Sprague-Dawley dams exposed to 0, 0.6, 1.1, or 2.2 mg manganese/kg on GDs 6–17. Although no significant effects were observed at the lowest dose, the exposed pups suffered a significant decrease in grasp/holding time and a 10–11% decrease in body weight at PNDs 4 and 7 at the 1.1 mg/kg dose. At the highest dose, pup weight was significantly decreased at PNDs 4, 7, 14, and 21; performance on grasp/holding, negative geotaxis, and surface righting tests was also significantly impaired. In addition, postnatal survival was decreased on days 0–4 (56 vs. 95.9% in the control group) and 4–21 (78.9 vs. 100% in the control group) at the highest dose (Grant et al. 1997a).

Current studies do not provide evidence on the potential for neurotoxicity following clinical exposure to mangafodipir. In general, studies on neurological effects in humans or animals following mangafodipir exposure did not involve a long observation period. Because deposition of manganese in the brain can be significantly delayed following exposure, it is possible that the studies to date were terminated prior to the onset of potential neurotoxicity. However, neurotoxicity in humans or animals has not been reported following single exposures to manganese, even at high doses. Studies on toxicokinetics of other manganese compounds also indicate that a single exposure is not likely to result in significant neurological effects. For further information on distribution, refer to Section 3.4 Toxicokinetics.

## 3. HEALTH EFFECTS

**3.2.4.5 Reproductive Effects**

No studies were located regarding reproductive effects in humans following administration of mangafodipir.

A single dose of 160 mg/kg in male Sprague-Dawley rats resulted in no adverse effects in testes as measured by organ weight and histomorphological analysis (Larsen and Grant 1997).

Male Sprague-Dawley rats dosed nine times in 3 weeks with 16 mg manganese/kg as mangafodipir suffered a decrease in absolute testes weights, but no relative decrease in weight and no histomorphological effects (Larsen and Grant 1997).

Injection of pregnant Sprague-Dawley rats with up to 4.4 mg manganese/kg as mangafodipir, on GDs 6–8, 9–11, 12–14, or 15–17 (all during organogenesis) resulted in no evidence of reproductive toxicity as measured by pregnancy rate, numbers of corpora lutea, implantations or resorptions (Treinen et al. 1995). Further, daily intravenous administration of doses up to 2.2 mg manganese/kg throughout GDs 6–17 did not result in any significant changes in pregnancy rate, corpora lutea, implantations, or resorptions (Treinen et al. 1995). However, Grant et al. (1997a) observed a >50% rate of post-implantation loss in pregnant Sprague-Dawley rats administered 2.2 mg manganese/kg as mangafodipir during GDs 6–17. Doses of 0.6 and 1.1 mg/kg resulted in postimplantation loss rates that were similar to that of the control group. There were no obvious differences in compound administration or animal husbandry between the two studies that would indicate why such disparate results would occur. Intravenous dosing of New Zealand white rabbits with up to 1.1 mg manganese/kg/day on GDs 6–17 did not cause reproductive toxicity in one study (Grant et al. 1997a), but a dose of 3.3 mg manganese/kg/day during GDs 6–18 in the same species resulted in a significant increase (3-fold) in post-implantation loss (Blazak et al. 1996). This latter dose corresponds to a 12-fold increase over the one-time human clinical dose (Earls and Bluemke 1999).

Mangafodipir dosing in female Sprague-Dawley rats for 22 total days, starting prior to conception and ending on the 7<sup>th</sup> day of gestation at a dose of up to 6 mg manganese/kg, did not result in any adverse reproductive effects (Grant et al. 1997a).

Male Sprague-Dawley rats dosed for 84–85 days with 0, 0.6, 2, or 6 mg manganese/kg as mangafodipir did not show any signs of reproductive toxicity as measured by histomorphological analyses. Although

## 3. HEALTH EFFECTS

absolute testes weights in the intermediate dose group were reduced compared to controls, relative weights were not, and in the absence of histopathological findings, this reduction is not considered an adverse effect. The treated rats were bred with females to determine if mangafodipir dosing had any effect on fertility. Pregnancy rates, and the number of corpora lutea, implantations, or resorptions were unaffected by parental treatment (Grant et al. 1997a).

**3.2.4.6 Developmental Effects**

No studies were located regarding developmental effects in humans following intravenous exposure to mangafodipir.

Treinen et al. (1995) tested the sensitivity of different gestational periods to the administration of mangafodipir in Sprague-Dawley rats. Pregnant rats were dosed with 0, 1.1, 2.2, or 4.4 mg manganese/kg on 3 consecutive days: GDs 6–8, 9–11, 12–14, or 15–17. The 1.1 mg/kg dose given on days 15–17 resulted in a significant increase in skeletal malformations in fetuses (10/113 fetuses vs. 0/106 in the control group;  $p < 0.05$ ). A higher dose of 2.2 mg/kg also caused a significant increase in malformations when given on GDs 12–14 (10 out of 104 fetuses affected) and days 15–17 (21/143) (both  $p < 0.05$ ), and the 4.4 mg/kg dose caused increases in malformations when given on days 9–11 (5/83), 12–14 (45/128), and 15–17 (98/129) (all  $p < 0.05$ ). The malformations seen in this study included angulated or irregularly shaped clavicle, femur, fibula, humerus, ilium, radius, tibia, ulna, and/or scapula (Treinen et al. 1995).

The offspring of Sprague-Dawley rats dosed with 0, 0.1, 0.3, or 1 mg manganese/kg as mangafodipir daily throughout GDs 6–17 had a significant increase ( $p < 0.05$ ) in abnormal limb flexures (38/270 fetuses affected) and skeletal malformations (141/270 fetuses affected) only at the highest dose (Treinen et al. 1995). These malformations included the same ones listed for the segmented teratology study above. In a separate experiment evaluating the teratology of mangafodipir administration on GDs 6–17 in pregnant Sprague-Dawley rats, Treinen et al. (1995) observed a significant increase ( $p < 0.05$ ) in skeletal malformations in offspring of rats dosed with 2.2 mg manganese/kg (86/92 fetuses affected) compared to controls. In both the segmented and continuous teratology studies, no maternal toxicity was observed.

Fetuses from Sprague-Dawley females dosed with 0, 0.6, 1.1, or 2.2 mg manganese/kg on GDs 6–17 exhibited a statistically significant increase in wavy ribs at 0.6 mg/kg (20.5% of the viable fetuses impacted vs. 0.7% at the control dose;  $p < 0.05$ ). At the intermediate dose, there was a statistically significant increase in the number of fetuses with abnormalities (20 out of 159 viable fetuses) including

## 3. HEALTH EFFECTS

distortion or misshaping of one or more of the following bones: humerus, radius, ulna, scapula, clavicle, femur, tibia, and fibula; in addition, 56.6% of the viable fetuses had wavy ribs and the fetuses weighed 14% less than controls ( $p < 0.05$ ). At 2.2 mg/kg, there was a significant decrease in fetal viability (56% decrease;  $p < 0.05$ ), a greater increase in fetuses with abnormalities (45 out of 64 viable fetuses,) and a greater percentage (85.9%) with wavy ribs (Grant et al. 1997a). These effects were observed in the absence of maternal toxicity. By contrast, when the mangafodipir was administered for 22 days prior to conception and up to GD 7 in the same species at doses of 0, 0.6, 2, and 6 mg manganese/kg/day, no adverse effects on the number of viable fetuses, fetal weight, or the number of fetuses with abnormalities were reported (Grant et al. 1997a). These teratogenic studies indicate that developmental toxicity resulting from mangafodipir dosing is highly dependent on the time-frame of administration.

Grant et al. (1997a) also observed behavioral changes in the offspring of Sprague-Dawley dams administered 0, 0.6, 1.1, or 2.2 mg manganese/kg on GDs 6–17. The exposed pups suffered a significant decrease in grasp/holding time and a 10–11% decrease in body weight at PNDs 4 and 7 at the 1.1 mg/kg dose, but no significant effects at the lower dose (Grant et al. 1997a). At the highest dose, pup weight was significantly decreased at PNDs 4, 7, 14, and 21, and performance on grasp/holding, negative geotaxis, and surface righting tests was significantly impaired. In addition, postnatal survival was decreased on days 0–4 (56 vs. 95.9% in the control group) and 4–21 (78.9 vs. 100% in the control group) at the highest dose (Grant et al. 1997a). These effects occurred at doses that did not cause observable maternal toxicity.

Mangafodipir administration in New Zealand white rabbits at doses of 0, 0.3, 0.55, or 1.1 mg manganese/kg on GDs 6–18 resulted in incomplete ossification of the sternbrae at 1.1 mg/kg in one study (Grant et al. 1997a), but no significant effects on fetotoxicity or fetal weight; this dose did not result in any maternal toxicity. In a separate study, mangafodipir at doses as high as 3.3 mg manganese/kg in the same strain of rabbit for the same period of exposure did not result in any significant increases in external, skeletal, or visceral malformations in a separate teratology study (Blazak et al. 1996). This dose did result in an 11% decrease in fetal weight (although this value was not statistically significant in the study, it is considered a significant developmental effect) and a 20% decrease in the number of viable fetuses (also not statistically significant). It is not readily apparent why two studies with similar dosing regimens would obtain such conflicting results. A comparison between rat and rabbit gestational studies indicates that the rabbit is a much less sensitive model for reproductive and developmental toxicity induced by mangafodipir.

## 3. HEALTH EFFECTS

**3.3 GENOTOXICITY**

There is some evidence from a study on occupationally exposed welders that manganese may cause chromosomal aberrations; the welders were exposed to other potentially toxic compounds including nickel (known to cause chromosomal aberrations) and iron; therefore, the observed increase in chromosomal aberrations cannot be attributed solely to manganese (Elias et al. 1989). Mutagenicity studies in both bacteria and mammalian strains are equivocal. While manganese sulfate was shown to not be mutagenic to *Salmonella typhimurium* strains TA97, TA98, TA100, TA1535, or TA1537 either in the presence or absence of S9 from Aroclor 1254-induced liver from rats or Syrian hamsters (Mortelmans et al. 1986), it was shown to be mutagenic to strain TA97 elsewhere (Pagano and Zeiger 1992). In yeast (*Saccharomyces cerevisiae* strain D7), a fungal gene conversion/reverse mutation assay indicated that manganese sulfate was mutagenic (Singh 1984). Manganese chloride was reportedly not mutagenic in *S. typhimurium* strains TA98, TA100, and TA1535, but it was mutagenic in strain TA1537, and conflicting results were obtained for TA102 (De Méo et al. 1991; Wong 1988).

*In vitro* assays in mammalian cells also gave conflicting results concerning manganese mutagenicity. Manganese chloride produced gene mutations in cultured mouse lymphoma cells (Oberly et al. 1982). Manganese chloride caused DNA damage *in vitro* using human lymphocytes at a concentration of 25  $\mu\text{m}$  without metabolic activation, but not at the lower tested concentrations of 15 and 20  $\mu\text{m}$  (Lima et al. 2008). The compound also caused DNA damage in human lymphocytes using the single-cell gel assay technique in the absence of metabolic activation, but caused no DNA damage when S9 was present (De Méo et al. 1991). Manganese sulfate induced sister chromatic exchange in Chinese hamster ovary (CHO) cells in both the presence and absence of S9 from Aroclor 1254-induced rat liver (Galloway et al. 1987). In a separate assay, manganese sulfate also induced chromosomal aberrations in CHO cells in the absence of S9 but not in its presence (Galloway et al. 1987). Manganese chloride caused chromosome aberrations in human lymphocytes without metabolic activation, but only when treated in the G2 phase of the cell cycle; treatment in the G1, G1/S, and S1 phases of the cell cycle did not result in chromosome aberrations (Lima et al. 2008). The compound was also found to be clastogenic in root tip cells of *Vicia faba* (Glass 1955, 1956), but not in cultured FM3A cells in the absence of metabolic activation (Umeda and Nishimura 1979). Potassium permanganate caused chromosomal aberrations in FM3A cells (Umeda and Nishimura 1979), but not in a primary culture of cells from Syrian hamster embryos when tested in the absence of metabolic activation (Tsuda and Kato 1977). Manganese chloride caused cell transformation in Syrian hamster embryo cells (Casto et al. 1979). A list of *in vitro* study results is given in Table 3-5.

## 3. HEALTH EFFECTS

**Table 3-5. Genotoxicity of Manganese *In Vitro***

| Species (test system)                                     | Compound                             | End point  | Strain                            | Results         |                    | Reference                |
|---|--------------------------------------|--|-----------------------------------|-----------------|--------------------|--------------------------|
|   |                                      |  |                                   | With activation | Without activation |                          |
| Inorganic manganese compounds                             |                                      |  |                                   |                 |                    |                          |
| Prokaryotic organisms:                                    |                                      |  |                                   |                 |                    |                          |
| <i>Salmonella typhimurium</i> (plate incorporation assay) | MnCl <sub>2</sub>                    | Gene mutation  | TA98 TA 102                       | –               | –                  | Wong 1988                |
|   |                                      |  | TA1535                            | –               | –                  |                          |
|   |                                      |  | TA1537                            | –               | –                  |                          |
|   |                                      |  |                                   | –               | +                  |                          |
|   | MnSO <sub>4</sub>                    | Gene mutation  | TA98, TA100, TA1535, TA1537, TA97 | –               | –                  | Mortelmans et al. 1986   |
| <i>S. typhimurium</i> (preincubation assay)               | MnSO <sub>4</sub>                    | Gene mutation  | TA97                              | No data         | +                  | Pagano and Zeiger 1992   |
|   | MnCl <sub>2</sub>                    | Gene mutation  | TA102                             | No data         | +                  | DeMéo et al. 1991        |
|   |                                      |  | TA100                             | No data         | –                  |                          |
|   | MnCl <sub>2</sub>                    | Gene mutation  | TA102                             | No data         | +                  | DeMéo et al. 1991        |
|   |                                      |  | TA100                             | No data         | –                  | DeMéo et al. 1991        |
| <i>Photobacterium fischeri</i> (bioluminescence test)     | MnCl <sub>2</sub>                    | Gene mutation (restored luminescence)  | Pf-13 (dark mutant)               | No data         | +                  | Ulitzur and Barak 1988   |
| <i>Escherichia coli</i>                                   | MnCl <sub>2</sub>                    | Gene mutation  | KMBL 3835                         | No data         | +                  | Zakour and Glickman 1984 |
| Bacteriophage ( <i>E. coli</i> lysis)                     | MnSO <sub>4</sub>                    | Gene mutation  | T4                                | No data         | +                  | Orgel and Orgel 1965     |
| <i>Bacillus subtilis</i> (recombination assay)            | MnCl <sub>2</sub>                    | Inhibition of growth in recombination deficient mutant (Rec <sup>-</sup> ) compared to wild type (Rec <sup>+</sup> ) | M45 (Rec <sup>-</sup> )           | No data         | +                  | Nishioka 1975            |
|   | Mn(NO <sub>3</sub> ) <sub>2</sub>    |  |                                   | +               | +                  |                          |
|   | MnSO <sub>4</sub>                    |  |                                   |                 | +                  |                          |
|   | Mn(CH <sub>3</sub> COO) <sub>2</sub> |  |                                   |                 | –                  |                          |
| <i>B. subtilis</i> (recombination assay)                  | MnCl <sub>2</sub>                    | Inhibition of growth in recombination deficient mutant (Rec <sup>-</sup> ) compared to wild type (Rec <sup>+</sup> ) | M45 (Rec <sup>-</sup> )           | No data         | –                  | Kanematsu et al. 1980    |
|   | Mn(NO <sub>3</sub> ) <sub>2</sub>    |  |                                   |                 | –                  |                          |
|   | Mn(CH <sub>3</sub> COO) <sub>2</sub> |  |                                   | –               |                    |                          |

## 3. HEALTH EFFECTS

**Table 3-5. Genotoxicity of Manganese *In Vitro***

| Species (test system)                     | Compound          | End point   | Strain  | Results         |                    | Reference             |
|---|-------------------|---|---|-----------------|--------------------|-----------------------|
|   |                   |   |   | With activation | Without activation |                       |
| Eukaryotic organisms:                     |                   |   |   |                 |                    |                       |
| Fungi:                                    |                   |   |   |                 |                    |                       |
| <i>Saccharomyces cerevisiae</i>           | MnSO <sub>4</sub> | Gene conversion, reverse mutation                 | D7  | No data         | +                  | Singh 1984            |
| Mammalian cells:                          |                   |   |   |                 |                    |                       |
| Mouse lymphoma cells                      | MnCl <sub>2</sub> | Gene mutation                                     | L5178Y TK+/-  | No data         | +                  | Oberly et al. 1982    |
| Syrian hamster embryo cells               | MnCl <sub>2</sub> | Enhancement of SA7 transformation                 |   | No data         | +                  | Casto et al. 1979     |
| Human lymphocytes (Single-cell gel assay) | MnCl <sub>2</sub> | DNA damage  | lymphocyte  | -               | +                  | DeMéo et al. 1991     |
| Chinese hamster ovary cells               | MnSO <sub>4</sub> | Chromosomal aberrations/sister chromatid exchange |   | +               | +                  | NTP 1993              |
| Human lymphocytes                         | MnCl <sub>2</sub> | Chromosomal aberrations (G2 phase)                |   | No data         | +                  | Lima et al. 2008      |
| Human lymphocytes                         | MnCl <sub>2</sub> | DNA damage  |   | No data         | +                  | Lima et al. 2008      |
| Organic manganese compounds               |                   |   |   |                 |                    |                       |
| Prokaryotic organisms:                    |                   |   |   |                 |                    |                       |
| <i>E. coli</i> and <i>S. typhimurium</i>  | MnDPDP            | Gene mutation                                     | <i>E. coli</i> : WP <sub>2</sub> uvrA <sup>-</sup><br><i>S. typhimurium</i> : TA100, TA1535, TA98, TA1537 | -               | -                  | Larsen and Grant 1997 |
| Eukaryotic organisms:                     |                   |   |   |                 |                    |                       |
| CHO cells                                 | MnDPDP            | Forward mutation                                  |   | -               | -                  | Larsen and Grant 1997 |
|   | MnDPDP            | Chromosomal aberration                            |   | -               | -                  | Larsen and Grant 1997 |

- = negative result; + = positive result; ± = weakly positive result; CHO = Chinese hamster ovary; DNA = deoxyribonucleic acid; Mn(CH<sub>3</sub>COO)<sub>2</sub> = manganese acetate; MnCl<sub>2</sub> = manganese chloride; MnDPDP = mangafodipir; Mn(NO<sub>3</sub>)<sub>2</sub> = manganese nitrate; MnSO<sub>4</sub> = manganese sulfate; Rec = recombination



## 3. HEALTH EFFECTS

Manganese chloride did not produce somatic mutations in *Drosophila melanogaster* fruit flies in one study (Rasmuson 1985), and manganese sulfate did not induce sex-linked recessive lethal mutations in germ cells of male *D. melanogaster* (Valencia et al. 1985).

*In vivo* assays in mice showed that oral doses of manganese sulfate or potassium permanganate caused micronuclei and chromosomal aberrations in bone marrow (Joardar and Sharma 1990). In contrast, oral doses of manganese chloride did not cause chromosomal aberrations in the bone marrow or spermatogonia of rats (Dikshith and Chandra 1978). A list of *in vivo* study results is given in Table 3-6.

The results of *in vitro* studies show that at least some chemical forms of manganese have mutagenic potential. However, as the results of *in vivo* studies in mammals are inconsistent, no overall conclusion can be made about the possible genotoxic hazard to humans from exposure to manganese compounds.

Genotoxicity data concerning MMT was not available.

One study was located regarding genotoxic effects in humans following inhalation exposure to manganese. In this study, the incidences of chromosomal aberrations in three groups of welders with occupational exposures (10–24 years) to metals including manganese, nickel, and chromium were examined (Elias et al. 1989). An increase in chromosomal aberrations was found in the group working with the metal active gas welding process; however, since their exposures included nickel as well as manganese, the authors could not attribute the results to any one metal exposure (nickel is known to cause chromosomal aberrations by the inhalation route). The median manganese concentrations during the survey were 0.18 mg/m<sup>3</sup> for respirable dust and 0.71 mg/m<sup>3</sup> for total dust. No information was available regarding the genotoxicity of manganese alone.

No studies were located regarding genotoxic effects in humans after oral exposure to inorganic manganese.

In male Swiss albino mice, manganese sulfate and potassium permanganate have both been found to be clastogenic, and their effects were found to be dependent primarily on the concentration (not duration) of exposure (Joardar and Sharma 1990). In this *in vivo* study, oral doses were administered at varying levels over a 3-week period. The manganese sulfate doses were 10.25, 20.25, and 61 mg/100 g body weight, and the potassium permanganate doses were 6.5, 13, and 38 mg/100 g body weight. Sperm head

## 3. HEALTH EFFECTS

**Table 3-6. Genotoxicity of Manganese *In Vivo***

| Species (test system)                                 | Compound          | End point                   | Route             | Results | Reference                 |
|---|-------------------|-----------------------------|-------------------|---------|---------------------------|
| Inorganic manganese compounds                         |                   |                             |                   |         |                           |
| Nonmammalian systems:                                 |                   |                             |                   |         |                           |
| <i>Drosophila melanogaster</i>                        | MnSO <sub>4</sub> | Sex-linked recessive lethal | Feeding injection | -       | Valencia et al. 1985      |
| <i>D.melanogaster</i>                                 | MnCl <sub>2</sub> | Somatic mutation            | Soaking larvae    | -       | Rasmuson 1985             |
| Mammalian systems:                                    |                   |                             |                   |         |                           |
| Albino rat (bone marrow cells) (spermatogonial cells) | MnCl <sub>2</sub> | Chromosomal aberrations     | Oral              | -       | Dikshith and Chandra 1978 |
| Albino mouse  | MnSO <sub>4</sub> | Chromosomal aberrations     | Oral              | +       | Joardar and Sharma 1990   |
| Albino mouse  | KMnO <sub>4</sub> | Chromosomal aberrations     | Oral              | +       | Joardar and Sharma 1990   |

- = negative result; + = positive result; KMnO<sub>4</sub> = potassium permanganate; MnCl<sub>2</sub> = manganese chloride; MnSO<sub>4</sub> = manganese sulfate

### 3. HEALTH EFFECTS

abnormalities and the frequency of chromosomal aberrations in bone marrow cells and micronuclei were significantly increased. In male rats, repeated oral doses of 0.014 mg manganese/kg/day (as manganese chloride) for 180 days did not produce any significant chromosomal damage in either bone marrow or spermatogonial cells (Dikshith and Chandra 1978).

No studies were located regarding genotoxic effects in animals after inhalation exposure to inorganic manganese.

No studies were located concerning genotoxic effects in humans or animals following inhalation or exposure to MMT.

#### 3.4 TOXICOKINETICS

Manganese is required by the body and is found in virtually all diets. As discussed in Chapter 6, adults consume between 0.7 and 10.9 mg of manganese per day in the diet, with higher intakes for vegetarians who may consume a larger proportion of manganese-rich nuts, grains, and legumes than non-vegetarians (WHO 2004b). Manganese intake from drinking water is substantially lower than intake from food. Exposure to manganese from air is considered negligible as compared to intake from diet, although persons in certain occupations may be exposed to much higher levels than the general public (see Section 6.7).

Even though daily dietary intake of manganese can vary substantially, adult humans generally maintain stable tissue levels of manganese through the regulation of gastrointestinal absorption and hepatobiliary excretion (Andersen et al. 1999; Aschner and Aschner 2005; Aschner et al. 2005; Roth 2006). Following inhalation exposure, manganese can be transported into olfactory or trigeminal presynaptic nerve endings in the nasal mucosa with subsequent delivery to the brain, across pulmonary epithelial linings into blood or lymph fluids, or across gastrointestinal epithelial linings into blood after mucociliary elevator clearance from the respiratory tract (Aschner and Dorman 2006; Dorman et al. 2006a; Roth 2006). Manganese is found in the brain and all other mammalian tissues, with some tissues showing higher accumulations of manganese than others. For example, liver, pancreas, and kidney usually have higher manganese concentrations than other tissues (Dorman et al. 2006a). The principal route of elimination of manganese from the body is fecal elimination via hepatobiliary excretion; contributions from pancreatic, urinary, and lactational elimination are expected to be small (Dorman et al. 2006a). Excess manganese is expected to be eliminated from the body rapidly. For example, following the intravenous bolus injection of

## 3. HEALTH EFFECTS

manganese chloride in rats, manganese concentrations in plasma return to normal levels within 12 hours (Zheng et al. 2000).

### 3.4.1 Absorption

#### 3.4.1.1 Inhalation Exposure

No studies were located regarding the absolute amount of manganese that is absorbed by humans or animals after inhalation exposure to manganese dusts.

In general, the extent of inhalation absorption is a function of particle size, because size determines the extent and location of particle deposition in the respiratory tract. Manganese from smaller particles that are deposited in the lower airway is mainly absorbed into blood and lymph fluids, while manganese from larger particles or nanosized particles deposited in the nasal mucosa may be directly transported to the brain via olfactory or trigeminal nerves. Alternatively, particles deposited in the upper or lower respiratory tract may be moved by mucociliary transport to the throat, where they are swallowed and enter the stomach. The latter process is thought to account for clearance of a significant fraction of manganese-containing particles initially deposited in the lung. Thus, manganese may be absorbed in the nasal mucosa, in the lung, and in the gastrointestinal tract following inhalation of manganese dust. However, the relative amounts absorbed from each site are not accurately known.

Absorption of manganese deposited in the lung is expected to be higher for soluble forms of manganese compared with relatively insoluble forms of manganese (Aschner et al. 2005). Evidence in support of this hypothesis comes from studies in which 3-month-old male Sprague-Dawley rats were given intratracheal doses (1.22 mg manganese/kg) of relatively soluble (manganese chloride) or insoluble (manganese dioxide) forms of manganese (Roels et al. 1997). Peak concentrations of manganese in blood were observed earlier after manganese chloride intratracheal administration (0.5 hour) compared with manganese dioxide (168 hours after administration). Peak concentration of manganese in blood were about 4-fold higher in rats exposed to manganese chloride than in rats exposed to manganese dioxide (Roels et al. 1997). Confirmatory evidence has been presented by Dorman et al. (2001a, 2004b). For example, rats exposed to manganese sulfate (0.1 mg manganese/m<sup>3</sup>, 6 hours/day, 5 days/week for 13 weeks) showed higher olfactory bulb and striatum manganese concentrations than rats exposed to 0.1 mg manganese/m<sup>3</sup> manganese phosphate (hureaulite) (Dorman et al. 2004b).

## 3. HEALTH EFFECTS

Results consistent with nasal uptake of manganese and transport to the brain along neuronal tracts have been obtained in several animal studies (Brenneman et al. 2000; Dorman et al. 2001a, 2002a; Elder et al. 2006; Fechter et al. 2002; Henriksson et al. 1999; Lewis et al. 2005; Normandin et al. 2004; Tjälve and Henriksson 1999; Tjälve et al. 1996; Vitarella et al. 2000). For example, following intranasal administration of 4 µg/kg <sup>54</sup>Mn (as manganese chloride) to weanling Sprague-Dawley rats, whole-body autoradiography showed that the olfactory bulb contained the vast majority of measured manganese at 1, 3, and 7 days post-dosing (90, 69, and 47%, respectively) with values decreasing to a low of 16% at 12 weeks (Tjälve et al. 1996). Significant uptake of manganese by other brain regions was not observed until the third day, when the basal forebrain, cerebral cortex, hypothalamus, and striatum had 21, 2, 3, and 1% of the measured label, respectively (Tjälve et al. 1996). Subsequent experiments with varying doses of manganese chloride showed that the uptake of manganese into the olfactory epithelium and the transfer to the brain olfactory bulb leveled off at the highest doses, indicating that these are saturable processes (Henriksson et al. 1999). Following single, 90-minute, nose-only inhalation exposures of 8-week old male CD rats to aerosols of manganese chloride (0.54 mg <sup>54</sup>Mn/m<sup>3</sup>; Brenneman et al. 2000) or manganese phosphate (0.39 mg <sup>54</sup>Mn/m<sup>3</sup>; Dorman et al. 2002a), peak concentrations of radioactivity in the brain olfactory bulb (at 1–3 days after exposure) were about 20- or 4-fold higher, respectively, than peak concentrations in the striatum at 21 days after exposure. Results consistent with transport of manganese to the brain along olfactory neurons have also been obtained in rats exposed to manganese phosphate aerosols in inhalation chambers (0, 0.03, 0.3, or 3 mg manganese/m<sup>3</sup>) 6 hours/day for up to 14 days (Vitarella et al. 2000). Elevated concentrations of manganese were observed in the olfactory bulb, striatum, and cerebellum at the 0.3 and 3 mg manganese/m<sup>3</sup> exposure levels, compared with control levels, and concentrations in the olfactory bulb were about 1.4–2.4-fold higher than concentrations in the striatum (Vitarella et al. 2000). Elevated manganese concentrations were also found in the olfactory bulb, striatum, and cerebellum, following 90 days of inhalation chamber exposure (6 hours/day, 5 days/week) of young (6 weeks old at start) male or female CD rats or aged (16 months old at start) male CD to aerosols of either manganese sulfate or manganese phosphate (“hureaulite”) at an exposure concentration of 0.1 mg manganese/m<sup>3</sup> (Dorman et al. 2004b). Regardless of age or gender, the olfactory bulb showed the highest elevation in manganese concentration, compared with other brain tissues, and concentrations in the olfactory bulb were higher in rats exposed to soluble manganese than in rats exposed to relatively insoluble manganese phosphate (Dorman et al. 2004a). Following 12 days of inhalation exposure of rats to ultrafine manganese oxide particles (30 nm diameter; about 0.5 mg manganese dioxide/m<sup>3</sup>), Elder et al. (2006) reported that manganese concentrations in the olfactory bulb were increased by 3.5-fold over controls, compared with 2-fold increased concentrations in lungs. Lung lavage analysis showed no signs of pulmonary inflammation following 11 days of exposure, but several markers of inflammation were

## 3. HEALTH EFFECTS

noted in the olfactory bulb including increase tumor necrosis factor- $\alpha$  mRNA and protein. Elder (1996) argued that these results are consistent with the direct transport of the nanosized particles from the nasal mucosa via the olfactory neuronal tract to the olfactory bulb, noting that when the right nares were occluded, manganese only accumulated in the left olfactory bulb.

Elevated concentrations of manganese have also been observed in the trigeminal ganglia of rats and mice at 0, 7, and 14 days following nose-only inhalation exposure to aerosols of manganese chloride at a concentration of about 2 mg manganese/m<sup>3</sup>, 6 hours/day, 5 days/week for 2 weeks (Lewis et al. 2005). The latter results are consistent with uptake of manganese in the nasal respiratory epithelium and subsequent transport to the brain via trigeminal neurons. In Rhesus monkeys exposed to 1.5 mg manganese/m<sup>3</sup> manganese sulfate for 65 days, olfactory epithelium, olfactory bulb, and trigeminal nerve manganese concentrations were increased by about 17-, 8-, and 2-fold over concentrations in air control monkeys (Dorman et al. 2006a). These results are consistent with the hypothesis that the nasal olfactory transport route may be more important than the trigeminal neuron transport route in nonhuman primates. The relative importance of the nasal route of manganese absorption (and delivery to the brain) in humans has not been quantified, but it may be less important in humans than in rats because the olfactory bulb accounts for a larger part of the central nervous system and the olfactory epithelium accounts for a larger proportion of the nasal mucosa in rats compared with humans (Aschner et al. 2005; Dorman et al. 2002a). Using a pharmacokinetic model describing the olfactory transport and blood delivery manganese in rats, Leavens et al. (2007) calculated that 21 days or 8 days following acute inhalation exposure of rats to <sup>54</sup>MnCl<sub>2</sub> or <sup>54</sup>MnHPO<sub>4</sub>, respectively direct olfactory transport accounted for the majority of label in the olfactory bulb, but only a small percentage ( $\leq 3\%$ ) of the label in the striatum.

Absorption of manganese deposited in the lung or nasal mucosa of rats is expected to be influenced by iron status, with enhanced absorption under iron-deficient conditions and diminished absorption under iron-excess conditions. Following intratracheal administration of <sup>54</sup>Mn-manganese chloride, <sup>54</sup>Mn blood concentrations were lower in male Sprague-Dawley rats fed a high-iron diet (about 10,000 ppm Fe), compared with concentrations in rats fed a control iron (210 ppm Fe) diet (Thompson et al. 2006). These results are consistent with diminished pulmonary absorption of manganese under iron-loaded conditions. Supporting this interpretation, 4 hours after <sup>54</sup>Mn administration, levels of <sup>54</sup>Mn (expressed as a percentage of the instilled dose) were higher in the lungs of high-iron rats, compared with control rats, but generally lower in other tissues in high-iron versus control rats (Thompson et al. 2006). In rats fed the high-iron diet, mRNA levels for divalent metal transporter 1 (DMT1—a transport protein that facilitates membrane transport of divalent iron and manganese) were decreased in the bronchus-associated

## 3. HEALTH EFFECTS

lymphatic tissue of high-iron rats, compared with control rats (Thompson et al. 2006). In Belgrade rats, homozygous (b/b) for a mutation in DMT1 that impairs transport function and fed 500 ppm Fe in the diet,  $^{54}\text{Mn}$  blood levels following intranasal administrations of  $^{54}\text{Mn}$ -manganese chloride were markedly (2–5-fold) lower than those in blood of anemic heterozygous (+/b) rats fed a 20 ppm Fe diet (Thompson et al. 2007). For example, levels of  $^{54}\text{Mn}$  remaining in the blood 4 hours after administration were 0.022 and 0.115% of the instilled dose in the homozygous (b/b) and anemic heterozygous (+/b) rats, respectively (a 5-fold difference). Intermediate levels of  $^{54}\text{Mn}$  in blood were found in heterozygous (+/b) rats fed the 500 ppm Fe diet (Thompson et al. 2007). In Sprague-Dawley rats, levels of DMT1 protein in the olfactory epithelium were 1.5- to 2.5-fold greater under anemic conditions (20 ppm Fe in diet for 3 weeks), compared with iron-sufficient conditions, 200 ppm Fe in diet for 3 weeks (Thompson et al. 2007). These results are consistent with the hypothesis that up- and down-regulation of DMT1 plays a role in enhanced nasal absorption of manganese under iron-deficient conditions and diminished absorption under iron-excess conditions, respectively.

No studies were located regarding the absorption of organic manganese compounds following inhalation exposure in either humans or animals.

#### 3.4.1.2 Oral Exposure

The amount of manganese absorbed across the gastrointestinal tract in humans is variable, but typically averages about 3–5% (Davidsson et al. 1988, 1989a; Mena et al. 1969). Data were not located on the relative absorption fraction for different manganese compounds, but there does not appear to be a marked difference between retention of manganese ingested in food (5% at day 10) or water (2.9% at day 10) (Davidsson et al. 1988, 1989a; Ruoff 1995). In humans, manganese absorption tends to be greater from manganese chloride (in demineralized water) than from foods (labeled intrinsically or extrinsically with  $^{54}\text{Mn}$ ); however, the biological half-life of manganese from either manganese chloride or food is the same (EPA 1995b; Johnson et al. 1991). In human adults, supplementation of the diet with manganese sulfate for 12–35 weeks at a level approximately 2 times the normal dietary intake caused a 30–50% decrease in absorption of a tracer dose of  $^{54}\text{MnCl}_2$  (Sandstrom et al. 1990).

Results from animal studies indicate that the gastrointestinal absorption of manganese is rapid and expected to be higher for soluble forms of manganese compared with relatively insoluble forms of manganese. Following a single gavage dose of 6 mg manganese/kg as manganese chloride to rats, maximal plasma concentrations were attained rapidly ( $T_{\text{max}}=15$  minutes) (Zheng et al. 2000). From

## 3. HEALTH EFFECTS

analysis of time course of plasma concentrations following oral and intravenous administration, the oral bioavailability for manganese was calculated to be 13.9% (Zheng et al. 2000). Roels et al. (1997) noted that in 3-month-old male rats, gavage administered manganese chloride (24.3 mg manganese/kg) reached a maximal level in blood, 7.05 µg/100 mL, within the first 30 minutes post-dosing (first time point measured), whereas manganese from manganese dioxide, administered in the same fashion, did not reach a maximal level in blood of 900 ng/100 mL until 144 hours (6 days) post-dosing. Following four weekly gavage doses of manganese chloride at 24.3 mg manganese/kg per dose, significant increases in manganese concentration were observed in blood and the cerebral cortex, but not cerebellum or striatum, as compared to controls; for identical doses of manganese dioxide, manganese levels were significantly increased only in blood. The lack of significant increase in manganese levels in any brain region following administration of the dioxide is likely due to the delayed uptake of manganese in the blood.

One study showed that, in full-term infants, manganese is absorbed from breast milk and cow's milk formulas that were either unsupplemented or supplemented with iron, copper, zinc, and iodine (Dorner et al. 1989). Manganese intake was greater in the formula-fed infants than in the breast-fed infants due to the higher manganese content of the formula. However, breast-fed infants retained more of their daily intake of manganese (40%) than did the formula-fed infants (20%). It must be noted that the full-term infants evaluated in this study were 2–18 weeks old, and the data did not stratify intake and retention amounts by age. Further, the data did not indicate if there were similar proportions of manganese taken up from breast milk as compared to the formulas. A study by Davidson and Lönnerdal (1989) demonstrated the *in vitro* receptor-mediated uptake of manganese from lactoferrin; the authors speculated that this may lead to the absorption of manganese from breast milk in human infants.

There is some evidence to suggest that gastrointestinal absorption of manganese is age-dependent. Dorner et al. (1989) have shown that infants, especially premature infants, retain a higher proportion of manganese than adults. Animal studies also support this finding. For example, Rehnberg et al. (1980, 1981, 1982) dosed 1-day-old rat pups with up to 214 mg manganese/kg/day (as manganese tetroxide) for up to 224 days, then measured manganese concentrations in tissues. The authors noted that intermediate and chronic exposure of rats to manganese tetroxide in water or food resulted in much larger increases in tissue levels in young rats (1–15 days in intermediate studies, 24–40 days in chronic study) than in older rats. These increases in neonates were judged to be due to the neonates' greater absorption of manganese as a result of a slower rate of transport through the gut (Rehnberg et al. 1985). Similar results have been reported in rats exposed to manganese chloride (Kostial et al. 1978). However, such age-dependent differences in tissue retention of manganese could also be due to differences in excretory ability (Cotzias



## 3. HEALTH EFFECTS

et al. 1976; Miller et al. 1975) or to age-related changes in dietary intake levels of iron and manganese (Ballatori et al. 1987). Dorner et al. (1989) found that both pre-term and full-term infants had active excretion of manganese; in fact, some infants had negative manganese balances. Animal studies show that absorption and/or retention of manganese is higher in neonates, but returns to the level of older animals at approximately post-GD 17–18 (Kostial et al. 1978; Lönnerdal et al. 1987; Miller et al. 1975; Rehnberg et al. 1981). Available studies (Dorner et al. 1989) do not provide adequate data to determine when this transition takes place in human infants.

One of the key determinants of absorption appears to be dietary iron intake, with low iron levels leading to increased manganese absorption. Mena et al. (1969) administered oral  $^{54}\text{Mn}$  and  $^{39}\text{Fe}$  to subjects with iron-deficiency anemia (ranging in age from 13 to 44 years old) and measured manganese and iron uptake with whole-body autoradiography. The uptake of manganese by anemic subjects was 7.5% while in non-anemic subjects, it was 3.0%. This is probably because both iron and manganese are absorbed by the same transport system in the gut. The activity of this system is inversely regulated by dietary iron and manganese intake levels (Chandra and Tandon 1973; Diez-Ewald et al. 1968; Rehnberg et al. 1982; Thomson et al. 1971). Interaction between iron and manganese occurs only between nonheme iron and manganese. Davis et al. (1992a) demonstrated that increasing dietary intakes of nonheme iron, but not heme iron, depressed biomarkers of manganese status (i.e., serum manganese concentrations and lymphocyte manganese-dependent superoxide dismutase activity).

Studies of oral absorption of manganese in animals have yielded results that are generally similar to those in humans. Manganese uptake in pigs, which have similar gastrointestinal tracts to humans, has been measured using labeled manganese administered orally (Finley et al. 1997). The mean absorption rates for different times post-dosing were 5% 1–6 hours post-dosing, 7% 6–12 hours post-dosing, and 3.8% 12–24 hours post-dosing. Gastrointestinal uptake of manganese chloride in rats has been estimated to be 2.5–8.2% (Davis et al. 1993; Pollack et al. 1965). Uptake is increased by iron deficiency (Pollack et al. 1965) and decreased by preexposure to high dietary levels of manganese (Abrams et al. 1976a; Davis et al. 1992b). In a rat study, the intestinal transfer of the calcium ion and manganese ion was found to be competitive, and the authors suggested that there is a common mechanism for their transfer in the intestines (Dupuis et al. 1992). High dietary intakes of phosphorus (Wedekind et al. 1991) and calcium (Wilgus and Patton 1939) have also been demonstrated to depress manganese uptake in chicks.

## 3. HEALTH EFFECTS

Manganese absorption has also been found to vary according to manganese intake; in rats with manganese-deficient diets, absorption was at least 2-fold higher than in rats whose diets contained an adequate amount of manganese (as manganese carbonate) (Davis et al. 1992b).

Two studies in suckling rat pups found differing absorptions of manganese from different milks and formulas. The first study (Lönnerdal et al. 1987) found that the percent of  $^{54}\text{Mn}$  (added to the food source as an extrinsic label) retained (measured as whole-body retention) in 14-day-old pups fed breast milk, cow milk, cow milk formula, and soy formula, was 82, 90, 77, and 65%, respectively.

The latter study (Lönnerdal et al. 1994) found that 13-day-old rat pups fed  $^{54}\text{Mn}$  (from manganese chloride that was incubated with the food for at least 24 hours prior to feeding) in breast milk, cow milk, and several different manufacturers' cow milk formulas had similar absorption values. These pups absorbed (measured as whole-body retention) 80% of the label from breast milk, 83% from cow milk, and 63–90% from the cow milk formulas, with the two lowest retention values being significantly lower than the others. In this latter study, manganese absorption from soy formulas was significantly lower than the other milks and formulas tested, ranging from 63 to 72%.

The inherent concentration of manganese in each of these food sources from the first study was 0.01, 0.04, 0.05, and 0.30  $\mu\text{g}/\text{mL}$ , respectively (Lönnerdal et al. 1987). Therefore, when the retention of the label was multiplied by the actual manganese concentration of the food, the total amounts of absorbed manganese were 0.004, 0.018, 0.019, and 0.097  $\mu\text{g}/\text{dose}$  fed, respectively. These data indicate that infants fed cow milk formula may retain 5 times more manganese, and infants fed soy formula may retain 25 times more manganese than breast-fed infants. Although the latter results differ significantly from those observed earlier, the researchers report that the similar relative values for manganese absorption were indicative of significant efforts made to optimize both the relative concentrations and the bioavailability of minerals and trace elements in the manufactured formulas.

No studies were located regarding absorption of manganese following oral exposure to MMT in humans. Several studies (Hanzlik et al. 1980a, 1980b; Hinderer 1979; Hysell et al. 1974; Komura and Sakamoto 1992a, 1992b) indicate that absorption is occurring because toxicity is observed following MMT exposure; however, no absorption rates or relative amounts were provided in these studies. The plasma temporal pattern of manganese following oral administration of MMT has been studied in male Sprague-Dawley rats (Zheng et al. 2000). Following oral gavage of 20 mg MMT/kg, manganese appears in the plasma with a  $C_{\text{max}}$  between 2 and 12 hours after dosing. When nearly equivalent oral doses of MMT

### 3. HEALTH EFFECTS

(5.6 mg manganese/kg) or manganese chloride (6 mg manganese/kg) were administered, the  $C_{\max}$  (0.93 mg manganese/mL) following oral MMT was about 3-fold higher than that following oral manganese chloride (0.30 mg manganese/mL) (Zheng et al. 2000).

#### 3.4.1.3 Dermal Exposure

The only available human study regarding dermal exposure to manganese discussed a case report of a man burned with a hot acid solution containing 6% manganese. The authors speculated that manganese absorption had occurred across the burn area (Laitung and Mercer 1983) because the man had slightly elevated urinary manganese levels (11–14 vs. 1–8 mg/L). In most cases, manganese uptake across intact skin would be expected to be extremely limited.

No studies were located regarding absorption of organic manganese in humans or animals following dermal exposure.

#### 3.4.2 Distribution

Manganese is a normal component of human and animal tissues and fluids. In humans, most tissue concentrations range between 0.1 and 1  $\mu\text{g}$  manganese/g wet weight (Sumino et al. 1975; Tipton and Cook 1963), with the highest levels in the liver, pancreas, and kidney and the lowest levels in bone and fat (see Table 3-7). Manganese levels in the blood, urine, and serum of healthy, unexposed subjects living in the Lombardy region of northern Italy were  $8.8 \pm 0.2$ ,  $1.02 \pm 0.05$ , and  $0.6 \pm 0.014$   $\mu\text{g}/\text{L}$ , respectively (Minoia et al. 1990). Serum manganese concentrations in healthy males and females in Wisconsin were 1.06 and 0.86  $\mu\text{g}/\text{L}$ , respectively (Davis and Greger 1992; Greger et al. 1990). Although precise inhalation exposure data were not available for humans, chronic occupational exposure studies have shown that higher levels of inhalation exposure generally correspond with higher blood or urine manganese levels for groups, but that individual measurements may not correspond to individual exposure or be reliable exposure predictors (Abdel-Hamid et al. 1990; Alessio et al. 1989; Jarvisalo et al. 1992; Roels et al. 1992; Siqueira et al. 1991).

Studies investigating manganese levels in human fetal tissues or fluids are very few. Widdowson et al. (1972) measured manganese in fetal livers from 29 unborn infants (ranging in gestational age from 20 to 41 weeks) and from 5 adults. The fetal manganese levels ranged from 0.09 to 0.23 mg/100 g wet weight with a mean of 0.14 mg/100g wet weight, while the mean of the five adults was 0.18 mg/100 g wet weight (range of values not reported). The highest fetal manganese value of 0.23 mg/100 g wet weight

## 3. HEALTH EFFECTS

**Table 3-7. Manganese Levels in Human and Animal Tissues**

| Tissue     | Tissue concentrations ( $\mu\text{g}$ manganese/g wet weight) |                      |                        |                        |
|------------|---|----------------------|------------------------|------------------------|
|            | Humans  |                      | Rats                   | Rabbits                |
|            | Tipton and Cook (1963)  | Sumino et al. (1975) | Rehnberg et al. (1982) | Fore and Morton (1952) |
| Liver      | 1.68  | 1.2                  | 2.6–2.9                | 2.1                    |
| Pancreas   | 1.21  | 0.77                 | No data                | 1.6                    |
| Adrenals   | 0.20  | 0.69                 | 2.9                    | 0.67                   |
| Kidney     | 0.93  | 0.56                 | 0.9–1.0                | 1.2                    |
| Brain      | 0.34  | 0.30 <sup>a</sup>    | 0.4                    | 0.36                   |
| Lung       | 0.34  | 0.22                 | No data                | 0.01                   |
| Heart      | 0.23  | 0.21                 | No data                | 0.28                   |
| Testes     | 0.19  | 0.20                 | 0.4                    | 0.36                   |
| Ovary      | 0.19  | 0.19                 | No data                | 0.60                   |
| Muscle     | 0.09  | 0.09                 | No data                | 0.13                   |
| Spleen     | 0.22  | 0.08                 | 0.3                    | 0.22                   |
| Fat        | No data   | 0.07                 | No data                | No data                |
| Bone (rib) | No data   | 0.06                 | No data                | No data                |
| Pituitary  | No data   | No data              | 0.5                    | 2.4                    |

<sup>a</sup>Average of cerebrum and cerebellum

## 3. HEALTH EFFECTS

was from one of the two infants at 41 gestational weeks of age when analyzed. The data indicate that fetal liver manganese levels throughout the latter half of gestation are comparable to those in the adult.

Concentrations of manganese also have been measured in the blood of pregnant women, as well as in the plasma of cord blood of preterm and full-term infants (Wilson et al. 1991). Manganese concentrations in full-term (37–42 weeks gestation) infants were  $5.5 \pm 1.5$   $\mu\text{g/L}$ , slightly higher than the preterm (27–36 weeks gestation) infants' values of  $5.0 \pm 1.1$   $\mu\text{g/L}$ , but the difference was not statistically significant. There were no correlations between the levels in infants and mothers. The higher manganese levels in cord blood of gestationally older infants, along with the higher manganese level in the oldest fetus from the Widdowson et al. (1972) study, suggest that manganese levels may rise slightly as the fetus approaches birth; however, there are inadequate data points to make a strong argument for this possibility. Serum manganese values of 180 healthy Venezuelan infants decreased consistently from a high value of  $0.45$   $\mu\text{g/L}$  (mean of 22 infants) at 5 days of age to a low value of  $0.29$   $\mu\text{g/L}$  (mean of 40 infants) at 12 months of age (Alarcón et al. 1996). The level of manganese at 12 months was the only measurement that was statistically different than the 5-day value. The values were not statistically different between the sexes. Rügauer et al. (1997) obtained very different results in their analyses of serum manganese levels in German children, adolescents, and adults. The authors evaluated 137 children (aged 1 month–18 years); the mean serum manganese level for all children was  $1.4$   $\mu\text{g/L}$  (range  $0.17$ – $2.92$   $\mu\text{g/L}$ ). When the children were separated by age, the serum manganese values were found to decrease from a mean value of  $2.12$   $\mu\text{g/L}$  (age 0–1 year) to a minimum of  $0.98$   $\mu\text{g/L}$  (age 14–18 years). Adults (age 22–75 years) had a mean value of  $0.79$   $\mu\text{g/L}$ . These data indicate that children had much higher manganese levels in serum than those levels shown by the other studies. It is unknown why this latter study indicates results that are vastly different from those reported in the earlier studies. Rügauer et al. (1997) took precautions to prevent manganese contamination of their experimental materials during sampling and analysis. Also, the authors reported that the subjects were healthy and were not suffering from nutritional diseases or metabolic disorders and were not taking medicines containing trace elements. However, the children and adolescent subjects were chosen from a pediatric hospital after seeking medical attention on non-nutrition related matters. Therefore, this population may not be a representative sample of the general population. Animal studies, by contrast, suggest that distribution of manganese in the infant and young child may be very different from the adult.

Levels in tissues from animals fed a normal diet are generally similar but, perhaps are slightly higher than those in humans (Fore and Morton 1952; Rehnberg et al. 1982). Levels of manganese in the milk of rats

### 3. HEALTH EFFECTS

fed a normal diet averaged 0.054 µg/g (Miller et al. 1975). Data on changes in tissue levels following acute exposures to excess manganese are presented in exposure-specific subsections later in this chapter.

Manganese is also found in breast milk for the continuing metabolic nutrition of the infant. One study reported manganese concentrations from 82 normal, healthy French women of 12±5.6 µg/L at postpartum day 2 in human colostrum decreasing to 3.4±1.6 µg/L at postpartum day 6 in breast milk (Arnaud and Favier 1995). Another study reported an average manganese concentration in breast milk of 6.2 µg/L using 2,339 samples from mothers of 20 full-term and 6 preterm infants (Dorner et al. 1989). Collipp et al. (1983) have reported concentrations of manganese in breast milk of 10 µg/L. These reports, however, did not address the dietary manganese intake of the nursing mothers. It is unknown whether mothers exposed to increased concentrations of manganese have higher-than-usual levels of the metal in breast milk.

Manganese is distributed throughout all cells in the body; therefore, it is present in germ cells. However, existing studies in humans and animals are not sufficient to predict if distribution of excess manganese into germ cells might result in heritable genetic changes. Manganese is constantly present in human tissues and, therefore, is able to enter germ cells. One human study involving inhalation exposure to nickel and manganese observed chromosomal aberrations in welders working with these metals (Elias et al. 1989). However, the presence of nickel is a confounding factor, as it is known for causing chromosomal changes. Studies in animals are equivocal; there are not enough data to make predictions as to the likelihood for excess exposures of manganese to cause heritable genetic changes.

Concentrations of manganese in select human and animal tissues are presented in Table 3-7 and concentrations of manganese in plasma and serum in infants of differing ages and adults are presented in Table 3-8.

#### **3.4.2.1 Inhalation Exposure**

Following inhalation exposure of mice to manganese dust, for a short period of time the concentration of manganese in the lung is approximately proportional to the concentration of manganese in the air (Adkins et al. 1980c). However, as noted earlier, some of the particles that are deposited in the lung are transported to the gastrointestinal tract (Mena et al. 1969). The rate of particle transport from the lungs has not been quantified in humans, but half-times of elimination in animals range from 3 hours to 1 day (Adkins et al. 1980c; Bergstrom 1977; Newland et al. 1987).

## 3. HEALTH EFFECTS

**Table 3-8. Manganese Levels in Human Serum/Plasma**

| Age                           | Concentration ( $\mu\text{g/L}$ ) (mean $\pm$ 2 standard deviations) |                 |
|-------------------------------|--|-----------------|
|                               | Serum <sup>c</sup>   | Plasma          |
| 5 Days <sup>a</sup>           | 0.45 $\pm$ 0.12 (22)   |                 |
| 1 Month                       | 0.41 $\pm$ 0.11 (20)   |                 |
| 3 Months                      | 0.39 $\pm$ 0.13 (22)   |                 |
| 5 Months                      | 0.39 $\pm$ 0.10 (14)   |                 |
| 7 Months                      | 0.38 $\pm$ 0.09 (20)   |                 |
| 10 Months                     | 0.37 $\pm$ 0.11 (20)   |                 |
| 11 Months                     | 0.36 $\pm$ 0.12 (22)   |                 |
| 12 Months                     | 0.29 $\pm$ 0.10 (40)   |                 |
| 1 Month–18 years <sup>b</sup> | 1.4 $\pm$ 1.25   |                 |
| 22–75 Years                   |  | 0.79 $\pm$ 0.63 |

<sup>a</sup>Data from infants 5 days–12 months in age are from Alarcón et al. (1996). Data are from mixed-sex groups. No statistically significant differences in manganese concentrations were found between sexes.

<sup>b</sup>Data from Rùkgauer et al. (1997).

<sup>c</sup>Value in parentheses is the number of subjects.

## 3. HEALTH EFFECTS

The relative increases in tissue levels of manganese following inhalation exposure to inorganic forms of manganese have received considerable investigation in animals.

Increases of 20–60% in manganese levels in the kidney and spleen were noted in mice 24–48 hours after exposure to manganese dioxide (Adkins et al. 1980c). Rats exposed to an aerosol containing 0.0003 mg  $^{54}\text{Mn}/\text{m}^3$  for 1 hour had manganese levels in the liver, lung, kidney, and brain of 0.0495, 0.1366, 0.0141, and 0.0014 ng  $^{54}\text{Mn}/\text{organ}$ , respectively, 5 days after exposure (Wieczorek and Oberdörster 1989b). Sheep exposed to welding fumes for 3 hours exhibited a 40-fold increase in lung manganese content (Naslund et al. 1990). Preferential accumulation of manganese in specific locations of the brain (including the caudate nucleus, globus pallidus, and substantia nigra) was noted in one monkey exposed to an aerosol of manganese chloride (20–40 mg/m<sup>3</sup>) several hours/day for 3–5 months (Newland et al. 1989). This preferential uptake could play a role in the characteristic neurological effects of manganese (see Section 3.5).

Roels et al. (1997) investigated the distributional differences in rats exposed to manganese in two forms (manganese chloride and manganese dioxide) administered via intratracheal injection (intended to simulate inhalation), by gavage (oral administration) and via intraperitoneal injection. When administered intratracheally once a week for 4 weeks, 1.22 mg manganese/kg as manganese chloride resulted in a 68% steady-state increase in blood manganese concentration after the dosing period. This dose also resulted in significantly increased concentrations of manganese in the rat cerebellum (27% increase that approached statistical significance), striatum (205% increase), and cortex (48% increase), compared with control rats.

When rats were administered the same amount of manganese under the same dosing regimen, with manganese in the form of manganese dioxide, similar, but less striking, results were observed (Roels et al. 1997). Manganese concentrations in the blood were increased by 41%, and in the cerebellum, striatum, and cortex by 31, 48, and 34%, respectively, over the control rats.

Tjälve et al. (1996) investigated the distribution of manganese in brain tissues, liver, and kidneys of young male rats following intranasal injection of  $^{54}\text{MnCl}_2$ . Radiography data indicated that 1 day after dosing, the olfactory bulb contained 90% of the manganese (measured as  $\mu\text{g}/100\text{g}$  wet weight) in the measured tissues, while the basal forebrain contained 6% of the manganese. Concentrations of manganese in the basal forebrain increased to 21 and 28% of the measured total at 3 and 7 days post-



## 3. HEALTH EFFECTS

dosing, respectively. Manganese in the cerebral cortex, hypothalamus, striatum, and hippocampus were also maximal at 7 days post-dosing. Manganese values in liver and kidneys were approximately 1% of the total measured for the first 7 days, and then decreased steadily until 12 weeks. These results were compared to distribution of manganese following intraperitoneal injection, in which no brain region showed preferential distribution at 1, 7, or 21 days post-dosing (Tjälve et al. 1996). In another study, Gianutsos et al. (1997) found a dose-dependent accumulation of manganese in the olfactory bulb and tubercle following intranasal injection of manganese chloride into one nostril. Injection of 200 µg manganese resulted in maximally elevated levels in the olfactory bulb (400% higher than the uninjected side), with levels in the tubercle half that in the bulb within 12 hours post-exposure; these levels remained elevated for 3 days. Two injections of 200 µg manganese doubled the level of manganese in the striatum compared to saline-injected controls; single doses did not increase tissue manganese levels. No other brain regions were noted and blood manganese levels were not changed with any treatment. These data indicate that the olfactory mucosa is an important pathway for distribution of manganese into the brain.

Vitarella et al. (2000) exposed adult rats to airborne doses of particulate manganese, as manganese phosphate, at 0, 0.03, 0.3, 3 mg manganese/m<sup>3</sup>. The particles had a mean diameter of 1.5 µm. Exposures lasted for 6 hours/day for either 5 days/week (10 exposures) or 7 days/week (14 exposures). The following tissues were analyzed for manganese content using neutron activation analysis: plasma, erythrocytes, olfactory bulb, striatum, cerebellum, lung, liver, femur, and skeletal muscle. Increased manganese concentrations were reported in olfactory bulb, lung, femur, and skeletal muscle following exposure to 3 mg/m<sup>3</sup> (after either dosing regimen); a lower dose of 0.3 mg/m<sup>3</sup> resulted in increased manganese concentrations in olfactory bulb, and lung (14-day dose regimen only). Striatal manganese levels were increased at the two highest doses only after 14 days of exposure. However, concentrations in the cerebellum were similarly elevated, which was interpreted by the authors to indicate that accumulation of manganese was not selective for the striatum. Red blood cell and plasma manganese levels were increased only in rats exposed to the highest dose for the 10-day exposure period. These data indicate that even at lower doses manganese can accumulate in the olfactory bulb and that the neuronal pathway to the brain is significant for inhaled manganese in rodents.

Although the results from the studies by Tjälve et al. (1996) and Vitarella et al. (2000) indicate that manganese can be transported via the olfactory neural pathway from the nasal mucosa to the olfactory bulb of the brain and, to a limited degree, to other brain regions in rodents, the relative importance of this pathway to the delivery of manganese to basal ganglia sites of neurotoxicity is uncertain. Statistical mapping of functional olfactory connections in rat brains using MRI following nasal administration of

## 3. HEALTH EFFECTS

manganese chloride could readily detect connections to the olfactory bulb, but could not detect connections to other brain regions (Cross et al. 2004). Mainstream manganese entry into the brain from blood occurs through capillary endothelial cells of the blood-brain barrier and through the cerebral spinal fluid via the choroid plexuses (Bock et al. 2008; Crossgrove and Yokel 2005). A number of transport mechanisms (including facilitated diffusion, active transport, transferrin-mediated transport, divalent metal transporter-1 mediation, store-operated calcium channels) have been proposed to transport manganese across the blood barrier, but current understanding is inadequate to determine the predominant mechanism of transport (Aschner et al. 2005; 2007; Crossgrove and Yokel 2004, 2005; Roth 2006).

A concern that inhaled manganese, compared with ingested manganese, may more readily result in manganese accumulation in the brain, a principal toxicity target of manganese, has led to recent detailed investigations of manganese concentrations in various brain regions and in other tissues following inhalation exposure of animals to environmentally relevant forms of manganese. These studies have investigated manganese concentrations in tissues of young male and female CD rats exposed by inhalation to manganese sulfate or manganese tetroxide for 14 days at concentrations of 0, 0.03, 0.3, or 3 mg manganese/m<sup>3</sup> (Dorman et al. 2001a), young male CD rats given low- (2 ppm), sufficient- (10 ppm), or high-manganese (100 ppm) diets for 67 days, followed by inhalation exposure to manganese sulfate for 14 days at concentrations of 0, 0.092, or 0.92 mg manganese/m<sup>3</sup> (Dorman et al. 2001b), young male and female CD rats or aged male CD rats after 90 days of inhalation exposure to manganese sulfate at 0.01, 0.1, or 0.5 mg manganese/m<sup>3</sup> or manganese phosphate at 0.1 mg manganese/m<sup>3</sup> (Dorman et al. 2004a), maternal CD rats and offspring after inhalation exposure to manganese sulfate at 0, 0.05, 0.5, or 1.0 mg manganese/m<sup>3</sup> starting 28 days prior to breeding through PND 18 (Dorman et al. 2005a, 2005b), and young male Rhesus monkeys after inhalation exposure to manganese sulfate at 0.06, 0.3 or 1.5 mg manganese/m<sup>3</sup> for 15, 33, or 65 exposure days (Dorman et al. 2006a).

The results from these animal studies indicate that tissue manganese concentrations in the brain depended on aerosol concentration, exposure duration, and brain region. Tissue manganese concentrations generally increased with increasing air concentrations and durations of exposure. With repeated exposures at the highest air concentrations ( $\geq 0.92$  mg manganese/m<sup>3</sup>), manganese concentrations in brain regions were elevated, compared with control animals, showing the following order: olfactory bulb>striatum>cerebellum. Illustrative data for maternal CD rats (Dorman et al. 2005a) and young Rhesus monkeys (Dorman et al. 2006a) exposed to manganese sulfate are shown in Tables 3-9 and 3-10, respectively. Comparison of manganese concentrations across tissues shows the following order in exposed maternal rats: liver > pancreas > olfactory bulb > lung > striatum  $\approx$  femur > milk > cerebellum

## 3. HEALTH EFFECTS

**Table 3-9. Terminal Mean ( $\pm$ Standard Error on the Mean) Tissue Manganese Concentrations ( $\mu\text{g}$  Manganese/g Tissue Wet Weight) in Maternal CD Rats Exposed to Aerosols of Manganese Sulfate 6 Hours/Day, 7 Days/Week Starting 28 Days Prior to Breeding Through Postnatal Day 18**

| Tissue         | Exposure concentration (mg manganese/m <sup>3</sup> ) |                              |                              |                              |
|----------------|---|------------------------------|------------------------------|------------------------------|
|                | 0   | 0.05                         | 0.5                          | 1.0                          |
| Whole blood    | 0.08 $\pm$ 0.04                                       | 0.06 $\pm$ 0.02              | 0.06 $\pm$ 0.01              | 0.05 $\pm$ 0.01              |
| Olfactory bulb | 0.56 $\pm$ 0.05                                       | 0.71 $\pm$ 0.04 <sup>a</sup> | 1.40 $\pm$ 0.07 <sup>a</sup> | 1.73 $\pm$ 0.07 <sup>a</sup> |
| Striatum       | 0.51 $\pm$ 0.02                                       | 0.54 $\pm$ 0.02              | 0.74 $\pm$ 0.02 <sup>a</sup> | 0.89 $\pm$ 0.02 <sup>a</sup> |
| Cerebellum     | 0.50 $\pm$ 0.02                                       | 0.52 $\pm$ 0.02              | 0.60 $\pm$ 0.01 <sup>a</sup> | 0.61 $\pm$ 0.03 <sup>a</sup> |
| Lung           | 0.22 $\pm$ 0.03                                       | 0.37 $\pm$ 0.02              | 0.86 $\pm$ 0.07 <sup>a</sup> | 1.05 $\pm$ 0.06 <sup>a</sup> |
| Liver          | 3.21 $\pm$ 0.15                                       | 3.04 $\pm$ 0.09              | 3.37 $\pm$ 0.15              | 4.28 $\pm$ 0.76 <sup>a</sup> |
| Femur          | 0.62 $\pm$ 0.07                                       | 0.61 $\pm$ 0.04              | 0.77 $\pm$ 0.05              | 0.89 $\pm$ 0.06 <sup>a</sup> |
| Pancreas       | 1.66 $\pm$ 0.13                                       | 1.80 $\pm$ 0.19              | 1.29 $\pm$ 0.28              | 1.91 $\pm$ 0.23              |
| Milk           | 0.21 $\pm$ 0.08                                       | 0.20 $\pm$ 0.06              | 0.47 $\pm$ 0.06              | 0.77 $\pm$ 0.10 <sup>a</sup> |
| Group size (n) | 8   | 10                           | 9                            | 8                            |

<sup>a</sup>Significantly ( $p < 0.05$ ) different from control mean value.

Source: Dorman et al. 2005a

## 3. HEALTH EFFECTS

**Table 3-10. Mean ( $\pm$ Standard Error on the Mean) Tissue Manganese Concentrations ( $\mu\text{g}$  Manganese/g Tissue Wet Weight) in Young Male Rhesus Monkeys Exposed to Aerosols of Manganese Sulfate ( $1.5 \text{ mg Manganese/m}^3$ ) 6 Hours/Day, 5 Days/Week for Up to 65 Days**

| Exposure to air          | 1.5 mg manganese/m <sup>3</sup> |                              |                              |                                    |                                    |                       |
|--------------------------|---------------------------------|------------------------------|------------------------------|------------------------------------|------------------------------------|-----------------------|
| Exposure (days)          | 65                              | 15                           | 33                           | 65                                 | 65 (+45) <sup>a</sup>              | 65 (+90) <sup>a</sup> |
| <b>Tissue</b>            |                                 |                              |                              |                                    |                                    |                       |
| <b>Olfactory tissues</b> |                                 |                              |                              |                                    |                                    |                       |
| Olfactory epithelium     | 0.49 $\pm$ 0.01                 | 6.10 $\pm$ 0.39 <sup>b</sup> | 7.34 $\pm$ 0.70 <sup>b</sup> | 7.10 $\pm$ 2.01 <sup>b</sup>       | 0.65 $\pm$ 0.04                    | 0.69 $\pm$ 0.11       |
| Olfactory bulb           | 0.31 $\pm$ 0.01                 | 2.19 $\pm$ 0.44 <sup>b</sup> | 2.29 $\pm$ 0.26 <sup>b</sup> | 2.40 $\pm$ 0.18 <sup>b</sup>       | 0.35 $\pm$ 0.02                    | 0.31 $\pm$ 0.02       |
| Olfactory tract          | 0.30 $\pm$ 0.06                 | 0.77 $\pm$ 0.19 <sup>b</sup> | 0.84 $\pm$ 0.11 <sup>b</sup> | 1.12 $\pm$ 0.08 <sup>b</sup>       | 0.18 $\pm$ 0.02                    | 0.22 $\pm$ 0.02       |
| Olfactory cortex         | 0.19 $\pm$ 0.01                 | 0.43 $\pm$ 0.04 <sup>b</sup> | 0.45 $\pm$ 0.01 <sup>b</sup> | 0.42 $\pm$ 0.01 <sup>b</sup>       | 0.26 $\pm$ 0.01                    | 0.21 $\pm$ 0.01       |
| <b>Brain</b>             |                                 |                              |                              |                                    |                                    |                       |
| Globus pallidus          | 0.48 $\pm$ 0.04                 | 1.92 $\pm$ 0.40 <sup>b</sup> | 2.41 $\pm$ 0.29 <sup>b</sup> | 2.94 $\pm$ 0.23 <sup>b</sup>       | 1.09 $\pm$ 0.03 <sup>b</sup>       | 0.59 $\pm$ 0.12       |
| Putamen                  | 0.36 $\pm$ 0.01                 | 1.01 $\pm$ 0.08 <sup>b</sup> | 1.50 $\pm$ 0.14 <sup>b</sup> | 1.81 $\pm$ 0.14 <sup>b</sup>       | 0.58 $\pm$ 0.03 <sup>b</sup>       | 0.44 $\pm$ 0.02       |
| Caudate                  | 0.34 $\pm$ 0.02                 | 0.93 $\pm$ 0.11 <sup>b</sup> | 1.37 $\pm$ 0.13 <sup>b</sup> | 1.72 $\pm$ 0.10 <sup>b</sup>       | 0.57 $\pm$ 0.03                    | 0.43 $\pm$ 0.02       |
| Frontal cortex           | 0.25 $\pm$ 0.03                 | 0.36 $\pm$ 0.01 <sup>b</sup> | 0.52 $\pm$ 0.03 <sup>b</sup> | 0.47 $\pm$ 0.02 <sup>b</sup>       | 0.26 $\pm$ 0.01                    | 0.23 $\pm$ 0.01       |
| Cerebellum               | 0.44 $\pm$ 0.01                 | 0.85 $\pm$ 0.06 <sup>b</sup> | 0.96 $\pm$ 0.05 <sup>b</sup> | 1.10 $\pm$ 0.11 <sup>b</sup>       | 0.66 $\pm$ 0.04                    | 0.61 $\pm$ 0.10       |
| Pituitary                | 0.84 $\pm$ 0.12                 | 3.79 $\pm$ 0.38 <sup>b</sup> | 5.60 $\pm$ 0.33 <sup>b</sup> | 6.19 $\pm$ 0.61 <sup>b</sup>       | 3.01 $\pm$ 0.91 <sup>b</sup>       | 1.54 $\pm$ 0.18       |
| Trigeminal nerve         | 0.17 $\pm$ 0.05                 | 0.27 $\pm$ 0.02              | 0.51 $\pm$ 0.14 <sup>b</sup> | 0.42 $\pm$ 0.08 <sup>b</sup>       | 0.18 $\pm$ 0.01                    | 0.17 $\pm$ 0.02       |
| <b>Organs</b>            |                                 |                              |                              |                                    |                                    |                       |
| Femur                    | 0.13 $\pm$ 0.02                 | 0.27 $\pm$ 0.04 <sup>b</sup> | 0.13 $\pm$ 0.03              | 0.20 $\pm$ 0.03                    | 0.12 $\pm$ 0.02                    | 0.09 $\pm$ 0.01       |
| Heart                    | 0.16 $\pm$ 0.03                 | 0.25 $\pm$ 0.05              | 0.50 $\pm$ 0.03 <sup>b</sup> | 0.62 $\pm$ 0.05 <sup>b</sup>       | 0.23 $\pm$ 0.3                     | 0.27 $\pm$ 0.01       |
| Kidney                   | 1.14 $\pm$ 0.12                 | 2.65 $\pm$ 0.14 <sup>b</sup> | 3.04 $\pm$ 0.09 <sup>b</sup> | 2.61 $\pm$ 0.30 <sup>b</sup>       | 1.38 $\pm$ 0.13                    | 1.27 $\pm$ 0.14       |
| Liver                    | 2.49 $\pm$ 0.09                 | 2.96 $\pm$ 0.34              | 3.28 $\pm$ 0.22              | 3.52 $\pm$ 0.45 <sup>b</sup>       | 2.88 $\pm$ 0.27                    | 2.04 $\pm$ 0.06       |
| Lung                     | 0.15 $\pm$ 0.03                 | 0.39 $\pm$ 0.06 <sup>b</sup> | 0.35 $\pm$ 0.02 <sup>b</sup> | 0.33 $\pm$ 0.04 <sup>b</sup>       | 0.09 $\pm$ 0.01                    | 0.06 $\pm$ 0.01       |
| Pancreas                 | 1.59 $\pm$ 0.11                 | 2.89 $\pm$ 0.14 <sup>b</sup> | 2.38 $\pm$ 0.34 <sup>b</sup> | 2.95 $\pm$ 0.24 <sup>b</sup>       | 1.41 $\pm$ 0.270.                  | 1.53 $\pm$ 0.10       |
| Skeletal muscle          | 0.15 $\pm$ 0.03                 | 0.22 $\pm$ 0.03              | 0.22 $\pm$ 0.02              | 0.58 $\pm$ 0.19 <sup>b</sup>       | 19 $\pm$ 0.02                      | 0.12 $\pm$ 0.01       |
| Parietal bone            | 0.08 $\pm$ 0.04                 | 0.48 $\pm$ 0.16 <sup>b</sup> | 0.56 $\pm$ 0.18 <sup>b</sup> | 0.25 $\pm$ 0.04                    | 0.17 $\pm$ 0.03                    | 0.16 $\pm$ 0.04       |
| Testis                   | 0.26 $\pm$ 0.03                 | 0.41 $\pm$ 0.06              | 0.50 $\pm$ 0.04 <sup>b</sup> | 0.39 $\pm$ 0.07                    | 0.36 $\pm$ 0.04                    | 0.31 $\pm$ 0.02       |
| <b>Fluids</b>            |                                 |                              |                              |                                    |                                    |                       |
| Bile                     | 0.89 $\pm$ .22                  | 7.38 $\pm$ .78 <sup>b</sup>  | 4.40 $\pm$ .89 <sup>b</sup>  | 7.60 $\pm$ 1.68 <sup>b</sup>       | 1.17 $\pm$ 0.28                    | 0.77 $\pm$ 0.13       |
| Blood                    | 0.010 $\pm$ .00<br>1            | 0.016 $\pm$ .06              | 0.022 $\pm$ .002<br>a        | 0.026 $\pm$ 0.00<br>3 <sup>b</sup> | 0.021 $\pm$ 0.00<br>2 <sup>b</sup> | 0.013 $\pm$ .00<br>1  |
| Urine                    | 0.000 $\pm$ .00<br>0            | 0.000 $\pm$ .000             | 0.001 $\pm$ .000             | 0.005 $\pm$ 0.00<br>1 <sup>b</sup> | 0.000 $\pm$ 0.00<br>0              | 0.000 $\pm$ .00<br>0  |
| Group size (n)           | 6                               | 4                            | 4                            | 4                                  | 4                                  | 4                     |

<sup>a</sup>These monkeys were sacrificed 45 or 90 days after the 65-day exposure period.

<sup>b</sup>Significantly ( $p < 0.05$ ) greater than mean value for air control rats.

Source: Dorman et al. 2006a

## 3. HEALTH EFFECTS

>> whole blood (Table 3-9). In young Rhesus monkeys after 65 days of exposure, the order was: bile > olfactory epithelium > pituitary > liver > pancreas  $\approx$  globus pallidus > olfactory bulb > kidney > putamen > caudate > cerebellum > heart > skeletal muscle > frontal cortex > lung > parietal bone  $\approx$  femur >> blood (Table 3-10).

Brain tissues from the monkeys were dissected into more regions than the rat brains and, immediately following 65 days of exposure to the highest exposure concentration, showed the following order of elevated manganese concentrations: pituitary>globus pallidus>olfactory bulb>putamen>caudate> cerebellum>frontal cortex>trigeminal nerve (see Table 3-10). These results are consistent with the evidence that the human striatum, globus pallidus, and substantia nigra are the primary neurotoxicity target for manganese (Aschner et al. 2005; Pal et al. 1999). Three- to 5-fold increases (over air control values) in mean manganese tissue concentrations were found in the globus pallidus, putamen, and caudate in monkeys exposed to 1.5 mg manganese/m<sup>3</sup> manganese sulfate for 65 days, but levels were <3-fold increased in the frontal cortex and cerebellum, two brain regions not generally associated with manganese neurotoxicity (Dorman et al. 2006a; Table 3-10).

Comparison with the rat results in Table 3-9 suggests that rodents do not accumulate manganese in the basal ganglia (i.e., the collection of deep regions of the brain including the striatum [comprised of the caudate and putamen]) to the same relative degree as primates, a difference that may be related to findings that overt signs of manganese neurotoxicity are more readily detected in nonhuman primates than rodents (Aschner et al. 2005; Bock et al. 2008; Newland 1999). Recent corroborative findings showed that marmosets, a nonhuman primate, accumulated more manganese in the brain (especially in the basal ganglia and the visual cortex) than rats following intravenous injection of equivalent mg/kg body weight doses of manganese chloride (Bock et al. 2008). The mechanisms by which manganese accumulates in the basal ganglia of primates are poorly understood (Aschner et al. 2005; Bock et al. 2008; Brenneman et al. 1999; Dorman et al. 2006b), but Bock et al. (2008) have hypothesized that primates may accumulate relatively more manganese in the basal ganglia than rodents because of a relatively larger cerebral spinal fluid space in lateral ventricles adjacent to the basal ganglia.

The high concentrations of manganese in bile sampled from manganese-exposed monkeys (compared with air control values in Table 3-10) are reflective of the hepatobiliary excretion of manganese. It is currently unknown whether or not the high manganese concentrations attained in the pituitary glands of these monkeys has any effect on normal pituitary function; in this study, exposed monkeys showed no

## 3. HEALTH EFFECTS

difference in serum levels of luteinizing hormone (LH), a hormone that stimulates production of testosterone by the Leydig cells of the testes (Dorman et al. 2006a).

In pregnant rats repeatedly exposed to inhaled manganese, the placenta appears to partially limit the transport of manganese to the developing fetus (Dorman et al. 2005b). After inhalation exposure to manganese sulfate at 0, 0.05, 0.5, or 1.0 mg manganese/m<sup>3</sup> starting 28 days prior to breeding through PND 18, samples of maternal tissues (whole blood, lung, pancreas, liver, brain, femur, and placenta) and fetal tissues (whole blood, lung, liver, brain, and skull cap) were collected and analyzed for manganese concentrations. Elevated ( $p < 0.05$ ) manganese concentrations were observed in exposed maternal rats (compared with air control rats) in the following tissues: brain and placenta at 0.5 and 1.0 mg manganese/m<sup>3</sup> and lung at 0.05, 0.5, and 1.0 mg manganese/m<sup>3</sup>. In contrast, statistically significant elevations of manganese concentrations in sampled fetal tissues were observed only in the liver at 0.5 and 1.0 mg manganese/m<sup>3</sup>. In pups born and allowed to live up to PND 19 (and sampled for tissue evaluations at PNDs 1, 14, and 19), statistically significant ( $p < 0.05$ ) elevated manganese concentrations (compared with air control values) were observed in blood, liver, and bone samples from exposed neonatal rats at concentrations  $\geq 0.05$  mg manganese/m<sup>3</sup>, starting at PND 1 (Dorman et al. 2005a). As shown in Table 3-11, elevated brain manganese concentrations were observed in exposed neonates starting at PND 14 (but not at earlier time points); tissue concentrations increased with increasing exposure concentration (Dorman et al. 2005a). At PND 19, mean manganese concentration in the striatum was about 2.6-fold higher in offspring exposed to 1 mg manganese/m<sup>3</sup>, compared with air control means (Table 3-11). In contrast, the mean striatum concentration at PND 19 in maternal rats exposed to 1 mg manganese/m<sup>3</sup> was about 1.7-fold increased, compared with controls (Table 3-11). The results from this study suggest that the brain in developing fetuses is partially protected from excess manganese by the placenta, and that the neonatal period, compared with adulthood, is relatively more susceptible to increased manganese concentration in brain tissues with inhalation exposure to manganese sulfate aerosol concentrations between 0.05 and 1 mg manganese/m<sup>3</sup>.

In an examination of the distribution of manganese in young adult male and female CD rats (28 days at start) and aged male CD rats (16 months at start) following 90-day inhalation exposure to manganese sulfate or manganese phosphate, no evidence was found for a gender or age effect on delivery of manganese to the striatum or on the order of manganese concentrations in tissues (pancreas > olfactory bulb > femur > testes), but gender or age-related differences in tissue manganese concentrations in other brain regions, as well as in the lung, pancreas, femur, and testis, were noted (Dorman et al. 2004a). Following a 90-day inhalation exposure to 0.5 mg manganese/m<sup>3</sup> manganese sulfate, young adult male

## 3. HEALTH EFFECTS

**Table 3-11. Manganese Concentrations in Brain Tissues of Lactating CD Rats and Offspring Exposed to Aerosols of Manganese Sulfate**

| Air level <sup>a</sup><br>(mg<br>manganese/m <sup>3</sup> ) | Mean maternal concentrations at<br>PND 18 (µg manganese/g) <sup>b</sup> |                        |                        | Mean offspring concentrations<br>(µg manganese/g) <sup>c</sup> |                   |                   |                   |                   |
|---|---|------------------------|------------------------|--|-------------------|-------------------|-------------------|-------------------|
|   | Striatum  | Cerebellum             | Olfactory<br>bulb      | Brain/striatum   |                   |                   | Cerebellum        | Olfactory<br>bulb |
|   |   |                        |                        | PND 1  | PND 14            | PND 19            | PND 19            | PND 19            |
| 0   | 0.51±0.02   | 0.50±0.02              | 0.56±0.04              | 0.39   | 0.19              | 0.37              | 0.34              | 0.36              |
| 0.05  | 0.54±0.02   | 0.52±0.02              | 0.71±0.04 <sup>d</sup> | 0.42   | 0.35 <sup>d</sup> | 0.63 <sup>d</sup> | 0.51 <sup>d</sup> | 0.52 <sup>d</sup> |
| 0.5   | 0.74±0.02 <sup>d</sup>  | 0.60±0.01 <sup>d</sup> | 1.40±0.07 <sup>d</sup> | 0.45   | 0.59 <sup>d</sup> | 0.83 <sup>d</sup> | 0.64 <sup>d</sup> | 0.70 <sup>d</sup> |
| 1   | 0.89±0.02 <sup>d</sup>  | 0.61±0.03 <sup>d</sup> | 1.73±0.07 <sup>d</sup> | 0.50   | 0.55 <sup>d</sup> | 0.97 <sup>d</sup> | 0.72 <sup>d</sup> | 0.76 <sup>d</sup> |

<sup>a</sup>Rats were exposed for 6 hours/day starting 28 days prior to breeding through postnatal day (PND) 18 as reported by Dorman et al. (2005a, 2005b).

<sup>b</sup>Mean±SEM from Table 3 in Dorman et al. (2005a).

<sup>c</sup>Means from Figure 4 in Dorman et al. (2005a). Bar graphs were digitized to obtain numerical estimates of means for male and female offspring combined. At PNDs 1 and 14, whole brain tissues were analyzed. At PND 19, brains were dissected into striatum, cerebellum, and olfactory bulb before analysis.

<sup>d</sup>Significantly (p<0.05) different from air control mean.

PND = postnatal day; SEM = standard error of the mean

### 3. HEALTH EFFECTS

rats had significantly ( $p < 0.05$ ) higher olfactory bulb, blood, femur, and pancreas manganese concentrations than aged male rats, and aged male rats had significantly higher testis manganese concentrations than young male rats. Young male rats exposed to 0.5 mg manganese/m<sup>3</sup> had significantly higher olfactory bulb, blood, and lung manganese concentrations than similarly exposed female rats, and female rats exposed to 0.5 mg manganese/m<sup>3</sup> had significantly higher cerebellum manganese concentrations than control females. Young male and female rats exposed to 0.5 mg manganese/m<sup>3</sup> for 90 days had increased <sup>54</sup>Mn clearance rates than air-exposed controls, but similarly-exposed aged male rats did not display increased <sup>54</sup>Mn clearance rates, compared with controls (Dorman et al. 2004a). No age-related effects were observed on the order of manganese concentrations in the various tissue.

No studies were located regarding distribution of manganese in human or animals following inhalation exposure to MMT or mangafodipir.

#### 3.4.2.2 Oral Exposure

Excess manganese uptake has occurred in humans following oral exposure, presumably via the diet, when the individuals suffered from chronic liver disease or some other liver dysfunction (cirrhosis, portacaval shunt, etc.). In these instances, excess manganese was shown to accumulate in certain regions of the brain, as determined by T1-weighted MRI or neutron activation analysis (Devenyi et al. 1994; Fell et al. 1996; Hauser et al. 1994, 1996; Pomier-Layrargues et al. 1998; Rose et al. 1999; Spahr et al. 1996). These studies show that manganese preferentially accumulates in the basal ganglia, especially the globus pallidus, and the substantia nigra.

Rats given a single oral dose of 416 mg manganese/kg body weight (as manganese chloride tetrahydrate) exhibited little tissue accumulation of manganese 14 days later (Holbrook et al. 1975). Studies in animals indicate that prolonged oral exposure to manganese compounds results in increased manganese levels in all tissues, but that the magnitude of the increase diminishes over time (Kristensson et al. 1986; Rehnberg et al. 1980, 1981, 1982). Table 3-12 provides illustrative data based on rats exposed to 214 mg manganese/kg(body weight)/day (as manganese tetroxide) for up to 224 days. As the data reveal, large increases in tissue levels of manganese compared to the controls occurred in all tissues over the first 24 days, but levels tended to decrease toward the control levels as exposure was continued. This pattern is thought to be due to a homeostatic mechanism that leads to decreased absorption and/or increased excretion of manganese when manganese intake levels are high (Abrams et al. 1976a; Ballatori et al. 1987; Mena et al. 1967). Davis et al. (1992b) and Malecki et al. (1996b) demonstrated that rats fed



## 3. HEALTH EFFECTS

**Table 3-12. Manganese Levels in Rat Tissue After Oral Exposure**

| Tissue | Tissue concentrations (percent of control) <sup>a</sup> |         |          |
|--------|---|---------|----------|
|        | 24 days   | 60 days | 224 days |
| Liver  | 810   | 137     | 138      |
| Kidney | 430   | 102     | 128      |
| Brain  | 540   | 175     | 125      |
| Testes | 260   | 125     | 100      |

<sup>a</sup>Values presented are the ratio (expressed as a percentage) of tissue levels of manganese in animals receiving 3,550 ppm manganese in the diet (as manganese tetroxide) compared to animals receiving a normal diet (50 ppm).

Source: Rehnberg et al. 1980

## 3. HEALTH EFFECTS

elevated levels of manganese for several weeks had increased tissue manganese concentrations, despite increased gut endogenous losses of manganese, as biliary manganese. This reflected several factors. Although the percentage of manganese absorbed decreased, the total amount of manganese absorbed increased when higher levels of manganese were fed. Moreover, although the total amount of manganese lost in bile increased when manganese intake increased, the percentage of manganese intake lost in bile remained constant at ~1% of manganese intake (Malecki et al. 1996b). Table 3-9 contains a summary of manganese levels measured in rat tissue.

A study measuring the retention of a single oral dose of radiolabeled manganese in adult and neonatal rats indicated that retention of the label 6 days after exposure was much greater in pups (67%) than in adults (0.18%); the addition of manganese to the animals' drinking water decreased radiolabel retention in pups and adults (Kostial et al. 1989).

The distributional differences in rats exposed to either manganese chloride or manganese dioxide by gavage were investigated by Roels et al. (1997). After administration of 24.3 mg manganese/kg body weight (as manganese chloride) once weekly for 4 weeks, the authors analyzed blood and brain concentrations of the metal. Manganese concentrations were significantly elevated in the blood (approximately 83% increase over controls) and the cortex of the brain (approximately 39% increase over controls). Gavage administration of manganese dioxide, by contrast, did not significantly increase the amount of manganese in blood or any section of the brain. In addition, administration of manganese as manganese chloride by gavage caused roughly the same amount of increased manganese in the blood as intratracheal administration of manganese in the same form; it did not cause as significant an increase of manganese in the cortex (Roels et al. 1997). These data indicate that inhalation exposure to manganese in the form of manganese chloride or manganese dioxide causes accumulation of manganese in the brain more readily than oral exposure.

Acute manganese exposure in drinking water was found to alter brain regional manganese levels in neonatal rats; after 5 days of exposure, the highest level was in the striatum (12.05 µg/g wet weight) and the lowest level was in the cerebral cortex (0.85 µg/g wet weight) (Chan et al. 1992). After 10 days, the highest concentrations were in the pons and medulla and the lowest were in the hypothalamus. Regional manganese differences were less pronounced in weanling and adult rats. A study by Lai et al. (1991) confirms that intermediate exposure to manganese in drinking water increases brain manganese concentrations; rats exposed from conception to 120 days at 0.04 or 0.4 mg manganese/kg/day had mean

### 3. HEALTH EFFECTS

brain manganese levels of 0.36–0.72 µg/g in the low-dose animals and 0.62–1.35 µg/g in the high-dose animals, compared to 0.21–0.38 µg/g in controls.

In a dietary study, elevated manganese levels were found in the organs of male mice fed manganese chloride, manganese acetate, manganese carbonate or manganese dioxide at 284 mg manganese/kg/day for 100 days; levels of manganese in the liver and kidney were significantly higher in the animals exposed to manganese acetate or manganese carbonate than in those exposed to manganese chloride or manganese dioxide (Komura and Sakamoto 1991). In a 1993 NTP study, mice and rats chronically fed manganese sulfate generally exhibited elevated tissue levels of manganese; the manganese levels in the liver and kidney were higher than the levels in the brain.

No studies were located concerning disposition of manganese in humans or animals following oral exposure to MMT or mangafodipir.

#### **3.4.2.3 Dermal Exposure**

No studies were located regarding tissue distribution of manganese in humans or animals after dermal exposure to inorganic manganese.

No studies were located regarding tissue distribution of manganese in humans or animals after dermal exposure to organic manganese.

#### **3.4.2.4 Other Routes of Exposure**

No studies were located regarding tissue distribution of inorganic manganese in humans after exposure via other routes of exposure.

A number of studies have been conducted that investigated various facets of the distribution of inorganic manganese in animal models. The studies utilized a number of routes of administration, and the results suggested that route may play an important role in distribution. In an intraperitoneal study performed in monkeys, manganese was reported in all tissues studied. The highest levels were found in the pancreas, liver, and kidney, and the lowest levels were found in the blood; levels in the central nervous system were found to decrease more slowly than those in other tissues (Dastur et al. 1971). Calves injected intravenously with <sup>54</sup>Mn were found to have 3-fold higher liver manganese concentrations and 13-fold higher pancreatic manganese concentrations than calves fed manganese (Carter et al. 1974). Davis et al.

## 3. HEALTH EFFECTS

(1993) observed that rats injected intraportally with free  $^{54}\text{Mn}$  or  $^{54}\text{Mn}$  complexed with transferrin and rats injected intraperitoneally with free  $^{54}\text{Mn}$  accumulated more manganese in the pancreatic tissue and less in the liver than those rats that were either fed  $^{54}\text{Mn}$  or injected intravenously in the portal vein with an albumin- $^{54}\text{Mn}$  complex. The similarity in the distribution of the injected manganese-albumin complex and the free manganese in the diet when compared to the distribution of manganese when it was administered by other routes or complexed with other proteins suggests that the route of administration and type of complexed protein may cause differences in the transport of manganese in the sera.

Roels et al. (1997) studied the effect of intraperitoneal administration of manganese chloride and manganese dioxide on distributional differences of manganese in rats. Doses of 1.22 mg manganese/kg as manganese chloride given once per week for 4 weeks resulted in significant increases (when compared to controls) in blood (approximately 60%), striatum (34%), and cortex (36%) concentrations of manganese; no changes were observed in the cerebellum. Identical dosing of rats with manganese dioxide resulted in significant increases in manganese levels in blood (79%), cerebellum (40%), striatum (124%), and cortex (67%) over those in controls. These data indicate that administration of manganese dioxide by this route resulted in greater accumulation of manganese in the brain than did manganese chloride.

The distribution of manganese in the brain was investigated using Cebus (Newland and Weiss 1992; Newland et al. 1989) and Macaque (Newland et al. 1989) monkeys given intravenous injections of manganese chloride that reached a cumulative dose of 10–40 mg manganese/kg. Magnetic resonance images indicated hyper-intensity of the globus pallidus and substantia nigra consistent with an accumulation of manganese in these areas (Newland and Weiss 1992; Newland et al. 1989). Substantial accumulation of manganese was also noted in the pituitary at low cumulative doses (Newland et al. 1989). London et al. (1989) reported a rapid localization of manganese in the choroid plexus observed on MRI; similarly, radiotracer studies of manganese injected into the intracerebroventricular space revealed that radiolabeled manganese was located in the choroid plexus within 1 hour and was located in the rat dentate gyrus and CA3 of the hippocampus 3 days post-dosing (Takeda et al. 1994).

No studies were located regarding disposition of MMT in humans following other routes of exposure, but toxicokinetics of MMT following parenteral administration has received some research attention in animals.

## 3. HEALTH EFFECTS

Young adult male rats were administered MMT dissolved in propylene glycol via subcutaneous injection at a dose of 1 mg manganese/kg (McGinley et al. 1987). Control rats received vehicle alone. The rats were sacrificed 1.5, 3, 6, 12, 24, 48, or 96 hours post-injection. Levels of manganese in the control animals were measured in the blood ( $0.09 \pm 0.01$  mg/kg), lung ( $1.51 \pm 0.22$  mg/kg), liver ( $2.49 \pm 0.36$  mg/kg), kidney ( $1.29 \pm 0.23$  mg/kg), and brain ( $0.45 \pm 0.01$  mg/kg). These values were assumed by the authors to originate from the feed given to the rats and were subtracted from similar values analyzed for MMT-treated rats to determine the amount of manganese in these tissues and fluids that originated from MMT. Maximum accumulation of MMT-derived manganese was measured 3 hours after dosing and was found primarily in the following four tissues: lung ( $\sim 9$  mg/kg); kidney (3.9 mg/kg); liver (2.75 mg/kg); and blood ( $\sim 0.75$  mg/kg). Concentrations of manganese in these four tissues was still elevated ( $\sim 1$  mg/kg) at 96 hours post-dosing. Brain manganese concentrations were not significantly elevated over control levels in MMT-treated animals (McGinley et al. 1987).

Gianutsos et al. (1985) administered 0, 11, or 22 mg manganese/kg as MMT (dissolved in propylene glycol) to male adult mice via subcutaneous injection to determine distribution of manganese. Control mice received vehicle alone. Mice were sacrificed at different time points after dosing. The experiment was divided into an acute study (one dose) or a “chronic study” (ten doses). The brain manganese level 24 hours after the single dose of MMT at 11 mg/kg was  $0.93 \pm 0.07$   $\mu\text{g/g}$ ; the value after 22 mg/kg was  $1.35 \pm 0.09$   $\mu\text{g/g}$ . Both values were significantly different from the control value of  $0.61 \pm 0.08$   $\mu\text{g/g}$ . The brain manganese level in the mice administered 10 doses of 11 mg/kg each was  $1.37 \pm 0.27$   $\mu\text{g/g}$ ; after 10 doses of 22 mg/kg, the value was  $3.33 \pm 0.15$   $\mu\text{g/g}$ ; both were significantly greater than the control value of  $0.64 \pm 0.06$   $\mu\text{g/g}$ , and were significantly different than the levels reported after the acute exposure. Manganese levels in the brains of mice given a single dose of MMT at 22 mg manganese/kg were compared with those following injection of the same manganese dose as manganese chloride; mice were sacrificed at different time points from 1–24 hours post-dosing. The brain manganese levels following MMT exposure increased from a low at 1 hour to a maximum at 24 hours of  $\sim 1.4$   $\mu\text{g/g}$  wet weight. The manganese level in brain after manganese chloride exposure followed the same increasing trend over the 24 hour analysis period, but was higher at each time point, with a maximum value of  $>2.0$   $\mu\text{g/g}$  wet weight (Gianutsos et al. 1985).

Clinical studies involving cancer patients or healthy volunteers have analyzed the usefulness of mangafodipir as a contrast agent for the identification of certain abdominal tumors. Although these studies do not necessarily quantify the amount of manganese, or mangafodipir, in particular tissues, they

## 3. HEALTH EFFECTS

are useful tools in identifying the location of the metal; also relative proportions of manganese among two or more tissues that contain the metal can be observed by differences in signal from these imaging studies.

Several studies have shown the qualitative presence of manganese in the liver due to increased signal in that organ following mangafodipir administration of 0.17–0.83 mg manganese/kg upon T1-weighted MRI (Bernardino et al. 1992; Lim et al. 1991; Padovani et al. 1996; Wang et al. 1997). Two studies show that the human liver takes up more of the manganese from mangafodipir than any other organ: the signal from the liver was roughly 2 times the amount from the spleen after dosing with 0.55 mg manganese/kg (Lim et al. 1991); the liver signal after dosing with 0.55 mg manganese/kg had reached a 100% increase over baseline signal by 20 minutes following post-dosing, whereas the maximal signal from other organs was only 80% in the pancreas, ~30% in the spleen, ~90% in the renal medulla, and 50% in the choroid plexus, all at the same dose. The renal cortex was the only other tissue to reach a 100% increase over baseline signal at 0.55 mg manganese/kg. Dosing with 0.25 mg manganese/kg (the clinically used dose for current MRI testing of patients) resulted in a similar distribution pattern, although the signal was decreased compared to the higher dose. The signal from the renal cortex at the lower dose had a maximum of 80% over baseline, whereas the signal in the liver at this dose was ~75% of the baseline value (Wang et al. 1997).

Several studies have determined the distribution of manganese in tissues of animals following intravenous administration of mangafodipir. Grant et al. (1994) reported that in rats injected with 2 times the clinical dose of [<sup>54</sup>Mn] mangafodipir (0.55 mg manganese/kg), the carcass retained 8% of the label and the tissues retained 7% of the label; individual tissue concentrations of manganese were not reported.

Gallez et al. (1997) injected adult male mice once with 0.25 mg manganese/kg as [<sup>54</sup>Mn] mangafodipir (clinical dose) and determined the tissue manganese content at time points ranging from 15 minutes to 3 months post-dosing. Brain concentration of <sup>54</sup>Mn did not reach a maximum value of 0.26±0.04 (value is the percent of injected dose/g tissue) until 24 hours post-dosing; this value was not different than the brain manganese content of mice injected with manganese chloride. This maximum value was still observed in the brain 2 weeks post-dosing, but measurements taken at 1 and 3 months post-dosing were below the detection limit. By contrast, manganese from manganese chloride was still detectable, although not at maximal levels, at 3 months' time. Liver manganese reached a maximum value of 7.5±1.4 (percent dose/g tissue) 15 minutes post-dosing and then decreased to below the detection limit 1 month later.

## 3. HEALTH EFFECTS

Male and female Sprague-Dawley rats injected with [ $^{54}\text{Mn}$ ] mangafodipir at a dose of 5.5 mg manganese/kg had the following distribution of labeled manganese 30 minutes post-dosing (values are given in percent injected dose/g tissue): liver, 1.3; kidney, 1.2; heart, 0.25; spleen, 0.2; blood, 0.3; small bowel, 1.3; large bowel, 0.5; muscle, 0.1; and brain, negligible. Distribution of manganese in tissues of rats injected with labeled manganese chloride was compared to the previous results, and for all tissues, the label was greater after administration with the chloride than from the mangafodipir, with the exception of kidney and large bowel, but these differences were not significant (Elizondo et al. 1991).

The distribution of label in male and female Sprague-Dawley rats injected with either [ $^{54}\text{Mn}$ ] or [ $^{14}\text{C}$ ] mangafodipir at a dose of 0.39 or 0.55 mg manganese/kg, respectively, was studied by Hustvedt et al. (1997). The plasma concentration of labeled manganese reached a peak of 10.2  $\mu\text{g/mL}$  at 5 minutes post-dosing and was quickly distributed into the following organs (values given as  $\mu\text{g}$  equivalents of compound/g): pancreas, 10.2; liver, 4.0; kidneys, 3.6; testes/ovaries, 1.7; spleen, 1.0; heart, 0.9; and brain, 0.69. When the bile duct was cannulated, the distribution of an equivalent dose of mangafodipir showed an increased retention of labeled manganese in all organs but the brain (0.62): pancreas, 17.2; liver, 12.3; kidneys, 10.1; testes/ovaries, 5.6; small intestine, large intestine and heart, 2.1; and spleen, 1.9. By contrast, tissue retention of  $^{14}\text{C}$  from radiolabeled mangafodipir was very low: pancreas, 0.016; liver, 0.045; kidneys, 0.067; testes/ovaries, 0.015; spleen, 0.023; small intestine, 0.012; large intestine, 0.019; heart, 0.017; and brain, 0.009. These data indicate that manganese dissociates from the fodipir moiety after mangafodipir administration and partitions into the tissues listed above.

The tissue distribution of normal and bile-cannulated dogs following administration of [ $^{54}\text{Mn}$ ] or [ $^{14}\text{C}$ ] mangafodipir was also studied (Hustvedt et al. 1997). Doses of 0.55 mg manganese/kg were used except for the normal dogs when the manganese was labeled; the dose in this case was 0.38 mg/kg. The general pattern of distribution of manganese and carbon was similar to that seen with rats, except the concentrations were increased in the dog. The values for normal dogs were taken 168 hours post-dosing for both forms of labeled mangafodipir; the bile-cannulated dogs were analyzed 24 hours post-dosing. The maximum concentration of  $^{54}\text{Mn}$  in the plasma following dosing was 13.1  $\mu\text{g/mL}$  at the end of the infusion period. The plasma concentrations declined rapidly with a terminal half-life of approximately 15 minutes. In the normal dog and bile-cannulated dog, the tissue distribution was as follows (the values for the bile-cannulated dog are given in parentheses; all values are in  $\mu\text{g}$  equivalents of compound/g): liver, 8.7 (79.8); pancreas, 8.1 (2.5); kidneys, 6.6 (37.5); bile, 5.9 (no sample); testes/ovaries, 2.2 (3.2); brain, 0.79 (1.1); spleen, 0.65 (26.6); and heart, 0.62 (3.1). The distribution of labeled carbon in normal (or bile-cannulated dogs) was the following: kidneys, 0.79 (4.1); liver, 0.13 (0.48); bile, 0.059 (no

## 3. HEALTH EFFECTS

sample); testes/ovaries, 0.05 (0.079); pancreas, 0.015 (0.11); heart, 0.015 (0.035); spleen, 0.007 (0.15); and brain, not detected (not detected). These data indicate that in the dog, as in the rat, the manganese cation is retained by the tissues, but the fodipir moiety is not.

Distribution of  $^{54}\text{Mn}$  and  $^{14}\text{C}$  following mangafodipir administration was also studied in the pregnant rat (Hustvedt et al. 1997). Whole-body autoradiography of a section of the rat made at different time points revealed that the kidney had retained the highest amount of labeled manganese; later time points showed a distribution similar to those seen in the rat and dog studies mentioned previously with the pancreas and liver causing the most intense signal upon autoradiography. By 24 hours, fetal livers and bones were clearly seen, but placental radioactivity had decreased substantially. Fat deposits also contained a significant amount of the radioactivity at 24 hours. By contrast, radioactivity from labeled carbon in the mangafodipir was relatively uniformly distributed throughout the pregnant rat at 5 minutes and 1 hour post-dosing, with the highest levels in the kidneys. At 24 hours, virtually all tissues were indistinguishable from background.

The human distribution studies have involved much shorter observation times than the animal studies, with maximal increase in MRI signal in human studies observed in minutes following administration. These studies have shown the liver to accumulate the highest amount of manganese from the administered dose of mangafodipir. This is an important limitation since the brain, the primary target of manganese neurotoxicity, may not accumulate a significant amount of manganese until much later, possibly after the current experiments in humans and animals were truncated. Experiments in rats and dogs, both normal and bile-cannulated, indicate that the brain does not accumulate a significant amount of manganese following administration of mangafodipir at levels much higher than the recommended clinical dose of the agent (Hustvedt et al. 1997), even at 168 hours post-dosing in the dog. Gallez et al. (1997) reported that manganese accumulation in the brain of adult mice following injection of a clinical dose of mangafodipir did not reach maximal levels until 24 hours post-dosing. This would indicate that the human distribution studies were terminated prematurely. However, while brain accumulation of manganese following mangafodipir administration is similar to that from manganese chloride, the manganese is not present after 2 weeks, whereas manganese from the inorganic compound was present, although at a decreased amount, 3 months following dosing (Gallez et al. 1997). These data indicate that single, clinical doses of mangafodipir are not likely to cause persistent accumulation of manganese in the brain.



## 3. HEALTH EFFECTS

**3.4.3 Metabolism**

Manganese is capable of existing in a number of oxidation states, and limited data suggest that manganese may undergo changes in oxidation state within the body. Circumstantial support for this hypothesis comes from the observation that the oxidation state of the manganese ion in several enzymes appears to be Mn(III) (Leach and Lilburn 1978; Utter 1976), while most manganese intake from the environment is either as Mn(II) or Mn(IV) (see Chapter 6). Another line of evidence is based on measurements of manganese in tissues and fluids using electron spin resonance (ESR), which detects the unpaired electrons in Mn(II), Mn(III), and Mn(IV). When animals were injected with manganese chloride, levels of manganese increased in bile and tissues, but only a small portion of this was in a form that gave an ESR signal (Sakurai et al. 1985; Tichy and Cíkr 1972). This suggests that Mn(II) is converted to another oxidation state (probably Mn(III)), but it is also possible that formation of complexes between Mn(II) and biological molecules (bile salts, proteins, nucleotides, etc.) results in loss of the ESR signal without oxidation of the manganese ion.

Evidence by Gibbons et al. (1976) suggests that oxidation of manganese occurs in the body. It was observed that human ceruloplasmin led to the oxidation of Mn(II) to Mn(III) *in vitro*, and although the process was not studied *in vivo*, it is a likely mechanism for manganese oxidation in the blood. These authors also noted that manganese oxidation led to a shift in manganese binding *in vitro* from  $\alpha_2$ -macroglobulin to transferrin and that *in vivo* clearance of Mn(II)- $\alpha_2$ -macroglobulin from cows was much more rapid than the clearance of Mn(III)-transferrin (Gibbons et al. 1976). This suggests that the rate and extent of manganese reduction/oxidation reactions may be important determinants of manganese retention and toxicity in the body.

As demonstrated in a study by Komura and Sakamoto (1991), tissue levels of manganese in rats were affected by the form in which the manganese was administered in the diet; levels of manganese were significantly higher in animals fed manganese acetate or manganese carbonate than in animals fed manganese chloride or manganese dioxide.

Reaney et al. (2006) compared brain concentrations of manganese, dopamine, and gamma amino butyric acid in female retired breeder Long Evans rats exposed to cumulative intraperitoneal doses of 0, 30, or 90 mg manganese/kg of Mn(II) chloride or Mn(III) pyrophosphate. Rats were given intraperitoneal doses of 0, 2, or 6 mg manganese/kg, 3 times/week for 5 weeks. In Mn(III)-treated rats, brain manganese concentrations (analyzed in the striatum, globus pallidus, thalamus, and cerebrum regions) and blood

## 3. HEALTH EFFECTS

concentrations were higher than brain concentrations in Mn(II)-treated rats. The only other marked changes in end points between the two treatment groups was that the highest Mn(III) exposure group showed a 60% increased dopamine level in the globus pallidus (compared with controls), whereas the comparably treated Mn(II) rats showed a 40% decrease in globus pallidus dopamine level. These results suggest that manganese valence state can influence tissue toxicokinetic behavior, and possibly toxicity.

**MMT.** Following intravenous administration in the male rat, MMT was metabolized to hydroxyl-methylcyclopentadienyl manganese tricarbonyl (CMT-CH<sub>2</sub>OH) and carboxycyclopentadienyl manganese tricarbonyl (CMT-COOH), both of which are present in urine (Hanzlik et al. 1980a). Metabolites are also present in the bile, as indicated by the fecal recovery of <sup>3</sup>H from the ring structure in MMT following intravenous or intraperitoneal administration of radiolabeled compound to rats (Hanzlik et al. 1980a, 1980b). After intravenous dosing of MMT in rats, 11% of the radiolabel was recovered in feces within 30 minutes (Hanzlik et al. 1980b). These metabolites have not been characterized; however, the administration of phenobarbital to the rat doubled the biliary excretion of the metabolite (Hanzlik et al. 1980a).

*In vitro* studies showed that rat liver microsomes activated with NADPH and molecular oxygen metabolized MMT (Hanzlik et al. 1980b). Preliminary studies with pooled liver microsomes from 5 to 6 normal or phenobarbital-induced rats showed that reaction rates of metabolism were linear for the first 20 minutes. MMT and aminopyrine, a positive control compound that is metabolized exclusively by cytochrome P450, showed parallel responses to changes in incubation conditions (i.e., NADPH dependence, inhibition by carbon monoxide, induction by phenobarbital). Liver microsomes metabolized MMT with an estimated K<sub>M</sub> of 78 μM and a V<sub>max</sub> of 3.12 nmol/mg protein/minute. When the studies were done with liver microsomes from phenobarbital-treated rats, the K<sub>M</sub> remained the same, but the V<sub>max</sub> doubled (Hanzlik et al. 1980b). Lung microsomes were equally capable of metabolizing MMT, but phenobarbital induction did not enhance the response.

In humans, an infusion of the clinical dose of MnDPDP (5 μmol/kg or 0.25 mg/kg) is rapidly dephosphorylated to manganese dipyridoxyl monophosphate (MnDPMP). This metabolite has been measured in human blood as quickly as 18 minutes after the beginning of infusion of the contrast agent, and is still measurable 1.3 hours after the start of the infusion (Toft et al. 1997a). MnDPMP was not observed in the blood after the first 18 minutes. The monophosphate is then fully dephosphorylated to manganese dipyridoxyl ethylenediamine (MnPLED); this compound has been isolated in blood from 18 minutes after the start of an infusion until 40 minutes after the start. Transmetallation of either

## 3. HEALTH EFFECTS

MnDPDP, MnDPMP, or MnPLED with zinc can occur, forming ZnDPDP, ZnDPMP, or ZnPLED. ZnDPDP has been identified in the bloodstream during the first 18 minutes of an infusion of 0.25 mg manganese/kg as MnDPDP. ZnDPMP has been detected in the blood from 18 to 40 minutes following the start of the infusion, and ZnPLED has been measured in the blood from 18 minutes to 8.33 hours following the start of the infusion. The major metabolite detected in urine was ZnPLED (Toft et al. 1997a). Figure 3-4 depicts the metabolism of mangafodipir in the human.

To study mangafodipir metabolism in the dog, Toft et al. (1997c) injected three male and female beagles with 0.55, 1.7, or 5.5 mg manganese/kg and took timed blood samples post-dosing to analyze for the presence of metabolites. Mangafodipir was rapidly metabolized by dephosphorylation and transmetallation at all three doses. After infusion with 0.55 mg/kg, MnPLED was the primary metabolite observed in the bloodstream 1 minute after the end of the infusion period, and MnDPDP was present at a concentration lower than the five metabolites. At 30 minutes post-dosing, ZnPLED was the main metabolite. However, at 5.5 mg/kg, MnPLED was the main metabolite at all sampling times (1, 5, and 30 minutes). The authors estimated that the ratios of manganese metabolites to zinc metabolites were 1, 2, and 3.5 at doses of 0.55, 1.7, or 5.5 mg manganese/kg, respectively; these data are consistent with the authors' hypothesis that the limited availability of free or loosely bound plasma zinc governs the initial transmetallation reaction (Toft et al. 1997c).

*In vitro* experiments with radiolabeled MnDPDP and whole blood or plasma from human donors indicate that mangafodipir undergoes a rapid transmetallation with zinc that is nearly complete within 1 minute after the start of incubation, followed by a relatively slow dephosphorylation process. The primary metabolite after a 90-minute incubation of whole blood with MnDPDP was MnDPMP, followed by CaDPDP/DPDP, Mn(III)DPDP (suggested as an artifact due to high pH and oxygen), and MnPLED. Experiments using <sup>14</sup>C-DPDP indicate that this chelate cannot enter red blood cells; therefore, the zinc contained within the cells is unavailable for binding to this compound. Binding of manganese ion to serum proteins was observed as well, indicating that dissociation of the metal from the chelate had occurred during incubation (Toft et al. 1997b).

#### 3.4.4 Elimination and Excretion

In humans, absorbed manganese is removed from the blood by the liver where it conjugates with bile and is excreted into the intestine. Biliary secretion is the main pathway by which manganese reaches the intestines where most of the element is excreted in the feces (Bertinchamps et al. 1965; Davis et al. 1993;

## 3. HEALTH EFFECTS

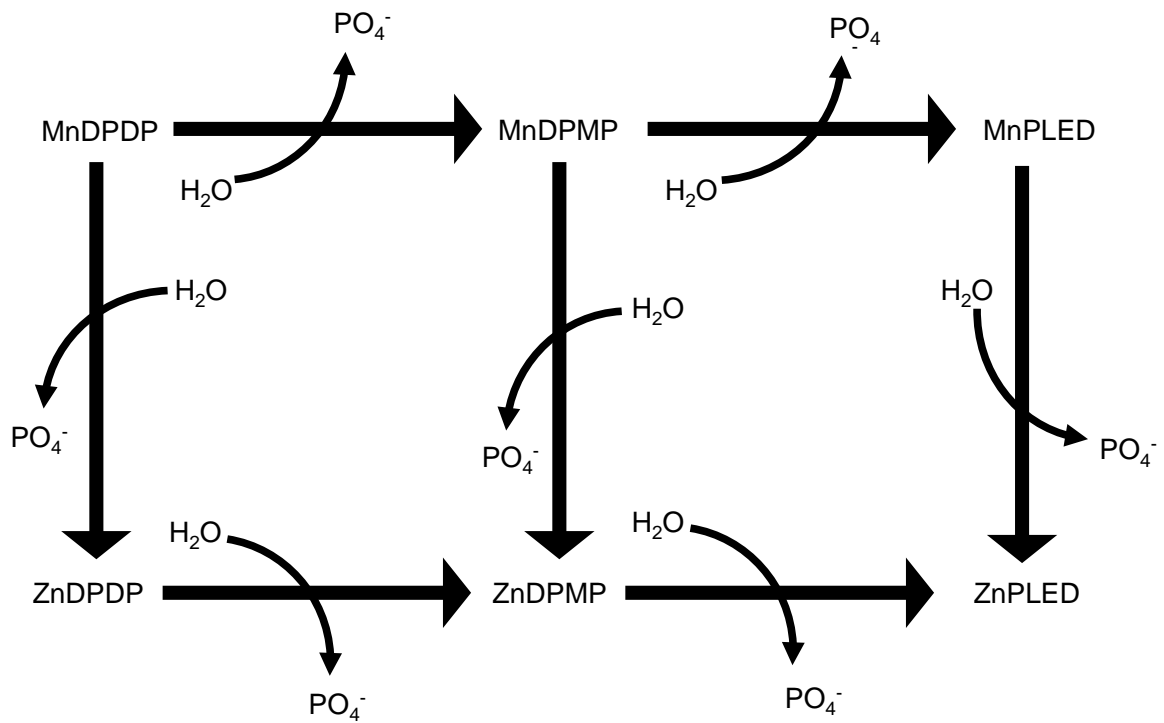
**Figure 3-4. Metabolism of MnDPDP**

Source: Toft et al. 1997c

## 3. HEALTH EFFECTS

Malecki et al. 1996). However, some of the manganese in the intestine is reabsorbed through enterohepatic circulation (Schroeder et al. 1966).

Small amounts of manganese can also be found in urine, sweat, and milk (EPA 1993b). Urinary excretion of manganese by healthy males was 7.0 nmole/g creatinine (7.0 nmole=385 ng=0.385 µg) (Greger et al. 1990). Similarly, urinary manganese excretion by women was 9.3 nmole/day. Moreover, urinary excretion of manganese was not responsive to oral intake of manganese (Davis and Greger 1992). Dorner et al. (1989) showed that some infants fed breast milk and formula suffered negative manganese balances due to high fecal excretion. However, animal studies indicate that in the young, excretion is not well-developed and may result in increased retention of the element. For example, in mice, rats, and kittens, there is an almost complete absence of excretion during the neonatal period (Cotzias et al. 1976). However, data in neonatal rats indicate that manganese retention rates decrease to rates observed in adult animals. This is indirect evidence that excretion may mature during the end of the neonatal period though the exact time frame across species is unknown.

#### 3.4.4.1 Inhalation Exposure

In humans who inhaled manganese chloride or manganese tetroxide, about 60% of the material originally deposited in the lung was excreted in the feces within 4 days (Mena et al. 1969). Chronically exposed male workers were reported to have urine manganese levels that were significantly higher than unexposed persons; for example, male foundry workers had a mean manganese level of 5.7 µg/L compared to 0.7 µg/L in unexposed controls (Alessio et al. 1989). Other studies have reported significantly increased levels of urinary manganese in men occupationally exposed to airborne manganese dusts and fumes (Lucchini et al. 1995; Roels et al. 1987a, 1992). Mergler et al. (1994) did not report a significant difference in urinary manganese levels between the exposed and control groups in their occupational study. The differences in urinary excretion may be due to differences in duration or extent of exposure. A listing of these occupational studies that measured exposure levels of manganese and the resultant levels of the metal in biological samples is provided in Table 3-13.

Rats exposed to either manganese chloride or manganese tetroxide by intratracheal instillation excreted about 50% of the dose in the feces within 3–7 days (Drown et al. 1986). Monkeys exposed to an aerosol of <sup>54</sup>MnCl<sub>2</sub> excreted most of the manganese, with a half-time of 0.2–0.36 days (Newland et al. 1987). However, a portion of the compound was retained in the lung and brain. Clearance of this label was slower, occurring with half-times of 12–250 days. These data do not provide information on how much

## 3. HEALTH EFFECTS

**Table 3-13. Levels of Manganese in Exposed and Non-Exposed Workers**

| Occupational study     | Mean age (years) | Mn in air (mg/m <sup>3</sup> )          | Biological samples                          |                                       |
|------------------------|------------------|---|---|---------------------------------------|
|                        |                  |   | Mn-blood µg/100 mL                          | Mn-urine µg/g creatinine              |
| Roels et al. (1987b)   |                  |   |   |                                       |
| Exposed                | 34.3±9.6         | 0.97 <sup>a</sup> (total dust)          | 1.36 <sup>b</sup> ±0.64 (1.22) <sup>c</sup> | 4.76 <sup>b</sup> (0.4) <sup>c</sup>  |
| Non-exposed            | 38.4±11.3        |   | 0.57 <sup>b</sup> ±0.27 (1.59) <sup>c</sup> | 0.30 <sup>b</sup> (0.15) <sup>c</sup> |
| Roels et al. (1992)    |                  |   |   |                                       |
| Exposed                | 31.3±7.4         | 0.179 <sup>a</sup> (respirable dust)    | 0.81 <sup>c</sup>                           | 0.84 <sup>c</sup>                     |
| Non-exposed            | 29.3±8.0         |   | 0.68 <sup>c</sup>                           | 0.09 <sup>c</sup>                     |
| Chia et al. (1993a)    |                  |   |   |                                       |
| Exposed                | 36.6±12.2        | 1.59 <sup>b</sup> (total dust)          | 2.53 <sup>c</sup>                           | 6.1 <sup>c</sup> (µg/L)               |
| Non-exposed            | 35.7±12.1        |   | 2.33 <sup>c</sup>                           | 3.9 <sup>c</sup> (µg/L)               |
| Mergler et al. (1994)  |                  |   |   |                                       |
| Exposed                | 43.4±5.4         | 0.032 <sup>a</sup> (respirable dust)    | 1.12 <sup>b</sup> (1.03) <sup>c</sup>       | 1.07 <sup>b</sup> (0.73) <sup>c</sup> |
| Non-exposed            | 43.2±5.6         |   | 0.72 <sup>b</sup> (0.68) <sup>c</sup>       | 1.05 (0.62) <sup>c</sup>              |
| Lucchini et al. (1999) |                  |   |   |                                       |
| Exposed                | 42.1±8.3         | 0.0967 (respirable dust)<br>(CEI/years) | 0.97 <sup>b</sup> (0.92) <sup>c</sup>       | 1.81 <sup>b</sup> (1.53) <sup>c</sup> |
| Non-exposed            | 42.6±8.8         |   | 0.6 <sup>b</sup> (0.57) <sup>c</sup>        | 0.67 <sup>b</sup> (0.40) <sup>c</sup> |

<sup>a</sup>Median<sup>b</sup>Arithmetic mean<sup>c</sup>Geometric mean

CEI = cumulative exposure index

### 3. HEALTH EFFECTS

of the manganese excreted in the feces after inhalation exposure was first absorbed and then excreted via the bile versus the amount simply transported directly from the lung to the gastrointestinal tract where it may have been absorbed. In addition, because these investigators measured manganese using gamma spectrometry techniques, the relatively long elimination half-times from the brain may have been influenced by manganese present in skull bones. In monkeys exposed to 1.5 mg manganese/m<sup>3</sup> manganese sulfate for 65 days, manganese concentrations were elevated (compared with air control values) in many brain regions and other tissues; 45 days following cessation of exposure, concentrations remained elevated in the olfactory cortex, globus pallidus, putamen, pituitary gland, and blood, but returned to air control values by 90 days after exposure (Dorman et al. 2006a). Based on these data, Dorman et al. (2006a) calculated elimination half-lives of about 15–16 days for the globus pallidus and putamen, suspected neurotoxicity targets of manganese.

Rat studies have demonstrated that urinary excretion of manganese 1 day following inhalation exposure was increased 200- and 30-fold when the animals were treated with the chelating agents 1,2-cyclohexylene-aminetetraacetic acid (CDTA) and diethylene triamine pentaacetic acid (DTPA), respectively, but fecal excretion was not altered (Wieczorek and Oberdörster 1989b).

No studies were located regarding excretion of manganese in either humans or animals following inhalation exposure to organic manganese.

#### 3.4.4.2 Oral Exposure

Humans who ingested tracer levels of radioactive manganese (usually as manganese chloride) excreted the manganese with whole-body retention half-times of 13–37 days (Davidsson et al. 1989a; Mena et al. 1969; Sandstrom et al. 1986). The route of manganese loss was not documented, but was presumed to be mainly fecal after biliary excretion. Serum manganese concentrations in a group of healthy men and women in Wisconsin were 1.06 and 0.86 µg/L, respectively (Davis and Greger 1992; Greger et al. 1990). Urinary excretion of manganese by men was 7.0 nmole/g creatinine (Greger et al. 1990). Similarly, urinary manganese excretion of women was 9.3 nmole/day. Moreover, urinary excretion of manganese was not responsive to oral intake of manganese (Davis and Greger 1992).

In a more recent study, young rats fed 45 mg manganese/kg/day were found to absorb 8.2% of the manganese ingested and to lose approximately 37% of the absorbed manganese through endogenous gut secretions (Davis et al. 1993).

### 3. HEALTH EFFECTS

The daily excretion of manganese from mice ingesting 11 mg manganese/kg as MMT in their daily diet was 5.4% of their daily intake (Komura and Sakamoto 1992b). In a comparison of plasma manganese kinetics following oral administration of MMT or manganese chloride in male rats, MMT-derived manganese was eliminated extremely slowly, having an average elimination half-time of 55.2 hours, compared with 4.56 hours for manganese chloride (Zheng et al. 2000). Rats receiving MMT showed an apparent oral clearance (CL/F) of  $0.09 \text{ L}\cdot\text{hours}^{-1}\cdot\text{kg}^{-1}$ , which was about 37-fold less than the oral clearance of manganese chloride ( $\text{CL/F} = 3.2 \text{ L}\cdot\text{hours}^{-1}\cdot\text{kg}^{-1}$ ). Accordingly, the AUC in MMT rats was about 37-fold higher than that in manganese chloride rats who received equivalent dose of manganese. A gender difference in manganese toxicokinetics following oral MMT exposure was also observed; female rats showed higher mean AUC and longer half times of plasma manganese than male rats (93.1 versus 51.8 mM hours and 68.4 versus 42.0 hours, respectively (Zheng et al. 2000).

No other studies were located regarding excretion of manganese from organic manganese compounds in either humans or animals.

#### **3.4.4.3 Dermal Exposure**

No studies were located regarding excretion of inorganic or organic manganese in humans or animals after dermal exposure to manganese.

#### **3.4.4.4 Other Routes of Exposure**

No studies were located regarding excretion of manganese by humans after exposure to inorganic manganese via other routes of exposure.

Rats exposed to manganese chloride by intravenous injection excreted 50% of the dose in the feces within 1 day (Klaassen 1974) and 85% by day 23 (Dastur et al. 1971), indicating that biliary excretion is the main route of manganese clearance. Only minimal levels were excreted in urine (<0.1% of the dose within 5 days) (Klaassen 1974). Direct measurement of manganese levels in bile revealed concentrations up to 150-fold higher than in plasma, indicating the existence of either an active transport system (Klaassen 1974) or some sort of trapping mechanism (Tichy and Cikrt 1972). Based on the difference in blood levels following portal or femoral injection, Thompson and Klaassen (1982) estimated that about 33% of the manganese burden in blood is removed in each pass through the liver. Apparently, some



### 3. HEALTH EFFECTS

manganese can cross directly from the blood to the bile (Bertinchamps et al. 1965; Thompson and Klaassen 1982), but most appears to be secreted into the bile via the liver (Bertinchamps et al. 1965).

The chemical state of manganese in bile is not known, but a considerable fraction is bound to bile components (Tichy and Cikrt 1972). This material is apparently subject to enterohepatic recirculation, since biliary manganese is reabsorbed from the intestine more efficiently than free Mn(II) (Klaassen 1974). The amount of manganese that contributes to total body burden following reabsorption from enterohepatic recirculation is not known.

While biliary secretion appears to be the main pathway by which manganese is excreted into the intestines, direct transport from blood across the intestinal wall may also occur (Bertinchamps et al. 1965; Garcia-Aranda et al. 1984). The relative amount of total excretion attributable to this pathway was not quantified by Bertinchamps, but it appears to be only a fraction of that attributable to biliary secretion (Bertinchamps et al. 1965).

Manganese originating from mangafodipir administered at clinical (0.25 mg/kg) and more than twice the clinical dose (0.55 mg/kg) is primarily excreted in the feces via the bile in both humans and animals (Grant et al. 1994; Hustvedt et al. 1997; Toft et al. 1997a; Wang et al. 1997). In contrast to the chelate, DPDP, manganese is incompletely cleared from the body 24 hours after administration, and roughly 7–8% of a dose is still retained in the body after 1 week (Hustvedt et al. 1997).

#### **3.4.5 Physiologically Based Pharmacokinetic (PBPK)/Pharmacodynamic (PD) Models**

Physiologically based pharmacokinetic (PBPK) models use mathematical descriptions of the uptake and disposition of chemical substances to quantitatively describe the relationships among critical biological processes (Krishnan et al. 1994). PBPK models are also called biologically based tissue dosimetry models. PBPK models are increasingly used in risk assessments, primarily to predict the concentration of potentially toxic moieties of a chemical that will be delivered to any given target tissue following various combinations of route, dose level, and test species (Clewell and Andersen 1985). Physiologically based pharmacodynamic (PBPD) models use mathematical descriptions of the dose-response function to quantitatively describe the relationship between target tissue dose and toxic end points.

PBPK/PD models refine our understanding of complex quantitative dose behaviors by helping to delineate and characterize the relationships between: (1) the external/exposure concentration and target

## 3. HEALTH EFFECTS

tissue dose of the toxic moiety, and (2) the target tissue dose and observed responses (Andersen and Krishnan 1994; Andersen et al. 1987). These models are biologically and mechanistically based and can be used to extrapolate the pharmacokinetic behavior of chemical substances from high to low dose, from route to route, between species, and between subpopulations within a species. The biological basis of PBPK models results in more meaningful extrapolations than those generated with the more conventional use of uncertainty factors.

The PBPK model for a chemical substance is developed in four interconnected steps: (1) model representation, (2) model parameterization, (3) model simulation, and (4) model validation (Krishnan and Andersen 1994). In the early 1990s, validated PBPK models were developed for a number of toxicologically important chemical substances, both volatile and nonvolatile (Krishnan and Andersen 1994; Leung 1993). PBPK models for a particular substance require estimates of the chemical substance-specific physicochemical parameters, and species-specific physiological and biological parameters. The numerical estimates of these model parameters are incorporated within a set of differential and algebraic equations that describe the pharmacokinetic processes. Solving these differential and algebraic equations provides the predictions of tissue dose. Computers then provide process simulations based on these solutions.

The structure and mathematical expressions used in PBPK models significantly simplify the true complexities of biological systems. If the uptake and disposition of the chemical substance(s) are adequately described, however, this simplification is desirable because data are often unavailable for many biological processes. A simplified scheme reduces the magnitude of cumulative uncertainty. The adequacy of the model is, therefore, of great importance, and model validation is essential to the use of PBPK models in risk assessment.

PBPK models improve the pharmacokinetic extrapolations used in risk assessments that identify the maximal (i.e., the safe) levels for human exposure to chemical substances (Andersen and Krishnan 1994). PBPK models provide a scientifically sound means to predict the target tissue dose of chemicals in humans who are exposed to environmental levels (for example, levels that might occur at hazardous waste sites) based on the results of studies where doses were higher or were administered in different species. Figure 3-5 shows a conceptualized representation of a PBPK model.

## 3. HEALTH EFFECTS

**Figure 3-5. Conceptual Representation of a Physiologically Based Pharmacokinetic (PBPK) Model for a Hypothetical Chemical Substance**

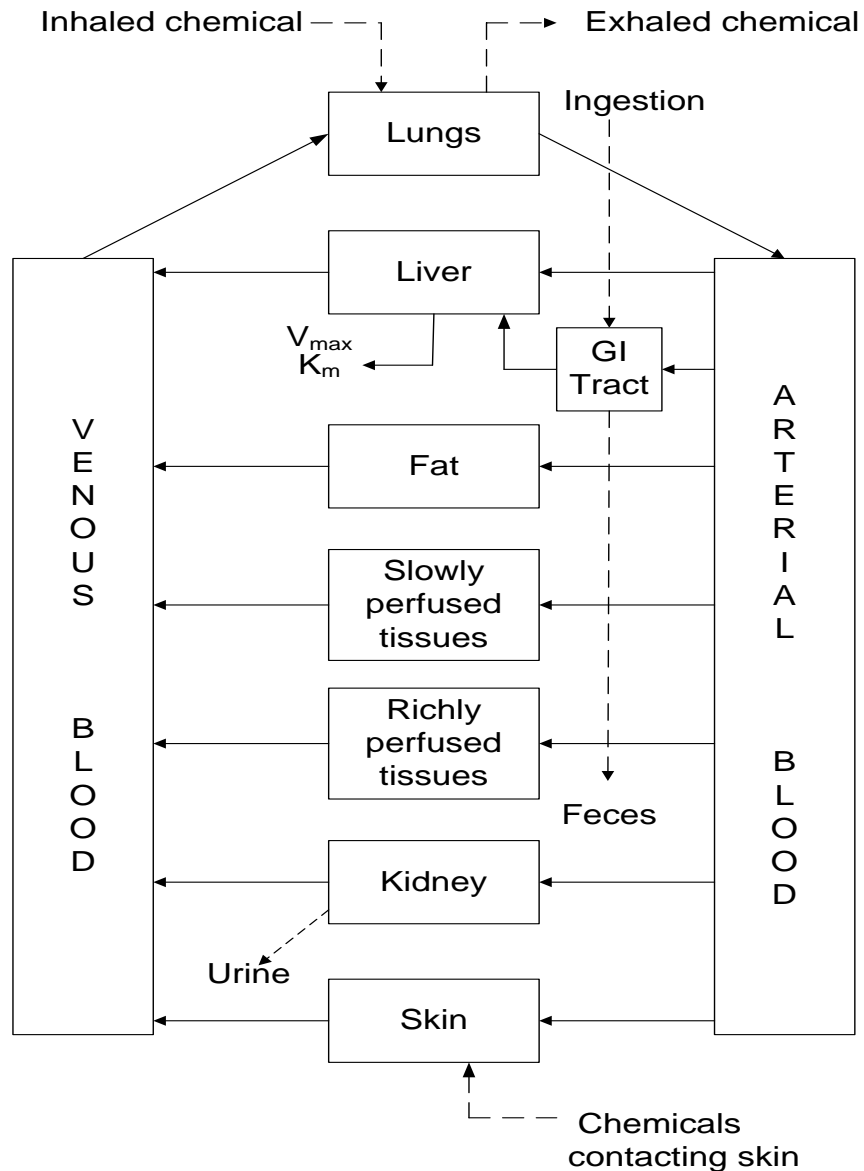

Note: This is a conceptual representation of a physiologically based pharmacokinetic (PBPK) model for a hypothetical chemical substance. The chemical substance is shown to be absorbed via the skin, by inhalation, or by ingestion, metabolized in the liver, and excreted in the urine or by exhalation.

Source: adapted from Krishnan and Andersen 1994

## 3. HEALTH EFFECTS

If PBPK models for manganese exist, the overall results and individual models are discussed in this section in terms of their use in risk assessment, tissue dosimetry, and dose, route, and species extrapolations.

PBPK models for manganese are discussed below.

No PBPK models have been developed for manganese in humans, but several recent reports are available on the development of models for manganese in rats.

***Initial Conceptual PBPK Model for Manganese (Andersen et al. 1999).*** A qualitative PBPK model for manganese disposition in humans and animals was initially developed by Andersen et al. (1999). This model represented the current understanding of manganese nutrition and toxicology, and because several data gaps existed concerning manganese pharmacokinetics, this model is anticipated to change with time (Andersen et al. 1999). The model, shown in Figure 3-6, was not designed to be quantitative in nature. The authors indicated that several data gaps prevented such an evaluation of manganese uptake, distribution, and excretion. For instance, there were inadequate data concerning oxidation rates for manganese in blood, uptake rates of protein-bound forms by the liver, neuronal transfer rates within the central nervous system, and quantitative data on systems controlling manganese uptake via the intestines and liver (such as transport mechanism in the intestines) (Andersen et al. 1999). Andersen et al. (1999) suggested that an approach to setting acceptable exposure levels for an essential, but neurotoxic, nutrient such as manganese could be based on predicting exposure levels by any route that would increase brain manganese concentrations to a small fraction (e.g., 10–25%) of the variation observed in the general human population. Reliable and validated multiple-route PBPK models for multiple species, including humans, are needed to take this approach to setting acceptable exposure levels. Efforts to develop such models in rats have been recently described (Leavens et al. 2007; Nong et al. 2008; Teeguarden et al. 2007a, 2007b, 2007c).

***Whole-Body PBPK Models (Nong et al. 2008; Teeguarden et al. 2007a, 2007b, 2007c).*** Utilizing pharmacokinetic and tissue manganese concentration data from several published studies of manganese in rats and mice, recent efforts have developed PBPK models for manganese in rats that include processes involved in homeostatic regulation of tissue levels of manganese taken up by ingestion and by inhalation (Nong et al. 2008; Teeguarden et al. 2007a, 2007b, 2007c). Two PBPK model structures were developed and evaluated for their ability to account for kinetics of manganese in the liver and brain striatum following inhalation and dietary administration of soluble forms of inorganic manganese. The data sets

3. HEALTH EFFECTS

Figure 3-6. Qualitative PBPK Model for Manganese

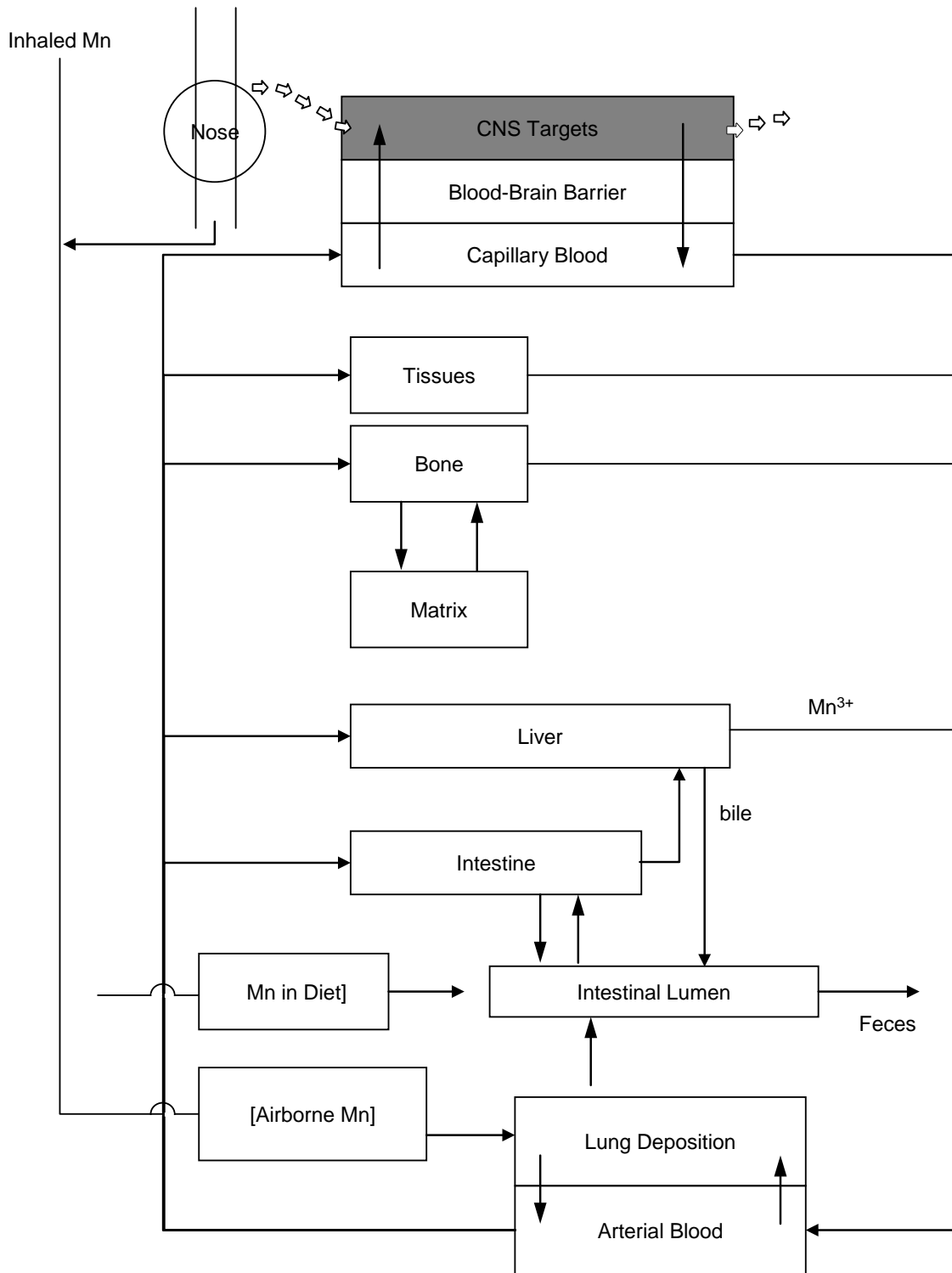

Source: Andersen et al. 1999

## 3. HEALTH EFFECTS

used to evaluate the models were: (1) tissue manganese concentrations in rats receiving diets containing 2, 10, or 100 ppm manganese for 13 weeks and elimination kinetics for an intravenous tracer dose of  $^{54}\text{Mn}$ -manganese chloride (Dorman et al. 2001b); (2) tissue manganese concentrations and tracer kinetics in rats fed a 100-ppm diet and exposed to 0, 0.03, 0.3 or 3 mg manganese/m<sup>3</sup> manganese sulfate 6 hours/day for 14 consecutive days (Dorman et al. 2001a); and (3) tissue manganese concentrations (sampled at 0, 45, and 90 days after exposure) in rats fed a 10-ppm diet and exposed to 0, 0.1 or 0.5 mg manganese/m<sup>3</sup> for 6 hours/day, 5 days/week for 90 days (Dorman et al. 2004b).

Structures of the models are shown in Figure 3-7. Model A is based on regulation of tissue concentrations by simple partitioning with slow inter-compartmental transfer from free manganese in tissues to deeper tissue stores of manganese (“diffusion-controlled tissue partitioning”; Nong et al. 2008; Teeguarden et al. 2007a, 2007b, 2007c). Model B features saturable binding of manganese in liver and brain with equilibrium binding constants defined by slow association and dissociation rate constants (Nong et al. 2008). Both models contain a submodel for deposition and absorption in the nose and lung shown schematically in Figure 3-8 (Teeguarden et al. 2007c).

***Nong et al. (2008) Model A Description and Development.*** Model A contains six compartments: the respiratory tract, brain striatum, liver, kidneys, bone, and slowly perfused tissues (Figure 3-7). The respiratory tract is divided into two subcompartments: nasopharyngeal tissues and lung (Figure 3-8). Table 3-14 lists parameters of Model A as described by Teeguarden et al. (2007c). Each of the six compartments is subdivided into a conventional flow-limited compartment connected to the blood and tissue stores that are not readily equilibrated with blood moving through the tissue compartment. First-order clearance rate constants (e.g.,  $k_{\text{InBrnC}}$  and  $k_{\text{outBrnC}}$ ) determine the transfer of manganese from the flow-limited compartment to the deep compartment of each tissue. The clearance rate constants, together with the blood flow to the tissue (e.g.,  $Q_{\text{BrnC}}$ ) and the tissue partition coefficients (e.g.,  $P_{\text{Brn}}$ ), determine the steady-state concentrations and the rate of change manganese in each of the tissues, according to differential equations that are described in detail by Teeguarden et al. (2007c).

Physiological parameters were taken from the literature and included values for blood flows, organ volumes, and food intake rate (Table 3-14). The initial (basal) concentrations of manganese in the tissues (Table 3-14) were taken from literature values as described by Teeguarden et al. (2007c). Remaining model parameters were estimated by fitting the model to experimental data. Fractions of manganese in the shallow versus deep compartments of each tissue (e.g.,  $f_{\text{Brn}}$  and  $F_{\text{DBrn}}$ , Table 3-14) were calibrated to obtain the best fit to intraperitoneal  $^{54}\text{Mn}$  clearance data collected by Furchner et al. (1966). Partition

3. HEALTH EFFECTS

**Figure 3-7. Schematic Structures of Nong et al. (2008) PBPK Models A and B for Manganese in CD Rats\***

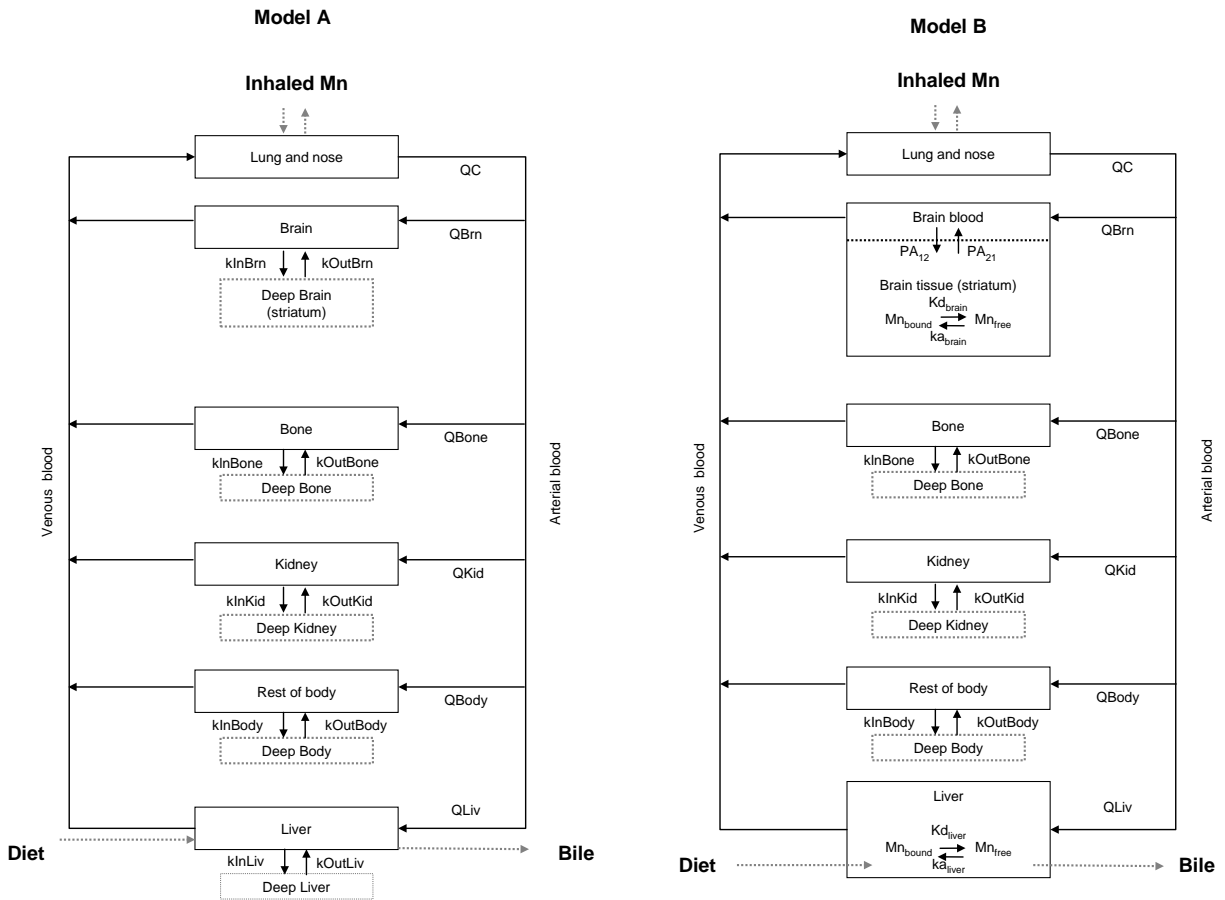

\*Values and descriptions of model parameters are in Tables 3-14, 3-15, and 3-16.

Source: Nong et al. 2008

## 3. HEALTH EFFECTS

**Figure 3-8. Schematic of Models for Nasopharyngeal and Lung Deposition of Manganese and Transport to Blood in the Nong et al. (2008) PBPK Models A and B for Manganese in CD Rats**

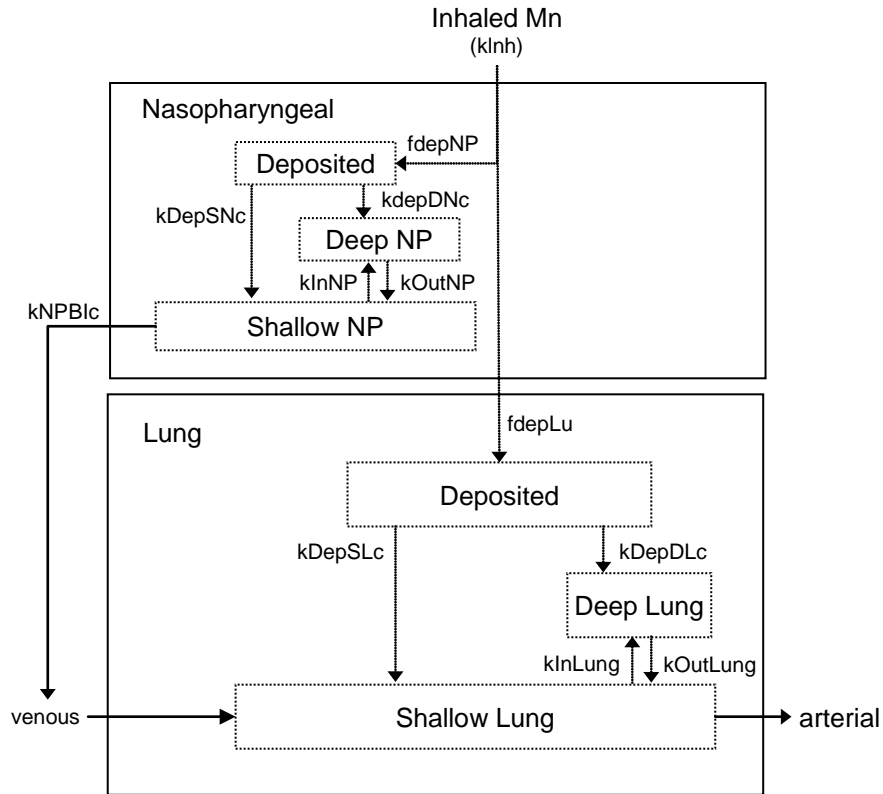

Source: Teeguarden et al. 2007c



## 3. HEALTH EFFECTS

**Table 3-14. Parameter Values in the Teeguarden et al. (2007c) PBPK Model for Manganese in CD Rats (Nong et al. 2008) Model A**

| Parameter                                |   | Value <sup>a</sup> |
|--|---|--------------------|
| BW                                       | Body weight (kg)                              | 0.325 <sup>b</sup> |
| QCC                                      | Cardiac output (L/hour for 1-kg animal)       | 14.6               |
| QPC                                      | Alveolar ventilation (L/hour for 1-kg animal) | 30.0               |
| Blood flows (fraction of cardiac output) |   |                    |
| QSlowC                                   | Slow  | 0.534              |
| QBoneC                                   | Bone  | 0.122              |
| QBrnC                                    | Brain   | 0.02               |
| QKidC                                    | Kidneys                                       | 0.141              |
| QLivC                                    | Liver   | 0.183              |
| Tissue volumes (fraction of body weight) |   |                    |
| VArtC                                    | Arterial blood                                | 0.0224             |
| VBldC                                    | Blood   | 0.0676             |
| VSlowC                                   | Slow  | 0.738              |
| VBoneC                                   | Bone  | 0.021              |
| VDBoneC                                  | Bone deep compartment                         | 0.052              |
| VBrnC                                    | Brain   | 0.006              |
| VKidC                                    | Kidneys                                       | 0.007              |
| VLivC                                    | Liver   | 0.034              |
| VLungC                                   | Lung  | 0.007              |
| VNasPhaC <sup>c</sup>                    | Nasopharyngeal                                | 0.0038             |
| VTraBroC <sup>c</sup>                    | Tracheobronchial                              | 0.01107            |
| VPulmonC                                 | Pulmonary                                     | 0.01107            |
| VVenC                                    | Venous blood                                  | 0.0452             |
| Partition coefficients                   |   |                    |
| Pslow                                    | Slow  | 0.4                |
| PBone                                    | Bone  | 30                 |
| PBrn                                     | Brain   | 0.1                |
| PKid                                     | Kidneys                                       | 1.25               |
| PLiv                                     | Liver   | 5.0                |
| PLung                                    | Lung  | 0.3                |
| Pnaspha                                  | Nasopharyngeal                                | 0.3                |
| Clearance rates                          |   |                    |
| kBileOC                                  | Biliary excretion (L/hour-kg body weight)     | 2.0                |
| kFeces                                   | Loss in feces (L/hour-kg body weight)         | 0.0001             |
| Clearance rates (/h)                     |   |                    |
| kInSlowC                                 | Into deep slow compartment                    | 0.017              |
| kInBoneC                                 | Into deep bone compartment                    | 0.105              |
| kInBrnC                                  | Into deep brain compartment                   | 0.011              |
| kInKidC                                  | Into deep kidney compartment                  | 0.146              |

## 3. HEALTH EFFECTS

**Table 3-14. Parameter Values in the Teeguarden et al. (2007c) PBPK Model for Manganese in CD Rats (Nong et al. 2008) Model A**

| Parameter  |                                      | Value <sup>a</sup> |
|--|--------------------------------------|--------------------|
| kInLivC  | Into deep liver compartment          | 0.621              |
| kInNPC   | Into deep nose compartment           | 0.035              |
| kInLungC   | Into deep lung compartment           | 0.035              |
| kOutSlowC  | Out of deep slow                     | 0.0035             |
| kOutBoneC  | Out of deep bone                     | 0.00085            |
| kOutBrnC   | Out of deep brain                    | 0.00056            |
| kOutKidC   | Out of deep kidneys                  | 0.0034             |
| kOutLivC   | Out of deep liver                    | 0.007              |
| kOutNPC  | Out of deep nose                     | 0.0035             |
| kOutLungC  | Out of deep lung                     | 0.0035             |
| Initial concentrations of manganese (µg/L)   |                                      |                    |
| CArt0  | Arterial blood                       | 10.0               |
| CBld0  | Blood                                | 10.0               |
| CSlow0   | Slow                                 | 110.0              |
| CDSlow0  | Deep slow                            | 110.0              |
| CBone0   | Bone                                 | 650.0              |
| CDBone0  | Deep bone compartment                | 650.0              |
| CBrn0  | Brain                                | 450.0              |
| CDBrn0   | Deep brain                           | 450.0              |
| CKid0  | Kidneys                              | 1000.0             |
| CDKid0   | Deep kidneys                         | 1000.0             |
| CLiv0  | Liver                                | 2600.0             |
| CDLiv0   | Deep liver                           | 2600.0             |
| CLung0   | Lung                                 | 250.0              |
| CDLung0  | Deep lung                            | 250.0              |
| CNose0   | Nose                                 | 0.0                |
| CDNose   | Deep nose                            | 0.0                |
| CVen0  | Venous blood                         | 10.0               |
| Fractional coefficients  |                                      |                    |
| fDepNP <sup>c</sup>  | Particles deposited nasopharyngeal   | 0.2                |
| fDepTB <sup>c</sup>  | Particles deposited tracheobronchial | 0.21               |
| fDepPu <sup>c</sup>  | Particles deposited pulmonary        | 0.07               |
| Fraction of manganese in shallow versus deep tissue <sup>d</sup><br>(ratios of volumes; not separately estimated model parameters) |                                      |                    |
| fSlow  | Slow                                 | 0.5                |
| fDSlow   | Deep slow                            | 0.5                |
| fBrn   | Brain                                | 0.05               |
| fDBrn  | Deep brain                           | 0.95               |
| fKid   | Kidneys                              | 0.25               |
| fDKid  | Deep kidneys                         | 0.75               |

## 3. HEALTH EFFECTS

**Table 3-14. Parameter Values in the Teeguarden et al. (2007c) PBPK Model for Manganese in CD Rats (Nong et al. 2008) Model A**

| Parameter         |  | Value <sup>a</sup> |
|-------------------|--|--------------------|
| fLiv              | Liver  | 0.4                |
| fDLiv             | Deep liver                                     | 0.6                |
| fLung             | Lung   | 0.1                |
| fDLung            | Deep lung                                      | 0.9                |
| FDNose            | Deep nose                                      | 0.9                |
| fDBody            | Body   | 0.5                |
| Dosing parameters |  |                    |
| InFac1            | Dietary intake factor for first diet           | 0.05               |
| FDietUp           | Fraction of manganese in diet that is absorbed | 0.008              |

<sup>a</sup>Physiological parameters are consistent with those reported by Brown et al. (1997). Rate constants were fit to available experimental data on the kinetics of Mn in the various tissues. Rate constants fitted to the control steady-state Mn tissue concentrations reported by Furchner et al. (1966) and used to simulate ip and inhalation experiments are shown.

<sup>b</sup>Default body weight. Some body weights were lower (0.25) to represent study conditions.

<sup>c</sup>The deposition lung region of the lung is the sum of the tracheobronchial and pulmonary tissue ( $f_{DepLu} = f_{DepTB} + f_{DepPu}$ ;  $V_{DepLuC} = V_{TraBroC} + V_{PulmonC}$ ).

<sup>d</sup>This fraction is not an independently estimated variable. Instead, the fraction represents the ratio of the two rate constants,  $k_{in}$  and  $k_{out}$ , for each tissue.

Source: Teeguarden et al. 2007c

## 3. HEALTH EFFECTS

coefficients (e.g.,  $P_{Brn}$ , Table 3-14) and clearance rate constants into and out of deep compartments (e.g.,  $k_{InBrnC}$ ,  $k_{OutBrnC}$ ) were calibrated with  $^{54}\text{Mn}$  kinetic data collected by Furchner et al. (1966) and steady-state tissue manganese concentration data collected by Wieczorek and Oberdörster (1989c). The fraction of manganese absorbed from the gut ( $F_{DietUp}$ ) was assumed to be 0.8%. The rate of biliary excretion from liver ( $k_{Bile0C}$ ) was determined by matching the rate of manganese excreted from liver against the amount of manganese taken up from the diet, while maintaining steady-state levels of manganese in all tissues and matching the turnover of  $^{54}\text{Mn}$  for each tissue (Teeguarden et al. 2007c). For inhaled manganese, fractional depositions in the nasopharyngeal ( $f_{DepNP} = 0.2$ ), tracheobronchial ( $f_{DepTB} = 0.21$ ), and pulmonary ( $f_{Deppu} = 0.07$ ) regions were taken from the EPA (1994a) respiratory tract deposition model for 1.1- $\mu\text{m}$  aerosols. The model assumed that deposited aerosols dissolved immediately and that there was no clearance from the airway lumen to the gut via mucociliary transport; this assumption is valid for soluble manganese forms such as manganese chloride and manganese sulfate, but would not be valid for less-soluble forms of manganese such as manganese phosphate (Nong et al. 2008; Teeguarden et al. 2007c).

Nong et al. (2008) described further refinements to model A parameters shown in Table 3-15. Daily manganese dietary intake ( $F_{DietUp}$ ) and biliary elimination rate constants ( $k_{BileC}$ ) were first calibrated for different levels of manganese in the diet (2, 10, 100, and 125 ppm; Table 3-15) by fitting the model to the observed steady-state tissue manganese concentration data for rats exposed to 2, 10, or 100 ppm manganese in the diet for 13 weeks (Dorman et al. 2001b). After this refinement, clearance rates for the liver and brain striatum ( $k_{In}$  and  $k_{Out}$  values shown in Table 3-15) were refined by fitting the model to tissue manganese concentration data from the 14-day inhalation study by Dorman et al. (2001a).

***Nong et al. (2008) Model B Description and Development.*** Model B contains a similar structure to Model A, except that manganese concentrations in the liver and brain striatum are dependent on capacity-limited binding of manganese (Figure 3-7). In addition, uptake from striatal blood to striatal tissues is described with diffusion terms ( $PA_{12}$  and  $PA_{21}$ , Figure 3-7). The diffusion terms were included to account for observations of preferential increases in some brain regions compared with other tissues, such as liver or blood, following inhalation exposure to manganese (see Dorman et al. 2006a for review). The diffusion terms are thought to reflect movement of manganese across the blood-brain barrier (Nong et al. 2008). In Model B, the total amounts of manganese in the liver and brain striatum tissues are dependent on concentrations of free circulating manganese, the binding capacity of the tissue, and the concentrations of bound manganese in tissue stored (Nong et al. 2008). Differential equations to describe changes (with time) in amounts of free or bound manganese in the liver and the brain striatum are described in detail by

## 3. HEALTH EFFECTS

**Table 3-15. Refined Parameter Values in Nong et al. (2008) Model A**

| Parameter <sup>a</sup>         | Manganese level in diet                    | Biliary excretion (/h/kg)                      |
|--------------------------------|--|--|
| k <sub>BileC</sub>             | 2 ppm manganese                            | 0.19   |
|                                | 10 ppm manganese                           | 0.28   |
|                                | 100 ppm manganese                          | 0.60   |
|                                | 125 ppm manganese                          | 0.60   |
| Tissue clearance rates (/h/kg) |  |  |
| k <sub>InLivC</sub>            | Into deep liver compartment                | 0.621  |
| k <sub>InBrnC</sub>            | Into deep brain compartment                | 0.011  |
| k <sub>OutLivC</sub>           | Out of deep liver compartment              | 0.007  |
| k <sub>OutBrnC</sub>           | Out of deep brain compartment              | 0.00039  |
|                                | Dosing parameters: diet level of manganese | Fraction of manganese in diet that is absorbed |
| F <sub>DietUp</sub>            | 2 ppm manganese                            | 0.044  |
|                                | 10 ppm manganese                           | 0.018  |
|                                | 100 ppm manganese                          | 0.004  |
|                                | 125 ppm manganese                          | 0.003  |

<sup>a</sup>The remaining parameters are described in Teeguarden et al. (2007c). Clearance rates are scaled to the body weight ( $BW^{-0.25}$ ).

Source: Nong et al. 2008

## 3. HEALTH EFFECTS

Nong et al. (2008). Table 3-16 lists binding rate constants (e.g.,  $k_{aBrnC}$ ,  $k_{dBrnC}$ ), binding capacities ( $B_{max,Brain}$ ,  $B_{max,Liver}$ ), brain diffusion constants ( $PA_{12}$  and  $PA_{21}$ ), and partition coefficients in Model B. Liver and brain striatum binding capacity levels were first determined by fitting the model to steady-state tissue concentration data from the 13-week dietary study by Dorman et al. (2001b), using starting values for the tissue binding parameters that were estimated based on clearance rate values ( $k_{In}$  and  $k_{out}$ ) for liver and brain striatum in Model A. Tissue binding parameters (e.g.,  $k_{aBrnC}$ ,  $k_{dBrnC}$ ) and brain diffusion constants ( $PA_{12}$  and  $PA_{21}$ ) were then refined by fitting the model to the 14-day-inhalation tissue concentration data from Dorman et al. (2001a).

***Evaluation of Nong et al. (2008) Models A and B.*** Nong et al. (2008) compared the abilities of Models A and B to predict: (1) whole-body elimination kinetics of  $^{54}\text{Mn}$  in rats fed a 100-ppm diet for 13 weeks (data from Dorman et al. 2001b); (2) liver and brain striatum manganese concentration data in rats exposed to 0.03, 0.3, or 3 mg manganese/ $\text{m}^3$  for 6 hours/day for 14 consecutive days (Dorman et al. 2001a); (3) whole-body elimination kinetics of  $^{54}\text{Mn}$  in rats following 14-day inhalation exposure to 3 mg manganese/ $\text{m}^3$ ; and (4) liver and brain striatum manganese concentrations in rats during and following a 90-day inhalation exposure period to 0.1 or 0.5 mg manganese/ $\text{m}^3$  (Dorman et al. 2004b). Both models adequately predicted observed  $^{54}\text{Mn}$  elimination kinetics data, but Model B much more accurately predicted liver and brain striatum manganese concentration data during and following 14- or 90-day inhalation exposures. Model A consistently overestimated liver and brain striatum manganese concentration, particularly at concentrations of 0.1, 0.3, or 0.5 mg manganese/ $\text{m}^3$  (as shown in Figures 4 and 7 of Nong et al. 2008). Nong et al. (2008) concluded that the evaluation of the models “highlighted the importance of tissue binding in maintaining relatively constant tissue concentrations across a wide range of inhaled concentrations.” Nong et al. (2008) mentioned that the next steps in model development would be to extend tissue binding in Model B to all other tissues in the models for which appropriate data are available for calibrating tissue-specific binding rate constants.

***PBPK Model for Manganese Transport from the Olfactory Mucosa to Striatum (Leavens et al. 2007).***

Leavens et al. (2007) developed a pharmacokinetic model describing the olfactory transport and blood delivery of manganese to the striatum in rats following acute inhalation exposure to manganese chloride or manganese phosphate. Figure 3-9 shows the structure of the model, which presumes that manganese undergoes axonal transport from the olfactory mucosa (OM) to the olfactory bulb (OB), followed by serial transport to the olfactory tract and tubercle (OTT) and then to the striatum (S). Tables 3-17 and 3-18 list values of the model parameters for soluble manganese chloride and relatively insoluble manganese phosphate, respectively. Each of the compartments in the model (containing a left and right

## 3. HEALTH EFFECTS

**Table 3-16. Parameter Values in Nong et al. (2008) Model B**

| Parameters <sup>a</sup>                    |  | Values    |
|--|--|-----------|
| Tissue binding rate constants <sup>a</sup> |  |           |
| kaBrnC                                     | Association striatum constant (/h/μg/kg) | 0.000176  |
| kaLivC                                     | Association liver constant (/h/μg/kg)    | 0.06772   |
| kdBrnC                                     | Dissociation striatum constant (/h/kg)   | 0.00002   |
| kdLivC                                     | Dissociation liver constant (/h/kg)      | 0.0054196 |
| Tissue binding constants (μg/kg)           |  |           |
| B <sub>max,brain</sub>                     | Maximal binding striatum constant        | 3,300     |
| B <sub>max,liver</sub>                     | Maximal binding liver constant           | 1,000     |
| Brain diffusion constants (/hour/kg)       |  |           |
| PA <sub>12</sub>                           | Influx brain tissue constant             | 1         |
| PA <sub>21</sub>                           | Efflux brain tissue constant             | 0.16      |
| Partition coefficient                      |  |           |
| P <sub>brain</sub>                         | Brain (striatum):blood                   | 1.0       |
| P <sub>liver</sub>                         | Liver:blood                              | 1.08      |

<sup>a</sup>The remaining parameters are described in Teeguarden et al. (2007c).

<sup>b</sup>Rate constants are scaled to the BW<sup>-0.25</sup> and maximal binding capacities are scaled to BW<sup>-0.75</sup>.

Source: Nong et al. 2008

## 3. HEALTH EFFECTS

**Figure 3-9. Schematic of the Leavens et al. (2007) Model to Describe Olfactory and Blood Delivery of Manganese to the Left Side of the Brain Isilateral to the Olfactory Mucosa (OM) in the Left Nasal Cavity\***

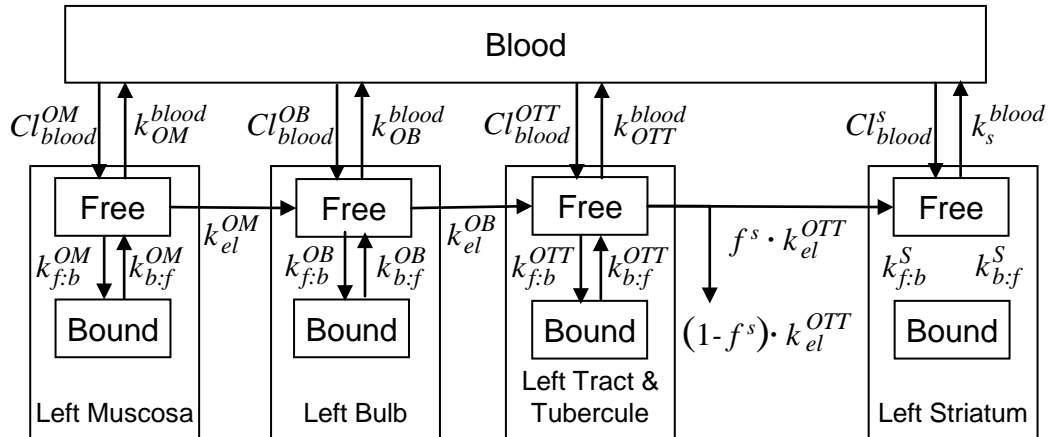

\*The model structure for the right side is identical. Values and descriptions of model parameters are in Tables 3-16, 3-17, and 3-18.

Source: Leavens et al. 2007



## 3. HEALTH EFFECTS

**Table 3-17. Parameter Values for Manganese Chloride in the Leavens et al. (2007) PBPK Model for Olfactory Transport of Manganese in Rats**

| Parameter  | Description                           | Value              | Units              | Source                |
|--|---------------------------------------|--------------------|--------------------|-----------------------|
| <b>Compartment volumes</b>                                       |                                       |                    |                    |                       |
| $V_{OM}^L$   | Left OM                               | 0.059              | mL                 | Measured <sup>a</sup> |
| $V_{OB}^L$   | Left OB                               | 0.031              | mL                 | Measured <sup>a</sup> |
| $V_{OTT}^L$  | Left OTT                              | 0.030              | mL                 | Measured <sup>a</sup> |
| $V_S^L$  | Left striatum                         | 0.032              | mL                 | Measured <sup>a</sup> |
| $V_{OM}^R$   | Right OM                              | 0.065              | mL                 | Measured <sup>a</sup> |
| $V_{OB}^R$   | Right OB                              | 0.038              | mL                 | Measured <sup>a</sup> |
| $V_{OTT}^R$  | Right OTT                             | 0.046              | mL                 | Measured <sup>a</sup> |
| $V_S^R$  | Right striatum                        | 0.042              | mL                 | Measured <sup>a</sup> |
| <b>Blood clearance into olfactory compartments</b>               |                                       |                    |                    |                       |
| $Cl_{blood}^{OM}$  | Influx to OM                          | $4 \times 10^{-4}$ | mL/hour            | Estimated             |
| $Cl_{blood}^{OB}$  | Influx to OB                          | $1 \times 10^{-5}$ | mL/hour            | Estimated             |
| $Cl_{blood}^{OTT}$   | Influx to OTT                         | $6 \times 10^{-4}$ | mL/hour            | Estimated             |
| $Cl_{blood}^S$   | Influx to striatum                    | $3 \times 10^{-5}$ | mL/hour            | Estimated             |
| <b>Rate constants for olfactory compartments efflux to blood</b> |                                       |                    |                    |                       |
| $k_{OM}^{blood}$   | Efflux from OM to blood               | $1 \times 10^{-6}$ | hour <sup>-1</sup> | Estimated             |
| $k_{OB}^{blood}$   | Efflux from OB to blood               | $1 \times 10^{-6}$ | hour <sup>-1</sup> | Estimated             |
| $k_{OTT}^{blood}$  | Efflux from OTT to blood              | 0.0                | hour <sup>-1</sup> | Estimated             |
| $k_S^{blood}$  | Efflux from striatum to blood         | $1 \times 10^{-6}$ | hour <sup>-1</sup> | Estimated             |
| <b>Olfactory transport rate constants</b>                        |                                       |                    |                    |                       |
| $k_{el}^{OM}$  | OM to OB                              | 0.022              | hour <sup>-1</sup> | Estimated             |
| $k_{el}^{OB}$  | OB to OTT                             | 0.037              | hour <sup>-1</sup> | Estimated             |
| $k_{el}^{OTT}$   | OTT to striatum                       | 0.094              | hour <sup>-1</sup> | Estimated             |
| $f^S$  | Fraction of OTT loss rate to striatum | 0.001              | Unitless           | Estimated             |
| <b>Binding rate constants in olfactory compartments</b>          |                                       |                    |                    |                       |
| $k_{f:b}^{OM}$   | OM free to bound                      | 0.006              | hour <sup>-1</sup> | Estimated             |
| $k_{f:b}^{OB}$   | OB free to bound                      | 0.0047             | hour <sup>-1</sup> | Estimated             |
| $k_{f:b}^{OTT}$  | OTT free to bound                     | 0.0043             | hour <sup>-1</sup> | Estimated             |
| $k_{f:b}^S$  | Striatum free to bound                | 0.0026             | hour <sup>-1</sup> | Estimated             |
| $k_{b:f}^{OM}$   | OM bound to free                      | $1 \times 10^{-6}$ | hour <sup>-1</sup> | Constant <sup>b</sup> |
| $k_{b:f}^{OB}$   | OB bound to free                      | $1 \times 10^{-6}$ | hour <sup>-1</sup> | Constant <sup>b</sup> |
| $k_{b:f}^{OTT}$  | OTT bound to free                     | $1 \times 10^{-6}$ | hour <sup>-1</sup> | Constant <sup>b</sup> |
| $k_{b:f}^S$  | Striatum bound to free                | $1 \times 10^{-6}$ | hour <sup>-1</sup> | Constant <sup>b</sup> |

<sup>a</sup>Unpublished results measured in CD rats used in Brenneman et al. (2000) study. Plugged and unplugged exposure data were averaged together because they were not significantly different.

<sup>b</sup>Not possible to estimate both constants for the binding; therefore, the rate constants for the bound to free manganese were set to a low rate to allow slow removal of manganese tracer from the bound compartment.

Source: Leavens et al. 2007

## 3. HEALTH EFFECTS

**Table 3-18. Parameter Values for Manganese Phosphate in the Leavens et al. (2007) PBPK Model for Olfactory Transport of Manganese in Rats**

| Parameter  | Description                           | Value                | Units              | Source                |
|--|---------------------------------------|----------------------|--------------------|-----------------------|
| <b>Compartment volumes</b>                                       |                                       |                      |                    |                       |
| $V_{OM}^L$   | Left OM                               | 0.085                | mL                 | Measured <sup>a</sup> |
| $V_{OB}^L$   | Left OB                               | 0.038                | mL                 | Measured <sup>a</sup> |
| $V_{OTT}^L$  | Left OTT                              | 0.025                | mL                 | Measured <sup>a</sup> |
| $V_S^L$  | Left striatum                         | 0.05                 | mL                 | Measured <sup>a</sup> |
| $V_{OM}^R$   | Right OM                              | 0.074                | mL                 | Measured <sup>a</sup> |
| $V_{OB}^R$   | Right OB                              | 0.038                | mL                 | Measured <sup>a</sup> |
| $V_{OTT}^R$  | Right OTT                             | 0.04                 | mL                 | Measured <sup>a</sup> |
| $V_S^R$  | Right striatum                        | 0.035                | mL                 | Measured <sup>a</sup> |
| <b>Blood clearance into olfactory compartments</b>               |                                       |                      |                    |                       |
| $Cl_{blood}^{OM}$  | Influx to OM                          | 0.0017               | mL/hour            | Estimated             |
| $Cl_{blood}^{OB}$  | Influx to OB                          | 0.0018               | mL/hour            | Estimated             |
| $Cl_{blood}^{OTT}$   | Influx to OTT                         | 0.0016               | mL/hour            | Estimated             |
| $Cl_{blood}^S$   | Influx to striatum                    | $1.8 \times 10^{-5}$ | mL/hour            | Estimated             |
| <b>Rate constants for olfactory compartments efflux to blood</b> |                                       |                      |                    |                       |
| $k_{OM}^{blood}$   | Efflux from OM to blood               | $3 \times 10^{-6}$   | hour <sup>-1</sup> | Estimated             |
| $k_{OB}^{blood}$   | Efflux from OB to blood               | 0.0                  | hour <sup>-1</sup> | Estimated             |
| $k_{OTT}^{blood}$  | Efflux from OTT to blood              | $1 \times 10^{-6}$   | hour <sup>-1</sup> | Estimated             |
| $k_S^{blood}$  | Efflux from striatum to blood         | $1.5 \times 10^{-5}$ | hour <sup>-1</sup> | Estimated             |
| <b>Olfactory transport rate constants</b>                        |                                       |                      |                    |                       |
| $k_{el}^{OM}$  | OM to OB                              | 0.011                | hour <sup>-1</sup> | Estimated             |
| $k_{el}^{OB}$  | OB to OTT                             | 0.036                | hour <sup>-1</sup> | Estimated             |
| $k_{el}^{OTT}$   | OTT to striatum                       | 0.099                | hour <sup>-1</sup> | Estimated             |
| $f^S$  | Fraction of OTT loss rate to striatum | 0.033                | Unitless           | Estimated             |
| <b>Binding rate constants in olfactory compartments</b>          |                                       |                      |                    |                       |
| $k_{f:b}^{OM}$   | OM free to bound                      | 0.00086              | hour <sup>-1</sup> | Estimated             |
| $k_{f:b}^{OB}$   | OB free to bound                      | 0.0014               | hour <sup>-1</sup> | Estimated             |
| $k_{f:b}^{OTT}$  | OTT free to bound                     | 0.0031               | hour <sup>-1</sup> | Estimated             |
| $k_{f:b}^S$  | Striatum free to bound                | 0.024                | hour <sup>-1</sup> | Estimated             |
| $k_{b:f}^{OM}$   | OM bound to free                      | $1 \times 10^{-6}$   | hour <sup>-1</sup> | Constant <sup>b</sup> |
| $k_{b:f}^{OB}$   | OB bound to free                      | $1 \times 10^{-6}$   | hour <sup>-1</sup> | Constant <sup>b</sup> |
| $k_{b:f}^{OTT}$  | OTT bound to free                     | $1 \times 10^{-6}$   | hour <sup>-1</sup> | Constant <sup>b</sup> |
| $k_{b:f}^S$  | Striatum bound to free                | $1 \times 10^{-6}$   | hour <sup>-1</sup> | Constant <sup>b</sup> |

<sup>a</sup>Unpublished results measured in CD rats used in Dorman et al. (2000) study. Plugged and unplugged exposure data were averaged together because they were not significantly different.

<sup>b</sup>Not possible to estimate both constants for the binding; therefore, the rate constants for the bound to free manganese were set to a low rate to allow slow removal of manganese tracer from the bound compartment.

Source: Leavens et al. 2007

## 3. HEALTH EFFECTS

nasal cavity) is connected by blood and each is comprised of pools of free and bound manganese. The rates of transport between tissue compartments and between bound and free pools are modeled as first-order transport processes. Tables 3-17 and 3-18 show measured values for compartment volumes, values for blood clearance into olfactory compartments (e.g.,  $Cl^{OM/blood}$ ), values for rate constants for efflux from compartments to blood (e.g.,  $k^{blood/OM}$ ), values for transport rate constants between compartments (e.g.,  $k^{OM/el}$ ), and binding rate constants in the olfactory compartments (e.g., OM free to bound,  $k^{OM/f.b}$  and OM bound to free,  $k^{OM/b.f}$ ). Equations for mass balance, clearance, and free concentrations of manganese for each of the compartments are described in detail by Leavens et al. (2007).

Model parameters were estimated by optimization procedures using kinetics data from rats exposed nose-only for 90 minutes to  $^{54}\text{Mn}$ -manganese chloride (Brenneman et al. 2000) or  $^{54}\text{Mn}$ -manganese phosphate (Dorman et al. 2002a). In each experiment, one group was exposed with both nostrils unplugged, while a second group was exposed with the right nostril plugged. Blood concentrations were not measured in either of these studies, but  $^{54}\text{Mn}$  concentrations in the kidney, liver, and pancreas were measured and reported. The mean concentration in these three organs is used to represent blood concentration in the model, and the data were used to obtain parameters for equations describing first-order absorption and elimination into a single compartment; values for the parameters under plugged and unplugged conditions, obtained through model optimization procedures, are listed in Table 3-19. The optimized model was used to predict the percentage of  $^{54}\text{Mn}$  that was transported into each compartment either via direct olfactory transport or blood delivery. For manganese chloride, olfactory transport was predicted to deliver >97–99% of the tracer in the left or right olfactory bulbs, 40–76% of the tracer in the left or right olfactory tract and tubercle, and only 4–8% of the tracer in the left or right striatum under plugged or unplugged conditions. For manganese phosphate, the respective predictions were 38–59% in the olfactory bulbs, 86–90% in the olfactory tract and tubercle and 77–83% in the striatum. Leavens et al. (2007) cautioned against the predictions for the striatum, since the model overpredicted striatum concentrations at the later time points for the plugged exposures to manganese chloride or manganese phosphate and the unplugged exposures to manganese phosphate (Figures 4–7 in Leavens et al. 2007).

## 3. HEALTH EFFECTS

**Table 3-19. Parameter Values for Describing Blood Concentrations in the Levens et al. (2007) PBPK Model for Olfactory Transport of Manganese in Rats**

| Parameter <sup>a</sup>        | Description                                  | Value   |           | Units              | Source    |
|-------------------------------|--|---------|-----------|--------------------|-----------|
|                               |  | Plugged | Unplugged |                    |           |
| Manganese chloride exposures  |  |         |           |                    |           |
| C <sub>e</sub>                | Initial deposited concentration <sup>b</sup> | 261     | 791       | ng/g               | Estimated |
| k <sub>a</sub>                | First-order absorption                       | 0.0068  | 0.005     | hour <sup>-1</sup> | Estimated |
| K                             | First-order elimination rate constant        | 0.057   | 0.063     | hour <sup>-1</sup> | Estimated |
| Manganese phosphate exposures |  |         |           |                    |           |
| C <sub>e</sub>                | Initial deposited concentration <sup>b</sup> | 171     | 376       | ng/g               | Estimated |
| k <sub>a</sub>                | First-order absorption                       | 0.0035  | 0.0034    | hour <sup>-1</sup> | Estimated |
| K                             | First-order elimination rate constant        | 0.083   | 0.124     | hour <sup>-1</sup> | Estimated |

<sup>a</sup>Estimated pharmacokinetic parameters for mean of liver, kidney, and pancreas concentration reported in Brenneman et al. (2000). See text for equation and details.

<sup>b</sup>Equal to  $FX_0/V_b$ , where  $X_0$  is initial dose, F is fraction dose bioavailable for absorption, and  $V_b$  is the blood volume.

Source: Levens et al. 2007

## 3. HEALTH EFFECTS

**3.5 MECHANISMS OF ACTION****3.5.1 Pharmacokinetic Mechanisms**

**Absorption.** Manganese absorption occurs primarily through the diet; however, absorption via the lungs can be significant for occupationally exposed persons or for those exposed to excess levels of airborne manganese, such as downwind of a manganese point source. Manganese absorption through the gut may occur through a nonsaturable simple diffusion process through the mucosal layer of brush border membranes (Bell et al. 1989) or via an active-transport mechanism that is high-affinity, low-capacity, and rapidly saturable (Garcia-Aranda et al. 1983). Manganese particles that are too large to enter the alveoli (>10 microns in diameter) remain in the upper respiratory tract, where they are coughed up by mucociliary transport and swallowed. Differences in solubility of manganese compounds deposited in the alveolar regions may impact the rate at which manganese will be absorbed, but manganese is bioavailable when deposited in these regions (Drown et al. 1986).

Diets high in iron have been shown to suppress manganese absorption, and conversely, iron-poor diets increase manganese uptake (Lönnerdal 1997, Lönnerdal et al. 1994). Phosphorus (Wedekind et al. 1991) and calcium (Wilgus and Patton 1939) have also been found to decrease manganese uptake.

**Distribution.** Review articles by Aschner and Aschner (1991) and Aschner et al. (2005; 2007) summarize some of the available data regarding the distribution of manganese. Dietary manganese, thought to be absorbed as Mn(II), enters portal circulation from the gastrointestinal tract and is bound to  $\alpha_2$ -macroglobulin or albumin in the plasma. After delivery to the liver, the major portion of Mn(II) is secreted in the bile, but some may be oxidized by ceruloplasmin to Mn(III). The Mn(III) enters systemic circulation conjugated with plasma transferrin; once this complex enters a neuron, it dissociates, and from there, the manganese is transported to axon terminals. For example, Slood and Gramsbergen (1994) observed that radiolabeled manganese injected into the striatum or substantia nigra of rat brain is transported in an anterograde direction through both  $\gamma$ -amino-butyric acid-producing striato-nigral and dopaminergic nigro-striatal fibers.

Other studies, however, argue for the transport of Mn(II) into the brain. For example, Murphy et al. (1991) measured the kinetics of manganese transport in the brains of adult male rats using a perfusion technique. The rats were infused with increasing concentrations of [ $^{54}\text{Mn}$ ]Cl<sub>2</sub>; blood and brain samples were analyzed for manganese at varying time points. The data indicated a saturable mechanism for transporting Mn(II) into the choroid plexus, and influx into the cerebral cortex was also near saturation at

## 3. HEALTH EFFECTS

the highest plasma concentration of manganese used. Influx into other brain regions (e.g., caudate nucleus, hippocampus, hypothalamus) and cerebrospinal fluid (CSF) showed non-saturable transport of the cation. The authors suggested that the non-saturable transport into these brain regions resulted from passive diffusion of manganese down a concentration gradient from ventricular cerebrospinal fluid because some of these brain regions have components adjacent to the ventricles and manganese concentrations in these regions were below levels in the CSF. The authors also noted that at all plasma manganese concentrations tested (from 0.8 to 78 nmol/mL), the transfer coefficient for manganese uptake into the choroid plexus was significantly higher than in any other area of the central nervous system. For example, at 0.08 nmol/mL, the transfer coefficients for the CSF and the choroid plexus were  $16.2 \pm 2.43 \times 10^{-6}$  mL/second\*g and  $23,800 \pm 2,910 \times 10^{-6}$  mL/second\*g, respectively. Even after correcting for differences in compartment size, influx of manganese into the choroid plexus was an order of magnitude greater than influx into CSF.

Rabin et al. (1993) also measured transport of  $[^{54}\text{Mn}]\text{Cl}_2$  in adult rats using a similar technique. In this study, the authors used three perfusates (whole blood, plasma/serum, and saline) to determine brain uptake in environments that facilitated or prevented protein binding of the metal. The authors reported that uptake of manganese into the cortex, hippocampus, caudate nucleus, and choroid plexus was greater and more rapid when saline was used rather than with whole blood. When EDTA-saline was used as the perfusate, uptake was not significantly different than zero, indicating that divalent manganese was the form taken up by the brain. The transfer coefficients of Mn(II) from saline in the different regions of the brain (frontal, parietal, and occipital cortex regions; hippocampus; caudate nucleus; and thalamus-hypothalamus) ranged from 5 to  $10 \times 10^{-5}$  mL/second\*g, whereas that of the choroid plexus was  $727 \times 10^{-3}$  mL/second\*g. The authors noted that the transfer coefficients were greater than that expected for passive diffusion and suggested a facilitated blood-brain barrier transport by a channel or carrier mechanism (Rabin et al. 1993). These findings of a rapid uptake mechanism and concentrated uptake into the choroid plexus are consistent with results reported by Murphy et al. (1991). Separate binding studies performed by the authors determined that albumin, transferrin,  $\alpha_2$ -macroglobulin added to the manganese during perfusion significantly decreased brain uptake of the cation in all brain regions. The authors were uncertain whether Mn(II) in the form of low-molecular mass solutes was taken up at the blood-brain barrier. However, based on other literature and their own unpublished results, they suggest that the free ion is the species transported.

Other studies have also revealed the rapid appearance of manganese in the choroid plexus. Ingersoll et al. (1995) demonstrated that manganese levels in the lateral choroid plexus were 44 and 24 times higher than

## 3. HEALTH EFFECTS

levels in CSF, and blood, respectively, 4 hours after intraperitoneal injection of 10 mg manganese/kg. However, manganese concentration in the choroid plexus did not change significantly following intrathecal administration of this same dose. This demonstrated that manganese in the blood could be sequestered by the choroid plexus, whereas little to no transfer of manganese from CSF to the choroid plexus occurred. Intrathecal administration of manganese increased manganese concentrations in all brain regions examined while there were only slight changes in brain manganese concentrations after intraperitoneal administration. Moreover, intrathecal administration of manganese decreased spontaneous motor activity with no effect on motor activity following intraperitoneal dosing. The authors suggested that these results indicated that the brain is protected from high concentrations of manganese through sequestering in the choroid plexus, but this mechanism could become overwhelmed with rising levels of blood manganese such that manganese could then “leak” from the choroid plexus into CSF and thereby enter the brain. This interpretation appears to be consistent with the findings of London et al. (1989). In these studies, 50 and 100 mg/kg manganese was administered intraperitoneal doses 5 and 10 times that used by Ingersoll et al. (1995). Using MRI images, these doses were shown to concentrate in the ventricles, the pineal gland, and the pituitary gland and the authors indicated that this high concentration of manganese appeared in the ventricular CSF because it crossed the barrier of the choroid plexus. Takeda et al. (1994) used autoradiography to also show that manganese in selected brain regions was taken up via the CSF from the choroid plexus. Moreover, Zheng et al. (1998) observed that, in a subchronic manganese intoxication rat model, the increases in manganese concentrations observed in targeted brain regions were closely related in magnitude to that of CSF manganese, but not to that of serum manganese. The observations of Takeda et al. (1994) and Zheng et al. (1998) support the view that manganese in the CSF serves as the main source for manganese distribution in brain tissues.

Recent reviews of the state of the science have emphasized that manganese can enter the brain via three pathways: (1) from the nasal mucosa to the brain olfactory bulb via olfactory neural connections; (2) from the blood through capillary endothelial cells of the blood-brain barrier; and (3) from the blood through the cerebral spinal fluid via the choroid plexuses (Aschner et al. 2005; Bock et al. 2008; Crossgrove and Yokel 2005). Current understanding is inadequate to determine which of these pathways may predominate in cases of severe manganism or cases of subtle neurological impairment in nonhuman primates or humans. A number of transport mechanisms (including facilitated diffusion, active transport, transferrin-mediated transport, divalent metal transporter-1 mediation, store-operated calcium channels) have been proposed to transport manganese across the blood barrier or into the choroid plexus, but current understanding is inadequate to determine the predominant molecular mechanism of transport in either of the pathways (Aschner et al. 2005, 2007; Crossgrove and Yokel 2004, 2005; Roth 2006).

## 3. HEALTH EFFECTS

**3.5.2 Mechanisms of Toxicity**

The central nervous system is the primary target of manganese toxicity. Although it is known that manganese is a cellular toxicant that can impair transport systems, enzyme activities, and receptor functions, the principal manner in which manganese neurotoxicity occurs has not been clearly established (Aschner and Aschner 1991; Aschner et al. 2007).

Mn(III) has been found to be more cytotoxic to human neural cells as a manganese pyrophosphate complex (MnPPi) than as a manganese-transferrin complex (MnTf) (Suarez et al. 1995). Specifically, human neuroblastoma cells (cell line SH-SY5Y) grown in culture showed effects of cytotoxicity from 30  $\mu$ M MnPPi but did not show the same signs of cytotoxicity from MnTf (membrane damage and cell granulation and aggregation) until concentrations of 60  $\mu$ M were reached (Suarez et al. 1995). Both manganese complexes inhibited mitochondrial enzyme activity, but MnTf was slightly more toxic than MnPPi in this respect (Suarez et al. 1995).

Neuropathological changes are detectable in the basal ganglia of humans with manganism, and the specific area of injury appears to be primarily in the globus pallidus; the substantia nigra is sometimes affected, but generally to a lesser extent (Katsuragi et al. 1996; Yamada et al. 1986). Studies in nonhuman primates have produced similar findings (Newland and Weiss 1992; Newland et al. 1989). Limited evidence suggests that dopamine levels in the caudate nucleus and putamen are decreased in manganism patients (Bernheimer et al. 1973). Similarities in the behavior of manganism patients to those with Parkinson's disease have prompted some to refer to manganism as "manganese-induced Parkinsonism" or "Parkinson-like disease." Further, the two diseases do affect functional related regions of the brain, but Parkinsonism is believed to be due to the selective loss of subcortical neurons whose cell bodies lie in the substantia nigra and whose axons terminate in the basal ganglia (which includes the caudate nucleus, the putamen, the globus pallidus, and other structures). These nigral neurons use dopamine as their neurotransmitter, and treatment of Parkinson patients with levo-dopa (the metabolic precursor to dopamine) often relieves some of the symptoms of Parkinson's disease (Bernheimer et al. 1973). Some investigators have reported that oral levo-dopa can temporarily improve symptoms of manganese-induced neurotoxicity (Barbeau 1984). However, most studies show that manganism patients typically do not respond to levo-dopa treatment (Calne et al. 1994; Chu et al. 1995; Huang et al. 1989), indicating that they have likely suffered degeneration of the receptors and neurons that normally respond to this neurochemical (Chu et al. 1995).



## 3. HEALTH EFFECTS

The precise biochemical mechanism by which manganese leads to this selective destruction of dopaminergic neurons is not known, but many researchers believe that the manganese ion, Mn(II), enhances the autoxidation or turnover of various intracellular catecholamines, leading to increased production of free radicals, reactive oxygen species, and other cytotoxic metabolites, along with a depletion of cellular antioxidant defense mechanisms (Barbeau 1984; Donaldson 1987; Garner and Nachtman 1989b; Graham 1984; Halliwell 1984; Liccione and Maines 1988; Parenti et al. 1988; Verity 1999). Oxidation of catechols is more efficient with Mn(III), than with Mn(II) or Mn(IV) (Archibald and Tyree 1987). Formation of Mn(III) may occur by oxidation of Mn(II) by superoxide ( $O_2^-$ ). In cases of exposure to Mn(VII), it is likely that a reduction to the Mn(II) or Mn(III) state occurs (Holzgraefe et al. 1986), but this has not been demonstrated.

Hussain et al. (1997) studied the effects of chronic exposure of manganese on antioxidant enzymes, including manganese superoxide dismutase (MnSOD). MnSOD is an antioxidant enzyme located primarily in the mitochondria that contains manganese as a functional component. MnSOD protects against oxidative injury by catalyzing the dismutation of  $O_2^-$ . Hussain et al. (1997) found that administration of 0, 1.1, and 2.2 mg manganese/kg/day (as manganese chloride), 5 days/week for 3 months, resulted in increased MnSOD in the hippocampus, cerebellum, and brainstem. Other areas of the brain were not affected and other antioxidant enzymes, such as Cu,ZnSOD and glutathione peroxidase (GPx), were not increased. The researchers suggest that since a critical role of MnSOD is to protect against oxidative injury, the increase of this enzyme after manganese exposure may reduce the risk of oxidative stress induced by that exposure. Thus, this protective mechanism would have to be overwhelmed in cases of manganese toxicity. Additionally, the authors suggest that, since MnSOD was altered while Cu,ZnSOD and Gpx were unchanged, manganese may not affect cytosolic enzymes like Cu,ZnSOD. In support of this point, the authors also mention other reports that suggest that these antioxidant enzymes are independently regulated (Mossman et al. 1996; Warner et al. 1993; Yen et al. 1996).

Supporting evidence for the hypothesis that high levels of manganese exert neurotoxicity through oxidation is provided by Desole et al. (1994). The authors observed that 22 mg manganese/kg/day (as manganese chloride) administered orally in 6-month-old rats resulted in increased concentrations of DOPAC (an oxidation product of DA) and uric acid, but left DA levels unchanged. Daily doses of 44 or 66 mg manganese/kg/day resulted in significantly decreased concentrations of DA, glutathione, ascorbic acid, and DOPAC, and increased concentrations of uric acid in the rat striatum when compared to

## 3. HEALTH EFFECTS

controls. The researchers also measured levels of these metabolites in the rat striatal synaptosomes, which were used as a model for neuronal terminals. Here, DA levels were unchanged at 22 mg manganese/kg/day but were decreased at the two highest doses. DOPAC levels remained constant at all three dose levels. Thus, the DOPAC/DA ratio was significantly increased at 44 and 66 mg manganese/kg/day in the synaptosomes. While the authors suggest that these data support other findings that manganese oxidizes dopamine (Segura-Aguilar and Lind 1989), the decrease in DA could be the result of decreased production or release of the chemical, rather than increased oxidation. Catabolism of adenosine triphosphate (ATP) forms xanthine and hypoxanthine, both of which are metabolized by xanthine oxidase. The products of this metabolism are uric acid and superoxide radical anion (Desole et al. 1994). The increase in uric acid production in rat striatum following oral dosing with 44 or 66 mg manganese/kg (as manganese chloride) suggests that manganese induces oxidative stress mediated by xanthine oxidase. Desole et al. (1995) expanded their studies to investigate the protective effect of allopurinol, a xanthine-oxidase inhibitor, to 3-month-old rats exposed to manganese. In this study, allopurinol was administered by gavage at a dose of 300 mg/kg/day for 4 days. Manganese (87 mg/kg/day) was also administered by gavage, for 7 days, either alone or with allopurinol; the allopurinol decreased the striatal ratio of DOPAC and homovanillic acid (HVA) to dopamine. When given in conjunction with manganese, allopurinol antagonized the manganese-induced increase in DOPAC levels and the (DOPAC + HVA)/DA ratio. Together, the two studies suggest that manganese-induced oxidative stress through the formation of reactive oxygen species may be a mechanism for manganese neurotoxicity, and allopurinol may protect against this oxidative stress in the striatum and brainstem of young rats.

Experiments such as the one by Desole et al. (1994) indicate that overexposure of rats to manganese results in increased dopamine turnover in the rat striatum. However, patients with basal ganglia dysfunction caused by manganese had normal striatal fluorodopa uptake on PET scan, indicating that the nigrostriatal pathway was intact (Wolters et al. 1989). Seven intravenous injections of manganese chloride into Rhesus monkeys resulted in an extrapyramidal syndrome characterized by bradykinesia, facial grimacing, and rigidity, with gliosis of the globus pallidus and the substantia nigra par reticularis (Olanow et al. 1996). These intravenous injections, however, would have resulted in a highly elevated but transient increase in blood manganese levels. Striatal dopamine and homovanillic acid levels were within normal ranges; yet, there was clear evidence of manganese-induced neurotoxicity. Interestingly, none of the symptoms improved after levo-dopa administration, supporting findings in humans that manganese does not respond to levo-dopa treatment (Chu et al. 1995; Huang et al. 1989).

## 3. HEALTH EFFECTS

While there are a number of studies that support the hypothesis that manganese exerts its neurotoxicity through oxidation, a study by Sziráki et al. (1999) has demonstrated atypical antioxidative properties of manganese in iron-induced brain lipid peroxidation and copper dependent low density lipoprotein conjugation. However, the underlying mechanisms of the antioxidant effects are not clear. Brenneman et al. (1999) measured reactive oxygen species (ROS) in the brains of neonatal rats administered up to 22 mg manganese/kg/day for up to 49 days (dosing was only 5 days/week from day 22 to 49). On PND 21, no increase in ROS was seen in the striatum, hippocampus, or hindbrain of exposed rats at any dose, compared to controls administered water only. In the cerebellum, ROS levels were significantly increased to the same extent at both dose levels, as compared to controls. Manganese levels were not increased significantly in the cerebellum at any dose level, but were increased in the striatum, and the rest of the brain at the high dose level, when measured at PND 49. Mitochondrial manganese was not significantly elevated in the cerebellum or striatum, but was elevated in the rest of the brain at this high dose level, also at PND 49. These data do not support the hypothesis that oxidative damage is a mechanism of action in manganese-induced neurotoxicity in the rat.

As reviewed Taylor et al. (2006), the available literature contains results both in support of and inconsistent with oxidative stress involvement in manganese neurotoxicity. Recent support for oxidative stress involvement includes the finding that co-treatment of rats with the antioxidant, N-acetylcysteine, and intraperitoneal injections of high doses of manganese chloride (50 mg/kg, once or daily for 4 days) prevented the development of pathological changes observed following injection of manganese chloride alone (Hazell 2006). Likewise, mouse catecholaminergic cells (CATH.a) were protected from the cytotoxicity of 50–1000  $\mu\text{M}$  manganese by supplementation of the culture media with 5 mM glutathione or 10 mM N-acetylcysteine (Stredrick et al. 2004). In contrast, in a series of studies of neonatal rats, adult male and female rats, or senescent male rats exposed by inhalation to manganese sulfate or manganese phosphate at concentrations up to 3 mg manganese/ $\text{m}^3$  with acute exposure durations or 1 mg manganese/ $\text{m}^3$  with subchronic exposure durations (Dorman et al. 2001a, 2004a, 2005a), no consistent exposure-related changes were found in the following markers of oxidative stress in various brain regions: glutathione, metallothionein, and glutamine synthetase (Taylor et al. 2006).

Mn(II) may also be involved in neurotoxicity. The neurotoxicity of Mn(II) has been linked to its ability to substitute for Ca(II) under physiological conditions (Aschner and Aschner 1991), and the intestinal transfers of Ca(II) and Mn(II) have been shown to be competitive *in vivo* (Dupuis et al. 1992). Although the mechanism for Mn(II) transport into brain cells is uncertain, Mn(II) preferentially accumulates in the mitochondria in the areas of the brain that are associated with manganese and neurological symptoms.

## 3. HEALTH EFFECTS

Manganese is taken up into mitochondria via the calcium uniporter, and once there, Mn(II) inhibits mitochondrial oxidative phosphorylation. Gavin et al. (1992) observed that Mn(II) can inhibit mitochondrial oxidative phosphorylation when incubating isolated mitochondria with Mn(II) at concentrations  $>1 \mu\text{M}$ . Recently, it has also been shown that intramitochondrial Mn(II) can inhibit the efflux of Ca(II), which may result in a loss of mitochondrial membrane integrity (Gavin et al. 1999). At the same time, intramitochondrial Mn(II) can also inhibit oxidative phosphorylation and decrease energy production. However, Brouillet et al. (1993) has suggested that the impaired oxidative metabolism induced by manganese is indirectly linked to an excitotoxic process that results in neuronal degeneration. Because manganese accumulates in the mitochondria and is associated with impaired energy production, these authors compared the effects of intrastriatal injection of manganese with effects produced by known mitochondrial toxins, aminooxyacetic acid and 1-methyl-4-phenylpyridinium. Lesions produced by these compounds can be blocked through an inhibition of the glutamatergic *N*-methyl-*D*-aspartate (NMDA) receptor or by the removal of the cortical glutamatergic input into the striatum by decortication. Thus, these lesions are termed “excitotoxic lesions.” It was shown that decortication or pre-treatment with the NMDA noncompetitive antagonist, MK-801, could reverse or ameliorate neurochemical changes induced by intrastriatal injection of manganese. These authors also showed that intrastriatal manganese treatment also interfered with energy metabolism, ATP concentrations were significantly reduced by 51% and lactate levels were increased by 97%. There is additional evidence that the glutamatergic excitatory system may play a role in manganese toxicity. Recent studies in genetically epilepsy-prone rats have suggested that there are abnormalities in manganese-dependent enzymes. Although the manganese-dependent enzymes are believed to be unrelated to seizure activity in these animals, it is suggested that there is a link between the low manganese concentrations in glial cells and elevated glutamate levels due to low glutamine synthetase activity (Critchfield et al. 1993).

Mn(II) (from manganese chloride) has also been shown to inhibit mitochondrial aconitase activity to a significant level in the frontal cortex of male rats dosed with 6 mg manganese/kg/day for 30 days (Zheng et al. 1998). Aconitase levels in striatum, hippocampus, and substantia nigra were decreased in treated rats, but not to a significant extent. Aconitase, which catalyzes the interconversion of L-citrate to isocitrate, via *cis*-aconitate, requires iron as a cofactor at its active center (Zheng et al. 1998). When the authors incubated brain mitochondrial fractions with Mn(II), aconitase activity was decreased; the addition of excess iron [Fe(II)] revived the enzyme activity. These data suggest that the similarity of manganese and iron facilitates their proposed interaction at the subcellular level; however, the data do not prove that Mn(II) is the form of manganese that is exerting the inhibitory effect.

## 3. HEALTH EFFECTS

Conversely, Suarez et al. (1995) did not observe cytotoxicity in cultured cells exposed to 100  $\mu\text{M}$  Mn(II). The discrepancy noted in this study, and that of Gavin et al. (1992) may have occurred because of a protective effect of the cell membrane; if the cell membrane protects the cytosol, which typically has a low manganese concentration, then the Mn(II) concentration may be too low to affect the mitochondria through uniport uptake (Suarez et al. 1995). Another explanation is that mitochondrial uptake of Mn(II) occurs, but toxic effects require that cells be exposed much longer than isolated mitochondria (Suarez et al. 1995). It has also been established that manganese accumulation in the brain varies between regions, particularly in developing animals; this region-specific accumulation may alter the metabolism and homeostasis of manganese (Chan et al. 1992). In addition, it has been demonstrated that the manganese concentration in the central nervous system, in particular the ventral mesencephalon, can be reduced by cocaine, a dopamine reuptake inhibitor, or by reserpine, a dopamine depleting agent (Ingersoll et al. 1999). This suggests that the dopamine reuptake carrier is linked to a transport mechanism for manganese.

*In vitro* studies of rat brain mitochondria have demonstrated that there is no apparent mechanism for Mn(II) clearance other than the slow  $\text{Na}^+$  independent mechanism; it is suggested that Ca(II) and Mn(II) may accumulate in the brain mitochondria during manganese intoxication (Gavin et al. 1990). Other theories regarding the mode of neurotoxicity for manganese (and other metal ions) include toxicity caused by the formation of hydroxyl radicals during the manganese-catalyzed autooxidation of hydrazines (Ito et al. 1992).

It has been suggested that the mechanism of manganese neurotoxicity may in part involve complex interactions with other minerals (Lai et al. 1999). In a developmental rat model of chronic manganese toxicity, administration of manganese in drinking water was associated with increased levels of iron, copper, selenium, zinc, and calcium in various regions of the brain. Moreover, the subcellular distribution of various minerals was differentially altered following manganese treatment. Iron deficiency is associated with increased manganese burden in the central nervous system of rats, while administration of excess iron significantly decreases manganese uptake (Aschner and Aschner 1990). The biochemical mechanisms underlying the interactions between manganese and other minerals are unclear.

Subtle deficits in fine motor and cognitive function in chronically exposed young adult male *Cynomolgus* macaques monkeys have been associated with manganese impairment of *in vivo* amphetamine-induced dopamine release in the striatum, without detectable changes in markers of striatal dopamine terminal integrity, and with decreased cerebral cortex N-acetylaspartate/creatine ratio (Guilarte

## 3. HEALTH EFFECTS

et al. 2006a, 2006b; Schneider et al. 2006). In these studies, four monkeys (5–6 years old at the start) were given intravenous injections of manganese sulfate, 10–15 mg/kg or 3.26–4.89 mg manganese/kg, once per week for an average of 34.2 weeks. Three additional monkeys without excess manganese exposure or behavioral evaluations were used as a control group for post-mortem analyses of the brain (Guilarte et al. 2006a). Prior to manganese exposure, the monkeys were trained to perform tests for cognitive and motor function; overall behavior was assessed by ratings and videotaped analysis (Schneider et al. 2006). By the end of the exposure period, monkeys developed deficits in spatial working memory, showed modest decreases in spontaneous activity and manual dexterity, and showed increased frequency of compulsive-type behaviors such as compulsive grooming (Schneider et al. 2006). At study termination, mean manganese concentrations were elevated in exposed monkeys, compared with control monkeys, in the following brain regions: globus pallidus (3.30 versus 0.72  $\mu\text{g/g}$  tissue); caudate (1.18 versus 0.38  $\mu\text{g/g}$  tissue); putamen (1.5 versus 0.48  $\mu\text{g/g}$  tissue); and frontal white matter (0.57 versus 0.17  $\mu\text{g/g}$  tissue) (Guilarte et al. 2006b; Schneider et al. 2006). Positron emission tomography (PET) analysis found changes in amphetamine-induced release of dopamine in the striatum (up to 60% decrease compared with baseline values), but no significant changes in striatal dopamine receptor binding potentials (Guilarte et al. 2006a). Post-mortem chemical and immunohistochemical analysis of caudate and putamen tissue found no evidence for exposure-related changes to levels of D2-dopamine receptor (D2-DAR), dopamine receptor (DAT), tyrosine hydroxylase, or dopamine and its metabolite, homovanillic acid (Guilarte et al. 2006a). Using  $^1\text{H}$ -magnetic resonance spectroscopy, concentrations of creatine (Cr), N-acetylaspartate (NAA), choline, and myo-inositol were measured. Decreases (relative to baseline) in the NAA/Cr ratio were measured in the parietal cortex and frontal white matter, but not in the striatum (Guilarte et al. 2006b). Guilarte et al. (2006b) suggested that the changes in the NAA/Cr ratio are indicative of neuronal degeneration or dysfunction in the parietal cortex that may also be associated with the neurobehavioral changes noted in the monkeys. Subsequent gene expression profiling in the frontal cortex of these monkeys found changes consistent with cellular stress responses that the investigators proposed may help to explain the subtle cognitive effects noted (Guilarte et al. 2008). The collective results from these studies suggest that subtle neurobehavioral changes noted in epidemiological studies of chronically exposed workers (see Section 3.2.1.4 and Appendix A) may be similar to those noted in these monkeys and may be related to manganese-induced functional changes and gene expression changes noted in the striatum and the cerebral cortex.

As reviewed by Fitsanakis et al. (2006), most mechanistic research on manganese neurotoxicity has focused on perturbations of the dopaminergic system, but there is evidence to suggest that early consequences of manganese neurotoxicity may involve perturbations of other neurotransmitters including

### 3. HEALTH EFFECTS

GABA and glutamate in the basal ganglia and other brain regions. For example, there is evidence to suggest that manganese decreases the ability of astrocytes to clear glutamate from extracellular space (Erikson and Aschner 2002, 2003), increases the sensitivity of glutamate receptors to glutamate (see Fitsanakis and Aschner 2005 and Fitsanakis et al. 2006 for review), and perturbs glutamine-glutamate-GABA interconversions in frontal cortex and basal ganglia of rats (Zwingmann et al. 2004, 2007). When rat striatum was perfused with artificial cerebrospinal fluid with 200 nM manganese, GABA levels in the perfusate were decreased by about 60% compared with controls, but no effects on levels of glutamate, aspartate or glycine in the perfusate were observed (Takeda et al. 2003). In the perfused rat hippocampus, 200 nM manganese caused a 50% decrease in the levels of GABA, glutamate, and aspartate in the perfusate (Takeda et al. 2002). The results from the studies of Takeda et al. (2002, 2003) suggest that there are differential regional effects of manganese on the release of different neurotransmitters. Fitsanakis et al. (2006) concluded that additional research is needed to better understand the interdependence of neurotransmitters, including dopamine, glutamate, and GABA and their relationships to manganese neurotoxicity.

#### 3.5.3 Animal-to-Human Extrapolations

As discussed in Section 3.2, the available literature on toxicological analysis of manganese in humans and animals is quite extensive. However, due to the wide dose ranges administered, the variety of responses, and the differences in measured end points, comparisons of effects across species is not straightforward.

Rodent models have primarily been used to study manganese neurotoxicity. These studies have reported mostly neurochemical, rather than neurobehavioral, effects (Brouillet et al. 1993; Chandra 1983; Chandra and Shukla 1978, 1981; Daniels and Abarca 1991; Deskin et al. 1980, 1981; Eriksson et al. 1987a; Gianutsos and Murray 1982; Parenti et al. 1986; Singh et al. 1979; Subhash and Padmashree 1991), as very few studies investigated neurobehavioral effects. It has been suggested that this focus may reflect difficulties in characterizing behavioral changes following basal ganglia damage in the rodent (Newland 1999). Other techniques, such as those used to identify basal ganglia damage as a result of exposure to neuroleptics (Newland 1999), may be refined to further exploit the rodent model as a predictor of neurobehavioral change in the human. The usefulness of the rat model for manganese neurotoxicity is also limited because the distribution of manganese in brain regions is dissimilar to that of the human (Chan et al. 1992; Brenneman et al. 1999; Kontur and Fechter 1988; Pappas et al. 1997). Studies to date have used exposure routes such as inhalation, intravenous, intraperitoneal, or subcutaneous, with few

## 3. HEALTH EFFECTS

exceptions (Brenneman et al. 1999; Dorman et al. 2000, 2002, 2004a, 2005a, 2006b; Lown et al. 1984; Morganti et al. 1985; Pappas et al. 1997).

The rabbit has also been used as a model for manganese toxicity in a few studies (Chandra 1972; Szakmáry et al. 1995). The only available neurotoxicity study using the rabbit (Chandra 1972) reported that the species, when dosed intratracheally with 253 mg manganese/kg body weight (inferred as a one-time dose), developed hindlimb paralysis (a response not typically observed in humans exposed to excess manganese) after an observation period of 18 months. The animals also exhibited wide-spread neuronal degeneration in the brain. This study suggests that rabbits and humans may be qualitatively similar in the manifestation of neurobehavioral effects. However, further studies are needed to determine if the two species manifest comparable symptoms within the same dose range.

The nonhuman primate has been a useful model for predicting neurotoxicity in the human as the monkey presents neurobehavioral responses to toxicants that are very similar to those observed in humans (Eriksson et al. 1987b; Golub et al. 2005; Gupta et al. 1980; Newland and Weiss 1992; Olanow et al. 1996). Further, the monkey also undergoes neurochemical changes (Bird et al. 1984) as a result of manganese exposure. Studies have shown that monkeys exposed to manganese injected either intravenously or subcutaneously exhibit symptoms very similar to those observed in miners and others exposed to manganese, including ataxia, bradykinesia, unsteady gait, grimacing, and action tremor (Eriksson et al. 1992a, 1992b; Newland and Weiss 1992; Olanow et al. 1996). In addition, monkeys exhibiting these effects show accumulation of manganese in the basal ganglia as observed by MRI (Eriksson et al. 1992b; Newland and Weiss 1992), as do humans who are either exposed to, or are unable to clear, excess manganese (Devenyi et al. 1994; Fell et al. 1996; Hauser et al. 1994; Ono et al. 1995; Pomier-Layrargues et al. 1998; Rose et al. 1999; Spahr et al. 1996). However, primate studies showing these neurobehavioral effects have involved routes of administration that do not mimic environmental exposures, and although the effects in monkeys are qualitatively similar, it is currently unknown whether the effects are seen at the same dose metric as those in humans. Newland (1999) proposes using MRI techniques to relate the administration of certain amounts of manganese with a corresponding MRI signal in the brain and the resultant neurobehavioral effects. This technique might be very useful in developing a true dose-response relationship for manganese neurotoxicity in both the monkey and human.

Mechanisms of manganese toxicity *in vivo* are likely to be comprised in part by unique characteristics of the exposed individual, as well as by general physiology and exposure route. Therefore, further studies are needed to develop appropriate animal models for human populations identified as susceptible (e.g.,



## 3. HEALTH EFFECTS

children, elderly adults, nutritionally-compromised children and adults) using appropriate animal modalities. Such techniques may lead to a more complete evaluation of the pathways and circumstances by which manganese exposure can result in toxicity. Additional research to further develop PBTK models in rats that have been recently described (Leavens et al. 2007; Nong et al. 2008; Teeguarden et al. 2007a, 2007b, 2007c) and extend them to populations of potentially susceptible individuals (in rodents, nonhuman primates, and primates) may be useful to increase understanding of interspecies differences in manganese neurotoxicity and provide support for extrapolations of dose-response relationships in animals to humans.

### 3.6 TOXICITIES MEDIATED THROUGH THE NEUROENDOCRINE AXIS

The potential hazardous effects of certain chemicals on the endocrine system are of current concern because of the ability of these chemicals to mimic or block endogenous hormones. Chemicals with this type of activity are most commonly referred to as *endocrine disruptors*. However, appropriate terminology to describe such effects remains controversial. The terminology *endocrine disruptors*, initially used by Thomas and Colborn (1992), was also used in 1996 when Congress mandated the EPA to develop a screening program for “...certain substances [which] may have an effect produced by a naturally occurring estrogen, or other such endocrine effect[s]...”. To meet this mandate, EPA convened a panel called the Endocrine Disruptors Screening and Testing Advisory Committee (EDSTAC), and in 1998, the EDSTAC completed its deliberations and made recommendations to EPA concerning *endocrine disruptors*. In 1999, the National Academy of Sciences released a report that referred to these same types of chemicals as *hormonally active agents*. The terminology *endocrine modulators* has also been used to convey the fact that effects caused by such chemicals may not necessarily be adverse. Many scientists agree that chemicals with the ability to disrupt or modulate the endocrine system are a potential threat to the health of humans, aquatic animals, and wildlife. However, others think that endocrine-active chemicals do not pose a significant health risk, particularly in view of the fact that hormone mimics exist in the natural environment. Examples of natural hormone mimics are the isoflavonoid phytoestrogens (Adlercreutz 1995; Livingston 1978; Mayr et al. 1992). These chemicals are derived from plants and are similar in structure and action to endogenous estrogen. Although the public health significance and descriptive terminology of substances capable of affecting the endocrine system remains controversial, scientists agree that these chemicals may affect the synthesis, secretion, transport, binding, action, or elimination of natural hormones in the body responsible for maintaining homeostasis, reproduction, development, and/or behavior (EPA 1997). Stated differently, such compounds may cause toxicities that are mediated through the neuroendocrine axis. As a result, these chemicals may play a role in altering,

## 3. HEALTH EFFECTS

for example, metabolic, sexual, immune, and neurobehavioral function. Such chemicals are also thought to be involved in inducing breast, testicular, and prostate cancers, as well as endometriosis (Berger 1994; Giwercman et al. 1993; Hoel et al. 1992).

Studies of endocrine effects in humans following manganese exposure are very limited. Alessio et al. (1989) reported the elevation of serum prolactin and cortisol in chronically-exposed workers, while no changes in prolactin, FSH, or LH levels were observed in an occupational study involving shorter exposure periods (Roels et al. 1992). Lucchini et al. (1995) reported elevated serum prolactin levels in ferromanganese workers; 20 of those workers still showed elevated prolactin levels 5 years later after exposure to consistent levels of airborne manganese (Smargiassi and Mutti 1999). In fact, the serum prolactin levels had increased significantly over the previous values. Although these changes are minor, changes in prolactin secretion may have effects on different physiological functions, including loss of libido and impotence in men, and infertility and change in menstrual cycle in women.

No studies of endocrine effects in animals following airborne manganese exposure were located. Short-term animal studies and some of the long-term animal studies were negative for endocrine effects following oral exposure to manganese (NTP 1993). One intermediate study reported a decrease in circulating testosterone and a significant increase in substance P in the hypothalamus and neurotensin in the pituitary in rats dosed intraperitoneally with 6.6 mg manganese/kg/day as manganese chloride (Hong et al. 1984). Two other studies in rats reported that manganese tetroxide in food, given at a dose of 350 mg manganese/kg/day for 224 days (starting on day 1 of gestation and continuing for 224 days) (Laskey et al. 1982) and 214 mg manganese/kg/day given up to 28 days (Laskey et al. 1985), resulted in reduced testosterone levels in male rats. The biological significance of this effect is unknown because the decrease had no result on fertility in the latter study (Laskey et al. 1985), and there were no observed effects on the hypothalamus or pituitary.

A current interest in endocrine effects of manganese revolves around the possibility that developmental manganese exposure may influence the timing of puberty. One study performed on 23-day-old female rats in which manganese was provided by a single, intraventricular administration of 0, 0.01, 0.02, 0.04, or 0.17 mg manganese/kg as manganese chloride found that, at the three highest doses, manganese stimulated a dose-responsive increase in luteinizing hormone (LH) levels (Pine et al. 2005). A dose of 2 mg manganese/kg/day, provided to another group of female pups by daily gavage from PND 12 to 29 significantly advanced the average age of puberty (by approximately 1 day) as well as produced significant increases in serum levels of LH, follicle stimulating hormone (FSH), and estradiol (E<sub>2</sub>) (Pine

## 3. HEALTH EFFECTS

et al. 2005). These results suggest a role for manganese in regulating the timing of puberty in female rats and suggests that excess manganese exposure may accelerate the onset of puberty. Manganese also appears to have pubertal effects in male rats; an oral gavage dose of 11 mg manganese/kg/day provided daily on PNDs 15–48 or 15–55 produced significantly increased LH, FSH, and testosterone at 55 days of age (Lee et al. 2006). Increases in both daily sperm production and efficiency of spermatogenesis were also observed, suggesting that manganese may be a stimulator of prepubertal LHRH/LH secretion and thus facilitate the onset of male puberty. *In vitro* experiments using medial basal hypothalamic implants from adult male Sprague-Dawley rats showed that manganese at 500  $\mu$ M increased luteinizing hormone-releasing hormone (LHRH) release, nitric oxide synthase activity, and the content of cyclic cGMP in the medial basal hypothalamus (Prestifilippo et al. 2007). The inhibition of nitric oxide synthase with a competitive inhibitor prevented the manganese-induced increase in LHRH release. The results of these *in vitro* studies provide added evidence of the ability of manganese to modulate levels of LHRH, even in adult animals (Prestifilippo et al. 2007).

### 3.7 CHILDREN'S SUSCEPTIBILITY

This section discusses potential health effects from exposures during the period from conception to maturity at 18 years of age in humans, when all biological systems will have fully developed. Potential effects on offspring resulting from exposures of parental germ cells are considered, as well as any indirect effects on the fetus and neonate resulting from maternal exposure during gestation and lactation. Relevant animal and *in vitro* models are also discussed.

Children are not small adults. They differ from adults in their exposures and may differ in their susceptibility to hazardous chemicals. Children's unique physiology and behavior can influence the extent of their exposure. Exposures of children are discussed in Section 6.6, Exposures of Children.

Children sometimes differ from adults in their susceptibility to hazardous chemicals, but whether there is a difference depends on the chemical (Guzelian et al. 1992; NRC 1993). Children may be more or less susceptible than adults to health effects, and the relationship may change with developmental age (Guzelian et al. 1992; NRC 1993). Vulnerability often depends on developmental stage. There are critical periods of structural and functional development during both prenatal and postnatal life, and a particular structure or function will be most sensitive to disruption during its critical period(s). Damage may not be evident until a later stage of development. There are often differences in pharmacokinetics and metabolism between children and adults. For example, absorption may be different in neonates

## 3. HEALTH EFFECTS

because of the immaturity of their gastrointestinal tract and their larger skin surface area in proportion to body weight (Morselli et al. 1980; NRC 1993); the gastrointestinal absorption of lead is greatest in infants and young children (Ziegler et al. 1978). Distribution of xenobiotics may be different; for example, infants have a larger proportion of their bodies as extracellular water, and their brains and livers are proportionately larger (Altman and Dittmer 1974; Fomon 1966; Fomon et al. 1982; Owen and Brozek 1966; Widdowson and Dickerson 1964). The infant also has an immature blood-brain barrier (Adinolfi 1985; Johanson 1980) and probably an immature blood-testis barrier (Setchell and Waites 1975). Many xenobiotic metabolizing enzymes have distinctive developmental patterns. At various stages of growth and development, levels of particular enzymes may be higher or lower than those of adults, and sometimes unique enzymes may exist at particular developmental stages (Komori et al. 1990; Leeder and Kearns 1997; NRC 1993; Vieira et al. 1996). Whether differences in xenobiotic metabolism make the child more or less susceptible also depends on whether the relevant enzymes are involved in activation of the parent compound to its toxic form or in detoxification. There may also be differences in excretion, particularly in newborns who all have a low glomerular filtration rate and have not developed efficient tubular secretion and resorption capacities (Altman and Dittmer 1974; NRC 1993; West et al. 1948). Children and adults may differ in their capacity to repair damage from chemical insults. Children also have a longer remaining lifetime in which to express damage from chemicals; this potential is particularly relevant to cancer.

Certain characteristics of the developing human may increase exposure or susceptibility, whereas others may decrease susceptibility to the same chemical. For example, although infants breathe more air per kilogram of body weight than adults breathe, this difference might be somewhat counterbalanced by their alveoli being less developed, which results in a disproportionately smaller surface area for alveolar absorption (NRC 1993).

Children as a group have typically not been studied for the adverse effects of overexposure to inorganic manganese. Manganese results in adverse respiratory effects, as well as neurological effects; the latter effects have been the most investigated. As discussed previously, manganism has typically been observed in occupational settings, as in manganese miners, or in isolated cases of extreme exposure to inhaled or ingested manganese. In general, these exposure scenarios do not pertain to children. Reports do exist, however, of incidences of overexposure to inorganic manganese resulting in respiratory illness. Two studies exist that investigated increased respiratory complaints and symptoms at a junior high school situated 100 m from a manganese alloy plant in Japan (manganese concentrations in total dust at a 200 meter perimeter around the plant were  $0.004 \text{ mg/m}^3$  [ $3.7 \text{ } \mu\text{g/m}^3$ ]) (Kagamimori et al. 1973; Nogawa et

## 3. HEALTH EFFECTS

al. 1973). The initial study showed that the incidences of self-reported respiratory illnesses among children in the exposed school were much higher than those of a control school 7 km away from the plant (Nogawa et al. 1973). Further, evaluations of respiratory fitness showed significant decreases in several parameters. When the installation of dust catchers resulted in a decreased manganese concentration in total dust, complaints of illness decreased, and the test results improved (Kagamimori et al. 1973). These respiratory effects were not unique from those observed in adults exposed to airborne manganese. Further, it was not reported if other compounds were present in the dust generated by the plant, which might have contributed to or caused the reported illnesses. It is possible that these effects might have been triggered by the dust and were not specific to manganese.

Studies on potential neurological effects in children from inhalation exposure to excess inorganic manganese are limited. One study showed that a native population living on an island with rich manganese deposits suffered increased neurological disorders and incidences of birth defects (Kilburn 1987); their exposure was most likely via inhalation and oral routes. This study involved small sample sizes and lacked exposure concentrations and a suitable control group; these limitations preclude ascribing these effects to manganese alone.

Children who have been exposed to elevated levels of inorganic manganese presumably through diet (either a normally ingested diet or through total parenteral nutrition, TPN) have shown signs of motor disorders (e.g., dystonia, dysmetria, propulsion, retropulsion, poor check response bilaterally) similar to those observed in cases of frank manganism (Devenyi et al. 1994; Fell et al. 1996). In a few of the cases, the presence of liver dysfunction indicated a decreased ability to clear excess manganese (Devenyi et al. 1994; Fell et al. 1996), but some of the children with apparently normal livers also exhibited motor disorders (Fell et al. 1996). Several children also exhibited hyperintense signals on MRI resulting from increased exposure to manganese due to cholestatic end-stage liver disease (Devenyi et al. 1994) and from high concentrations of the element in TPN, either in the presence (Fell et al. 1996) or absence (Fell et al. 1996; Ono et al. 1995) of liver disease. The Ono et al. (1995) study involved a child on TPN for more than 2 years; although this child did have increased blood manganese and hyperintense signals in the basal ganglia as shown by MRI, the authors did not report any observable signs of neurotoxicity. A similar lack of observable neurotoxicity was reported in two siblings fed TPN with high manganese concentrations (0.2 mmol manganese/kg/day) for several months (the brother for 63 months total starting at age 4 months; the sister for 23 months total starting at age 1 month) (Kafritsa et al. 1998). Both children had elevated blood manganese levels and showed hyperintense signals in the basal ganglia (especially the globus pallidus and subthalamic nuclei) on MRI. Reduction of manganese concentration

## 3. HEALTH EFFECTS

in the TPN resulted in a gradual loss of signal on MRI analysis (becoming comparable to normal scans) and a decrease in blood manganese levels as measured in three subsequent annual exams. These equivocal results indicate that there are considerable differences in susceptibility to the neurotoxic effects of excess manganese in children.

Four reports of manganese neurotoxicity in children have been published recently including: (1) severe managism-like neurotoxic symptoms (inability to stand independently, tendency to fall backward, and development of a “cock-like” walk) in a previously healthy 6-year-old female that were associated with elevated drinking water concentrations of manganese (1.7–2.4 mg manganese/L), pica, a diet high in manganese-rich foods, and elevated levels of plasma manganese (Sahni et al. 2007); (2) inattentiveness and lack of focus in the classroom and low-percentile performance in tests of memory in a 10-year-old male with no history of learning problems associated with elevated manganese in drinking water (1.21 mg manganese/L) (Woolf et al. 2002); (3) a statistically significant relationship for decreasing intelligence scores with increasing manganese levels in drinking water in a cross-sectional epidemiological study of 142 10-year-old children in Bangladesh (Wasserman et al. 2006); and (4) a statistically significant relationship between increased levels of oppositional behaviors and hyperactivity and increased levels of manganese in drinking water in an epidemiological study of 46 children (ages 6–15 years) in Quebec, Canada (Bouchard et al. 2007c). These results provide added weight to the evidence for the neurotoxic potential of excessive manganese in children, but the following uncertainties associated preclude the establishment of causal relationships between the observed effects and manganese exposure: (1) whether or not the observed effects were solely due to excess manganese alone or could have been influenced by other drinking water or dietary components; (2) the lack of information about manganese levels in food and air; and (3) the small sample sizes.

Two other earlier studies show that children who drank water containing manganese at average concentrations of at least 0.241 mg/L (Zhang et al. 1995) and ate food with increased manganese content (He et al. 1994) for 3 years performed more poorly in school (as shown by mastery of their native language, mathematics, and overall grade average) and on the WHO neurobehavioral core test battery than those students who drank water with manganese  $\leq 0.04$  mg/L. These neurobehavioral tests are among those administered to workers occupationally exposed to manganese to determine the presence of early neurological deficit (Chia et al. 1993a; Iregren 1990; Lucchini et al. 1995; Mergler et al. 1994; Roels et al. 1987a, 1992). These concentrations are much lower than the ones to which adults were exposed in the Kondakis et al. (1989) study. In this study, ingestion of drinking water with excess manganese (1.8–2.3 mg/L) was linked to the onset of unspecified neurological symptoms in an aged

## 3. HEALTH EFFECTS

population (average age, over 67 years). Though there are limitations, this and other environmental studies in adults (Baldwin et al. 1999; Beuter et al. 1999; Goldsmith et al. 1990; Kawamura et al. 1941; Kondakis et al. 1989; Mergler et al. 1999) and two studies in children (He et al. 1994; Zhang et al. 1995) indicate that both adults and children can manifest similar neurological deficits that are potentially linked to ingesting excess manganese. However, these reports are lacking well-characterized and quantitative exposure data that would indicate whether children and adults experience neurological effects at the same or different exposure levels. Existing studies do not allow estimations of the quantitative susceptibility of children to the preclinical effects of excess manganese exposure. They do indicate, though, that children can develop symptoms of neurotoxicity after oral exposure to manganese that are similar to those effects seen in adults environmentally or occupationally exposed to the metal. Further, these studies indicate that neurological effects may be a concern for children exposed to excess manganese from the environment or from a hazardous waste site.

The investigations by He et al. (1994) and Zhang et al. (1995) showed that children with poorer school performance had higher manganese hair content than children from the control area. Other studies have found that manganese levels in hair are higher in learning disabled children than in normal children (Collipp et al. 1983; Pihl and Parkes 1977). The route of excess exposure is not known, but it is presumed to be mainly oral. These observations are consistent with the possibility that excess manganese ingestion could lead to learning or behavioral impairment in children. However, an association of this sort is not sufficient to establish a cause-effect relationship since a number of other agents, including lead, might also be involved (Pihl and Parkes 1977).

Developmental studies in animals following inhalation exposure to manganese are sparse. One study exists (Lown et al. 1984) in which pregnant mice were exposed to a high concentration of airborne manganese or filtered air for 17 days preconception and then exposed to either the same concentration of manganese or filtered air postconception. Their pups were then fostered to adult females who had experienced the same inhalation exposures as the mothers (no manganese exposure, pre- or post-conception exposure, or both). The pups of exposed mothers had decreased body weight, but exhibited no differences in activity compared to pups from mothers exposed to air, irrespective of exposure history. In neonatal rats orally exposed to 25 or 50 mg manganese/kg/day from PNDs 1 through 21, manganese concentrations in various brain regions were about 2-fold higher than brain manganese concentrations in adult rats exposed to the same oral dose levels for 21 days (Dorman et al. 2000). At the highest dose level, neonatal rats showed an increased acoustic startle response, but exposure-related changes in other neurological end points (clinical signs, motor activity, and passive avoidance) were not found (Dorman et

## 3. HEALTH EFFECTS

al. 2000). In another recent study, inhalation exposure of female CD rats to manganese sulfate, starting 28 days prior to breeding through PND 18, caused elevated manganese concentrations in exposed maternal rats (compared with air control rats) in the following tissues: brain and placenta at 0.5 and 1.0 mg manganese/m<sup>3</sup> and lung at 0.05, 0.5, and 1.0 mg manganese/m<sup>3</sup> (Dorman et al. 2005a). In contrast, statistically significant elevations of manganese concentrations in sampled fetal tissues were observed only in the liver at 0.5 and 1.0 mg manganese/m<sup>3</sup>, and elevated brain manganese concentrations were only observed in offspring after PND 14. The results from this study suggest that the brain in developing fetuses is partially protected from excess manganese by the placenta, and that the neonatal period is sensitive to increased manganese concentration in brain and other tissues under exposure to elevated airborne manganese concentrations.

Oral studies in animal models, whether involving the dosing of pregnant dams or sucklings, reveal a variety of neurochemical and physiological changes as a result of manganese exposure. The majority of studies have involved manganese chloride. One study in rats reported that pups exposed *in utero* 11 days during gestation to a relatively low concentration of manganese chloride (22 mg/kg; by gavage in water) did not have any observable decrease in weight gain, nor any gross or skeletal malformations upon necropsy (Grant et al. 1997a). Another study (Szakmáry et al. 1995) that also administered manganese chloride in water by gavage to pregnant rats at the slightly higher concentration of the 33 mg manganese/kg/day throughout the entire gestation period reported a delay of skeletal and organ development as well as an increase in skeletal malformations, such as clubfoot, in unborn pups. These malformations, however, were self-corrected in pups allowed to grow to 100 days of age. In addition, the same dose and route did not result in any observable developmental toxicity in the rabbit (Szakmáry et al. 1995). Rat pups exposed during gestation and after birth to manganese at relatively high concentrations of 120–620 mg/kg in drinking water suffered no observable adverse effects at the low dose and only transient adverse effects (decrease in weight and hyperactivity) at the high dose (Pappas et al. 1997). Similar transient body weight decreases and increases in motor activity were observed in neonatal rats administered 22 mg manganese/kg/day (as manganese chloride), by mouth or gavage, for up to 49 days (Brenneman et al. 1999; Dorman et al. 2000).

Rat pups from a generational study in which the male and female parents were exposed to 240–715 mg manganese/kg/day (as manganese chloride in drinking water) in either a diet adequate or deficient in protein (Ali et al. 1983a) suffered a delayed air righting reflex (independent of protein content of diet) and showed significant alterations in the age of eye opening and development of auditory startle when produced by parents fed low-protein diets with 240 mg manganese/kg/day in water. Kontur and Fechter



## 3. HEALTH EFFECTS

(1988) administered up to 1,240 mg manganese/kg/day as manganese chloride in drinking water to pregnant rats during days 0–20 of gestation. Although the authors found increased manganese levels in the fetus, there were no measurable effects on dopamine or norepinephrine turnover in the pup brain, or in the development of a startle response. In a more recent study, an increased amplitude in acoustic startle reflex was observed at PND 21 in neonatal rats administered 22 mg manganese/mg/day (as manganese chloride) by mouth from PND 1 to 21 (Dorman et al. 2000). Significant increases in brain dopamine and DOPAC concentrations in select brain regions in these animals as well as increased brain manganese concentrations were reported. This study demonstrated that neonates treated with manganese showed neurological changes, whereas no effects were observed in the adult animals treated similarly. Jarvinen and Ahlström (1975) fed pregnant rats varying doses of manganese sulfate in food for 8 weeks prior to and during gestation. Fetuses taken at 21 days did not show gross abnormalities, but did have significantly increased body burdens of manganese from mothers fed 187 mg/kg/day.

Neonatal rats given manganese chloride in drinking water for 44 days at a dose of 150 mg manganese/kg/day developed a transient ataxia on days 15–20 of the treatment and had decreased levels of homovanillic acid in the hypothalamus and striatum on day 15 but not day 60 (Kristensson et al. 1986). Neonatal rats given bolus doses of manganese chloride in water of 1 mg manganese/kg/day for 60 days suffered neuronal degeneration and increased monoamine oxidase on days 15 and 30 of the study, but did not show any clinical or behavioral signs of neurotoxicity (Chandra and Shukla 1978). Similarly, neonatal rats given bolus doses of manganese chloride in 5% sucrose at doses of 0, 1, 10 or 20 mg manganese/kg/day for 24 days after birth showed decreased levels of dopamine, but not norepinephrine, in the hypothalamus (Deskin et al. 1980); doses of 20 mg/kg/day caused a decrease of tyrosine hydroxylase activity and an increase in monoamine oxidase activity in the hypothalamus. In a follow-up study, Deskin et al. (1981) gave 0, 10, 15 and 20 mg manganese/kg/day (as manganese chloride in 5% sucrose by gavage) to neonatal rats from birth to age 24 days. The authors found that the highest dose resulted in increased serotonin in the hypothalamus and decreased acetylcholinesterase in the striatum. However, the authors did not indicate that the acetylcholinesterase decrease was important given other mechanisms involved in the metabolism of this neurochemical. Other recent findings from rat studies include increased locomotor activity when dosed with 10 mg/kg cocaine in adulthood (but no increased locomotor activity without cocaine challenge) following oral exposure to 13.1 mg manganese/kg/day (but not 4.4 mg manganese/kg/day) on PNDs 1–21 (Reichel et al. 2006); and impaired olfactory-mediated homing ability and passive avoidance of footshocks in male Sprague-Dawley rats exposed to oral doses of 17.2 mg manganese/kg/day (but not 8.6 mg manganese/kg/day) as manganese chloride on PNDs 1–20 (Tran et al. 2002a, 2002b).

## 3. HEALTH EFFECTS

Several studies evaluated the effects of manganese in the diet on reproductive development in the pre-weanling rodent. Gray and Laskey (1980) fed mice 1,050 mg manganese/kg/day (as manganese tetroxide) in the diet beginning on PND 15 and continuing for 90 days. The manganese caused decreased growth of the testes, seminal vesicles, and preputial gland. Later studies evaluated the effect of excess manganese via the diet and gavage on development of the rat (Laskey et al. 1982, 1985). These studies reported that 350 mg manganese/kg/day (as manganese tetroxide in food fed to pregnant rats and resulting male offspring for a total of 224 days) (Laskey et al. 1982) or 214 mg manganese/kg/day (as manganese tetroxide by gavage in water given for 28 days) (Laskey et al. 1985) reduced testosterone levels in developing rats.

Studies involving intravenous or subcutaneous exposure routes of pregnant dams indicate that doses of manganese chloride as low as 1.1 mg manganese/kg/day administered on GDs 6–17 in the rat (Grant et al. 1997a; Treinen et al. 1995) and 14 mg/kg/day administered on GDs 9–12 in the mouse (Colomina et al. 1996) can result in decreased fetal body weight and skeletal abnormalities.

The data indicate that animals may suffer adverse developmental effects after inhalation, oral, and intravenous exposures of their pregnant mothers, but results are mixed. Taken together, the evidence from environmental studies in humans and studies in animals suggests that younger children can be affected by exposures to excess manganese. Only one study is available that compared the incidence of adverse neurological effects in neonates and adults exposed to excess manganese (Dorman et al. 2000). Another recent study (Dorman et al. 2005b) showed that fetal brains were protected from excess manganese when their mothers were exposed to air concentrations as high as 1 mg manganese/m<sup>3</sup> manganese sulfate for 28 days before mating through PND 18, but increased brain manganese concentrations developed in the offspring by PND 14. Additional information may help to quantitatively characterize the potential differences in susceptibility to manganese-induced effects in young and adult animals.

No studies currently exist on the health effects arising in children as a result of exposure to organic manganese. Therefore, predictions concerning potential effects must be made from extrapolations from existing animal studies.

Weanling mice who ingested 11 mg manganese/kg/day as MMT for 12 months exhibited a significant increase in spontaneous activity at day 80, but no other behavioral differences throughout the exposure

## 3. HEALTH EFFECTS

period (Komura and Sakamoto 1992b). Concentrations of certain neurotransmitters and dopamine metabolites were modified in different brain regions, but the relationship to manganese levels in the affected regions was weak to none (Komura and Sakamoto 1994).

Developmental studies in rats involving intravenous exposure of pregnant dams to mangafodipir during organogenesis (days 6–17) indicate that the compound targets the skeletal system, resulting in irregularly shaped bones at doses as low as 1 mg manganese/kg/day (Grant et al. 1997a; Treinen et al. 1995). Further, application of specific doses of the compound during segmented time periods in organogenesis causes the same skeletal defects (Treinen et al. 1995). When the compound is administered from 22 days prior to conception until GD 7, at up to 6 mg manganese/kg/day, no developmental effects were observed (Grant et al. 1997a). These data further indicate that animals developing during organogenesis are particularly susceptible to developmental toxicity from mangafodipir exposure. Further, behavioral changes and significant decreases in body weight were observed in rat pups delivered from dams dosed with 1.1 mg manganese/kg/day, while decreased survival was observed in pups from dams given 2.2 mg manganese/kg/day on GDs 6–17.

In contrast to the rat, available studies suggest that the rabbit is far less susceptible to the developmental effects of mangafodipir. One study reported only decreased ossification in fetal sternbrae at 1.1 mg manganese/kg/day when given to dams on GDs 6–17 (Grant et al. 1997a); a similar study in the same species reported no observable developmental toxicity at 2.2 mg manganese/kg/day, but a significant decrease in fetal weight and viable fetuses, with no skeletal abnormalities, at a dose of 3.3 mg manganese/kg/day also given during organogenesis (Blazak et al. 1996).

In total, these developmental studies indicate that organic manganese can induce adverse developmental effects in the unborn and young, with effects ranging from slight biochemical changes in the brain to structural changes to changes in functional development. However, the majority of studies have involved very high exposure doses.

The developmental toxicity of elemental manganese has been shown in large part by comparison studies between manganese chloride and mangafodipir (Blazak et al. 1996; Grant et al. 1997a; Treinen et al. 1995). While these studies have provided much information as to the targeted teratogenicity of manganese during organogenesis, they have generally involved intravenous exposures, which are not particularly relevant to the general population. Further, it is likely that the majority of women who may be exposed to mangafodipir are beyond child-bearing age, since clinical subjects with suspected liver

## 3. HEALTH EFFECTS

tumors that merit use of the compound to assist in diagnosis are often over 50 years old (mean values; Bernardino et al. 1992). Should child-bearing women be exposed to the compound in a clinic environment, the doses required to induce developmental toxicity in animals greatly exceed the clinical dose (Blazak et al. 1996; Grant et al. 1997a; Treinen et al. 1995).

The pharmacokinetics of manganese in infants is known to be different than in adults. Balance studies, although limited, show that there is high retention of manganese during the neonatal period (Dorner et al. 1989). Formula-fed infants had an apparent manganese absorption of around 20% (Davidsson et al. 1988; 1989b), compared to absorption in adults, which is shown to be around 3–5% (Mena et al. 1969). The increased absorption may be a compensatory mechanism due to the low concentration of manganese in mother's milk (Collipp et al. 1983; Dorner et al. 1989; Lönnerdal et al. 1987) and to the increased metabolic needs of infants as compared to adults, since manganese is required for adequate bone mineralization, as well as for connective tissue synthesis (Hurley and Keen 1987). Alternatively, the increased absorption may be due to decreased excretion in the very young (Kostial et al. 1978; Lönnerdal et al. 1987; Miller et al. 1975; Rehnberg et al. 1981), although at least one study indicates that both pre-term and full-term infants actively excrete manganese (Dorner et al. 1989). Some studies have indicated that infants, who acquire all of their manganese in the first 4 months of life from human milk or milk formulas, ingest very different amounts of manganese due to the differing manganese content of these food sources. More specifically, studies showed that due to the low manganese concentration of human milk (4–10 µg/L) and its higher concentration in cow's milk formulas (30–75 µg/L) and soy formulas (100–300 µg/L) (Dorner et al. 1989; Lönnerdal et al. 1987), more manganese was absorbed from the formula (with absorption rate from all sources being roughly equal). Recent changes in nutritional status of infant formulas have resulted in a more nutritionally balanced absorption of manganese when compared to human milk and cow's milk formulas (~80–90%), with absorption of manganese from soy milk formulas being slightly lower (~70%; Lönnerdal et al. 1994). However, given the existing differences in inherent manganese concentrations between the different food sources, reports still suggest that infant intake of manganese from milk formulas is 10–50 times that of a breast-fed infant (Lönnerdal 1997). Animal studies show that absorption and/or retention of manganese is similar to that of older animals at approximately post-gestational day 17–18 (Kostial et al. 1978; Lönnerdal et al. 1987; Miller et al. 1975; Rehnberg et al. 1981). However, when this transition takes place in human infants has not been clearly defined.

Animal studies also show increased absorption of manganese in the young. For example, Kostial et al. (1989) found that rat pups retained a greater proportion (67%) of a single oral dose of radiolabeled

## 3. HEALTH EFFECTS

manganese than adult rats (0.18%). Bell et al. (1989) found that manganese absorption in rat pups (using isolated brush border membrane vesicles from the intestine) is nonsaturable and appears to occur primarily by diffusion. In the older rat, however, a high affinity, low capacity, active-transport mechanism for manganese absorption appears to be present (Garcia-Aranda et al. 1983).

Several elements, including iron (Davis et al. 1992a), phosphorus (Wedekind et al. 1991), and calcium (Wilgus and Patton 1939) are known to decrease manganese absorption in adults and animals. Iron-poor diets result in increased manganese absorption in humans (Mena et al. 1969) and in rats (Pollack et al. 1965). These interactions have not been studied in infants or children, but are expected to occur.

Manganese is known to cross the placenta and has been detected in cord blood in healthy full-term and pre-term infants. It is unknown whether mothers exposed to increased concentrations of manganese will pass on toxic amounts of the metal to their unborn children via the blood. However, as manganese is an essential nutrient and is part of the human body at all times, it is expected to be found in all tissues and fluids of the infant. Manganese is also naturally found in breast milk (typical concentrations in mature milk range from 4 to 10 µg/L) (Collipp et al. 1983). No studies exist concerning breast milk concentrations of mothers exposed to increased concentrations of manganese, but milk manganese concentrations increased with increasing exposure levels in lactating female rats exposed by inhalation to manganese sulfate at 0.05, 0.5, or 1 mg manganese/m<sup>3</sup> for 28 days before mating through PND 18 (Dorman et al. 2005a). The mean milk concentration was statistically significantly increased, compared with air control levels, however, only at the highest exposure level. It is unclear if manganese stored in the brain, bone, or in another depot, in excess amounts, could be mobilized to affect a developing fetus. However, one study by Jarvinen and Ahlström (1975) showed that pregnant rats fed 94 mg manganese/kg/day (as manganese sulfate) for 8 weeks accumulated the metal in their livers in contrast to non-pregnant females. Further, at a daily dose of 187 mg/kg/day, increased manganese concentrations were found in 21-day-old fetuses. These data suggest that homeostatic control of pregnant mothers regulated the distribution of the metal at lower concentrations, but this control was circumvented at high daily concentrations, resulting in liver excesses and distribution in the developing fetus. Although the fetuses in this study showed no physical abnormalities, no neurochemical or neurobehavioral studies were performed to determine potential adverse effects on these relevant end points.

Transferrin is one of the proteins responsible for binding and transporting both iron and manganese throughout the body. One study (Vahlquist et al. 1975) reported no correlation between infant cord blood and maternal blood transferrin levels. The same study reported an increase in plasma transferrin from

### 3. HEALTH EFFECTS

1.68±0.60 mg/mL in blood from infants at 6 weeks of age, to a peak of 2.60±0.27 mg/mL at 10 months, with values stabilizing at these adult levels throughout 16 years of age. The authors did not comment as to the statistical difference, if any, of these values.

There are no established biomarkers consistently used as indicators for overexposure to manganese in either adults or children. Elevated blood concentrations and hyperintense signals in the globus pallidus on T1-weighted MRI have been observed in children with increased exposure to manganese (Devenyi et al. 1994; Fell et al. 1996; Kafritsa et al. 1998; Ono et al. 1995). However, the same limitations of these indicators of overexposure in adults (wide range of blood manganese in normal populations, high cost and, hence, low availability of MRI) apply to children. Blood manganese has generally been poorly related to current levels of exposure or cumulative exposure index (Smargiassi and Mutti 1999). Elevated blood manganese alone does not constitute an adequate indicator of manganese overexposure. There are no pediatric-specific biomarkers of exposure or effect. See Section 3.8.1 for further information.

Studies suggest that children may differ from adults in their susceptibility to the toxic effects of manganese due to toxicokinetic differences (i.e., increased absorption and/or retention). Qualitative similarities exist between respiratory and neurological effects seen in adults and children suffering from extreme manganese exposure. While infant and animal studies indicate that the young have an increased uptake of manganese, and distribution of the element in certain tissues may differ with age, studies that reveal quantitative levels of manganese associated with discrete frank effects in both adults and children are lacking. The studies to date (namely absorption, distribution and excretion studies in animals) suggest a pharmacokinetic susceptibility to manganese that is different in children than in adults.

### 3.8 BIOMARKERS OF EXPOSURE AND EFFECT

Biomarkers are broadly defined as indicators signaling events in biologic systems or samples. They have been classified as markers of exposure, markers of effect, and markers of susceptibility (NAS/NRC 1989).

A biomarker of exposure is a xenobiotic substance or its metabolite(s) or the product of an interaction between a xenobiotic agent and some target molecule(s) or cell(s) that is measured within a compartment of an organism (NAS/NRC 1989). The preferred biomarkers of exposure are generally the substance itself, substance-specific metabolites in readily obtainable body fluid(s), or excreta. However, several factors can confound the use and interpretation of biomarkers of exposure. The body burden of a

### 3. HEALTH EFFECTS

substance may be the result of exposures from more than one source. The substance being measured may be a metabolite of another xenobiotic substance (e.g., high urinary levels of phenol can result from exposure to several different aromatic compounds). Depending on the properties of the substance (e.g., biologic half-life) and environmental conditions (e.g., duration and route of exposure), the substance and all of its metabolites may have left the body by the time samples can be taken. It may be difficult to identify individuals exposed to hazardous substances that are commonly found in body tissues and fluids (e.g., essential mineral nutrients such as copper, zinc, and selenium). Biomarkers of exposure to manganese are discussed in Section 3.8.1.

Biomarkers of effect are defined as any measurable biochemical, physiologic, or other alteration within an organism that, depending on magnitude, can be recognized as an established or potential health impairment or disease (NAS/NRC 1989). This definition encompasses biochemical or cellular signals of tissue dysfunction (e.g., increased liver enzyme activity or pathologic changes in female genital epithelial cells), as well as physiologic signs of dysfunction such as increased blood pressure or decreased lung capacity. Note that these markers are not often substance specific. They also may not be directly adverse, but can indicate potential health impairment (e.g., DNA adducts). Biomarkers of effects caused by manganese are discussed in Section 3.8.2.

A biomarker of susceptibility is an indicator of an inherent or acquired limitation of an organism's ability to respond to the challenge of exposure to a specific xenobiotic substance. It can be an intrinsic genetic or other characteristic or a preexisting disease that results in an increase in absorbed dose, a decrease in the biologically effective dose, or a target tissue response. If biomarkers of susceptibility exist, they are discussed in Section 3.10, Populations That Are Unusually Susceptible.

#### **3.8.1 Biomarkers Used to Identify or Quantify Exposure to Manganese**

Manganese can be measured with good sensitivity in biological fluids and tissues (see Section 7.1), and levels in blood, urine, feces, and hair have been investigated as possible biomarkers of exposure. As a group, workers exposed to a mean concentration of 1 mg manganese/m<sup>3</sup> had higher levels of manganese in the blood and the urine than unexposed controls (Roels et al. 1987b). The group average levels in blood appeared to be related to manganese body burden, while average urinary excretion levels were judged to be most indicative of recent exposures. A study by Lucchini et al. (1995) is the only evidence that suggests that blood and urine levels were correlated with manganese exposure on an individual basis. This study differed from others in that it involved exposure to manganese dioxide and measured adverse

## 3. HEALTH EFFECTS

effects in workers after exposure ceased, whereas other studies involved current exposures, and some, like Roels et al. (1987b) involved exposure to numerous manganese compounds (salts and oxides). The findings of Lucchini et al. (1995) suggest that blood and urine levels of manganese, on an individual basis, are positively correlated with exposure levels in the few weeks following cessation of exposure. In a study of chronically exposed workers who were evaluated while exposure was ongoing, Lucchini et al. (1999) found a positive correlation between manganese levels in total dust and in blood of exposed workers. This correlation did not exist for cumulative exposure index and blood levels of the metal.

Other studies have indicated that on an individual basis, the correlation between the level of workplace exposure and the levels in blood or urine is not a reliable predictor of exposure (Jarvisalo et al. 1992; Roels et al. 1987b, 1992; Smyth et al. 1973). However, two studies (Jarvisalo et al. 1992; Roels et al. 1992) suggest that blood and urinary manganese levels may be used to monitor group exposure, such as exposure in an occupational setting. Also, a study (Siqueira et al. 1991) of ferromanganese workers indicated that exposed workers had elevated levels of plasma and urinary urea and decreased levels of urinary calcium, HDL cholesterol, and plasma inorganic phosphate. The study authors concluded that measurement of these parameters may be useful in the early detection of manganese poisoning. Although manganese may play a role in a metabolic pathway or other biological function involving these products, it is unclear what physiological significance these parameters have as related to manganese toxicity. There was no significant correlation between fecal excretion of manganese and occupational exposure to the metal (Valentin and Schiele 1983). A recent study on environmental exposure to manganese (Baldwin et al. 1999) in southwest Quebec, Canada, indicates that significantly higher levels of blood manganese are correlated with high levels of airborne manganese. In this study, air samples were taken in four geographic areas around a former ferroalloy plant (point source for airborne manganese). The air samples, which were for total dust and PM<sub>10</sub> levels, were taken for 3 consecutive days in the summer. Using a geometric algorithm, 297 blood manganese values from nearby residents in seven postal zones were separated into two geographical areas corresponding to the point source. Higher blood manganese values in men and women were located in the geographic area with the higher airborne manganese values. It is notable that the air samples taken were limited in number and were taken only in the summer. However, the authors mentioned that the data were consistent with samples taken in an adjacent urban area and were consistent with potential exposure sources. Further, at the time of sampling, the ferroalloy plant was not in use and exposure data indicated that airborne levels of manganese decreased dramatically at a point 25 km downwind of the plant after the plant closed (Zayed et al. 1994). Thus, manganese exposure of the population in the Baldwin et al. (1999) study is likely to have been greater in the past; current blood manganese levels may be analogous to those observed in occupational workers undergoing



## 3. HEALTH EFFECTS

a forced layoff (Lucchini et al. 1995). These data, combined with the occupational studies, indicate that there may be a plateau level of homeostatic control of the metal. At low levels, blood manganese concentrations would be related to intake from food, water, and air; large differences in individual blood manganese levels would be observed. At high exposure levels, such as in occupational environments, a higher but still non-toxic level of blood manganese may be maintained by homeostatic control (i.e., a plateau level is reached); alternatively, that level may be exceeded.

These data also indicate that blood manganese levels can be an indicator of exposure to environmental manganese. These data indicate that manganese in blood or urine may be useful in detecting groups with above-average current exposure, but that measurements of manganese in these body fluids in individuals may only be related to exposure dose after the exposure has ceased.

In addition to individual variability, another factor that limits the usefulness of measuring manganese in blood, urine, or feces as a measure of excess manganese exposure is the relatively rapid rate of manganese clearance from the body. As discussed in Section 3.4, excess manganese in blood is rapidly removed by the liver and excreted into the bile, with very little excretion in urine (Klaassen 1974; Malecki et al. 1996b). Thus, levels of manganese in blood or urine are not expected to be the most sensitive indicators of exposure.

Serum prolactin (PRL) has been shown to be a possible biomarker of manganese action of dopamine neurotransmission (Smargiassi and Mutti 1999). Manganese acts on the tuberoinfundibular dopaminergic system, which exerts tonic inhibition of PRL secretion. Serum PRL levels observed in workers occupationally exposed to manganese were shown to be consistent with mechanistic studies as they were distinctly higher than unexposed workers. It is still unclear whether or not serum PRL levels indicate recent or cumulative exposure. The value of PRL as a biomarker is called into question by the Roels et al. (1992) study in which serum PRL levels were not increased in workers chronically exposed to airborne manganese.

Lymphocyte manganese-dependent superoxide dismutase activity increases with increased manganese uptake (Yiin et al. 1996). It has been suggested that this enzyme, in conjunction with serum manganese levels, may be helpful in assessing low and moderate levels of manganese exposure (Davis and Greger 1992; Greger 1999). MnSOD has been shown to be elevated in women ingesting 15 mg of supplemental manganese/day, while levels have been shown to be depressed in the heart and liver of manganese deficient animals. MnSOD is important as a possible biomarker because its levels can be related to

## 3. HEALTH EFFECTS

oxidative damage. Its sensitivity as a biomarker depends on factors that induce oxidative stress or effect manganese bioavailability including diets high in polyunsaturated fatty acids and strenuous physical exercise (Greger 1999).

Brain MRI scans and a battery of specific neurobehavioral tests (Greger 1998) may be useful in assessing excessive manganese exposure even among industrial workers exposed to airborne manganese (Nelson et al. 1993). These scans also have been successfully used to identify accumulation of manganese in the brains of children exposed to excess manganese (Devenyi et al. 1994; Fell et al. 1996; Ihara et al. 1999; Kafritsa et al. 1998; Ono et al. 1995; Sahni et al. 2007). Levels in feces could be useful in evaluating relatively recent high-level exposures but would not be expected to be helpful in detecting chronic low-level exposures. These methods are potentially useful biomarkers, but require additional evaluation to determine their validity.

While it is well established that exposure to excess manganese can result in increased tissue levels in animals, the correlations among exposure levels, tissue burdens, and health effects have not been thoroughly investigated in humans or animals. Also, since homeostatic mechanisms largely prevent fluctuations of manganese concentration in whole blood and since manganese is mainly excreted by the biliary route, it is not believed possible to identify a biological marker to assess the intensity of exposure or concentration in the target organ (Lauwerys et al. 1992). As noted by Rehnberg et al. (1982), manganese levels in tissues are subject to homeostatic regulation via changes in absorption and/or excretion rates. While exposure to very high levels may overwhelm these mechanisms, continuous exposure to moderate excesses of manganese does not appear to cause a continuous increase in tissue levels (Rehnberg et al. 1982). Moreover, even if tissue levels are increased in response to above-average exposure, levels are likely to decrease toward the normal level after exposure ceases. For example, the level of manganese in the brain of a subject with severe manganism was not different from the normal level (Yamada et al. 1986). For these reasons, measurement of tissue levels of manganese at autopsy or possibly biopsy may be of some value in detecting current exposure levels but is not useful in detecting past exposures. Evaluation of manganese exposure by analysis of tissue levels is also not readily applicable to living persons except through the collection of biopsy samples.

MRI has been used to track manganese distribution in the brains of monkeys (Dorman et al. 2006b; Newland and Weiss 1992; Newland et al. 1989) and humans (Kafritsa et al. 1998; Klos et al. 2005; Nolte et al. 1998; Park et al. 2003; Rose et al. 1999; Uchino et al. 2007; Wolters et al. 1989). In addition, it has been used to assay hyperintense signaling in the globus pallidus and other brain areas of individuals with

## 3. HEALTH EFFECTS

chronic liver disease (Devenyi et al. 1994; Hauser et al. 1994, 1996; Klos et al. 2005; Nolte et al. 1998; Park et al. 2003; Pomier-Layrargues et al. 1998; Spahr et al. 1996; Uchino et al. 2007), individuals on chronically-administered TPN (Kafritsa et al. 1998; Nagatomo et al. 1999; Ono et al. 1995), and individuals with symptoms characteristic of manganism (Nelson et al. 1993). Although data addressing the sensitivity and specificity of MRI as an indicator for body burden or exposure are limited, the technique is being used to identify individuals who are likely to have increased stores of manganese in brain and potentially in other tissues, as well. For example, the hyperintense signaling in the brain is typically coincident with elevated blood manganese levels (Devenyi et al. 1994; Hauser et al. 1994, 1996; Kafritsa et al. 1998; Klos et al. 2005; Nagatomo et al. 1999; Nolte et al. 1998; Ono et al. 1995; Park et al. 2003; Pomier-Layrargues et al. 1998; Spahr et al. 1996; Uchino et al. 2007). Dorman et al. (2006b) evaluated the use of the pallidal index (PI—ratio of hyperintensities in the globus pallidus and the adjacent subcortical frontal white matter) and the T1 relaxation rate (R1) from MRI to reflect manganese concentrations determined by analytical chemistry in brain regions of monkeys repeatedly exposed by inhalation to aerosols of manganese sulfate at several concentrations  $\geq 0.06$  mg. Increases in the PI and R1 were correlated with the pallidal manganese concentration, but increased manganese concentrations in white matter confounded the PI measurements. Dorman et al. (2006b) suggested that R1 can be used to estimate regional brain manganese concentrations and that this technique may be used as a reliable biomarker of occupational manganese exposure.

Neutron activation has been shown to be a possible means of *in vivo* measurement of manganese in the liver and possibly other tissues and organs, including the brain (Arnold et al. 1999; Rose et al. 1999). Minimum detection levels are low enough to distinguish between normal and elevated concentrations.

Scalp hair has also been investigated as a possible biomarker of manganese exposure. While some studies have found a correlation between exposure level and manganese concentration in hair (Collipp et al. 1983), use of hair is problematic for several reasons. For example, exogenous contamination may yield values that do not reflect absorbed doses, and hair growth and loss limit its usefulness to only a few months after exposure (Stauber et al. 1987). Manganese has also been reported to have a strong affinity for pigmented tissues (Lydén et al. 1984), and Hurley and Keen (1987) and Sturaro et al. (1994) have reported that manganese concentrations in hair vary with hair color. Further, hair may be contaminated by dye, bleaching, or other materials. Thus, it is not surprising that other studies have found no correlation between individual hair levels and the severity of neurological effects in manganese-exposed persons (Stauber et al. 1987). A study that investigated the correlation between potentially toxic metal content in hair and violent behavior found an association between manganese and violent behavior, but it

### 3. HEALTH EFFECTS

was not conclusively established that manganese was the causative factor (Gottschalk et al. 1991). He et al. (1994) observed that poor performance in school and on neurobehavioral tests was inversely correlated with hair levels of manganese. The manganese exposure in this study was via drinking water and certain foods. Several studies have found that manganese levels in hair are higher in learning disabled children than in nondisabled children (Collipp et al. 1983; Pihl and Parkes 1977). The route of excess exposure is not known but is presumed to be mainly oral. However, an association of this sort is not sufficient to establish a cause-effect relationship since a number of other agents, including lead, might also be involved (Pihl and Parkes 1977). Other studies have found statistically significant associations between hair manganese levels and behavioral deficits (Bouchard et al. 2007c; Wright et al. 2006). These studies suggest that hair manganese levels can provide meaningful exposure assessments.

Clara cell protein CC16 is a potential biomarker for exposure to MMT, because the protein decreases in both BALF and serum following MMT exposure (Bernard and Hermans 1997; Halatek et al. 1998), possibly due to decreased synthesis and/or protein secretion due to loss of producing cells (Halatek et al. 1998). The protein can be quantified in serum or urine, but no dose-response studies on the potential biomarker have been performed.

There are no known biomarkers of exposure that are specific for children; any biomarkers applicable for use in adults should be applicable for children. For example, manganese-induced hyperintense signals on MRI have been seen in children (Devenyi et al. 1994; Kafritsa et al. 1998; Ono et al. 1995; Sahni et al. 2007) as well as adults (Hauser et al. 1994, 1996; Nagatomo et al. 1999; Pomier-Layrargues et al. 1998; Spahr et al. 1996).

#### **3.8.2 Biomarkers Used to Characterize Effects Caused by Manganese**

The principal adverse health effects associated with exposure to manganese are respiratory effects (lung inflammation, pneumonia, reduced lung function, etc.) and the neurological syndrome of manganism and preclinical neurological effects. Although the respiratory effects are similar in many different exposure studies (Kagamimori et al. 1973; Lloyd Davies 1946; Nogawa et al. 1973), there are no specific biomarkers of effect other than reduced lung function. The fully developed disease can be diagnosed by the characteristic pattern of symptoms and neurological signs (Mena et al. 1967; Rodier 1955), but the early signs and symptoms are not specific for manganese. Careful neurological and psychomotor examination in conjunction with known exposure to manganese may be able to detect an increased incidence of preclinical signs of neurological effects in apparently healthy people (Iregren 1990; Roels

## 3. HEALTH EFFECTS

et al. 1987a). However, these signs are not sufficiently specific for preclinical effects of manganese to reliably identify whether an individual has been exposed to excess levels for a prolonged period. In addition, no biochemical indicator is currently available for the detection of the early neurotoxic effects of manganese. There are no specific biomarkers that would clearly indicate long-term exposure to excess manganese.

Idiopathic Parkinsonism and manganism can be difficult to distinguish due to some similarity in the symptoms (Kim et al. 1999). Idiopathic Parkinsonism is marked by neurodegeneration in the dopaminergic nigrostriatal pathway, while manganism induced damage occurs postsynaptic to the nigrostriatal system. PET with  $^{18}\text{F}$ -dopa afforded a differentiation between manganism and idiopathic Parkinsonism in isolated patients with manganese exposure by indexing the integrity of the dopaminergic nigrostriatal pathway.

Measurement of altered levels of dopamine and other neurotransmitters in the basal ganglia has proven to be a useful means of evaluating central nervous system effects in animals (e.g., Bonilla and Prasad 1984; Eriksson et al. 1987a, 1987b), and these changes are often observed before any behavioral or motor effects are apparent (Bird et al. 1984). No noninvasive methods are currently available to determine whether there are decreased dopamine levels in the brain of exposed humans, but decreased urinary excretion of dopamine and its metabolites has been noted in groups of manganese-exposed workers (Bernheimer et al. 1973; Siqueira and Moraes 1989). However, the relationship between manganese effects on peripheral versus central dopamine levels has not been clearly defined, and given the lack of change in dopamine content in substantia nigra of humans exposed to manganese, the relevance of the animal studies to central nervous system disorder is questionable.

Smargiassi et al. (1995) evaluated platelet monoamine oxidase (MAO) and serum dopamine  $\beta$ -hydroxylase (DBH) activities in 11 men occupationally exposed to manganese via inhalation in a ferroalloy plant. Exposed workers, in general, had lower MAO activities, but similar DBH activities, in comparison to 15 nonexposed control males. However, a positive dose-effect relationship was observed in the exposed group between a Cumulative Exposure Index (CEI) and DBH activity ( $r^2=0.40$ ,  $p<0.05$ ). The CEI took into account the average annual respirable or total manganese concentrations in dust, the ventilation characteristic of each working area, the number of years that each worker spent in a given area, and all of the areas that a worker had been during his job history. The authors proposed that DBH, which is an expression of catecholamine release, might be increasing dose-dependently in response to reduced turnover of MAO. The authors cautioned however, that while the data appear interesting, they

### 3. HEALTH EFFECTS

should be investigated in a larger study population, with careful analysis of possible confounding factors (Smargiassi et al. 1995).

Reduced urinary excretion of 17-ketosteroids (perhaps as a consequence of decreased testosterone production) has been noted in many patients with neurological signs of manganism (Rodier 1955), but it has not been determined whether this change is detectable prior to the occurrence of neurological effects. Although the urinary excretion of manganese is generally not related to oral manganese intake, Davis and Greger (1992) have suggested that the concentration of manganese in serum, combined with lymphocyte manganese-dependent superoxide dismutase activity, may be helpful in assessing low and moderate levels of manganese exposure. Manganese superoxide dismutase is activated by manganese, thus it is sensitive to the overall manganese balance. Therefore, increased manganese concentrations will affect an increased manganese superoxide dismutase level. There is no clear link between activity of superoxide dismutase and the harmful effects of manganese. Therefore, the potential usefulness of this technique as a biomarker of effect requires further evaluation.

The Clara cell protein CC16 is a potential biomarker for pulmonary effects from exposure to MMT (Bernard and Hermans 1997; Halatek et al. 1998). Damage of Clara cells by MMT causes a significant reduction in the levels of this protein in the BALF, but does not affect its level in serum. The protein can be quantified in serum or urine as well. However, no dose-response studies on the potential biomarker have been performed. Further, the protein has only been studied following intraperitoneal administration of MMT. It is unknown if CC16 levels will change following other exposure pathways.

For more information on biomarkers for renal and hepatic effects of chemicals see ATSDR/CDC Subcommittee Report on Biological Indicators of Organ Damage (Agency for Toxic Substances and Disease Registry 1990) and for information on biomarkers for neurological effects see OTA (1990).

### 3.9 INTERACTIONS WITH OTHER CHEMICALS

There is clear evidence from studies in animals that the gastrointestinal absorption (and hence the toxicity) of manganese is inversely related to dietary iron concentrations. That is, high levels of nonheme iron lead to decreased manganese absorption and toxicity, and low levels of iron lead to increased manganese absorption and toxicity (Chandra and Tandon 1973; Davis et al. 1992a, 1992b; Diez-Ewald et al. 1968; Rehnberg et al. 1982). Conversely, high levels of dietary manganese lead to decreased iron absorption (Davis et al. 1992b; Diez-Ewald et al. 1968; Garcia et al. 2006, 2007; Li et al. 2006;

## 3. HEALTH EFFECTS

Rossander-Hulten et al. 1991; Thomson et al. 1971). Short-term effects of this sort are believed to be the result of kinetic competition between iron and manganese for a limited number of binding sites on intestinal transport enzymes (Thomson et al. 1971), while longer-term effects of iron deficiency or excess are thought to be due to adaptive changes in the level of intestinal transport capacity (Cotzias 1958). The studies reporting competition between iron and manganese in absorption clearly indicate the impact an iron-poor diet will have on manganese uptake in the human (Chandra and Tandon 1973; Davis et al. 1992a, 1992b; Diez-Ewald et al. 1968; Mena et al. 1969; Rehnberg et al. 1982; Thomson et al. 1971). Further, competition between manganese and iron at the blood-brain barrier has been reported (Aschner and Aschner 1990), indicating that excesses of either metal will affect the brain distribution of the other. Johnson and Korynta (1992) found that, in rats, dietary copper can also decrease manganese absorption and increase manganese turnover; dietary ascorbate supplementation had minimal effects on manganese absorption. However, there is insufficient information to determine the significance of these observations for health effects in humans exposed to copper and manganese by the oral route.

Mn(II) pretreatment reduces Cd(II)-induced lethality (Goering and Klaassen 1985). Cadmium has been noted to have an inhibitory effect on manganese uptake (Gruden and Matausic 1989). In addition, manganese appears to be capable of increasing the synthesis of the metal-binding protein metallothioneine (Waalkes and Klaassen 1985). Data from a study by Goering and Klaassen (1985) suggest that manganese pretreatment increases the amount of Cd<sup>+2</sup> bound to metallothioneine, thereby decreasing hepatotoxicity due to unbound Cd<sup>+2</sup>. The significance of these observations for health effects in humans exposed to cadmium and manganese by the oral or inhalation routes is not clear.

High dietary intakes of phosphorus (Wedekind et al. 1991) and calcium (Wilgus and Patton 1939) were shown to depress manganese utilization in chicks. Low levels of calcium and iron may act synergistically to affect manganese toxicity by increasing absorption, but it is not known whether ensuring iron plus calcium sufficiency will reduce the toxic effects of manganese once it has been absorbed (Cawte et al. 1989). Thus, the importance of these observations to humans exposed to manganese by the oral or inhalation routes is not clear.

Ethanol has been suspected of increasing the susceptibility of humans to manganese toxicity (e.g., Rodier 1955), but evidence to support this is limited. Singh et al. (1979) and Shukla et al. (1976) reported that concomitant exposure of rats to ethanol and manganese (as manganese chloride in drinking water) led to higher levels of manganese in the brain and liver than if manganese were given alone; the higher levels were accompanied by increased effects as judged by various serum or tissue enzyme levels (Shukla et al.

### 3. HEALTH EFFECTS

1978). Although the authors referred to these effects as "synergistic," the data suggest that the effects were more likely additive. Based on the report in humans and evidence in animals, the effects of manganese on humans may be enhanced by the consumption of ethanol, but additional investigation is needed.

There is some evidence from a study in animals that chronic administration of drugs such as chlorpromazine (an antipsychotic) results in increased levels of manganese in the brain, including the caudate nucleus (Weiner et al. 1977). Chronic chlorpromazine treatment sometimes results in tardive dyskinesia, and manganese deposition in the brain might contribute to this condition. It has not been determined whether excess manganese exposure increases the risk of chlorpromazine-induced dyskinesia.

Intramuscular injection of animals with metallic nickel or nickel disulfide ( $\text{Ni}_3\text{S}_2$ ) normally leads to a high incidence of injection-site sarcomas, but this increased incidence is reduced when the nickel is injected along with manganese dust (Sunderman et al. 1976). The mechanism of this effect is not clear, but natural killer cell activity normally undergoes a large decrease following nickel injection, and this is prevented by the manganese (Judde et al. 1987). However, the significance that these observations have for human health effects resulting from exposure to nickel and/or manganese by the oral or inhalation routes is not clear.

One study found that allopurinol, when administered orally to rats, antagonized the oxidative effects of manganese in the striatum and brainstem (Desole et al. 1994). The authors suggest that allopurinol, a xanthine oxidase inhibitor, may exert its protective effect by inhibiting both dopamine oxidative metabolism and xanthine oxidase-mediated production of reactive oxygen species.

#### **3.10 POPULATIONS THAT ARE UNUSUALLY SUSCEPTIBLE**

A susceptible population will exhibit a different or enhanced response to manganese than will most persons exposed to the same level of manganese in the environment. Reasons may include genetic makeup, age, health and nutritional status, and exposure to other toxic substances (e.g., cigarette smoke). These parameters result in reduced detoxification or excretion of manganese, or compromised function of organs affected by manganese. Populations who are at greater risk due to their unusually high exposure to manganese are discussed in Section 6.7, Populations with Potentially High Exposures.



## 3. HEALTH EFFECTS

A number of researchers have observed that there is a wide range in individual susceptibility to the neurological effects of inhaled manganese dusts (Rodier 1955; Schuler et al. 1957; Smyth et al. 1973; Tanaka and Lieben 1969). For example, Rodier (1955) reported that the majority of manganism cases in miners occurred after 1–2 years of exposure to the metal, with only six cases observed occurring with 1–3 months exposure. Schuler et al. (1957) showed that in his group of miners, the average time for manifestation of manganism was 8 years, 2 months, with a minimum exposure of 9 months required for symptoms to present. However, the reason for this variable susceptibility is not clear. One likely factor is a difference in work activities and level of exertion. Another is that rates of manganese absorption and/or excretion can vary widely among individuals (Saric et al. 1977a). These toxicokinetic variations may be due to differences in dietary levels of iron and differences in transferrin saturation (Chandra and Tandon 1973; Davis et al. 1992a, 1992b; Mena et al. 1969; Thomson et al. 1971), to differences in dietary levels of other metals (Chowdhury and Chandra 1987; Gruden and Matausic 1989) or of calcium (Cawte et al. 1989), or to different levels of alcohol ingestion (Schafer et al. 1974). Another factor that might be relevant is dietary protein intake: low-level protein intake appears to increase the effect of manganese on brain neurotransmitter levels in exposed animals (Ali et al. 1983a, 1983b, 1985). However, a genetic basis for the wide difference in susceptibility cannot be ruled out.

One group that has received special attention as a potentially susceptible population is the very young. This is mainly because a number of studies indicate that neonates retain a much higher percentage of ingested or injected manganese than adults, both in animals (Keen et al. 1986; Kostial et al. 1978; Rehnberg et al. 1980) and in humans (Zlotkin and Buchanan 1986). The basis for high manganese retention in neonates is not certain, but is presumably a consequence of increased absorption (Mena et al. 1974; Rehnberg et al. 1980) and/or decreased excretion (Kostial et al. 1978; Miller et al. 1975; Rehnberg et al. 1981), possibly because maternal milk is low in manganese (Ballatori et al. 1987). Regardless of the mechanism, the result of the high retention is increased levels of manganese in the tissue of exposed neonatal animals (Miller et al. 1975; Rehnberg et al. 1980, 1981), especially in the brain (Kontur and Fechter 1985, 1988; Kostial et al. 1978; Kristensson et al. 1986; Miller et al. 1975; Rehnberg et al. 1981). This increase has caused several researchers to express concern over possible toxic effects in human infants exposed to manganese in formula (Collipp et al. 1983; Keen et al. 1986; Zlotkin and Buchanan 1986). At least one recent report indicates that an infant's rate of absorption of manganese from infant formulas, cow's milk, and breast milk is similar (Lönnerdal et al. 1994), resulting mainly from recent modifications to formulas to optimize the bioavailability of several essential minerals. There is some limited evidence that prenatal or neonatal exposure of animals to elevated levels of manganese can lead to neurological changes in the newborn (Ali et al. 1983a; Chandra and Shukla 1978; Deskin et al. 1980,

## 3. HEALTH EFFECTS

1981; Dorman et al. 2000; Kristensson et al. 1986); other studies have either not observed any neurochemical or neurophysiological effects in young animals exposed to excess manganese or the effects have been transient (Kontur and Fechter 1988; Kostial et al. 1978; Pappas et al. 1997). Currently, there is only one report that indicates that neonatal animals showed adverse neurological effects at a dose of manganese that had no effect on adults (Dorman et al. 2000). Brain concentrations of manganese were elevated in the neonates, but not in the adult animals given comparable doses of manganese for similar durations. The concern is that the young may be more susceptible due to increased absorption and/or retention and the potential toxicity from higher circulating levels of the metal. A few studies have reported increased blood and brain levels of the metal, either because of an inability to clear manganese due to chronic liver disease (Devenyi et al. 1994) or to an excess in parenteral nutrition (Kafritsa et al. 1998; Ono et al. 1995). However, observable neurological signs associated with manganese toxicity were only reported in the case of chronic liver disease (Devenyi et al. 1994). Although data suggest that children, particularly infants, are potentially more susceptible to the toxic effects of manganese, available evidence indicates that individual susceptibility varies greatly. Current information is not sufficient to quantitatively assess how susceptibility in children might differ from adults.

Elderly people might also be somewhat more susceptible to manganese neurotoxicity than the general population. Neurological effects were observed in older persons consuming manganese levels similar to levels found in U.S. surface water and groundwater (Deverel and Millard 1988; EPA 1984; Kondakis et al. 1989). The neurological effects observed in a group of families exposed to manganese in their drinking water were reportedly more severe among the older persons, whereas there was little effect in the youngest (Kawamura et al. 1941). Further, occupational studies indicate that older workers represent the largest numbers of manganese poisoning cases (Rodier 1955; Tanaka and Lieben 1969). More recent occupational (Crump and Rousseau 1999; Gibbs et al. 1999) and environmental (Mergler et al. 1999) manganese exposure studies indicate that increasing age was a factor in poorer performance on certain neurobehavioral tests. For example, Beuter et al. (1999) and Mergler et al. (1999) reported that performance on tests that required regular, rapid, and precise pointing movements was significantly decreased in exposed individuals, especially in those 50 years of age and over with high blood manganese levels. These reports suggest that older persons may have a greater susceptibility to adverse effects from inhaled or ingested manganese. One factor that could contribute to this increased susceptibility is a loss of neuronal cells due to aging or to accumulated neurological damage from other environmental neurotoxicants (Silbergeld 1982). Homeostatic mechanisms might become less effective in aged populations, which leads to higher tissue levels of manganese following exposure (Silbergeld 1982).

## 3. HEALTH EFFECTS

Mena et al. (1969) noted that the oral absorption of manganese was increased in individuals with iron-deficiency anemia. Altered nutritional status might be another predisposing factor. The inverse relationship of manganese absorption and iron-status has also been reported in animal models (Davis et al. 1992a, 1992b). It has been suggested that anemic persons may be more susceptible to the toxic effects of manganese because of enhanced absorption of iron and manganese through similar uptake mechanisms (Cotzias et al. 1968). Baldwin et al. (1999) reported an inverse relationship between serum iron and blood manganese levels in individuals environmentally exposed to airborne manganese.

Another group of potential concern is people with liver disease. This is because the main route of manganese excretion is via hepatobiliary transport (see Section 3.4.4), so individuals with impaired biliary secretion capacity would be expected to have a diminished ability to handle manganese excesses. In support of this hypothesis, Hambidge et al. (1989) reported that in a group of infants and children receiving parenteral nutrition, children with liver disease had higher average plasma concentrations of manganese than children without liver disease. Devenyi et al. (1994) also observed increased blood manganese concentrations, abnormal MRI scans indicative of increased manganese in the brain, and dystonia similar to that of patients with manganism, in an 8-year-old girl suffering from cholestatic liver disease. Hauser et al. (1994) reported increased blood and brain manganese in two patients with chronic liver disease and one with cirrhosis of the liver and a portacaval shunt. All three exhibited some form of neuropathy, including postural tremor of the upper extremities and a general lack of alertness, along with failure to concentrate and follow simple commands. In a later study, Hauser et al. (1996) did not observe movement disorders, but did observe the increased blood manganese concentrations and abnormal MRI scans in a group of adults with failing livers. Other studies have shown the link between increased deposition of manganese in the blood and/or the brains of humans with cirrhosis of the liver or chronic liver disease (Pomier-Layrargues et al. 1998; Rose et al. 1999; Spahr et al. 1996).

Patients on parenteral nutrition may be at risk for increased exposure to manganese. Forbes and Forbes (1997) observed that 31 of 32 adults treated with total parenteral nutrition (TPN) due to intestinal failure had increased manganese concentrations in their blood. Nagatomo et al. (1999) observed elevated blood manganese levels and hyperintense signals in the basal ganglia upon T1-weighted MRI in two elderly patients receiving TPN. Both patients exhibited severe symptoms associated with manganese exposure (masked facies, marked rigidity, hypokinesia). When manganese supplementation in the TPN was reduced, the blood and brain levels returned to normal.

## 3. HEALTH EFFECTS

Children receiving parenteral nutrition have also been shown to have increased blood manganese concentrations with accompanying hyperintense signals in the globus pallidus as observed by MRI (Fell et al. 1996; Kafritsa et al. 1998; Ono et al. 1995). Fell et al. (1996) studied a group of 57 children receiving parenteral nutrition, 11 of whom had a combination of hypermanganesemia and cholestasis. Four of these 11 patients died; the 7 survivors had whole blood manganese concentrations ranging from 34–101 µg/L. Four months after reduction or removal of manganese from the supplementation, the blood concentration of manganese decreased by a median of 35 µg/L. Two of the seven survivors had movement disorders, one of whom survived to have a MRI scan. The scan revealed bilateral symmetrically increased signal intensity in the globus pallidus and subthalamic nuclei. These signals were also observed in five other children—one from the original group exhibiting cholestasis with hypermanganesemia and five more given parenteral nutrition chronically with no liver disease. These results indicate that the cholestatic condition is not necessary for manganese to accumulate in the brain. A supporting study is provided by Ono et al. (1995) who observed increased blood manganese concentrations and hyperintense signals on MRI in the brain of a 5-year-old child on chronic parenteral nutrition due to a gastrointestinal failure. Five months after the manganese was removed from the parenteral solution, blood manganese levels returned to normal, and the brain MRI scans were almost completely free of abnormal signals. Further, the authors reported no neurological effects from exposure to manganese. Kafritsa et al. (1998) reported results similar to those of Ono et al. (1995). In the latter study, two siblings, one 9 years old and the other 2 years old, had been administered TPN chronically since the ages of 4 and 1 month(s), respectively. While elevated blood and brain manganese levels were reported (via laboratory analyses and MRI), no adverse neurological or developmental effects were observed. Once the manganese supplementation was reduced, the MRI signals abated, and the blood manganese levels returned to a normal range.

Although human interindividual variability is great concerning the ability to tolerate excess amounts of manganese in the body, these data indicate that, in general, children and the elderly may be more susceptible than young and middle-aged adults due to differential toxicokinetics and potential adverse effects superimposed on normal decline in fine motor function with age.

With respect to the respiratory effects of inhaled manganese (e.g., bronchitis, pneumonitis), people with lung disease or people who have exposure to other lung irritants may be especially susceptible. This is supported by the finding that the inhalation of manganese dusts by manganese alloy workers caused an increased incidence of respiratory symptoms (e.g., wheezing, bronchitis) in smokers, but not in nonsmokers (Saric and Lucic-Palaic 1977b).

## 3. HEALTH EFFECTS

**3.11 METHODS FOR REDUCING TOXIC EFFECTS**

This section will describe clinical practice and research concerning methods for reducing toxic effects of exposure to manganese. However, because some of the treatments discussed may be experimental and unproven, this section should not be used as a guide for treatment of exposures to manganese. When specific exposures have occurred, poison control centers and medical toxicologists should be consulted for medical advice. The following texts provide specific information about treatment following exposures to manganese.

Leikin JB, Paloucek JB. 2002. Leikin and Paloucek's poisoning and toxicology handbook. Hudson, OH: Lexi-Comp, Inc., 773-774.

Schonwald S. 2004. Manganese. In: Dart RC, eds. Medical toxicology. 3rd ed. Philadelphia, PA: Lippicott Williams & Wilkins, 1433-1434.

WHO. 1999. Concise international chemical assessment document 12. Manganese and its compounds. Geneva: United Nations Environment Programme. International Labour Organisation. World Health Organization. <http://whqlibdoc.who.int/publications/1999/924153012X.pdf>. August 04, 2008.

**3.11.1 Reducing Peak Absorption Following Exposure**

There is substantial evidence to indicate that an interaction between iron and manganese occurs during intestinal absorption (Chandra and Tandon 1973; Diez-Ewald et al. 1968; Keen and Zidenberg-Cher 1990; Mena et al. 1969; Rehnberg et al. 1982). Cawte et al. (1989) cite low levels of iron and calcium as "synergistic factors" that impact on the toxic effects associated with manganese exposures. In a dietary study investigating the effects of copper, iron, and ascorbate on manganese absorption in rats, these substances were all found to influence manganese absorption, depending in part on their relative concentrations (Johnson and Korynta 1992).

Evidence from these reports suggests that it may be possible to reduce the uptake of manganese and thereby circumvent the potential for toxic effects caused by current and future exposure to excess manganese through specific dietary supplementation. For example, sufficient iron or calcium stores, as opposed to a deficiency in these or other minerals, may reduce manganese absorption, and thus reduce potential toxicity. It is not known whether ensuring iron and calcium sufficiency will reduce the toxic effects of manganese once it has been absorbed into the body because information on critical levels of manganese at target sites is not available. No consistent clinical data are available documenting benefit from ipecac or dilution after ingestion of metallic, inorganic, or organic manganese (Schonwald 2004).

## 3. HEALTH EFFECTS

**3.11.2 Reducing Body Burden**

Inhaled manganese is readily absorbed by the lungs, although some may be retained there. Larger particles of dust containing manganese may be transported by mucociliary transport from the throat to the gut (Drown et al. 1986). Manganese in the gut may be directly absorbed either by a simple diffusion process (Bell et al. 1989) or by a high-affinity, low-capacity, active-transport mechanism (Garcia-Aranda et al. 1983). Once in the plasma, manganese is reportedly transported by transferrin; however, information on the mechanism of uptake in extrahepatic tissues is limited (Keen and Zidenberg-Cher 1990).

In severe cases of manganese poisoning, chelation therapy may be recommended in order to reduce the body burden of manganese and to help alleviate symptoms. Chelation therapy with agents such as ethylenediaminetetraacetic acid (EDTA) may alleviate some of the neurological signs of manganism, but in cases where it has been used, not all patients have shown improvement, and some of the improvements have not always been permanent (Cook et al. 1974; Schonwald 2004). Nagatomo et al. (1999) recently reported the use of Ca-EDTA treatment to reduce the body burden of two elderly patients with increased blood and brain levels of manganese. These patients exhibited masked faces, hypokinesia, and rigidity that are among the clinical signs of manganese poisoning. The potential use of calcium disodium ethylenediaminetetracetate (CaNa<sub>2</sub> EDTA) for the management of heavy metal poisoning was investigated in dogs by Ibim et al. (1992). CaNa<sub>2</sub> EDTA-treated dogs (without excess manganese exposure) were found to have decreased manganese levels in their hair. It is possible that the decrease was partially associated with mobilization and redistribution of this element from storage as well as from soft tissues. The authors, however, cautioned that the use of CaNa<sub>2</sub> EDTA could adversely affect the metabolism of manganese.

In an attempt to treat seven welders with manganism, a solution of 20% CaNa<sub>2</sub> EDTA was administered intravenously at the dose of 1.0 g daily for 3 days followed by a pause for 4 days. The therapy continued for 2–4 courses of this treatment, depending upon the improvement of symptoms. The symptoms, as well as blood manganese concentrations and urinary manganese concentrations, were monitored before and after each course of treatment. EDTA treatment resulted in increased manganese excretion in urine and decreased manganese concentrations in the blood; however, the patients did not show significant improvement in their symptoms (Crossgrove and Zheng 2004). A lack of improvement after EDTA chelation has also been observed in an additional case study of an adult worker (Jiang et al. 2006). It is

## 3. HEALTH EFFECTS

postulated that four carboxyl groups in the EDTA structure, which are essential to its chelating property, render the molecule poorly lipophilic, thus preventing it from effectively crossing the blood-brain barrier. Thus, EDTA appears to successfully chelate and remove the extracellular manganese ions in the blood, but with limited access to brain parenchyma, it cannot effectively chelate and remove manganese ions from the brain. Because EDTA cannot significantly remove manganese from damaged neurons, it appears to be of very limited therapeutic value for more advanced cases of manganism.

Cyclohexylene-aminotetraacetic acid (CDTA) and dimercaptol-1-propanesulphonic acid sodium salt (DTPA) were shown to decrease tissue manganese content in rats following inhalation exposure, but it is unknown whether the effects of manganese were alleviated (Wieczorek and Oberdörster 1989a, 1989b).

The use of the anti-tuberculosis drug para-aminosalicylic acid (PAS) to treat manganism has been reported (Jiang et al. 2006). The patient in this case study had palpitations, hand tremor, lower limb myalgia, hypermyotonia, and a distinct festinating gait. She received 6 g PAS per day through an intravenous drip infusion for 4 days and rest for 3 days. Fifteen courses of this treatment were administered to the patient. At the end of PAS treatment, the patient's symptoms were reportedly significantly alleviated, and handwriting recovered to normal. A reexamination at 17 years after PAS therapy found a general normal presentation in clinical, neurologic, brain MRI, and handwriting examinations. Her gait improved, and although it did not improve to an entirely normal status, it could be described as passable. A literature survey of more than 90 cases using PAS (Jiang et al. 2006) indicates a significant therapeutic benefit.

A study in monkeys reported a long half-life of manganese in the brain following inhalation exposure (Newland et al. 1987). Given that neurotoxicity is of concern with manganese exposure, knowledge of the mechanisms behind this longer half-life in the brain may be central to the development of mitigation methods. Newland et al. (1987) reported that this long half-life reflected both redistribution of manganese from other body depots and a slow rate of clearance from the brain. A later study reported that elevated levels in the brain persisted after inhalation exposure (due to redistribution), whereas for subcutaneous exposure, levels declined when administration was stopped (Newland et al. 1989). The authors observed that the accumulation of manganese in the brain was preferential in specific regions, but was unrelated to the route of exposure (Newland et al. 1989). They also reported that there are no known mechanisms or "complexing agents" that have been shown to remove manganese from the brain.

### 3. HEALTH EFFECTS

Few data are available regarding the reversibility of the neurological injury produced by prolonged excess manganese exposure. The effects are thought to be largely irreversible, and treatment for manganese intoxication is mainly supportive (Schonwald 2004). However, some evidence indicates that recovery may occur when exposure ceases (Smyth et al. 1973). Anti-Parkinsonian drugs, such as levo-dopa, have been shown to reverse some of the neuromuscular signs of manganism (Ejima et al. 1992; Rosenstock et al. 1971), but these drugs can produce a variety of side effects, and reports have indicated that they are not effective in improving the symptoms of neurotoxicity in manganism patients (Calne et al. 1994; Chu et al. 1995; Cook et al. 1974; Haddad et al. 1998; Huang et al. 1989; Schonwald 2004). Para-aminosalicylic acid was used successfully to treat two patients who exhibited neurological signs of manganese poisoning; one person made an almost complete recovery and the other was significantly improved. The mechanism for this treatment is unknown (Shuqin et al. 1992). Parenti et al. (1988) has proposed the use of antioxidants such as vitamin E, but the effectiveness of this treatment has not been further evaluated.

#### **3.11.3 Interfering with the Mechanism of Action for Toxic Effects**

The oxidation state of manganese may influence both its retention in the body (see Section 3.4.3) and its toxicity (see Section 3.5). Therefore, it is possible that interference with the oxidation of manganese could be a method for preventing manganese cellular uptake and toxicity. Regarding retention, one study suggests that clearance is much more rapid for divalent manganese than for trivalent manganese (Gibbons et al. 1976). Regarding neurotoxicity, Mn(III) appears to be more efficient in enhancing the oxidation of catechols than either Mn(II) or Mn(IV) (Archibald and Tyree 1987). Thus, it is plausible that reducing the formation of Mn(III) could possibly both enhance elimination and prevent neurotoxicity, but no studies were located that evaluate this theory.

Ceruloplasmin is involved in the oxidation of iron and has also been involved in the oxidation of divalent manganese ion to the trivalent state (Gibbons et al. 1976). Selective inhibition of this oxidative function may be a method of mitigating the toxic effects of exposure to manganese. However, inhibition of the oxidation of manganese might also result in adverse effects on transport and cellular uptake of other essential metals, especially iron. Furthermore, it is not completely clear how the oxidation state of manganese is related to its normal function in neural cells or how this role is altered in manganese toxicity. Both Mn(II) and Mn(III) have been reported as components of metalloenzymes (Keen and Zidenberg-Cher 1990; Leach and Lilburn 1978; Utter 1976).



### 3. HEALTH EFFECTS

Manganese has been shown to catalyze the oxidation of dopamine *in vitro*; Cawte et al. (1989) reported that the toxicity induced by manganese resulted from the depletion of dopamine and the production of dopamine quinone and hydrogen peroxide through this mechanism. Antioxidants were tested for their ability to inhibit the dopamine oxidation induced by manganese, and it was found that ascorbic acid and thiamine completely inhibited dopamine oxidation both in the presence and absence of manganese. The report did not include data on background oxidation levels nor on the extent of dopamine oxidation in the absence of manganese. Results from treatment with antioxidants were viewed as evidence for their use in mitigating the adverse effects of manganese. However, because dopamine oxidation was inhibited to some degree in the absence of manganese, these data could alternately be interpreted as suggesting a more complex mechanism than the direct action of manganese for inducing dopamine oxidation and subsequent cell toxicity. Further investigation of the inhibition of manganese oxidation as a possible mitigation method should be preceded by additional studies to elucidate the role of manganese in its various oxidation states in normal neuronal cell metabolism and to determine whether oxidative stress is a primary mechanism for neurotoxicity mediated by manganese exposure.

#### 3.12 ADEQUACY OF THE DATABASE

Section 104(I)(5) of CERCLA, as amended, directs the Administrator of ATSDR (in consultation with the Administrator of EPA and agencies and programs of the Public Health Service) to assess whether adequate information on the health effects of manganese is available. Where adequate information is not available, ATSDR, in conjunction with the National Toxicology Program (NTP), is required to assure the initiation of a program of research designed to determine the health effects (and techniques for developing methods to determine such health effects) of manganese.

The following categories of possible data needs have been identified by a joint team of scientists from ATSDR, NTP, and EPA. They are defined as substance-specific informational needs that if met would reduce the uncertainties of human health assessment. This definition should not be interpreted to mean that all data needs discussed in this section must be filled. In the future, the identified data needs will be evaluated and prioritized, and a substance-specific research agenda will be proposed.

##### 3.12.1 Existing Information on Health Effects of Manganese

The existing data on health effects of inhalation, oral, and dermal exposure of humans and animals to inorganic manganese are summarized in Figure 3-10. The purpose of this figure is to illustrate the existing information concerning the health effects of manganese. Each dot in the figure indicates that one

### 3. HEALTH EFFECTS

or more studies provide information associated with that particular effect. The dot does not necessarily imply anything about the quality of the study or studies, nor should missing information in this figure be interpreted as a “data need”. A data need, as defined in ATSDR’s *Decision Guide for Identifying Substance-Specific Data Needs Related to Toxicological Profiles* (Agency for Toxic Substances and Disease Registry 1989), is substance-specific information necessary to conduct comprehensive public health assessments. Generally, ATSDR defines a data gap more broadly as any substance-specific information missing from the scientific literature.

As the upper part of Figure 3-10 reveals, studies in humans exposed to inorganic manganese have focused mainly on intermediate and chronic inhalation exposure and the resulting neurological effects. There are several reports of humans exposed by ingestion and these too have focused on neurological effects. Reproductive effects have been studied in men exposed to manganese by inhalation, but other effects have generally not been formally investigated.

Inorganic manganese toxicity has been investigated in numerous animal studies, both by the oral and the inhalation routes. These studies have included most end points of potential concern. The dermal route for inorganic manganese has not been investigated, but there is no evidence that this exposure pathway is a human health concern. Dermal contact to MMT is expected to occur mainly in occupational settings, and no human dermal contact with mangafodipir is expected to occur. In addition, organic compounds are degraded to some extent in the environment. Thus, dermal effects from organic manganese compounds are not expected to be of great concern for the general population or to persons near hazardous waste sites.

#### 3.12.2 Identification of Data Needs

Presented below is a brief review of available information and a discussion of research needs. Although data are lacking, dermal studies to inorganic manganese are not discussed since there is no evidence that this exposure pathway is a human health concern.

**Acute-Duration Exposure.** Studies in animals and humans indicate that inorganic manganese compounds have very low acute toxicity by any route of exposure. An exception is potassium permanganate, which is an oxidant that can cause severe corrosion of skin or mucosa at the point of contact (Southwood et al. 1987). Acute inhalation exposure to high concentrations of manganese dusts (manganese dioxide, manganese tetroxide) can cause an inflammatory response in the lung, which can

3. HEALTH EFFECTS

**Figure 3-10. Existing Information on Health Effects of Inorganic Manganese**

|            | Systemic |       |              |         |                         |            |              |               |           |        |
|------------|----------|-------|--------------|---------|-------------------------|------------|--------------|---------------|-----------|--------|
|            | Death    | Acute | Intermediate | Chronic | Immunologic/Lymphoretic | Neurologic | Reproductive | Developmental | Genotoxic | Cancer |
| Inhalation | ●        |       |              | ●       | ●                       | ●          | ●            |               |           | ●      |
| Oral       | ●        | ●     | ●            | ●       |                         | ●          |              | ●             |           |        |
| Dermal     |          |       |              |         |                         |            |              |               |           |        |

**Human**

|            | Systemic |       |              |         |                         |            |              |               |           |        |
|------------|----------|-------|--------------|---------|-------------------------|------------|--------------|---------------|-----------|--------|
|            | Death    | Acute | Intermediate | Chronic | Immunologic/Lymphoretic | Neurologic | Reproductive | Developmental | Genotoxic | Cancer |
| Inhalation | ●        | ●     | ●            | ●       | ●                       | ●          | ●            | ●             |           |        |
| Oral       | ●        | ●     | ●            | ●       | ●                       | ●          | ●            | ●             | ●         |        |
| Dermal     |          |       |              |         |                         |            |              |               |           |        |

**Animal**

● Existing Studies

## 3. HEALTH EFFECTS

lead to impaired lung function (Maigetter et al. 1976; Shiotsuka 1984). However, this response is characteristic of nearly all inhalable particulate matter (EPA 1985d) and is not dependent on the manganese content of the particle. Large oral doses of highly concentrated solutions of manganese salts given by gavage can cause death in animals (Holbrook et al. 1975; Kostial et al. 1978; Smyth et al. 1969), but oral exposures via food or water have not been found to cause significant acute toxicity (Gianutsos and Murray 1982; NTP 1987a, 1987b). Since the acute database is incomplete and studies demonstrating a dose-response are not available, an acute MRL was not derived. In order to derive acute MRL values, further studies would be helpful to define the threshold for adverse effects following acute exposure to manganese. However, any MRL derived for the oral route would have to take into consideration that manganese is an essential nutrient.

Acute-duration exposure studies in animals exposed to MMT via inhalation or via a dermal pathway are lacking. The dermal pathway is very important, because MMT in gasoline that may be spilled on the skin could penetrate and become absorbed. Although the photolability of the compound is an important obstacle for any animal study, carefully planned and executed analyses of the toxicity of this compound to animal models through these exposure pathways are needed.

The likelihood for exposure to mangafodipir is small and clinical trials in humans have shown a great tolerance for a controlled exposure to the compound. Toxicity studies in several different animal species have been performed, including reproductive and developmental studies (and more specifically, teratogenic analysis). Although behavioral data in the young who have been exposed during gestation are relatively limited, human gestational exposure to this compound is not believed to be very likely. Reports of neurological effects have been limited to complaints of headaches in clinical trials. Further evaluation of these effects relative to the distribution of manganese to the brain during clinical use is warranted. Mangafodipir is administered intravenously, which bypasses homeostatic control of the compound. Although animal studies indicate that a single, clinical dose does not cause accumulation of manganese in the brain for longer than 2 weeks (Gallez et al. 1997), human studies have not monitored central nervous system distribution of manganese following mangafodipir injection for longer than half an hour (Lim et al. 1991). In addition, given the neurotoxic effects of excess manganese, evaluation of patients treated with mangafodipir for neurological sequelae are needed.

**Intermediate-Duration Exposure.** Intermediate-duration inhalation exposure of humans to manganese compounds can lead to central nervous system effects (Rodier 1955). However, reliable estimates of intermediate-duration NOAELs or LOAELs for neurotoxicity in humans are not available.

## 3. HEALTH EFFECTS

Intermediate-duration inhalation studies in animals have yielded NOAEL and LOAEL values for biochemical and neurobehavioral effects (EPA 1977; Morganti et al. 1985; Ulrich et al. 1979a, 1979b), but the range of exposure levels associated with these effects is too wide (an order of magnitude) to define a threshold. Although neurological effects were observed in animals, symptoms characteristic of manganese toxicity (e.g., ataxia, tremor, etc.) are not typically observed in rodent species (with the exception of one study in which ataxia was seen only transiently) (Kristensson et al. 1986). Although other rodent studies indicated decreases in motor activity (Gray and Laskey 1980; Komura and Sakamoto 1991), increased activity and aggression (Chandra 1983; Shukakidze et al. 2003), delayed reflexes (Ali et al. 1983a), or deficits in learning (Shukakidze et al. 2003; Vezér et al. 2005, 2007) the effects are not consistent and are observed over a wide dose range. For these reasons, it is concluded that these data are not sufficient to derive an intermediate-duration inhalation MRL. Epidemiological studies in occupationally exposed human populations that help define the intermediate-duration exposure levels that are associated with neurological effects would be valuable.

Intermediate-duration oral exposure of humans to manganese has been reported to cause neurotoxicity in two cases (Holzgraefe et al. 1986; Kawamura et al. 1941), but the data for quantitating exposure levels are too limited to define the threshold or to judge whether these effects were due entirely to manganese exposure. An epidemiological investigation of people who have ingested high levels of manganese may provide valuable information on the health risk of intermediate-duration oral exposure and may provide sufficient dose-response data from which to derive an MRL. Additional oral studies in animals including rodents may be valuable in revealing cellular and molecular mechanisms of manganese neurotoxicity; studies on nonhuman primates would probably be the most helpful in estimating a MRL because they appear to be the most suitable animal model for manganese-induced neurological effects comparable to effects observed in humans. However, any MRL derived for the oral route would have to take into consideration that manganese is an essential nutrient and account for manganese intake from daily dietary sources.

Intermediate-duration studies of inhalation and oral exposure to MMT in humans and animals are lacking. Animal studies of this duration evaluating systemic toxicity from exposure to MMT and typical environmental concentrations of its combustion products would be helpful to determine body burdens that might be anticipated for the general population in areas that use this compound. Further, these studies would be helpful in determining mechanisms of toxicity and expected adverse effects in exposed populations.

## 3. HEALTH EFFECTS

Due to the nature of mangafodipir administration, which typically occurs only once in a subject, no intermediate-duration studies in humans have been identified for this compound. Although there are a few intermediate-duration studies in animals (Grant et al. 1997a; Larsen and Grant 1997; Treinen et al. 1995), they have focused primarily on reproductive and developmental effects. Studies of the potential neurological effects of exposure to this compound are lacking, although the reason for this may be due to the lack of evidence that the compound distributes in the central nervous system. As discussed previously, the exposure to mangafodipir is expected to be very limited due to the compound's clinical use. There are no identified data needs for this compound.

**Chronic-Duration Exposure and Cancer.** As discussed in Sections 2.3 and 3.2.1.4, and Appendix A, a number of epidemiological studies have reported psychological or neurological effects of exposure to low levels of manganese in the workplace (Bast-Pettersen et al. 2004; Beuter et al. 1999; Blond and Netterstrom 2007; Blond et al. 2007; Bouchard et al. 2003, 2005, 2007a, 2007b; Chia et al. 1993a, 1995; Crump and Rousseau 1999; Deschamps et al. 2001; Gibbs et al. 1999; Iregren 1990; Lucchini et al. 1995, 1999; Mergler et al. 1994; Myers et al. 2003a, 2003b; Roels et al. 1987a, 1992, 1999; Wennberg et al. 1991) or in environmental media close to manganese-emitting industries (Lucchini et al. 2007; Mergler et al. 1999; Rodríguez-Agudelo et al. 2006). Some of these studies have found statistically significant differences between exposed and non-exposed groups or significant associations between exposure indices and neurological effects (Bast-Pettersen et al. 2004; Chia et al. 1993a; Iregren 1990; Lucchini et al. 1995, 1999; Mergler et al. 1994; Roels et al. 1987a, 1992; Wennberg et al. 1991), whereas others have not found significant associations (Deschamps et al. 2001; Gibbs et al. 1999; Myers et al. 2003a, 2003b; Young et al. 2005). Table A-3 in Appendix A summarizes results from these studies.

Additional studies involving follow-up evaluation of previously exposed occupational cohorts may be useful to provide information on threshold levels that are correlated with observed preclinical effects. Additional studies of populations living close to manganese-emitting industries may be useful to better describe neurotoxicological potentials of low-level exposure to air-borne manganese.

In early animal studies, intermediate or chronic inhalation exposure of monkeys and rats to manganese dusts did not produce neurological signs similar to those seen in humans (Bird et al. 1984; EPA 1983c; Ulrich et al. 1979a, 1979b). For example, Ulrich et al. (1979a) reported that monkeys continually exposed for 9 months to aerosols of manganese dioxide at concentrations as high as 1.1 mg manganese/m<sup>3</sup> showed no obvious clinical signs of neurotoxicity, no histopathological changes in brain tissues, and no evidence for limb (leg) tremor or electromyographic effects on flexor and extensor

## 3. HEALTH EFFECTS

muscles in the arm. However, in a chronic study with Rhesus monkeys, decreased levels of dopamine were found in several regions of the brain (caudate and globus pallidus) (Bird et al. 1984). Behavioral tests detected signs of neurological effects in mice (increased open-field activity and decreased maternal pup retrieval latency), although these are only seen at relatively high exposure levels (60–70 mg manganese/m<sup>3</sup>) (Lown et al. 1984; Morganti et al. 1985).

Other animal intermediate-duration studies provide evidence for associations between decreased neuronal cell counts in the globus pallidus and neurobehavioral changes (increased locomotor activity) in rats exposed by inhalation for 13 weeks to a mixture of manganese phosphate/sulfate (at 1.05 mg manganese/m<sup>3</sup>) or manganese sulfate alone (at concentration between 0.009 and 0.9 mg manganese/m<sup>3</sup>), but not to manganese phosphate alone at concentrations up to 1.1 mg manganese/m<sup>3</sup> (Normandin et al. 2002; Salehi et al. 2003, 2006; Tapin et al. 2006). Other 13-week rat inhalation exposure studies reported increased brain manganese concentrations and increased locomotor activity after exposure to 3.75 mg manganese/m<sup>3</sup> as metallic manganese (St-Pierre et al. 2001) and increased brain manganese concentrations with no increases in olfactory bulb, cerebellar, or striatal concentrations of glial fibrillary acidic protein (GFAP) after exposure to 0.5 mg manganese/m<sup>3</sup> as manganese sulfate or 0.1 mg manganese/m<sup>3</sup> as manganese phosphate (Dorman et al. 2004b). Other animal studies have examined the influence of inhalation exposure to manganese sulfate on biochemical end points associated with oxidative stress or inflammation in the brain of rats (Erikson et al. 2005, 2006; HaMai et al. 2006; Taylor et al. 2006) and monkeys (Erikson et al. 2007). The results from these studies indicate that acute- or intermediate-duration inhalation exposure to manganese sulfate concentrations ranging from about 0.1 to 1 mg manganese/m<sup>3</sup> can differentially affect brain biochemical markers of neurotoxicity, but understanding of the neurotoxic mechanism of manganese is inadequate to confidently define any one of the observed changes as biologically adverse.

Chronic inhalation studies in animal models (Bird et al. 1984; EPA 1977; Newland et al. 1989; Olanow et al. 1996) indicate that while non-human primates are very sensitive to the neurological effects of manganese at very low doses (depending on exposure route), rodent models do not exhibit the same neurological symptoms as humans and monkeys despite the administration of high doses through inhalation, oral, and intravenous exposure routes. Although there is an apparent difference in susceptibility, neurological effects have been observed in rodents treated with manganese. Additional studies in animals could be valuable to increase our understanding of the mechanism of manganese-induced disease and the basis for the differences between humans and animals.

## 3. HEALTH EFFECTS

Some data on neurological or other health effects in humans from repeated or chronic oral intake of manganese exist (Bouchard et al. 2007c; Cawte et al. 1987; He et al. 1994; Holzgraefe et al. 1986; Kawamura et al. 1941; Kilburn 1987; Kondakis et al. 1989; Vieregge et al. 1995; Wasserman et al. 2006; Wright et al. 2006; Zhang et al. 1995). The majority of these studies are limited by uncertainties in the exposure routes, total exposure levels, duration of exposure, or the influence of other confounding factors; none of these studies adequately assessed daily dietary manganese intake. Five studies (Bouchard et al. 2007c; He et al. 1994; Sahni et al. 2007; Wasserman et al. 2006; Zhang et al. 1995) indicate concentrations of manganese in drinking water that may be associated with preclinical neurological effects in children, but the studies have several limitations.

As discussed in Section 2.3, no oral MRLs were derived for acute-, intermediate-, or chronic-duration oral exposure to manganese, even though the limited human data and extensive animal data clearly identify neurobehavioral changes as the most sensitive effect from intermediate- and chronic-duration oral exposure to excess inorganic manganese. However, inconsistencies in the dose-response relationship information across studies evaluating different neurological end points under different experimental conditions in different species, as well as a lack of information concerning all intakes of manganese (e.g., dietary intakes plus administered doses), make it difficult to derive intermediate- or chronic-duration MRLs using standard MRL derivation methodology from the animal studies. An interim guidance value of 0.16 mg manganese/kg/day is recommended for ATSDR public health assessments. The interim guidance value is based on the Tolerable Upper Intake Level for adults of 11 mg manganese/day established by the U.S. Food and Nutrition Board/Institute of Medicine (FNB/IOM 2001) based on a NOAEL for Western diets. The interim guidance value is necessary because of the prevalence of manganese at hazardous waste sites and the fact that manganese is an essential nutrient.

Additional chronic oral studies, especially epidemiological studies in populations exposed to high levels of either inorganic and organic manganese in the environment, particularly the combustion products of MMT in areas of high traffic density, would be valuable for evaluating the potential for adverse effects from oral exposure to excess manganese from the environment in addition to that ingested through dietary intake.

No studies or anecdotal reports were located that described cancer associated with exposure of humans to inorganic manganese. Chronic oral exposure of rats and mice to high doses of manganese sulfate has provided equivocal evidence of carcinogenic potential (NTP 1993); however, the lack of evidence for the



## 3. HEALTH EFFECTS

carcinogenic potential of manganese in humans and the equivocal evidence in animals suggest that the potential for cancer may be low. Further animal studies are not needed at this time.

MMT has not been found to induce tumor formation in rodents (Witschi et al. 1981) and additional studies measuring this end point would be useful to corroborate the limited database. Though no studies of carcinogenesis involving mangafodipir exposure were identified, there are no data needs regarding this end point with this compound.

**Genotoxicity.** One study was located regarding the genotoxic effects of inorganic manganese in humans. An increase in chromosomal aberrations was observed in welders exposed to manganese; however, the welders were also exposed to nickel (known to cause chromosomal aberrations) and iron, so the observed increase could not be attributed solely to manganese (Elias et al. 1989). Some *in vivo* studies in fruit flies and rats have been negative (Dikshith and Chandra 1978; Rasmuson 1985; Valencia et al. 1985), but manganese has been found to be clastogenic in mice (Joardar and Sharma 1990). *In vitro* studies in bacteria, yeast, and cultured mammalian cells have yielded mixed, but mainly positive, results (Casto et al. 1979; De Méo et al. 1991; Joardar and Sharma 1990; Kanematsu et al. 1980; Nishioka 1975; NTP 1993; Oberly et al. 1982; Orgel and Orgel 1965; Singh 1984; Ulitzur and Barak 1988; Wong and Goeddel 1988; Zakour and Glickman 1984). Additional studies, especially in cultured mammalian cells, heritable cell types, or in lymphocytes from exposed humans, would be valuable in clarifying the genotoxic potential of manganese. As for organic manganese, no genotoxicity studies were located regarding MMT and studies measuring this end point are needed. Genotoxicity studies for mangafodipir have shown negative effects (Grant et al. 1997a).

**Reproductive Toxicity.** Men who are exposed to manganese dust in workplace air report decreased libido and impotency (Emara et al. 1971; Mena et al. 1967; Rodier 1955), and may suffer from sexual dysfunction (Jiang et al. 1996b) and decreased sperm and semen quality (Wu et al. 1996). In addition, studies in animals indicate that manganese can cause direct damage to the testes (Chandra et al. 1973; Seth et al. 1973). While the Jiang et al. (1996b) study suggests testicular damage in occupationally exposed men, additional epidemiological studies involving these subjects or other exposed groups to more fully evaluate reproductive function would be valuable. Results from such studies may provide definitive exposure-response data on reproductive function (e.g., impotence, libido, and number of children).

## 3. HEALTH EFFECTS

Additional studies in animals are needed to determine whether the testes are damaged directly from exposure to manganese. Information on adverse reproductive effects in women is not available. Data from studies in female animals indicate that manganese can cause post-implantation loss when administered through both oral and subcutaneous exposure routes in female mice and rats (Colomina et al. 1996; Sánchez et al. 1993; Szakmáry et al. 1995; Treinen et al. 1995). To establish more clearly whether or not this is a human health concern, two types of studies would be valuable. First, single-generation reproductive studies of female animals exposed by the inhalation route could be done. Then, if strong evidence for concern is found in animals from these studies, epidemiological studies that included women and men exposed in the workplace would be valuable to assess the effects of manganese on reproductive function.

**Developmental Toxicity.** There is a growing body of human data on potential developmental effects of excess manganese, although these studies are generally confined to studies of neurodevelopmental effects as observed in children. The incidences of stillbirths and malformations have been studied in an Australian aboriginal population living on an island where environmental levels of manganese are high (Kilburn 1987), but small population size and lack of data from a suitable control group preclude determining whether reported incidence of developmental abnormalities is higher than average. Hafeman et al. (2007) reported high mortality among infants <1 year of age in a Bangladesh population where the drinking water supplied by certain local wells contained high levels of manganese. Two studies investigated neurobehavioral and school performances (He et al. 1994; Zhang et al. 1995) of children exposed to excess levels of manganese in water and food. However, these studies did not report data on either lengths of exposure to the metal or on excess manganese intake compared to control areas. More recent investigations include epidemiological studies that have detected altered behavioral and cognitive performance among children exposed to excess levels of manganese in their local drinking water (Bouchard et al. 2007c; Wasserman et al. 2006). These results suggest the neurotoxic potential of excessive manganese exposure to children, but these studies have uncertainties that preclude the establishment of causal relationships between the observed effects and manganese exposure. The studies are limited in their ability to address several important concerns, such as whether manganese alone is responsible for the observed effects and the contribution of dietary manganese levels as well as inhalation exposure levels and small sample sizes. Studies evaluating developmental effects with clear analysis of exposure levels and duration are needed to estimate dose-response relationships of manganese toxicity in children.

## 3. HEALTH EFFECTS

Several developmental studies have been performed in animals, but they are mainly limited to rodent species and have measured limited developmental end points. One study in pregnant mice that inhaled manganese resulted in decreased pup weight and a transient increase in activity (Lown et al. 1984). Other studies have indicated that oral exposure to manganese adversely affects reproductive development in male mice (Gray and Laskey 1980) and rats (Laskey et al. 1982, 1985). A single study on rats involving oral exposure indicated that manganese caused a transient decrease in pup weight and increased activity (Pappas et al. 1997). Another study involving gavage dosing reported skeletal abnormalities in unborn pups, but these effects were resolved in pups allowed to grow to 100 days of age (Szakmáry et al. 1995). Neurobehavioral effects have been shown in neonates given excess manganese orally from PND 1 to 21 (Dorman et al. 2000; Reichel et al. 2006; Tran et al. 2002a). Several studies have shown neurochemical changes in offspring of dams exposed to increased manganese concentrations (Lai et al. 1991; Garcia et al. 2006, 2007) or in neonatal animals dosed with excess manganese (Chandra and Shukla 1978; Deskin et al. 1980, 1981; Dorman et al. 2000). Also of interest is the possibility that developmental manganese exposure may influence the timing of puberty; such results have been observed in studies of both male and female rats (Lee et al. 2006; Pine et al. 2005). Studies conducted in infant Rhesus monkeys found that soy-based infant formulas (which contain higher manganese levels than cow's milk) and a soy-based infant formula supplemented with manganese produced behavioral changes that may be comparable to those implicated in attention deficit-hyperactivity disorders (Golub et al. 2005).

Other studies indicate that injected manganese is more toxic to a developing fetus than inhaled or ingested manganese. Manganese injected subcutaneously or intravenously during the gestation period causes serious effects on skeletal development and ossification, but studies to date using this exposure pathway have not measured neurological deficits in pups or young rodents. The relevance to humans of results from these injection studies is unclear.

The monkey is increasingly regarded as a more appropriate model for neurological end points; however, monkey studies are extremely expensive and will be limited for this reason. Evaluation of appropriate end points in rodent assays by the oral and inhalation route are needed so that these models can be used to increase the body of knowledge of the developmental toxicity of manganese. Further, the one developmental study involving inhalation exposure (Lown et al. 1984) had many complications; additional studies involving neurobehavioral effects in animals following gestational and postnatal exposure to airborne manganese are necessary. A few developmental studies have involved sectioning fetuses to detect internal malformations (Blazak et al. 1996; Grant et al. 1997a; Szakmáry et al. 1995; Treinen et al. 1995). However, these studies have primarily administered the manganese intravenously,

## 3. HEALTH EFFECTS

except for Szakmáry et al. (1995). Additional teratogenesis studies that assess bone malformations following inhalation and oral exposures using a wide range of doses are needed given that manganese overexposure affects the developing skeletal system (Blazak et al. 1996; Grant et al. 1997a; Szakmáry et al. 1995; Treinen et al. 1995). In order to improve the accuracy of the development of an oral MRI for manganese, additional developmental neurotoxicology studies using a functional observational battery design and using a wide range of well-established measures in rodents and primates would be useful (Moser 2000).

**Immunotoxicity.** Studies in animals indicate that injection or consumption of manganese compounds can cause significant changes in the functioning of several cell types of the immune system (NTP 1993; Rogers et al. 1983; Smialowicz et al. 1985, 1987). However, it is not known whether these changes are associated with significant impairment of immune system function. Further studies are needed to determine whether these effects also occur after inhalation exposure in animals or humans. If so, a battery of immune function tests would be valuable in determining if observed changes result in a significant impairment of immune system function.

**Neurotoxicity.** Studies in humans exposed to high levels of manganese dust in the workplace provide clear evidence that the chief health effect of concern following manganese exposure is injury to the central nervous system (Emara et al. 1971; Mena et al. 1967; Rodier 1955; Schuler et al. 1957; Smyth et al. 1973). Quantitative data on exposure levels for chronic durations are sufficient to identify a LOAEL for preclinical neurological effects (Iregren 1990; Roels et al. 1987a, 1992), and some of these data have been used to estimate a NOAEL using benchmark dose analysis (Iregren 1990; Roels et al. 1992). These NOAEL estimates are comparable to a NOAEL for early neurological effects recently reported by Gibbs et al. (1999). Thus, no additional epidemiological studies to characterize effects in workers exposed to manganese via inhalation appear necessary at this time. Two recent studies investigated longitudinally whether manganese-induced preclinical effects in workers previously evaluated were reversible (Crump and Rousseau 1999; Roels et al. 1999). Improved performance was observed only in workers exposed to the lowest levels of manganese and effects in others neither improved nor worsened. High variability in the results of neurobehavioral testing from year-to-year was a limitation in the interpretation of results in one of these studies (Crump and Rousseau 1999). Also, the two studies reported conflicting findings on the effect aging the in workers may have had on their performance in certain tests. Additional follow-up studies are needed to further evaluate the reversibility of manganese-induced effects and define threshold exposure levels above which manganese-induced neurological effects are irreversible.

## 3. HEALTH EFFECTS

Studies of environmental exposure to airborne manganese report a correlation between high levels of the metal and increased blood manganese levels and subtle neurological effects, particularly in those over 50 years old (Baldwin et al. 1999; Mergler et al. 1999). These studies are also the first to study manganese exposures and potential adverse effects in women. More studies are needed that include analyses of both sexes and assess the relationship between environmental sources of excess manganese, altered manganese body burden, and the potential for adverse effects.

The evidence for neurotoxicity in humans following oral exposure to manganese is inconclusive due to several limitations in the majority of these reports (Bouchard et al. 2007c; Holzgraefe et al. 1986; Kawamura et al. 1941; Kilburn 1987; Kondakis et al. 1989; Wasserman et al. 2006). One report in Japanese adults (Iwami et al. 1994) showed the link between eating food with concentrations of manganese on the high end of the normal range of a typical Western diet (5.79 mg manganese ingested per day) and low intake concentrations of magnesium associated with an increased incidence of motor neuron disease. Four studies in children (Bouchard et al. 2007c; He et al. 1994; Wasserman et al. 2006; Zhang et al. 1995) indicated that those who ingested drinking water and/or who ate food with increased concentrations of manganese ( $\geq 0.241$  mg/L) for at least 3 years had measurable deficits in performance on certain tests. In addition, the children exposed to manganese performed more poorly in school compared to non-exposed control students (who drank water with manganese concentrations no higher than 0.04 mg/L), as measured in mastery of Chinese, performance in mathematics, and overall grade average (Zhang et al. 1995). These studies show that both adults and children show adverse neurological effects from oral exposure to excess manganese. There are no existing studies showing adverse neurological effects in children as a result of inhalation exposure to the airborne metal, either from locations near work sites or near hazardous waste sites.

There currently exists only one series of studies of potential neurotoxic effects of inhaled environmental manganese (Baldwin et al. 1999; Beuter et al. 1999; Mergler et al. 1999). These exposures most likely resulted from a point source, but the possible contribution of airborne manganese from MMT-gasoline exhaust cannot be excluded. These studies lend support to the possibility that the elderly may be a population susceptible to the neurotoxic effects of excess manganese exposure. Studies are currently needed to further investigate the potential for neurological effects in people, including children, who may have ingested excess amounts of excess manganese from sources in the environment. Clearly defined information on exposure levels and regular dietary intakes should also be captured. Further studies are needed to determine whether manganese from MMT and/or its unique combustion products contribute to

### 3. HEALTH EFFECTS

airborne manganese concentrations that can be associated with adverse effects (e.g., respiratory or neurological effects).

Studies in rodents and nonhuman primates indicate that oral intake of high doses of manganese can lead to biochemical and behavioral changes indicative of nervous system effects (Bonilla and Prasad 1984; Chandra 1983; Gupta et al. 1980; Kristensson et al. 1986; Lai et al. 1984; Nachtman et al. 1986), and this is supported by intravenous studies in monkeys (Newland and Weiss 1992). Rodents do not appear to be as susceptible to manganese neurotoxicity as humans; however, a study by Newland and Weiss (1992) indicates that Cebus monkeys would be a reasonable animal model. Further studies in animals may help determine the basis for the apparent differences in route and species susceptibility.

Additional studies in animals concerning the cellular and biochemical basis of manganese neurotoxicity, including a more detailed analysis of precisely which neuronal cell types are damaged and why, are needed. For example, Carl et al. (1993) have performed initial studies investigating the relationship between manganese and the major Mn(II) enzymes (arginase and glutamine synthetase) in epileptic and induced seizures. Further studies may prove helpful in elucidating mechanism(s) of toxic action and could potentially lead to developing methods for mitigating adverse effects induced by manganese.

**Epidemiological and Human Dosimetry Studies.** As already noted, there are numerous epidemiological studies of workers exposed to manganese dusts in air, and the clinical signs and symptoms of the resulting disease are well established. However, these studies have only involved males and have only involved the inhalation route of exposure. Additional epidemiological studies on populations exposed to manganese dust in the workplace or local environments (e.g., such as near foundries, populations exposed to manganese emissions from MMT-burning automobiles, particularly those living in areas of high-traffic density, and populations exposed to above-average oral intakes [either through water and/or food]) may help to strengthen conclusions on dose-response relationships and no-effect exposure levels. This would be helpful in evaluating potential risks to people who may be exposed to above-average manganese levels near hazardous waste sites.

#### **Biomarkers of Exposure and Effect.**

**Exposure.** Studies in humans have shown that it is difficult to estimate past exposure to manganese by analysis of manganese levels in blood, urine, feces, or tissues (Roels et al. 1987b; Smyth et al. 1973; Valentin and Schiele 1983; Yamada et al. 1986). This is the result of several factors: (1) manganese is a

## 3. HEALTH EFFECTS

normal component of the diet and is present in all human tissues and fluids, so above average exposure must be detected as an increase over a variable baseline; (2) manganese is rapidly cleared from the blood and is excreted mainly in the feces, with very little in the urine; and (3) manganese absorption and excretion rates are subject to homeostatic regulation, so above average exposures may result in only small changes in fluid or tissue levels. Probably the most relevant indicator of current exposure is manganese concentrations in tissues, but at present, this can only be measured in autopsy or biopsy samples. Studies on new, noninvasive methods capable of measuring manganese levels *in vivo*, either in the whole body or in specific organs (e.g., brain), would be very helpful in identifying persons with above average exposure. Dorman et al. (2006b) evaluated the use of the pallidal index (PI—ratio of hyperintensities in the globus pallidus and the adjacent subcortical frontal white matter) and the T1 relaxation rate (R1) from MRI to reflect manganese concentrations determined by analytical chemistry in brain regions and concluded that R1 can be used to estimate regional brain manganese concentrations and be used as a reliable biomarker of occupational manganese exposure.

**Effect.** The principal biological markers of toxic effects from manganese exposure are changes in the levels of various neurotransmitters and related enzymes and receptors in the basal ganglia (Bird et al. 1984; Bonilla and Prasad 1984; Eriksson et al. 1987a, 1987b). Noninvasive methods to detect preclinical changes in these biomarkers or in the functioning of the basal ganglia need to be developed to help identify individuals in whom neurological effects might result. Research to determine the correlation between urinary excretion levels of neurotransmitters, neurotransmitter metabolites, and/or 17-ketosteroids (Bernheimer et al. 1973; Rodier 1955; Siqueira and Moraes 1989) and the probability or severity of neurological injury in exposed people is also needed. Measurements of MnSOD as a biomarker of effect may also be helpful (Greger 1999), but there is a lack of information concerning the relationship of this enzyme to manganese toxicity.

Research in the use of Clara cell protein CC16 may be useful in identifying populations at risk from exposure to MMT; however, the majority of exposure to this compound is expected to arise from inhalation and ingestion of its combustion products. Therefore, increased use of MMT in gasoline necessitates the development of biomarkers of exposure to inorganic manganese compounds, as discussed previously.

**Absorption, Distribution, Metabolism, and Excretion.** The toxicokinetics of manganese absorption, distribution, and excretion have been studied in both humans and animals. The oral absorption rate is about 3–5% in humans (Davidsson et al. 1988, 1989a; Mena et al. 1969), but the rate

## 3. HEALTH EFFECTS

may vary depending on age and dietary iron and manganese intake levels (Chandra and Tandon 1973; Diez-Ewald et al. 1968; Rehnberg et al. 1982; Thomson et al. 1971). Information is needed on the relative proportion of manganese that is absorbed via the gut following mucociliary transport of particles from the lung to the stomach. The oral absorption rate may depend on the chemical form of manganese ingested, but data on this are sparse. Data on the differences in uptake as a function of chemical species (manganese dioxide, manganese tetroxide) and particle size would also be valuable in assessing human health risk from different types of manganese dusts. Absorption of manganese deposited in the lung is expected to be higher for soluble forms of manganese compared with relatively insoluble forms of manganese (Aschner et al. 2005; Roels et al. 1997). Results consistent with nasal uptake of manganese and transport to the brain along neuronal tracts have been obtained in several animal studies (Brenneman et al. 2000; Dorman et al. 2001a, 2002a; Elder et al. 2006; Fechter et al. 2002; Henriksson et al. 1999; Lewis et al. 2005; Normandin et al. 2004; Tjälve and Henriksson 1999; Tjälve et al. 1996; Vitarella et al. 2000). Following nasal instillation of solutions of manganese chloride or sonicated suspensions of ultrafine insoluble manganese oxide particles to rats, similar manganese concentrations were found in the brain olfactory bulb (Elder et al. 2006). These results suggest that ultrafine particles can be distributed from the nasal mucosa to the brain olfactory bulb. Absorption of manganese deposited in the lung or nasal mucosa of rats is expected to be influenced by iron status, with enhanced absorption under iron-deficient conditions and diminished absorption under iron-excess conditions (Thompson et al. 2006, 2007).

Manganese appears to be distributed to all tissues, including the brain (Aschner et al. 2005, 2007; Kristensson et al. 1986; Rehnberg et al. 1980, 1981, 1982). Inhaled manganese appears to be distributed more extensively to the brain than ingested manganese and there are differences in distribution between different forms of manganese (manganese chloride compared with manganese dioxide or manganese phosphate) (Dorman et al. 2001a, 2004b; Roels et al. 1997). Additional research would be useful in understanding how particle size and solubility of manganese forms influence distribution of manganese to and within the brain. In addition, the metabolism of manganese (specifically, the degree and the rate of oxidation state interconversions) has not been thoroughly investigated. Data on this topic are needed to understand the mechanism of manganese toxicity and would help in evaluating the relative toxicity of different manganese compounds. Excretion of manganese is primarily through the feces (Drown et al. 1986; Klaassen 1974; Mena et al. 1969); because the rate of excretion is an important determinant of manganese levels in the body, further studies would be valuable on the biochemical and physiological mechanisms that regulate manganese excretion.



## 3. HEALTH EFFECTS

Additional studies would be useful to more fully elucidate the pharmacokinetic mechanisms responsible for uptake, distribution, and excretion in humans and animals, including studies to determine the following: control rates and processes for uptake of ingested manganese by the intestines and liver, including uptake rates of protein-bound forms by the liver; oxidation rates of manganese in the blood and tissues; relative speciation of Mn(II vs. III) in blood transport mechanisms into the central nervous system, including transfer rates; competition between manganese and iron in terms of transport processes; and distribution following long-term exposures to assess potential storage depots.

Andersen et al. (1999) suggested that an approach to setting acceptable exposure levels for an essential, but neurotoxic, nutrient such as manganese could be based on predicting exposure levels by any route that would increase brain manganese concentrations to a small fraction (e.g., 10–25%) of the variation observed in the general human population. Reliable and validated multiple-route PBTK models for multiple species, including humans, are needed to take this approach to setting acceptable exposure levels. Efforts to develop such models in rats have been recently described (Leavens et al. 2007; Nong et al. 2008; Teeguarden et al. 2007a, 2007b, 2007c). Continued development of these models and extension of them to nonhuman primates and humans would be needed to establish MRLs for manganese by this alternative approach.

Data on the pharmacokinetics of mangafodipir are sufficient for environmental assessment purposes. Additional studies concerning absorption, distribution, metabolism, and excretion of MMT, via inhalation, ingestion, and dermal exposures, would be very helpful.

**Comparative Toxicokinetics.** Several papers have reviewed the fairly extensive literature showing differences in the expression of manganese neurotoxicity in humans, nonhuman primates, and rodents (Aschner et al. 2005; Gwiazda et al. 2007; Newland et al. 1999). Aschner et al. (2005) concluded that manganese-exposed monkeys show overlapping effects to those observed in patients with manganism (e.g., retention of manganese in the basal ganglia and loss of dopamergic neurons), but similar changes in regional brain manganese concentrations, neurochemical concentrations, and neuropathological effects have been observed less consistently in rodents. Likewise, Gwiazda et al. (2007) concluded from their analysis of estimated internal cumulative doses associated with neurobehavioral, histological, and neurochemical changes in manganese-exposed animals that the range of adverse internal cumulative doses extended more than 2 orders of magnitude above the lowest estimated doses associated with subtle neurological deficits in manganese-exposed workers. The reasons for these differences are poorly understood, but may be due to interspecies differences in toxicokinetics or toxicodynamics (i.e.,

## 3. HEALTH EFFECTS

differences in tissue sensitivities). Research to further develop PBTK models in rats that have been recently described (Leavens et al. 2007; Nong et al. 2008; Teeguarden et al. 2007a, 2007b, 2007c) and extend them to nonhuman primates and humans may be useful to increase understanding of interspecies differences in manganese neurotoxicity.

**Methods for Reducing Toxic Effects.** In general, the methods which provide the greatest likelihood of reducing toxic effects are the same as those aimed at reducing body burden (see section 3.11.2). The recommended methods for the mitigation of manganese toxicity (manganism) are mainly supportive (Schonwald 2004). Administration of anti-Parkinson drugs, such as levo-dopa, is of little use (Calne et al. 1994; Chu et al. 1995; Cook et al. 1974; Schonwald 2004; Huang et al. 1989; Leikin and Paloucek 2002). Chelation therapy with agents such as ethylenediaminetetraacetic acid (EDTA) has reportedly been effective in reducing some of the symptoms (Schonwald 2004; Haddad and Winchester 1990), but was not effective in all cases (Crossgrove and Zheng 2004; Jiang et al. 2006). Studies on the efficacy of newly developed methods to reduce the toxic effects of manganese are needed. The available data indicate that para-aminosalicylate has been successfully used to treat neurological symptoms of manganese poisoning in several patients (Shuqin et al. 1992; Jiang et al. 2006). The use of the antioxidant vitamin E has also been proposed to mitigate manganese-induced effects (Parenti et al. 1988). Additional studies on the efficacy of these treatments are needed. Further evaluation for the mitigation of effects from excess exposure to manganese is also needed.

Methods for reducing toxic effects have not been identified for MMT.

**Children's Susceptibility.** Data needs relating to both prenatal and childhood exposures, and developmental effects expressed either prenatally or during childhood, are discussed in detail in the Developmental Toxicity subsection above.

Children have been identified as a potentially susceptible population because of their high absorption and/or retention of manganese as compared to adults. Although some available studies indicate that tissue concentrations of human fetuses are comparable to adults, animal studies indicate that neonates retain higher tissue concentrations than adult animals. Researchers hypothesize that this increased retention of manganese may lead to neurotoxicity. Existing data indicate that the adverse neurological effects of manganese overexposure from intravenous and oral sources are qualitatively similar in children and adults. One study has reported that neonates are more susceptible to the effects of oral exposure to excess manganese than adults (Dorman et al. 2000). Additional quantitative information on the levels of

## 3. HEALTH EFFECTS

manganese that result in adverse effects in children as compared to adults for inhalation, oral, and intravenous exposures are needed. Further, analysis of existing data from effects observed in the clinical setting might be helpful.

There are inadequate data on the pharmacokinetics of manganese in children. Although two studies provided typical serum manganese levels in differing ages of healthy children (Alarcón et al. 1996; Rügauer et al. 1997), no studies have provided any data on the distribution of manganese in infants or adolescents. Studies in animals, particularly nonhuman primates, are needed to clearly elucidate the pharmacokinetic handling of manganese in neonates and the young (absorption, metabolism, distribution, elimination). There are no PBPK models for children, embryos, fetuses and pregnant women, infants and lactating women, or adolescents. Such models would be very informative if they could assist in the identification of depots for manganese storage under conditions of excess exposure, as well as the nutritional needs of these age groups for the compound. One study was available that would provide information on the concentrations of manganese that might be found in the developing fetus of a highly-exposed mother (Jarvinen and Ahlström 1975). Further studies of this nature, especially those that measure neurological end points in live offspring following excess exposure, are needed. Similarly, data are needed to determine whether increased amounts of manganese might be present in the breast milk of a mother with significantly elevated blood or tissue manganese concentrations.

There are likely to be multiple mechanisms of manganese toxicity and most of these have probably been elucidated. However, there is a deficiency in our knowledge of how these mechanisms act singly or in combination to explain the different functional deficits observed in children versus adults. There are inadequate data to determine whether metabolism of manganese is different in children than in adults. Manganese is necessary for normal functioning of certain enzymes. However, there are no definitive data to indicate that children might need more manganese than adults for normal body processes. A few studies suggest that children may have a higher need for manganese than adults, based on the increased retention of manganese in the brains of certain neonatal animals, but this hypothesis has not been proven. Additional studies are necessary to determine the nutritional requirements of children for manganese, especially in infants for which FNB/IOM has not provided any guidelines.

Studies indicate that children exposed to increased concentrations of inorganic manganese, either via the diet, due to inability to clear the compound from the body or through parenteral nutrition, develop neurological dysfunction similar to that of adults (Devenyi et al. 1994; Fell et al. 1996; He et al. 1994; Zhang et al. 1995). Other data exist that indicate that children may not be as susceptible as adults to the

### 3. HEALTH EFFECTS

adverse neurological effects of inorganic manganese (Kawamura et al. 1941), but the limitations in this report make predictions about susceptibility inconclusive. Additional animal studies comparing the potential for inorganic manganese to induce neurological effects in different age groups are needed to help understand the susceptibility of the young compared to adults.

The mechanism of action of inorganic manganese toxicity has not been identified. Studies in humans indicate that children and adults with increased manganese deposition in the globus pallidus and other basal regions suffer neuromuscular deficits. It has been suggested that manganese accelerates the autoxidation of catecholamines and contributes to oxidative stress in these affected regions of the brain. Further research is needed to more completely elucidate the mechanism of inorganic manganese toxicity.

There are no dependable biomarkers of exposure or effect that are consistently used in a clinical setting. However, MRI scans have been used in both adults and children to determine whether manganese is accumulating in certain brain regions. More data are needed to determine the sensitivity and specificity of this method.

Available data do not indicate that there are any interactions of manganese with other compounds that occur only in children. Interactions with compounds in adults are expected to also occur in children. Data concerning the significance of any interactions of manganese with other compounds are needed.

Child health data needs relating to exposure are discussed in Section 6.8.1, Identification of Data Needs: Exposures of Children.

#### **3.12.3 Ongoing Studies**

Ongoing studies pertaining to manganese have been identified and are shown in Table 3-20.

## 3. HEALTH EFFECTS

**Table 3-20. Ongoing Studies on Manganese**

| Investigator                     | Affiliation                             | Research description   | Sponsor   |
|----------------------------------|---|--|---|
| Aschner, Judy L                  | Vanderbilt University                   | Brain manganese deposition in high risk neonates   | National Institute of Environmental Health Sciences |
| Aschner, Michael                 | Vanderbilt University                   | Mechanisms of manganese neurotoxicity  | National Institute of Environmental Health Sciences |
| Berkowitz, Bruce A               | Wayne State University                  | Manganese-enhanced MRI studies of retinal neovascularization                                   | National Eye Institute                              |
| Brain, Joseph D                  | Harvard University                      | Manganese, iron, cadmium, and lead transport from the environment to critical organs           | National Institute of Environmental Health Sciences |
| Culotta, Valeria C               | Johns Hopkins University                | Intracellular pathways of manganese trafficking  | National Institute of Environmental Health Sciences |
| Dees, WL                         | Texas A&M University                    | Actions of manganese on neuroendocrine development   | National Institute of Environmental Health Sciences |
| Dietrich, Kim                    | University of Cincinnati                | Early lead exposure, ADHD, and persistent criminality: Role of genes and environment           | National Institute of Environmental Health Sciences |
| Erikson, Keith M                 | University of North Carolina Greensboro | Neurotoxicology of dietary iron/manganese interactions   | National Institute of Environmental Health Sciences |
| Glasfeld, Arthur                 | Reed College                            | Mechanism and specificity in manganese homeostasis   | National Institute of General Medical Sciences      |
| Graziano, Joseph H, Grazi        | Columbia University                     | Research description: Health effects and geochemistry of arsenic and manganese                 | National Institute of Environmental Health Sciences |
| Guilarte, Tomas R                | Johns Hopkins University                | Molecular and behavioral effects of low level Mn exposure                                      | National Institute of Environmental Health Sciences |
| Gunter, Thomas E                 | University of Rochester                 | Mitochondrial role in manganese toxicity   | National Institute of Environmental Health Sciences |
| Hu, Howard, MD                   | Brigham and Women's Hospital            | Gene-metal interactions and Parkinson's disease  | National Institute of Environmental Health Sciences |
| Kanthasamy, Anumantha Gounder, G | Iowa State University                   | Mechanisms of manganese neurotoxicity  | National Institute of Environmental Health Sciences |
| Klimis-Zacas, D                  | University of Maine                     | Manganese, arterial functional properties, and metabolism as related to cardiovascular disease | Department of Agriculture Hatch                     |
| Klimis-Zacas, D                  | University of Maine                     | Manganese, arterial functional properties, and proteoglycan-lipoprotein interactions           | Department of Agriculture Hatch                     |
| Klimis-Zacas, D                  | University Of Maine                     | Manganese, proteoglycan-lipoprotein interactions, and arterial wall functional properties      | Department of Agriculture NRI Competitive           |

## 3. HEALTH EFFECTS

**Table 3-20. Ongoing Studies on Manganese**

| Investigator               | Affiliation                                    | Research description  | Sponsor   |
|----------------------------|--|---|---|
| Korrick, Susan A           | Brigham and Women's Hospital                   | Metal and organochlorines exposure: Impact on adolescent behavior and cognition | National Institute of Environmental Health Sciences |
| Liu, Bin                   | University of Florida                          | Combined dopaminergic neurotoxicity of manganese and LPS                        | National Institute of Environmental Health Sciences |
| Miller, Gary W             | Emory University                               | Neurotoxicity of nanomaterials: Evaluation of subcellular redox state           | National Institute of Environmental Health Sciences |
| Nass, Richard Michael      | Vanderbilt University                          | Molecular genetics of manganese induced dopamine neuron toxicity                | National Institute of Environmental Health Sciences |
| Oberley, Larry W           | University of Iowa                             | Oxidative stress and metabolism research cluster                                | National Institute of Environmental Health Sciences |
| Pecoraro, Vincent L        | University of Michigan at Ann Arbor            | Structural models for multinuclear manganese enzymes                            | National Institute of General Medical Sciences      |
| Rao, Rajini                | Johns Hopkins University                       | Secretory pathway calcium and manganese pumps                                   | National Institute of General Medical Sciences      |
| Shine, James P             | Harvard University                             | Exposure assessment of children and metals in mining waste                      | National Institute of Environmental Health Sciences |
| Smith, Donald R            | University of California Santa Cruz            | Role of manganese in neurodegenerative disease                                  | National Institute of Environmental Health Sciences |
| Srinivasan, Chandra        | California State University Fullerton          | Superoxide dismutases and ionic manganese in aging                              | National Institute on Aging                         |
| Tjalkens, Ronald B         | Colorado State University-Fort Collins         | Manganese and basal ganglia dysfunction: Role of NO                             | National Institute of Environmental Health Sciences |
| Weisskopf, Marc G          | Harvard University                             | Metal neurotoxicity   | National Institute of Environmental Health Sciences |
| Wessling-Resnick, Marianne | Harvard University                             | Influence of iron status on the neurotoxicity of inhaled manganese              | National Institute of Environmental Health Sciences |
| Williams, Michael T        | Children's Hospital Medical Center, Cincinnati | Effect of lead, manganese, and stress during development                        | National Institute of Environmental Health Sciences |
| Wright, Robert O, MD       | Brigham and Women's Hospital                   | Metal mixtures and neurodevelopment   | National Institute of Environmental Health Sciences |
| Zheng, Wei                 | Purdue University West Lafayette               | Choroid plexus as a target in metal-induced neurotoxicity                       | National Institute of Environmental Health Sciences |

Source: FEDRIP 2008

## **4. CHEMICAL AND PHYSICAL INFORMATION**

### **4.1 CHEMICAL IDENTITY**

Table 4-1 lists common synonyms, trade names, and other relevant information regarding the chemical identity of manganese and several of its most important compounds.

### **4.2 PHYSICAL AND CHEMICAL PROPERTIES**

Information regarding the physical and chemical properties of manganese is located in Table 4-2.

## 4. CHEMICAL AND PHYSICAL INFORMATION

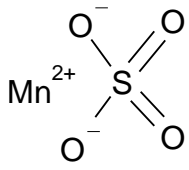
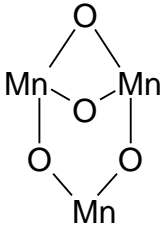

**Table 4-1. Chemical Identity of Manganese and Compounds<sup>a</sup>**

| Characteristic           | Information  |   |   |
|--------------------------|--|---|---|
| Chemical name            | Manganese  | Mn(II) chloride   | Manganese sulfate   |
| Synonym(s)               | Elemental manganese <sup>b</sup> ;<br>colloidal manganese <sup>b</sup> ;<br>cutaval <sup>b</sup> | Manganese chloride <sup>b</sup> ;<br>manganese dichloride                             | Manganese sulfate   |
| Registered trade name(s) | Cutaval <sup>b</sup> ; Mangan <sup>b</sup>   | No data   | Sorba-spray manganese <sup>b</sup>  |
| Chemical formula         | Mn   | MnCl <sub>2</sub>   | MnSO <sub>4</sub>   |
| Chemical structure       | Mn   | $\begin{array}{c} \text{Cl}^- \\   \\ \text{Mn}^{2+} \\   \\ \text{Cl}^- \end{array}$ |  |
| Identification numbers:  |  |   |   |
| CAS registry             | 7439-96-5  | 7773-01-5   | 7785-87-7   |
| NIOSH RTECS              | 009275000 <sup>b</sup>   | 009625000 <sup>b</sup>  | OP1050000 <sup>b</sup>  |
| EPA hazardous waste      | No data  | No data   | No data   |
| OHM/TADS                 | No data  | No data   | No data   |
| DOT/UN/NA/IMDG shipping  | No data  | No data   | No data   |
| HSDB                     | 00550 <sup>b</sup>   | 02154 <sup>b</sup>  | 02187 <sup>b</sup>  |
| NCI                      | No data  | No data   | No data   |



## 4. CHEMICAL AND PHYSICAL INFORMATION

**Table 4-1. Chemical Identity of Manganese and Compounds<sup>a</sup>**

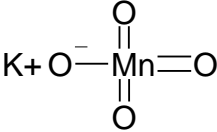
| Characteristic           | Information   |  |   |
|--------------------------|---|--|---|
| Chemical name            | Manganese (II, III) oxide   | Manganese dioxide  | Potassium permanganate  |
| Synonym(s)               | Manganese tetroxide; manganomanganic oxide <sup>c</sup>                           | Manganese peroxide; manganese binoxide; manganese black; battery manganese         | Permanganic acid; potassium salt; chameleon mineral <sup>c</sup>                    |
| Registered trade name(s) | No data   | No data  | No data   |
| Chemical formula         | Mn <sub>3</sub> O <sub>4</sub>  | MnO <sub>2</sub>   | KMnO <sub>4</sub>   |
| Chemical structure       |  |  |  |
| Identification numbers:  |   |  |   |
| CAS registry             | 1317-35-7   | 1313-13-9  | 7722-64-7   |
| NIOSH RTECS              | OP0900000 <sup>b</sup>  | No data  | SD6475000 <sup>b</sup>  |
| EPA hazardous waste      | No data   | No data  | No data   |
| OHM/TADS                 | No data   | No data  | No data   |
| DOT/UN/NA/IMDG shipping  | No data   | No data  | UN1490 <sup>b</sup> , IMDG 5.1 <sup>b</sup>   |
| HSDB                     | No data   | No data  | 01218 <sup>b</sup>  |
| NCI                      | No data   | No data  | No data   |

## 4. CHEMICAL AND PHYSICAL INFORMATION

**Table 4-1. Chemical Identity of Manganese and Compounds<sup>a</sup>**

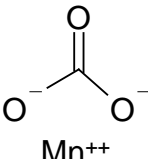
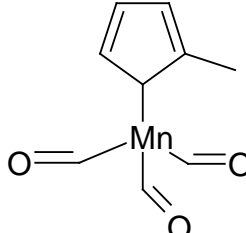
| Characteristic           | Information   |  |   |
|--------------------------|---|--|---|
| Chemical name            | Mn(II) carbonate  | Mangafodipir   | Methylcyclopentadienyl manganese tricarbonyl (MMT)  |
| Synonym(s)               | Carbonic acid; manganese (2+) salt; manganous carbonate <sup>b</sup> ; natural rhodochrosite <sup>b</sup> | Mangafodipir trisodium <sup>d</sup> ; MnDPDP <sup>d</sup>  | MMT; manganese, tricarbonyl ([1,2,3,4,5-eta]-1-methyl-2,4-cyclopentadien-1yl)-; methylcymantrene; tricarbonyl (2-methylcyclopentadienyl) manganese <sup>b</sup> |
| Registered trade name(s) | No data   | Teslascan <sup>d</sup> ; Win 59010 <sup>d</sup>  | AK-33X; Antiknock-33; CI-2; Combustion Improver-2 <sup>b</sup>  |
| Chemical formula         | MnCO <sub>3</sub>   | C <sub>22</sub> H <sub>24</sub> MnN <sub>4</sub> O <sub>14</sub> P <sub>2</sub> H <sub>3</sub> Na <sub>3</sub> | C <sub>9</sub> H <sub>7</sub> MnO <sub>3</sub>  |
| Chemical structure       |                          | No data  |    |
| Identification numbers:  |   |  |   |
| CAS registry             | 598-62-9  | 140678-14-4  | 12108-13-3  |
| NIOSH RTECS              | No data   | OO9163250  | 48184   |
| EPA hazardous waste      | No data   | No data  | No data   |
| OHM/TADS                 | No data   | No data  | No data   |
| DOT/UN/NA/IMDG shipping  | No data   | No data  | No data   |
| HSDB                     | 00790 <sup>b</sup>  | No data  | 2014  |
| NCI                      | No data   | No data  | No data   |

<sup>a</sup>All information obtained from Sax and Lewis 1987, except where noted.

<sup>b</sup>HSDB 2008

<sup>c</sup>O'Neil et al. 2006

<sup>d</sup>RTECS 2007

CAS = Chemical Abstracts Service; DOT/UN/NA/IMDG = Department of Transportation/United Nations/North America/International Maritime Dangerous Goods Code; EPA = Environmental Protection Agency; HSDB = Hazardous Substances Data Bank; NCI = National Cancer Institute; NIOSH = National Institute for Occupational Safety and Health; OHM/TADS = Oil and Hazardous Material Technical Assistance Data System; RTECS = Registry of Toxic Effects of Chemical Substances

## 4. CHEMICAL AND PHYSICAL INFORMATION

**Table 4-2. Physical and Chemical Properties of Manganese and Compounds<sup>a</sup>**

| Property                      | Manganese  | Mn(II) chloride                               | Manganese sulfate                      |
|-------------------------------|--|---|--|
| Molecular weight              | 54.94 <sup>b</sup>   | 125.85 <sup>b</sup>                           | 151.00 <sup>b</sup>                    |
| Color                         | Steel-gray <sup>b</sup>  | Pink  | Pale rose-red                          |
| Physical state                | Solid  | Solid   | Solid                                  |
| Melting point                 | 1,244 °C <sup>c</sup>  | 650 °C  | 700 °C                                 |
| Boiling point                 | 2,095 °C <sup>b</sup>  | 1,412 °C <sup>b</sup>                         | 850 °C (decomposes)                    |
| Density at 20 °C              | 7.26 g/cm <sup>3</sup> <sup>b</sup> at 20 °C   | 2.325 g/cm <sup>3</sup> at 25 °C <sup>b</sup> | 3.25 g/cm <sup>3</sup> <sup>d</sup>    |
| Odor                          | No data  | No data                                       | Odorless                               |
| Odor threshold:               |  |   |  |
| Water                         | No data  | No data                                       | No data                                |
| Air                           | No data  | No data                                       | No data                                |
| Solubility:                   |  |   |  |
| Water at 20 °C                | Decomposes   | No data                                       | No data                                |
| Acids                         | Reacts with diluted mineral acids with evolution of hydrogen and formation of divalent manganous salts <sup>b</sup>  | No data                                       | No data                                |
| Organic solvents              | No data  | Soluble in alcohol, insoluble in ether        | Soluble in alcohol, insoluble in ether |
| Partition coefficients:       |  |   |  |
| Log K <sub>ow</sub>           | No data  | No data                                       | Not applicable                         |
| Log K <sub>oc</sub>           | No data  | No data                                       | Not applicable                         |
| Vapor pressure at 20 °C       | 1 Pa at 955 °C <sup>c</sup>  | 1,000 Pa at 760 °C <sup>c</sup>               | No data                                |
| Henry's law constant at 25 °C | No data  | Not applicable                                | Not applicable                         |
| Autoignition temperature      | No data  | Noncombustible                                | No data                                |
| Flashpoint                    | No data  | No data                                       | No data                                |
| Flammability limits           | Flammable and moderately explosive in dust form when exposed to flame <sup>d</sup>   | No data                                       | No data                                |
| Conversion factors            | Not applicable   | Not applicable                                | Not applicable                         |
| Explosive limits              | Mixture of aluminum and manganese dust may explode in air. Mixtures with ammonium nitrate may explode when heated <sup>d</sup>   | No data                                       | No data                                |
| Reactivity                    | Hydrogen <sup>d</sup> ; when heated above 200 °C in presence of nitrogen, forms nitrode; violent reaction with NO <sub>2</sub> and oxidants; incandescent reaction with phosphorous, nitryl fluoride, nitric acid <sup>d</sup> | No data                                       | No data                                |

## 4. CHEMICAL AND PHYSICAL INFORMATION

**Table 4-2. Physical and Chemical Properties of Manganese and Compounds<sup>a</sup>**

| Property                      | Manganese (II, III) oxide    | Manganese dioxide                   | Potassium permanganate                                  |
|-------------------------------|------------------------------|-------------------------------------|---|
| Molecular weight              | 228.81 <sup>b</sup>          | 86.94 <sup>b</sup>                  | 158.03 <sup>b</sup>                                     |
| Color                         | Brownish-black <sup>b</sup>  | Black                               | Purple  |
| Physical state                | Solid                        | Solid                               | Solid   |
| Melting point                 | 1,564 °C                     | Loses oxygen at 535 °C <sup>d</sup> | <240 °C (decomposes)                                    |
| Boiling point                 | No data                      | No data                             | No data   |
| Density at 20 °C              | No data                      | 5.0 g/cm <sup>3</sup> <sup>d</sup>  | 2.703 g/cm <sup>3</sup>                                 |
| Odor                          | No data                      | No data                             | Odorless  |
| Odor threshold:               |                              |                                     |   |
| Water                         | No data                      | No data                             | No data   |
| Air                           | No data                      | No data                             | No data   |
| Solubility:                   |                              |                                     |   |
| Water at 20 °C                | Insoluble                    | Insoluble                           | No data   |
| Acids                         | Soluble in hydrochloric acid | Soluble in hydrochloric acid        | Soluble in sulfuric acid                                |
| Organic solvents              | No data                      | No data                             | Soluble in acetone                                      |
| Partition coefficients:       |                              |                                     |   |
| Log K <sub>ow</sub>           | Not applicable               | No data                             | No data   |
| Log K <sub>oc</sub>           | Not applicable               | No data                             | No data   |
| Vapor pressure at 20 °C       | No data                      | No data                             | No data   |
| Henry's law constant at 25 °C | Not applicable               | No data                             | No data   |
| Autoignition temperature      | No data                      | No data                             | No data   |
| Flashpoint                    | No data                      | No data                             | No data   |
| Flammability limits           | No data                      | No data                             | No data   |
| Conversion factors            | Not applicable               | Not applicable                      | Not applicable  |
| Explosive limits              | No data                      | No data                             | No data   |
| Reactivity                    | No data                      | No data                             | Spontaneously flammable on contact with ethylene glycol |

## 4. CHEMICAL AND PHYSICAL INFORMATION

**Table 4-2. Physical and Chemical Properties of Manganese and Compounds<sup>a</sup>**

| Property                      | Mn(II) carbonate                    | Mangafodipir trisodium  | Methylcyclopentadienyl manganese tricarbonyl (MMT) <sup>f</sup>  |
|-------------------------------|-------------------------------------|---|--|
| Molecular weight              | 114.95                              | 757.4 <sup>e</sup>  | 218.1  |
| Color                         | Pink <sup>c</sup>                   | No data   | Yellow to dark orange  |
| Physical state                | hexagonal, crystals <sup>c</sup>    | Liquid (solution for infusion)  | Liquid, solid below 2 °C   |
| Melting point                 | Decomposes                          | No data   | 1.5 °C <sup>d</sup>  |
| Boiling point                 | No data                             | No data   | 232 °C   |
| Density at 20 °C              | 3.70 g/cm <sup>3</sup> <sup>c</sup> | 1.537 g/cm <sup>3</sup> <sup>b</sup>  | 1.39 g/cm <sup>3</sup>   |
| Odor                          | No data                             | No data   | Faint, pleasant  |
| Odor threshold:               |                                     |   |  |
| Water                         | No data                             | No data   | No data  |
| Air                           | No data                             | No data   | No data  |
| Solubility:                   |                                     |   |  |
| Water at 20 °C                | Insoluble                           | 459.6 g/L <sup>b</sup>  | Insoluble  |
| Acids                         | Soluble in dilute acid <sup>c</sup> | No data   | No data  |
| Organic solvents              | No data                             | 23 g/L (methanol);<br>0.8 g/L (ethanol);<br>0.6 g/L (acetone);<br>1.1 g/L (chloroform) <sup>b</sup> | Readily soluble in hydrocarbons and the usual organic solvents including hexane, alcohols, ethers, acetone, ethylene glycol, lubricating oils, gasoline and diesel fuel <sup>b</sup> |
| Partition coefficients:       |                                     |   |  |
| Log K <sub>ow</sub>           | No data                             | -5.62 <sup>b</sup>  | No data  |
| Log K <sub>oc</sub>           | No data                             | No data   | No data  |
| Vapor pressure at 20 °C       | No data                             | No data   | Ranges from 8 mm Hg at 100 °C to 360.6 mm Hg at 200 °C <sup>b</sup>  |
| Henry's law constant at 25 °C | No data                             | No data   | No data  |
| Autoignition temperature      | No data                             | No data   | No data  |
| Flashpoint                    | No data                             | No data   | 110 °C   |
| Flammability limits           | No data                             | No data   | No data  |
| Conversion factors            | Not applicable                      | No data   | No data  |
| Explosive limits              | No data                             | No data   | No data  |
| Reactivity                    | No data                             | No data   | Light (decomposes)   |

<sup>a</sup>All information obtained from Sax and Lewis 1987, except where noted.

<sup>b</sup>O'Neil et al. 2006

<sup>c</sup>Lide 2000

<sup>d</sup>Lewis 2000

<sup>e</sup>RTECS 2007

<sup>f</sup>Data for MMT from NIOSH 2005 unless otherwise noted

4. CHEMICAL AND PHYSICAL INFORMATION

This page is intentionally blank.

## 5. PRODUCTION, IMPORT/EXPORT, USE, AND DISPOSAL

### 5.1 PRODUCTION

Tables 5-1 and 5-2 list the facilities in each state that manufacture or process manganese, the intended use, and the range of maximum amounts of manganese that are stored on site. The data listed in Tables 5-1 and 5-2 are derived from the Toxics Release Inventory (TRI06 2008). Only certain types of facilities were required to report. Therefore, this is not an exhaustive list.

Manganese is an abundant element comprising about 0.1% of the earth's crust (Graedel 1978). It does not occur naturally as a base metal, but is a component of over 100 minerals, including various sulfides, oxides, carbonates, silicates, phosphates, and borates (NAS 1973). The most commonly occurring manganese-bearing minerals include pyrolusite (manganese dioxide), rhodochrosite (manganese carbonate), and rhodanate (manganese silicate) (EPA 1984; NAS 1973; Windholz et al. 1983).

Most manganese ore is smelted in electric furnaces to produce ferromanganese, a manganese-iron alloy widely used in the production of steel (EPA 1984; NAS 1973). Approximately 2 tons of manganese ore are required to make 1 ton of ferromanganese (NAS 1973). Production of manganese metal is achieved by aluminum reduction of low iron-content manganese ore, and electrolytically from sulfate or chloride solution (Lewis 2001). Manganese with <0.1% metallic impurities can be produced electrolytically from a manganese sulfate solution (EPA 1984; Lewis 2001).

Manganese compounds are produced either from manganese ores or from manganese metal. For example, manganese chloride is produced by the reaction of hydrochloric acid with manganese oxide (Pisarczyk 2005). Manganese carbonate and manganese sulfate are produced by dissolving manganese carbonate ore (rhodochrosite) or Mn(II) oxide in sulfuric acid (Pisarczyk 2005). Potassium permanganate may be manufactured by the one-step electrolytic conversion of ferromanganese to permanganate, or by a two-step process involving the thermal oxidation of manganese(IV) dioxide of a naturally occurring ore into potassium manganate(VI), followed by electrolytic oxidation to permanganate (Pisarczyk 2005).

Most manganese is mined in open pit or shallow underground mines (EPA 1984; NAS 1973). Manganese ores were previously mined in the United States, but no appreciable quantity has been mined in the United States since 1978 (USGS 2007). The only mine production of manganese in the United States consisted of small amounts of manganiferous material having a natural manganese content of <5%. This type of

## 5. PRODUCTION, IMPORT/EXPORT, USE, AND DISPOSAL

**Table 5-1. Facilities that Produce, Process, or Use Manganese**

| State <sup>a</sup> | Number of facilities | Minimum amount on site in pounds <sup>b</sup> | Maximum amount on site in pounds <sup>b</sup> | Activities and uses <sup>c</sup>              |
|--------------------|----------------------|---|---|---|
| AK                 | 4                    | 0   | 99,999  | 1, 5, 12, 13, 14                              |
| AL                 | 93                   | 0   | 499,999,999                                   | 1, 2, 3, 4, 5, 6, 7, 8, 9, 10, 11, 12, 13, 14 |
| AR                 | 61                   | 0   | 49,999,999                                    | 1, 2, 3, 4, 5, 6, 7, 8, 9, 11, 12, 13, 14     |
| AZ                 | 36                   | 0   | 49,999,999                                    | 1, 2, 3, 4, 5, 6, 7, 8, 9, 10, 11, 12, 13, 14 |
| CA                 | 108                  | 0   | 999,999,999                                   | 1, 2, 3, 4, 5, 6, 7, 8, 9, 10, 11, 12, 13, 14 |
| CO                 | 37                   | 100   | 499,999,999                                   | 1, 2, 3, 4, 5, 6, 7, 8, 9, 10, 11, 12, 14     |
| CT                 | 25                   | 0   | 9,999,999                                     | 1, 2, 3, 4, 5, 7, 8, 9, 10, 11, 12, 13        |
| DE                 | 5                    | 100   | 999,999                                       | 1, 3, 4, 5, 8, 10                             |
| FL                 | 45                   | 100   | 499,999,999                                   | 1, 2, 3, 4, 5, 6, 7, 8, 9, 10, 11, 12, 13, 14 |
| GA                 | 62                   | 0   | 99,999,999                                    | 1, 2, 3, 4, 5, 6, 7, 8, 9, 11, 12, 14         |
| HI                 | 5                    | 100   | 99,999  | 2, 3, 4, 7, 8, 12                             |
| IA                 | 94                   | 0   | 999,999,999                                   | 1, 2, 3, 4, 5, 6, 7, 8, 9, 10, 11, 12, 13, 14 |
| ID                 | 11                   | 1,000   | 9,999,999                                     | 1, 3, 4, 5, 7, 8, 12, 13                      |
| IL                 | 169                  | 0   | 499,999,999                                   | 1, 2, 3, 4, 5, 6, 7, 8, 9, 10, 11, 12, 13, 14 |
| IN                 | 171                  | 0   | 999,999,999                                   | 1, 2, 3, 4, 5, 6, 7, 8, 9, 10, 11, 12, 13, 14 |
| KS                 | 49                   | 0   | 499,999,999                                   | 1, 2, 3, 4, 5, 6, 7, 8, 9, 10, 11, 12, 13, 14 |
| KY                 | 96                   | 0   | 499,999,999                                   | 1, 2, 3, 4, 5, 6, 7, 8, 9, 10, 11, 12, 13, 14 |
| LA                 | 53                   | 0   | 49,999,999                                    | 1, 2, 3, 4, 5, 6, 7, 8, 9, 10, 11, 12, 13, 14 |
| MA                 | 36                   | 0   | 49,999,999                                    | 1, 2, 3, 4, 5, 7, 8, 9, 11, 12, 14            |
| MD                 | 36                   | 0   | 499,999,999                                   | 1, 2, 3, 4, 5, 6, 7, 8, 9, 10, 11, 12, 13     |
| ME                 | 21                   | 0   | 999,999                                       | 1, 2, 3, 5, 6, 8, 11, 12, 13                  |
| MI                 | 157                  | 0   | 999,999,999                                   | 1, 2, 3, 4, 5, 6, 7, 8, 9, 10, 11, 12, 13, 14 |
| MN                 | 56                   | 0   | 999,999                                       | 1, 2, 3, 4, 5, 6, 7, 8, 9, 10, 11, 12, 13, 14 |
| MO                 | 76                   | 0   | 49,999,999                                    | 1, 2, 3, 4, 5, 6, 7, 8, 9, 10, 11, 12, 13, 14 |
| MS                 | 37                   | 0   | 9,999,999                                     | 1, 2, 3, 4, 5, 7, 8, 9, 10, 11, 12, 13, 14    |
| MT                 | 9                    | 10,000  | 999,999                                       | 1, 2, 3, 4, 5, 7, 8, 9, 10, 11, 12            |
| NC                 | 91                   | 0   | 499,999,999                                   | 1, 2, 3, 4, 5, 6, 7, 8, 9, 10, 11, 12, 13, 14 |
| ND                 | 16                   | 100   | 9,999,999                                     | 1, 2, 3, 4, 5, 7, 8, 9, 10, 11, 12            |
| NE                 | 43                   | 0   | 49,999,999                                    | 1, 2, 3, 4, 5, 7, 8, 9, 10, 11, 12, 13, 14    |
| NH                 | 14                   | 0   | 49,999,999                                    | 1, 5, 7, 8, 11, 12, 13                        |
| NJ                 | 65                   | 0   | 499,999,999                                   | 1, 2, 3, 4, 5, 6, 7, 8, 9, 11, 12, 13, 14     |
| NM                 | 5                    | 1,000   | 9,999,999                                     | 6, 8, 11, 12                                  |
| NV                 | 32                   | 0   | 49,999,999                                    | 1, 2, 3, 4, 5, 6, 7, 8, 9, 10, 11, 12, 13, 14 |
| NY                 | 98                   | 0   | 9,999,999                                     | 1, 2, 3, 4, 5, 6, 7, 8, 9, 10, 11, 12, 14     |
| OH                 | 221                  | 0   | 499,999,999                                   | 1, 2, 3, 4, 5, 6, 7, 8, 9, 10, 11, 12, 13, 14 |
| OK                 | 72                   | 0   | 499,999,999                                   | 1, 2, 3, 4, 5, 6, 7, 8, 9, 10, 11, 12, 13     |
| OR                 | 57                   | 0   | 99,999,999                                    | 1, 2, 3, 4, 5, 6, 7, 8, 9, 10, 11, 12, 13, 14 |
| PA                 | 212                  | 0   | 999,999,999                                   | 1, 2, 3, 4, 5, 6, 7, 8, 9, 10, 11, 12, 13, 14 |
| PR                 | 11                   | 100   | 999,999                                       | 2, 3, 4, 7, 8, 11, 12                         |



## 5. PRODUCTION, IMPORT/EXPORT, USE, AND DISPOSAL

**Table 5-1. Facilities that Produce, Process, or Use Manganese**

| State <sup>a</sup> | Number of facilities | Minimum amount on site in pounds <sup>b</sup> | Maximum amount on site in pounds <sup>b</sup> | Activities and uses <sup>c</sup>              |
|--------------------|----------------------|---|---|---|
| RI                 | 12                   | 0   | 999,999                                       | 2, 3, 4, 8, 9, 11, 12                         |
| SC                 | 62                   | 0   | 99,999,999                                    | 1, 2, 3, 4, 5, 6, 7, 8, 9, 11, 12, 13, 14     |
| SD                 | 29                   | 0   | 49,999,999                                    | 1, 2, 3, 5, 7, 8, 9, 11, 12, 13, 14           |
| TN                 | 99                   | 0   | 499,999,999                                   | 1, 2, 3, 4, 5, 6, 7, 8, 9, 10, 11, 12, 13, 14 |
| TX                 | 141                  | 0   | 499,999,999                                   | 1, 2, 3, 4, 5, 6, 7, 8, 9, 10, 11, 12, 13, 14 |
| UT                 | 60                   | 0   | 499,999,999                                   | 1, 2, 3, 4, 5, 6, 7, 8, 9, 10, 11, 12, 13, 14 |
| VA                 | 58                   | 0   | 9,999,999                                     | 1, 2, 3, 4, 5, 6, 7, 8, 9, 10, 11, 12, 13, 14 |
| VT                 | 4                    | 0   | 999,999                                       | 2, 4, 7, 11, 12                               |
| WA                 | 59                   | 0   | 9,999,999                                     | 1, 2, 3, 4, 5, 6, 7, 8, 9, 10, 11, 12, 13     |
| WI                 | 132                  | 0   | 999,999,999                                   | 1, 2, 3, 4, 5, 6, 7, 8, 9, 10, 11, 12, 13, 14 |
| WV                 | 44                   | 0   | 499,999,999                                   | 1, 2, 3, 4, 5, 6, 7, 8, 9, 10, 11, 12, 13, 14 |
| WY                 | 11                   | 0   | 999,999                                       | 1, 2, 3, 5, 8, 9, 11, 12, 13, 14              |

<sup>a</sup>Post office state abbreviations used

<sup>b</sup>Amounts on site reported by facilities in each state

<sup>c</sup>Activities/Uses:

- |                          |                          |                             |
|--------------------------|--------------------------|-----------------------------|
| 1. Produce               | 6. Impurity              | 11. Chemical processing aid |
| 2. Import                | 7. Reactant              | 12. Manufacturing aid       |
| 3. Onsite use/processing | 8. Formulation component | 13. Ancillary/other uses    |
| 4. Sale/distribution     | 9. Article component     | 14. Process impurity        |
| 5. Byproduct             | 10. Repackaging          |                             |

Source: TRI06 2008 (Data are from 2006)

## 5. PRODUCTION, IMPORT/EXPORT, USE, AND DISPOSAL

**Table 5-2. Facilities that Produce, Process, or Use Manganese Compounds**

| State <sup>a</sup> | Number of facilities | Minimum amount on site in pounds <sup>b</sup> | Maximum amount on site in pounds <sup>b</sup> | Activities and uses <sup>c</sup>              |
|--------------------|----------------------|---|---|---|
| AK                 | 12                   | 0   | 49,999,999                                    | 1, 2, 3, 5, 7, 8, 11, 12, 13, 14              |
| AL                 | 141                  | 0   | 499,999,999                                   | 1, 2, 3, 4, 5, 6, 7, 8, 9, 10, 11, 12, 13, 14 |
| AR                 | 68                   | 0   | 49,999,999                                    | 1, 2, 3, 4, 5, 6, 7, 8, 9, 11, 12, 13, 14     |
| AZ                 | 55                   | 100   | 999,999,999                                   | 1, 2, 3, 4, 5, 6, 7, 8, 9, 11, 12, 13, 14     |
| CA                 | 100                  | 0   | 999,999,999                                   | 1, 2, 3, 4, 5, 6, 7, 8, 9, 10, 11, 12, 13, 14 |
| CO                 | 52                   | 100   | 499,999,999                                   | 1, 3, 4, 5, 6, 7, 8, 9, 10, 11, 12, 13, 14    |
| CT                 | 30                   | 0   | 9,999,999                                     | 1, 2, 3, 4, 5, 6, 7, 8, 9, 10, 11, 12, 13, 14 |
| DC                 | 2                    | 1,000   | 99,999  | 12  |
| DE                 | 32                   | 0   | 9,999,999                                     | 1, 2, 3, 5, 7, 8, 9, 10, 11, 12, 13, 14       |
| FL                 | 88                   | 0   | 9,999,999                                     | 1, 2, 3, 4, 5, 6, 7, 8, 9, 10, 11, 12, 13, 14 |
| GA                 | 93                   | 0   | 49,999,999                                    | 1, 2, 3, 4, 5, 6, 7, 8, 9, 10, 11, 12, 13, 14 |
| HI                 | 6                    | 100   | 999,999                                       | 1, 5, 7, 9, 10                                |
| IA                 | 90                   | 0   | 49,999,999                                    | 1, 2, 3, 4, 5, 6, 7, 8, 9, 10, 11, 12, 13, 14 |
| ID                 | 25                   | 0   | 49,999,999                                    | 1, 5, 6, 7, 8, 10, 11, 12, 13                 |
| IL                 | 186                  | 0   | 499,999,999                                   | 1, 2, 3, 4, 5, 6, 7, 8, 9, 10, 11, 12, 13, 14 |
| IN                 | 150                  | 0   | 499,999,999                                   | 1, 2, 3, 4, 5, 6, 7, 8, 9, 10, 11, 12, 13, 14 |
| KS                 | 68                   | 0   | 499,999,999                                   | 1, 2, 3, 4, 5, 6, 7, 8, 9, 10, 11, 12, 13, 14 |
| KY                 | 85                   | 0   | 999,999,999                                   | 1, 2, 3, 4, 5, 6, 7, 8, 9, 11, 12, 13, 14     |
| LA                 | 58                   | 0   | 9,999,999                                     | 1, 2, 3, 4, 5, 6, 7, 8, 9, 10, 11, 12, 13, 14 |
| MA                 | 28                   | 0   | 999,999                                       | 1, 2, 3, 4, 5, 6, 7, 8, 9, 11, 12, 13         |
| MD                 | 69                   | 100   | 99,999,999                                    | 1, 2, 3, 4, 5, 6, 7, 8, 9, 10, 11, 12, 13, 14 |
| ME                 | 18                   | 0   | 9,999,999                                     | 1, 5, 6, 8, 13, 14                            |
| MI                 | 159                  | 0   | 499,999,999                                   | 1, 2, 3, 4, 5, 6, 7, 8, 9, 10, 11, 12, 13, 14 |
| MN                 | 59                   | 0   | 49,999,999                                    | 1, 2, 3, 4, 5, 6, 7, 8, 9, 10, 11, 12, 13, 14 |
| MO                 | 79                   | 0   | 499,999,999                                   | 1, 2, 3, 4, 5, 6, 7, 8, 9, 10, 11, 12, 13, 14 |
| MS                 | 66                   | 0   | 49,999,999                                    | 1, 2, 3, 4, 5, 6, 7, 8, 9, 10, 11, 12, 13, 14 |
| MT                 | 23                   | 100   | 499,999,999                                   | 1, 2, 3, 4, 5, 6, 7, 8, 9, 12, 13, 14         |
| NC                 | 116                  | 0   | 99,999,999                                    | 1, 2, 3, 4, 5, 6, 7, 8, 9, 10, 11, 12, 13, 14 |
| ND                 | 21                   | 1,000   | 9,999,999                                     | 1, 3, 5, 7, 8, 9, 10, 11, 12, 13, 14          |
| NE                 | 49                   | 0   | 9,999,999                                     | 1, 2, 3, 4, 5, 6, 7, 8, 9, 11, 12, 13, 14     |
| NH                 | 10                   | 0   | 99,999  | 1, 2, 3, 5, 7, 8, 9                           |
| NJ                 | 86                   | 0   | 49,999,999                                    | 1, 2, 3, 4, 5, 6, 7, 8, 9, 10, 11, 12, 13, 14 |
| NM                 | 29                   | 100   | 10,000,000,000                                | 1, 3, 4, 5, 7, 9, 12, 13, 14                  |
| NV                 | 33                   | 1,000   | 499,999,999                                   | 1, 2, 3, 4, 5, 6, 8, 9, 10, 11, 12, 13, 14    |
| NY                 | 113                  | 0   | 49,999,999                                    | 1, 2, 3, 4, 5, 6, 7, 8, 9, 10, 11, 12, 13, 14 |
| OH                 | 253                  | 0   | 499,999,999                                   | 1, 2, 3, 4, 5, 6, 7, 8, 9, 10, 11, 12, 13, 14 |
| OK                 | 49                   | 0   | 499,999,999                                   | 1, 2, 3, 4, 5, 6, 7, 8, 9, 10, 11, 12, 13, 14 |
| OR                 | 48                   | 0   | 9,999,999                                     | 1, 2, 3, 4, 5, 6, 7, 8, 9, 10, 11, 12, 13, 14 |

## 5. PRODUCTION, IMPORT/EXPORT, USE, AND DISPOSAL

**Table 5-2. Facilities that Produce, Process, or Use Manganese Compounds**

| State <sup>a</sup> | Number of facilities | Minimum amount on site in pounds <sup>b</sup> | Maximum amount on site in pounds <sup>b</sup> | Activities and uses <sup>c</sup>              |
|--------------------|----------------------|---|---|---|
| PA                 | 243                  | 0   | 99,999,999                                    | 1, 2, 3, 4, 5, 6, 7, 8, 9, 10, 11, 12, 13, 14 |
| PR                 | 18                   | 0   | 999,999                                       | 1, 2, 3, 4, 5, 7, 8, 9, 10, 11, 12            |
| RI                 | 5                    | 10,000  | 999,999                                       | 8, 11   |
| SC                 | 91                   | 0   | 99,999,999                                    | 1, 2, 3, 4, 5, 6, 7, 8, 9, 10, 11, 12, 13, 14 |
| SD                 | 12                   | 100   | 9,999,999                                     | 1, 5, 6, 7, 8, 9, 11, 12, 13, 14              |
| TN                 | 122                  | 0   | 49,999,999                                    | 1, 2, 3, 4, 5, 6, 7, 8, 9, 10, 11, 12, 13, 14 |
| TX                 | 181                  | 0   | 499,999,999                                   | 1, 2, 3, 4, 5, 6, 7, 8, 9, 10, 11, 12, 13, 14 |
| UT                 | 71                   | 100   | 999,999,999                                   | 1, 2, 3, 4, 5, 6, 7, 8, 9, 10, 11, 12, 13, 14 |
| VA                 | 64                   | 0   | 9,999,999                                     | 1, 2, 3, 4, 5, 6, 7, 8, 9, 10, 11, 12, 13, 14 |
| VT                 | 3                    | 1,000   | 99,999  | 1, 5, 7, 8                                    |
| WA                 | 72                   | 0   | 49,999,999                                    | 1, 2, 3, 4, 5, 6, 7, 8, 9, 10, 11, 12, 13, 14 |
| WI                 | 96                   | 0   | 499,999,999                                   | 1, 2, 3, 4, 5, 6, 7, 8, 9, 10, 11, 12, 13, 14 |
| WV                 | 60                   | 0   | 499,999,999                                   | 1, 2, 3, 4, 5, 6, 7, 8, 9, 10, 11, 12, 13, 14 |
| WY                 | 24                   | 0   | 999,999                                       | 1, 3, 4, 5, 7, 9, 12, 13, 14                  |

<sup>a</sup>Post office state abbreviations used

<sup>b</sup>Amounts on site reported by facilities in each state

<sup>c</sup>Activities/Uses:

- |                           |                          |                             |
|---------------------------|--------------------------|-----------------------------|
| 1. Produce                | 6. Impurity              | 11. Chemical processing aid |
| 2. Import                 | 7. Reactant              | 12. Manufacturing aid       |
| 3. On-site use/processing | 8. Formulation component | 13. Ancillary/other uses    |
| 4. Sale/distribution      | 9. Article component     | 14. Process impurity        |
| 5. Byproduct              | 10. Repackaging          |                             |

Source: TRI06 2008 (Data are from 2006)

## 5. PRODUCTION, IMPORT/EXPORT, USE, AND DISPOSAL

material was produced in South Carolina for use in coloring brick (USGS 2007). Essentially all manganese ore used in manganese production in the United States is now imported (USGS 2007).

Currently, there are 3,200 facilities in the United States that indicate that they produce, process, or use manganese (TRI06 2008). These facilities are scattered across the United States, with the largest numbers in Ohio (221), Pennsylvania (212), and Indiana (171). Over 3,700 facilities are involved in the distribution or use of manganese or manganese compounds (TRI06 2008). Tables 5-1 and 5-2 list the number of facilities in each state, the ranges of the maximum amounts stored at each facility, and the uses of the material (TRI06 2008).

The organomanganese compound methylcyclopentadienyl manganese tricarbonyl (MMT) is produced in either of the following ways: via the reaction of manganous chloride, cyclopentadiene, and carbon monoxide in the presence of manganese carbonyl and an element of group II or IIIA, or via the reaction of methylcyclopentadiene with manganese carbonyl (EPA 1984; Sax and Lewis 1987). According to data submitted to the EPA by the American Chemistry Council Petroleum Additives Panel, MMT is manufactured by adding methylcyclopentadienyl dimer to a dispersion of sodium metal in diethylene glycol dimethyl ether under a nitrogen environment (EPA 2006b). Keeping the mixture at elevated temperature yields sodium-methylcyclopentadienyl, which is an intermediate in the reaction process. Manganese chloride is added to the stirred mixture containing the sodium methylcyclopentadienyl intermediate. The reaction eventually yields bis(methylcyclopentadienyl)manganese as a second intermediate of the reaction process. The reaction vessel is then pressurized with carbon monoxide, which results in the formation of MMT, which is separated from the reaction mixture via vacuum distillation (EPA 2006b).

No production data from facilities that manufacture or process MMT were found. According to data from the 2007 Directory of Chemical Producers, only one company located in Orangeburg, South Carolina produces MMT in the United States (SRI 2007).

Mn(II) dipyridoxyl diphosphate (MnDPDP), or mangafodipir trisodium, is classified as a drug or therapeutic agent, and no production data were found for it.

## 5. PRODUCTION, IMPORT/EXPORT, USE, AND DISPOSAL

**5.2 IMPORT/EXPORT**

The United States does not produce manganese and is 100% import reliant (USGS 2007). Import and export data for manganese are provided in Table 5-3. Demand for manganese metal comes primarily from the aluminum and steel industry (USGS 2007). Manganese consumption in 2007 was about 13% lower than that of 2006, owing to constant demand by the domestic steel industry and reduction of producer and consumer stocks. From January through August of 2007, domestic steel production was 1.4% lower than that for the same period in 2006 (USGS 2008). The United States imports the bulk of its manganese ore from Gabon, 65%; South Africa, 19%; Australia, 7%; Ghana, 2%; and other nations, 7% (USGS 2007). Ferromanganese is imported from South Africa, 51%; China, 14%; Mexico, 6%; Republic of Korea, 5%; and other nations, 24% (USGS 2007).

There were no data located regarding the import or export of MMT or mangafodipir.

**5.3 USE**

Metallic manganese (ferromanganese) is used principally in steel production to improve hardness, stiffness, and strength. It is used in carbon steel, stainless steel, high-temperature steel, and tool steel, along with cast iron and superalloys (EPA 1984; NAS 1973). According to data obtained from the U.S. Geological Society (USGS), manganese ore was consumed primarily by eight firms with plants principally in the east and midwest United States (USGS 2008). The majority of ore consumed was associated with steel production, directly in pig iron manufacture and indirectly through upgrading ore to ferroalloys. Additional quantities of ore were used for nonmetallurgical purposes such as production of dry cell batteries, in plant fertilizers and animal feed, and as a brick colorant. Manganese ferroalloys were produced at two smelters, although one operated sporadically throughout the year (USGS 2008). Construction, machinery, and transportation end uses accounted for approximately 24, 10, and 10%, respectively, of manganese demand (USGS 2008). Most of the rest went to a variety of other iron and steel applications. The value of domestic consumption, estimated from foreign trade data, was about \$730 million (USGS 2008).

Manganese compounds have a variety of uses. Manganese dioxide is commonly used in production of dry-cell batteries, matches, fireworks, porcelain and glass-bonding materials, amethyst glass, and as the starting material for production of other manganese compounds (EPA 1984; NAS 1973; Venugopal and Luckey 1978). Manganese chloride is used as a precursor for other manganese compounds, as a catalyst in the chlorination of organic compounds, in animal feed to supply essential trace minerals, and in

## 5. PRODUCTION, IMPORT/EXPORT, USE, AND DISPOSAL

**Table 5-3. Manganese Import/Export Data for 2003–2007**

|                                      | 2003 | 2004 | 2005 | 2006 | 2007 |
|--------------------------------------|------|------|------|------|------|
| Imports for consumption <sup>a</sup> |      |      |      |      |      |
| Manganese ore                        | 347  | 451  | 656  | 572  | 610  |
| Ferromanganese                       | 238  | 429  | 255  | 358  | 322  |
| Silicomanganese                      | 267  | 422  | 327  | 400  | 390  |
| Exports <sup>a</sup>                 |      |      |      |      |      |
| Manganese ore                        | 18   | 123  | 13   | 2    | 2    |
| Ferromanganese                       | 11   | 9    | 14   | 22   | 33   |

<sup>a</sup>Data in thousand metric tons gross weight

Source: USGS 2008

## 5. PRODUCTION, IMPORT/EXPORT, USE, AND DISPOSAL

dry-cell batteries (EPA 1984). Manganese sulfate is used primarily as a component of fertilizer (60% of total consumption) and as a livestock supplement (30% of total consumption); it is also used in some glazes, varnishes, ceramics, and fungicides (EPA 1984; Windholz et al. 1983). Potassium permanganate's oxidizing power allows it to be used as a disinfectant; an antialgal agent; for metal cleaning, tanning, and bleaching; and as a water purification agent (Lewis 2001). Another common source of manganese is found in the street drug "Bazooka". It is a cocaine-based drug contaminated with manganese-carbonate from free-base preparation methods (Ensing 1985).

MMT is a fuel additive developed in the 1950s to increase the octane level of gasoline and thus improve the antiknock properties of the fuel (Davis 1998; EPA 1984; Lynam et al. 1990; NAS 1973). MMT was introduced into Canada in 1976 and its use increased so substantially that it completely replaced tetraethyl lead in gasoline in that country in 1990 (Zayed et al. 1999a). The major refiners in Canada have voluntarily stopped using MMT, out of concern that its use may harm on-board diagnostic equipment (OBD), which monitors the performance of emissions control devices in the vehicle (ICCT 2004). As a result, as much as 95% of Canadian gasoline is now MMT-free (ICCT 2004). MMT was used as an additive in leaded gasoline in the United States; however, EPA banned its use in unleaded gasoline in 1977 (EPA 1978, 1979a, 1981). In 1995, the ban on MMT use in unleaded gasoline was lifted, and a court decision ordered EPA to register the product for use as a fuel additive (EPA 1995a). Recent data suggest that MMT is currently used only sparsely in the developed world including the United States, although exact quantities are not known (ICCT 2004). Historical data suggest that approximately 70 million pounds of MMT were sold for use in leaded gasoline in the United States between 1976 and 1990 (Veysseyre et al. 1998).

Mangafodipir trisodium (MnDPDP) is used as both a liver- and pancreas-specific contrast agent for magnetic resonance imaging (MRI); it improves lesion detection in MRI of these organs by selectively enhancing the normal parenchyma, but not lesions, so that the contrast between tumorous and normal tissue is increased (Federle et al. 2000).

#### 5.4 DISPOSAL

Manganese is listed as a toxic substance under Section 313 of the Emergency Planning and Community Right to Know Act (EPCRA) under Title III of the Superfund Amendments and Reauthorization Act (SARA) (EPA 1998). Disposal of wastes containing manganese is controlled by a number of federal regulations (see Chapter 8).

## 5. PRODUCTION, IMPORT/EXPORT, USE, AND DISPOSAL

Disposal of waste manganese into water requires a discharge permit from the EPA (see Chapter 8), but disposal of solid wastes such as manganese metal or manganese compounds is not regulated under current federal law. There are incomplete federal records of this disposal because most, but not all, solid manganese wastes are disposed of by being deposited on land or by being trucked to off-site disposal facilities (TRIO6 2008). The total amount of waste manganese disposed of in this way in 2006 was in excess of 200 million pounds (TRIO6 2008) (see Tables 6-1 and 6-2).

Manganese and other metals are commonly recycled for future use. In 1998, 218,000 metric tons of manganese were estimated to have been recycled from old scrap, of which 96% was from iron and steel scrap (USGS 2001). In 2007, the USGS reported that manganese was recycled incidentally as a minor constituent of ferrous and nonferrous scrap; however, scrap recovery specifically for manganese was negligible (USGS 2008). No quantitative statistics were provided regarding the amount recovered from steel slag.

No information on disposal of MMT was located.



## 6. POTENTIAL FOR HUMAN EXPOSURE

### 6.1 OVERVIEW

Manganese has been identified in at least 869 of the 1,699 hazardous waste sites that have been proposed for inclusion on the EPA National Priorities List (NPL) (HazDat 2008). However, the number of sites evaluated for manganese is not known. The frequency of these sites can be seen in Figure 6-1. Of these sites, 861 are located within the United States, 5 are located in the Commonwealth of Puerto Rico, 2 are located in the Virgin Islands, and 1 is located in Guam (not shown).

Manganese is ubiquitous in the environment, and human exposure arises from both natural and anthropogenic activities. It occurs naturally in more than 100 minerals with background levels in soil ranging from 40 to 900 mg/kg, with an estimated mean background concentration of 330 mg/kg (Barceloux 1999). Manganese is released to the environment from industrial emissions, fossil fuel combustion, and erosion of manganese-containing soils. Volcanic eruptions can also contribute to levels of manganese in air. Almost 80% of industrial emissions of manganese are attributable to iron and steel production facilities (EPA 2003a). Power plant and coke oven emissions contribute about 20% (EPA 2003a). Manganese may also be released to the environment through the use of MMT as a gasoline additive. Thus, all humans are exposed to manganese, and manganese is a normal component of the human body.

Background levels of manganese in the atmosphere vary widely depending on the proximity of point sources, such as ferroalloy production facilities, coke ovens, and power plants. The estimated average background concentration of manganese in urban areas is approximately 40 ng/m<sup>3</sup>, based on measurements obtained in 102 U.S. cities (EPA 2003a; WHO 2004b). Concentrations near source dominated areas were reported to range from 220 to 300 ng/m<sup>3</sup> (WHO 2004b) and rural/remote levels are typically under 10 ng/m<sup>3</sup> (Sweet et al. 1993). Manganese occurs naturally in surface water and groundwater. A median dissolved manganese concentration of 24 µg/L in samples from 286 U.S. rivers and streams was reported (Smith et al. 1987). Natural concentrations of manganese in seawater reportedly range from 0.4 to 10 µg/L (EPA 1984).

The general population is exposed to manganese primarily through food intake. The World Health Organization (WHO) estimates that adults consume between 0.7 and 10.9 mg of manganese per day in the diet, with higher intakes for vegetarians who may consume a larger proportion of manganese-rich nuts, grains, and legumes in their diet as compared to non-vegetarians in the general population (WHO 2004b).

6. POTENTIAL FOR HUMAN EXPOSURE

**Figure 6-1. Frequency of NPL Sites with Manganese Contamination**

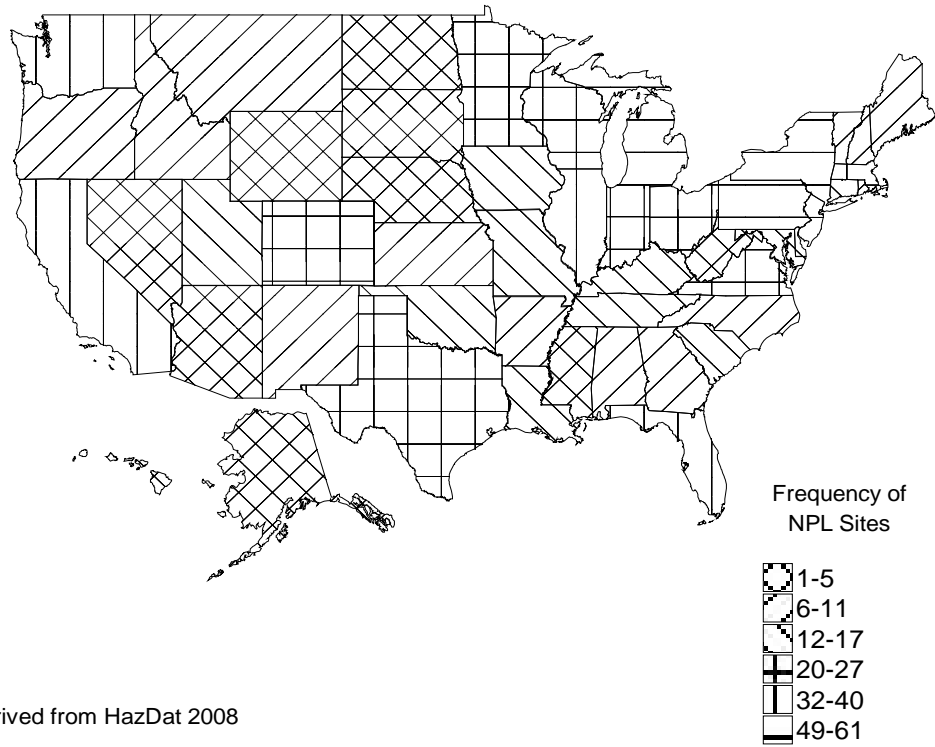

Derived from HazDat 2008

## 6. POTENTIAL FOR HUMAN EXPOSURE

Manganese intake from drinking water is substantially lower than intake from food. Using a median drinking-water level of 10 µg/L and an assumption that the average adult drinks 2 L of water/day, an average intake of approximately 0.020 mg/day was estimated (WHO 2004b). Exposure to manganese from air is considered negligible as compared to intake from diet; however, persons in certain occupations may be exposed to much higher levels than the general public (see Section 6.7).

Manganese adsorbed to particulate matter in air can be classified by the size of the particles. Air concentrations can be reported as total suspended particulate matter (TSP), respirable particulates, and fine particulates. In this document, manganese adsorbed to particulate matter <10 microns in aerodynamic diameter is referred to as PM<sub>10</sub>. The EPA has further divided these tiny particles into "fine" particles of ≤2.5 microns (PM<sub>2.5</sub>) and "coarse" particles of between 2.5 and 10 microns.

## 6.2 RELEASES TO THE ENVIRONMENT

The Toxics Release Inventory (TRI) data should be used with caution because only certain types of facilities are required to report (EPA 2005). This is not an exhaustive list. Manufacturing and processing facilities are required to report information to the TRI only if they employ 10 or more full-time employees; if their facility is included in Standard Industrial Classification (SIC) Codes 10 (except 1011, 1081, and 1094), 12 (except 1241), 20–39, 4911 (limited to facilities that combust coal and/or oil for the purpose of generating electricity for distribution in commerce), 4931 (limited to facilities that combust coal and/or oil for the purpose of generating electricity for distribution in commerce), 4939 (limited to facilities that combust coal and/or oil for the purpose of generating electricity for distribution in commerce), 4953 (limited to facilities regulated under RCRA Subtitle C, 42 U.S.C. section 6921 et seq.), 5169, 5171, and 7389 (limited S.C. section 6921 et seq.), 5169, 5171, and 7389 (limited to facilities primarily engaged in solvents recovery services on a contract or fee basis); and if their facility produces, imports, or processes ≥25,000 pounds of any TRI chemical or otherwise uses >10,000 pounds of a TRI chemical in a calendar year (EPA 2005).

According to the Toxics Release Inventory (TRI), in 2006, a total of 27,094,361 pounds (12,290 metric tons) of manganese was released to the environment from 2,040 large processing facilities (TRI06 2008). An additional 199,804,760 pounds (90,630 metric tons) of manganese compounds were released from 1,748 facilities. Tables 6-1, and 6-2 list the amount of manganese and manganese related compounds, respectively, that were released from all of the facilities that manufacture or process manganese to each medium within each state in 2006 (TRI06 2008). The TRI data should be used with caution because only

## 6. POTENTIAL FOR HUMAN EXPOSURE

**Table 6-1. Releases to the Environment from Facilities that Produce, Process, or Use Manganese<sup>a</sup>**

| State <sup>c</sup> | RF <sup>d</sup> | Reported amounts released in pounds per year <sup>b</sup> |                    |                 |                   |                    |                      |                       |                  |
|--------------------|-----------------|---|--------------------|-----------------|-------------------|--------------------|----------------------|-----------------------|------------------|
|                    |                 | Air <sup>e</sup>  | Water <sup>f</sup> | UI <sup>g</sup> | Land <sup>h</sup> | Other <sup>i</sup> | Total release        |                       |                  |
|                    |                 |   |                    |                 |                   |                    | On-site <sup>j</sup> | Off-site <sup>k</sup> | On- and off-site |
| AK                 | 1               | 440   | 0                  | 0               | 43,596            | 0                  | 440                  | 43,596                | 44,036           |
| AL                 | 46              | 14,003  | 2,594              | 0               | 311,137           | 138                | 39,354               | 288,519               | 327,873          |
| AR                 | 28              | 14,187  | 202                | 0               | 40,397            | 11,970             | 14,345               | 52,410                | 66,756           |
| AZ                 | 23              | 1,249   | 86                 | 0               | 988,345           | 5                  | 989,128              | 557                   | 989,685          |
| CA                 | 52              | 5,905   | 446                | 0               | 266,849           | 508                | 190,728              | 82,980                | 273,708          |
| CO                 | 13              | 673   | 61                 | 0               | 14,367            | 0                  | 686                  | 14,415                | 15,101           |
| CT                 | 9               | 6   | 7                  | 0               | 550               | 76                 | 6                    | 633                   | 639              |
| DE                 | 1               | 0   | 0                  | 0               | 14                | 0                  | 0                    | 14                    | 14               |
| FL                 | 28              | 1,387   | 304                | 0               | 19,193            | 10                 | 1,390                | 19,504                | 20,894           |
| GA                 | 43              | 3,256   | 2,559              | 0               | 47,464            | 10                 | 3,618                | 49,671                | 53,289           |
| HI                 | 1               | 0   | 0                  | 3               | 33                | 0                  | 3                    | 33                    | 36               |
| IA                 | 75              | 26,407  | 3,501              | 0               | 87,121            | 387,890            | 52,459               | 452,460               | 504,919          |
| ID                 | 2               | 206   | 0                  | 0               | 1,159,780         | 0                  | 1,159,986            | 0                     | 1,159,986        |
| IL                 | 113             | 16,708  | 3,288              | 723             | 725,350           | 2,914              | 17,866               | 731,117               | 748,983          |
| IN                 | 142             | 31,353  | 5,835              | 0               | 487,103           | 23,334             | 32,009               | 515,617               | 547,626          |
| KS                 | 28              | 7,838   | 290                | 0               | 1,045,331         | 159,947            | 1,013,666            | 199,740               | 1,213,406        |
| KY                 | 57              | 8,743   | 1,431              | 0               | 93,655            | 16,068             | 10,660               | 109,238               | 119,898          |
| LA                 | 35              | 11,553  | 7,316              | 0               | 64,028            | 8,095              | 17,306               | 73,686                | 90,993           |
| MA                 | 16              | 453   | 108                | 0               | 8,497             | 737                | 465                  | 9,329                 | 9,795            |
| MD                 | 12              | 148   | 57                 | 0               | 759               | 6                  | 148                  | 822                   | 970              |
| ME                 | 5               | 15  | 68                 | 0               | 81                | 420                | 20                   | 564                   | 584              |
| MI                 | 101             | 13,587  | 3,774              | 0               | 418,116           | 6,311              | 42,212               | 399,577               | 441,789          |
| MN                 | 43              | 4,752   | 184                | 0               | 86,817            | 394                | 4,757                | 87,390                | 92,148           |
| MO                 | 59              | 10,907  | 1,718              | 0               | 20,096            | 10,164             | 21,102               | 21,783                | 42,885           |
| MS                 | 30              | 4,955   | 345                | 0               | 67,256            | 0                  | 8,037                | 64,518                | 72,555           |
| MT                 | 3               | 0   | 0                  | 0               | 78,546            | 0                  | 78,546               | 0                     | 78,546           |
| NC                 | 58              | 2,225   | 140                | 0               | 30,064            | 2,830              | 2,250                | 33,009                | 35,260           |
| ND                 | 7               | 1,592   | 7                  | 0               | 531               | 0                  | 1,600                | 530                   | 2,130            |
| NE                 | 17              | 1,723   | 307                | 0               | 49,079            | 635                | 1,770                | 49,974                | 51,744           |
| NH                 | 6               | 87  | 17,300             | 0               | 6,245             | 0                  | 17,387               | 6,245                 | 23,632           |
| NJ                 | 10              | 583   | 29                 | 0               | 11,324            | 0                  | 600                  | 11,336                | 11,936           |
| NM                 | 1               | 500   | 0                  | 0               | 1,699             | 0                  | 2,199                | 0                     | 2,199            |
| NV                 | 11              | 135   | 0                  | 0               | 94,028            | 0                  | 94,163               | 0                     | 94,163           |
| NY                 | 43              | 5,555   | 8,766              | 0               | 320,476           | 1,182              | 7,932                | 328,047               | 335,979          |
| OH                 | 166             | 39,047  | 120,301            | 2               | 11,591,066        | 2,463,430          | 10,515,399           | 3,698,447             | 14,213,846       |
| OK                 | 77              | 4,384   | 325                | 0               | 62,595            | 0                  | 10,352               | 56,952                | 67,304           |

## 6. POTENTIAL FOR HUMAN EXPOSURE

**Table 6-1. Releases to the Environment from Facilities that Produce, Process, or Use Manganese<sup>a</sup>**

| State <sup>c</sup> | RF <sup>d</sup> | Reported amounts released in pounds per year <sup>b</sup> |                    |                 |                   |                    |                      |                       |                  |
|--------------------|-----------------|---|--------------------|-----------------|-------------------|--------------------|----------------------|-----------------------|------------------|
|                    |                 | Air <sup>e</sup>  | Water <sup>f</sup> | UI <sup>g</sup> | Land <sup>h</sup> | Other <sup>i</sup> | Total release        |                       |                  |
|                    |                 |   |                    |                 |                   |                    | On-site <sup>j</sup> | Off-site <sup>k</sup> | On- and off-site |
| OR                 | 14              | 349   | 0                  | 0               | 528               | 0                  | 349                  | 528                   | 877              |
| PA                 | 152             | 43,170  | 11,360             | 0               | 1,000,943         | 59,278             | 375,255              | 739,495               | 1,114,751        |
| PR                 | 4               | 2   | 0                  | 0               | 0                 | 16                 | 2                    | 16                    | 18               |
| RI                 | 2               | 0   | 0                  | 0               | 0                 | 0                  | 0                    | 0                     | 0                |
| SC                 | 48              | 6,328   | 536                | 0               | 85,146            | 29,788             | 46,481               | 75,318                | 121,799          |
| SD                 | 19              | 8,727   | 5                  | 0               | 26,330            | 0                  | 16,460               | 18,602                | 35,062           |
| TN                 | 62              | 49,422  | 1,924              | 0               | 348,780           | 3,943              | 99,022               | 305,047               | 404,069          |
| TX                 | 121             | 53,231  | 22,104             | 5               | 171,602           | 624                | 155,306              | 92,260                | 247,566          |
| UT                 | 17              | 2,559   | 13                 | 0               | 747,419           | 0                  | 738,680              | 11,311                | 749,992          |
| VA                 | 29              | 2,033   | 608                | 0               | 161,608           | 22,211             | 2,356                | 184,105               | 186,461          |
| WA                 | 26              | 5,729   | 42,723             | 0               | 139,920           | 539                | 51,480               | 137,431               | 188,911          |
| WI                 | 171             | 20,115  | 8,948              | 0               | 2,137,917         | 12,870             | 58,935               | 2,120,915             | 2,179,850        |
| WV                 | 8               | 26  | 1                  | 0               | 38,324            | 14                 | 24,026               | 14,338                | 38,364           |
| WY                 | 5               | 193   | 0                  | 0               | 71,139            | 5                  | 71,332               | 5                     | 71,337           |
| Total              | 2,040           | 426,449   | 269,573            | 733             | 23,171,244        | 3,226,362          | 15,992,276           | 11,102,084            | 27,094,361       |

<sup>a</sup>The TRI data should be used with caution since only certain types of facilities are required to report. This is not an exhaustive list. Data are rounded to nearest whole number.

<sup>b</sup>Data in TRI are maximum amounts released by each facility.

<sup>c</sup>Post office state abbreviations are used.

<sup>d</sup>Number of reporting facilities.

<sup>e</sup>The sum of fugitive and point source releases are included in releases to air by a given facility.

<sup>f</sup>Surface water discharges, waste water treatment-(metals only), and publicly owned treatment works (POTWs) (metal and metal compounds).

<sup>g</sup>Class I wells, Class II-V wells, and underground injection.

<sup>h</sup>Resource Conservation and Recovery Act (RCRA) subtitle C landfills; other on-site landfills, land treatment, surface impoundments, other land disposal, other landfills.

<sup>i</sup>Storage only, solidification/stabilization (metals only), other off-site management, transfers to waste broker for disposal, unknown

<sup>j</sup>The sum of all releases of the chemical to air, land, water, and underground injection wells.

<sup>k</sup>Total amount of chemical transferred off-site, including to POTWs.

RF = reporting facilities; UI = underground injection

Source: TRI06 2008 (Data are from 2006)

## 6. POTENTIAL FOR HUMAN EXPOSURE

**Table 6-2. Releases to the Environment from Facilities that Produce, Process, or Use Manganese Compounds<sup>a</sup>**

| State <sup>c</sup> | RF <sup>d</sup> | Reported amounts released in pounds per year <sup>b</sup> |                    |                 |                   |                    |                      |                       |                  |
|--------------------|-----------------|---|--------------------|-----------------|-------------------|--------------------|----------------------|-----------------------|------------------|
|                    |                 | Air <sup>e</sup>  | Water <sup>f</sup> | UI <sup>g</sup> | Land <sup>h</sup> | Other <sup>i</sup> | Total release        |                       | On- and off-site |
|                    |                 |   |                    |                 |                   |                    | On-site <sup>j</sup> | Off-site <sup>k</sup> |                  |
| AK                 | 5               | 25,328  | 750                | 0               | 845,025           | 6,280              | 871,103              | 6,280                 | 877,383          |
| AL                 | 68              | 178,265   | 875,746            | 0               | 5,663,753         | 2,104,302          | 5,163,681            | 3,658,386             | 8,822,066        |
| AR                 | 50              | 19,489  | 441,421            | 0               | 1,480,122         | 989,320            | 1,844,948            | 1,085,404             | 2,930,352        |
| AZ                 | 14              | 4,047   | 410,010            | 0               | 1,971,519         | 28,019             | 2,113,096            | 300,499               | 2,413,595        |
| CA                 | 37              | 7,828   | 1,059              | 0               | 200,104           | 193                | 124,029              | 85,154                | 209,183          |
| CO                 | 24              | 5,126   | 11,022             | 0               | 2,246,268         | 9,100              | 714,772              | 1,556,744             | 2,271,516        |
| CT                 | 10              | 4,362   | 1,883              | 0               | 60,665            | 7,840              | 5,865                | 68,885                | 74,750           |
| DC                 | 3               | 0   | 4,347              | 0               | 6,000             | 0                  | 10,347               | 0                     | 10,347           |
| DE                 | 11              | 4,334   | 39,657             | 0               | 4,092,502         | 28,305             | 116,524              | 4,048,274             | 4,164,798        |
| FL                 | 37              | 18,745  | 202,776            | 0               | 3,397,056         | 33,456             | 3,360,138            | 291,895               | 3,652,032        |
| GA                 | 61              | 47,377  | 773,805            | 0               | 2,836,912         | 7,944              | 3,330,409            | 335,629               | 3,666,038        |
| HI                 | 1               | 38  | 0                  | 0               | 26,872            | 0                  | 38                   | 26,872                | 26,910           |
| IA                 | 42              | 41,786  | 22,496             | 0               | 840,340           | 364,964            | 227,129              | 1,042,457             | 1,269,586        |
| ID                 | 12              | 841   | 190,590            | 0               | 14,737,870        | 130                | 14,679,285           | 250,146               | 14,929,431       |
| IL                 | 84              | 96,010  | 35,152             | 0               | 9,033,549         | 259,391            | 5,687,449            | 3,736,654             | 9,424,103        |
| IN                 | 79              | 192,010   | 93,426             | 1,900           | 18,418,915        | 1,671,366          | 7,130,422            | 13,247,195            | 20,377,618       |
| KS                 | 28              | 13,257  | 652                | 250             | 244,236           | 250                | 220,445              | 38,200                | 258,645          |
| KY                 | 47              | 68,576  | 147,644            | 0               | 1,528,078         | 119,954            | 1,660,270            | 203,982               | 1,864,252        |
| LA                 | 29              | 20,544  | 387,475            | 0               | 6,371,936         | 1,408              | 6,476,794            | 304,569               | 6,781,363        |
| MA                 | 17              | 1,436   | 1,331              | 0               | 100,634           | 32,790             | 61,732               | 74,459                | 136,191          |
| MD                 | 26              | 21,618  | 90,703             | 25,571          | 2,166,200         | 125,137            | 2,233,047            | 196,182               | 2,429,229        |
| ME                 | 10              | 2,117   | 331,758            | 0               | 677,049           | 18,587             | 792,798              | 236,713               | 1,029,511        |
| MI                 | 67              | 81,060  | 99,058             | 2,000           | 2,612,249         | 43,241             | 1,138,887            | 1,698,721             | 2,837,608        |
| MN                 | 31              | 14,598  | 256,905            | 0               | 1,587,019         | 23,337             | 1,591,056            | 290,802               | 1,881,858        |
| MO                 | 46              | 13,796  | 51,704             | 0               | 708,194           | 3,865              | 418,616              | 358,943               | 777,558          |
| MS                 | 33              | 15,064  | 288,780            | 8,506,700       | 9,204,141         | 6,158              | 17,937,765           | 83,078                | 18,020,843       |
| MT                 | 9               | 9,747   | 29,912             | 0               | 1,981,375         | 46,473             | 1,849,854            | 217,652               | 2,067,506        |
| NC                 | 63              | 19,836  | 213,027            | 0               | 2,011,149         | 1,177,640          | 1,796,233            | 1,625,420             | 3,421,652        |
| ND                 | 9               | 15,474  | 16,333             | 0               | 2,480,954         | 15,612             | 1,479,091            | 1,049,282             | 2,528,373        |
| NE                 | 22              | 21,131  | 500                | 0               | 153,009           | 612,303            | 161,275              | 625,668               | 786,943          |
| NH                 | 1               | 134   | 0                  | 0               | 4,770             | 0                  | 4,034                | 870                   | 4,904            |
| NJ                 | 15              | 3,032   | 10,005             | 0               | 472,763           | 13,484             | 31,191               | 468,093               | 499,284          |
| NM                 | 6               | 3,916   | 1,300              | 0               | 828,935           | 0                  | 834,151              | 0                     | 834,151          |
| NV                 | 10              | 12,998  | 3,611              | 0               | 10,169,735        | 0                  | 9,260,544            | 925,800               | 10,186,344       |
| NY                 | 26              | 4,650   | 81,183             | 0               | 584,743           | 26,423             | 261,995              | 435,004               | 697,000          |
| OH                 | 138             | 430,169   | 642,313            | 30,514          | 11,063,512        | 597,498            | 6,580,637            | 6,183,369             | 12,764,006       |
| OK                 | 32              | 11,618  | 48,634             | 0               | 750,631           | 508,644            | 531,270              | 788,257               | 1,319,527        |

## 6. POTENTIAL FOR HUMAN EXPOSURE

**Table 6-2. Releases to the Environment from Facilities that Produce, Process, or Use Manganese Compounds<sup>a</sup>**

| State <sup>c</sup> | RF <sup>d</sup> | Air <sup>e</sup> | Water <sup>f</sup> | UI <sup>g</sup>  | Land <sup>h</sup>  | Other <sup>i</sup> | Reported amounts released in pounds per year <sup>b</sup> |                       |                    |
|--------------------|-----------------|------------------|--------------------|------------------|--------------------|--------------------|---|-----------------------|--------------------|
|                    |                 |                  |                    |                  |                    |                    | Total release   |                       | On- and off-site   |
|                    |                 |                  |                    |                  |                    |                    | On-site <sup>j</sup>                                      | Off-site <sup>k</sup> |                    |
| OR                 | 23              | 8,314            | 144,618            | 0                | 2,142,046          | 323,198            | 2,004,367   | 613,809               | 2,618,176          |
| PA                 | 134             | 72,526           | 184,992            | 0                | 10,063,261         | 340,932            | 5,031,291   | 5,630,420             | 10,661,710         |
| PR                 | 6               | 8,490            | 401                | 0                | 282                | 0                  | 8,886   | 287                   | 9,173              |
| RI                 | 1               | 103              | 31                 | 0                | 169                | 0                  | 134   | 169                   | 303                |
| SC                 | 44              | 27,819           | 378,152            | 0                | 6,760,363          | 6,148              | 2,292,815   | 4,879,668             | 7,172,483          |
| SD                 | 7               | 38               | 0                  | 0                | 27,700             | 0                  | 22,038  | 5,700                 | 27,738             |
| TN                 | 53              | 50,882           | 293,774            | 0                | 16,727,879         | 38,873             | 16,041,491  | 1,069,917             | 17,111,408         |
| TX                 | 104             | 66,756           | 185,907            | 0                | 6,283,703          | 94,244             | 6,150,141   | 480,469               | 6,630,610          |
| UT                 | 20              | 6,687            | 761                | 0                | 1,271,573          | 13                 | 1,264,871   | 14,163                | 1,279,034          |
| VA                 | 35              | 19,359           | 183,002            | 0                | 1,522,896          | 4,563              | 729,421   | 1,000,399             | 1,729,820          |
| VT                 | 1               | 0                | 0                  | 0                | 0                  | 0                  | 0   | 0                     | 0                  |
| WA                 | 25              | 3,227            | 187,304            | 0                | 814,927            | 16,167             | 808,095   | 213,530               | 1,021,626          |
| WI                 | 60              | 23,609           | 116,184            | 0                | 2,533,313          | 95,152             | 364,876   | 2,403,382             | 2,768,258          |
| WV                 | 26              | 133,302          | 13,412             | 0                | 1,700,100          | 24,034             | 1,325,047   | 545,801               | 1,870,848          |
| WY                 | 6               | 8,493            | 1,327              | 0                | 647,297            | 0                  | 617,518   | 39,599                | 657,117            |
| <b>Total</b>       | <b>1,748</b>    | <b>1,859,959</b> | <b>7,496,834</b>   | <b>8,566,935</b> | <b>172,054,292</b> | <b>9,826,740</b>   | <b>137,361,909</b>  | <b>62,442,851</b>     | <b>199,804,760</b> |

<sup>a</sup>The TRI data should be used with caution since only certain types of facilities are required to report. This is not an exhaustive list. Data are rounded to nearest whole number.

<sup>b</sup>Data in TRI are maximum amounts released by each facility.

<sup>c</sup>Post office state abbreviations are used.

<sup>d</sup>Number of reporting facilities.

<sup>e</sup>The sum of fugitive and point source releases are included in releases to air by a given facility.

<sup>f</sup>Surface water discharges, waste water treatment-(metals only), and publicly owned treatment works (POTWs) (metal and metal compounds).

<sup>g</sup>Class I wells, Class II-V wells, and underground injection.

<sup>h</sup>Resource Conservation and Recovery Act (RCRA) subtitle C landfills; other on-site landfills, land treatment, surface impoundments, other land disposal, other landfills.

<sup>i</sup>Storage only, solidification/stabilization (metals only), other off-site management, transfers to waste broker for disposal, unknown

<sup>j</sup>The sum of all releases of the chemical to air, land, water, and underground injection wells.

<sup>k</sup>Total amount of chemical transferred off-site, including to POTWs.

RF = reporting facilities; UI = underground injection

Source: TRI06 2008 (Data are from 2006)

## 6. POTENTIAL FOR HUMAN EXPOSURE

certain types of facilities are required to report. This is not an exhaustive list. Also, because these data reflect past releases, they may not be representative of current releases at these facilities.

Manganese may also be emitted to the environment through the use of gasoline that contains MMT; however, no data on the amount of MMT that is currently being used in gasoline in the United States were located. No data for releases of mangafodipir to the environment were found. Because mangafodipir is a compound used exclusively in a clinical environment, it is not expected to be released to the environment and will not be discussed in subsequent sections concerning fate and transport.

**6.2.1 Air**

Estimated releases of 426,449 pounds (193 metric tons) of manganese to the atmosphere from 2,040 domestic manufacturing and processing facilities in 2006, accounted for about 1.6% of the estimated total environmental releases from facilities required to report to the TRI (TRI06 2008).

Estimated releases of 1,859,959 pounds (844 metric tons) of manganese compounds to the atmosphere from 1,748 domestic manufacturing and processing facilities in 2006, accounted for about 1% of the estimated total environmental releases from facilities required to report to the TRI (TRI06 2008). These releases are summarized in Tables 6-1 and 6-2.

According to data from the National Pollutant Release Inventory (NPRI) maintained by Environment Canada, approximately 273.9 metric tons of manganese were released to air in Canada in 2003 from various industrial sources (Health Canada 2008). The major industrial sources for manganese emissions in Canada were attributed to an iron-ore mine located in Labrador, iron- and steel-related industries, pulp/paper/newsprint mills, fossil fuel electric power generation, and the manufacturing of heating and commercial refrigeration equipment.

Manganese has been identified in air samples collected at 31 of the 869 NPL hazardous waste sites where it was detected in some environmental media (HazDat 2008).

The main sources of manganese release to the air are industrial emissions, combustion of fossil fuels, and reentrainment of manganese-containing soils (EPA 1983c, 1984, 1985c, 1985d, 1987a; Liroy 1983). The principal sources of industrial emissions are ferroalloy production and iron and steel foundries, and the principal sources of combustion emissions are power plants and coke ovens (EPA 1983c, 1985c, 1985d). Atmospheric emissions of manganese and other trace metals from these industrial sources have declined



## 6. POTENTIAL FOR HUMAN EXPOSURE

over the last 2 decades due to the use of advanced pollution control devices and increased government regulations regarding these emissions (EPA 1984, 1985d).

Windblown erosion of dusts and soils is also an important atmospheric source of manganese. Wallace and Slonecker (1997) estimated that the background contribution of windblown soil to fine particulate atmospheric manganese levels was 1–2 ng/m<sup>3</sup> in the United States and Canada. Volcanic eruptions may also release manganese to the atmosphere (Schroeder et al. 1987).

MMT is a manganese-containing compound used to enhance the octane rating in gasoline. MMT was used as an additive in leaded gasoline until the phase-out of leaded gas in the United States in 1995. It was also used in unleaded gasoline for a short period of time in the late 1970's, but was banned as an additive in unleaded gasoline by EPA in 1977 (EPA 1978, 1979a, 1981). In 1995, the ban on MMT use in unleaded gasoline was lifted, and a court decision ordered EPA to register the product for use as a fuel additive, although testing for health effects continues (EPA 1995a). Analysis of manganese levels in the air indicates that vehicular emissions from MMT containing fuels contributed an average of 13 ng manganese/m<sup>3</sup> in southern California, while vehicular emissions were only responsible for about 3 ng/m<sup>3</sup> in central and northern California (Davis et al. 1988). A survey of ambient air concentrations of fine (PM<sub>2.5</sub>) manganese in rural sites in U.S. national parks and in urban sites in California indicated that from 1988 to 1993, ambient concentrations of manganese ranged from 1 ng/m<sup>3</sup> in rural sites to 3 ng/m<sup>3</sup> in urban sites (Wallace and Slonecker 1997). Part of the increase in fine manganese during this period was considered to be the result of the use of MMT in leaded gasoline. It was estimated that automobile emissions from leaded gasoline were responsible for 37% of the fine manganese levels in California in 1992. In 1994, automobile emissions were estimated to contribute 12% of the fine manganese levels in the atmosphere, as the use of leaded gasoline declined. It has been estimated that if MMT were used in all gasoline, urban air manganese levels would be increased by about 50 ng/m<sup>3</sup> (Cooper 1984; Ter Haar et al. 1975). Other authors have estimated that the increase in atmospheric manganese levels would be <20 ng/m<sup>3</sup> (Lynam et al. 1994).

In Canada, where the use of MMT containing gasoline has been extensive, a 10% per year increase in manganese emission rates from MMT in gasoline since 1981 was estimated (Loranger and Zayed 1994). A positive correlation between atmospheric manganese concentration and traffic density has been observed (Loranger and Zayed 1997a; Loranger et al. 1994a). The principal emission product of MMT combustion is a fine particulate matter (0.1–0.4 µm diameter) consisting of manganese oxide (Egyed and Wood 1996; Ter Haar et al. 1975), manganese phosphate, and some manganese sulfate (Lynam et al.

## 6. POTENTIAL FOR HUMAN EXPOSURE

1999). The finding of soluble manganese (<0.4 µm) in snow samples obtained close to a highway in Montreal, Canada suggested a possible contamination from mobile sources (Loranger and Zayed 1997a; Loranger et al. 1995). However, it has been difficult to assess the exact contribution of mobile sources to overall contamination from natural and industrial sources because of the physico-chemical characteristics of manganese particulate, environmental factors affecting its dispersion, and the difficulties in distinguishing between mobile sources of manganese and background manganese levels (Loranger and Zayed 1997a; Veysseyre et al. 1998).

Despite the estimated 10% per year increase in manganese emission rates from the use of MMT in gasoline in Canada, atmospheric manganese concentrations in Montreal have remained fairly constant between 1981 and 1990, and have decreased markedly in 1991 and 1992 (Loranger and Zayed 1994). The decline in manganese concentration after 1990 may have been due to a shutdown in 1991 of a ferromanganese plant located near Montreal. Air concentrations are in general below the EPA reference concentration (RfC) of 0.05 µg/m<sup>3</sup> for respirable manganese. However, in 1998, it was observed that some atmospheric concentrations in specific microenvironments with important traffic density were higher than the RfC (Zayed et al. 1999a).

### 6.2.2 Water

Estimated releases of 269,573 pounds (122 metric tons) of manganese to water from 2,040 domestic manufacturing and processing facilities in 2006, accounted for about 1% of the estimated total environmental releases from facilities required to report to the TRI (TRI06 2008). Estimated releases of 7,496,834 pounds (3,401 metric tons) of manganese compounds to water from 1,748 domestic manufacturing and processing facilities in 2006, accounted for about 4% of the estimated total environmental releases from facilities required to report to the TRI (TRI06 2008). These releases are summarized in Tables 6-1 and 6-2.

Manganese has been identified in surface water and groundwater samples collected at 392 and 692, respectively, of the 869 NPL hazardous waste sites where it was detected in some environmental media (HazDat 2008).

Based on comparison to typical background levels of manganese in surface water or groundwater (see Section 6.4.2), it seems likely that some waste sites where manganese is detected contain only natural levels. Although ambient manganese levels are about 200 µg/L in a number of cases, high levels (in

## 6. POTENTIAL FOR HUMAN EXPOSURE

excess of 1,000 µg/L) have been detected indicating that manganese wastes may lead to significant contamination of water at some sites. For example, at one site in Ohio where "heavy metals" had been disposed, manganese concentrations up to 1,900 µg/L were found in on-site wells (Cooper and Istok 1988). Levels in water at two NPL sites in Missouri ranged from 0.009 to 3.7 µg/L (MDNR 1990). No information is available on the method used to determine these values, so it is not clear whether the data refer to total or dissolved manganese.

**6.2.3 Soil**

Estimated releases of 23,171,244 pounds (10,510 metric tons) of manganese to soil from 2,040 domestic manufacturing and processing facilities in 2006, accounted for about 86% of the estimated total environmental releases from facilities required to report to the TRI (TRI06 2008). Estimated releases of 172,054,292 pounds (78,043 metric tons) of manganese compounds to the soil from 1,748 domestic manufacturing and processing facilities in 2006, accounted for about 86% of the estimated total environmental releases from facilities required to report to the TRI (TRI06 2008). An additional 8,566,935 pounds (3,886 metric tons) were injected underground. These releases are summarized in Tables 6-1 and 6-2.

Manganese deposition to soils from the use of MMT in gasoline was estimated for two sites in Toronto, Canada (Bhuie et al. 2005). Accounting for variables such as annual average daily traffic (AADT) density, fuel consumption, distance traveled by automobiles, and a manganese content of 10 mg/L of gasoline, the annual average manganese contribution to soils from MMT emissions were calculated as 5.73 and 2.47 mg/kg at two sites (Bhuie et al. 2005). These concentrations were considered insignificant when compared to natural background manganese levels (541 and 557 mg/kg ) in soil for these areas.

Manganese has been identified in soil and sediment, samples collected at 355 and 257, respectively, of the 869 NPL hazardous waste sites where it was detected in some environmental media (HazDat 2008).

**6.3 ENVIRONMENTAL FATE****6.3.1 Transport and Partitioning**

Manganese compounds have negligible vapor pressures (see Table 4-2), but may exist in air as suspended particulate matter derived from industrial emissions or the erosion of soils. Manganese-containing particles are mainly removed from the atmosphere by gravitational settling, with large particles tending to

## 6. POTENTIAL FOR HUMAN EXPOSURE

fall out faster than small particles (EPA 1984). The half-life of airborne particles is usually on the order of days, depending on the size of the particle and atmospheric conditions (Nriagu 1979). Some removal by washout mechanisms such as rain may also occur, although it is of minor significance in comparison to dry deposition (EPA 1984; Turner et al. 1985).

In a study completed by Evans (1989), there were two mechanisms involved in explaining the retention of manganese and other metals in the environment by soil. First, through cation exchange reactions, manganese ions and the charged surface of soil particles form manganese oxides, hydroxides, and oxyhydroxides, which in turn form absorption sites for other metals. Secondly, manganese can be adsorbed to other oxides, hydroxides, and oxyhydroxides through ligand exchange reactions. When the soil solution becomes saturated, these manganese oxides, hydroxides, and oxyhydroxides can precipitate into a new mineral phase and act as a new surface to which other substances can absorb (Evans 1989).

The behavior of heavy metals in the combustion gases of urban waste incinerators was studied by Fernandez et al. (1992). Manganese was detected inside gaseous fly ash particles in the form of oxides and chlorides. When these soluble oxides and chlorides reach environmental media, they can leach out and become mobile (Fernandez et al. 1992).

The transport of manganese in air is largely determined by its particle size. About 80% of the manganese in suspended particulate matter is associated with particles having a mass median aerodynamic diameter (MMAD) of  $<5 \mu\text{m}$  (WHO 1981). The compound's small particle size (approximately 80% with a MMAD  $<5 \mu\text{m}$  and approximately 50% with an MMAD  $<2 \mu\text{m}$ ) favors widespread airborne distribution and is within the respirable range (WHO 1981).

The transport and partitioning of manganese in water is controlled by the solubility of the specific chemical form present, which in turn is determined by pH, Eh (oxidation-reduction potential), and the characteristics of the available anions. The metal may exist in water in any of four oxidation states; however, Mn(II) predominates in most waters (pH 4–7), but may become oxidized under alkaline conditions at pH  $>8$  (EPA 1984). The principal anion associated with Mn(II) in water is usually carbonate ( $\text{CO}_3^{-2}$ ), and the concentration of manganese is limited by the relatively low solubility (65 mg/L) of manganese carbonate (Schaanning et al. 1988). Under oxidizing conditions, the solubility of Mn(II) may be controlled by manganese oxide equilibria (Ponnamperuma et al. 1969), with manganese being converted to the Mn(II) or Mn(IV) oxidation states (Rai et al. 1986). In extremely reduced water, the fate of manganese tends to be controlled by formation of a poorly soluble sulfide (EPA 1984).

## 6. POTENTIAL FOR HUMAN EXPOSURE

Manganese is often transported in rivers as suspended sediments. It has been reported that most of the manganese in a South American river came from industrial sources and was bound to suspended particles in the water (Malm et al. 1988).

In an aquifer studied in France, manganese was shown to originate from within the aquifer itself (Jaudon et al. 1989). In the presence of decreased dissolved oxygen in the groundwater, Mn(IV) has been shown to be reduced both chemically and bacterially into the Mn(II) form (Jaudon et al. 1989). This oxidation state is water soluble and easily released into the groundwater.

Manganese in water may be significantly bioconcentrated at lower trophic levels. A bioconcentration factor (BCF) relates the concentration of a chemical in plant and animal tissues to the concentration of the chemical in the water in which they live. Folsom et al. (1963) estimated that the BCFs of manganese were 2,500–6,300 for phytoplankton, 300–5,500 for marine algae, 800–830 for intertidal mussels, and 35–930 for coastal fish. Similarly, Thompson et al. (1972) estimated that the BCFs of manganese were 10,000–20,000 for marine and freshwater plants, 10,000–40,000 for invertebrates, and 100–600 for fish. In general, these data indicate that lower organisms such as algae have larger BCFs than higher organisms. In order to protect consumers from the risk of manganese bioaccumulation in marine mollusks, EPA has set a criterion for manganese at 0.1 mg/L for marine waters (EPA 1993b).

The tendency of soluble manganese compounds to adsorb to soils and is dependent upon the cation exchange capacity and the organic composition of the soil (Curtin et al. 1980; Hemstock and Low 1953; Kabata-Pendias and Pendias 1984; McBride 1979; Schnitzer 1969). Baes and Sharp (1983) noted that soil adsorption constants (the ratio of the concentration in soil to the concentration in water) for Mn(II) span five orders of magnitude, ranging from 0.2 to 10,000 mL/g, increasing as a function of the organic content and the ion exchange capacity of the soil; thus, adsorption may be highly variable. In some cases, adsorption of manganese to soils may not be a readily reversible process. At low concentrations, manganese may be "fixed" by clays and will not be released into solution readily (Reddy and Perkins 1976). At higher concentrations, manganese may be desorbed by ion exchange mechanisms with other ions in solution (Rai et al. 1986). For example, the discharge of waste water effluent into estuarine environments resulted in the mobilization of manganese from the bottom sediments (Helz et al. 1975; Paulson et al. 1984). The metals in the effluent may have been preferentially adsorbed resulting in the release of manganese.

## 6. POTENTIAL FOR HUMAN EXPOSURE

**6.3.2 Transformation and Degradation****6.3.2.1 Air**

Very little information is available on atmospheric reactions of manganese (EPA 1984). Manganese can react with sulfur dioxide and nitrogen dioxide, but the occurrence of such reactions in the atmosphere has not been demonstrated.

MMT undergoes photolysis rapidly by sunlight in the atmosphere or in aqueous solutions with a very short half-life (i.e., <2 minutes) (Ter Haar et al. 1975; Garrison et al. 1995). The photodegradation products tentatively identified in aqueous photolysis experiments were methylcyclopentadiene, cyclopentadiene, carbon monoxide, manganese carbonyl, and trimanganese tetroxide (Garrison et al. 1995). Undegraded MMT is not likely to be released directly to the atmosphere in significant quantities from its intended use as a gasoline additive. Spectroscopic studies of the tailpipe emissions of MMT-containing gasoline indicated that the manganese in MMT is converted to a mixture of solid manganese oxides, sulfates, and phosphates. The manganese containing particulates were determined to be  $Mn_3O_4$ ,  $MnSO_4 \cdot H_2O$  and a divalent manganese phosphate,  $Mn_5(PO_4)[PO_3(OH)]_2 \cdot 4H_2O$  (Mölders et al. 2001; Ressler et al. 2000).

**6.3.2.2 Water**

Manganese in water may undergo oxidation at high pH or Eh (see Section 6.3.1) and is also subject to microbial activity. For example, Mn(II) in a lake was oxidized during the summer months, but this was inhibited by a microbial poison, indicating that the oxidation was mediated by bacteria (Johnston and Kipphut 1988). The microbial metabolism of manganese is presumed to be a function of pH, temperature, and other factors, but no data were located on this.

The rate of MMT degradation in natural aquifer and sediment systems was determined to be very slow under anaerobic conditions (Garrison et al. 1995). Calculated half-lives ranged from approximately 0.2 to 1.5 years at 25 °C. However, MMT photolyzed rapidly in purified, distilled water exposed to sunlight. The disappearance of MMT followed first-order kinetics, with a calculated half-life of 0.93 minutes. Reaction products included methylcyclopentadiene, cyclopentadiene, carbon monoxide, and a manganese carbonyl that readily oxidized to trimanganese tetroxide.

## 6. POTENTIAL FOR HUMAN EXPOSURE

**6.3.2.3 Sediment and Soil**

The oxidation state of manganese in soils and sediments may be altered by microbial activity. Geering et al. (1969) observed that Mn(II) in suspensions of silt or clay loams from several areas of the United States was oxidized by microorganisms, leading to the precipitation of manganese minerals. Other studies (Francis 1985) have shown that bacteria and microflora can increase the mobility of manganese in coal-waste solids by increasing dissolution of manganese in subsurface environments.

MMT was found to be stable in a stream bottom sediment under anaerobic conditions. Photodegradation of MMT is not likely to occur in sediments, and it may equilibrate between the sediment, sediment porewater, and water column manganese (Garrison et al. 1995).

**6.4 LEVELS MONITORED OR ESTIMATED IN THE ENVIRONMENT**

Reliable evaluation of the potential for human exposure to manganese depends in part on the reliability of supporting analytical data from environmental samples and biological specimens. Concentrations of manganese in unpolluted atmospheres and in pristine surface waters are often so low as to be near the limits of current analytical methods. In reviewing data on manganese levels monitored or estimated in the environment, it should also be noted that the amount of chemical identified analytically is not necessarily equivalent to the amount that is bioavailable. The analytical methods available for monitoring manganese in a variety of environmental media are detailed in Chapter 7.

**6.4.1 Air**

Table 6-3 summarizes historic manganese air level data collected over a period of nearly 30 years from numerous urban, nonurban, and source-dominated areas of the United States. Direct comparisons of data from different time periods are complicated because of changes in sample collection and analytical methodology. However, it is clear that manganese levels tend to be higher in source-dominated and urban areas than in nonurban areas. These data also indicate that concentrations in all areas have tended to decrease over the past three decades (EPA 1984; Kleinman et al. 1980). This decrease came as the result of the installation of emission controls in the metals industry (EPA 1984, 1985d). A concurrent decrease in total suspended particulates (TSP) was observed in most areas. Ambient air levels of manganese (PM<sub>10</sub> and PM<sub>2.5</sub>) in Canadian locations monitored from the late 1980s through the early 2000s were reported to have a 13–77% reduction over that time period (Health Canada 2008). Annual averages of manganese in urban and rural areas without significant manganese pollution are in the range of 10–70 ng/m<sup>3</sup> (0.01–

## 6. POTENTIAL FOR HUMAN EXPOSURE

**Table 6-3. Average Levels of Manganese in Ambient Air<sup>a</sup>**

| Sampling location | Concentration (ng/m <sup>3</sup> ) |           |         |
|-------------------|------------------------------------|-----------|---------|
|                   | 1953–1957                          | 1965–1967 | 1982    |
| Nonurban          | 60                                 | 12        | 5       |
| Urban             | 110                                | 73        | 33      |
| Source dominated  | No data                            | 250–8,300 | 130–140 |

<sup>a</sup>Adapted from EPA 1984



## 6. POTENTIAL FOR HUMAN EXPOSURE

0.07  $\mu\text{g}/\text{m}^3$ ) (WHO 1997). The daily intake of manganese in the air by the general population in areas without manganese emitting industries was estimated to be  $<2$   $\mu\text{g}/\text{day}$  (WHO 1981). In areas with major foundry facilities, intake may rise to 4–6  $\mu\text{g}/\text{day}$ , and in areas associated with ferro- or silicomanganese industries, it may be as high as 10  $\mu\text{g}$ , with 24-hour peak values exceeding 200  $\mu\text{g}/\text{day}$  (WHO 1981). Data compiled for 2006 under the EPA Urban Air Toxics Monitoring Program, studied ambient air levels of manganese and several other metals at 20 urban locations across the United States. Manganese ( $\text{PM}_{10}$ ) was detected in 415 samples of urban air at levels ranging from 0.24 to 89.10  $\text{ng}/\text{m}^3$  (EPA 2007b). The arithmetic mean, geometric mean, and median concentrations were 10.13, 6.68, and 6.29  $\text{ng}/\text{m}^3$ , respectively. Manganese levels ranged from 0.85 to 614.00  $\text{ng}/\text{m}^3$  in 114 samples of total suspended particulates (TSP) at these 20 urban locations. The arithmetic mean, geometric mean, and median concentrations of manganese in TSP were 47.89, 22.39, and 23.98  $\text{ng}/\text{m}^3$ , respectively.

During 1988–1993, ambient concentration of fine ( $\text{PM}_{2.5}$ ) manganese ranged from 1  $\text{ng}/\text{m}^3$  (0.001  $\mu\text{g}/\text{m}^3$ ) in rural sites in U.S. National Parks to 3  $\text{ng}/\text{m}^3$  (0.003  $\mu\text{g}/\text{m}^3$ ) in urban sites in California (Wallace and Slonecker 1997). There is concern in Canada regarding the combustion of MMT as an important source of manganese contamination in the urban environment, especially in areas of high traffic density. For instance, Loranger and Zayed (1997a) reported significantly higher levels of both respirable and total manganese levels at a high traffic density site (24 and 50  $\text{ng}/\text{m}^3$ , respectively) in Montreal in contrast to a low traffic density site (15 and 27  $\text{ng}/\text{m}^3$ , respectively). Temporal variation of respirable and total manganese was similar for both sites, and atmospheric manganese concentrations reflected a positive relationship with the traffic density. However, as discussed in Section 6.2.1, it has been difficult to assess the exact contribution of the combustion of MMT by vehicles to manganese levels in the environment.

In Montreal, Canada, ambient atmospheric concentrations of MMT, and respirable and total manganese, were measured in five microenvironments including a gas station, an underground car park, downtown Montreal, near an expressway, and near an oil refinery (Zayed et al. 1999a). The overall mean concentrations of respirable manganese, total manganese, and MMT measured for all the microenvironments were 36, 103, and 5  $\text{ng}/\text{m}^3$ , respectively (0.036, 0.103, and 0.005  $\mu\text{g}/\text{m}^3$ ); however, the mean respirable manganese concentration 53  $\text{ng}/\text{m}^3$  (0.053  $\mu\text{g}/\text{m}^3$ ) near the expressway was greater than the EPA Reference Concentration (RfC) of 0.05  $\mu\text{g}/\text{m}^3$ .

The Canadian National Air Pollution Surveillance (NAPS) Program reported that average fine ( $\text{PM}_{2.5}$ ) manganese levels from 2003 to 2005 in cities with industrial sources (Windsor and Hamilton) were 9–15  $\text{ng}/\text{m}^3$  (Health Canada 2008). In Vancouver, Winnipeg, Montreal, Quebec, Toronto, and Edmonton,

## 6. POTENTIAL FOR HUMAN EXPOSURE

the average levels were 4–14 ng/m<sup>3</sup>. In Saskatoon, Ottawa, Victoria, St. John, and background sites, levels were <5 ng/m<sup>3</sup>. NAPS also reported manganese PM<sub>10</sub> levels were: 20–60 ng/m<sup>3</sup> in Hamilton and Windsor; 8–25 ng/m<sup>3</sup> in Montreal, Toronto, Edmonton, Winnipeg, Quebec, Calgary, Vancouver, and Victoria; and generally <10 ng/m<sup>3</sup> in Saskatoon, Ottawa, St. John, Yellowknife, and background sites (Health Canada 2008).

Studies were conducted in Indianapolis, Indiana and Toronto, Canada to assess levels of PM<sub>2.5</sub> and PM<sub>10</sub> manganese in indoor, outdoor, and personal air samples (Pellizzari et al. 1999, 2001). The levels observed in Toronto, where MMT had been used in gasoline for over 20 years, were approximately 2 times greater in indoor and outdoor air than in Indianapolis, where MMT was not being used as a gasoline additive. The monitoring data from these studies are summarized in Table 6-4.

#### 6.4.2 Water

Many factors, both environmental (e.g., the presence of high or low levels of other inorganics in drinking water) and biological or host-related (e.g., age, nutritional status, and alcohol consumption) can significantly influence the uptake of manganese by an individual (EPA 1993b). The determination of a single concentration of manganese in drinking water, then, must be recognized as a process that is limited in its ability to reflect the variable nature of manganese toxicity (EPA 1993b).

Concentrations of manganese in surface water are usually reported as dissolved manganese. Although total manganese may be a better indicator, since manganese adsorbed to suspended solids may exceed dissolved manganese in many systems, the bioavailability of manganese in this form has not been established (EPA 1984; NAS 1977). In a 1962–1967 survey of U.S. surface waters, dissolved manganese was detected in 51% of 1,577 samples, at a mean concentration of 59 µg/L. Individual values ranged from 0.3 to 3,230 µg/L. Mean concentrations for 15 different drainage basins in the United States ranged from 2.3 µg/L in the western Great Lakes to 232 µg/L in the Ohio River drainage basin (Kopp and Kroner 1967). A later (1974–1981) survey of U.S. river waters reported a median dissolved manganese concentration of 24 µg/L in samples from 286 locations, with values ranging from <11 µg/L (25th percentile) to >51 µg/L (75th percentile) (Smith et al. 1987). Analyzing data available from the USGS National Water Quality Assessment (NAWQA) database, the EPA reported that the median concentration of manganese was 16 µg/L for surface water and 5 µg/L for groundwater from 20 watersheds and 16 drainage basins in the United States (EPA 2003a). The results of this analysis for all sites are reproduced in Table 6-5. Reported mean groundwater concentrations of manganese were 20 and 90 µg/L

## 6. POTENTIAL FOR HUMAN EXPOSURE

**Table 6-4. Levels of PM<sub>2.5</sub> and PM<sub>10</sub> in Indoor and Outdoor Air in Toronto, Canada and Indianapolis, Indiana**

| Location                          | Number | Median concentration<br>(ng/m <sup>3</sup> ) | 90 <sup>th</sup> concentration<br>(ng/m <sup>3</sup> ) |
|-----------------------------------|--------|--|--|
| <b>PM<sub>10</sub> Manganese</b>  |        |  |  |
| Toronto (indoor)                  | 203    | 6.7  | 14   |
| Indianapolis (indoor)             | 59     | 3.9  | 8.7  |
| Toronto (outdoor)                 | 203    | 17   | 28   |
| Indianapolis (outdoor)            | 59     | 8.8  | 14   |
| <b>PM<sub>2.5</sub> Manganese</b> |        |  |  |
| Toronto (indoor)                  | 187    | 4.7  | 9.9  |
| Indianapolis (indoor)             | 58     | 2.2  | 4.6  |
| Toronto (outdoor)                 | 185    | 8.6  | 16   |
| Indianapolis (outdoor)            | 57     | 3.2  | 5.8  |

Sources: Pellizzari et al. 1999, 2001

## 6. POTENTIAL FOR HUMAN EXPOSURE

**Table 6-5. Manganese Detections and Concentrations in Surface Water and Groundwater in the United States**

|                      | Detection frequency                                    |       |  |       | Concentration ( $\mu\text{g/L}$ ) |                  |
|----------------------|--|-------|--|-------|-----------------------------------|------------------|
|                      | Above the minimal reporting level (1 $\mu\text{g/L}$ ) |       | Above the health reference level <sup>a</sup> (300 $\mu\text{g/L}$ ) |       | Median                            | 99 <sup>th</sup> |
|                      | Samples  | Sites | Samples  | Sites |                                   |                  |
| <b>Surface water</b> |  |       |  |       |                                   |                  |
| Urban                | 99.1%  | 99.6% | 4.6%   | 13.0% | 36                                | 700              |
| Mixed                | 92.4%  | 98.5% | 1.3%   | 6.4%  | 12                                | 400              |
| Agricultural         | 96.3%  | 97.2% | 3.7%   | 12.3% | 19                                | 700              |
| Forest/rangeland     | 90.9%  | 96.4% | 5.0%   | 6.6%  | 11                                | 800              |
| All sites            | 94.0%  | 96.9% | 3.0%   | 10.2% | 16                                | 700              |
| <b>Groundwater</b>   |  |       |  |       |                                   |                  |
| Urban                | 74.7%  | 85.3% | 17.2%  | 21.0% | 15                                | 5,600            |
| Mixed                | 56.9%  | 62.9% | 8.9%   | 9.0%  | 2                                 | 1,300            |
| Agricultural         | 61.4%  | 64.0% | 11.9%  | 12.8% | 4                                 | 1,600            |
| Forest/rangeland     | 75.3%  | 81.3% | 10.9%  | 13.8% | 12                                | 2,900            |
| All sites            | 64.1%  | 70.1% | 12.8%  | 13.8% | 5                                 | 2,900            |

<sup>a</sup>The Health Reference Level (HRL) is based on the dietary reference dose (RfD) and application of a modifying factor (MF) of 3 for drinking water, and on an allocation of an assumed 20% relative source contribution from water ingestion as opposed to total manganese exposure.

Source: EPA 2003a

## 6. POTENTIAL FOR HUMAN EXPOSURE

in an analysis of California shallow groundwater from two geologic zones (Deverel and Millard 1988). Values up to 1,300 and 9,600 µg/L have been reported in neutral and acidic groundwater, respectively (EPA 1984). Manganese levels of 9,500–18,600 µg/L have been reported in four private wells in Connecticut (CDHS 1990). Natural concentrations of manganese in seawater reportedly range from 0.4 to 10 µg/L (EPA 1984).

A 1962 survey of public drinking water supplies in 100 large U.S. cities reported that 97% contained <100 µg/L of manganese (USGS 1964). Similarly, a 1969 survey of 969 systems reported that 91% contained <50 µg/L, with a mean concentration of 22 µg/L (U.S. DHEW 1970). Several other studies reported similar manganese concentrations, with mean values ranging from 4 to 32 µg/L (EPA 1984; NAS 1980a; WHO 1981). The EPA analyzed drinking water statistics from Alabama, California, Illinois, New Jersey, and Oregon for occurrence and concentration data for manganese in public water supplies. The data used contained >37,000 analytical results from about 4,000 public water supplies from 1993 to 1997, although some prior monitoring data were also employed in the analysis. The median manganese level for all detections was 10 µg/L and the 99<sup>th</sup> percentile of the detections was 720 µg/L (EPA 2003a).

#### 6.4.3 Sediment and Soil

Manganese comprises about 0.1% of the earth's crust (Graedel 1978; NAS 1973), and manganese occurs naturally in virtually all soils. Average natural ("background") levels of manganese in soils range from around 40 to 900 mg/kg, with an estimated mean background concentration of 330 mg/kg (Barceloux 1999; Cooper 1984; Eckel and Langley 1988; EPA 1985c; Rope et al. 1988; Schroeder et al. 1987). The maximum value reported was 7,000 mg/kg (Eckel and Langley 1988). Using data from 20 watersheds and 16 drainage basins in the United States, manganese was detected at 100% of the National Water-Quality Assessment Program (NAWQA) stream bed sediment sampling sites. The median and 99<sup>th</sup> percentile concentrations in bed sediments were reported as 1.1 mg/kg (dry weight) and 9.4 mg/kg (dry weight), respectively (EPA 2003a). Manganese levels as high as 1,900 mg/kg were detected in sediment samples obtained from the Tar Creek Superfund site (a site heavily contaminated with mining wastes) in Ottawa County, Oklahoma (Wright et al. 2006).

Accumulation of manganese in soil usually occurs in the subsoil and not on the soil surface; 60–90% of manganese is found in the sand fraction of the soil (WHO 1981). A preliminary survey was conducted in Utah to provide an initial field measurement of the contamination by manganese oxides from exhaust in roadside soil and plant species due to the addition of MMT to motor vehicle fuels. Soil (0–5 cm)

## 6. POTENTIAL FOR HUMAN EXPOSURE

manganese concentrations were strongly correlated with distance from roadways with moderate and moderately high traffic volumes (Lytle et al. 1994). In addition, exchangeable manganese was found to be significantly higher in an organic soil located at stations with a high traffic density comparing to another one with a low traffic density (Brault et al. 1994). The average soil manganese concentration measured at 1 meter from a moderate to moderately-high traffic volume roadside was 3,046 µg/g dry weight. At 15m, the average soil manganese concentration decreased to 254 µg/g dry weight.

#### 6.4.4 Other Environmental Media

Manganese is a natural component of most foods. A summary of mean manganese concentrations in foods analyzed by the Food and Drug Administration (FDA) Total Diet Study (TDS) 1991–1996 is summarized in Table 6-6. TDS sampling is conducted 4 times annually, once in each of the major geographical regions of the country (west, north central, south, and northeast). Each round of sampling is referred to as an individual market basket survey and for each market basket survey, samples of 260 selected food and beverages were obtained from three cities within the region. The mean and median concentration of manganese in all foods were 2.4 and 1.0 mg/kg, respectively (Capar and Cunningham 2000). The TDS results concluded that detectable levels of manganese were present in roughly 75% of all foods, although approximately 24% of these detections were below the quantification limits used in the study (Capar and Cunningham 2000). The highest manganese level was observed in a sample of shredded wheat cereal (44.4 mg/kg). The five foods with the highest mean manganese levels were oat ring cereal (33.8 mg/kg), raisin bran cereal (28.8 mg/kg), shredded wheat cereal (25.0 mg/kg), mixed nuts (23.2 mg/kg), and granola cereal (20.1 mg/kg). These levels are similar to levels found in previous market basket surveys (Pennington et al. 1986). Tea and leafy green vegetables were the major dietary sources of manganese for young women taking part in a dietary study in Wisconsin (Davis et al. 1992a).

Bioaccumulation of manganese by plants was examined using oats (*Avena nova*) and beans (*Phaseolus vulgaris*) (Brault et al. 1994). These plants were grown in sandy and organic soil at a control site (greenhouse) and at two outdoor sites near <20,000 and 132,000 vehicles/day respectively. The highest manganese accumulation was found in the fruits and stems of oats grown in the organic and sandy soils at the station with the highest traffic density. Lönnerdal (1997) reported that infant formulas contain 30–75 ppb (0.03–0.075 ppm) manganese, as compared to concentrations of 3–10 ppb (0.003–0.01 ppm) in breast milk and 30 ppb (0.03 ppm) in cow's milk.

## 6. POTENTIAL FOR HUMAN EXPOSURE

**Table 6-6. Mean Concentrations of Manganese for FDA's Total Diet Study Market Baskets 1991 through 1997<sup>a</sup>**

| Food product              | Range (mg/kg)    |
|---------------------------|------------------|
| Milk and cheese           | Not detected–<2  |
| Eggs                      | <1               |
| Meat, poultry, and fish   | Not detected–3.7 |
| Legumes and nuts          | 3.4–23.2         |
| Grain products            | <1–33.8          |
| Fruit                     | <1–10.0          |
| Vegetables                | <1–5.9           |
| Mixed dishes and meals    | <1–3.4           |
| Desserts                  | Not detected–4.9 |
| Snacks                    | 3.4–9.3          |
| Condiments and sweeteners | Not detected–4.1 |
| Fats and dressings        | Not detected–<1  |
| Beverages                 | Not detected–2.9 |
| Infant and junior foods   | Not detected–7.5 |

<sup>a</sup>A < symbol indicates that manganese was detected, but at a level lower than the limit of quantification.

Source: Capar and Cunningham 2000

## 6. POTENTIAL FOR HUMAN EXPOSURE

During a 1992 survey conducted by Canada's Department of Fisheries and Oceans, concentrations of manganese were detected in the muscle samples of bluefin tuna (*Thunnus thynnus*) (Hellou et al. 1992). Concentrations of manganese in 14 samples of fish muscle ranged from 0.16 to 0.31 µg manganese/g dry weight, with a mean of 0.22 µg/g. Although the analysis was administered with a high accuracy of 94% using inductively coupled plasma-mass spectrometry (ICP-MS), the sample population was small.

In the field survey conducted by Lytle et al. (1994), terrestrial and aquatic plant samples were collected along motorways and local urban roadways throughout Utah during 1992 and 1993. Manganese was detected in the plant samples, with manganese concentrations ranging from 30.2 to 13,680 µg/g dry weight. Manganese was detected in plants found nearest to the motorway. Loranger et al. (1994b) evaluated the use of the pigeon as a monitor for manganese contamination from motor vehicles in urban and rural areas of Canada, a country in which MMT has been used to replace lead in gasoline. Manganese concentrations were similar in the two groups of pigeons for all tissues except the liver and feces; urban pigeons had about 35% more manganese than rural ones. Loranger et al. (1994b) suggested that although pigeon feces and liver may be good biomarkers of manganese contamination, it is premature to associate the excess manganese with the combustion of MMT. Toxicokinetic studies of manganese in both male and female rats suggested that MMT-derived manganese administered in oral doses resulted in higher and more prolonged plasma concentration versus time profiles than inorganic ( $MnCl_2$ ) complexes, leading to the conclusion that MMT-derived manganese was likely to accumulate following repeated exposures (Zheng et al. 2000).

### 6.5 GENERAL POPULATION AND OCCUPATIONAL EXPOSURE

Since manganese is ubiquitous in the environment, the general population is exposed to manganese from both natural and anthropogenic sources. The manganese concentration in blood of healthy adults is reported to range from 4 to 15 µg/L with an average value of about 9 µg/L (Barceloux 1999). Typical daily human exposure levels to manganese from water, air, and food are summarized in Table 6-7 (EPA 1984). As the table illustrates, the most significant exposure for the general population is from food, with an average ingestion rate of 3,800 µg/day (EPA 1984). Other estimates of daily intake for adults range from 2,000 to 8,800 µg (EPA 1984; NAS 1977; Patterson et al. 1984; Pennington et al. 1986; WHO 1984a) and 700–10,900 µg/day (WHO 2004b). Even though gastrointestinal absorption of manganese is low (3–5%), oral exposure is the primary source of absorbed manganese.



## 6. POTENTIAL FOR HUMAN EXPOSURE

**Table 6-7. Summary of Typical Human Exposure to Manganese<sup>a</sup>**

| Parameter                                     | Exposure medium   |                         |                   |
|---|-------------------|-------------------------|-------------------|
|   | Water             | Air                     | Food              |
| Typical concentration in medium               | 4 µg/L            | 0.023 µg/m <sup>3</sup> | 1.28 µg/calories  |
| Assumed daily intake of medium by 70-kg adult | 2 L               | 20 m <sup>3</sup>       | 3,000 calories    |
| Estimated average daily intake by 70-kg adult | 8 µg              | 0.46 µg <sup>b</sup>    | 3,800 µg          |
| Assumed absorption fraction                   | 0.03 <sup>c</sup> | 1 <sup>c</sup>          | 0.03 <sup>d</sup> |
| Approximate absorbed dose                     | 0.24 µg           | 0.46 µg                 | 114 µg            |

<sup>a</sup>Adapted from EPA 1984

<sup>b</sup>Assumes 100% deposition in the lungs

<sup>c</sup>No data; assumed value

<sup>d</sup>Vitarella et al. 2000

## 6. POTENTIAL FOR HUMAN EXPOSURE

Manganese intake among individuals varies greatly, depending upon dietary habits. For example, an average cup of tea may contain 0.4–1.3 mg of manganese (Pennington et al. 1986; Schroeder et al. 1966). Thus, an individual consuming three cups of tea per day might receive up to 4 mg/day from this source alone, increasing the average intake from all dietary sources.

As part of the Third National Health and Nutrition Examination Survey (NHANES) conducted by the Centers of Disease Control and Prevention (CDC), manganese was detected at quantifiable levels in urine samples from 73% of 496 participants of the monitoring study (Paschal et al. 1998). The mean urinary manganese concentration in these 496 individuals (aged 6–88 years of age) was 1.19 µg/L (Paschal et al. 1998).

The EPA Reference Dose (RfD)/RfC workgroup in June 1990 set an RfD for manganese in food of 0.14 mg manganese/kg/day, equivalent to about 10 mg/day for a 70-kg man based on chronic manganese uptake (EPA 1993b). The Food and Nutrition Board of the National Research Council (NRC) estimated the adequate and safe intake of manganese for adults at 2–5 mg/day (NAS 1980b). This level was chosen because it includes an "extra margin of safety" of 5 mg/day below the level of 10 mg/day, which the NRC considered to be safe for occasional intake (IRIS 2008).

In the workplace, exposure to manganese is most likely to occur by inhalation of manganese fumes or manganese-containing dusts. This is a concern mainly in the ferromanganese, iron and steel, dry-cell battery, and welding industries (WHO 1986). Exposure may also occur during manganese mining and ore processing; however, the most recent data indicate that only a very small amount of manganese is still mined in the United States (USGS 2007). Excluding insignificant quantities of similar low-grade manganiferous ore, the United States has not mined significant amounts of manganese since 1978 and now relies on imports to fill its needs (USGS 2007). In 1980, it was estimated that in the United States about 300 workers were exposed to pure manganese and about 630,000 workers were exposed to other forms of manganese (NOES 1989). Concentrations as large as 1.5–450 mg manganese/m<sup>3</sup> have been reported in U.S. manganese mines (EPA 1984), 0.30–20 mg manganese/m<sup>3</sup> in ferroalloy production facilities (Saric et al. 1977), and 3–18 mg manganese/m<sup>3</sup> in a dry-cell battery facility (Emara et al. 1971). Steel-manufacturing facilities are significant employers in the United States. There is a potential for manganese exposure to workers in these facilities. Airborne manganese levels in a metal-producing plant in the United States were reported as 0.066 mg/m<sup>3</sup> (mean), 0.051 mg/m<sup>3</sup> (median) as respirable dust, and 0.18 mg/m<sup>3</sup> in total dust (Gibbs et al. 1999). Exposure levels should not exceed the Occupational Safety and Health Administration (OSHA) time-weighted average Permissible Exposure Limit (PEL) of 1 mg

## 6. POTENTIAL FOR HUMAN EXPOSURE

total manganese/m<sup>3</sup> (see Table 8-1). Average airborne manganese levels during welding operations of two factories located in China were 0.24 and 2.21 mg/m<sup>3</sup> (Wang et al. 2008). Manganese levels in workplace air at a smelting facility in China ranged from 0.30 to 2.9 mg/m<sup>3</sup> in the furnace smelting area and from about 0.2 to 0.8 mg/m<sup>3</sup> in a power control room (Jiang et al. 2007). The workplace air at this facility contained mainly MnO (20%) and SiO<sub>2</sub> (22%), in addition to other trace metals including Fe<sub>2</sub>O<sub>3</sub> (4%), CaO (4.5%), MgO (4%), and Al<sub>2</sub>O<sub>3</sub> (5%). Thus, for workers in industries using manganese, the major route of exposure may be inhalation from workplace air rather than from ingestion of food.

Occupational exposure to manganese resulting from the combustion of MMT in Montreal, Canada has been studied. Sierra et al. (1995) conducted a study of Montreal automotive workers (garage mechanics) and nonautomotive workers (control group). Exposure to manganese was measured for 5 consecutive working days. In addition, their environmental exposure (at home) was measured on 2 days of the same week. Air sampling was performed by portable pumps; for sampling at homes, workers were asked to wear the pumps as much as possible. At the workplace, the mechanics were exposed to manganese concentrations ranging from 0.010 to 6.673 µg/m<sup>3</sup> (mean of 0.45 µg/m<sup>3</sup>), while nonautomotive workers were exposed to manganese concentrations ranging from 0.011 to 1.862 µg/m<sup>3</sup> (mean of 0.04 µg/m<sup>3</sup>). The average manganese concentrations in the indoor air of the homes were 0.012 µg/m<sup>3</sup> for the mechanics and were 0.008 µg/m<sup>3</sup> for the nonautomotive workers (Sierra et al. 1995). Based on measurements of manganese particle size distributions, Sierra et al. (1995) estimated that <10% of the manganese exposure of the garage mechanics was due to MMT; however, the exact contribution of MMT could not be determined.

A similar study conducted in Montreal by these investigators, but involving taxi drivers and garage mechanics revealed that garage mechanics at work were exposed to an average of 0.250 µg/m<sup>3</sup> and taxi drivers to 0.024 µg/m<sup>3</sup> (Zayed et al. 1994). In another study, exposure of office workers and taxi drivers to both respirable and total manganese was evaluated (Zayed et al. 1996). Manganese concentrations measured for the office workers ranged from 0.001 to 0.034 µg/m<sup>3</sup> (respirable manganese) and from 0.002 to 0.044 µg/m<sup>3</sup> (total manganese). For the taxi drivers, the manganese concentrations ranged from 0.007 to 0.032 µg/m<sup>3</sup> (respirable manganese) and from 0.008 to 0.073 µg/m<sup>3</sup> (total manganese). Zayed et al. (1996) concluded that the higher exposure to atmospheric manganese in the outdoor urban environment may be at least partly due to the use of MMT in cars. Nevertheless, these investigators indicated that the exposures of taxi drivers to manganese were well below existing exposure and health guidelines.

## 6. POTENTIAL FOR HUMAN EXPOSURE

In order to assess the potential health risks from MMT combustion, Loranger and Zayed (1995) conducted a multi-media assessment (i.e., food, water, and ambient air) of manganese exposure in two groups of workers (garage mechanics and blue-collar workers) potentially exposed to different levels of manganese from MMT. Garage mechanics were exposed to higher air manganese concentrations ( $0.42 \mu\text{g}/\text{m}^3$ ) than blue-collar workers ( $0.04 \mu\text{g}/\text{m}^3$ ). However, for the garage workers, exposure to atmospheric manganese represented only approximately 4% of the total absorbed dose, while ingestion of food represented 95.7% of the total multi-media dose. For the blue collar workers, atmospheric manganese contributed only 0.3% to the total absorbed dose, whereas ingestion of food represented 99.2% of the total multi-media dose. These results were consistent with values of multi-media doses predicted by GADUS, an environmental fate/exposure model (Loranger and Zayed 1997b). Based on governmental standards or criteria for occupational and environmental exposures, Loranger and Zayed (1995) concluded that the manganese levels in food and air may not cause any problems for these workers.

Based on an analysis of data obtained from a large, continuous personal exposure study in Toronto, Canada, a city with widespread use of MMT, it was determined that the general population was exposed to low concentrations (median concentration was  $0.008 \mu\text{g}/\text{m}^3$ ) of  $\text{PM}_{2.5}$  manganese in personal air samples (Lynam et al. 1999; Pellizzari et al. 1999). A similar study, which collected 925 personal exposure samples for residents of Toronto, also concluded that MMT was not a significant source of  $\text{PM}_{2.5}$  manganese inhalation exposure for the general population (Crump 2000). However, personal exposure levels of fine manganese in Toronto were nearly 3 times greater when compared to data obtained from Indianapolis, Indiana where MMT was not being used as a gasoline additive. The median concentration of  $\text{PM}_{2.5}$  manganese in personal exposure samples from Indianapolis was  $0.0028 \mu\text{g}/\text{m}^3$  (Pellizzari et al. 2001). These data are summarized in Table 6-8. Certain activities such as time spent in subways, metal working, and smoking were associated with higher personal manganese exposure.

## 6.6 EXPOSURES OF CHILDREN

This section focuses on exposures from conception to maturity at 18 years in humans. Differences from adults in susceptibility to hazardous substances are discussed in Section 3.7, Children's Susceptibility.

Children are not small adults. A child's exposure may differ from an adult's exposure in many ways. Children drink more fluids, eat more food, breathe more air per kilogram of body weight, and have a larger skin surface in proportion to their body volume. A child's diet often differs from that of adults.

## 6. POTENTIAL FOR HUMAN EXPOSURE

**Table 6-8. Levels of PM<sub>2.5</sub> in Personal Air Samples Collected in Toronto, Canada and Indianapolis, Indiana**

| Location                                    | Number | Median concentration (µg/m <sup>3</sup> ) | 90 <sup>th</sup> concentration (µg/m <sup>3</sup> ) |
|---|--------|---|---|
| PM <sub>2.5</sub> Manganese in personal air |        |   |   |
| Toronto                                     | 272    | 0.008                                     | 0.016   |
| Indianapolis                                | 240    | 0.0028                                    | 0.006   |

Source: Pellizzari et al. 1999, 2001

## 6. POTENTIAL FOR HUMAN EXPOSURE

The developing human's source of nutrition changes with age: from placental nourishment to breast milk or formula to the diet of older children who eat more of certain types of foods than adults. A child's behavior and lifestyle also influence exposure. Children crawl on the floor, put things in their mouths, sometimes eat inappropriate things (such as dirt or paint chips), and spend more time outdoors. Children also are closer to the ground, and they do not use the judgment of adults to avoid hazards (NRC 1993).

Children would be exposed to manganese in the same manner as adults. The main source of exposure of children to manganese is through food. Infants and young toddlers who are formula-fed may receive higher daily intakes of manganese than breast-fed infants because of the increased levels of the element in infant formulas as compared to breast milk (Collipp et al. 1983; Cook 1997; Dorner et al. 1989; Keen et al. 1986; Lönnerdal et al. 1983, 1994). For example, a study of 2,339 breast milk samples obtained from nursing mothers in Germany had a mean manganese level of 6.2 µg/L, while two different brands of formula had levels of 77 and 99 µg/L (Dorner et al. 1989). It was concluded that the mean daily manganese intake of formula-fed infants was approximately 13 times greater than that of breast-fed infants.

Manganese concentrations in blood serum of children of different ages are provided in Section 3.4.2. The data indicate that manganese concentrations decrease slightly from the time the infant is 5 days of age until he or she is 12 months of age (Alarcón et al. 1996; Rügauer et al. 1997). Manganese concentrations increase after this time, and they have been measured as an average of  $1.4 \pm 1.25$  µg/L in children aged 1 month to 18 years (Rügauer et al. 1997).

Children are exposed *in utero* because manganese in maternal blood crosses the placenta to satisfy the fetus's need for manganese. The compound has been measured in cord blood plasma of premature and full-term infants and their mothers (Wilson et al. 1991). Full-term babies had higher (but not statistically significantly different) blood concentrations of manganese than premature babies, and pregnant women had higher blood concentrations than nonpregnant women. The average manganese concentration in the cord blood of full term babies was 5.5 µg/L, as compared to 5.0 µg/L for preterm babies (Wilson et al. 1991). No correlations were observed between maternal and infant concentrations of manganese. Manganese in breast milk has been found to range from 3.4 to 10 µg/L (Arnaud and Favier 1995; Collipp et al. 1983) depending on the maturity of the milk. The Food and Nutrition Board of the NRC based the recommended manganese intake of infants on the analyses of pooled human milk samples. As discussed above, manganese intakes of infants fed some formulas appear high, but no signs of toxicity have been observed (Dorner et al. 1989; Lönnerdal et al. 1983). Differences in weight-adjusted intake are likely to

## 6. POTENTIAL FOR HUMAN EXPOSURE

be caused by the type of diet that infants and small children receive. It is unknown whether nursing mothers exposed to higher-than-average concentrations of manganese would excrete increased concentrations of the metal in their breast milk.

Young children often eat dirt (exhibiting what is called soil pica, the ingestion of a material unfit for food) and exhibit frequent hand-to-mouth activity; they can be exposed to manganese through this unique pathway if the soils contain the metal. Current estimates indicate that soil pica may be more prevalent in the general population than previously thought and that most children periodically ingest soil to varying degrees; this may be a potential health concern (EPA 1986d; Stanek and Calabrese 1995). The predicted oral average daily intake of manganese for children from soils in the vicinity of a municipal solid waste incinerator was estimated to range from approximately 0.0021 to 0.0032 mg/kg/day (Mari et al. 2007). However, no information was found concerning the bioavailability of manganese from soil and, therefore, determining the actual risk posed to children from this exposure pathway is difficult. This behavior should not pose an increased risk of exposure to manganese in most residential situations where the manganese levels are in the normal or background range. If the soils are from a hazardous waste site that contains high concentrations of manganese, then increased exposure to the compound may occur. Manganese levels in hair samples of 32 children residing near a hazardous waste site (former mining facility) in Northeast Oklahoma ranged from 89.1 to 2,145.3 ppb (471.5 ppb mean) (Wright et al. 2006). The authors found that in school-aged children, higher manganese and arsenic levels in hair samples were associated with significantly lower scores on a standardized test, as well as on tests of verbal learning and memory.

Children who suffer from cholestatic liver disease or who have gastrointestinal disorders that mandate they be given parenteral nutrition may be at increased risk from overexposure to manganese. Increased manganese concentrations in blood and brain, and symptoms of neuromotor dysfunction were observed in an 8-year-old girl with cholestatic liver failure (Devenyi et al. 1994). Children with or without chronic liver disease and a 5-year-old boy who had gastrointestinal disorders, all of whom were administered parenteral nutrition, had abnormal MRI scans indicative of manganese accumulation (Fell et al. 1996; Ono et al. 1995) accompanied by motor disorders (Fell et al. 1996).

Because manganese is a trace element that is essential for normal human health and is predominantly obtained from food, it is unlikely that toxic amounts of manganese will be absorbed from food. However, diets vary and some are higher in manganese than others (diets high in grains and tea, for instance). One case study suggested that a 59-year-old man developed manganism-like symptoms from abusing vitamins

## 6. POTENTIAL FOR HUMAN EXPOSURE

and minerals. This man had very high manganese concentrations in blood, urine, feces, hair, and brain (Banta and Markesbery 1977). Both manganese and iron are bound by transferrin and these elements compete for the binding protein in the body. Therefore, diets that are low in iron allow transferrin to bind more manganese. For this reason, it is important to provide children with a balanced diet to maintain optimal iron and manganese stores in the body. Studies show that adults absorb only 3–5% of manganese ingested from the diet (Davidsson et al. 1988, 1989a; Mena et al. 1969); infants have increased absorption relative to adults (Dorner et al. 1989). Neonatal animals also exhibit increased absorption relative to older animals (Ballatori et al. 1987; Miller et al. 1975; Rehnberg et al. 1981).

Children may be exposed to organic manganese compounds through a variety of routes. They may be exposed to MMT combustion products via inhalation of these products in air, or ingestion of them after deposition on the soil.

### 6.7 POPULATIONS WITH POTENTIALLY HIGH EXPOSURES

As discussed in Section 6.5, workers in industries using or producing manganese are mostly likely to have higher exposures to manganese, primarily by inhalation of manganese dusts in workplace air as compared to the general population. In a year-long investigation of personal exposure to manganese fine particulate matter (PM<sub>2.5</sub>) for residents of Toronto, Canada, it was determined that workers in the metal industry had the highest personal exposures as compared to other groups. The mean concentration of manganese PM<sub>2.5</sub> in personal samples for 39 workers engaged in welding, soldering, or other metal working practices was 105 ng/m<sup>3</sup>, which was more than 10 times greater than the mean concentration (10 ng/m<sup>3</sup>) for 886 non-metal workers (Crump 2000). Smokers and those nearby second-hand smoke were also shown to be exposed to higher levels of fine particulate matter manganese as compared to nonsmokers. The mean concentration of PM<sub>2.5</sub> manganese in 702 personal air samples of nonsmokers in Toronto, Canada was 10 ng/m<sup>3</sup>, while the mean concentration calculated from 223 personal samples obtained from smokers was 27 ng/m<sup>3</sup> (Crump 2000).

Average airborne manganese levels (total dust) in the breathing zone of two factories located in China were 0.24 and 2.21 mg/m<sup>3</sup> (Wang et al. 2008). The greatest levels were observed during welding operations in enclosed spaces. The workers at these two factories had higher measurable manganese levels in their saliva (3.47±1.42 and 5.55±2.31 µg/L), as compared to a control group of non-occupationally exposed individuals (3.04±1.40 µg/L).



## 6. POTENTIAL FOR HUMAN EXPOSURE

Workers in three manganese alloy production plants located in Norway were found to have slightly higher manganese blood and urine levels when compared to a group of non-occupationally exposed individuals. The arithmetic mean manganese level in the blood of workers at these plants was 189 nmol/L (10.3 µg/L) versus 166 nmol/L (9.1 µg/L) for the reference group (Ellingsen et al. 2003c). The urinary arithmetic mean concentrations were 3.9 nmol/mmol creatinine for the occupationally exposed workers and 0.9 nmol/mmol creatinine for the reference group (Ellingsen et al. 2003c). The arithmetic mean inhalable and respirable concentrations of manganese in the air of these production plants were 0.769 and 0.064 mg/m<sup>3</sup>, respectively (Ellingsen et al. 2003c). Section 3.2.1.4 summarizes other studies that compared noted health effects with urinary and blood manganese levels of occupationally exposed individuals and reference populations. It has been demonstrated that levels in the blood and urine may not be adequate biomarkers for high level manganese exposure since free manganese usually does not accumulate within the circulatory system (Josephs et al. 2005).

Populations living in the vicinity of ferromanganese or iron and steel manufacturing facilities, coal-fired power plants, or hazardous waste sites may also be exposed to elevated manganese particulate matter in air or water, although this exposure is likely to be much lower than in the workplace. Populations living in regions of natural manganese ore deposits may be exposed to above-average levels in soil, water, or air.

People ingesting large amounts of foods high in manganese also have a potential for higher-than-usual exposure. Included in this group would be vegetarians, who ingest a larger proportion of grains, legumes, and nuts in their diets than the average U.S. population, and heavy tea drinkers. While the intake of manganese from vegetarians may exceed the estimates of daily dietary intake, the bioavailability of manganese from vegetable sources is substantially decreased by dietary components such as fiber and phytates (EPA 1993b). In addition to the population with these dietary habits, individuals with iron deficiency show increased rates of manganese absorption (Mena et al. 1969, 1974); iron deficiency leads to increased brain manganese concentrations in experimental animals (Aschner and Aschner 1990).

Manganese is eliminated from the body primarily through the bile. Interruption of the manufacture or flow of bile can impair the body's ability to clear manganese. Several studies have shown that adults and children (Devenyi et al. 1994; Fell et al. 1996; Hauser et al. 1994, 1996; Pomier-Layrargues et al. 1998; Rose et al. 1999; Spahr et al. 1996), as well as experimental animals (Rose et al. 1999), with cholestatic liver disorders have increased manganese levels in their blood and brain and are at risk from potentially increased exposure to manganese due to their decreased homeostatic control of the compound.

## 6. POTENTIAL FOR HUMAN EXPOSURE

In addition to oral diets, people on partial and total parenteral nutrition may be exposed to increased amounts of manganese. Forbes and Forbes (1997) found that of 32 patients receiving home parenteral nutrition due to digestive problems, 31 had elevated serum manganese levels (0.5–2.4 mg/L). It is unclear whether these levels reflected steady-state conditions due to the time the samples were taken. However, these levels are much higher than other studies involving patients on TPN; thus, it is unlikely that these levels represent steady-state conditions. Further, the normal range reported by these authors (0.275–0.825 mg/L) is elevated compared to other studies, suggesting the possibility that the blood samples were contaminated with exogenous manganese. The authors observed no clinical evidence of toxicity in the patients. Fourteen of the patients suffered iron deficiency anemia; because low iron concentrations are associated with increased manganese uptake, the anemia may have exacerbated the increased blood manganese concentrations. Increased blood manganese levels and MRI scans indicative of increased manganese in brains have been reported in children fed entirely on parenteral nutrition (Fell et al. 1996; Ono et al. 1995). Only in the Fell et al. (1996) study were neurotoxic effects reported. Whole-blood manganese in the children from this study ranged from 9.9 to 110 µg/L. Devenyi et al. (1994) found hyperintense signals in the brain of an 8-year-old child who had cholestatic liver disease and exhibited dystonia and other motor dysfunctions. Nagatomo et al. (1999) reported that two elderly patients who had been administered TPN for 3–4 months exhibited clinical signs of manganism (including masked facies, marked rigidity, hypokinesia) with associated elevated blood manganese levels and hyperintense signals on MRI, localized to the basal ganglia, especially the globus pallidus. Signs of manganism abated upon levodopa treatment and the administration of Ca-EDTA; the high intensity signals on MRI abated when manganese supplementation ceased. In addition to patients on parenteral nutrition, uremic patients on hemodialysis have been found to have increased manganese levels due to increased concentrations of manganese in the dialysis solution (Lin et al. 1996). These studies indicate that while increased levels of manganese in blood and brain are often associated with TPN administration, adverse neurological effects are not always reported. Nagatomo et al. (1999) found increased serum concentrations of manganese and brain abnormalities in two patients who showed Parkinsonism with psychiatric symptoms after 3–4 months of total parenteral nutrition. Discontinuation of manganese supplementation in the parenteral diet, coupled with levodopa treatment, gradually improved both the symptoms and brain abnormalities in the patients.

In comparison to other groups within the general population, persons living close to high density traffic areas, automotive workers, gas station attendants, and taxi drivers may be exposed to higher concentrations of manganese arising from the combustion of MMT. Levels of respirable manganese, in both indoor and outdoor air near an expressway with high traffic density were shown to be greater than

## 6. POTENTIAL FOR HUMAN EXPOSURE

corresponding air samples obtained from a rural location in Montreal, Canada (Bolte et al. 2004). The average concentration of respirable manganese (defined in this study as  $<5 \mu\text{m}$  diameter) in outdoor air from the urban location of Montreal was  $0.025 \mu\text{g}/\text{m}^3$ , which is 5 times greater than the average of  $0.005 \mu\text{g}/\text{m}^3$  found in the rural location. The average indoor respirable manganese concentration was also greater for the urban area ( $0.017 \mu\text{g}/\text{m}^3$ ) as compared to the rural area ( $0.007 \mu\text{g}/\text{m}^3$ ). However, differences in exposure levels did not lead to significantly greater levels of manganese in blood for residents of these areas. The mean manganese concentration in blood samples obtained from female residents in the urban location ( $8.4 \mu\text{g}/\text{L}$ ) was only slightly greater than the average level observed for females living in the rural location ( $7.8 \mu\text{g}/\text{L}$ ).

It is possible that medical workers may be exposed to higher concentrations of manganese than the general population, although exposure routes other than intravenous are not expected to pose a significant risk.

## 6.8 ADEQUACY OF THE DATABASE

Section 104(i)(5) of CERCLA, as amended, directs the Administrator of ATSDR (in consultation with the Administrator of EPA and agencies and programs of the Public Health Service) to assess whether adequate information on the health effects of manganese is available. Where adequate information is not available, ATSDR, in conjunction with NTP, is required to assure the initiation of a program of research designed to determine the health effects (and techniques for developing methods to determine such health effects) of manganese.

The following categories of possible data needs have been identified by a joint team of scientists from ATSDR, NTP, and EPA. They are defined as substance-specific informational needs that if met would reduce the uncertainties of human health assessment. This definition should not be interpreted to mean that all data needs discussed in this section must be filled. In the future, the identified data needs will be evaluated and prioritized, and a substance-specific research agenda will be proposed.

### 6.8.1 Identification of Data Needs

**Physical and Chemical Properties.** The fundamental physical and chemical properties of manganese and manganese compounds are known (see Table 4-2), and additional research does not appear necessary.

## 6. POTENTIAL FOR HUMAN EXPOSURE

**Production, Import/Export, Use, Release, and Disposal.** According to the Emergency Planning and Community Right-to-Know Act of 1986, 42 U.S.C. Section 11023, industries are required to submit substance release and off-site transfer information to the EPA. The TRI, which contains this information for 2006, became available in March of 2008. This database is updated yearly and should provide a list of industrial production facilities and emissions.

Information is available on U.S. import, export and production of manganese ore and related materials (USGS 2007, 2008). It is clear that most manganese is used in steel production. Information regarding the import, export, and use of MMT in U.S. fuels is a data need.

Data from the TRI database provide valuable information on the amounts of manganese released to different environmental media (e.g., air, soil, and water) each year, although details on the chemical form and physical state of the waste materials are not included. These disposal practices are not regulated under current federal law. TRI data may not be complete estimates of total release. Also, because these data reflect past releases, they may not be representative of current releases at these facilities.

**Environmental Fate.** The partitioning of manganese between water and soil can be fairly well predicted using thermodynamic equilibrium concepts, if soil-specific information is available (Baes and Sharp 1983; Rai et al. 1986). The fate of manganese particles released into the air is determined by the particle size, and the direction and distance of particle transport at a site can be predicted from meteorological data and particle size data (EPA 1984; Nriagu 1979). Transport of manganese in water is determined mainly by the solubility of the manganese compounds present, although suspended particles may also be transported in flowing waters (EPA 1984; Schaanning et al. 1988).

The primary transformations that manganese undergoes in the environment are oxidation/reduction reactions (EPA 1984; Rai et al. 1986). Reactions of manganese with airborne oxidants have not been studied. Information on the rate and extent of such reactions would be helpful in understanding the fate of atmospheric releases. The transformation of manganese in water or soil is dependent mainly on Eh, pH, and available counter ions (EPA 1984). In some soils, manganese may also be oxidized by bacteria (Geering et al. 1969; Johnston and Kipphut 1988). More work is needed on the environmental factors, such as soil composition and pH, which may determine the form in which manganese will appear and thus impact manganese availability and absorption.

## 6. POTENTIAL FOR HUMAN EXPOSURE

Modeling has also provided interesting insight into the contribution of the combustion of MMT to atmospheric manganese (Loranger et al. 1995). According to the model estimations, the contribution of direct emissions from motor vehicles to the atmospheric background manganese (as measured from sampling stations) would be about 50% at <25 m and <8% at 250 m. These results are confirmed with an *in situ* study using snow as the environmental indicator where the average deposition rates of manganese for the top and bottom layers ranged from 0.01 to 0.21 mg/m<sup>2</sup>/day (Loranger et al. 1996). The average concentrations of manganese decreased with distance from the road. However, it was impossible to distinguish between directly-emitted manganese from automobiles, manganese enriched road dust, and the naturally-occurring manganese in crustal materials. No study to date has provided the complete answer to this question and this constitutes one of the major remaining data needs regarding the environmental significance of manganese from MMT and the resulting potential for exposure.

**Bioavailability from Environmental Media.** Manganese is known to be absorbed following inhalation or oral exposure (Mena et al. 1969; Pollack et al. 1965; Zheng et al. 2000), but dermal exposure is not considered to be significant. The uptake of manganese from air, food, milk, and water has been studied (Davidsson et al. 1988, 1989a). However, absorption from soil has not been investigated. In view of the potential for tight binding of manganese to some soil types, studies on this subject would be valuable in evaluating risk to humans, especially children who may ingest contaminated soils near hazardous waste sites. Additional information would also be valuable on the relative bioavailability of different manganese compounds across various environmental media.

**Food Chain Bioaccumulation.** It has been established that while lower organisms (e.g., plankton, aquatic plants, and some fish) can significantly bioconcentrate manganese, higher organisms (including humans) tend to maintain manganese homeostasis (EPA 1984; Folsom et al. 1963; Thompson et al. 1972). This indicates that the potential for biomagnification of manganese from lower trophic levels to higher ones is low, and it does not appear that additional research in this area is essential at this time.

**Exposure Levels in Environmental Media.** Reliable monitoring data for the levels of manganese in contaminated media at hazardous waste sites are needed so that the information obtained on levels of manganese in the environment can be used in combination with the known body burden of manganese to assess the potential risk of adverse health effects in populations living in the vicinity of hazardous waste sites.

## 6. POTENTIAL FOR HUMAN EXPOSURE

Manganese levels have been monitored in all environmental media, including air, water, soil, and food (Capar and Cunningham 2000; EPA 1984; NAS 1980a; Pennington et al. 1986). Estimates are available for the average human intake levels of manganese from water, air, and food (EPA 1984; WHO 2004b).

More specific data on levels in the environment around those particular sites where manganese is believed to have been dumped would be helpful in determining the extent of exposure levels around such waste sites. In particular, data on the concentration of manganese in the air around hazardous waste sites would be valuable in assessing the potential significance of this exposure pathway.

**Exposure Levels in Humans.** This information is necessary for assessing the need to conduct health studies on these populations. Manganese is a normal component of human tissues and fluids (Sumino et al. 1975; Tipton and Cook 1963). Increased average levels of manganese have been detected in blood and urine of populations exposed to high concentrations of manganese in the workplace (Roels et al. 1987b). Manganese has been measured in hair samples of children residing near a hazardous waste site (Wright et al. 2006); however, the absence of data on levels of manganese in the hair of U.S. children in the general population makes it difficult to draw conclusions about whether the exposures of the children at this site are unusually high. Surveys of manganese levels in the blood or urine of populations living near waste sites could be useful in identifying groups with above-average levels of manganese exposure. More information is also needed to determine whether iron-deficient populations have a higher manganese body burden. Manganese and iron have many physico/chemical similarities and there is a possibility of competition between these elements. Increased manganese concentrations have been shown to inhibit the metabolic function of the iron-dependent enzyme, aconitase (Zheng et al. 1998). Iron deficiency is the single most prevalent nutritional deficiency in the world, and so the potential health risk associated with iron deficiencies exacerbating the brain manganese burden may represent a crucial issue of exposure and susceptibility, and has yet to be evaluated. Air concentrations in areas with high traffic density are sometimes higher than the guide level (Zayed et al. 1999a); therefore, some individuals could be at risk. Research focusing on the environmental level of exposure of certain groups of the population, such as those living near a major highway, is needed.

This information is necessary for assessing the need to conduct health studies on these populations.

**Exposures of Children.** Children are exposed daily to manganese. The compound is an essential trace element vital for the body to function properly and body burden studies are available (Alarcón et al. 1996; Rügauer et al. 1997). Although the primary pathway for exposure is the diet, studies involving

## 6. POTENTIAL FOR HUMAN EXPOSURE

exposures to airborne manganese (e.g., in dust that may be present at a nearby hazardous waste site or manganese-processing plant) would aid in understanding other pathways that may contribute significantly to children's total body burden of manganese

Soil ingestion is likely the only unique exposure pathway for children. Additional studies concerning bioavailability of manganese from soil would provide important information concerning the proportion of the total daily manganese intake that could originate from ingested soils.

Although infants differ in their weight-adjusted intake of manganese, it is unknown whether older children differ in this parameter. Studies concerning this end point would be very valuable.

Studies involving inhalation or ingestion exposure to MMT in the young are very few (Komura and Sakamoto 1992b, 1994). Although these studies indicate that MMT had very little measurable effect on development, only one dose level was used. Although analytical data indicate that environmental MMT is unlikely to persist (Lynam et al. 1999), it is unknown what typical body burdens of manganese might be in children following long-term exposure to MMT combustion products. Additional studies measuring these end points in the young would be helpful.

Child health data needs relating to susceptibility are discussed in Section 3.12.2, Identification of Data Needs: Children's Susceptibility.

**Exposure Registries.** No exposure registries for manganese were located. This substance is not currently one of the compounds for which a sub-registry has been established in the National Exposure Registry. The substance will be considered in the future when chemical selection is made for sub-registries to be established. The information that is amassed in the National Exposure Registry facilitates the epidemiological research needed to assess adverse health outcomes that may be related to exposure to this substance.

### 6.8.2 Ongoing Studies

The Federal Research in Progress (FEDRIP 2008) database provides additional information obtainable from a few ongoing studies that may fill in some of the data needs identified in Section 6.8.1.

## 6. POTENTIAL FOR HUMAN EXPOSURE

Researchers at the University of Delaware (D.M. Di Toro, principal investigator) are conducting research to develop models for predicting the toxicity and mobilization of individual metals (including manganese) and metal mixtures in sediments. These predictions are critical in evaluating the risk associated with contaminated sediments at Superfund sites.

Thomas R. Guilarte and co-workers at Johns Hopkins University are studying the behavioral and neuropathological changes that occur as a result of chronic exposure to low levels of manganese. The findings from the proposed studies will be used to aid in understanding the mechanism(s) of chronic, low-level manganese neurotoxicity. Moreover, these data will identify sensitive markers for the early detection of manganese neurotoxicity that can be used *in vivo* in humans.

Wei Zheng and co-workers at Purdue University are studying the biomarkers for early diagnosis of manganese toxicity among Chinese smelting workers. They plan to combine exposure indices and biological effects into one parameter for quick clinical assessment of manganese toxicity. They are also conducting clinical trials to investigate the efficacy of para-aminosalicylic acid in treatment of severe manganese. Advanced MRI and MRS techniques along with molecular biotechnology have been used in these studies.

Donald Smith and co-workers at the University of California, Santa Cruz are studying the effect that early manganese exposure in neonatal rats has on neurobehavioral and neurocognitive deficits and comparing these data with epidemiological studies in children.



## 7. ANALYTICAL METHODS

The purpose of this chapter is to describe the analytical methods that are available for detecting, measuring, and/or monitoring manganese, its metabolites, and other biomarkers of exposure and effect to manganese. The intent is not to provide an exhaustive list of analytical methods. Rather, the intention is to identify well-established methods that are used as the standard methods of analysis. Many of the analytical methods used for environmental samples are the methods approved by federal agencies and organizations such as EPA and the National Institute for Occupational Safety and Health (NIOSH). Other methods presented in this chapter are those that are approved by groups such as the Association of Official Analytical Chemists (AOAC) and the American Public Health Association (APHA). Additionally, analytical methods are included that modify previously used methods to obtain lower detection limits and/or to improve accuracy and precision.

The most common analytical procedures for measuring manganese levels in biological and environmental samples use the methods of atomic absorption spectroscopy (AAS) and atomic emission spectroscopy (AES). In AAS analysis, the sample is aspirated into a flame or in a graphite furnace (GFAAS) until the element atomizes (Tsalev 1983). The ground-state atomic vapor absorbs monochromatic radiation from a source and a photoelectric detector measures the intensity of radiation absorbed at 279.5 nm (Tsalev 1983). Furnace atomic absorption analysis is often used for very low analyte levels and for the analysis of solid samples or slurries (Baruthio et al. 1988). Inductively coupled plasma-atomic emission spectrometry (ICP-AES) analysis is frequently employed for multianalyte analyses that include manganese. Neutron activation analysis is also a very effective method for determining manganese concentrations in different samples (Rose et al. 1999). This technique uses no reagents and a minimum of sample handling; thus, potential contamination with exogenous sources of manganese can be avoided. In addition, the technique has a low detection limit in biological tissues (4 ng/g) and high precision. Further, the technique can be used for environmental samples as well as biological samples. Other methods for measuring manganese include spectrophotometry, mass spectrometry, neutron activation analysis, and x-ray fluorimetry.

It is important to note that none of these methods distinguish between different oxidation states of manganese or between different manganese compounds. Thus, monitoring data on manganese are nearly always available only as total manganese present.

## 7. ANALYTICAL METHODS

Levels of organometallic species in environmental and toxicological samples are typically in ppb concentrations, ng/mL in solution, or ng/g in solids (Walton et al. 1991). Therefore, methods of determination must be both selective and sensitive, achieved usually by coupling liquid or gas chromatography (GC) with detection via electrochemical, mass spectrometry, and atomic spectrometry detectors. A number of analytical methods for quantifying MMT in gasoline have been described, including simple determination of total elemental manganese by atomic absorption and gas chromatography followed by flame-ionization detection (FID). These methods usually measure MMT by detecting the metallic portion of the compound and reporting detection of MMT as manganese.

X-ray absorption near edge structure (XANES) and x-ray absorption fine structure (XAFS) spectroscopy have been used for the analysis of manganese-containing particulates emitted from automobile exhaust containing MMT (Mölders et al. 2001; Ressler et al. 2000). These methods are particularly useful in determining the chemical speciation and valence state of manganese or other metal complexes attached to particulate matter.

### 7.1 BIOLOGICAL MATERIALS

Normally, determination of manganese in biological materials requires digestion of the organic matrix prior to analysis. For tissue samples or feces (detection limits ranging from 0.2 to <1 µg/g), this is usually done by treatment with an oxidizing acid mixture such as 3:1:1 (v/v/v) nitric:perchloric:sulfuric acid mixture (Kneip and Crable 1988a). Fluid samples such as blood, saliva, or urine may be digested in the same way (blood, detection limits=1 µg/100 g, 10 µg/L), or manganese can be extracted by an ion exchange resin (urine, detection limit=0.5–2 µg/L) or by chelating agents such as cupferon in methylisobutylketone (urine, detection limit=<1 µg/L). A method for directly measuring concentrations of trace elements in hair that does not require digestion prior to analysis has been developed (Stupar and Dolinsek 1996). While the authors used their technique to determine chromium, lead, and cadmium levels in hair, it is assumed that their slurry sampling or direct solid sampling technique might also work for manganese determination. Table 7-1 summarizes some of the methods used for sample preparation and analysis of manganese in biological materials. It is important to note that special care is needed to avoid contamination of biological materials with exogenous manganese, especially for samples with low levels of manganese (Tsalev 1983; Versieck et al. 1988).

GC-FID may be used to determine levels of MMT in biological tissues and fluids with a detection limit of 1–2 ppm and percent recovery of 93.5–102.7% (Hanzlik et al. 1979).

## 7. ANALYTICAL METHODS

**Table 7-1. Analytical Methods for Determining Manganese in Biological Materials<sup>a</sup>**

| Sample matrix                       | Preparation method  | Analytical method                                     | Sample detection limit  | Percent recovery | Reference                             |
|-------------------------------------|---|---|---|------------------|---------------------------------------|
| Urine                               | Extraction into methylisobutyl-ketone as the cupferon chelate   | AAS (furnace technique)                               | <1 µg/L <sup>b</sup>  | No data          | Baselt 1988                           |
| Urine                               | Extract with resin, ash resin   | ICP-AES   | <1 µg/L <sup>b</sup>  | 100±10           | NIOSH 1984d                           |
| Blood                               | Acid digestion  | ICP-AES   | 1 µg/dL   | 98±2.1           | Kneip and Craple 1988a                |
| Blood                               | Digestion in oxidizing acid   | ICP-AES   | 1 µg/100 g  | 98±2.1           | NIOSH 1984c                           |
| Tissue                              | Digestion in oxidizing acid   | ICP-AES   | 0.2 µg/g  | 98±2.1           | NIOSH 1984c                           |
| Tissue                              | Acid digestion  | ICP-AES   | 0.2 µg/g  | 104±5.6          | Kneip and Craple 1988a                |
| Feces                               | Dry at 110 °C, ash at 550 °C, dissolve in nitric acid   | AAS (furnace technique)                               | <1 µg/g   | 102±7            | Friedman et al. 1987                  |
| Hair                                | Digestion in concentrated nitric:perchloric acid (3:1) mixture  | Flameless AAS   | <0.2 µg/g   | No data          | Collipp et al. 1983                   |
| Hair                                | (a) slurry sample introduction technique (hair powder added to twice distilled water to measure bulk hair trace elements, or (b) direct introduction of hair segments to measure longitudinal gradients | ETAAS (furnace technique)                             | No data   | No data          | Stupar and Dolinsek 1996 <sup>c</sup> |
| Methods for determination of MnDPDP |   |   |   |                  |                                       |
| Human plasma                        | Mix heparinized blood samples of patients receiving MnDPDP via injection with solid trisodium phosphate dodecahydrate pH 10.0±0.2; ultrafiltrate  | Mixed-bed resin HPLC-anion exchange and reverse-phase | 0.8–2.3 µM (manganese compounds)<br>0.1–0.8 µM (zinc compounds) of 50 µL injection volume | 85–115           | Toft et al. 1997a                     |

<sup>a</sup>Magnetic resonance imaging (MRI) has been useful in determining brain accumulation of manganese, but is not a quantitative method; therefore, it is not listed as an entry in this table.

<sup>b</sup>Estimated from sensitivity and linearity data

<sup>c</sup>Methods were used to determine levels of chromium, lead, and cadmium in hair. Manganese concentrations in hair were evaluated for some, but not all, of the samples and tested one, but not both, new methods. However, it is assumed that both techniques will work for the trace element manganese.

AAS = atomic absorption spectroscopy; HPLC = high performance liquid chromatography; ICP-AES = inductively coupled-plasma atomic emission spectroscopy; MnDPDP = mangafodipir; NIOSH = National Institute for Occupational Safety and Health

## 7. ANALYTICAL METHODS

Walton et al. (1991) have described high performance liquid chromatography (HPLC) coupled with laser-excited atomic fluorescence spectrometry (LEAFS) to detect various species of MMT. The detection limit for this GC-LEAFS method ranged from 8 to 20 pg of manganese for the various organomanganese species; the detection limit for determining manganese in MMT was 0.4 ng/mL. This limit of detection was several orders of magnitude better than those for HPLC with ultraviolet (UV) detection or HPLC-atomic fluorescence spectrometry (AFC) (Walton et al. 1991), but was worse than detection by GC-FID (DuPuis and Hill 1979). Walton et al. (1991) used their method to determine manganese species present in rat urine after rats had been administered MMT prepared in propylene glycol via subcutaneous injection.

Table 7-1 summarizes some common methods for the determination of manganese in various types of biological materials.

## 7.2 ENVIRONMENTAL SAMPLES

Manganese in air exists as particulate matter, so sampling is done by drawing air through a filter in order to collect the suspended particles. A variety of filter types (e.g., glass fibers and cellulose acetate) and sampling devices (e.g., low volume, high volume, and dichotomous) are available, depending on the particle sizes of concern and the concentration range of interest. In some cases, material on the filter may be analyzed directly (e.g., by x-ray fluorescence), or the filter may be digested by ashing in acid prior to analysis. In general, sensitivity is dependent on the volume of air drawn through the filter prior to analysis, and typically, detection limits are 1–2 µg/sample.

Several analytical methods from the EPA Office of Solid Waste publication SW-846, entitled *Test Methods for Evaluating Solid Waste, Physical/Chemical Methods* are applicable for analyzing manganese in water, soil, and wastes. In addition, the EPA Emission Measurement Center (EMS) and Office of Water (OW) have standardized methods for the measurement of manganese and other metals in environmental media. Several of these methods, including the analytical instrumentation and detection limits, are summarized in Table 7-2.

Water may either be analyzed directly, or, if the concentration of manganese is low, a concentration step (e.g., evaporation, extraction, and binding to a resin) may be employed (detection limits ranging from 0.005–50 µg/L). In all cases, acid is added to the sample to prevent precipitation of manganese.

## 7. ANALYTICAL METHODS

**Table 7-2. Analytical Methods for Determining Manganese in Environmental Samples**

| Sample matrix                         | Preparation method  | Analytical method                       | Sample detection limit                           | Percent recovery                          | Reference               |
|---------------------------------------|---|---|--|---|-------------------------|
| Air                                   | Collect sample on MCE or PVC filter, followed by nitric/perchloric acid ashing  | Method 7300 (ICP-AES)                   | 0.2 mg/m <sup>3</sup>                            | 94.7–101 (MCE)<br>99.3–101.9 (PVC)        | NIOSH 2003a             |
| Air                                   | Collect sample on MCE filter, followed by hot block/HCl/HNO <sub>3</sub> digestion  | Method 7303 (ICP-AES)                   | 1.2 mg/m <sup>3</sup>                            | No data                                   | NIOSH 2003b             |
| Air                                   | Collect sample on MCE or PVC filter, followed by aqua regia ashing  | Method 7301 (ICP-AES)                   | 0.2 mg/m <sup>3</sup>                            | 91.2–103.5 (MCE)<br>77.4–93.4 (PVC)       | NIOSH 2003c             |
| Water                                 | Acidify with nitric acid  | AAS (furnace technique)                 | 0.2 µg/L   | No data                                   | EPA 1983b               |
| Water                                 | Acidify with nitric acid  | AAS (flame)<br>AAS (furnace)<br>ICP-AES | 2 µg/L<br>0.01 µg/L<br>1 µg/L                    | No data<br>No data<br>No data             | Taylor 1982             |
| Water                                 | Acidify with nitric acid  | Method 311 (AAS)                        | <10 µg/L   | No data                                   | APHA 1998a              |
| Water                                 | Filter and acidify filtrate with HNO <sub>3</sub> and analyze   | Method 3113A (AAS furnace technique)    | 0.2 µg/L   | No data                                   | APHA 1998b              |
| Water                                 | Digest sample with HNO <sub>3</sub> /HCl and analyze  | Method 3120B (ICP-AES)                  | 2 µg/L   | No data                                   | APHA 1998c              |
| Water                                 | Acidify with nitric acid  | AAS (direct aspiration)                 | 10 µg/L  | 100±2 <sup>a</sup>                        | EPA 1983a               |
| Water                                 | Acid digest and analyze   | Method 3125A (ICP-MS)                   | 0.002 µg/L                                       | 91.81–110                                 | APHA 1998d              |
| Water                                 | Preconcentration manganese-containing solution and 3,3',5,5'-tetramethylbenzidine (TMB) onto filter paper; add oxidant KIO <sub>4</sub> to catalyze oxidation; measure absorbance | Catalytic kinetic method of analysis    | 0.005 µg/L                                       | No data                                   | Beklemishev et al. 1997 |
| Water, waste water, sludge, and soils | For dissolved constituents: filter, acidify filtrate, and analyze; for samples containing solids: digestion with HNO <sub>3</sub> /HCl prior to analysis                          | Method 200.8 (ICP-MS)                   | 0.01–0.04 µg/L (liquids);<br>0.05 mg/kg (solids) | 95.8–96.9 (water);<br>95.2–103.6 (wastes) | EPA 1994b               |

## 7. ANALYTICAL METHODS

**Table 7-2. Analytical Methods for Determining Manganese in Environmental Samples**

| Sample matrix                 | Preparation method   | Analytical method            | Sample detection limit  | Percent recovery | Reference                 |
|-------------------------------|--|------------------------------|---|------------------|---------------------------|
| Water and wastes              | Acid digestion   | AAS                          | 10 µg/L   | 100±2            | EPA 1986c                 |
| Water, solids, sediment,      | For dissolved constituents: filter, acidify filtrate, and analyze; for samples containing solids: digestion with HNO <sub>3</sub> /HCl prior to analysis | Method 6010C (ICP-AES)       | 0.93 µg/L   | No data          | EPA 2007a                 |
| Foods                         | Digest wet or dry foods with HNO <sub>3</sub> -H <sub>2</sub> SO <sub>4</sub> mixture (12:2 mL)  | AAS (flame)<br>AAS (furnace) | AAS (flame):<br>0.15 mg/kg<br>AAS (furnace):<br>1.10 µg/kg  | No data          | Tinggi et al. 1997        |
| Foods                         | Digestion with nitric, sulfuric, perchloric acid solution  | ICP-AES                      | 0.2 mg/kg   | 96.2–97          | Capar and Cunningham 2000 |
| Methods for MMT determination |  |                              |   |                  |                           |
| Air                           | Draw known volume of air through XAD-2 sampling tubes for 10–60 minutes  | GC-ECD                       | 0.001 mg/m <sup>3</sup> (in 10-L sample);<br>0.02 ng from a 2.0 µL injection of a 0.01 µg/mL MMT solution | No data          | Gaind et al. 1992         |
| Gasoline                      | Dilute gasoline in acetone (1:10)  | Capillary GC-ACP detector    | 62 pg/s   | No data          | Ombaba and Barry 1994     |
| Gasoline                      | Dilute with hexane (1:99); direct injection  | GC-ECD                       | No data   | No data          | Gaind et al. 1992         |
| Gasoline                      | Inject sample  | GC-MED                       | 0.25 pg/s   | No data          | Quimby et al. 1978        |
| Gasoline                      | Inject sample  | GC-FPD                       | 0.6 ppm   | No data          | Aue et al. 1990           |

<sup>a</sup>Percent recovery at manganese concentration >80 µg/L; at lower concentrations (10–20 µg/L), percent recoveries were >120%.

AAS = atomic absorption spectrometry; ACP = alternating current plasma; AES = atomic emission spectroscopy; APDC = ammonium pyrrolidine dithiocarbamate; APHA = American Public Health Association; ECD = electron-capture detection; EPA = Environmental Protection Agency; FPD = flame photometric detection; GC = gas chromatography; ICP = inductivity coupled plasma; MCE = mixed cellulose ester; MED = microwave emission detector; MS = mass spectrometry; NIOSH = National Institute for Occupational Safety and Health; PVC = polyvinyl chloride; XRF = x-ray fluorescence

## 7. ANALYTICAL METHODS

Beklemishev et al. (1997) measured the concentrations of manganese in tap and river water. Their analytical method relies on an indicator reaction that is catalyzed by Mn(II) (the oxidation of 3,3',5,5'-tetramethylbenzidine [TMB] by potassium periodate [KIO<sub>4</sub>]) and is carried out on the surface of a paper-based sorbent. The advantages of this novel technique are that it has a much lower detection limit (0.005 µg/L) than do established methods and is transportable, allowing it to be used for rapid tests in the field (i.e., spot tests and similar procedures).

Determination of manganese levels in soils, sludges, or other solid wastes requires an acid extraction/digestion step prior to analysis. The details vary with the specific characteristics of the sample, but usually treatment will involve heating in nitric acid, oxidation with hydrogen peroxide, and filtration and/or centrifugation to remove insoluble matter.

Manganese levels in foods have been determined in order to define more clearly human dietary requirements or levels of absorption of manganese from the diet (Tinggi et al. 1997). Atomic absorption spectrometry has been the most widely used analytical technique to determine manganese levels in a broad range of foods, as well as other environmental and biological samples (Tinggi et al. 1997). Tinggi et al. (1997) contributed a wet digestion technique using a 12:2 (v/v) nitric:sulfuric acid mixture for their determination, and for food samples with low levels of manganese, they found that the more sensitive graphite furnace atomic absorption analysis was required. Because manganese is often found at very low levels in many foods, its measurement requires methods with similarly low detection limits; these researchers identified detection limits of 0.15 mg/kg (ppm) and 1.10 µg/kg (ppb) for flame and graphite furnace atomic absorption spectrometry, respectively (Tinggi et al. 1997). Neutron activation analysis is an effective technique for measuring manganese in environmental samples; it provides a low detection limit and high precision (Kennedy 1990).

A number of analytical methods for quantifying MMT in gasoline have been described including simple determination of total elemental manganese by atomic absorption (Smith and Palmby 1959) and gas chromatography followed by FID (DuPuis and Hill 1979). The former has measured manganese concentrations from 0.1 to 4 g/gallon of gasoline after dilution of the sample with isooctane to minimize the effects of differences in base stock composition and is accurate to about 3% of the amount of manganese present. The latter has an absolute detection limit of  $1.7 \times 10^{-14}$  g/sample (0.017 pg/s) and could easily measure 6 mg/gallon of manganese in a gasoline sample; it is one of the most sensitive approaches. Aue et al. (1990) described a method in which MMT is detected in gasolines by gas chromatography coupled with flame photometric detection (FPD); the chemiluminescence of manganese

## 7. ANALYTICAL METHODS

is measured to determine MMT levels in a method that uses simple, inexpensive, and commercially available instrumentation. MMT levels can be determined down to 0.6 ppm (w/w) in gasoline (Aue et al. 1990). In another method showing excellent performance, Quimby et al. (1978) used GC followed by atmospheric pressure helium microwave detection system (or microwave emission detector [MED]); this method has a high degree of selectivity ( $1.9 \times 10^6$ ) and a detection limit of 0.25 pg/s at a wavelength of 257.6 nm.

GC followed by electron-capture detection (ECD) (Gaind et al. 1992) or alternating current plasma (ACP) emission detection (Ombaba and Barry 1994) (detection limit: 62 pg as manganese) has also been described for determination of MMT in gasoline. GC followed by ACP emission detection has been described for detecting MMT in air samples; airborne MMT concentrations as low as  $0.001 \text{ mg/m}^3$  can be measured (Ombaba and Barry 1994).

Table 7-2 summarizes some common methods for the determination of manganese in various types of environmental media.

### 7.3 ADEQUACY OF THE DATABASE

Section 104(i)(5) of CERCLA, as amended, directs the Administrator of ATSDR (in consultation with the Administrator of EPA and agencies and programs of the Public Health Service) to assess whether adequate information on the health effects of manganese is available. Where adequate information is not available, ATSDR, in conjunction with NTP, is required to assure the initiation of a program of research designed to determine the health effects (and techniques for developing methods to determine such health effects) of manganese.

The following categories of possible data needs have been identified by a joint team of scientists from ATSDR, NTP, and EPA. They are defined as substance-specific informational needs that if met would reduce the uncertainties of human health assessment. This definition should not be interpreted to mean that all data needs discussed in this section must be filled. In the future, the identified data needs will be evaluated and prioritized, and a substance-specific research agenda will be proposed.



## 7. ANALYTICAL METHODS

**7.3.1 Identification of Data Needs****Methods for Determining Biomarkers of Exposure and Effect**

**Exposure.** Sensitive and selective methods are available for the detection and quantitative measurement of manganese in blood, urine, hair, feces, and tissues (Baselt 1988; Collipp et al. 1983; Friedman et al. 1987; Kneip and Crable 1988a; NIOSH 1984c, 1984d). Since levels in biological samples are generally rather low, sample contamination with exogenous manganese can sometimes occur (Tsalev 1983; Versieck et al. 1988). Development of standard methods for limiting this problem would be useful. Measurement of average manganese concentrations in these materials has proved useful in comparing groups of occupationally exposed people to nonexposed people (Roels et al. 1987b), but has not been especially valuable in evaluating human exposure in individuals (Rehnberg et al. 1982). This is due to the inherent variability in intake levels and toxicokinetics of manganese in humans, rather than a limitation in the analytical methods for manganese. Smith et al. (2007) have discussed the limitations of using blood and urine levels of manganese as biomarkers of exposure and have suggested further investigation of using manganese levels in teeth and hair as exposure biomarkers. The use of tooth enamel as a potential biomarker has been explored by Ericson et al. (2007). Josephs et al. (2005) have also discussed the limitations of using manganese levels in serum or urine as a direct measure of exposure since free manganese does not accumulate in the circulatory system. Magnetic resonance imaging (MRI) in conjunction with analysis of manganese in whole blood (MnB), plasma (MnP), or red blood cells has been used in the diagnosis of manganism in humans (Jiang et al. 2007). Development of additional noninvasive methods for measuring whole-body or tissue-specific manganese burdens would be valuable in estimating human exposure levels, but would be limited by the same considerations of individual variability that limit existing methods.

There is a need to evaluate the accuracy and reproducibility of analytical measures of manganese in biological media, so that analytical variability is not inappropriately incorporated into natural biological variability in reported data, as may now be the case.

**Effect.** No reliable biomarkers of manganese effect are known. Biochemical changes such as altered blood or urinary levels of steroids, neurotransmitters, or their metabolites are plausible biomarkers of exposure, but this possibility has not been thoroughly investigated. Although methods exist for the analysis of these biochemicals, further work to improve the analyses does not seem warranted unless the utility of this approach is established.

## 7. ANALYTICAL METHODS

**Methods for Determining Parent Compounds and Degradation Products in Environmental Media.** All humans are exposed to manganese, primarily through food (EPA 1984). Near a hazardous waste site that contains manganese or a factory that uses manganese, humans could receive above-average exposure by inhalation of air or ingestion of water, soil, or food. Methods exist for the analysis of manganese in air (NIOSH 2003a, 2003b, 2003c), water (APHA 1998a, 1998b, 1998c, 1998d; EPA 1994b, 2007a), and soils and sediment (EPA 2007a). Methods are also available to analyze manganese in food (Capar and Cunningham 2000; Tinggi et al. 1997).

### 7.3.2 Ongoing Studies

The Federal Research in Progress (FEDRIP 2008) database provides additional information obtainable from a few ongoing studies that may fill in some of the data needs pertinent to the analysis of manganese in biological or environmental samples. Donald Smith and co-workers at the University of California, Santa Cruz are studying the role of manganese in neurodegenerative disease using particle induced x-ray emission (PIXE) analyses of *in situ* brain regional manganese levels of rodents (FEDRIP 2008). Carmen Enid Martinez and co-workers at Pennsylvania State University are studying the elemental distribution in soil particles using novel techniques that include synchrotron-based microprobe- x-ray fluorescence (XRF) and x-ray diffraction (XRD) in addition to scanning electron microscopy coupled to energy or wavelength dispersive x-ray analysis (SEM/E-W-DS). Metal solubility measurements are to be studied by inductively coupled plasma emission spectroscopy (ICP), anodic/cathodic stripping voltammetry (A/C-SV), and ion-selective electrodes (ISE).

## 8. REGULATIONS, ADVISORIES, AND GUIDELINES

MRLs are substance-specific estimates, which are intended to serve as screening levels, are used by ATSDR health assessors and other responders to identify contaminants and potential health effects that may be of concern at hazardous waste sites.

An MRL of  $3 \times 10^{-4}$  mg manganese/m<sup>3</sup> (0.3 µg manganese/m<sup>3</sup>) in respirable dust has been derived for chronic inhalation exposure to manganese. As discussed in Appendix A, dichotomous models in the EPA Benchmark Dose software were fit to the incidence data for abnormal eye-hand coordination scores in battery workers exposed to respirable manganese (Roels et al. 1992). The model with the lowest AIC was selected as the best fitting model, and the BMCL<sub>10</sub> from this model, 142 µg respirable manganese/m<sup>3</sup>, was selected as the point of departure for the chronic inhalation MRL. The MRL of 0.3 µg respirable manganese/m<sup>3</sup> was derived by adjusting the point of departure to a continuous exposure basis ( $142 \times 5/7 \times 8/24$ ) and dividing by an uncertainty factor of 100:

- 10 for uncertainty about human variability including possibly enhanced susceptibility of the elderly, infants, and children; individuals with chronic liver disease or diminished hepatobiliary function; and females and individuals with iron deficiency; and
- 10 for limitations/uncertainties in the database including the lack of epidemiological data for humans chronically exposed to soluble forms of manganese and the concern that the general population may be exposed to more soluble forms of manganese than most of the manganese-exposed workers in the principal and supporting studies and the uncertainty that a factor of 10 for human variability will provide enough protection for manganese effects on brain development in children. In addition, data on developmental toxicity for this route and duration of exposure are lacking. There is limited information on reproductive effects in females (one study in rat dams) and reported effects on male reproductive organs have not been clearly associated with decreased reproductive function. Though it is clear that the neurological system is the target organ for effects from chronic-duration inhalation exposure to manganese, data are lacking to fully characterize the potential risk for all organ systems from chronic inhalation exposure.

No oral MRLs were derived for acute-, intermediate-, or chronic-duration oral exposure to manganese, but an interim guidance value of 0.16 mg manganese/kg/day, based on the Tolerable Upper Intake Level for adults of 11 mg manganese/day (established by the U.S. Food and Nutrition Board/Institute of Medicine [FNB/IOM 2001]) is recommended to be used for ATSDR public health assessments of oral exposure to inorganic forms of manganese. The interim guidance value is necessary because of the prevalence of manganese at hazardous waste sites and the fact that manganese is an essential nutrient. It is recommended to be used until more information on actual intake levels across environmental media can be obtained.

## 8. REGULATIONS, ADVISORIES, AND GUIDELINES

The EPA derived a chronic inhalation RfC of  $5 \times 10^{-5}$  mg/m<sup>3</sup> for respirable manganese (IRIS 2008). This value is based on the LOAEL of 0.15 mg/m<sup>3</sup> from a study of battery workers exposed to manganese dioxide (Roels et al. 1992). EPA verified this assessment in 1993. The LOAEL was calculated by dividing the geometric mean concentration of the lifetime-integrated respirable dust concentration for the exposed workers by the average duration of employment in the facility. EPA calculated the RfC by adjusting for continuous exposure and dividing by an uncertainty factor of 1,000 (10 for use of a LOAEL, 10 to protect sensitive individuals, and 10 for database limitations reflecting both the less-than-chronic periods of exposure and the lack of developmental data, as well as potential, but unquantified, differences in the toxicity of different forms of manganese). The estimated breathing rate in the exposed workers was assumed to be 10 m<sup>3</sup>/workday.

The EPA (IRIS 2008) derived an oral reference dose (RfD) value of 0.14 mg/kg/day manganese from all oral exposures. As of August 2008, this value was last updated in May 1996. The agency suggested using a modifying factor of 1 if the manganese is ingested in food and a modifying factor of 3 if the element is ingested in water or soil. The RfD was developed using a previous determination of the upper range of total dietary intake of 10 mg/day. The modifying factor of 1 was based on composite data on chronic human NOAELs from the World Health Organization (WHO 1973) (0.11–0.13 mg/kg/day), the National Academy of Sciences/National Research Council (1989) “safe and adequate level” (0.04–0.07 mg/kg/day), and a study by Freedland-Graves et al. (1994) concerning nutritional requirements for manganese. The FNB/IOM (2001) re-established an Adequate Intake (AI) value for manganese for men and women at 2.3 and 1.8 mg manganese/day, respectively (for 70-kg individuals, this would result in exposures of 0.033 and 0.026 mg manganese/kg/day, respectively). A Tolerable Upper Intake Level (UL) of 11 mg/day was also set by the FNB/IOM (2001) for adults based on a NOAEL for Western diets (approximately 0.16 mg manganese/kg/day assuming a 70-kg body weight).

The international and national regulations, advisories, and guidelines regarding manganese in air, water, and other media are summarized in Table 8-1.

## 8. REGULATIONS, ADVISORIES, AND GUIDELINES

**Table 8-1. Regulations, Advisories, and Guidelines Applicable to Manganese**

| Agency                      | Description  | Information   | Reference  |
|-----------------------------|--|---|------------|
| <u>INTERNATIONAL</u>        |  |   |            |
| Guidelines:                 |  |   |            |
| IARC                        | Carcinogenicity classification                                   | No data   | IARC 2008  |
| WHO                         | Air quality guidelines<br>Manganese <sup>a</sup>                 | 0.15 µg/m <sup>3</sup>  | WHO 2000a  |
|                             | Drinking water quality guidelines<br>Manganese <sup>b</sup>      | 0.4 mg/L  | WHO 2004a  |
| <u>NATIONAL</u>             |  |   |            |
| Regulations and Guidelines: |  |   |            |
| a. Air                      |  |   |            |
| ACGIH                       | TLV (8-hour TWA)   |   | ACGIH 2007 |
|                             | Manganese  | 0.2 mg/m <sup>3</sup>   |            |
|                             | MMT <sup>c</sup>   | 0.2 mg/m <sup>3</sup>   |            |
|                             | TLV basis (critical effects)                                     |   |            |
|                             | Manganese  | Central nervous system impairment                                 |            |
|                             | MMT  | Central nervous system impairment, lung, liver, and kidney damage |            |
| EPA                         | Second list of AEGL priority chemicals for guideline development |   | EPA 2008a  |
|                             | Manganese  | Yes   |            |
|                             | MMT  | Yes   |            |
| NIOSH                       | Category of pesticides   |   | NIOSH 1992 |
|                             | Potassium permanganate   | Group 1 pesticide   |            |
|                             | REL (10-hour TWA)  |   | NIOSH 2005 |
|                             | Manganese  | 1 mg/m <sup>3</sup>   |            |
|                             | Manganese (II,III) oxide <sup>d</sup>                            | Not established   |            |
|                             | MMT <sup>e</sup>   | 0.2 mg/m <sup>3</sup>   |            |
|                             | STEL (15-minute TWA)   |   |            |
|                             | Manganese  | 3 mg/m <sup>3</sup>   |            |
|                             | IDLH   |   |            |
|                             | Manganese  | 500 mg/m <sup>3</sup>   |            |
|                             | Target organs  |   |            |
|                             | Manganese  | Respiratory system, central nervous system, blood, and kidneys    |            |
|                             | Manganese (II,III) oxide   | Respiratory system, central nervous system, blood, and kidneys    |            |

## 8. REGULATIONS, ADVISORIES, AND GUIDELINES

**Table 8-1. Regulations, Advisories, and Guidelines Applicable to Manganese**

| Agency  | Description   | Information                                      | Reference                                 |
|---|---|--|---|
| <b>NATIONAL (cont.)</b>   |   |  |   |
| NIOSH   | Target organs (cont.)   |  |   |
|   | MMT   | Eyes, central nervous system, liver, and kidneys |   |
| OSHA  | PEL (8-hour TWA) for general industry (ceiling limit)   |  | OSHA 2007c<br>29 CFR 1910.1000, Table Z-2 |
|   | Manganese (compounds and fume)  | 5 mg/m <sup>3</sup>                              |   |
|   | PEL (8-hour TWA) for shipyard industry (ceiling limit)  |  | OSHA 2007a<br>29 CFR 1915.1000            |
|   | Manganese (compounds and fume)  | 5 mg/m <sup>3</sup>                              |   |
|   | PEL (8-hour TWA) for construction industry (ceiling limit)  |  | OSHA 2007b<br>29 CFR 1926.55, Appendix A  |
|   | Manganese (compounds and fume)  | 5 mg/m <sup>3</sup>                              |   |
| b. Water  |   |  |   |
| EPA   | Designated as hazardous substances in accordance with Section 311(b)(2)(A) of the Clean Water Act |  | EPA 2008b<br>40 CFR 116.4                 |
|   | Potassium permanganate  | Yes  |   |
|   | Drinking water contaminant candidate list   |  | EPA 1998                                  |
|   | Manganese   | Yes  |   |
|   | Drinking water standards and health advisories  |  | EPA 2006a                                 |
|   | Manganese   |  |   |
|   | 1-Day health advisory for a 10-kg child   | 1 mg/L   |   |
|   | 10-Day health advisory for a 10-kg child  | 1 mg/L   |   |
|   | DWEL  | 1.6 mg/L   |   |
|   | Lifetime  | 0.3 mg/L   |   |
|   | National recommended water quality criteria   |  | EPA 2006c                                 |
|   | Manganese <sup>f</sup>  |  |   |
|   | Human health for consumption of water + organism  | 0.05 mg/L  |   |
|   | Human health for consumption of organism only   | 0.1 mg/L   |   |
| National secondary drinking water standards   |   | EPA 2003b  |   |
| Manganese <sup>g</sup>  | 0.05 mg/L   |  |   |
| Reportable quantities of hazardous substances designated pursuant to Section 311 of the Clean Water Act |   | EPA 2008d<br>40 CFR 117.3                        |   |
| Potassium permanganate  | 100 pounds  |  |   |

## 8. REGULATIONS, ADVISORIES, AND GUIDELINES

**Table 8-1. Regulations, Advisories, and Guidelines Applicable to Manganese**

| Agency                  | Description   | Information                          | Reference      |
|-------------------------|---|--------------------------------------|----------------|
| <b>NATIONAL (cont.)</b> |   |                                      |                |
| <b>c. Food</b>          |   |                                      |                |
| EPA                     | Inert ingredients permitted for use in nonfood use pesticide products |                                      | EPA 2008e      |
|                         | Mn(II) carbonate  | Yes                                  |                |
|                         | Manganese dioxide   | Yes                                  |                |
|                         | Manganese sulfate   | Yes                                  |                |
|                         | Potassium permanganate  | Yes                                  |                |
| FDA                     | Bottled drinking water  |                                      | FDA 2007a      |
|                         | Manganese   | 0.05 mg/L                            | 21 CFR 165.110 |
|                         | EAFUS <sup>n</sup>  |                                      | FDA 2008       |
|                         | Potassium permanganate  | Yes                                  |                |
|                         | Indirect food additives: adhesives and components of coatings         |                                      | FDA 2007b      |
|                         | Potassium permanganate  | Yes                                  | 21 CFR 175.105 |
| <b>d. Other</b>         |   |                                      |                |
| ACGIH                   | Carcinogenicity classification  |                                      | ACGIH 2007     |
|                         | Manganese   | No data                              |                |
|                         | MMT   | No data                              |                |
| DEA                     | Records and reports of listed chemicals                               |                                      | DEA 2007       |
|                         | Potassium permanganate  | List II chemical                     | 21 CFR 1310.02 |
| EPA                     | Carcinogenicity classification  |                                      | IRIS 2008      |
|                         | Manganese   | Group D <sup>l</sup>                 |                |
|                         | RfC   |                                      |                |
|                         | Manganese   | 5x10 <sup>-5</sup> mg/m <sup>3</sup> |                |
|                         | RfD   |                                      |                |
|                         | Manganese   | 0.14 mg/kg/day                       |                |
|                         | Superfund, emergency planning, and community right-to-know            |                                      |                |
|                         | Designated CERCLA hazardous substance                                 |                                      | EPA 2008c      |
|                         | Manganese <sup>l</sup>  | Yes                                  | 40 CFR 302.4   |
|                         | Potassium permanganate <sup>k</sup>                                   | Yes                                  |                |
|                         | Reportable quantity   |                                      |                |
|                         | Manganese   | None <sup>l</sup>                    |                |
|                         | Potassium permanganate  | 100 pounds                           |                |
|                         | Effective date of toxic chemical release reporting                    |                                      | EPA 2008g      |
|                         | Manganese   | 01/01/1987                           | 40 CFR 372.65  |

## 8. REGULATIONS, ADVISORIES, AND GUIDELINES

**Table 8-1. Regulations, Advisories, and Guidelines Applicable to Manganese**

| Agency                           | Description   | Information | Reference                              |
|----------------------------------|---|-------------|--|
| <b>NATIONAL</b> ( <i>cont.</i> ) |   |             |  |
| EPA                              | Superfund, emergency planning, and community right-to-know<br>Extremely Hazardous Substances<br>MMT |             | EPA 2008f<br>40 CFR 355,<br>Appendix A |
|                                  | Reportable quantity   | 100 pounds  |  |
|                                  | Threshold planning quantity   | 100 pounds  |  |
| NTP                              | Carcinogenicity classification  | No data     | NTP 2005                               |

<sup>a</sup>TWA based on effects other than cancer or odor/annoyance using an averaging time of 1 year.

<sup>b</sup>Concentrations of the substance at or below the health-based guideline value may affect the appearance, taste, or odor of the water, resulting in consumer complaints.

<sup>c</sup>Skin designation refers to the potential significant contribution to the overall exposure by the cutaneous route, including mucous membranes and the eyes, by contact with vapors, liquids, and solids.

<sup>d</sup>NIOSH has not established a REL for magnesium oxide fume under the "Proposed Rule on Air Contaminants" (29 CFR 1910, Docket No. H-020) in which NIOSH questioned whether the OSHA PEL for magnesium oxide fume (1 mg/m<sup>3</sup>) was adequate enough to protect workers from potential health hazards (NIOSH 2005).

<sup>e</sup>Skin designation indicates the potential for dermal absorption; skin exposure should be prevented as necessary through the use of good work practices, gloves, coveralls, goggles, and other appropriate equipment.

<sup>f</sup>The human health criteria are based on carcinogenicity of 10<sup>-6</sup> risk. This criterion for manganese is not based on toxic effects, but rather is intended to minimize objectionable qualities such as laundry stains and objectionable tastes in beverages.

<sup>g</sup>National Secondary Drinking Water Standards are non-enforceable guidelines regulating contaminants that may cause cosmetic effects (such as skin or tooth discoloration) or aesthetic effects (such as taste, odor, or color) in drinking water.

<sup>h</sup>The EAFUS list of substances contains ingredients added directly to food that FDA has either approved as food additives or listed or affirmed as GRAS.

<sup>i</sup>Group D: not classifiable as to human carcinogenicity.

<sup>j</sup>Designated CERCLA hazardous substance pursuant to Section 112 of the Clean Air Act.

<sup>k</sup>Designated CERCLA hazardous substance pursuant to Section 311(b)(2) of the Clean Water Act.

<sup>l</sup>No reportable quantity is being assigned to the generic or broad class.

ACGIH = American Conference of Governmental Industrial Hygienists; AEGL = acute exposure guideline levels; CERCLA = Comprehensive Environmental Response, Compensation, and Liability Act; CFR = Code of Federal Regulations; DEA = Drug Enforcement Administration; DWEL = drinking water equivalent level; EAFUS = Everything Added to Food in the United States; EPA = Environmental Protection Agency; FDA = Food and Drug Administration; GRAS = Generally Recognized As Safe; IARC = International Agency for Research on Cancer; IDLH = immediately dangerous to life or health; IRIS = Integrated Risk Information System; MMT = methylcyclopentadienyl manganese tricarbonyl; NIOSH = National Institute for Occupational Safety and Health; NTP = National Toxicology Program; OSHA = Occupational Safety and Health Administration; PEL = permissible exposure limit; REL = recommended exposure limit; RfC = inhalation reference concentration; RfD = oral reference dose; STEL = short-term exposure limit; TLV = threshold limit values; TWA = time-weighted average; WHO = World Health Organization



## 9. REFERENCES

- Abbott PJ. 1987. Methylcyclopentadienyl manganese tricarbonyl (MMT) in petrol: The toxicological issues. *Sci Total Environ* 67:247-255.
- +\*Abdel-Hamid MM, El-Desoky SA, Magdi SM. 1990. Estimation of manganese in blood between exposed workers to different concentrations at industrial units. *Egypt J Pharm Sci* 31:143-150.
- +\*Abrams E, Lassiter JW, Miller WJ, et al. 1976a. Effect of dietary manganese as a factor affecting <sup>54</sup>Mn absorption in rats. *Nutr Rep Int* 14:561-565.
- Abrams E, Lassiter JW, Miller WJ, et al. 1976b. Absorption as a factor in manganese homeostasis. *J Anim Sci* 42:630-636.
- ACGIH. 1998. TLV-Threshold limit values and biological exposure indices for 1996-1997. Cincinnati, OH: American Conference of Governmental Industrial Hygienists.
- \*ACGIH. 2007. Manganese. Threshold limit values for chemical substances and physical agents and biological exposure indices. Cincinnati, OH: American Conference of Governmental Industrial Hygienists, 37.
- Adams RM and Manchester RD. 1982. Allergic contact dermatitis to maneb in a housewife. *Contact Dermatitis* 8:271.
- \*Adinolfi M. 1985. The development of the human blood-CSF-brain barrier. *Dev Med Child Neurol* 27(4):532-537.
- Adkins B, Luginbuhl GH, Gardner DE. 1980a. Biochemical changes in pulmonary cells following manganese oxide inhalation. *J Toxicol Environ Health* 6:445-454.
- +\*Adkins B, Luginbuhl GH, Gardner DE. 1980b. Acute exposure of laboratory mice to manganese oxide. *Am Ind Hyg Assoc J* 41:494-500.
- +\*Adkins B, Luginbuhl GH, Miller FJ, et al. 1980c. Increased pulmonary susceptibility to streptococcal infection following inhalation of manganese oxide. *Environ Res* 23:110-120.
- \*Adlercreutz H. 1995. Phytoestrogens: Epidemiology and a possible role in cancer protection. *Environ Health Perspect Suppl* 103(7):103-112.
- Afsana K, Shiga K, Ishizuka S, et al. 2004. Reducing effect of ingesting tannic acid on the absorption of iron, but not zinc, copper and manganese by rats. *Biosci Biotechnol Biochem* 68(3):584-592.
- Afsar H, Demirata B. 1987. Simple method for distinguishing maneb, zineb, mancozeb, and selected mixtures. *J Assoc Off Anal Chem* 70:923-924.

---

\*Cited in text

+Cited in supplemental document

## 9. REFERENCES

- \*Agency for Toxic Substances and Disease Registry. 1989. Decision guide for identifying substance-specific data needs related to toxicological profiles; Notice. Agency for Toxic Substances and Disease Registry, Division of Toxicology. Fed Regist 54(174):37618-37634.
- \*Agency for Toxic Substances and Disease Registry. 1990. Biomarkers of organ damage or dysfunction for the renal, hepatobiliary, and immune systems. Subcommittee on Biomarkers of Organ Damage and Dysfunction. Atlanta, GA: Agency for Toxic Substances and Disease Registry.
- \*Agency for Toxic Substances and Disease Registry. 1997. Public health assessment. Tobyhanna army depot Coolbaugh township, Monroe County, Pennsylvania. Agency for Toxic Substances and Disease Registry. [http://www.atsdr.cdc.gov/HAC/PHA/toby/tob\\_toc.html](http://www.atsdr.cdc.gov/HAC/PHA/toby/tob_toc.html). August 07, 2008.
- \*Agency for Toxic Substances and Disease Registry. 2003. Public health assessment. Fish and shellfish evaluation Isla de Vieques bombing range. Vieques, Puerto Rico. Agency for Toxic Substances and Disease Registry. <http://www.atsdr.cdc.gov/hac/PHA/viequesfish/viequespr-toc.html>. August 07, 2008.
- Agusa T, Kunito T, Fujihara J, et al. 2006. Contamination by arsenic and other trace elements in tube-well water and its risk assessment to humans in Hanoi, Vietnam. Environ Pollut 139:95-106.
- Ahmad N, Guo L, Mandarakas P, et al. 1996. Headspace gas-liquid chromatographic determination of dithiocarbamate residues in fruits and vegetables with confirmation by conversion to ethylenethiourea. J AOAC International 79:1417-1422.
- Ahn C, Mitsch WJ. 2001. Chemical analysis of soil and leachate from experimental wetland mesocosms lined with coal combustion products. J Environ Qual 30:1457-1463.
- Aihara K, Nishi Y, Hatano S, et al. 1985. Zinc, copper, manganese, and selenium metabolism in patients with human growth hormone deficiency or acromegaly. J Pediatr Gastroenterol Nutr 4:610-618.
- +\*Akbar-Khanzadeh F. 1993. Short-term respiratory function changes in relation to workshift welding fume exposures. Int Arch Occup Environ Health 64:393-397.
- \*Alarcón OM, Reinoso-Fuller JA, Silva T, et al. 1996. Manganese levels in serum of healthy Venezuelan infants living in Mérida. J Trace Elem Med Biol 10:210-213.
- +\*Alessio L, Apostoli P, Ferioli A, et al. 1989. Interference of manganese on neuroendocrinal system in exposed workers. Preliminary report. Biol Trace Elem Res 21:249-253.
- +\*Ali MM, Murthy RC, Mandal SK, et al. 1985. Effect of low protein diet on manganese neurotoxicity: III. Brain neurotransmitter levels. Neurobehav Toxicol Teratol 7:427-431.
- +\*Ali MM, Murthy RC, Saxena DK, et al. 1983a. Effect of low protein diet on manganese neurotoxicity: I. Developmental and biochemical changes. Neurobehav Toxicol Teratol 5:377-383.
- \*Ali MM, Murthy RC, Saxena DK, et al. 1983b. Effect of low protein diet on manganese neurotoxicity: II. Brain GABA and seizure susceptibility. Neurobehav Toxicol Teratol 5:385-389.
- \*Altman PL, Dittmer DS. 1974. Biological handbooks: Biology data book. Vol. III. 2nd ed. Bethesda, MD: Federation of American Societies for Experimental Biology, 1987-2008, 2041.

## 9. REFERENCES

- Amdur MO, Norris LC, Heuser GF. 1944. The need for manganese in bone development by the rat. *Proc Soc Exp Biol Med* 59:254-255.
- \*Andersen ME, Krishnan K. 1994. Relating in vitro to in vivo exposures with physiologically based tissue dosimetry and tissue response models. In: Salem H, ed. *Animal test alternatives: Refinement, reduction, replacement*. New York, NY: Marcel Dekker, Inc., 9-25.
- \*Andersen ME, Clewell HJ, Gargas ML, et al. 1987. Physiologically based pharmacokinetics and the risk assessment process for methylene chloride. *Toxicol Appl Pharmacol* 87(2):185-205.
- \*Andersen ME, Gearhart JM, Clewell HJ. 1999. Pharmacokinetic data needs to support risk assessments for inhaled and ingested manganese. *Neurotoxicology* 20:161-171.
- +\*Anderson JG, Cooney PT, Erikson KM. 2007a. Brain manganese accumulation is inversely related to  $\gamma$ -amino butyric acid uptake in male and female rats. *Toxicol Sci* 95(1):188-195.
- Anderson JG, Cooney PT, Erikson KM. 2007b. Inhibition of DAT function attenuates manganese accumulation in the globus pallidus. *Environ Toxicol Pharmacol* 23:179-184.
- Angerer J, Schaller KH. 1985. Digestion procedures for the determination of metals in biological samples. In: *Analysis of hazardous substances in biological materials*. Vol. 2. Weinheim, FRG: VCH, 1-30.
- Anke M, Groppel B. 1987. Toxic actions of essential trace elements (molybdenum, copper, zinc, iron and manganese). *Trace Element Anal Chem Med Biol* 4:201-236.
- Antonini JM, Stone S, Roberts JR, et al. 2007. Effect of short-term stainless steel welding fume inhalation exposure on lung inflammation, injury, and defense responses in rats. *Toxicol Appl Pharmacol* 223:234-245.
- Antunes MB, Bowler R, Doty RL. 2007. San Francisco/Oakland Bay bridge welder study. Olfactory function. (Erratum in: *Neurology* 70:87). *Neurology* 69:1278-1284.
- Antunes MB, Bowler R, Doty RL. 2008. Correction: San Francisco/Oakland Bay bridge welder study: Olfactory function. (Erratum on: *Neurology* 69:1278-1287). *Neurology* 70:87.
- APHA. 1985a. Determination of micro quantities of aluminum, antimony, arsenic, barium, beryllium, cadmium, chromium, cobalt, copper, iron, lead, manganese, molybdenum, nickel, selenium, silver, and tin by electrothermal atomic absorption spectrometry. In: *Standard methods for the examination of water and wastewater*. 16th ed. American Public Health Association, Washington, DC.
- APHA. 1985b. Manganese (total). In: *Standard methods for the examination of water and wastewater*. 16th ed. American Public Health Association, Washington, DC.
- APHA. 1985c. Metals by atomic absorption spectrometry. In: *Standard methods for the examination of water and wastewater*. 16th ed. American Public Health Association, Washington, DC.
- APHA. 1985d. Metals by emission spectroscopy using an inductively coupled plasma source (tentative). In: *Standard methods for the examination of water and wastewater*. 16th ed. American Public Health Association, Washington, DC.

## 9. REFERENCES

APHA. 1985e. Determination of antimony, bismuth, cadmium, calcium, cesium chromium, cobalt, copper, gold, iridium, iron, lead, lithium, magnesium, manganese, nickel, palladium, potassium, rhodium, ruthenium, silver, sodium, strontium, thallium, tin, and zinc by direct aspiratin into an air-acetylene flame-method 303A. In: Standard methods for the examination of water and wastewater. 16th ed. Washington, DC: American Public Health Association, 157-160.

APHA. 1985f. Determination of low concentrations of cadmium, chromium, cobalt, copper, iron, lead, manganese, nickel, silver, and zinc by chelation with ammonium pyrrolidine dithiocarbamate (APDC) and extraction into methyl isobutyl ketone (MIBK)-method 303B. In: Standard methods for the examination of water and wastewater. 16th ed. Washington, DC: American Public Health Association, 160-162.

\*APHA. 1998a. Method 3111. Metals by flame atomic absorption spectrometry. In: Clesceri LS, Greenberg AE, Eaton AD, et al., eds. Standard Methods for the Examination of Water and Wastewater. 20th ed. Washington, DC: American Public Health Association. American Water Works Association. Water Environmental Federation, 3-13 to 3-18.

\*APHA. 1998b. Method 3113. Metals by electrothermal atomic absorption spectrometry. In: Clesceri LS, Greenberg AE, Eaton AD, et al., eds. Standard methods for the examination of water and wastewater. 20th ed. Washington, DC: American Public Health Association. American Water Works Association. Water Environmental Federation, 3-24 to 3-31.

\*APHA. 1998d. Method 3120 A. Introduction. Method 3120 B. Inductively coupled plasma (ICP) method. In: Clesceri LS, Greenberg AE, Eaton AD, eds. Standard methods for the examination of water and wastewater. 20th ed. Washington, DC: American Public Health Association. American Water Works Association. Water Environmental Federation, 3-37 to 3-43.

\*APHA. 1998c. Method 3125. Metals by inductively coupled plasma/mass spectrometry. In: Clesceri LS, Greenberg AE, Eaton AD, et al., eds. Standard Methods for the Examination of Water and Wastewater. 20th ed. Washington, DC: American Public Health Association. American Water Works Association. Water Environmental Federation, 3-44 to 3-52.

Aposhian HV, Ingersoll RT, Montgomery EB. 1999. Transport and control of manganese ions in the central nervous system. *Environ Res Section A* 80:96-98.

Apostoli P, Lucchini R, Alessio L. 2000. Are current biomarkers suitable for the assessment of manganese exposure in individual workers? *Am J Ind Med* 37:283-290.

\*Archibald FS, Tyree C. 1987. Manganese poisoning and the attack of trivalent manganese upon catecholamines. *Arch Biochem Biophys* 256:638-650.

Arias E, Zavarella T. 1979. Teratogenic effects of manganese ethylenebisdithiocarbamate (maneb) on forelimb regeneration in the adult newt, *Triturus cristatus carnifex*. *Bull Environ Contam Toxicol* 22:297-304.

\*Arnaud J, Favier A. 1995. Copper, iron, manganese and zinc contents in human colostrum and transitory milk of French women. *Sci Total Environ* 159:9-15.

Arnich N, Cunat L, Lanhers M, et al. 2004. Comparative in situ study of the intestinal absorption of aluminum, manganese, nickel, and lead in rats. *Biol Trace Elem Res* 99:157-171.

## 9. REFERENCES

- \*Arnold ML, McNeill FE, Chettle DR. 1999. The feasibility of measuring manganese concentrations in human liver using neutron activation analysis. *Neurotoxicology* 20:407-412.
- Aschner M. 1998. Blood-brain barrier: Physiological and functional considerations. In: Slikker W, Chang LW, eds. *Handbook of developmental neurotoxicology*. San Diego: Academic Press, 339-351.
- Aschner M. 1999. Manganese homeostasis in the CNS. *Environ Res Section A* 80:105-109.
- Aschner M. 2000. Manganese: Brain transport and emerging research needs. *Environ Health Perspect Suppl* 108:429-432.
- Aschner M. 2006a. Manganese as a potential confounder of serum prolactin. *Environ Health Perspect* 114(8):A458.
- Aschner M. 2006b. The transport of manganese across the blood-brain barrier. *Neurotoxicology* 27:311-314.
- \*Aschner JL, Aschner M. 2005. Nutritional aspects of manganese homeostasis. *Mol Aspects Med* 26:353-362.
- \*Aschner M, Aschner JL. 1990. Manganese transport across the blood-brain barrier: relationship to iron homeostasis. *Brain Res Bull* 24:857-860.
- \*Aschner M, Aschner JL. 1991. Manganese neurotoxicity: Cellular effects and blood-brain barrier transport. *Neurosci Biobehav Rev* 15:333-340.
- \*Aschner M, Dorman DC. 2006. Manganese: Pharmacokinetics and molecular mechanisms of brain uptake. *Toxicol Rev* 25(3):147-154.
- Aschner M, Connor JR, Dorman DC, et al. 2002a. Manganese in health and disease. From transport to neurotoxicity. In: Massaro EJ, ed. *Handbook of neurotoxicology: Volume 1*. Totowa, NJ: Humana Press, 195-209.
- \*Aschner M, Erikson KM, Dorman DC. 2005. Manganese dosimetry: Species differences and implications for neurotoxicity. *Crit Rev Toxicol* 35(1):1-32.
- \*Aschner M, Guilarte TR, Schneider JS, et al. 2007. Manganese: Recent advances in understanding its transport and neurotoxicity. *Toxicol Appl Pharmacol* 221:131-147.
- Aschner M, Shanker G, Erikson K, et al. 2002b. The uptake of manganese in brain endothelial cultures. *Neurotoxicology* 23:165-168.
- Aschner M, Vrana KE, Zheng W. 1999. Manganese uptake and distribution in the central nervous system (CNS). *Neurotoxicology* 20:173-180.
- Asplund A, Grant D, Karlsson JOG. 1994. Mangafodipir (MnDPDP)- and MnCl<sub>2</sub>-induced endothelium-dependent relaxation in bovine mesenteric arteries. *J Pharmacol Exp Ther* 271(2):609-614.
- Asubiojo OI, Iskander FY. 1988. A trace element study of commercial infant milk and cereal formulas. *J Radioanal Nucl Chem* 125:265-270.

## 9. REFERENCES

- \*Aue WA, Millier B, Sun XY. 1990. Determination of (methylcyclopentadienyl)manganese tricarbonyl in gasolines by gas chromatography with flame photometric detection. *Anal Chem* 62:2453-2457.
- +Ayotte P, Plaa GL. 1985. Hepatic subcellular distribution of manganese in manganese and manganese-bilirubin induced cholestasis. *Biochem Pharmacol* 34:3857-3865.
- Ayyamperumal T, Jonathan MP, Srinivasalu S, et al. 2006. Assessment of acid leachable trace metals in sediment cores from River Uppanar, Cuddalore, southeast coast of India. *Environ Pollut* 143:34-45.
- Baek S, Cho J, Kim E, et al. 2004. cDNA array analysis of gene expression profiles in brain of mice exposed to manganese. *Ind Health* 2004(42):315-320.
- \*Baes CF, Sharp RD. 1983. A proposal for estimation of soil leaching and leaching constants for use in assessment models. *J Environ Qual* 12:17-28.
- +Bairati C, Goi G, Bollini D, et al. 1997. Effects of lead and manganese on the release of lysosomal enzymes in vitro and in vivo. *Clin Chim Acta* 261(1):91-101.
- +Baker DH, Halpin KM. 1991. Manganese and iron interrelationship in the chick. *Poultry Sci* 70:146-152.
- +\*Baldwin M, Mergler D, Larribe F, et al. 1999. Bioindicator and exposure data for a population based study of manganese. *Neurotoxicology* 20:343-354.
- +\*Ballatori N, Miles E, Clarkson TW. 1987. Homeostatic control of manganese excretion in the neonatal rat. *Am J Physiol* 252:R842-R847.
- Baly DL, Lee I, Doshi R. 1988. Mechanism of decreased insulinogenesis in manganese-deficient rats. Decreased insulin mRNA levels. *FEBS Lett* 239:55-58.
- +\*Banta RG, Markesbery WR. 1977. Elevated manganese levels associated with dementia and extrapyramidal signs. *Neurology* 27:213-216.
- \*Barbeau A. 1984. Manganese and extrapyramidal disorders (a critical review and tribute to Dr. George C. Cotzias). *Neurotoxicology* 5:13-35.
- \*Barceloux DG. 1999. Manganese. *Clin Toxicol* 37(2):293-307.
- Bardarov V, Zaikov C, Mitewa M. 1989. Application of high-performance liquid chromatography with spectrophotometric and electrochemical detection to the analysis of alkylenebis(dithiocarbamates) and their metabolites. *J Chromatogr* 479:97-105.
- Barhoumi R, Faske J, Liu X, et al. 2004. Manganese potentiates lipopolysaccharide-induced expression of NOS2 in C6 glioma cells through mitochondrial-dependent activation of nuclear factor kappaB. *Brain Res Mol Brain Res* 122:167-179.
- \*Barnes DG, Dourson M. 1988. Reference dose (RfD): Description and use in health risk assessments. *Regul Toxicol Pharmacol* 8(4):471-486.
- \*Baruthio F, Guillard O, Arnaud J, et al. 1988. Determination of manganese in biological materials by electrothermal atomic absorption spectrometry: A review. *Clin Chem* 34:227-234.

## 9. REFERENCES

- \*Baselt RC. 1988. Manganese. In: Biological monitoring methods for industrial chemicals. Littleton, MA: PSG Publishing Company, Inc., 194-197.
- Bason CW, Colborn T. 1992. US application and distribution of pesticides and industrial chemicals capable of disrupting endocrine and immune systems. In: Colborn T, Clement C, eds. Advances in modern environmental toxicology. Vol 21. Princeton, NJ: Princeton Scientific Publishing Co., 335-345.
- Bason CW, Colborn T. 1998. U.S. application and distribution of pesticides and industrial chemicals capable of disrupting endocrine and immune systems. *J Clean Technol Environ Toxicol Occup Med* 7:147-156.
- Bast-Pettersen R, Ellingsen DG. 2005. The Klove-Matthews static steadiness test compared with the dpd tremor. *Neurotoxicology* 26:331-342.
- \*Bast-Pettersen R, Ellingsen DG, Hetland SM, et al. 2004. Neuropsychological function in manganese alloy plant workers. *Int Arch Occup Environ Health* 77:277-287.
- +Baxter DJ, Smith WO, Klein GC. 1965. Some effects of acute manganese excess in rats. *Proc Soc Exp Biol Med* 119:966-970.
- Beach ED, Fernandez-Cornejo J, Huang WY. 1995. The potential risks of groundwater and surface water contamination by agricultural chemicals used in vegetable production. *J Environ Sci Health*. A30(6):1295-1325.
- Beck SL. 1990. Prenatal and postnatal assessment of maneb-exposed CD-1 mice. *Reprod Toxicol* 4:283-290.
- Beck JN, Sneddon J. 2000. Metal concentrations in soils and sediments in Southwest Louisiana. *Anal Lett* 33(10):1913-1959.
- \*Beklemishev MK, Stoyan TA, Dolmanova IF. 1997. Sorption-catalytic determination of manganese directly on a paper-based chelating sorbent. *Analyst* 122:1161-1165.
- \*Bell JG, Keen CL, Lönnerdal B. 1989. Higher retention of manganese in suckling than in adult rats is not due to maturational differences in manganese uptake by rat small intestine. *J Toxicol Environ Health* 26:387-398.
- \*Berger GS, ed. 1994. Epidemiology of endometriosis. In: Endometriosis: Advanced management and surgical techniques. New York, NY: Springer-Verlag, 3-7.
- +\*Bergstrom R. 1977. Acute pulmonary toxicity of manganese dioxide. *Scand J Work Environ Health* 3(Suppl 1):1-40.
- Berlin M, Lee IP, Russell LD. 1983. Effects of metals on male reproduction. In: Clarkson TW, Nordberg GF, Sager PR, eds. Reproductive and developmental toxicity of metals. New York, NY: Plenum Press, 29-40.
- \*Bernard A, Hermans C. 1997. Biomonitoring of early effects on the kidney or the lung. *Sci Total Environ* 199:205-211.

## 9. REFERENCES

- +\*Bernardino ME, Young SW, Lee JKT, et al. 1992. Hepatic MR imaging with MnDPDP: Safety, image quality, and sensitivity. *Radiology* 183:53-58.
- +\*Bernheimer H, Birkmayer W, Hornykiewicz O, et al. 1973. Brain dopamine and the syndromes of Parkinson and Huntington: Clinical, morphological and neurochemical correlations. *J Neurol Sci* 20: 415-455.
- Bertinchamps AJ, Cotzias GC. 1958. Biliary excretion of manganese. *Fed Proc* 17:428.
- +\*Bertinchamps AJ, Miller ST, Cotzias GC. 1965. Interdependence of routes excreting manganese. *Am J Physiol* 211:217-224.
- +\*Beuter A, Edwards R, de Geoffroy A, et al. 1999. Quantification of neuromotor function for detection of the effects of manganese. *Neurotoxicology* 20:355-366.
- Beuter A, Lambert G, MacGibbon B. 2004. Quantifying postural tremor in workers exposed to low levels of manganese. *J Neurosci Methods* 139:247-255.
- +Bhargava HN. 1987. Effect of repeated administration of manganese on the striatal cholinergic and dopaminergic receptors in the rat. *Toxicol Lett* 37:135-141.
- Bhuie AK, Roy DN. 2001. Deposition of Mn from automotive combustion of methylcyclopentadienyl manganese tricarbonyl beside the major highways in the greater Toronto area, Canada. *J Air Waste Manage Assoc* 51:1288-1301.
- \*Bhuie AK, Ogunseitan OA, White RR, et al. 2005. Modeling the environmental fate of manganese from methylcyclopentadienyl manganese tricarbonyl in urban landscapes. *Sci Total Environ* 339:167-178.
- Bianchi F, Maffini M, Mangia A, et al. 2007. Experimental design optimization for the ICP-AES determinatino of Li, Na, K, Al, Fe, Mn and Zn in human serum. *J Pharm Biomed Anal* 43:659-665.
- +\*Bird ED, Anton AH, Bullock B. 1984. The effect of manganese inhalation on basal ganglia dopamine concentrations in rhesus monkey. *Neurotoxicology* 5:59-65.
- Blais JF, Tyagi RD, Auclair JC. 1993. Metals removal from sewage sludge by indigenous iron-oxidizing bacteria. *J Environ Sci Health (A)* 28:443-467.
- +\*Blazak WF, Brown GL, Gray TJB, et al. 1996. Developmental toxicity study of mangafodipir trisodium injection (MnDPDP) in New Zealand white rabbits. *Fundam Appl Toxicol* 33:11-15.
- +\*Blond M, Netterstrom B. 2007. Neuromotor function in a cohort of Danish steel workers. *Neurotoxicology* 28:336-344.
- +\*Blond M, Netterstrom B, Laursen P. 2007. Cognitive function in a cohort of Danish steel workers. *Neurotoxicology* 28:328-335.
- \*Bock NA, Paiva FF, Nascimento GC, et al. 2008. Cerebrospinal fluid to brain transport of manganese in a non-human primate revealed by MRI. *Brain Res* 1198:160-170.



## 9. REFERENCES

- \*Bolte S, Normandin L, Kennedy G, et al. 2004. Human exposure to respirable manganese in outdoor and indoor air in urban and rural areas. *J Toxicol Environ Health A* 67:459-467.
- Bolze MS, Reeves RD, Lindbeck FE, et al. 1985. Influence of manganese on growth, somatomedin and glycosaminoglycan metabolism. *J Nutr* 115:352-358.
- +Bona MA, Castellano M, Plaza L, et al. 1992. Determination of heavy metals in human liver. *Hum Exp Toxicol* 11:311-313.
- Bonilla E. 1978a. Flameless atomic absorption spectrophotometric determination of manganese in rat brain and other tissues. *Clin Chem* 24:471-474.
- +\*Bonilla E. 1978b. Increased GABA content in caudate nucleus of rats after chronic manganese chloride administration. *J Neurochem* 31:551-552.
- +\*Bonilla E. 1980. L-tyrosine hydroxylase activity in the rat brain after chronic oral administration of manganese chloride. *Neurobehav Toxicol* 2:37-41.
- +\*Bonilla E, Prasad AL. 1984. Effects of chronic manganese intake on the levels of biogenic amines in rat brain regions. *Neurobehav Toxicol Teratol* 6:341-344.
- +\*Boojar MMA, Goodarzi F. 2002. A longitudinal follow-up of pulmonary function and respiratory symptoms in workers exposed to manganese. *J Occup Environ Med* 44:282-290.
- Boojar MMA, Goodarzi F, Basedaghat MA. 2002. Long-term follow-up of workplace and well water manganese effects on iron status indexes in manganese miners. *Arch Environ Health* 57(6):519-528.
- Borg K, Tjalve H. 1988. Effect of thiram and dithiocarbamate pesticides on the gastrointestinal absorption and distribution of nickel in mice. *Toxicol Lett* 42:87-98.
- Borgstahl GEO, Parge HE, Hickey MJ, et al. 1992. The structure of human mitochondrial manganese superoxide dismutase reveals a novel tetrameric interface of two 4-helix bundles. *Cell Press* 71:107-118.
- +\*Boshnakova E, Divanyan H, Zlatarov I, et al. 1989. Immunological screening of welders. *J Hyg Epidemiol Microbiol Immunol* 33:379-382.
- +\*Bouchard M, Mergler D, Baldwin M, et al. 2003. Blood manganese and alcohol consumption interact on mood states among manganese alloy production workers. *Neurotoxicology* 24:641-647.
- +\*Bouchard M, Mergler D, Baldwin M. 2005. Manganese exposure and age: Neurobehavioral performance among alloy production workers. *Environ Toxicol Pharmacol* 19(3):687-694.
- +\*Bouchard M, Mergler D, Baldwin M, et al. 2007b. Neurobehavioral functioning after cessation of manganese exposure: A follow-up after 14 years. *Am J Ind Med* 50:831-840.
- +\*Bouchard M, Mergler D, Baldwin M, et al. 2007a. Neuropsychiatric symptoms and past manganese exposure in a ferro-alloy plant. *Neurotoxicology* 28:290-297.
- \*Bouchard M, Laforest F, Vandelac L, et al. 2007c. Hair manganese and hyperactive behaviors: Pilot study of school-age children exposed through tap water. *Environ Health Perspect* 115:122-127.

## 9. REFERENCES

- Boudia N, Halley R, Kennedy G, et al. 2006. Manganese concentrations in the air of the Montreal (Canada) subway in relation to surface automobile traffic density. *Sci Total Environ* 366:143-147.
- Boudissa SM, Lambert J, Muller C, et al. 2006. Manganese concentrations in the soil and air in the vicinity of a closed manganese alloy production plant. *Sci Total Environ* 361:67-72.
- Bowler RM, Gysens S, Diamond E, et al. 2006b. Manganese exposure: Neuropsychological and neurological symptoms and effects in welders. *Neurotoxicology* 27:315-326.
- Bowler RM, Koller W, Schulz PE. 2006a. Parkinsonism due to manganism in a welder: Neurological and neuropsychological sequelae. *Neurotoxicology* 27:327-332.
- +\*Bowler RM, Mergler D, Sassine MP, et al. 1999. Neuropsychiatric effects of manganese on mood. *Neurotoxicology* 20:367-378.
- Bowler RM, Nakagawa S, Drezgic M, et al. 2007a. Sequelae of fume exposure in confined space welding: A neurological and neuropsychological case series. *Neurotoxicology* 28:298-311.
- Bowler RM, Roels HA, Nakagawa S, et al. 2007b. Dose-effect relationships between manganese exposure and neurological, neuropsychological and pulmonary function in confined space bridge welders. *Occup Environ Med* 64:167-177.
- +Boyce W, Witzleben CL. 1973. Bilirubin as a cholestatic agent. II. Effect of variable doses of bilirubin on the severity of manganese-bilirubin cholestasis. *Am J Pathol* 72:427-432.
- Boyer PD, Shaw JH, Phillips PH. 1942. Studies on manganese deficiency in the rat. *J Biol Chem* 143:417-425.
- Brain JD, Hellig E, Donaghey TC, et al. 2006. Effects of iron status on transpulmonary transport and tissue distribution of Mn and Fe. *Am J Respir Cell Mol Biol* 34:330-337.
- \*Brault N, Loranger S, Courchesne F, et al. 1994. Bioaccumulation of manganese by plants: Influence of MMT as a gasoline additive. *Sci Total Environ* 153:77-84.
- +\*Bredow S, Falgout MM, March TH, et al. 2007. Subchronic inhalation of soluble manganese induces expression of hypoxia-associated angiogenic genes in adult mouse lungs. *Toxicol Appl Pharmacol* 221:148-157.
- +\*Brenneman KA, Cattley RC, Ali SF, et al. 1999. Manganese-induced developmental neurotoxicity in the CD rat: Is oxidative damage a mechanism of action? *Neurotoxicology* 20:477-488.
- \*Brenneman KA, Wong BA, Buccellato MA, et al. 2000. Direct olfactory transport of inhaled manganese ( $^{54}\text{MnCl}_2$ ) to the rat brain: Toxicokinetic investigations in a unilateral nasal occlusion model. *Toxicol Appl Pharmacol* 169:238-248.
- Brenner SR. 2006. Searching for a relationship between manganese and welding and Parkinson's disease (Comment on: *Neurology* 2005; 64:2021-2028). *Neurology* 66:458-461.
- +Britton AA, Cotzias GC. 1966. Dependence of manganese turnover on intake. *Am J Physiol* 211:203-206.

## 9. REFERENCES

- +Brock AA, Chapman SA, Ulman EA, et al. 1994. Dietary manganese deficiency decreases rat hepatic arginase activity. *J Nutr* 124:340-344.
- Brocker ER, Schlatter C. 1979. Influence of some cations on the intestinal absorption of maneb. *J Agric Food Chem* 27:303-306.
- Brocker ER, Schlatter C. 1980. Dose dependence of the excretion of maneb metabolites in urine of rats. *Toxicol Lett* 6(4-5):221-224.
- Bronstein AC, Currance PL. 1988. Emergency care for hazardous materials exposure. St. Louis, MO: The C.V. Mosby Company, 191-192.
- +\*Brouillet EP, Shinobu L, McGarvey U, et al. 1993. Manganese injection into the rat striatum produces excitotoxic lesions by impairing energy metabolism. *Exp Neurol* 120:89-94.
- +Brown DSO, Wills CE, Yousefi V, et al. 1991. Neurotoxic effects of chronic exposure to manganese dust. *Neuropsychiatry Neuropsychol Behav Neurol* 4(3):238-250.
- \*Brown RP, Delp MD, Lindstedt SL, et al. 1997. Physiological parameter values for physiologically based pharmacokinetic models. *Toxicol Ind Health* 13(4):407-484.
- Bruemmer GW, Gerth J, Herms U. 1986. Heavy metal species, mobility and availability in soils. *Zeitschrift Fur Pflanzenernaehr Bodenk* 149:382-398.
- Brurok H, Ardenkjaer-Larsen JH, Hansson G, et al. 1999. Manganese dipyridoxyl diphosphate: MRI contrast agent with antioxidative and cardioprotective properties? In vitro and ex vivo assessments. *Biochem Biophys Res Commun* 254:768-772.
- Brurok H, Schojtt J, Berg K, et al. 1995. Effects of manganese dipyridoxyl diphosphate, dipyridoxyl diphosphate<sup>-</sup>, and manganese chloride on cardiac function. *Invest Radiol* 30(3):159-167.
- +Brurok H, Schjott J, Berg K, et al. 1997. Manganese and the heart: Acute cardiodepression and myocardial accumulation of manganese. *Acta Physiol Scand* 159:33-40.
- Buchet JP, Lauwerys R, Roels H. 1976. Determination of manganese in blood and urine by flameless atomic absorption spectrophotometry. *Clin Chim Acta* 73:481-486.
- Burry JN. 1976. Contact dermatitis from agricultural fungicide in south Australia. *Contact Dermatitis* 6:348-349.
- Buschmann J, Berg M, Stengel C, et al. 2007. Arsenic and manganese contamination of drinking water resources in Cambodia: Coincidence of risk areas with low relief topography. *Environ Sci Technol* 41:2146-2152.
- Calabrese EJ, Barnes R, Stanek EJ, et al. 1989. How much soil do young children ingest: An epidemiologic study. *Regul Toxicol Pharmacol* 10:123-137.
- +\*Calabresi P, Ammassari-Teule M, Gubellini P, et al. 2001. A synaptic mechanism underlying the behavioral abnormalities induced by manganese intoxication. *Neurobiol Dis* 9:419-432.

## 9. REFERENCES

- Calmano W, Ahlf W, Forstner U. 1988. Study of metal sorption/desorption processes on competing sediment components with a multichamber device. *Environ Geol Water Sci* 11:77-84.
- \*Calne DB, Chu NS, Huang CC, et al. 1994. Manganism and idiopathic Parkinsonism: Similarities and differences. *Neurology* 44:1583-1586.
- Calumpang SMF, Medina MJB, Roxas NP, et al. 1993. Movement and degradation of mancozeb fungicide and its metabolites, ethylenethiourea and ethyleneurea, in silty clay loam soils. *Int J Pest Management* 39:161-166.
- +\*Camner P, Curstedt T, Jarstrand C, et al. 1985. Rabbit lung after inhalation of manganese chloride: A comparison with the effects of chlorides of nickel, cadmium, cobalt, and copper. *Environ Res* 38:301-309.
- \*Campbell KI, George EL, Hall LL, et al. 1975. Dermal irritancy of metal compounds: Studies with palladium, platinum, lead, and manganese compounds. *Arch Environ Health* 30:168-170.
- \*Capar SG, Cunningham WC. 2000. Element and radionuclide concentrations in food: FDA total diet study 1991-1996. *J AOAC Int* 83(1):157-177.
- Carl GF, Gallagher BB. 1994. Manganese and epilepsy. In: Klimis-Tavantzis DJ, ed. *Manganese in health and disease*. Boca Raton, FL: CRC Press, 133-144.
- +\*Carl GF, Blackwell LK, Barnett FC, et al. 1993. Manganese and epilepsy: Brain glutamine synthetase and liver arginase activities in genetically epilepsy prone and chronically seized rats. *Epilepsia* 34:441-446.
- Carson BL, Ellis HV, McCann JL, eds. 1987. Manganese. In: *Toxicology and biological monitoring of metals in humans including feasibility and need*. Chelsea, MI: Lewis Publishers, Inc., 145-149.
- \*Carter JC, Miller WJ, Neathery MW, et al. 1974. Manganese metabolism with oral and intravenous <sup>54</sup>Mn in young calves as influenced by supplemental manganese. *J Animal Sci* 38:1284-1290.
- +\*Carter SD, Hein JF, Rehnberg GL, et al. 1980. Chronic manganese oxide ingestion in rats: Hematological effects. *J Toxicol Environ Health* 6:207-216.
- \*Casarett W, Klaassen CD, Doull, J. 2001. *Casarett and Doull's toxicology: The basic science of poisons*. 6th ed. New York: McGraw-Hill, 844.
- \*Casto BC, Meyers J, DiPaolo JA. 1979. Enhancement of viral transformation for evaluation of the carcinogenic or mutagenic potential of inorganic metal salts. *Cancer Res* 39:193-198.
- Cawte J. 1985. Psychiatric sequelae of manganese exposure in the adult, foetal and neonatal nervous system. *Aust NZ J Psychiatry* 19:211-217.
- +Cawte J. 1991. Environmental manganese toxicity. *Med J Austral* 154:291-292.
- +\*Cawte J, Hams G, Kilburn C. 1987. Manganism in a neurological ethnic complex in northern Australia [Letter]. *Lancet* 1(8544):1257.

## 9. REFERENCES

- +\*Cawte J, Kilburn C, Florence M. 1989. Motor neurone disease of the Western Pacific: Do the foci extend to Australia? *Neurotoxicity* 10:263-270.
- \*CDHS. 1990. Written communication regarding levels of manganese found in private wells. Hartford, CT: Connecticut Department of Health Services.
- CEH. 1980. Manganese-salient statistics. In: *Chemical economics handbook*. Menlo Park, CA: SRI International.
- +\*Centonze D, Gubellini P, Bernardi G, et al. 2001. Impaired excitatory transmission in the striatum of rats chronically intoxicated with manganese. *Exp Neurol* 172(2):469-476.
- +\*Chan AW, Minski MJ, Lim L, et al. 1992. Changes in brain regional manganese and magnesium levels during postnatal development: Modulations by chronic manganese administration. *Metab Brain Dis* 7:21-33.
- Chan WY, Bates JM, Rennert OM, et al. 1984. Intestinal transport of manganese from human milk, bovine milk and infant formula in rats. *Life Sci* 35:2415-2419.
- +\*Chandra SV. 1972. Histological and histochemical changes in experimental manganese encephalopathy in rabbits. *Arch Toxicol* 29:29-38.
- +\*Chandra SV. 1983. Psychiatric illness due to manganese poisoning. *Acta Psychiatr Scand* 67(Suppl 303):49-54.
- +\*Chandra SV, Imam Z. 1973. Manganese induced histochemical and histological alterations in gastrointestinal mucosa of guinea pigs. *Acta Pharmacol Toxicol* 33:449-458.
- +\*Chandra SV, Shukla GS. 1978. Manganese encephalopathy in growing rats. *Environ Res* 15:28-37.
- +\*Chandra SV, Shukla GS. 1981. Concentrations of striatal catecholamines in rats given manganese chloride through drinking water. *J Neurochem* 36:683-687.
- \*Chandra SV, Tandon SK. 1973. Enhanced manganese toxicity in iron-deficient rats. *Environ Physiol Biochem* 3:230-235.
- +\*Chandra SV, Ara R, Nagar N, et al. 1973. Sterility in experimental manganese toxicity. *Acta Biol Med Ger* 30:857-862.
- +Chandra SV, Saxena DK, Hasan MZ. 1975. Effect of zinc on manganese induced testicular injury in rats. *Ind Health* 13:51-56.
- +Chandra SV, Shukla GS, Srivastava RS. 1981. An exploratory study of manganese exposure to welders. *Clin Toxicol* 18:407-416.
- Chen CJ, Ou YC, Lin SY, et al. 2006. Manganese modulates pro-inflammatory gene expression in activated glia. *Neurochem Int* 49:62-71.
- Chen JY, Tsao GC, Zhao Q, et al. 2001. Differential cytotoxicity of Mn(II) and Mn(III): Special reference to mitochondrial [Fe-S] containing enzymes. *Toxicol Appl Pharmacol* 175:160-168.

## 9. REFERENCES

- Cheng J, Fu JL, Zhou ZC. 2003. The inhibitory effects of manganese on steroidogenesis in rat primary Leydig cells by disrupting steroidogenic acute regulatory (StAR) protein expression. *Toxicology* 187:139-148.
- Cheng J, Fu JL, Zhou ZC. 2005. The mechanism of manganese-induced inhibition of steroidogenesis in rat primary Leydig cells. *Toxicology* 211:1-11.
- Chernoff N, Kavlock RJ, Rogers EH, et al. 1979. Perinatal toxicity of maneb, ethylene thiourea, and ethylenebisisothiocyanate sulfide in rodents. *J Toxicol Environ Health* 5:821-834.
- Chetty CS, Reddy GR, Suresh A, et al. 2001. Effects of manganese on inositol polyphosphate receptors and nitric oxide synthase activity in rat brain. *Int J Toxicol* 20:275-280.
- +\*Chia SE, Foo SC, Gan SL, et al. 1993a. Neurobehavioral functions among workers exposed to manganese ore. *Scand J Work Environ Health* 19:264-270.
- +\*Chia SE, Gan SL, Chua LH, et al. 1995. Postural stability among manganese exposed workers. *Neurotoxicology* 16:519-526.
- Chia SE, Phoon WH, Lee HS, et al. 1993b. Exposure to neurotoxic metals among workers in Singapore: An overview. *Occup Med* 43:18-22.
- Choi CJ, Anantharam V, Saetveit NJ, et al. 2007a. Normal cellular prion protein protects against manganese-induced oxidative stress and apoptotic cell death. *Toxicol Sci* 92(2):495-509.
- Choi DS, Kim EA, Cheong H, et al. 2007b. Evaluation of MR signal index for the assessment of occupational manganese exposure of welders by measurement of local proton T relaxation time. *Neurotoxicology* 28:284-289.
- \*Chowdhury BA, Chandra RK. 1987. Biological and health implications of toxic heavy metal and essential trace element interactions. *Prog Food Nutr Sci* 11:55-113.
- Chu N. 2004. Effect of levodopa treatment for parkinsonism in welders: A double-blind study (Comment on: *Neurology* 2004; 62:730-733). *Neurology* 63:1541-1544.
- \*Chu NS, Hochberg FH, Calne DB, et al. 1995. Neurotoxicity of manganese. In: Chang L, Dyer R, eds. *Handbook of neurotoxicology*. New York, NY: Marcel Dekker, Inc., 91-103.
- Cikrt M, Bencko V. 1975. Biliary excretion of <sup>7</sup>Be and its distribution after intravenous administration of <sup>7</sup>BeCl<sub>2</sub> in rats. *Arch Toxicol* 34:53-60.
- +Clay RJ, Morris JB. 1989. Comparative pneumotoxicity of cyclopentadienyl manganese tricarbonyl and methylcyclopentadienyl manganese tricarbonyl. *Toxicol Appl Pharmacol* 98:434-443.
- Clegg MS, Lönnerdal B, Hurley LS, et al. 1986. Analysis of whole blood manganese by flameless atomic absorption spectrophotometry and its use as an indicator of manganese status in animals. *Anal Biochem* 157:12-18.
- \*Clewell HJ, Andersen ME. 1985. Risk assessment extrapolations and physiological modeling. *Toxicol Ind Health* 1(4):111-131.

## 9. REFERENCES

- \*Clewell HJ, Crump KS. 1999. Benchmark dose analysis of the neurological effects of manganese in smelter workers. Agency for Toxic Substances and Disease Registry
- \*Clewell HJ, Lawrence GA, Calne DB, et al. 2003. Determination of an occupational exposure guideline for manganese using the benchmark method. *Risk Anal* 23(5):1031-1046.
- \*Cockell KA, Bonacci G, Belonje B. 2004. Manganese content of soy or rice beverages is high in comparison to infant formulas. *J Am Coll Nutr* 23(2):134-130.
- Coe M, Cruz R, Van Loon JC. 1980. Determination of methylcyclopentadienyl manganese-tricarbonyl by gas chromatography-atomic absorption spectrometry at ng m-3 levels in air samples. *Anal Chim Acta* 120:171-176.
- Cohen G. 1984. Oxy-radical in catecholamine neurons. *Neurotoxicology* 5:77-82.
- Cohen JM, Kamphake LJ, Harris EK, et al. 1960. Taste threshold concentrations of metals in drinking water. *J Am Water Works Assoc* (May):660-670.
- Colet JM, Elst LV, Muller RN. 1998. Dynamic evaluation of the hepatic uptake and clearance of manganese-based MRI contrast agents: A 31P NMR study on the isolated and perfused rat liver. *J Magn Reson Imaging* 8(3):663-669.
- +\*Collipp PJ, Chen SY, Maitinsky S. 1983. Manganese in infant formulas and learning disability. *Ann Nutr Metab* 27:488-494.
- +\*Colomina MT, Domingo JL, Llobet JM, et al. 1996. Effect of day of exposure on the developmental toxicity of manganese in mice. *Vet Hum Toxicol* 38:7-9.
- \*Cook KK. 1997. Extension of dry ash atomic absorption and spectrophotometric methods to determination of minerals and phosphorus in soy-based, whey-based, and enteral formulae (Modification of AOAC official methods 985.35 and 986.24): Collaborative study. *J AOAC Int* 80:834-844.
- +\*Cook DG, Fahn S, Brait KA. 1974. Chronic manganese intoxication. *Arch Neurol* 30:59-64.
- Cooper R, Stranks DR. 1966. Vapor pressure measurements. In: Jonassen HB, Weissberg A, eds. *Technique of inorganic chemistry*. Vol. VI. New York, NY: John Wiley and Sons, 1-82.
- \*Cooper RM, Istok JD. 1988. Geostatistics applied to groundwater contamination. II: Application. *J Environ Eng* 114:287-299.
- \*Cooper WC. 1984. The health implications of increased manganese in the environment resulting from the combustion of fuel additives: A review of the literature. *J Toxicol Environ Health* 14:23-46.
- Cordier S, Theriault G, Iturra H. 1983. Mortality patterns in a population living near a copper smelter. *Environ Res* 31:311-322.
- Cory-Slechta DA, Thiruchelvam M, Barlow BK, et al. 2005. Developmental pesticide models of the Parkinson disease phenotype. *Environ Health Perspect* 113(9):1263-1270.
- Cotton FA, Wilkinson G. 1972. Manganese. In: *Advanced inorganic chemistry*. New York, NY: Interscience Publisher, 845-855.

## 9. REFERENCES

- \*Cotzias GC. 1958. Manganese in health and disease. *Physiol Rev* 38:503-533.
- +\*Cotzias GC, Horiuchi K, Fuenzalida S, et al. 1968. Chronic manganese poisoning: Clearance of tissue manganese concentrations with persistence of the neurological picture. *Neurology* 18:376-382.
- \*Cotzias GC, Miller ST, Papavasiliou PS, et al. 1976. Interactions between manganese and brain dopamine. *Med Clin North Am* 60:729-738.
- \*Cotzias GC, Papavaioliou PS, Miller ST. 1964. Manganese in melanin. *Nature* 201:1228-1229.
- +Cox DN, Traiger GJ, Jacober SP, et al. 1987. Comparison of the toxicity of methylcyclopentadienyl manganese tricarbonyl with that of its two major metabolites. *Toxicol Lett* 39:1-5.
- Crippa M, Misquith L, Lonati A, et al. 1990. Dyshidrotic eczema and sensitization to dithiocarbamates in a florist. *Contact Dermatitis* 23:203-204.
- +Critchfield JW, Keen CL. 1992. Manganese +2 exhibits dynamic binding to multiple ligands in human plasma. *Metabolism* 41:1087-1092.
- \*Critchfield JW, Carl GF, Keen CL. 1993. The influence of manganese supplementation on seizure onset and severity, brain monoamines in the genetically epilepsy prone rat. *Epilepsy Res* 14:3-10.
- Crittenden PL, Filipov NM. 2008. Manganese-induced potentiation of in vitro proinflammatory cytokine production by activated microglial cells is associated with persistent activation of p38 MAPK. *Toxicol In Vitro* 22:18-27.
- Crooks DR, Welch N, Smith DR. 2007a. Low-level manganese exposure alters glutamate metabolism in GABAergic AF5 cells. *Neurotoxicology* 28:548-554.
- Crooks DR, Ghosh MC, Braun-Sommargren M, et al. 2007b. Manganese targets m-aconitase and activates iron regulatory protein 2 in AF5 GABAergic cells. *J Neurosci Res* 2007(85):1797-1809.
- Cross DJ, Flexman JA, Anzai Y, et al. 2006. In vivo imaging of functional disruption, recovery and alteration in rat olfactory circuitry after lesion. *Neuroimage* 32:1265-1272.
- \*Cross DJ, Minoshima S, Anzai Y, et al. 2004. Statistical mapping of functional olfactory connections of the rat brain in vivo. *Neuroimage* 23:1326-1335.
- \*Crossgrove J, Zheng W. 2004. Review article. Manganese toxicity upon overexposure. *NMR Biomed* 17:544-553.
- \*Crossgrove JS, Yokel RA. 2004. Manganese distribution across the blood-brain barrier III. The divalent metal transporter-1 is not the major mechanism mediating brain manganese uptake. *Neurotoxicology* 25(3):451-460.
- \*Crossgrove JS, Yokel RA. 2005. Manganese distribution across the blood-brain barrier IV. Evidence of brain influx through store-operated calcium channels. *Neurotoxicology* 26:297-307.



## 9. REFERENCES

- Crossgrove JS, Allen DD, Bukaveckas BL, et al. 2003. Manganese distribution across the blood-brain barrier I. Evidence for carrier-mediated influx of manganese citrate as well as manganese and manganese transferrin. *Neurotoxicology* 24:3-13.
- \*Crump KS. 2000. Manganese exposure in Toronto during use of the gasonline additive, methylcyclopentadienyl manganese tricarbonyl. *J Expo Anal Environ Epidemiol* 10(3):227-239.
- +\*Crump KS, Rousseau P. 1999. Results from eleven years of neurological health surveillance at a manganese oxide and salt producing plant. *Neurotoxicology* 20:273-286.
- \*Curtin D, Ryan J, Chaudhary RA. 1980. Manganese adsorption and desorption in calcareous Lebanese soils. *Soil Sci Soc Am J* 44:947-950.
- Daniels AI, Everson GJ. 1935. The relation of manganese to congenital debility. *J Nutr* 9:191-203.
- +\*Daniels AJ, Abarca J. 1991. Effect of intranigral Mn<sup>2+</sup> on striatal and nigral synthesis and levels of dopamine and cofactor. *Neurotoxicol Teratol* 13:483-487.
- +Dastur DK, Manghani DK, Raghavendran KV, et al. 1969. Distribution and fate of Mn<sup>54</sup> in the rat, with special reference to the C.N.S. *Q J Exp Physiol* 54:322-331.
- +\*Dastur DK, Manghani DK, Raghavendran KV. 1971. Distribution and fate of <sup>54</sup>Mn in the monkey: Studies of different parts of the central nervous system and other organs. *J Clin Invest* 50:9-20.
- +\*Davidson LA, Lönnnerdal B. 1989. Fe-saturation and proteolysis of human lactoferrin: Effect on brush-border receptor-mediated uptake of Fe and Mn. *Am J Physiol* 257(6Pt1):G930-934.
- +\*Davidsson L, Cederblad A, Hagebo E, et al. 1988. Intrinsic and extrinsic labeling for studies of manganese absorption in humans. *J Nutr* 118:1517-1524.
- +\*Davidsson L, Cederblad A, Lönnnerdal B, et al. 1989a. Manganese retention in man: A method for estimating manganese absorption in man. *Am J Clin Nutr* 49:170-179.
- \*Davidsson L, Cederblad A, Lönnnerdal B, et al. 1989b. Manganese absorption from human milk, cow's milk, and infant formulas in humans. *Am J Dis Child* 143:823-827.
- \*Davis JM. 1998. Methylcyclopentadienyl manganese tricarbonyl: Health risk uncertainties and research directions. *Environ Health Perspect Suppl* 106(1):191-201.
- +\*Davis CD, Greger JL. 1992. Longitudinal changes of manganese-dependent superoxide dismutase and other indices of manganese and iron status in women. *Am J Clin Nutr* 55:747-752.
- +\*Davis CD, Malecki EA, Greger JL. 1992a. Interactions among dietary manganese, heme iron and non-heme iron in women. *Am J Clin Nutr* 56:926-932.
- +Davis CD, Ney DM, Greger JL. 1990. Manganese, iron and lipid interactions in rats. *J Nutr* 120:507-513.
- +\*Davis CD, Wolf TL, Greger JL. 1992b. Varying levels of manganese and iron affect absorption and gut endogenous losses of manganese by rats. *J Nutr* 122:1300-1308.

## 9. REFERENCES

- +\*Davis CD, Zech L, Greger JL. 1993. Manganese metabolism in rats: An improved methodology for assessing gut endogenous losses. *Proc Soc Exp Biol Med* 202:103-108.
- \*Davis DW, Hsiao K, Ingels R, et al. 1988. Origins of manganese in air particulates in California. *J Air Pollut Control Assoc* 38:1152-1157.
- Davis JM. 1999. Inhalation health risks of manganese: An EPA perspective. *Neurotoxicology* 20:511-518.
- Davis JM, Jarabek AM, Mage DT, et al. 1998. The EPA health risk assessment of methylcyclopentadienyl manganese tricarbonyl (MMT). *Risk Anal* 18:57-70.
- Davison RL, Natusch DFS, Wallace JR, et al. 1974. Trace elements in fly ash: Dependence of concentration on particle size. *Environ Sci Technol* 8:1107-1113.
- de Bie RMA, Gladstone RM, Strafella AP, et al. 2007. Manganese-induced Parkinsonism associated with methcathinone (ephedrone) abuse. *Arch Neurol* 64:886-889.
- de Burbure C, Buchet JP, Leroyer A, et al. 2006. Renal and neurologic effects of cadmium, lead, mercury, and arsenic in children: Evidence of early effects and multiple interactions at environmental exposure levels. *Environ Health Perspect* 114(4):584-590.
- \*de Carvalho E, Faria V, Loureiro A, et al. 1989. Acute renal failure and nephrotic syndrome after maneb exposure: A new case with light and electron microscopic study. *Acta Med Port* 1989 2:215-218.
- de Lamirande E, Plaa GL. 1978. Role of manganese, bilirubin and sulfobromophthalein in manganese-bilirubin cholestasis in rats (40189). *Proc Soc Exp Biol Med* 158:283-287.
- +de Lamirande E, Tuchweber B, Plaa GL. 1982. Morphological aspects of manganese-bilirubin induced cholestasis. *Liver* 2:22-27.
- \*De Méo M, Laget M, Castegnaro M, et al. 1991. Genotoxic activity of potassium permanganate in acidic solutions. *Mutat Res* 260:295-306.
- De Paris P, Caroli S. 1995. In vitro effect of dithiocarbamate pesticides and of CaNa<sub>2</sub> EDTA on human serum dopamine beta-hydroxylase. *Biomed Environ Sci* 8:114-121.
- \*Deschamps FJ, Guillaumot M, Raux S. 2001. Neurological effects in workers exposed to manganese. *J Occup Environ Med* 43(2):127-132.
- de Sousa PL, Souza SL, Silva AC, et al. 2007. Manganese-enhanced magnetic resonance imaging (MEMRI) of rat brain after systemic administration of MnCl<sub>2</sub>: Changes in T1 relaxation times during postnatal development. *J Magn Reson Imaging* 25:32-38.
- \*DEA. 2007. Records and reports of listed chemicals and certain machines. U.S. Drug Enforcement Administration. Code of Federal Regulations. 21 CFR 1310.02. [http://www.access.gpo.gov/nara/cfr/waisidx\\_07/21cfrv9\\_07.html](http://www.access.gpo.gov/nara/cfr/waisidx_07/21cfrv9_07.html). April 29, 2008.
- +\*Deschamps FJ, Guillaumot M, Raux S. 2001. Neurological effects in workers exposed to manganese. *J Occup Environ Med* 43(2):127-132.

## 9. REFERENCES

- +\*Deskin R, Bursian SJ, Edens FW. 1980. Neurochemical alterations induced by manganese chloride in neonatal rats. *Neurotoxicology* 2:65-73.
- +\*Deskin R, Bursian SJ, Edens FW. 1981. The effect of chronic manganese administration on some neurochemical and physiological variables in neonatal rats. *Gen Pharmacol* 12:279-280.
- \*Desole MS, Esposito G, Migheli R, et al. 1995. Allopurinol protects against manganese-induced oxidative stress in the striatum and in the brainstem of the rat. *Neurosci Lett* 192:73-76.
- +\*Desole MS, Esposito G, Migheli R, et al. 1997. Glutathione deficiency potentiates manganese toxicity in rat striatum and brainstem and in PC12 cells. *Pharmacol Res* 36(4):285-292.
- +\*Desole MS, Miele M, Esposito G, et al. 1994. Dopaminergic system activity and cellular defense mechanisms in the striatum and striatal synaptosomes of the rat subchronically exposed to manganese. *Arch Toxicol* 68:566-570.
- +\*Devenyi AG, Barron TF, Mamourian AC. 1994. Dystonia, hyperintense basal ganglia, and whole blood manganese levels in Alagille's syndrome. *Gastroenterology* 106:1068-1071.
- \*Deverel SJ, Millard SP. 1988. Distribution and mobility of selenium and other trace elements in shallow groundwater of the western San Joaquin Valley, California. *Environ Sci Technol* 22:697-702.
- Diamond GL, Goodrum PE, Felter SP, et al. 1998. Gastrointestinal absorption of metals. *Drug Chem Toxicol* 21(2):223-251.
- Diaz-Veliz G, Mora S, Gomez P, et al. 2004. Behavioral effects of manganese injected in the rat substantia nigra are potentiated by dicumarol, a DT-diaphorase inhibitor. *Pharmacol Biochem Behav* 77:245-251.
- +Dieter HH, Rotard W, Simon J, et al. 1992. Manganese in natural mineral waters from Germany. *Die Nahrung* 5:488-484.
- +\*Diez-Ewald M, Weintraub LR, Crosby WH. 1968. Interrelationship of iron and manganese metabolism. *Proc Soc Exp Biol Med* 129:448-451.
- +\*Dikshith TS, Chandra SV. 1978. Cytological studies in albino rats after oral administration of manganese chloride. *Bull Environ Contam Toxicol* 19:741-746.
- \*Doisy EA. 1973. Effects of deficiency in manganese upon plasma levels of clotting proteins and cholesterol in man. Trace element metabolism. In: Hoekstra WG, Suttie JW, Ganther AE, et al., eds. *Animals-2*, 2nd Ed. Baltimore, MD: University Park Press, 668-670.
- Donaldson J. 1984. Involvement of manganese in physiological and biochemical processes: An overview. *Neurotoxicology* 5:1-3.
- \*Donaldson J. 1987. The physiopathologic significance of manganese in brain: Its relation to schizophrenia and neurodegenerative disorders. *Neurotoxicology* 8:451-462.
- Donaldson J, LaBella FS. 1984. The effects of manganese on the cholinergic receptor in vivo and in vitro may be mediated through modulation of free radicals. *Neurotoxicology* 5:105-112.

## 9. REFERENCES

- Donaldson J, LaBella FS, Gesser D. 1980. Enhanced autoxidation of dopamine as a possible basis of manganese neurotoxicity. *Neurotoxicity* 2:53-64.
- Donaldson J, McGregor D, LaBella F. 1982. Manganese neurotoxicity: A model for free radical mediated neurodegeneration? *Can J Physiol Pharmacol* 60:1398-1405.
- Dorman DC. 2006. Neurotoxicity of inhaled manganese: A reanalysis of human exposure arising from showering. *Med Hypotheses* 66(1):199-200.
- \*Dorman DC, Breneman KA, McElveen AM, et al. 2002a. Olfactory transport: A direct route of delivery of inhaled manganese phosphate to the rat brain. *J Toxicol Environ Health* 65(20):1493-1511.
- \*Dorman DC, McElveen AM, Marshall MW, et al. 2005b. Maternal-fetal distribution of manganese in the rat following inhalation exposure to manganese sulfate. *NeuroToxicology* 26:625-632.
- \*Dorman DC, McElveen AM, Marshall MW, et al. 2005a. Tissue manganese concentrations in lactating rats and their offspring following combined in utero and lactation exposure to inhaled manganese sulfate. *Toxicol Sci* 84:12-21.
- \*Dorman DC, McManus BE, Marshall MW, et al. 2004a. Old age and gender influence the pharmacokinetics of inhaled manganese sulfate and manganese phosphate in rats. *Toxicol Appl Pharmacol* 197:113-124.
- +\*Dorman DC, McManus BE, Parkinson CU, et al. 2004b. Nasal toxicity of manganese sulfate and manganese phosphate in young male rats following subchronic (13-week) inhalation exposure. *Inhal Toxicol* 16(6-7):481-488.
- +\*Dorman DC, Struve MF, Gross EA, et al. 2005c. Sub-chronic inhalation of high concentrations of manganese sulfate induces lower airway pathology in rhesus monkeys. *Respir Res* 6(1):121. <http://www.pubmedcentral.nih.gov/picrender.fcgi?artid=1283983&blobtype=pdf>. May 5, 2008.
- \*Dorman DC, Struve MF, James RA, et al. 2001b. Influence of dietary manganese on the pharmacokinetics of inhaled manganese sulfate in male CD rats. *Toxicol Sci* 60:242-251.
- \*Dorman DC, Struve MF, James RA, et al. 2001a. Influence of particle solubility on the delivery of inhaled manganese to the rat brain: Manganese sulfate and manganese tetroxide pharmacokinetics following repeated (14-day) exposure. *Toxicol Appl Pharmacol* 170:79-87.
- +\*Dorman DC, Struve MF, Marshall MW, et al. 2006a. Tissue manganese concentrations in young male Rhesus monkeys following subchronic manganese sulfate inhalation. *Toxicol Sci* 92(1):201-210.
- +\*Dorman DC, Struve MF, Vitarella D, et al. 2000. Neurotoxicity of manganese chloride in neonatal and adult CD rats following subchronic (21-day) high-dose oral exposure. *J Appl Tox* 20(3):179-187.
- Dorman DC, Struve MF, Wong BA. 2002b. Brain manganese concentrations in rats following manganese tetroxide inhalation are unaffected by dietary manganese intake. *Neurotoxicology* 23(2):185-195.
- \*Dorman DC, Struve MF, Wong, et al. 2006b. Correlation of brain magnetic resonance imaging changes with pallidal manganese concentrations in Rhesus monkeys following subchronic manganese inhalation. *Toxicol Sci* 92(1):219-227.

## 9. REFERENCES

- +\*Dorner K, Dziadzka S, Hohn A, et al. 1989. Longitudinal manganese and copper balances in young infants and preterm infants fed on breast-milk and adapted cow's milk formulas. *Br J Nutr* 61:559-572.
- +Droms KA, Malkinson AM. 1991. Mechanisms of glucocorticoid involvement in mouse lung tumorigenesis. *Exp Lung Res* 17:359-370.
- +\*Drown DB, Oberg SG, Sharma RP. 1986. Pulmonary clearance of soluble and insoluble forms of manganese. *J Toxicol Environ Health* 17:201-212.
- Dukhande VV, Malthankar-Phatak GH, Hugus JJ, et al. 2006. Manganese-induced neurotoxicity is differentially enhanced by glutathione depletion in astrocytoma and neuroblastoma cells. *Neurochem Res* 31:1349-1357.
- \*DuPuis MD, Hill HH. 1979. Analysis of gasoline for antiknock agents with a hydrogen atmosphere flame ionization detector. *Anal Chem* 51:292-295.
- +\*Dupuis Y, Porembska Z, Tardivel S, et al. 1992. Intestinal transfer of manganese: Resemblance to and competition with calcium. *Reprod Nutr Dev* 32:453-460.
- \*Earls JP, Bluemke DA. 1999. New MR imaging contrast agents. *Magn Reson Imaging Clin N Am* 7:255-273.
- \*Eckel WP, Langley WD. 1988. A background-based ranking technique for assessment of elemental enrichment in soils at hazardous waste sites. In: *Superfund '88: Proceedings of the 9th National Conference*. Washington, DC, 282-286.
- Egeberg PK, Schaanning M, Naes K, et al. 1988. Modelling the manganese cycling in two stratified fjords. *Marine Chemistry* 23:383-391.
- \*Egyed M, Wood GC. 1996. Risk assessment for combustion products of the gasoline additive MMT in Canada. *Sci Total Environ* 189/190:11-20.
- Eisenreich SJ, Looney BB, Thonton JD. 1981. Airborne organic contaminants in the Great Lakes ecosystem. *Environ Sci Technol* 15:30-38.
- +\*Ejima A, Imamura T, Nakamura S, et al. 1992. Manganese intoxication during total parenteral nutrition [Letter]. *Lancet* 339:426.
- El-Deiry WS, Downey KM, So AG. 1984. Molecular mechanisms of manganese mutagenesis. *Proc Natl Acad Sci USA* 81:7378-7382.
- +\*Elbetieha A, Bataineh H, Darmani H, et al. 2001. Effects of long-term exposure to manganese chloride on fertility of male and female mice. *Toxicol Lett* 119:193-201.
- \*Elder A, Gelein R, Silva V, et al. 2006. Translocation of inhaled ultrafine manganese oxide particles to the central nervous system. *Environ Health Perspect* 114(8):1172-1178.
- +\*Elias Z, Mur JM, Pierre F, et al. 1989. Chromosome aberrations in peripheral blood lymphocytes of welders and characterization of their exposure by biological samples analysis. *J Occup Med* 31:477-483.

## 9. REFERENCES

- +\*Elizondo G, Fretz CJ, Stark DD, et al. 1991. Preclinical evaluation of MnDPDP: New paramagnetic hepatobiliary contrast agent for MR imaging. *Radiology* 178:73-78.
- Ellingsen DG, Haug E, Gaarder PI, et al. 2003a. Endocrine and immunologic markers in manganese alloy production workers. *Scand J Work Environ Health* 29(3):230-238.
- Ellingsen DG, Haug E, Ulvik RJ, et al. 2003b. Iron status in manganese alloy production workers. *J Appl Toxicol* 23:239-247.
- \*Ellingsen DG, Hetland SM, Thomassen Y. 2003c. Manganese air exposures assessment and biological monitoring in the manganese alloy production industry. *J Environ Monit* 5(1):84-90.
- +El-Rahman SS. 2004. Assessment of neuropathology, amino acid profile and bioaccumulation following sub chronic inhalation of manganese phosphate (as one of gasoline combustion products) in male sprague-dawley rats. *Vet Med J* 52(4):495-506.
- +\*Emara AM, El-Ghawabi SH, Madkour OI, et al. 1971. Chronic manganese poisoning in the dry battery industry. *Br J Ind Med* 28:78-82.
- \*Ensing JG. 1985. Bazooka: Cocaine-base and manganese carbonate. *J Anal Toxicol* 9:45-46.
- +\*EPA. 1977. Inhalation toxicology of airborne particulate manganese in rhesus monkeys. Research Triangle Park, NC: U.S. Environmental Protection Agency. EPA600177026. PB268643.
- \*EPA. 1978. U.S. Environmental Protection Agency. *Fed Regist* 43:41424-41429.
- \*EPA. 1979a. Regulation of fuel and fuel additives MMT. Lifting of suspension of enforcement. U.S. Environmental Protection Agency. *Fed Regist* 44:58952-58965.
- EPA. 1979b. Sources of toxic pollutants found in influents to sewage treatment plants. VI. Integrated interpresentation. Washington, DC: U.S. Environmental Protection Agency, Office of Water Planning and Standards. EPA 4404008. PB81219685.
- EPA. 1980. Chemical contaminants in nonoccupationally exposed U.S. residents. Report to U.S. Environmental Protection Agency, Office of Research and Development, Research Triangle Park, NC, by Oak Ridge National Laboratory, Oak Ridge, TN. EPA-600180001.
- \*EPA. 1981. Ethyl Corp: Denial of application for fuel waiver; summary of decision. U.S. Environmental Protection Agency. *Fed Regist* 46:58360.
- EPA. 1982. Inductively coupled plasma-atomic emission spectrometric method for trace element analysis of water and wastes—method 200.7. Cincinnati, OH: U.S. Environmental Protection Agency, Office of Research and Development.
- \*EPA. 1983a. Manganese: Atomic-absorption, direct aspiration—method 243.1. In: *Methods for chemical analysis of water and wastes*. Cincinnati, OH: U.S. Environmental Protection Agency, Office of Research and Development. EPA600479020.
- \*EPA. 1983b. Manganese. Method 243.2. Atomic absorption, furnace technique. In: *Methods for chemical analysis of water and wastes*. Cincinnati, OH: U.S. Environmental Protection Agency, 243.2-1 to 243.2-2. EPA600479020.

## 9. REFERENCES

\*EPA. 1983c. Human exposure to atmospheric concentrations of selected chemicals. Vol. II. Report to U.S. Environmental Protection Agency, Office of Air Quality Planning and Standards, Research Triangle Park, NC, by Systems Applications, Incorporated, San Rafael, CA. PB83265249.

+\*EPA. 1984. Health assessment document for manganese. Final draft. Cincinnati, OH: U.S. Environmental Protection Agency, Office of Research and Development. EPA600883013F.

EPA. 1985a. Chemical identity—manganese, tricarbonyl methylcyclopentadienyl. Cincinnati, OH: U.S. Environmental Protection Agency, Office of Toxic Substances.

EPA. 1985b. Chemical, physical and biological properties of compounds present at hazardous waste sites. Report to U.S. Environmental Protection Agency, Office of Solid Waste and Emergency Response, Washington, DC, by Clement Associates, Inc., Arlington, VA.

\*EPA. 1985c. Locating and emitting air emissions from sources of manganese. Research Triangle Park, NC: U.S. Environmental Protection Agency, Office of Air Quality Planning and Standards. EPA450484007h.

\*EPA. 1985d. Decision not to regulate manganese under the Clean Air Act. U.S. Environmental Protection Agency. Fed Regist 50:32627-32628.

EPA. 1986a. Acid digestion of sediments, sludges, and soils—method 3050. In: Test methods for evaluating solid waste. 3rd ed. SW-846. Washington, DC: U.S. Environmental Protection Agency, Office of Solid Waste and Emergency Response.

EPA. 1986b. Inductively coupled plasma atomic emission spectroscopy—method 6010. In: Test methods for evaluating solid waste. 3rd ed. SW-846. Washington, DC: U.S. Environmental Protection Agency, Office of Solid Waste and Emergency Response.

\*EPA. 1986c. Manganese (atomic absorption, direct aspiration)—method 7460. In: Test methods for evaluating solid waste. 3rd ed. SW-846. Washington, DC: U.S. Environmental Protection Agency, Office of Solid Waste and Emergency Response.

\*EPA. 1986d. Air quality criteria for lead. Research Triangle Park, NC: U.S. Environmental Protection Agency, Office of Research and Development, Office of Health and Environmental Assessment, Environmental Criteria and Assessment Office. EPA600833028F.

\*EPA. 1987a. Toxic air pollutant/source crosswalk: A screening tool for locating possible sources emitting toxic air pollutants. Research Triangle Park, NC: U.S. Environmental Protection Agency, Office of Air Quality Planning and Standards. EPA450487023a.

EPA. 1987b. U.S. Environmental Protection Agency: Part II. Fed Regist 52:13400.

EPA. 1988a. U.S. Environmental Protection Agency: Part II. Fed Regist 53:4500-4501.

EPA. 1988b. Reportable quantity document for tricarbonylmethylcyclopentadienyl manganese. Cincinnati, OH: U.S. Environmental Protection Agency, Office of Solid Waste and Emergency Response. ECAO-CIN-R566.

## 9. REFERENCES

- \*EPA. 1990. Interim methods for development of inhalation reference concentrations. Washington, DC: U.S. Environmental Protection Agency, Office of Health and Environmental Assessment, Office of Research and Development, Environmental Criteria and Assessment Office. EPA600890066A.
- EPA. 1993a. U.S. Environmental Protection Agency. Code of Federal Regulations. 40 CFR 302.4.
- \*EPA. 1993b. Drinking water criteria document for manganese. Cincinnati, OH: U.S. Environmental Protection Agency. ECAO-CIN-D008
- \*EPA. 1994b. Method 200.8. Determination of trace elements in waters and wastes by inductively coupled plasma-mass spectrometry. Revision 5.4. EMMC version. U.S. Environmental Protection Agency. [http://www.epa.gov/waterscience/methods/method/files/200\\_8.pdf](http://www.epa.gov/waterscience/methods/method/files/200_8.pdf). May 02, 2008.
- \*EPA. 1994a. Methods for derivation of inhalation reference concentrations and application of inhalation dosimetry. Washington, DC: U.S. Environmental Protection Agency, Office of Research and Development. EPA600890066F.
- \*EPA. 1995a. Fuels and fuel additives; grant of waiver application. Fed Regist 60. U.S. Environmental Protection Agency.:36414. <http://frwebgate4.access.gpo.gov/cgi-bin/PDFgate.cgi?WAISdocID=279770422119+5+1+0&WAISaction=retrieve>. July 28, 2008.
- \*EPA. 1995b. Proceedings: Workshop on the bioavailability and oral toxicity of manganese. Washington, DC: Environmental Criteria and Assessment Office, Office of Research and Development, Office of Science and Technology, Office of Water, U.S. Environmental Protection Agency.
- \*EPA. 1997. Special report on environmental endocrine disruption: An effects assessment and analysis. Washington, DC: U.S. Environmental Protection Agency, Risk Assessment Forum. EPA630R96012.
- \*EPA. 1998. Announcement of the drinking water contaminant candidate list. U.S. Environmental Protection Agency. Fed Regist 63:10274-10287. [http://frwebgate.access.gpo.gov/cgi-bin/getdoc.cgi?IPaddress=frwais.access.gpo.gov&dbname=1998\\_register&docid=98-5313-filed.pdf](http://frwebgate.access.gpo.gov/cgi-bin/getdoc.cgi?IPaddress=frwais.access.gpo.gov&dbname=1998_register&docid=98-5313-filed.pdf). May 5, 2008.
- \*EPA. 2000. Benchmark dose technical guidance document. Washington, DC: U.S. Environmental Protection Agency. EPA630R00001.
- \*EPA. 2003a. Health effects support document for manganese. U.S. Environmental Protection Agency. EPA822R03003. [http://www.epa.gov/safewater/ccl/pdfs/reg\\_determine1/support\\_cc1\\_magnese\\_healtheffects.pdf](http://www.epa.gov/safewater/ccl/pdfs/reg_determine1/support_cc1_magnese_healtheffects.pdf). April 07, 2008.
- \*EPA. 2003b. National primary drinking water regulations. Washington, DC: U.S. Environmental Protection Agency, Office of Ground Water and Drinking Water. EPA816F03016. <http://www.epa.gov/safewater/mcl.html>. March 07, 2006.
- \*EPA. 2004. Drinking water health advisory for manganese. U.S. Environmental Protection Agency. [http://www.epa.gov/safewater/ccl/pdfs/reg\\_determine1/support\\_cc1\\_magnese\\_dwreport.pdf](http://www.epa.gov/safewater/ccl/pdfs/reg_determine1/support_cc1_magnese_dwreport.pdf). June 19, 2008.
- \*EPA. 2005. Toxic chemical release inventory reporting forms and instructions: Revised 2004 version. Section 313 of the Emergency Planning and Community Right-to-Know Act (Title III of the Superfund



## 9. REFERENCES

Amendments and Reauthorization Act of 1986). U.S. Environmental Protection Agency. Office of Environmental Information. EPA260B05001.

\*EPA. 2006a. 2006 Edition of the drinking water standards and health advisories. Washington, DC: U.S. Environmental Protection Agency. EPA822R06013.  
<http://www.epa.gov/waterscience/criteria/drinking/dwstandards.pdf>. April 11, 2007.

\*EPA. 2006b. High production volume (HPV) challenge program. Final submission for methylcyclopentadienyl manganese tricarbonyl (MMTr). U.S. Environmental Protection Agency.  
<http://www.epa.gov/chemrtk/pubs/summaries/mthmtri/c14889rt.pdf>. April 10, 2008.

\*EPA. 2006c. National recommended water quality criteria. Washington, DC: U.S. Environmental Protection Agency, Office of Water, Office of Science and Technology.  
<http://www.epa.gov/waterscience/criteria/nrwqc-2006.pdf>. January 08, 2008.

\*EPA. 2007a. Method 6010C. Inductively coupled plasma-atomic emission spectrometry. U.S. Environmental Protection Agency. <http://www.epa.gov/sw-846/pdfs/6010c.pdf>. May 02, 2008.

\*EPA. 2007b. 2006 Urban air toxics monitoring program (UATMP) final report. U.S. Environmental Protection Agency. EPA454R08001.  
[http://www.epa.gov/ttnamti1/files/ambient/airtox/2006\\_uatmp\\_final\\_report.pdf](http://www.epa.gov/ttnamti1/files/ambient/airtox/2006_uatmp_final_report.pdf). May 02, 2008.

\*EPA. 2008a. Acute exposure guideline levels (AEGLs). Second AEGL chemical priority list. U.S. Environmental Protection Agency. [http://www.epa.gov/oppt/aegl/pubs/priority\\_2.htm](http://www.epa.gov/oppt/aegl/pubs/priority_2.htm). April 24, 2008.

\*EPA. 2008b. Designation of hazardous substances. U.S. Environmental Protection Agency. Code of Federal Regulations. 40 CFR 116.4. <http://www.epa.gov/lawsregs/search/40cfr.html>. April 24, 2008.

\*EPA. 2008c. Designation of hazardous substances. U.S. Environmental Protection Agency. Code of Federal Regulations. 40 CFR 302.4. <http://www.epa.gov/lawsregs/search/40cfr.html>. April 24, 2008.

\*EPA. 2008d. Determination of reportable quantities. U.S. Environmental Protection Agency. Code of Federal Regulations. 40 CFR 117.3. <http://www.epa.gov/lawsregs/search/40cfr.html>. April 24, 2008.

\*EPA. 2008e. Inert ingredients permitted for use in nonfood use pesticide products. Washington, DC: U.S. Environmental Protection Agency. <http://www.epa.gov/opprd001/inerts/lists.html>. April 24, 2008.

\*EPA. 2008f. The list of extremely hazardous substances and their threshold planning quantities. U.S. Environmental Protection Agency. Code of Federal Regulations. 40 CFR 355, Appendix A.  
<http://www.epa.gov/lawsregs/search/40cfr.html>. April 24, 2008.

\*EPA. 2008g. Toxic chemical release reporting. Chemicals and chemical categories to which this part applies. U.S. Environmental Protection Agency. Code of Federal Regulations. 40 CFR 372.65.  
<http://www.epa.gov/lawsregs/search/40cfr.html>. April 24, 2008.

Ericson JE, Crinella FM, Clarke-Stewart KA, et al. 2007. Prenatal manganese levels linked to childhood behavioral disinhibition. *Neurotoxicol Teratol* 29:181-187.

\*Erikson K, Aschner M. 2002. Manganese causes differential regulation of glutamate transporter (GLAST) taurine transporter and metallothionein in cultured rat astrocytes. *Neurotoxicology* 23(4-5):595-602.

## 9. REFERENCES

- \*Erikson KM, Aschner M. 2003. Manganese neurotoxicity and glutamate-GABA interaction. *Neurochem Int* 43:475-480.
- +\*Erikson KM, Dorman DC, Fitsanakis V, et al. 2006. Alterations of oxidative stress biomarkers due to in utero and neonatal exposures of airborne manganese. *Biol Trace Elem Res* 111(1-3):199-215.
- Erikson KM, Dorman DC, Lash LH, et al. 2004. Airborne manganese exposure differentially affects endpoints of oxidative stress in age- and sex-dependent manner. *Biol Trace Elem Res* 100: 49-62.
- +\*Erikson KM, Dorman DC, Lash LH, et al. 2007. Manganese inhalation by Rhesus monkeys is associated with brain regional changes in biomarkers of neurotoxicity. *Toxicol Sci* 97(2):459-466.
- +\*Erikson KM, John CE, Jones SR, et al. 2005. Manganese accumulation in striatum of mice exposed to toxic doses is dependent upon a functional dopamine transporter. *Environ Toxicol Pharmacol* 20:390-394.
- Erikson KM, Suber RL, Aschner M. 2002. Glutamate/aspartate transporter (GLAST), taurine transporter and metallothionein mRNA levels are differentially altered in astrocytes exposed to manganese chloride, manganese phosphate or manganese sulfate. *Neurotoxicology* 23:281-288.
- \*Eriksson H, Gillberg PG, Aquilonius SM, et al. 1992a. Receptor alterations in manganese intoxicated monkeys. *Arch Toxicol* 66:359-364.
- +\*Eriksson H, Lenngren S, Heilbronn E. 1987a. Effect of long-term administration of manganese on biogenic amine levels in discrete striatal regions of rat brain. *Arch Toxicol* 59:426-431.
- +\*Eriksson H, Magiste K, Plantin LO, et al. 1987b. Effects of manganese oxide on monkeys as revealed by a combined neurochemical, histological and neurophysiological evaluation. *Arch Toxicol* 61:46-52.
- +\*Eriksson H, Tedroff J, Thuomas K, et al. 1992b. Manganese induced brain lesions in *Macaca fascicularis* as revealed by positron emission tomography and magnetic resonance imaging. *Arch Toxicol* 66:403-407.
- \*Evans LJ. 1989. Chemistry of metal retention by soils: Several processes are explained. *Environ Sci Technol* 23:1046-1056.
- +\*Exon JH, Koller LD. 1975. Effects of feeding manganese antiknock gasoline additive exhaust residues ( $Mn_3O_4$ ) in rats. *Bull Environ Contam Toxicol* 14:370-373.
- Fang G, Wu Y, Wen C, et al. 2006. Ambient air particulate concentrations and metallic elements principal component analysis at Taichung Harbor (TH) and WuChi Traffic (WT) near Tawian Strait during 2004-2005. *J Hazard Mater* 2006:314-323.
- \*FDA. 2007a. Beverages. Bottled water. U.S. Food and Drug Administration. Code of Federal Regulations. 21 CFR 165.110. <http://www.accessdata.fda.gov/scripts/cdrh/cfdocs/cfcr/CFRSearch.cfm>. April 24, 2008.
- \*FDA. 2007b. Indirect food additives: Adhesives and components of coatings. U.S. Food and Drug Administration. Code of Federal Regulations. 21 CFR 175. 105. <http://www.accessdata.fda.gov/scripts/cdrh/cfdocs/cfcr/CFRSearch.cfm>. April 24, 2008.

## 9. REFERENCES

- \*FDA. 2007c. Food ingredients and packaging. Summary of color additives listed for use in the United States in food, drugs, cosmetics, and medical devices. U.S. Department of Health and Human Services. U.S. Food and Drug Administration. Center for Food Safety and Applied Nutrition. <http://www.cfsan.fda.gov/~dms/opa-col2.html>. June 17, 2008.
- \*FDA. 2008. Everything added to food in the United States (EAFUS). U.S. Food and Drug Administration. <http://vm.cfsan.fda.gov/~dms/eafus.html>. April 24, 2008.
- Fechter LD. 1999. Distribution of manganese in development. *Neurotoxicology* 20:197-201.
- \*Fechter LD, Johnson DL, Lynch RA. 2002. The relationship of particle size to Olfactory nerve uptake of non-soluble form of manganese into brain. *Neurotoxicology* 23:177-183.
- \*Federle MP, Chezmar JL, Rubin DL, et al. 2000. Safety and efficacy of mangafodipir trisodium (MnDPDP) injection for hepatic MRI in adults: Results of the U.S. multicenter phase III clinical trials (safety). *J Magn Reson Imaging* 12(1):186-197.
- \*FEDRIP. 2008. Manganese. Federal Research in Progress database. Springfield, VA: National Technical Information Service.
- Fee JA, Shapiro ER, Moss, TH. 1976. Direct evidence for manganese (III) binding to the manganosuperoxide dismutase of *Escherichia coli* B. *J Biol Chem* 251:6157-6159.
- Feldman RG. 1992. Manganese as possible etiologic factor in Parkinson's disease. *Ann NY Acad Sci* 648:266-267.
- \*Fell JM, Reynolds AP, Meadows N, et al. 1996. Manganese toxicity in children receiving long-term parenteral nutrition. *Lancet* 347:1218-1221.
- \*Fernandez MA, Martinez L, Segarra M, et al. 1992. Behavior of heavy metals in the combustion gases of urban waste incinerators. *Environ Sci Technol* 26:1040-1047.
- Ferraz HB, Bertolucci PH, Pereira JS, et al. 1988. Chronic exposure to the fungicide maneb may produce symptoms and signs of CNS manganese intoxication. *Neurology* 38:550-553.
- Filipov NM, Seegal RF, Lawrence DA. 2005. Manganese potentiates in vitro production of proinflammatory cytokines and nitric oxide by microglia through a nuclear factor kappa B-dependent mechanism. *Toxicol Sci* 84:139-148.
- Finkelstein MM, Jerret M. 2007. A study of the relationships between Parkinson's disease and markers of traffic-derived and environmental manganese air pollution in two Canadian cities. *Environ Res* 104:420-432.
- Finkelstein MM, Boulard M, Wilk N. 1991. Increased risk of lung cancer in the melting department of a second Ontario steel manufacturer. *Am J Ind Med* 19:183-194.
- Finley JW. 1999. Manganese absorption and retention by young women is associated with serum ferritin concentration. *Am J Clin Nutr* 70:37-43.

## 9. REFERENCES

Finley JW. 2004. Does environmental exposure to manganese pose a health risk to healthy adults? Brief critical review. *Nutr Rev* 62(4):148-153.

+\*Finley JW, Caton JS, Zhou Z, et al. 1997. A surgical model for determination of true adsorption and biliary excretion of manganese in conscious swine fed commercial diets. *J Nutr* 127:2334-2341.

+\*Finley JW, Penland JG, Pettit RE, et al. 2003. Dietary manganese intake and type of lipid do not affect clinical or neuropsychological measures in healthy young women. *J Nutr* 133:2849-2856.

Fisher AA. 1983. Occupational dermatitis from pesticides: Patch testing procedures. *Current Contact News* 31:483-508.

+Fishman BE, McGinley PA, Gianutsos G. 1987. Neurotoxic effects of methylcyclopentadienyl manganese tricarbonyl (MMT) in the mouse: Basis of MMT-induced seizure activity. *Toxicology* 45:193-201.

\*Fitsanakis VA, Aschner M. 2005. The importance of glutamate, glycine, and  $\gamma$ -aminobutyric acid transport and regulation in manganese, mercury and lead neurotoxicity. *Toxicol Appl Pharmacol* 204:343-354.

\*Fitsanakis VA, Au C, Erikson KM, et al. 2006. The effects of manganese on glutamate, dopamine and  $\gamma$ -aminobutyric acid regulation. *Neurochem Int* 48:426-433.

Fitsanakis VA, Piccola G, Aschner JL, et al. 2005. Manganese transport by rat brain endothelial (RBE4) cell-based transwell model in the presence of astrocyte conditioned media. *J Neurosci Res* 81:235-243.

+Flaten TP, Bolviken B. 1991. Geographical associations between drinking water chemistry and the mortality and morbidity of cancer and some other diseases in Norway. *Sci Total Environ* 102:75-100.

Florence TM, Stauber JL. 1988. Neurotoxicology of manganese [Letter]. *Lancet* 1:363.

\*FNB/IOM. 2001. Manganese. Dietary reference intakes for vitamin A, vitamin K, arsenic, boron, chromium, copper, iodine, iron, manganese, molybdenum, nickel, silicon, vanadium, and zinc (2000). A Report of the Panel on Micronutrients, subcommittees on upper reference levels of nutrients and of interpretation and uses of dietary reference intakes, and the standing committee on the scientific evaluation of dietary reference intakes. Washington, DC: Food and Nutrition Board. Institute of Medicine. National Academy Press, 394-419.  
[http://books.nap.edu/openbook.php?record\\_id=10026&page=394](http://books.nap.edu/openbook.php?record_id=10026&page=394). April 03, 2008.

\*Folsom TR, Young DR, Johnson JN, et al. 1963. Manganese-54 and zinc-65 in coastal organisms of California. *Nature* 200:327-329.

\*Fomon SJ. 1966. Body composition of the infant: Part I: The male reference infant. In: Falkner F, ed. *Human development*. Philadelphia, PA: WB Saunders, 239-246.

\*Fomon SJ, Haschke F, Ziegler EE, et al. 1982. Body composition of reference children from birth to age 10 years. *Am J Clin Nutr* 35(Suppl 5):1169-1175.

+\*Forbes GM, Forbes A. 1997. Micronutrient status in patients receiving home parenteral nutrition. *Nutrition* 13:941-944.

## 9. REFERENCES

- +\*Fore H, Morton RA. 1952. Manganese in rabbit tissues. *Biochem J* 51:600-603.
- Fored CM, Fryzek JP, Brandt L, et al. 2006. Parkinson's disease and other basal ganglia or movement disorders in large nationwide cohort of Swedish welders. *Occup Environ Med* 63:135-140.
- \*Francis AJ. 1985. Anaerobic microbial dissolution of toxic metals in subsurface environments. Upton, NY: Brookhaven National Laboratory. BNL-36571.
- Francis CW, White GH. 1987. Leaching of toxic metals from incinerator ashes. *J Water Pollut Control Fed* 59:979-986.
- Freeland-Graves J. 1994. Derivation of manganese estimated safe and adequate daily dietary intakes. In: Mertz W, Abernathy CO, Olin SS, eds. *Risk assessment of essential elements*. Washington, DC: International Life Sciences Institute Press.
- \*Freeland-Graves JH, Bales CW, Behmardi F. 1987. Manganese requirements of humans. Nutritional bioavailability of manganese. *American Chemical Society*, 90-104.
- Freitag D, Ballhorn L, Geyer H, et al. 1985. Environmental hazard profile of organic chemicals: An experimental method for the assessment of the behaviour of organic chemicals in the ecosphere by means of simple laboratory tests with <sup>14</sup>C labelled chemicals. *Chemosphere* 14:1589-1616.
- Fridovich I. 1974. Superoxide dismutases. *Adv Enzymol* 41:35-97.
- \*Friedman BJ, Freeland-Graves JH, Bales CW, et al. 1987. Manganese balance and clinical observations in young men fed a manganese-deficient diet. *J Nutr* 117:133-143.
- \*Furchner JE, Richmond CR, Drake GA. 1966. Comparative metabolism of radionuclides in mammals III. *Health Phys* 12:1415-1423.
- +\*Furst A. 1978. Tumorigenic effect of an organomanganese compound on F344 rats and Swiss albino mice [Brief communication]. *J Natl Cancer Inst* 60:1171-1173.
- \*Gand VS, Vohra K, Chai F. 1992. Determination of tricarbonyl(2-methylcyclopentadienyl) manganese in gasoline and air by gas chromatography with electron-capture detection. *Analyst* 117:161-164.
- Gallez B, Bacic G, Swartz HM. 1996a. Evidence for the dissociation of the hepatobiliary MRI contrast agent Mn-DPDP. *Magn Reson Med* 35:14-19.
- Gallez B, Baudelet C, Adline J, et al. 1996b. The uptake of Mn-DPDP by hepatocytes is not mediated by the facilitated transport of pyridoxine. *Magn Reson Imaging* 14(10):1191-1195.
- \*Gallez B, Baudelet C, Adline J, et al. 1997. Accumulation of manganese in the brain of mice after intravenous injection of manganese-based contrast agents. *Chem Res Toxicol* 10:360-363.
- \*Galloway SM, Armstrong MJ, Reuben C, et al. 1987. Chromosome aberrations and sister chromatid exchanges in Chinese hamster ovary cells: Evaluations of 108 chemicals. *Environ Mol Mutagen* 1 (Suppl. 10):1-175.
- Gao Y, Leermakers M, Elskens M, et al. 2007. High resolution profiles of thallium, manganese and iron assessed by DET and DGT techniques in riverine sediment pore waters. *Sci Total Environ* 373:526-533.

## 9. REFERENCES

- +\*Garcia SJ, Gellein K, Syversen T, et al. 2006. A manganese-enhanced diet alters brain metals and transporters in the developing rat. *Toxicol Sci* 92(2):516-525.
- +\*Garcia SJ, Gellein K, Syversen T, et al. 2007. Iron deficient and manganese supplemented diets alter metals and transporters in the developing rat brain. *Toxicol Sci* 95(1):205-217.
- +\*Garcia-Aranda JA, Lifshitz F, Wapnir RA. 1984. Intestinal absorption of manganese in experimental malnutrition. *J Pediatr Gastroenterol Nutr* 3:602-607.
- +\*Garcia-Aranda JA, Wapnir RA, Lifshitz F. 1983. In vivo intestinal absorption of manganese in the rat. *J Nutr* 113:2601-2607.
- Garner CD, Nachtman JP. 1989a. Manganese catalyzed auto-oxidation of dopamine to 6-hydroxydopamine in vitro. (Erratum on: *Chem Biol Interact* 69:345-351). *Chem Biol Interact* 71(2-3):309.
- \*Garner CD, Nachtman JP. 1989b. Manganese catalyzed auto-oxidation of dopamine to 6-hydroxydopamine in vitro. (Erratum in: *Chem Biol Interact* 71(2-3):309). *Chem Biol Interact* 69:345-351.
- \*Garrison AW, Cipollone MG, Wolfe NL, et al. 1995. Environmental fate of methylcyclopentadienyl manganese tricarbonyl. *Environ Toxicol Chem* 14(11):1859-1864.
- Garruto RM, Shankar SK, Yanagihara R, et al. 1989. Low-calcium, high-aluminum diet-induced motor neuron pathology in cynomolgus monkeys. *Acta Neuropathol* 78:210-219.
- \*Gavin CE, Gunter KK, Gunter TE. 1990. Manganese and calcium efflux kinetics in brain mitochondria. Relevance to manganese toxicity. *Biochem J* 266:329-334.
- +\*Gavin CE, Gunter KK, Gunter TE. 1992. Mn<sup>2+</sup> sequestration by mitochondria and inhibition of oxidative phosphorylation. *Toxicol Appl Pharmacol* 115:1-5.
- \*Gavin CE, Gunter KK, Gunter TE. 1999. Manganese and calcium transport in mitochondria: Implications for manganese toxicity. *Neurotoxicology* 20:445-454.
- \*Geering HR, Hodgson JF, Sdano C. 1969. Micronutrient cation complexes in soil solution: IV. The chemical state of manganese in soil solution. *Soil Sci Soc Amer Proc* 33:81-85.
- +\*Gennart JP, Buchet JP, Roels H, et al. 1992. Fertility of male workers exposed to cadmium, lead, or manganese. *Am J Epidemiol* 135:1208-1219.
- Georgian L, Moraru I, Draghicescu T, et al. 1983. Cytogenetic effects of alachlor and mancozeb. *Mutat Res* 116:341-348.
- Gerber GB, Leonard A, Hantson P. 2002. Carcinogenicity, mutagenicity and teratogenicity of manganese compounds. *Crit Rev Oncol Hematol* 42:25-34.
- +Gerdin B, McCann E, Lundberg C, et al. 1985. Selective tissue accumulation of manganese and its effect on regional blood flow and hemodynamics after intravenous infusion of its chloride salt in the rat. *Int J Tissue React* 7(5):373-380.

## 9. REFERENCES

- Ghio AJ, Bennet WD. 2007. Metal particles are inappropriate for testing a postulate of extrapulmonary transport. *Environ Health Perspect* 115(2):70-71.
- +\*Gianutsos G, Murray MT. 1982. Alterations in brain dopamine and GABA following inorganic or organic manganese administration. *Neurotoxicology* 3:75-81.
- +\*Gianutsos G, Morrow GR, Morris JB. 1997. Accumulation of manganese in rat brain following intranasal administration. *Fundam Appl Toxicol* 37:102-105.
- +\*Gianutsos G, Seltzer MD, Saymeh R, et al. 1985. Brain manganese accumulation following systemic administration of different forms. *Arch Toxicol* 57(4):272-275.
- \*Gibbons RA, Dixon SN, Hallis K, et al. 1976. Manganese metabolism in cows and goats. *Biochim Biophys Acta* 444:1-10.
- +\*Gibbs JP, Crump KS, Houck DP, et al. 1999. Focused medical surveillance: A search for subclinical movement disorders in a cohort of U.S. workers exposed to low levels of manganese dust. *Neurotoxicology* 20:299-313.
- Gibson RS. 1994. Content and bioavailability of trace elements in vegetarian diets. *Am J Clin Nutr* 59:1223s-1232s.
- Gilmore DA Jr, Bronstein AC. 1992. Manganese and magnesium. In: Sullivan JB, Drieger GR, eds. *Hazardous materials toxicology, clinical principles of environmental health*. Baltimore, MD: Williams and Wilkins, 896-902.
- \*Giwerzman A, Carlsen E, Keiding N, et al. 1993. Evidence for increasing incidence of abnormalities of the human testis: A review. *Environ Health Perspect Suppl* 101(2):65-71.
- \*Glass E. 1955. Untersuchungen über die einwirkung von schwermetallsalzen auf die wurzelspitzenmitose von *Vicia faba*. *Zeitschrift fuer Botanik* 43:359-403.
- \*Glass E. 1956. Untersuchungen über die einwirkung von schwermetallsalzen auf die wurzelspitzenmitose von *Vicia faba*. *Zeitschrift fuer Botanik* 44:1-58.
- Goering PL, Fowler BA. 1985. Mechanisms of renal lead-binding protein protection against lead-inhibition of delta-aminolevulinic acid dehydratase. *J Pharmacol Exp Ther* 234:365-371.
- \*Goering PL, Klaassen CD. 1985. Mechanism of manganese-induced tolerance to cadmium lethality and hepatotoxicity. *Biochem Pharmacol* 34:1371-1379.
- \*Goldsmith J, Herishanu Y, Abarbanel J, et al. 1990. Clustering of Parkinson's disease points to environmental etiology. *Arch Env Health* 45(2):88-94.
- +\*Golub MS, Hogrefe CE, Germann SL, et al. 2005. Neurobehavioral evaluation of rhesus monkey infants fed cow's milk formula, soy formula, or soy formula with added manganese. *Neurotoxicol Teratol* 27(4):615-627.
- Gonzalez RC, Gonzalez-Chavez MCA. 2006. Metal accumulation in wild plants surrounding mining wastes. *Environ Pollut* 144:84-92.

## 9. REFERENCES

- Goodson PA, Glerup J, Hodgson DJ, et al. 1991. Syntheses and characterization of binuclear manganese (III, IV) and (IV, IV) complexes with ligands related to N,N'-bis(2-pyridylmethyl)-1,2-ethanediamine. *Inorg Chem* 30:4909-4914.
- Goodson PA, Hodgson DJ, Glerup J, et al. 1992. Syntheses and characterization of binuclear manganese (III, IV) and (IV, IV) complexes with 1,4,7,10-tetraazacyclododecane (cyclen). *Inorg Chim Acta* 197:141-147.
- +Gordon CJ, Fogelson L, Highfill JW. 1990. Hypothermia and hypometabolism: Sensitive indices of whole-body toxicity following exposure to metallic salts in the mouse. *J Toxicol Environ Health* 29:185-200.
- +Gorell JM, Johnson CC, Rybicki BA, et al. 1997. Occupational exposures to metals as risk factors for Parkinson's disease. *Neurology* 48:137-145.
- +\*Gorell JM, Johnson CC, Rybicki BA, et al. 1999. Occupational exposure to manganese, copper, lead, iron, mercury, and zinc and the risk of Parkinson's disease. *Neurotoxicology* 20:239-248.
- Gosselin RE, Smith RP, Hodge HC, et al. 1984. *Clinical toxicology of commercial products*. 5th ed. Baltimore, MD: Williams and Wilkins, II-144-II-145.
- +\*Gottschalk LA, Rebello T, Buchsbaum MS, et al. 1991. Abnormalities in hair trace elements as indicators of aberrant behavior. *Comp Psych* 32:229-237.
- \*Graedel TE. 1978. Inorganic elements, hydrides, oxides, and carbonates. In: *Chemical compounds in the atmosphere*. New York, NY: Academic Press, 35-41, 44-49.
- \*Graham DG. 1984. Catecholamine toxicity: A proposal for the molecular pathogenesis of manganese neurotoxicity and Parkinson's disease. *Neurotoxicology* 5:83-95.
- +\*Grant D, Blazak WF, Brown GL. 1997a. The reproductive toxicology of intravenously administered MnDPDP in the rat and rabbit. *Acta Radiol* 38:759-769.
- \*Grant D, Refsum H, Rummeny E, et al. 1997b. Editorial on MnDPDP. *Acta Radiol* 38:623-625.
- \*Grant D, Zech K, Holtz E. 1994. Biodistribution and in vivo stability of manganese dipyridoxyl diphosphate in relation to imaging efficacy. *Invest Radiol* 29:S249-S250.
- +\*Gray LE, Laskey JW. 1980. Multivariate analysis of the effects of manganese on the reproductive physiology and behavior of the male house mouse. *J Toxicol Environ Health* 6:861-867.
- \*Greger JL. 1998. Dietary standards for manganese: Overlap between nutritional and toxicological studies. *J Nutr* 128(2 Suppl):368S-371S.
- \*Greger JL. 1999. Nutrition versus toxicology of manganese in humans: Evaluation of potential biomarkers. *Neurotoxicology* 20:205-212.
- \*Greger JL, Davis CD, Suttie JW, Lyle BJ, et al. 1990. Intake, serum concentrations and urinary excretion of manganese by adult males. *Am J Clin Nutr* 51(3):457-461.



## 9. REFERENCES

- +\*Gruden N, Matausic S. 1989. Some factors influencing cadmium-manganese interaction in adult rats. *Bull Environ Contam Toxicol* 43:101-106.
- Guilarte TR, Chen M. 2007. Manganese inhibits NMDA receptor channel function: Implications to psychiatric and cognitive effects. *Neurotoxicology* 28:1147-1152.
- \*Guilarte TR, Burton NC, Verina T, et al. 2008. Increased APLP1 expression and neurodegeneration in the frontal cortex of manganese-exposed non-human primates. *J Neurochem* [Epub ahead of print]:1-12.
- \*Guilarte TR, Chen M, McGlothan JL. 2006a. Nigrostriatal dopamine system dysfunction and subtle motor deficits in manganese-exposed non-human primates. *Exp Neurol* 2002:381-390.
- \*Guilarte TR, McGlothan JL, Degaonkar M, et al. 2006b. Evidence for cortical dysfunction and widespread manganese accumulation in the nonhuman primate brain following chronic manganese exposure: A 1H-MRS and MRI study. *Toxicol Sci* 94(2):351-358.
- Gulson B, Mizon K, Taylor A, et al. 2006. Changes in manganese and lead in the environment and young children associated with the introduction of methylcyclopentadienyl manganese tricarbonyl in gasoline—preliminary results. *Environ Res* 100:100-114.
- Gunter KK, Aschner M, Miller LM, et al. 2005. Determining the oxidation states of manganese in PC12 and nerve growth factor-induced PC12 cells. *Free Radic Biol Med* 39:164-181.
- Gunter KK, Aschner A, Miller LM, et al. 2006. Determining the oxidation states of manganese in NT2 cells and cultured astrocytes. *Neurobiol Aging* 27:1816-1826.
- Gunter TE, Miller LM, Gavin CE, et al. 2004. Determination of the oxidation states of manganese in brain, liver, and heart mitochondria. *J Neurochem* 88:266-280.
- Gupta KP, Mehrota NK. 1992. Status of ornithine decarboxylase activity and DNA synthesis in mancozeb-exposed mouse skin. *Carcinogenesis* 13:131-133.
- +\*Gupta SK, Murthy RC, Chandra SV. 1980. Neuromelanin in manganese-exposed primates. *Toxicol Lett* 6:17-20.
- Gutierrez AJ, Gonzalez-Weller D, Gonzales T, et al. 2007. Content of trace metals (iron, zinc, manganese, chromium, copper, nickel) in canned variegated scallops (*Chlamys varia*). *Int J Food Sci Nutr* [Epub ahead of print].
- \*Guzelian PS, Henry CJ, Olin SS, eds. 1992. Similarities and differences between children and adults: Implications for risk assessment. Washington, DC: International Life Sciences Institute Press.
- \*Gwiazda R, Lucchini R, Smith D. 2007. Adequacy and consistency of animal studies to evaluate the neurotoxicity of chronic low-level manganese exposure to humans. *J Toxicol Environ Health* 70(7):594-605.
- Gwiazda RH, Lee D, Sheridan J, et al. 2002. Low cumulative manganese exposure affects striatal GABA but not dopamine. *Neurotoxicology* 23:69-76.
- \*Haddad CM, Shannon MW, Winchester JF, eds. 1998. In: *Clinical management of poisoning and drug overdose*. 3rd ed. Philadelphia, PA: WB Saunders, 796-797.

## 9. REFERENCES

- +\*Hafeman D, Factor-Litvak P, Cheng Z, et al. 2007. Association between manganese exposure through drinking water and infant mortality in Bangladesh. *Environ Health Perspect* 115:1107-1112.
- +Hakkinen PJ, Haschek WM. 1982. Pulmonary toxicity of methylcyclopentadienyl manganese tricarbonyl: Nonciliated bronchiolar epithelial (Clara) cell necrosis and alveolar damage in the mouse, rat, and hamster. *Toxicol Appl Pharmacol* 65:11-22.
- +\*Halatek T, Hermans C, Broeckeaert F, et al. 1998. Quantification of Clara cell protein in rat and mouse biological fluids using a sensitive immunoassay. *Eur Respir J* 11:726-733.
- Halatek T, Sinczuk-Walczak H, Rydzynski K. 2008. Early neurotoxic effects of inhalation exposure to aluminum and/or manganese assessed by serum levels of phospholipid-binding Clara cells protein. *J Toxicol Environ Health A* 43(2):118-124.
- Halatek T, Sinczuk-Walczak H, Szymczak M, et al. 2005. Neurological and respiratory symptoms in shipyard welders exposed to manganese. *Int J Occup Med Environ Health* 18(3):265-274.
- Hall ED, Symonds HW, Mallinson CB. 1982. Maximum capacity of the bovine liver to remove manganese from portal plasma and the effect of the route of entry of manganese on its rate of removal. *Res Vet Sci* 33:89-94.
- \*Halliwell B. 1984. Manganese ions, oxidation reactions and the superoxide radical. *Neurotoxicology* 5:113-118.
- +\*HaMai D, Rinderknecht AL, Guo-Sharman K, et al. 2006. Decreased expression of inflammation-related genes following inhalation exposure to manganese. *Neurotoxicology* 27:395-401.
- \*Hambidge KM, Sokol RJ, Fidanza SJ, et al. 1989. Plasma manganese concentrations in infants and children receiving parenteral nutrition. *J Parenter Enteral Nutr* 13(2):168-171.
- Hams GA, Fabri JK. 1988. An analysis for blood manganese used to assess environmental exposure. *Clin Chem* 34:1121-1123.
- Han SG, Kim Y, Kashon ML, et al. 2005. Correlates of oxidative stress and free-radical activity in serum from asymptomatic shipyard welders. *Am J Respir Crit Care Med* 172:1541-1548.
- +\*Hanzlik RP, Bhatia P, Stitt R, et al. 1980a. Biotransformation and excretion of methylcyclopentadienyl manganese tricarbonyl in the rat. *Drug Metab Dispos* 8:428-433.
- \*Hanzlik RP, Harkness CE, Arnoldi S. 1979. Gas chromatographic determination of methylcyclopentadienyl manganese tricarbonyl in biological tissues and fluids. *J Chromatogr* 171:279-283.
- +\*Hanzlik RP, Stitt R, Traiger GJ. 1980b. Toxic effects of methylcyclopentadienyl manganese tricarbonyl (MMT) in rats: Role of metabolism. *Toxicol Appl Pharmacol* 56:353-360.
- Harper ER, St. Leger JA, Westberg JA, et al. 2007. Tissue heavy metal concentrations of stranded California sea lions (*Zalophus californianus*) in Southern California. *Environ Pollut* 147:677-682.

## 9. REFERENCES

- Harris MK, Ewing WM, Longo W, et al. 2005. Manganese exposures during shielded metal arc welding (SMAW) in an enclosed space. *J Occup Environ Hyg* 2:375-382.
- Hart DA. 1978. Evidence that manganese inhibits an early event during stimulation of lymphocytes by mitogens. *Exp Cell Res* 113:139-150.
- Haschek WM, Hakkinen PJ, Witschi HP, et al. 1982. Nonciliated bronchiolar epithelial (Clara) cell necrosis induced by organometallic carbonyl compounds. *Toxicol Lett* 14:85-92.
- Haug BA, Schoenle PW, Karch BJ, et al. 1989. Morvan's fibrillary chorea. A case with possible manganese poisoning. *Clin Neurol Neurosurg* 91:53-59.
- +\*Hauser RA, Zesiewicz TA, Martinez C, et al. 1996. Blood manganese correlates with brain magnetic resonance imaging changes in patients with liver disease. *Can J Neurol Sci* 23:95-98.
- +\*Hauser RA, Zesiewicz TA, Rosemurgy AS, et al. 1994. Manganese intoxication and chronic liver failure. *Ann Neurol* 36:871-875.
- \*HazDat. 2008. Manganese. HazDat Database: ATSDR's Hazardous Substance Release and Health Effects Database. Atlanta, GA: Agency for Toxic Substances and Disease Registry. <http://www.atsdr.cdc.gov/hazdat.html>. May 1, 2008.
- Hazell AS. 2002. Astrocytes and manganese neurotoxicity. *Neurochem Int* 41:271-277.
- Hazell AS, Desjardins P, Butterworth RF. 1999. Increased expression of glyceraldehyde-3-phosphate dehydrogenase in cultured astrocytes following exposure to manganese. *Neurochem Int* 35:11-17.
- \*Hazell AS, Normandin L, Norenberg MD, et al. 2006. Alzheimer type II astrocytic changes following sub-acute exposure to manganese and its prevention by antioxidant treatment. *Neurosci Lett* 396:167-171.
- He SC, Niu Q. 2004. Subclinical neurophysiological effects of manganese in welding workers. *Int J Immunopathol Pharmacol* 17(2):11-16.
- +\*He P, Liu D, Zhang G, et al. 1994. [Effects of high-level manganese sewage irrigation on children's neurobehavior.] *Chung Hua Yu Fang I Hsueh Tsa Chih* 28:216-218. (Chinese).
- Headley JV, Massiah W, Laberge D, et al. 1996. Rapid screening for mancozeb in exposure trials by inductively coupled plasma-atomic emission spectrometric determination of manganese. *J AOAC Int* 79:1184-1188.
- \*Health Canada. 2008. Human health risk assessment for inhaled manganese. Draft. Health Canada. [http://www.hc-sc.gc.ca/ewh-semt/alt\\_formats/hecs-sesc/pdf/air/out-ext/\\_consult/draft\\_ebauche/manganese\\_e.pdf](http://www.hc-sc.gc.ca/ewh-semt/alt_formats/hecs-sesc/pdf/air/out-ext/_consult/draft_ebauche/manganese_e.pdf). May 07, 2008.
- Heilig E, Molina R, Donaghey T, et al. 2005. Pharmacokinetics of pulmonary manganese absorption: Evidence for increased susceptibility to manganese loading in iron-deficient rats. *Am J Physiol Lung Cell Mol Physiol* 288:L887-L893.
- Helling CS, Dennison DG, Kaufman DD. 1974. Fungicide movement in soils. *Phytopathology* 64:1091-1100.

## 9. REFERENCES

- \*Hellou J, Fancey LL, Payne JF. 1992. Concentrations of twenty-four elements in bluefin tuna, *Thunnus thynnus* from the Northwest Atlantic. *Chemosphere* 24:211-218.
- \*Helz GR, Huggett RJ, Hill JM. 1975. Behavior of Mn, Fe, Cu, Zn, Cd and Pb discharged from a wastewater treatment plant into an estuarine environment. *Water Research* 9:631-636.
- \*Hemstock GA, Low PF. 1953. Mechanisms responsible for retention of manganese in the colloidal fraction of soil. *Soil Science* 76:331-343.
- Henriksson J, Tjalve H. 2000. Manganese taken up into the CNS via the olfactory pathway in rats affects astrocytes. *Toxicol Sci* 55:392-398.
- \*Henriksson J, Tallkvist J, Tjälve H. 1999. Transport of manganese via the olfactory pathway in rats: Dosage dependency of the uptake and subcellular distribution of the metal in the olfactory epithelium and the brain. *Toxicol Appl Pharmacol* 156:119-128.
- Herrero Hernandez E, Discalzi G, Dassi P, et al. 2003. Manganese intoxication: The cause of an inexplicable epileptic syndrome in a 3 year old child. *Neurotoxicology* 24:633-639.
- Herrero Hernandez EH, Discalzi G, Valentini C, et al. 2006. Follow-up of patients affected by manganese-induced Parkinsonism after treatment with  $\text{CaNa}_2\text{EDTA}$ . *Neurotoxicology* 27:333-339.
- Higashi Y, Asanuma M, Miyazaki I, et al. 2004. Parkin attenuates manganese-induced dopaminergic cell death. *J Neurochem* 89:1490-1497.
- Higo A, Ohtake N, Saruwatari K, et al. 1996. Photoallergic contact dermatitis from mancozeb, an agricultural fungicide. *Contact Dermatitis* 35:183.
- +\*Hinderer RK. 1979. Toxicity studies of methylcyclopentadienyl manganese tricarbonyl (MMT). *Am Ind Hyg Assoc J* 40:164-167.
- Hirata Y, Meguro T, Kiuchi K. 2006. Differential effect of nerve growth factor on dopaminergic neurotoxin-induced apoptosis. *J Neurochem* 99:416-425.
- Hirata Y, Suzuno H, Tsuruta T, et al. 2008. The role of dopamine transporter in selective toxicity of manganese and rotenone. *Toxicology* 244:249-256.
- \*Hobbesland A, Kjuus H, Thelle DS. 1997a. Mortality from nonmalignant respiratory diseases among male workers in Norwegian ferroalloy plants. *Scand J Work Environ Health* 23:342-350.
- +\*Hobbesland A, Kjuus H, Thelle DS. 1997b. Mortality from cardiovascular diseases and sudden death in ferroalloy plants. *Scand J Work Environ Health* 23:334-341.
- \*Hoel DG, Davis DL, Miller AB, et al. 1992. Trends in cancer mortality in 15 industrialized countries, 1969-1986. *J Natl Cancer Inst* 84(5):313-320.
- +\*Holbrook DJ Jr, Washington ME, Leake HB, et al. 1975. Studies on the evaluation of the toxicity of various salts of lead, manganese, platinum, and palladium. *Environ Health Perspect* 10:95-101.

## 9. REFERENCES

- +\*Holzgraefe M, Poser W, Kijewski H, et al. 1986. Chronic enteral poisoning caused by potassium permanganate: A case report. *J Toxicol Clin Toxicol* 24:235-244.
- +\*Hong JS, Hung CR, Seth PK, et al. 1984. Effect of manganese treatment on the levels of neurotransmitters, hormones, and neuropeptides: Modulation by stress. *Environ Res* 34:242-249.
- Hope S, Daniel K, Gleason KL, et al. 2006. Influence of tea drinking on manganese intake, manganese status and leucocyte expression of MnSOD and cytosolic aminopeptidase P. *Eur J Clin Nutr* 60:1-8.
- \*HSDB. 2008. Manganese. Hazardous Substances Data Bank. National Library of Medicine. <http://toxnet.nlm.nih.gov>. April 17, 2008.
- Hsieh C, Liang J, Peng SS, et al. 2007. Seizure associated with total parenteral nutrition-related hypermanganesemia. *Pediatr Neurol* 36:181-183.
- +Hua MS, Huang CC. 1991. Chronic occupational exposure to manganese and neurobehavioral function. *J Clin Exp Neuropsychol* 13:495-507.
- +\*Huang C, Chu N, Lu C, et al. 1989. Chronic manganese intoxication. *Arch Neurol* 46:1104-1106.
- \*Huang C, Chu N, Lu C, et al. 1998. Long-term progression in chronic manganism. Ten years of follow-up. *Neurology* 50:698-700.
- Huang C, Chu N, Lu C, et al. 2007. The natural history of neurological manganism over 18 years. *Parkinsonism Relat Disord* 13:143-145.
- Huang C, Weng Y, Lu C, et al. 2003. Dopamine transporter binding in chronic manganese intoxication. *J Neurol* 250:1335-1339.
- Huang Y, Jin B, Zhong Z, et al. 2004. Trace elements (Mn, Cr, Pb, Se, Zn, Cd and Hg) in emissions from a pulverized coal boiler. *86:23-32*.
- Hudnell HK. 1999. Effects from environmental Mn exposures: A review of the evidence from non-occupational exposure studies. *Neurotoxicology* 20:379-398.
- \*Hurley LS, Keen CL. 1987. Manganese. In: Mertz W, ed. Trace elements in human and animal nutrition, 5th Ed., Vol. 1. San Diego, CA: Academic Press, Inc., 185-223.
- +Hurley LS, Keen CL, Baly DL. 1984. Manganese deficiency and toxicity: Effects on carbohydrate metabolism in the rat. *Neurotoxicology* 5:97-104.
- Hurley LS, Woolley DE, Timiras PS. 1961. Threshold and pattern of electro shock seizures in ataxic manganese-deficient rats. *Proc Soc Exp Biol Med* 106:343-346.
- +\*Hussain S, Lipe GW, Slikker W, et al. 1997. The effects of chronic exposure of manganese on antioxidant enzymes in different regions of rat brain. *Neurosci Res Commun* 21:135-144.
- +\*Hustvedt SO, Grant D, Southon TE, et al. 1997. Plasma pharmacokinetics, tissue distribution, and excretion of MnDPDP in the rat and dog after intravenous administration. *Acta Radiologica* 38:690-699.

## 9. REFERENCES

- Hylin JW. 1973. Oxidative decomposition of ethylene-bis-dithiocarbamates. *Bull Environ Contam Toxicol* 10:227-233.
- Hylin JW, Kawano Y, Chang W. 1978. An ultraviolet absorption method for the analysis of maneb formulations. *Bull Environ Contam Toxicol* 20:840-845.
- +\*Hysell DK, Moore W, Stara JF, et al. 1974. Oral toxicity of methylcyclopentadienyl manganese tricarbonyl (MMT) in rats. *Environ Res* 7:158-168.
- IARC. 1982. IARC monographs on the evaluation of the carcinogenic risk of chemicals to humans: Chemicals, industrial processes and industries associated with cancer in humans. Vol. 1 to 29, Supplement 4. International Agency for Research on Cancer, Lyon, France.
- IARC. 1986. IARC monographs on the evaluation of the carcinogenic risk of chemicals to humans. Tobacco smoking. Vol. 38. Lyon, France: International Agency for Research on Cancer.:114-116.
- \*IARC. 2008. Agents reviewed by the IARC monographs: Volumes 1-99. Lyon, France: International Agency for Research on Cancer. <http://monographs.iarc.fr/ENG/Classification/index.php>. April 24, 2008.
- \*Ibim SE, Trotman J, Musey PI, et al. 1992. Depletion of essential elements by calcium disodium EDTA treatment in the dog. *Toxicology* 73:229-237.
- \*ICCT. 2004. Status report concerning the use of MMT in gasoline. International Council on Clean Transportation. [http://www.theicct.org/documents/MMT\\_ICCT\\_2004.pdf](http://www.theicct.org/documents/MMT_ICCT_2004.pdf). May 07, 2008.
- \*Ihara K, Hijii T, Kuromaru R, et al. 1999. High-intensity basal ganglia lesions on T1-weighted images in two toddlers with elevated blood manganese with portosystemic shunts. *Neuroradiology* 41(3):195-198.
- Ikeda M, Ohisuji H. 1972. A comparative study of the excretion of Fujiwara reaction-positive substances in urine of humans and rodents given trichloro- or tetrachloro-dreivatives of ethane and ethylene. *Br J Ind Med* 29:99-104.
- Ikeda S, Yamaguchi Y, Sera Y, et al. 2000. Manganese deposition in the globus pallidus in patients with biliary atresia. *Transplantation*. 69(11):2339-2343.
- Iliev D, Elsner P. 1997. Allergic contact dermatitis from the fungicide Rondo-M® and the insecticide Alfacron®. *Contact Dermatitis* 36:51.
- +Imam Z, Chandra SV. 1975. Histochemical alterations in rabbit testis produced by manganese chloride. *Toxicol Appl Pharmacol* 32:534-544.
- \*Ingersoll RT, Montgomery EB, Aposhian HV. 1995. Central nervous system toxicity of manganese. I. Inhibition of spontaneous motor activity in rats after intrathecal administration of manganese chloride. *Fundam Appl Toxicol* 27:106-113.
- \*Ingersoll RT, Montgomery EB, Aposhian HV. 1999. Central nervous system toxicity of manganese II: Cocaine or reserpine inhibit manganese concentration in the rat brain. *Neurotoxicology* 20:467-476.

## 9. REFERENCES

- +\*Iregren A. 1990. Psychological test performance in foundry workers exposed to low levels of manganese. *Neurotoxicol Teratol* 12:673-675.
- \*Iregren A. 1994. Using psychological tests for the early detection of neurotoxic effects of low level manganese exposure. *Neurotoxicology* 15(3):671-677.
- \*Iregren A. 1999. Manganese neurotoxicity in industrial exposures: Proof of effects, critical exposure level, and sensitive tests. *Neurotoxicology* 20:315-324.
- \*IRIS. 1993. Integrated Risk Information System. U.S. Environmental Protection Agency, Washington, DC.
- \*IRIS. 2008. Manganese. Integrated Risk Information System. Washington, DC: U.S. Environmental Protection Agency. <http://www.epa.gov/iris/subst/index.html>. April 24, 2008.
- IRPTC. 1989. International Register of Potentially Toxic Chemicals. United Nations Environment Programme, Geneva, Switzerland. September 1989.
- Isaac AO, Kawikova I, Bothwell ALM, et al. 2006. Manganese treatment modulates the expression of peroxisome proliferator-activated receptors in astrocytoma and neuroblastoma cells. *Neurochem Res* 31:1305-1316.
- +\*Ishizuka H, Nishida M, Kawada J. 1991. Changes in stainability observed by light microscopy in the brains of ataxial mice subjected to three generations of manganese administration. *Biochem Int* 25:677-687.
- Israeli R, Sculsky M, Tiberin P. 1983a. Acute central nervous system changes due to intoxication by Manzidan (a combined dithiocarbamate of maneb and zineb). *Arch Toxicol Suppl* 6:238-243.
- Israeli R, Sculsky M, Tiberin P. 1983b. Acute intoxication due to exposure to maneb and zineb: A case with behavioral and central nervous system changes. *Scand J Work Environ Health* 9:47-51.
- \*Ito K, Yamamoto K, Kawanishi S. 1992. Manganese-mediated oxidative damage of cellular and isolated DNA by isoniazid and related hydrazines: Non-Fenton-type hydroxyl radical formation. *Biochemistry* 31(46):11606-11613.
- Ito Y, Oh-hashii K, Kiuchi K, et al. 2006. p44/42 MAP kinase and c-Jun N-terminal kinase contribute to the up-regulation of caspase-3 in manganese-induced apoptosis in PC12 cells. *Brain Res* 1099:1-7.
- +\*Iwami O, Watanabe T, Moon CS, et al. 1994. Motor neuron disease on the Kii Peninsula of Japan: Excess manganese intake from food coupled with low magnesium in drinking water as a risk factor. *Sci Total Environ* 149:121-135.
- Iyengar GV. 1987. Reference values for the concentrations of As, Cd, Co, Cr, Cu, Fe, I, Hg, Mn, Mo, Pb, Se, and Zn in selected human tissues and body fluids. *Biol Trace Elem Res* 12:263-295.
- Jablonická A, Polakova H, Karellova J, et al. 1989. Analysis of chromosome aberrations and sister-chromatid exchanges in peripheral blood lymphocytes of workers with occupational exposure to the mancozeb-containing fungicide Novozir Mn80. *Mutat Res* 224(2):143-146.

## 9. REFERENCES

- Janaki-Raman D, Jonathan MP, Srinivasalu S, et al. 2007. Trace metal enrichments in core sediments in Muthupet mangroves, SE coast of India: Application of acid leachable technique. *Environ Pollut* 145:245-257.
- Jankovic J. 2005. Searching for a relationship between manganese and welding and Parkinson's disease. *Neurology* 64:2021-2028.
- +\*Jarvinen R, Ahlström A. 1975. Effect of the dietary manganese level on tissue manganese, iron, copper and zinc concentrations in female rats and their fetuses. *Med Biol* 53:93-99.
- +\*Jarvisalo J, Olkinuora M, Kiilunen M, et al. 1992. Urinary and blood manganese in occupationally nonexposed populations and in manual metal arc welders of mild steel. *Int Arch Occup Environ Health* 63:495-501.
- \*Jaudon P, Massiani C, Galea J, et al. 1989. Groundwater pollution by manganese. Manganese speciation: Application to the selection and discussion of an in situ groundwater treatment. *Sci Total Environ* 84:169-183.
- +\*Jiang Y, Lu J, Mai H, et al. 1996a. [Effects of manganese exposure on ECG and blood pressure.] *Ind Health Occup Dis* 22:341-343. (Chinese).
- +\*Jiang Y, Lu J, Xie P, et al. 1996b. [Effects of manganese on the sexual function and reproductive outcome of male exposed workers]. *Chi J Ind Hyg Occup Dis* 14:271-273. (Chinese).
- \*Jiang Y, Mo X, Du F, et al. 2006. Effective treatment of manganese-induced occupational Parkinsonism with p-aminosalicylic acid: A case of 17-year follow-up study. *J Occup Environ Med* 48:644-649.
- \*Jiang Y, Zheng W, Long L, et al. 2007. Brain magnetic resonance imaging and manganese concentrations in red blood cells of smelting workers: Search for biomarkers of manganese exposure. *Neurotoxicology* 28:126-135.
- +\*Joardar M, Sharma A. 1990. Comparison of clastogenicity of inorganic manganese administered in cationic and anionic forms in vivo. *Mutat Res* 240:159-163.
- \*Johanson CE. 1980. Permeability and vascularity of the developing brain: Cerebellum vs cerebral cortex. *Brain Res* 190(1):3-16.
- Johnson CA. 1976. The determination of some toxic metals in human liver as a guide to normal levels in New Zealand. Part I. Determination of Bi, Cd, Cr, Co, Cu, Pb, Mn, Ni, Ag, Tl and Zn. *Anal Chim Acta* 81:69-74.
- +\*Johnson PE, Korynta ED. 1992. Effects of copper, iron, and ascorbic acid on manganese availability to rats. *Proc Soc Exp Biol Med* 199:470-480.
- +\*Johnson PE, Lykken GI, Korynta ED. 1991. Absorption and biological half-life in humans of intrinsic and extrinsic <sup>54</sup>Mn tracers from foods of plant origin. *J Nutr* 121(5):711-717.
- \*Johnston CG, Kipphut GW. 1988. Microbially mediated Mn(II) oxidation in an oligotrophic arctic lake. *Appl Environ Microbiol* 54:1440-1445.



## 9. REFERENCES

- Jordan LW, Neal RA. 1979. Examination of the in vivo metabolism of maneb and zineb to ethylenethiourea (ETU) in mice. *Bull Environ Contam Toxicol* 22:271-277.
- \*Josephs KA, Ahlskog Je, Klos KJ, et al. 2005. Neurologic manifestations in welders with pallidal MRI T1 hyperintensity. *Neurology* 64:2033-2039.
- \*Judde JG, Breillout F, Clemenceau C, et al. 1987. Inhibition of rat natural killer cell function by carcinogenic nickel compounds: Preventive action of manganese. *J Natl Cancer Inst* 78:1185-1190.
- \*Kabata-Pendias A, Pendias H. 1984. Trace elements in soils and plants. Boca Raton, FL: CRC Press, Inc.
- Kackar R, Srivastava MK, Raizada RB. 1997a. Induction of gonadal toxicity to male rats after chronic exposure to mancozeb. *Indust Health* 35:104-111.
- Kackar R, Srivastava MK, Raizada RB. 1997b. Studies on the rat thyroid after oral administration of mancozeb: Morphological and biochemical evaluations. *J Appl Toxicol* 17:369-375.
- \*Kafritsa Y, Fell J, Long S, et al. 1998. Long term outcome of brain manganese deposition in patients on home parenteral nutrition. *Arch Dis Child* 79:263-265.
- +\*Kagamimori S, Makino T, Hiramaru Y, et al. 1973. [Studies of effects on the respiratory organs of air pollution through dust consisting mainly of manganese.] *Nippon Koshu Eisei Zasshi [Japanese Journal of Public Health]* 20:413-421. (Japanese).
- \*Kalea AZ, Lamari FN, Theocharis AD, et al. 2006. Dietary manganese affects the concentration, composition and sulfation pattern of heparan sulfate glycosaminoglycans in Sprague-Dawley rat aorta. *Biometals* 19(5):535-546.
- Kamata N, Oshitani N, Oiso R, et al. 2003. Crohn's disease with Parkinsonism due to long-term total parenteral nutrition. *Dig Dis Sci* 48(5):992-994.
- \*Kanematsu N, Hara M, Kada T. 1980. Rec assay and mutagenicity studies on metal compounds. *Mutat Res* 77:109-116.
- Kannan K, Perrotta E, Thomas NJ. 2006. Association between perfluorinated compounds and pathological conditions in southern sea otters. *Environ Sci Technol* 40:4943-4948.
- Kara K, Gupta AK, Kumar A, et al. 2006. Characterization and identification of the sources of chromium, zinc, lead, cadmium, nickel, manganese and iron in PM10 particulates at the two sites of Kolkata, India. *Environ Monit Assess* 120:347-360.
- +\*Karlsson JOG, Mortensen E, Pedersen HK, et al. 1997. Cardiovascular effects of MnDPDP and MnCl<sub>2</sub> in dogs with acute ischaemic heart failure. *Acta Radiologica* 38:750-758.
- +Kato M. 1963. Distribution and excretion of radiomanganese administered to the mouse. *Q J Exp Physiol* 48:355-369.
- +\*Katsuragi T, Takahashi T, Shibuya K, et al. 1996. [A Parkinsonism patient exhibiting high-signal intensity in the globus pallidus on T1-weighted MRI of the head: The correlation with manganese poisoning.] *Clin Neurol* 36:780-782. (Japanese).

## 9. REFERENCES

- +\*Kawamura R, Ikuta H, Fukuzumi S, et al. 1941. Intoxication by manganese in well water. *Kitasato Arch Exp Med* 18:145-171.
- Kawano J, Ney DM, Keen CL, et al. 1987. Altered high density lipoprotein composition in manganese-deficient Sprague-Dawley and Wistar rats. *J Nutr* 117:902-906.
- Keen CL, Leach RM. 1988. Manganese. In: Seiler HG, Sigel H, eds. *Handbook on toxicity of inorganic compounds*. New York, NY: Marcel Dekker, Inc.,
- \*Keen CL, Zidenberg-Cher S. 1990. Manganese. In: Brown M, ed. *Present knowledge in nutrition*, sixth edition. Washington, DC: International Life Sciences Institute Nutrition Foundation, 279-286.
- Keen CL, Zidenberg-Cherr S. 1994. Manganese toxicity in humans and experimental animals. In: Klimis-Tavantzis DL, ed. *Manganese in health and disease*. Boca Raton, LA: CRC Press, 194-205.
- +\*Keen CL, Bell JG, Lönnnerdal B. 1986. The effect of age on manganese uptake and retention from milk and infant formulas in rats. *J Nutr* 116:395-402.
- Keen CL, Ensunsa JL, Watson MH, et al. 1999. Nutritional aspects of manganese from experimental studies. *Neurotoxicology* 20:213-223.
- Keen CL, Tamura T, Lönnnerdal B, et al. 1985. Changes in hepatic superoxide dismutase activity in alcoholic monkeys. *Am J Clin Nutr* 41:929-932.
- Keller J, Owens CT, Lai JCK, et al. 2005. The effects of 17 $\beta$ -estradiol and ethanol on zinc- or manganese-induced toxicity in SK-N-SH cells. *Neurochem Int* 46:293-303.
- Kempton S, Sterritt RM, Lester JN. 1987. Heavy metal removal in primary sedimentation. I. The influence of metal solubility. *Sci Total Environ* 63:231-246.
- Kenangil G, Ertan S, Sayilir I, et al. 2006. Progressive motor syndrome in a welder with pallidal T1 hyperintensity on MRI: A two-year follow-up. *Mov Disord* 21(12):2197-2262.
- \*Kent C. 1998. *Basics of toxicology*. New York: John Wiley and Sons, 90.
- Keppel GE. 1971. Collaborative study of the determination of the dithiocarbamate residues by a modified carbon disulfide evolution method. *J Assoc Off Anal Chem* 54(3):528-532.
- +Khan KN, Andress JM, Smith PF. 1997. Toxicity of subacute intravenous manganese chloride administration in beagle dogs. *Toxicol Pathol* 25:344-350.
- Khan PK, Sinha SP. 1996. Ameliorating effect of vitamin C on murine sperm toxicity induced by three pesticides (endosulfan, phosphamidon and macozeb). *Mutagenesis* 11(1):33-36.
- Kiebertz K, Kurlan R. 2005. Welding and Parkinson disease (Comment on: *Neurology* 2005; 64:230-235, 2021-2028 & 2033-2039). *Neurology* 64:2001-2003.
- +\*Kihira T, Mukoyama M, Ando K, et al. 1990. Determination of manganese concentrations in the spinal cords from amyotrophic lateral sclerosis patients by inductively coupled plasma emission spectroscopy. *J Neurol Sci* 98:251-258.

## 9. REFERENCES

- +\*Kilburn CJ. 1987. Manganese, malformations and motor disorders: Findings in a manganese-exposed population. *Neurotoxicology* 8:421-429.
- Kiloh LG, Lethlean AK, Morgan G, et al. 1980. An endemic neurological disorder in tribal Australian aborigines. *J Neurol Neurosurg Psychiat* 43:661-668.
- Kim EA, Cheong H, Choi DS, et al. 2007a. Effect of occupational manganese exposure on the central nervous system of welders: <sup>1</sup>H magnetic resonance spectroscopy and MRI findings. *Neurotoxicology* 28:276-283.
- Kim EA, Cheong H, Joo K, et al. 2007b. Effect of manganese exposure on the neuroendocrine system in welders. *Neurotoxicology* 28:263-269.
- \*Kim Y, Kim JW, Ito K, et al. 1999. Idiopathic Parkinsonism with superimposed manganese exposure: Utility of positron emission tomography. *Neurotoxicology* 20:249-252.
- Kimura T, Kuroki K, Doi K. 1998. Dermatotoxicity of agricultural chemicals in the dorsal skin of hairless dogs. *Toxicol Pathol* 26:442-447.
- Kitazawa M, Anantharam V, Yang Y, et al. 2005. Activation of protein kinase Cd by proteolytic cleavage contributes to manganese-induced apoptosis in dopaminergic cells: Protective role of Bcl-2. *Biochem Pharmacol* 69:133-146.
- Kitazawa M, Wagner JR, Kirby ML, et al. 2002. Oxidative stress and mitochondrial-mediated apoptosis in dopaminergic cells exposed to methylcyclopentadienyl manganese tricarbonyl. *J Pharmacol Exp Ther* 302(1):26-35.
- +\*Klaassen CD. 1974. Biliary excretion of manganese in rats, rabbits, and dogs. *Toxicol Appl Pharmacol* 29:458-468.
- Klaassen CD, Amdur MO, Doull J, eds. 1986. Casarett and Doull's toxicology: The basic science of poisons. New York, NY: Macmillan Publishing Company, 348, 350, 381, 614.
- Kleibl K, Ráčková M. 1980. Cutaneous allergic reactions to dithiocarbamates. *Contact Dermatitis* 6:348-349.
- \*Kleinman MT, Pasternack BS, Eisenbud M, et al. 1980. Identifying and estimating the relative importance of airborne particulates. *Environ Sci Technol* 14:62-65.
- \*Klos KJ, Ahlshog E, Josephs KA, et al. 2005. Neurologic spectrum of chronic liver failure and basal ganglia T1 hyperintensity on magnetic resonance imaging. *Arch Neurol* 62:1385-1390.
- \*Klos KJ, Chandler M, Kumar N, et al. 2006. Neuropsychological profiles of manganese neurotoxicity. *Eur J Neurol* 13(10):1139-1141.
- \*Kneip TJ, Crable JV, eds. 1988a. Metals in blood or tissue - method 118. In: *Methods for biological monitoring*. Washington, DC: American Public Health Association, 221-228.
- Kneip TJ, Crable JV, eds. 1988b. Metals in urine—method 119. In: *Methods for biological monitoring*. Washington, DC: American Public Health Association, 229-235.

## 9. REFERENCES

- +Knudsen E, Sandstrom B, Andersen O. 1995. Zinc and manganese bioavailability from human milk and infant formula used for very low birthweight infants, evaluated in a rat pup model. *Biol Trace Elem Res* 49:53-65.
- Kobayashi K, Kuroda J, Shibata N, et al. 2007. Induction of metallothionein by manganese is completely dependent on interleukin-6 production. *J Pharmacol Exp Ther* 320(2):721-727.
- Koch P. 1996. Occupational allergic contact dermatitis and airborne contact dermatitis from 5 fungicides in a vineyard worker: Cross-reactions between fungicides of the dithiocarbamate group? *Contact Dermatitis* 34:324-329.
- Koizumi A, Shiojima S, Omiya M, et al. 1979. Acute renal failure and maneb (manganous ethylenebis[dithiocarbamate]) exposure. *JAMA* 242:2583-2585.
- Koller WC, Lyons KE. 2004. Effect of levodopa treatment for Parkinsonism in welders: A double-blind study. *Neurology* 63:1541-1544.
- Koller WC, Lyons KE, Truly W. 2004. Effect of levodopa treatment Parkinsonism in welders. *Neurology* 62:730-733.
- Komaki H, Maisawa S-i, Sugai K, et al. 1999. Tremor and seizures associated with chronic manganese intoxication. *Brain Dev* 21:122-124.
- \*Komori M, Nishio K, Kitada M, et al. 1990. Fetus-specific expression of a form of cytochrome P-450 in human livers. *Biochemistry* 29(18):4430-4433.
- Komulainen H, Savolainen K. 1985. Effect of dithiocarbamate fungicides and thiurams on 3H-haloperidol binding in rat brain. *Arch Toxicol Suppl* 8:77-79.
- +\*Komura J, Sakamoto M. 1991. Short-term oral administration of several manganese compounds in mice: Physiological and behavioral alterations caused by different forms of manganese. *Bull Environ Contam Toxicol* 46:921-928.
- +\*Komura J, Sakamoto M. 1992a. Disposition, behavior, and toxicity of methylcyclopentadienyl manganese tricarbonyl in the mouse. *Arch Environ Contam Toxicol* 23:473-475.
- +\*Komura J, Sakamoto M. 1992b. Effects of manganese forms on biogenic amines in the brain and behavioral alterations in the mouse: Long-term oral administration of several manganese compounds. *Environ Res* 57:34-44.
- +\*Komura J, Sakamoto M. 1994. Chronic oral administration of methylcyclopentadienyl manganese tricarbonyl altered brain biogenic amines in the mouse: Comparison with inorganic manganese. *Toxicol Lett* 73:65-73.
- +\*Kondakis XG, Makris N, Leotsinidis M, et al. 1989. Possible health effects of high manganese concentration in drinking water. *Arch Environ Health* 44:175-178.
- Kono Y, Fridovich I. 1983. Isolation and characterization of the pseudocatalase of *Lactobacillus plantarum*: A new manganese-containing enzyme. *J Biol Chem* 258:6015-6019.

## 9. REFERENCES

- +\*Kontur PJ, Fechter LD. 1985. Brain manganese, catecholamine turnover, and the development of startle in rats prenatally exposed to manganese. *Teratology* 32:1-11.
- +\*Kontur PJ, Fechter LD. 1988. Brain regional manganese levels and monoamine metabolism in manganese-treated neonatal rats. *Neurotoxicol Teratol* 10:295-303.
- Kool HJ, van Kreijl CF, Zoeteman BC. 1982. Toxicology assessment of organic compounds in drinking water. *CRC Crit Rev Environ Control* 12:307, 347.
- \*Kopp JF, Kroner RC. 1967. Trace metals in waters of the United States. A five year summary of trace metals in rivers and lakes of the United States (Oct. 1, 1962 - Sept. 30, 1967). Cincinnati, OH: U.S. Department of the Interior, Federal Water Pollution Control Administration. NTIS No. PB-215680.
- +\*Kostial K, Blanusa M, Maljkovic T, et al. 1989. Effect of a metal mixture in diet on the toxicokinetics and toxicity of cadmium, mercury and manganese in rats. *Toxicol Ind Health* 5:685-698.
- Kostial K, Blanusa M, Piasek M. 2005. Regulation of manganese accumulation in perinatally exposed rat pups. *J Appl Toxicol* 25:89-93.
- +\*Kostial K, Kello D, Jugo S, et al. 1978. Influence of age on metal metabolism and toxicity. *Environ Health Perspect* 25:81-86.
- \*Krishnan K, Andersen ME. 1994. Physiologically based pharmacokinetic modeling in toxicology. In: Hayes AW, ed. *Principles and methods of toxicology*. 3rd ed. New York, NY: Raven Press, Ltd., 149-188.
- \*Krishnan K, Andersen ME, Clewell HJ, et al. 1994. Physiologically based pharmacokinetic modeling of chemical mixtures. In: Yang RSH, ed. *Toxicology of chemical mixtures: Case studies, mechanisms, and novel approaches*. San Diego, CA: Academic Press, 399-437.
- Krishnan KP, Fernandes SO, Chandan GS, et al. 2007. Bacterial contribution to mitigation of iron and manganese in mangrove sediments. *Mar Pollut Bull* 54:1427-1433.
- +\*Kristensson K, Eriksson H, Lundh B, et al. 1986. Effects of manganese chloride on the rat developing nervous system. *Acta Pharmacol Toxicol* 59:345-348.
- Kuhn NJ, Ward S, Pionski M, et al. 1995. Purification of human hepatic arginase and its manganese (II)-dependent and pH-dependent interconversion between active and inactive forms: A possible pH sensing function of the enzyme on the ornithine cycle. *Arch Biochem Biophys* 320:24-34.
- Kuo Y, Herligy AH, So P, et al. 2005. In vivo measurements of T1 relaxation times in mouse brain associated with different modes of systemic administration of manganese chloride. *J Magn Reson Imaging* 21:334-339.
- Kurtio P, Savolainen K. 1990. Ethylenethiourea in air and in urine as an indicator of exposure to ethylenebisdithiocarbamate fungicides. *Scand J Work Environ Health* 16:203-207.
- Kurtio P, Vartiainen T, Savolainen K. 1990. Environmental and biological monitoring of exposure to ethylenebisdithiocarbamate fungicides and ethylenethiourea. *Br J Ind Med* 47:203-206.

## 9. REFERENCES

Kwik-Urbe C, Smith DR. 2006. Temporal responses in the disruption of iron regulation by manganese. *J Neurosci Res* 83:1601-1610.

Lai JC, Leung TK, Lim L. 1982. The ontogeny of acetylcholinesterase activities in rat brain regions and the effect of chronic treatment with manganese chloride. *J Neurochem* 39:1767-1769.

+\*Lai JC, Leung TK, Lim L. 1984. Differences in the neurotoxic effects of manganese during development and aging: Some observations on brain regional neurotransmitter and non-neurotransmitter metabolism in a developmental rat model of chronic manganese

+\*Lai JC, Leung TK, Lim L, et al. 1991. Effects of chronic manganese treatment on rat brain regional sodium-potassium-activated and magnesium-activated adenosine triphosphatase activities during development. *Metab Brain Dis* 6:165-174.

+Lai JC, Minski MJ, Chan AW, et al. 1981. Brain regional manganese distribution after chronic manganese treatment. *Biochem Soc Trans* 9:228.

\*Lai JCK, Minski MH, Chan AWK, et al. 1999. Manganese mineral interactions in brain. *Neurotoxicology* 20:433-444.

Laisi A, Tuominen R, Mannisto P, et al. 1985. The effect of maneb, zineb, and ethylenethiourea on the humoral activity of the pituitary-thyroid axis in rat. *Arch Toxicol Suppl* 8:253-258.

+\*Laitung JK, Mercer DM. 1983. Manganese absorption through a burn. *Burns Incl Therm Inj* 10:145-146.

Langston JW, Irwin I, Ricaurte GA. 1987. Neurotoxins, parkinsonism and Parkinson's disease. *Pharmacol Ther* 32:19-49.

\*Larsen LE, Grant D. 1997. General toxicology of MnDPDP. *Acta Radiol* 38:770-779.

Larsson KS, Arnander C, Cekanova E, et al. 1976. Studies of teratogenic effects of the dithiocarbamates maneb, mancozeb, and propineb. *Teratology* 14:171-183.

+\*Laskey JW, Rehnberg GL, Hein JF, et al. 1985. Assessment of the male reproductive system in the pre-weanling rat following Mn<sub>3</sub>O<sub>4</sub> exposure. *J Toxicol Environ Health* 15:339-350.

+\*Laskey JW, Rehnberg GL, Hein JF. 1982. Effects of chronic manganese (Mn<sub>3</sub>O<sub>4</sub>) exposure on selected reproductive parameters in rats. *J Toxicol Environ Health* 9:677-687.

Latchoumycandane C, Anantharam V, Kitazawa M, et al. 2005. Protein kinase C is a key downstream mediator of manganese-induced apoptosis in dopaminergic neuronal cells. *J Pharmacol Exp Ther* 313(1):46-55.

+\*Lauwerys R, Roels H, Genet P, et al. 1985. Fertility of male workers exposed to mercury vapor or to manganese dust: A questionnaire study. *Am J Ind Med* 7:171-176.

\*Lauwerys RR, Bernard A, Roels H, et al. 1992. Health risk assessment of long term exposure to chemicals: Application to cadmium and manganese. *Arch Toxicol Suppl* 15:97-102.

## 9. REFERENCES

- Lawrence DA. 1981. Heavy metal modulation of lymphocyte activities. I. In vitro effects of heavy metals on primary humoral immune responses. *Toxicol Appl Pharmacol* 57:439-451.
- Leach RM. 1984. Manganese in enteral and parenteral nutrition. *Bull NY Acad Med* 60:172-176.
- \*Leach RM, Lilburn MS. 1978. Manganese metabolism and its function. *World Rev Nutr Diet* 32:123-134.
- \*Leavens TL, Rao D, Andersen ME, et al. 2007. Evaluating transport of manganese from olfactory mucosa to straitum by pharmacokinetic modeling. *Toxicol Sci* 97(2):265-278
- Lee B, Hiney JK, Pine MD, et al. 2007. Manganese stimulates luteinizing hormone releasing hormone secretion in prepubertal female rats: Hypothalamic site and mechanism of action. *J Physiol* 578(Pt 3):765-772.
- \*Lee B, Pine M, Johnson L, et al. 2006. Manganese acts centrally to activate reproductive hormone secretion and pubertal development in male rats. *Reproductive Toxicology* 22:580-585.
- \*Leeder JS, Kearns GL. 1997. Pharmacogenetics in pediatrics: Implications for practice. *Pediatr Clin North Am* 44(1):55-77.
- Lees-Haley PR, Greiffenstein MF, Larrabee GJ, et al. 2004. Methodological problems in the neuropsychological assessment of effects of exposure to welding fumes and manganese. *Clin Neuropsychol* 18:449-464.
- \*Leikin JB, Paloucek JB. 2002. Leikin and Paloucek's poisoning and toxicology handbook. Hudson, OH: Lexi-Comp, Inc., 773-774.
- \*Leung HW. 1993. Physiologically-based pharmacokinetic modelling. In: Ballentyne B, Marrs T, Turner P, eds. *General and applied toxicology*. Vol. 1. New York, NY: Stockton Press, 153-164.
- +Leung TK, Lai JC, Lim L. 1981. The regional distribution of monoamine oxidase activities towards different substrates: Effects in rat brain of chronic administration of manganese chloride and of ageing. *J Neurochem* 36(6):2037-2043.
- +Leung TK, Lai JC, Lim L. 1982. The effects of chronic manganese feeding on the activity of monamine oxidase in various organs of the developing rat. *Comp Biochem Physiol* 71C:223-228.
- \*Lewis RJ. 2000. Manganese. *Sax's dangerous properties of industrial materials*. 10th ed. New York, NY: John Wiley & Sons, Inc., 2275-2276, 2278-2780.
- \*Lewis RJ, ed. 2001. *Hawley's condensed chemical dictionary*. 14th ed. New York, NY: John Wiley & Sons, Inc., 694-698.
- \*Lewis J, Bench G, Myers O, et al. 2005. Trigeminal uptake and clearance of inhaled manganese chloride in rats and mice. *Neurotoxicology* 26:113-123.
- +\*Li GJ, Choi B, Wang X, et al. 2006. Molecular mechanism of distorted iron regulation in the blood-CSF barrier and regional blood-brain barrier following in vivo subchronic manganese exposure. *Neurotoxicology* 27:737-744.

## 9. REFERENCES

- \*Li GJ, Zhang LL, Lu L, et al. 2004. Occupational exposure to welding fume among welders: Alterations of manganese, iron, zinc, copper, and lead in body fluids and the oxidative stress status. *J Occup Environ Med* 46(3):241-248.
- Li MS, Lou YP, Su ZY. 2007. Heavy metal concentrations in soils and plant accumulation in a restored manganese mineland in Guangxi, South China. *Environ Pollut* 147:168-175.
- \*Liccione JJ, Maines MD. 1988. Selective vulnerability of glutathione metabolism and cellular defense mechanisms in rat striatum to manganese. *J Pharmacol Exp Ther* 247:156-161.
- \*Lide DR, ed. 2000. *CRC Handbook of chemistry and physics*. New York, NY: CRC Press LLC., 4-1, 6-66, 6-68.
- +\*Lim KO, Stark DD, Leese PT, et al. 1991. Hepatobiliary MR imaging: First human experience with MnDPDP. *Radiology* 178:79-82.
- \*Lima PDL, Vasconcellos MC, Bahia MO, et al. 2008. Genotoxic and cytotoxic effects of manganese chloride in cultured human lymphocytes treated in different phases of cell cycle. *Toxicol In Vitro* 22(4):1032-1037.
- +\*Lin TH, Chen JG, Liaw JM, et al. 1996. Trace elements and lipid peroxidation in uremic patients on hemodialysis. *Biol Trace Elem Res* 51:277-283.
- \*Lioy PJ. 1983. Air pollution emission profiles of toxic and trace elements from energy related sources: Status and needs. *Neurotoxicology* 4(3):103-112.
- Lioy PJ, Daisey JM. 1987. *Toxic air pollution: A comprehensive study of non-criteria air pollutants*. Chelsea, MI: Lewis Publishers, Inc.
- +\*Lipe GW, Duhart H, Newport GD, et al. 1999. Effect of manganese on the concentration of amino acids in different regions of the rat brain. *J Environ Sci Health B* 34(1):119-132.
- Lisi P, Caraffini S. 1985. Pellagroid dermatitis from mancozeb with vitiligo. *Contact Dermatitis* 13:124-125.
- Lisi P, Caraffini S, Assalve D. 1987. Irritation and sensitization potential of pesticides. *Contact Dermatitis* 17:212-218.
- Liu S, Wang J, Kang J, et al. 2000. Alterations in the properties and isoforms of sciatic nerve Na<sup>+</sup>, K<sup>+</sup>-ATPase in methylcyclopentadienyl manganese tricarbonyl-treated mice. *Environ Res Section A* 82:239-244.
- +\*Liu X, Sullivan KA, Madl JE, et al. 2006. Manganese-induced neurotoxicity: The role of astroglial-derived nitric oxide in striatal interneuron degeneration. *Toxicol Sci* 91(2):521-531.
- Liu X, Buffington JA, Tjalkens RB. 2005. NF- $\kappa$ B-dependent production of nitric oxide by astrocytes mediates apoptosis in differentiated PC12 neurons following exposure to manganese and cytokines. *Brain Res Mol Brain Res* 141:39-47.
- \*Livingston AL. 1978. Forage plant estrogens. *J Toxicol Environ Health* 4(2-3):301-324.



## 9. REFERENCES

- Ljung K, Vahter M. 2007. Time to re-evaluate the guideline value for manganese in drinking water? *Environ Health Perspect* 115:1533-1538.
- Llobet JM, Schuhmacher M, Domingo JL. 2002. Spatial distribution and temporal variation of metals in the vicinity of a municipal solid waste incinerator after a modernization of the flue gas cleaning systems of the facility. *Sci Total Environ* 284:205-214.
- Llorens JF, Fernandez-Turiel JL, Querol X. 2001. The fate of trace elements in a large coal-fired power plant. *Environ Geol* 40(4-5):409-416.
- +\*Lloyd Davies TA. 1946. Manganese pneumonitis. *Br J Ind Med* 3:111-135.
- +Lloyd Davies TA, Harding HE. 1949. Manganese pneumonitis: Further clinical and experimental observations. *Br J Ind Med* 6:82-90.
- Lo KSL, Chen YH. 1990. Extracting heavy metals from municipal and industrial sludges. *Sci Total Env* 90:99-116.
- +\*London RE, Toney G, Gabel SA, et al. 1989. Magnetic resonance imaging studies of the brains of anesthetized rats treated with manganese chloride. *Brain Res Bull* 23:229-235.
- \*Lönnerdal B. 1997. Effects of milk and milk components on calcium, magnesium, and trace element absorption during infancy. *Physiol Rev* 77:643-669.
- \*Lönnerdal B, Keen CL, Bell JG, et al. 1987. Manganese uptake and retention: Experimental animal and human studies. In: Kies C, ed. *Nutritional bioavailability of manganese: ACS Symposium Series 354*, Washington, DC: American Chemical Society, 9-20.
- \*Lönnerdal B, Keen CL, Ohtake M, et al. 1983. Iron, zinc, copper, and manganese in infant formulas. *Am J Dis Child* 137:433-437.
- Lönnerdal B, Kelleher SL, Kaup SM, et al. 1998. Effect of manganese level of infant formula on manganese and iron status and retention in infant monkeys [Abstract]. *FASEB J* 12:A970.
- +\*Lönnerdal B, Yuen M, Huang S. 1994. Calcium, iron, zinc, copper and manganese bioavailability from infant formulas and weaning diets assessed in rat pups. *Nutr Res* 14:1535-1548.
- \*Loranger S, Zayed J. 1994. Manganese and lead concentrations in ambient air and emission rates from unleaded and leaded gasoline between 1981 and 1992 in Canada: A comparative study. *Atmos Environ* 28:1645-1651.
- \*Loranger S, Zayed J. 1995. Environmental and occupational exposure to manganese: A multimedia assessment. *Int Arch Occup Environ Health* 67(2):101-110.
- \*Loranger S, Zayed J. 1997a. Environmental contamination and human exposure to airborne total and respirable manganese in Montreal. *J Air Waste Manag Assoc* 47(9):983-989.
- \*Loranger S, Zayed J. 1997b. Environmental contamination and human exposure assessment to manganese in the St. Lawrence River ecozone (Quebec, Canada) using an environmental fate/exposure model: *Geotox. SAR QSAR Environ Res* 6:105-119.

## 9. REFERENCES

- +\*Loranger S, Demers G, Kennedy G, et al. 1994b. The pigeon (*Columba livia*) as a monitor for manganese contamination from motor vehicles. *Arch Environ Contam Toxicol* 27:311-317.
- \*Loranger S, Tetrault M, Kennedy G, et al. 1996. Manganese and other trace elements in urban snow near an expressway. *Environ Pollut* 92(2):203-211.
- \*Loranger S, Zayed J, Forget E. 1994a. Manganese contamination in Montreal in relation with traffic density. *Water Air Soil Pollut* 74:385-396.
- \*Loranger S, Zayed J, Kennedy G. 1995. Contribution of methylcyclopentadienyl manganese tricarbonyl (MMT) to atmospheric manganese concentration near expressway: Dispersion modeling estimations. *Atmos Environ* 29(5):591-599.
- Louis ED, Applegate LM, Factor-Litvak P, et al. 2004. Essential tremor: Occupational exposure to manganese and organic solvents. *Neurology* 63:2162-2164.
- Lovley DR. 1991. Dissimilatory Fe(III) and Mn(IV) reduction. *Microbiol Rev* 55:259-287.
- +\*Lown BA, Morganti JB, D'Agostino R, et al. 1984. Effects on the postnatal development of the mouse of preconception, postconception and/or suckling exposure to manganese via maternal inhalation exposure to MnO<sub>2</sub> dust. *Neurotoxicology* 5:119-129.
- Lu L, Zhang L, Li GJ, et al. 2005. Alteration of serum concentrations of manganese, iron, ferritin, and transferrin receptor following exposure to welding fumes among career welders. *Neurotoxicology* 26:257-265.
- \*Lucchini RG, Albini E, Benedetti L, et al. 2007. High prevalence of parkinsonian disorders associated to manganese exposure in the vicinities of ferroalloy industries. *Am J Ind Med* 50:788-800.
- +\*Lucchini R, Apostoli P, Perrone C, et al. 1999. Long term exposure to "low levels" of manganese oxides and neurofunctional changes in ferroalloy workers. *Neurotoxicology* 20:287-298.
- +\*Lucchini R, Selis L, Folli D, et al. 1995. Neurobehavioral effects of manganese in workers from a ferroalloy plant after temporary cessation of exposure. *Scand J Work Environ Health* 21:143-149.
- +Lustig S, Pitlik SD, Rosenfeld JB. 1982. Liver damage in acute self-induced hypermanganemia. *Arch Intern Med* 142:405-406.
- Luthen F, Bulnheim U, Muller PD, et al. 2007. Influence of manganese ions on cellular behavior of human osteoblasts in vitro. *Biomol Eng* 24:531-536.
- +\*Lydén A, Larsson B, Lindquist NG. 1984. Melanin affinity of manganese. *Acta Pharmacol Toxicol* 55:133-138.
- Lyman WR. 1971. The metabolic fate of Dithane M-45.
- \*Lynam DR, Pfeifer GD, Fort BF, et al. 1990. Environmental assessment of MMT fuel additive. *Sci Total Environ* 93:107-114.

## 9. REFERENCES

- \*Lynam DR, Pfeifer GD, Fort BF, et al. 1994. Atmospheric exposure to manganese from use of methylcyclopentadienyl manganese tricarbonyl (MMT) performance additive. *Sci Total Environ* 146/147:103-109.
- \*Lynam DR, Roos JW, Pfeifer GD, et al. 1999. Environmental effects and exposures to manganese from use of methylcyclopentadienyl manganese tricarbonyl (MMT) in gasoline. *Neurotoxicology* 20:145-150.
- \*Lytle CM, McKinnon CZ, Smith BN. 1994. Manganese accumulation in roadside soil and plants. *Naturwissenschaften* 81:509-510.
- Maci R and Arias E. 1987. Teratogenic effects of the fungicide maneb on chick embryos. *Ecotoxicol Environ Safety* 13:169-173.
- +Mahoney JP, Small WJ. 1968. Studies on manganese: III. The biological half-life of radiomanganese in man and factors which affect this half-life. *J Clin Invest* 47:643-653.
- +\*Maigetter RZ, Ehrlich R, Fenters JD, et al. 1976. Potentiating effects of manganese dioxide on experimental respiratory infections. *Environ Res* 11:386-391.
- Maini P and Boni R. 1986. Gas chromatographic determination of dithiocarbamate fungicides in workroom air. *Bull Environ Contam Toxicol* 37:931-937.
- Malecki EA. 2001. Manganese toxicity is associated with mitochondrial dysfunction and DNA fragmentation in rat primary striatal neurons. *Brain Res Bull* 55(2):225-228.
- Malecki EA, Greger JL. 1995. Manganese protects against heart mitochondrial lipid peroxidation in rats fed high levels of polyunsaturated fatty acids. *J Nutr* 126:27-33.
- Malecki EA, Devenyi AG, Beard JL. 1998. Transferrin response in normal and iron-deficient mice heterozygotic for hypotransferrinemia; effects on iron and manganese accumulation. *Biomaterials* 11:265-276.
- Malecki EA, Devenyi AG, Beard JL, et al. 1999. Existing and emerging mechanisms for transport of iron and manganese to the brain. *J Neurosci Res* 56:113-122.
- \*Malecki EA, Radzanowski GM, Radzanowski TJ, et al. 1996. Biliary manganese excretion in conscious rats is affected by acute and chronic manganese intake but not by dietary fat. *J Nutr* 126:489-498.
- \*Malm O, Pfeiffer WC, Fiszman M, et al. 1988. Transport and availability of heavy metals in the Paraiba do Sul-Guandu River system, Rio de Janeiro state, Brazil. *Sci Total Environ* 75:201-209.
- Malsch PA, Proctor DM, Finley BL. 1994. Estimation of chromium inhalation reference concentration using the benchmark dose method: A case study. *Regul Toxicol Pharmacol* 20:58-82.
- Malthankar GV, White BK, Bhushan A, et al. 2004. Differential lowering by manganese treatment of activities of glycolytic and tricarboxylic acid (TCA) cycle enzymes investigated in neuroblastoma and astrocytoma cells is associated with manganese-induced cell death. *Neurochem Res* 29(4):709-717.
- Mandgzhgaladze RN. 1966a. [Effect of manganese compounds on the estrous cycle and embryogeny of experimental animals.] *Sb Tr Nauch-Issled Inst Gig Tr Profzabol, Tiflis* 10:219-223. (Russian)

## 9. REFERENCES

- Mandzhgaladze RN. 1966b. [Effect of manganese compounds on the sexual function of male rats.] *Sb Tr Nauch-Issled Inst Gig Tr Progzabol, Tiflis* 10:191-195. (Russian)
- Manuzzi P, Borrello P, Misciali C, et al. 1988. Contact dermatitis due to ziram and maneb. *Contact Dermatitis* 19:148.
- \*Mari M, Ferre-Huguet N, Nadal M, et al. 2007. Temporal trends in metal concentrations in soils and herbage collected near a municipal waste incinerator: Human health risks. *Hum Ecol Risk Assess* 13:457-472.
- Markesbery WR, Ehmann WD, Hossain TI, et al. 1984. Brain manganese concentrations in human aging and Alzheimer's disease. *Neurotoxicology* 5:49-57.
- Marriott LD, Foote KD, Kimber AC, et al. 2007. Zinc, copper, selenium and manganese blood levels in preterm infants. *Arch Dis Child Fetal Neonatal Ed* 92:F494-F497.
- Marsh GM, Gula MJ. 2006. Employment as a welder and Parkinson disease among heavy equipment manufacturing workers. *J Occup Environ Med* 48(10):1031-1046.
- Martin CJ. 2006. Manganese neurotoxicity: Connecting the dots along the continuum of dysfunction. *Neurotoxicology* 27:347-349.
- Marty JL, Noguier T. 1993. Bi-enzyme amperometric sensor for the detection of dithiocarbamate fungicides. *Analysis* 21:231-233.
- +Matrone G, Hartman RH, Clawson AJ. 1959. Studies of a manganese-iron antagonism in the nutrition of rabbits and baby pigs. *J Nutr* 67:309-317.
- Matsushita T, Arimatsu Y, Nomura S. 1976. Experimental study on contact dermatitis caused by dithiocarbamates maneb, mancozeb, zineb, and their related compounds. *Int Arch Occup Environ Health* 37:169-178.
- \*Mayr U, Butsch A, Schneider S. 1992. Validation of two in vitro test systems for estrogenic activities with zearalenone, phytoestrogens and cereal extracts. *Toxicology* 74(2-3):135-149.
- \*McBride MB. 1979. Chemisorption and precipitation of Mn<sup>2+</sup> at CaCO<sub>3</sub> surfaces. *Soil Sci Soc Am J* 43:693-698.
- McCleod HA, McCully KA. 1969. Head space gas procedure for screening food samples for dithiocarbamate residues. *J AOAC* 52:1226-1230.
- +\*McGinley PA, Morris JB, Clay RJ, et al. 1987. Disposition and toxicity of methylcyclopentadienyl manganese tricarbonyl in the rat. *Toxicol Lett* 36:137-145.
- Mchichi BE, Hadji A, Vazquez A, et al. 2007. p38 MAPK and MSK1 mediate caspase-8 activation in manganese-induced mitochondria-dependent cell death. *Cell Death Differ* 14:1826-1836.
- McKinney AM, Filice RW, Teksam M, et al. 2004. Diffusion abnormalities of the globi pallidi in manganese neurotoxicity. *Neuroradiology* 46:291-295.

## 9. REFERENCES

- McMillan DE. 1999. A brief history of the neurobehavioral toxicity of manganese: Some unanswered questions. *Neurotoxicology* 20:499-508.
- \*MDNR. 1990. Written communication regarding contaminant levels in water at hazardous waste sites. Jefferson City, MO: Missouri Department of Natural Resources.
- Meco G, Bonifati V, Vanacore N, et al. 1994. Parkinsonism after chronic exposure to the fungicide maneb (manganese ethylene bis-dithiocarbamate). *Scand J Work Environ Health* 20:301-305.
- +Mehta R, Reilly JJ. 1990. Manganese levels in a jaundiced long-term total parenteral nutrition patient: Potentiation of haloperidol toxicity? Case report and literature review. *JPEN J Parenter Enteral Nutr* 14:428-430.
- Mena I. 1974. The role of manganese in human disease. *Ann Clin Lab Sci* 4:487-491.
- \*Mena I. 1979. Manganese poisoning. In: Vinken PJ, Bruyn GW, eds. *Handbook of Clinical Neurology*. Amsterdam, the Netherlands: North-Holland Publishing Co., 217-237.
- +\*Mena I, Horiuchi K, Burke K, et al. 1969. Chronic manganese poisoning: Individual susceptibility and absorption of iron. *Neurology* 19:1000-1006.
- \*Mena I, Horiuchi K, Lopez G. 1974. Factors enhancing entrance of manganese into the brain: Iron deficiency and age. *J Nucl Med* 15:516.
- +\*Mena I, Marin O, Fuenzalida S, et al. 1967. Chronic manganese poisoning: Clinical picture and manganese turnover. *Neurology* 17:128-136.
- Menezes LM, Campos LC, Quintao CC, et al. 2004. Hypersensitivity to metals in orthodontics. *Am J Orthod Dentofacial Orthop* 126:58-64.
- Mergler D. 1999. Neurotoxic effects of low level exposure to manganese in human populations. *Environ Res Section A* 80:99-102.
- +\*Mergler D, Baldwin M, Bélanger S, et al. 1999. Manganese neurotoxicity, a continuum of dysfunction: Results from a community based study. *Neurotoxicology* 20:327-342.
- +\*Mergler D, Huel G, Bowler R, et al. 1994. Nervous system dysfunction among workers with long-term exposure to manganese. *Environ Res* 64:151-180.
- Michalke B, Berthele A, Mistriotis P, et al. 2007b. Manganese speciation in human cerebrospinal fluid using CZE coupled to inductively coupled plasma MS. *Electrophoresis* 28:1380-1386.
- Michalke B, Berthele A, Mistriotis P, et al. 2007c. Manganese species from human serum, cerebrospinal fluid analyzed by size exclusion chromatography-, capillary electrophoresis coupled to inductively coupled plasma mass spectrometry. *J Trace Elem Med Biol* 21:4-9.
- Michalke B, Halbach S, Nischwitz V. 2007a. Speciation and toxicological relevance of manganese in humans. *J Environ Monit* 9:650-656.
- Migheli R, Godani C, Sciola L, et al. 1999. Enhancing effect of manganese on L-DOPA-induced apoptosis in PC12 cells: Role of oxidative stress. *J Neurochem* 73:1155-1163.

## 9. REFERENCES

- Milatovic D, Yin Z, Gupta RC, et al. 2007. Manganese induces oxidative impairment in cultured rat astrocytes. *Toxicol Sci* 98(1):198-205.
- \*Miller KB, Caton JS, Finley JW. 2006. Manganese depresses rat heart muscle respiration. *Biofactors* 28:33-46.
- \*Miller KB, Caton JS, Schafer DM, et al. 2000. High dietary manganese lowers heart magnesium in pigs fed a low-magnesium diet. *J Nutr* 130:2032-2035.
- \*Miller KB, Newman SM, Caton JS, et al. 2004. Manganese alters mitochondrial integrity in the hearts of swine marginally deficient in magnesium. *Biofactors* 20:86-96.
- +\*Miller ST, Cotzias GC, Evert HA. 1975. Control of tissue manganese: Initial absence and sudden emergence of excretion in the neonatal mouse. *Am J Physiol* 229:1080-1084.
- +\*Minoia C, Sabbioni E, Apostoli P, et al. 1990. Trace element reference values in tissues from inhabitants of the European community. I. A study of 46 elements in urine, blood and serum of Italian subjects. *Sci Total Environ* 95:89-105.
- Minyard JP, Roberts WE. 1991. State findings on pesticide residues in foods: 1988 and 1989. *J Assoc Off Anal Chem* 74:438-452.
- Missy P, Lanhers M, Cunat L, et al. 2000a. Effects of subchronic exposure to manganese chloride on tissue distribution of three essential elements in rats. *Int J Toxicol* 19:313-321.
- Missy P, Lanhers M, Grignon Y, et al. 2000b. In vitro and in vivo studies on chelation of manganese. *Hum Exp Toxicol* 19:448-456.
- Mitchell JA, Long SF, Wilson MC, et al. 1989. The behavioral effects of pesticides in male mice. *Neurotoxicol Teratol* 11:45-50.
- \*Mölders N, Schilling PJ, Wong J, et al. 2001. X-ray fluorescence mapping and micro-XANES spectroscopic characterization of exhaust particulates emitted from auto engines burning MMT-added gasoline. *Environ Sci Technol* 35(15):3122-3129.
- Monis B, Valentich MA. 1993. Promoting effects of mancozeb on pancreas of nitrosomethylurea-treated rats. *Carcinogenesis* 14:929-933.
- +\*Montes S, Alcaraz-Zubeldia M, Muriel P, et al. 2001. Striatal manganese accumulation induces changes in dopamine metabolism in the cirrhotic rat. *Brain Res* 891:123-129.
- +\*Montes S, Perez-Severiano F, Vergara P, et al. 2006. Nitric oxide production in striatum and pallidum of cirrhotic rats. *Neurochem Res* 31(1):11-20.
- Montes S, Riojas-Rodriguez H, Sabido-Pedraza E, et al. 2008. Biomarkers of manganese exposure in a population living close to a mine and mineral processing plant in Mexico. *Environ Res* 106:89-95.
- +\*Moore W, Hysell D, Miller R, et al. 1975. Exposure of laboratory animals to atmospheric manganese from automotive emissions. *Environ Res* 9:274-284.

## 9. REFERENCES

- Morato GS, Lemos T, Takahashi RN. 1988. Acute exposure to maneb alters some behavioral functions in the mouse. *Neurotoxicol Teratol* 11:421-425.
- Morello M, Canini A, Mattioli P, et al. 2008. Sub-cellular localization of manganese in the basal ganglia of normal and manganese-treated rats. An electron spectroscopy imaging and electron energy-loss spectroscopy study. *Neurotoxicology* 29:60-72.
- +\*Morello M, Zatta P, Zambenedetti P, et al. 2007. Manganese intoxication decreases the expression of manganese proteins in the rat basal ganglia: An immunohistochemical study. *Brain Res Bull* 74:406-415.
- Morgan JM. 1972. Hepatic copper, manganese, and chromium content in bronchogenic carcinoma. *Cancer* 29:710-713.
- +\*Morganti JB, Lown BA, Stineman CH, et al. 1985. Uptake, distribution and behavioral effects of inhalation exposure to manganese (MnO<sub>2</sub>) in the adult mouse. *Neurotoxicology* 6:1-16.
- Morris PD, Koepsell TD, Daling JR, et al. 1986. Toxic substance exposure and multiple myeloma: A case-control study. *J Natl Cancer Inst* 76:987-994.
- \*Morselli PL, Franco-Morselli R, Bossi L. 1980. Clinical pharmacokinetics in newborns and infants: Age-related differences and therapeutic implications. *Clin Pharmacokin* 5(6):485-527.
- \*Mortelmans K, Haworth S, Lawlor T, et al. 1986. Salmonella mutagenicity tests: II. Results from testing of 270 chemicals. *Environ Mutagen* 8:1-26.
- \*Moser VC. 2000. The functional observational battery in adult and developing rat. *Neurotoxicology* 21(6):989-996.
- \*Mossman BT, Surinrut P, Brinton BT, et al. 1996. Transfection of a manganese-containing superoxide dismutase gene into hamster tracheal epithelial cells ameliorates asbestos-mediated cytotoxicity. *Free Radical Biol Med* 21:125-131.
- Mouri T. 1973. [Experimental studies on the inhalation of manganese dust.] *Shikoku Acta Medica* 29:118-129. (Japanese)
- Mumma RO, Raupach DC, Waldman JP, et al. 1984. National survey of elements and other constituents in municipal sewage sludges. *Arch Environ Contam Toxicol* 13:75-83.
- Munk R, Schulz V. 1989. Study of possible teratogenic effects of the fungicide maneb on chick embryos. *Ecotoxicol Environ Safety* 17:112-118.
- \*Murphy VA, Wadhvani KC, Smith QR, et al. 1991. Saturable transport of manganese (II) across the rat blood-brain barrier. *J Neurochem* 57:948-954
- Murthy GK, Rhea U, Peeler JT. 1971. Levels of antimony, cadmium, chromium, cobalt, manganese, and zinc in institutional total diets. *Environ Sci Technol* 5:436-442.
- Mustafa SJ, Chandra SV. 1972. Adenosine deaminase and protein pattern in serum and cerebrospinal fluid in experimental manganese encephalopathy. *Arch Toxicol* 28:279-285.

## 9. REFERENCES

- Mutkus L, Aschner JL, Fitsanakis V, et al. 2005. The in vitro uptake of glutamate in GLAST and GLT-1 transfected mutant CHO-K1 cells is inhibited by manganese. *Biol Trace Elem Res* 107:221-230.
- Mutti A, Smargiassi A. 1998. Selective vulnerability of dopaminergic systems to industrial chemicals: Risk assessment of related neuroendocrine changes. *Toxicol Ind Health* 14:311-324.
- +\*Myers JE, teWaterNaude J, Fourie M, et al. 2003a. Nervous system effects of occupational manganese exposure on South African manganese mineworkers. *Neurotoxicology* 24(4-5):649-656.
- Myers JE, Thompson ML, Naik I, et al. 2003c. The utility of biological monitoring for manganese in Ferroally smelter workers in South Africa. *Neurotoxicology* 24:875-883.
- +\*Myers JE, Thompson ML, Ramushu S, et al. 2003b. The nervous system effects of occupational exposure on workers in a South African manganese smelter. *Neurotoxicology* 24:885-894.
- +\*Nachtman JP, Tubben RE, Commissaris RL. 1986. Behavioral effects of chronic manganese administration in rats: Locomotor activity studies. *Neurobehav Toxicol Teratol* 8:711-715.
- Nagata H, Miyata S, Nakamura S, et al. 1985. Heavy metal concentrations in blood cells in patients with amyotrophic lateral sclerosis. *J Neurol Sci* 67:173-185.
- +\*Nagatomo S, Umehara F, Hanada K, et al. 1999. Manganese intoxication during total parenteral nutrition: report of two cases and review of the literature. *J Neurol Sci* 162:102-105.
- Nakata A, Araki S, Park S, et al. 2006. Decreases in CD8+ T, naive (CD4+CD45RA+) T, and B (CD19+) lymphocytes by exposure to manganese fume. *Ind Health* 44:592-597.
- \*NAS. 1973. Manganese in the ecosystem. In: *Medical and biological effects of environmental pollutants: Manganese*. Washington, DC: National Academy of Sciences, 3-50.
- \*NAS. 1977. *Drinking water and health*. Washington, DC: National Academy of Sciences, 214-215, 267-270, 311-312.
- \*NAS. 1980a. *Drinking water and health*. Vol. 3. Washington, DC: National Academy Press, 331-337.
- \*NAS. 1980b. Manganese. In: *Recommended dietary allowances*. 9th revised ed. Washington, DC: National Academy of Sciences, 154-157.
- NAS. 1982. *Drinking water and health*. Vol. 4. Washington, DC: National Academy Press, 93.
- \*NAS/NRC. 1989. Report of the oversight committee. In: *Biologic markers in reproductive toxicology*. Washington, DC: National Academy of Sciences, National Research Council, National Academy Press, 15-35.
- Nash RG, Beall ML. 1980. Fate of maneb and zineb fungicides in microagroecosystems chambers. *J Agric Food Chem* 28:322-330.
- +\*Naslund PE, Andreasson S, Bergstrom R, et al. 1990. Effects of exposure to welding fume: An experimental study in sheep. *Eur Respir J* 3:800-806.



## 9. REFERENCES

Nater JP, Terpstra H, Bleumink E. 1979. Allergic contact sensitization to the fungicide maneb. *Contact Dermatitis* 5:24-26.

+\*Nelson K, Golnick J, Korn T, et al. 1993. Manganese encephalopathy: Utility of early magnetic resonance imaging. *Br J Ind Med* 50: 510-513.

\*Newland MC. 1999. Animal models of manganese's neurotoxicity. *Neurotoxicology* 20:415-432.

+\*Newland MC, Weiss B. 1992. Persistent effects of manganese on effortful responding and their relationship to manganese accumulation in the primate globus pallidus. *Toxicol Appl Pharmacol* 113:87-97.

+\*Newland MC, Ceckler TL, Kordower JH, et al. 1989. Visualizing manganese in the primate basal ganglia with magnetic resonance imaging. *Exp Neurology* 106:251-258.

+\*Newland MC, Cox C, Hamada R, et al. 1987. The clearance of manganese chloride in the primate. *Fundam Appl Toxicol* 9:314-328.

Newsome WH. 1974. The excretion of ethylenethiourea by rat and guinea pig. *Bull Environ Contam Toxicol* 11:174-176.

\*Ni Y, Petre C, Bosmans H, et al. 1997. Comparison of manganese biodistribution and MR contrast enhancement in rats after intravenous injection of MnDPDP and MnCl<sub>2</sub>. *Acta Radiol* 38:700-707.

NIOSH. 1984a. Total manganese-method 7200. In: NIOSH manual of analytical methods. 3rd ed. Vol. 1. Cincinnati, OH: National Institute for Occupational Safety and Health, DHHS (NIOSH) Publication No. 84-100.

NIOSH. 1984b. Total manganese-method 7300. In: NIOSH manual of analytical methods. 3rd ed. Vol. 1. Cincinnati, OH: National Institute for Occupational Safety and Health, DHHS (NIOSH) Publication No. 84-100.

\*NIOSH. 1984c. Elements in blood or tissue-method 8005. In: NIOSH manual of analytical methods. 3rd ed. Vol. 2. Cincinnati, OH: National Institute for Occupational Safety and Health, DHHS (NIOSH) Publication No. 84-100.

\*NIOSH. 1984d. Metals in urine-method 8310. In: NIOSH manual of analytical methods. 3rd ed. Vol. 2. Cincinnati, OH: National Institute for Occupational Safety and Health, DHHS (NIOSH) Publication No. 84-100.

\*NIOSH. 1992. NIOSH recommendations for occupational safety and health. Compendium of policy documents and statements. Categories of pesticides. Atlanta, GA: National Institute for Occupational Safety and Health, Centers for Disease Control and Prevention. <http://www.cdc.gov/niosh/92-100.html>. April 29, 2008.

\*NIOSH. 2003a. Method 7300. Elements by ICP. (Nitric/perchloric acid ashing). NIOSH manual of analytical methods (NMAM). 4th ed. National Institute for Occupational Safety and Health. <http://www.cdc.gov/niosh/nmam/pdfs/7300.pdf>. April 30, 2008.

## 9. REFERENCES

- \*NIOSH. 2003b. Method 7303. Elements by ICP. (Hot block/HCL/HNO<sub>3</sub> digestion). NIOSH manual of analytical methods (NMAM). 4th ed. National Institute for Occupational Safety and Health. <http://www.cdc.gov/niosh/nmam/pdfs/7303.pdf>. May 01, 2008.
- \*NIOSH. 2003c. Method 7301. Elements by ICP. (Aqua regia ashing). NIOSH manual of analytical methods (NMAM). 4th ed. National Institute for Occupational Safety and Health. <http://www.cdc.gov/niosh/nmam/pdfs/7301.pdf>. May 01, 2008.
- \*NIOSH. 2005. Manganese. NIOSH pocket guide to chemical hazards. Atlanta, GA: National Institute for Occupational Safety and Health, Centers for Disease Control and Prevention. <http://www.cdc.gov/niosh/npg/> April 24, 2008.
- Nishiayama K, Suzuki Y, Fujii N, et al. 1975. [Effect of long-term inhalation of manganese dusts. II. Continuous observation of the respiratory organs of monkeys and mice.] *Jap J Hyg* 30:117. (Japanese)
- +Nishida M, Ogata K, Sakurai H, et al. 1992. A binding profile of manganese to the nucleus of rat liver cells, and manganese-induced aberrations in thyroid hormone content and RNA synthesis in the nucleus. *Biochem Int* 27:209-219.
- \*Nishioka H. 1975. Mutagenic activities of metal compounds in bacteria. *Mutat Res* 31:185-189.
- \*NLM. 2008. Manganese violet. Household products database. Health and safety information on household products. National Library of Medicine. <http://householdproducts.nlm.nih.gov/cgi-bin/household/brands?tbl=chem&id=1556>. June 18, 2008.
- \*NOES. 1989. National Occupational Exposure Survey. National Institute of Occupational Safety and Health, Cincinnati, OH. October 18, 1989.
- +\*Nogawa K, Kobayashi E, Sakamoto M, et al. 1973. Epidemiological studies on disturbance of respiratory system caused by manganese air pollution: (Report 1) Effects on respiratory system of junior high school students. *Nippon Koshu Eisei Zasshi* 20(6):315-325.
- Noguer T and Marty JL. 1997. High sensitive bienzymic sensor for the detection of dithiocarbamate fungicides. *Anal Chim Acta* 347:63-70.
- NOHS. 1989. National Occupational Hazard Survey. National Institute of Occupational Safety and Health, Cincinnati, OH. October 18, 1989.
- \*Nolte W, Wiltfang J, Schindler CG, et al. 1998. Bright basal ganglia in T1-weighted magnetic resonance images are frequent in patients with portal vein thrombosis without liver cirrhosis and not suggestive of hepatic encephalopathy. *J Hepatol* 29:443-449.
- \*Nong A, Teegarden JG, Clewell HJ, et al. 2008. Pharmacokinetic modeling of manganese in the rat IV: Assessing factors that contribute to brain accumulation during inhalation exposure. *J Toxicol Environ Health A* 71:413-426.
- Nordhoy W, Anthonsen HW, Bruvold M, et al. 2003. Manganese ions as intracellular contrast agents: Proton relaxation and calcium interactions in rat myocardium. *NMR Biomed* 16:82-95.

## 9. REFERENCES

- \*Normandin L, Beaupre LA, Salehi F, et al. 2004. Manganese distribution in the brain and neurobehavioral changes following inhalation exposure of rats to three chemical forms of manganese. *Neurotoxicology* 25:433-441.
- +\*Normandin L, Carrier G, Gardiner PF, et al. 2002. Assessment of bioaccumulation, neuropathology, and neurobehavior following subchronic (90 days) inhalation in Sprague-Dawley rats exposed to manganese phosphate. *Toxicol Appl Pharmacol* 183:135-145.
- \*NRC. 1993. National Research Council. Pesticides in the diets of infants and children. Washington, DC: National Academy Press.
- \*NRC. 1989. Recommended dietary allowances. Washington, DC: National Research Council. Tenth Edition, 230-235.
- \*Nriagu JO. 1979. Copper in the atmosphere and precipitation. In: Nriagu JO, ed. Copper in the environment. Part I: Ecological cycling. New York, NY: John Wiley and Sons, Inc., 43-67.
- +\*NTP. 1987b. The chronic study of manganese sulfate monohydrate (CAS No. 10034-96-5) in B6C3F1 mice. Research Triangle Park, NC: National Toxicology Program.
- +\*NTP. 1987a. The chronic study of manganese sulfate monohydrate (CAS No. 10034-96-5) in F344 rats. Research Triangle Park, NC: National Toxicology Program.
- NTP. 1990. Manganese sulfate monohydrate. In: Chemical status report produced from NTP chemtrack system. Research Triangle Park, NC: National Toxicology Program, 14.
- NTP. 1990. NTP Technical report on the perinatal toxicity and carcinogenicity studies on ethylene thiourea in F/344 rats and B6C3F1 mice (feed studies). National Toxicology Program. NTO-TR-388, NIH Pub. No. 90-28-43.
- NTP. 1992. Technical report on the studies of manganese (II) sulfate monohydrate in F344/N rats and B6C3F1 mice. National Toxicological Program.
- +\*NTP. 1993. Toxicology and carcinogenesis studies of manganese (II) sulfate monohydrate in F344/N rats and B6C3F1 mice (feed study). National Toxicology Program. Technical Report Series 428. RISKLINE 94030007.
- \*NTP. 2005. Report on carcinogens. 11th ed. Research Triangle Park, NC: U.S. Department of Health and Human Services, Public Health Service, National Toxicology Program. <http://ntp-server.niehs.nih.gov/ntp/roc/toc11.html>. April 24, 2008.
- Oakley AMM. 1988. Contact allergy to fungicide. *NZ Med J* 101:180-181.
- Obama K. 1996. Studies on allergic skin disease caused by pesticides in citrus growers: Field survey study and animal experiments. *Med J Kagoshima Univ* 48:13-22.
- Oberg TG. 2002. Prediction of vapour pressures for halogenated diphenyl ether congeners from molecular descriptors. *Environ Sci Pollut Res Int* 9(6):405-411.
- Oberley LW, Oberley TD, Buettner GR. 1980. Cell differentiation, aging and cancer: The possible roles of superoxide and superoxide dismutases. *Med Hypotheses* 6:249-268.

## 9. REFERENCES

- \*Oberly TJ, Piper CE, McDonald DS. 1982. Mutagenicity of metal salts in the L5178Y mouse lymphoma assay. *J Toxicol Environ Health* 9:367-376.
- Ohashi F, Fukui Y, Takada S, et al. 2006. Reference values for cobalt, copper, manganese, and nickel in urine among women of the general population in Japan. *Int Arch Occup Environ Health* 80:117-126.
- Ohtake T, Negishi K, Okamoto K, et al. 2005. Manganese-induced Parkinsonism in a patient undergoing maintenance hemodialysis. *Am J Kidney Dis* 46(4):749-753.
- Oikawa S, Hirosawa I, Tada-Oikawa S, et al. 2006. Mechanism for manganese enhancement of dopamine-induced oxidative DNA damage and neuronal cell death. *Free Radic Biol Med* 41:748-756.
- Okumura D, Melnicoe R, Jackson T, et al. 1991. Pesticide residues in food crops analyzed by the California department of food and agriculture in 1989. *Rev Environ Contam Toxicol* 92:87-93.
- Okumura M, Anate T, Fujinaga K, et al. 2002. A simple and rapid in situ preconcentration method using solid-phase extraction for the determination of dissolved manganese in brackish lake water samples. *Anal Sci* 18:1093-1097.
- +\*Olanow CW, Good PF, Shinotoh H, et al. 1996. Manganese intoxication in the rhesus monkey: A clinical, imaging, pathologic, and biochemical study. *Neurology* 46:492-498.
- \*Ombaba JM, Barry EF. 1994. Determination of methylcyclopentadienyl manganese tricarbonyl in gasoline by capillary gas chromatography with alternating current plasma emission detection. *J Chromatogr A* 678:319-325.
- \*O'Neil MJ, Heckelman PE, Koch CB, et al, eds. 2006. *The Merck Index*. 14th ed. Whitehouse Station, NJ: Merck & Co., Inc., 990-991, 1074-1075.
- +\*Ono J, Harada K, Kodaka R. 1995. Manganese deposition in the brain during long-term total parenteral nutrition. *J Parent Enter Nutr* 19:310-312.
- Ono K, Komai K, Yamada M. 2002. Myoclonic involuntary movement associated with chronic manganese poisoning. *J Neurol Sci* 199(1-2):93-96.
- +Onoda K, Hasegawa A, Sunouchi M, et al. 1978. Studies on the fate of poisonous metals in experimental animal (VII): Distribution and transplacental passage of manganese in pregnant rat and fetus. *J Food Hyg Soc* 19:208-215.
- \*Orgel A, Orgel LE. 1965. Induction of mutations in bacteriophage T4 with divalent manganese. *J Mol Biol* 14:453-457.
- OSHA. 1998. Occupational Safety and Health Administration. Code of Federal Regulations 29 CFR 1910.1000. Table Z-1. Limits for air contaminants.
- \*OSHA. 2007a. Air contaminants. Occupational Safety and Health Administration. Code of Federal Regulations 29 CFR 1915.1000. <http://www.osha.gov/comp-links.html>. April 24, 2008.

## 9. REFERENCES

- \*OSHA. 2007b. Gases, vapors, fumes, dusts, and mists. Occupational Safety and Health Administration. Code of Federal Regulations 29 CFR 1926.55, Appendix A. <http://www.osha.gov/comp-links.html>. April 24, 2008.
- \*OSHA. 2007c. Limits for air contaminants. Occupational Safety and Health Administration. Code of Federal Regulations 29 CFR 1910.1000, Table Z 1. <http://www.osha.gov/comp-links.html>. April 24, 2008.
- Ostiguy C, Asselin P, Malo S. 2006. The emergence of manganese-related health problems in Quebec: An integrated approach to evaluation, diagnosis, management and control. *Neurotoxicology* 27:350-356.
- \*OTA. 1990. Neurotoxicity: Identifying and controlling poisons of the nervous system. Washington, DC: Office of Technology Assessment. OTABA438.
- \*Owen GM, Brozek J. 1966. Influence of age, sex and nutrition on body composition during childhood and adolescence. In: Falkner F, ed. Human development. Philadelphia, PA: WB Saunders, 222-238.
- Paccès Zaffaroni N, Zavanella T, Arias E. 1979. Peripheral blood cells in the crested newt after long-term exposure to the fungicide manganese ethylenebisdithiocarbamate (maneb). *Bull Environ Contam Toxicol* 23:587-591.
- Paccès Zaffaroni N, Arias E, Capodanno G, et al. 1978. The toxicity of manganese ethylenebisdithiocarbamate to the adult newt, *Triturus cristatus*. *Bull Environ Contam Toxicol* 20:261-267.
- +\*Padovani B, Lecesne R, Raffaelli C. 1996. Tolerability and utility of mangafodipir trisodium injection (MnDPDP) at the dose of 5 µmol/kg body weight in detecting focal liver tumors: Results of a phase III trial using an infusion technique. *Eur J Radiol* 23(3):205-211.
- \*Pagano DA, Zeiger E. 1992. Conditions for detecting the mutagenicity of divalent metals in *Salmonella typhimurium*. *Environ Mol Mutagen* 19:139-146.
- \*Pal PK, Samii A, Calne DB. 1999. Manganese neurotoxicity: A review of clinical features, imaging and pathology. *Neurotoxicology* 20(2-3):227-238.
- Papp A, Pecze L, Szabo A, et al. 2006. Effects on the central and peripheral nervous activity in rats elicited by acute administration of lead, mercury and manganese, and their combinations. *J Appl Toxicol* 26(4):374-380.
- +\*Pappas BA, Zhang D, Davidson CM, et al. 1997. Perinatal manganese exposure: Behavioral, neurochemical, and histopathological effects in the rat. *Neurotoxicol Teratol* 19:17-25.
- +\*Parenti M, Flauto C, Parati E, et al. 1986. Manganese neurotoxicity: Effects of L-DOPA and pargyline treatments. *Brain Res* 367:8-13.
- \*Parenti M, Rusconi L, Cappabianca V, et al. 1988. Role of dopamine in manganese neurotoxicity. *Brain Res* 473:236-240.
- Park J, Yoo CI, Sim CS, et al. 2006a. A retrospective cohort study of Parkinson's disease in Korean shipbuilders. *Neurotoxicology* 27(3):445-449.

## 9. REFERENCES

- Park JD, Chung YH, Kim CY, et al. 2007a. Comparison of high MRI T1 signals with manganese concentration in brains of Cynomolgus monkeys after 8 months of stainless steel welding-fume exposure. *Inhal Toxicol* 19:965-971.
- Park JD, Kim KY, Kim DW, et al. 2007b. Tissue distribution of manganese in iron-sufficient or iron-deficient rats after stainless steel welding-fume exposure. *Inhal Toxicol* 19:563-572.
- \*Park NH, Park JK, Choic Y, et al. 2003. Whole blood manganese correlates with high signal intensities on T1-weighted MRI in patients with liver cirrhosis. *Neurotoxicology* 24:909-915.
- Park RM, Bowler RM, Eggerth DE, et al. 2006b. Issues in neurological risk assessment for occupational exposures: The Bay Bridge welders. *Neurotoxicology* 27(3):373-384.
- Pascal LE, Tessier DM. 2004. Cytotoxicity of chromium and manganese to lung epithelial cells in vitro. *Toxicol Lett* 147(2):143-151.
- \*Paschal DC, Ting BG, Morrow JC, et al. 1998. Trace metals in urine of United States residents: Reference range concentrations. *Environ Res* 76(1):53-59.
- Pastorelli R, Allevi R, Romagnano S, et al. 1995. Gas chromatography-mass spectrometry determination of ethylenethiourea hemoglobin adducts: A possible indicator of exposure to ethylene bis dithiocarbamate pesticides. *Arch Toxicol* 69:306-311.
- \*Patterson KY, Holbrook JT, Bodner JE, et al. 1984. Zinc, copper, and manganese intake and balance for adults consuming self-selected diets. *Am J Clin Nutr* 40:1397-1403.
- \*Paulson AJ, Feely RA, Curl HC, et al. 1984. Behavior of Fe, Mn, Cu and Cd in the Duwamish River estuary downstream of a sewage treatment plant. *Water Research* 18:633-641.
- +Paynter DI. 1980. Changes in activity of the manganese superoxide dismutase enzyme in tissues of the rat with changes in dietary manganese. *J Nutr* 110:437-447.
- Pease HL, Holt RF. 1977. Manganese ethylenebis (dithiocarbamate) (maneb)/ethylenethiourea (ETU) residue studies on five crops treated with ethylenebis (dithiocarbamate) (EBDC) fungicides. *J Agric Food Chem* 25:561-567.
- Pecze L, Papp A, Nagymajtenyi L. 2004. Changes in the spontaneous and stimulus-evoked activity in the somatosensory cortex of rats on acute manganese administration. *Toxicol Lett* 148(1-2):125-131.
- \*Pellizzari ED, Clayton CA, Rodes CE, et al. 1999. Particulate matter and manganese exposures in Toronto, Canada. *Atmos Environ* 33:721-734.
- \*Pellizzari ED, Clayton CA, Rodes CE, et al. 2001. Particulate matter and manganese exposures in Indianapolis, Indiana. *J Expo Anal Environ Epidemiol* 11(6):423-440.
- Penalver R. 1955. Manganese poisoning: The 1954 Ramazzini oration. *Ind Med Surg* 24:1-7.
- Penney DA, Hogberg K, Traiger GJ, et al. 1985. The acute toxicity of cyclopentadienyl manganese tricarbonyl in the rat. *Toxicology* 34:341-347.

## 9. REFERENCES

- \*Pennington JAT, Young BE, Wilson DB, et al. 1986. Mineral content of foods and total diets: The selected minerals in foods survey, 1982 to 1984. *J Am Diet Assoc* 86:876-891.
- \*Perl DP, Olanow CW. 2007. The neuropathology of manganese-induced Parkinsonism. *J Neuropathol Exp Neurol* 66(8):675-682.
- +\*Perocco P, Santucci MA, Campani AG, et al. 1989. Toxic and DNA-damaging activities of the fungicides mancozeb and thiram (TMTD) on human lymphocytes in vitro. *Teratog Carcinog Mutagen* 9:75-81.
- Petrova-Vergieva T, Ivanova-Tchemishanska L. 1973. Assessment of the teratogenic activity of dithiocarbamate fungicides. *Food Cosmet Toxicol* 11:239-244.
- Pezzoli G, Canesi M, Ravina B, et al. 2001. (Comment on: *Neurology* 56:8-13). *Neurology* 57:936-937, 1738-1739.
- Pfeifer GD, Roper JM, Dorman D, et al. 2004. Health and environmental testing of manganese exhaust products from use of methylcyclopentadienyl manganese tricarbonyl in gasoline. *Sci Total Environ* 334-335:397-408.
- Phoon WH. 1988. Manganese exposure and biological indicators. *Singapore Med J* 29:93-94.
- Pierson WR, McKee DE, Brachaczek WW, et al. 1978. Methylcyclopentadienyl manganese tricarbonyl: Effect on manganese emissions from vehicles on the road. *J Air Pollut Control Assoc* 28:692-693.
- Pifl C, Khorchide M, Kattinger A, et al. 2004. alpha-Synuclein selectively increases manganese-induced viability loss in SK-N-MC neuroblastoma cells expressing the human dopamine transporter. *Neurosci Lett* 354(1):34-37.
- \*Pihl RO, Parkes M. 1977. Hair element contents in learning disabled children. *Science* 198:204-206.
- \*Pine M, Lee B, Dearth R, et al. 2005. Manganese acts centrally to stimulate luteinizing hormone secretion: A potential influence on female pubertal development. *Toxicol Sci* 85(2):880-885.
- Pinto FG, Rey UV, Fernandes EF, et al. 2006. Determination of manganese in urine and whole blood samples by electrothermal atomic absorption spectrometry: Comparison of chemical modifiers. *Anal Sci* 22(12):1605-1609.
- \*Pisarczyk K. 2005. Manganese compounds. *Kirk-Othmer encyclopedia of chemical technology*. Vol. 15. <http://mrw.interscience.wiley.com/emrw/9780471238966/kirk/article/mangpisa.a01/current/pdf>. April 07, 2008.
- Piscator M. 1970. Health hazards from inhalation of metal fumes. *Environ Res* 11:268-270.
- +Plantin LO, Lying-Tunell U, Kristensson K. 1987. Trace elements in the human central nervous system studied with neutron activation analysis. *Biol Trace Elem Res* 13:69-75.
- Pleil JD, Oliver KD, McClenny WA. 1988. Ambient air analyses using nonspecific flame ionization and electron capture detection compared to specific detection by mass spectrometry. *J Air Pollut Control Assoc* 38:1006-1010.

## 9. REFERENCES

- +\*Pollack S, George JN, Reba RC, et al. 1965. The absorption of nonferrous metals in iron deficiency. *J Clin Invest* 44:1470-1473.
- \*Pomier-Layrargues G, Rose C, Spahr L, et al. 1998. Role of manganese in the pathogenesis of portal-systemic encephalopathy. *Metabol Brain Dis* 13:311-317.
- \*Ponnamperuma FN, Loy TA, Tianco EM. 1969. Redox equilibria in flooded soils: II. The manganese oxide systems. *Soil Science* 108:48-57.
- +\*Ponnapakkam TP, Bailey KS, Graves KA, et al. 2003a. Assessment of male reproductive system in the CD-1 mice following oral manganese exposure. *Reprod Toxicol* 17(5):547-551.
- +\*Ponnapakkam T, Iszard M, Henry-Sam G. 2003b. Effects of oral administration of manganese on the kidneys and urinary bladder of Sprague-Dawley rats. *Int J Toxicol* 22:227-232.
- +\*Ponnapakkam TP, Sam GH, Iszard MB. 2003c. Histopathological changes in the testis of the Sprague Dawley rat following orally administered manganese. *Bull Environ Contam Toxicol* 71(6):1151-1157.
- Pramod KP, Samii A, Calne DB. 1999. Manganese neurotoxicity: A review of clinical features, imaging, and pathology. *Neurotoxicology* 20:227-238.
- \*Prestifilippo JP, Fernandez-Solari J, Mohn C, et al. 2007. Effect of manganese on luteinizing hormone-releasing hormone secretion in adult male rats. *Toxicol Sci* 97(1):75-80.
- Proctor NH, Hughes JP, Fischman ML. 1988. *Chemical hazards of the workplace*. 2nd ed. Philadelphia, PA: J.B. Lippincott Company, 307-308.
- Puli S, Lai JCK, Edgley KL, et al. 2006. Signaling pathways mediating manganese-induced toxicity in human glioblastoma cells (U87). *Neurochem Res* 31(10):1211-1218.
- \*Quimby BD, Uden PC, Barnes RM. 1978. Atmospheric pressure helium microwave detection system for gas chromatography. *Anal Chem* 50:2112-2118.
- \*Rabin O, Hegedus L, Bourre J-M, et al. 1993. Rapid brain uptake of manganese(II) across the blood-brain barrier. *J Neurochem* 61:509-517.
- \*Racette BA, Antenor JA, McGee-Minnich L, et al. 2005. [<sup>18</sup>F]FDOPA PET and clinical features in parkinsonism due to manganism. *Mov Disord* 20(4):492-496.
- \*Rai D, Zachara JM, Schwab AP, et al. 1986. Manganese. In: *Chemical attenuation rates, coefficients, and constants in leachate migration*. Volume 1: A critical review. Report to Electric Power Research Institute, Palo Alto, CA, by Battelle, Pacific Northwest Laboratories, Richland, WA, 15-1-15-4.
- Rama Rao KV, Reddy PV, Hazell AS, et al. 2007. Manganese induces cell swelling in cultured astrocytes. *Neurotoxicology* 28(4):807-812.
- Ramesh GT, Ghosh D, Gunasekar PG. 2002. Activation of early signaling transcription factor, NF-kappaB following low-level manganese exposure. *Toxicol Lett* 136(2):151-158.



## 9. REFERENCES

- +\*Ranasinghe JGS, Liu M, Sakakibara Y, et al. 2000. Manganese administration induces the increased production of dopamine sulfate and depletion of dopamine in Sprague-Dawley rats. *J Biochem (Tokyo)* 128:477-480.
- Rangaswamy JR, Vijayashankar YN. 1975. A rapid method for the determination of manganese ethylenebisdithiocarbamate and its residues on grains. *J Assoc Off Anal Chem* 58:1232-1234.
- Rao A LJ, Malik AK, Kapoor J. 1993. Extraction spectrophotometric determination of maneb with 1-(2'-pyridylazo)-2-naphthol (PAN). *Talanta* 40:201-203.
- Rao DB, Wong BA, McManus BE, et al. 2003. Inhaled iron, unlike manganese, is not transported to the rat brain via the olfactory pathway. *Toxicol Appl Pharmacol* 193:116-126.
- \*Rasmuson A. 1985. Mutagenic effects of some water-soluble metal compounds in a somatic eye-color test system in *Drosophila melanogaster*. *Mutat Res* 157:157-162.
- Rathore HS, Sharma R, Mital S. 1997. Spot test analysis of pesticides: Detection of carbaryl and mancozeb in water. *Water Air Soil Pollut* 97:431-441.
- Reaney SH, Smith DR. 2005. Manganese oxidation state mediates toxicity in PC12 cells. *Toxicol Appl Pharmacol* 205:271-281.
- \*Reaney SH, Bench G, Smith DR. 2006. Brain accumulation and toxicity of Mn(II) and Mn(III) exposures. *Toxicol Sci* 93(1):114-124.
- \*Reddy MR, Perkins HF. 1976. Fixation of manganese by clay minerals. *Soil Science* 121:21-24.
- Reeves PG, Ralston NVD, Idso JP, et al. 2004. Contrasting and cooperative effects of copper and iron deficiencies in male rats fed different concentrations of manganese and different sources of sulfur amino acids in an AIN-93G-based diet. *J Nutr* 134:416-425.
- +\*Rehnberg GL, Hein JF, Carter SD, et al. 1980. Chronic manganese oxide administration to pre-weanling rats: Manganese accumulation and distribution. *J Toxicol Environ Health* 6:217-226.
- +\*Rehnberg GL, Hein JF, Carter SD, et al. 1981. Chronic ingestion of Mn<sub>3</sub>O<sub>4</sub> by young rats: Tissue accumulation, distribution, and depletion. *J Toxicol Environ Health* 7:263-272.
- +\*Rehnberg GL, Hein JF, Carter SD, et al. 1982. Chronic ingestion of Mn<sub>3</sub>O<sub>4</sub> by rats: Tissue accumulation and distribution of manganese in two generations. *J Toxicol Environ Health* 9:175-188.
- +\*Rehnberg GL, Hein JF, Carter SD, et al. 1985. Age-dependent changes in gastrointestinal transport and retention of particulate manganese oxide in the rat. *J Toxicol Environ Health* 16:887-899.
- +\*Reichel CM, Wacan JJ, Farley CM, et al. 2006. Postnatal manganese exposure attenuates cocaine-induced locomotor activity and reduces dopamine transporters in adult male rats. *Neurotoxicol Teratol* 28(3):323-332.
- \*Ressler T, Wong J, Roos J, et al. 2000. Quantitative speciation of Mn-bearing particulates emitted from autos burning (methylcyclopentadienyl) manganese tricarbonyl-added gasolines using XANES spectroscopy. *Environ Sci Technol* 34:950-958.

## 9. REFERENCES

- Rhodes RC. 1977. Studies with manganese [<sup>14</sup>C]ethylenebis(dithiocarbamate)([<sup>14</sup>C]maneb) fungicide and [<sup>14</sup>C]ethylenethiourea ([<sup>14</sup>C]ETU) in plants, soil, and water. *J Agric Food Chem* 25:528-533.
- \*Rice RH, Cohen DE. 1996. Toxic responses of the skin. In: Klassen CD, Amdur MO, Doull J, eds. *Casarett and Doull's toxicology: The basic science of poisons*. 5th ed. New York, NY: McGraw-Hill, 529-544.
- Robinson D. 2004. Subways grind out a dose of fine metals. *Environ Sci Technol* (Feb):49-50.
- +\*Rodier J. 1955. Manganese poisoning in Moroccan miners. *Br J Ind Med* 12:21-35.
- \*Rodríguez-Agudelo Y, Riojas-Rodriguez H, Rios C, et al. 2006. Motor alterations associated with exposure to manganese in the environment in Mexico. *Sci Total Environ* 368(2-3):542-556.
- +\*Roels H, Lauwerys R, Buchet JP, et al. 1987a. Epidemiological survey among workers exposed to manganese: Effects on lung, central nervous system, and some biological indices. (Erratum in: *Am J Ind Hyg* 12:119-120). *Am J Ind Med* 11:307-327.
- \*Roels H, Lauwerys R, Genet P, et al. 1987b. Relationship between external and internal parameters of exposure to manganese in workers from a manganese oxide and salt producing plant. *Am J Ind Med* 11:297-305.
- Roels H et al. 1987c. (Erratum on: *Am J Ind Med* 11:307-327).
- +\*Roels H, Meiers G, Delos M, et al. 1997. Influence of the route of administration and the chemical form (MnCl<sub>2</sub>, MnO<sub>2</sub>) on the absorption and cerebral distribution of manganese in rats. *Arch Toxicol* 71:223-230.
- +Roels H, Sarhan MJ, Hanotiau I, et al. 1985. Preclinical toxic effects of manganese in workers from a manganese salts and oxides producing plant. *Sci Total Environ* 42:201-206.
- +\*Roels HA, Ghyselen P, Buchet JP, et al. 1992. Assessment of the permissible exposure level to manganese in workers exposed to manganese dioxide dust. *Br J Ind Med* 49:25-34.
- +\*Roels HA, Ortega Eslava MI, Ceulemans E, et al. 1999. Prospective study on the reversibility of neurobehavioral effects in workers exposed to manganese dioxide. *Neurotoxicology* 20:255-272.
- +\*Rogers RR, Garner RJ, Riddle MM, et al. 1983. Augmentation of murine natural killer cell activity by manganese chloride. *Toxicol Appl Pharmacol* 70:7-17.
- Rollin HB, Mathee A, Levin J, et al. 2005. Blood manganese concentrations among first-grade schoolchildren in two South African cities. *Environ Res* 97(1):93-99.
- Rollin HB, Mathee A, Levin J, et al. 2007. Examining the association between blood manganese and lead levels in schoolchildren in four selected regions of South Africa. *Environ Res* 103(2):160-167.
- \*Rope SK, Arthur WJ, Craig TH, et al. 1988. Nutrient and trace elements in soil and desert vegetation of southern Idaho. *Environ Monit Assess* 10:1-24.
- +\*Rose C, Butterworth RF, Zayed J, et al. 1999. Manganese deposition in basal ganglia structures results from both portal-systemic shunting and liver dysfunction. *Gastroenterology* 117:640-644.

## 9. REFERENCES

- Rosenberg C, Siltanen H. 1979. Residues of mancozeb and ethylenethiourea in grain samples. *Bull Environ Contam Toxicol* 22:475-478.
- +\*Rosenstock HA, Simons DG, Meyer JS. 1971. Chronic manganism: Neurologic and laboratory studies during treatment with levodopa. *J Am Med Assoc* 217:1354-1358.
- +\*Rossander-Hulten L, Brune M, Sandstrom B, et al. 1991. Competitive inhibition of iron absorption by manganese and zinc in humans. *Am J Clin Nutr* 54:152-156.
- \*Roth JA. 2006. Homeostatic and toxic mechanisms regulating manganese uptake, retention, and elimination. *Toxicol* 39:45-57.
- Roth JA, Feng L, Walowitz J, et al. 2000. Manganese-induced rat pheochromocytoma (PC12) cell death is independent of caspase activation. *J Neurosci Res* 61:162-171.
- Roth JA, Horbinski C, Higgins D, et al. 2002. Mechanisms of manganese-induced rat pheochromocytoma (PC12) cell death and cell differentiation. *Neurotoxicology* 23:147-157.
- Rovetta F, Catalani S, Steimberg N, et al. 2007. Organ-specific manganese toxicity: A comparative in vitro study on five cellular models exposed to MnCl<sub>2</sub>. *Toxicol In Vitro* 21:284-292.
- \*RTECS. 2007. Manganese. Registry of Toxic Effects on Chemical Substances. National Institute of Occupational Safety and Health. MDL Information Systems, Inc. May 8, 2008.
- Ruitjen MWMM, Sallé HJA, Verberk MM, et al. 1994. Effect of chronic mixed pesticide exposure on peripheral and autonomic nerve function. *Arch Environ Health* 49:188-195.
- \*Rückgauer M, Klein J, Kruse-Jarres JD. 1997. Reference values for the trace elements copper, manganese, selenium, and zinc in the serum/plasma of children, adolescents, and adults. *J Trace Elements Med Biol* 11:92-98.
- \*Ruoff W. 1995. Relative bioavailability of manganese ingested in food or water. In: *Proceedings: Workshop on the bioavailability and oral toxicity of manganese*, Omni Netherland Plaza, August 30-31, 1994. Lexington, MA: Eastern Research Group, Inc., 65-75.
- Sadek AH, Rauch R, Schulz PE. 2003. Parkinsonism due to manganism in a welder. *Int J Toxicol* 22:393-401.
- +\*Sahni V, Leger Y, Panaro L, et al. 2007. Case report: A metabolic disorder presenting as pediatric manganism. *Environ Health Perspect* 115:1776-1779.
- +\*Sakurai H, Nishida M, Yoshimura T, et al. 1985. Partition of divalent and total manganese in organs and subcellular organelles of MnCl<sub>2</sub>-treated rats studied by ESR and neutron activation analysis. *Biochim Biophys Acta* 841:208-214.
- +\*Salehi F, Krewski D, Mergler D, et al. 2003. Bioaccumulation and locomotor effects of manganese phosphate/sulfate mixture in Sprague-Dawley rats following subchronic (90 day) inhalation exposure. *Toxicol Appl Pharmacol* 191:264-271.

## 9. REFERENCES

- +\*Salehi F, Normandin L, Krewski D, et al. 2006. Neuropathology, tremor and electromyogram in rats exposed to manganese phosphate/sulfate mixture. *J Appl Toxicol* 26:419-426.
- Saltzman BE, Cholak J, Schafer LJ, et al. 1985. Concentrations of six metals in the air of eight cities. *Environ Sci Technol* 19:328-333.
- +\*Sánchez DJ, Domingo JL, Llobet JM, et al. 1993. Maternal and developmental toxicity of manganese in the mouse. *Toxicol Lett* 69:45-52.
- +\*Sandstrom B, Davidsson L, Cederblad A, et al. 1986. Manganese absorption and metabolism in man. *Acta Pharmacol Toxicol (Copenh)* 59:60-62.
- +\*Sandstrom B, Davidsson L, Eriksson R, et al. 1990. Effect of long-term trace element supplementation on blood trace element levels and absorption of (<sup>75</sup>Se), (<sup>54</sup>Mn) and (<sup>65</sup>Zn). *J Trace Elem Electrolytes Health Dis* 4:65-72.
- +Sarhan MJ, Roels H, Lauwerys R. 1986. Influence of manganese on the gastrointestinal absorption of cadmium in rats. *J Appl Toxicol* 6:313-316
- +\*Saric M, Hrustic O. 1975. Exposure to airborne manganese and arterial blood pressure. *Environ Res* 10:314-318.
- +\*Saric M, Lucic-Palaic S. 1977. Possible synergism of exposure to airborne manganese and smoking habit occurrence of respiratory symptoms. In: Walton WH, ed. *Inhaled particles. IV*. New York, NY: Pergamon Press, 773-779.
- +\*Saric M, Markicevic A, Hrustic O. 1977. Occupational exposure to manganese. *Br J Ind Med* 34:114-118.
- Sassine M-P, Mergler D, Bowler R, et al. 2002. Manganese accentuates adverse mental health effects associated with alcohol use disorders. *Biol Psychiatry* 51:909-921.
- Savolainen K, Kurtio P, Vartiainen T, et al. 1989. Ethylenethiourea as an indicator of exposure to ethylenebisdithiocarbamate fungicides. *Arch Toxicol Suppl* 13:120-123.
- \*Sax NI, Lewis RJ. 1987. *Hawley's condensed chemical dictionary*. 11th ed. New York, NY: Van Nostrand Reinhold Company, 727-731.
- Saxena J, Howard PH. 1977. Environmental transformation of alkylated and inorganic forms of certain metals. *Adv Microb* 21:185-226.
- +\*Schaanning M, Naes K, Egeberg PK, et al. 1988. Cycling of manganese in the permanently anoxic Drammens fjord. *Marine Chemistry* 23:365-382.
- +\*Schafer DF, Stephenson DV, Barak AJ, et al. 1974. Effects of ethanol on the transport of manganese by small intestine of the rat. *J Nutr* 104:101-104.
- Schaumburg HH, Herskovitz S, Cassano VA. 2006a. Occupational manganese neurotoxicity provoked by hepatitis C. (Erratum in *Neurology* 67:1902). *Neurology* 67(2):322-323.

## 9. REFERENCES

- Schaumburg HH, Herskovitz S, Cassano VA. 2006b. Occupational manganese neurotoxicity provoked by hepatitis C (Erratum on: *Neurology* 2006; 67:322-323). *Neurology* 67:1902.
- +Scheuhammer AM. 1983. Chronic manganese exposure in rats: Histological changes in the pancreas. *J Toxicol Environ Health* 12:353-360.
- +Scheuhammer AM, Cherian MG. 1983. The influence of manganese on the distribution of essential trace elements. II. The tissue distribution of manganese, magnesium, zinc, iron, and copper in rats after chronic manganese exposure. *J Toxicol Environ Health* 12(2-3):361-370.
- \*Schneider JS, Decamp E, Koser AJ, et al. 2006. Effects of chronic manganese exposure on cognitive and motor functioning in non-human primates. *Brain Res* 1118(1):222-231.
- \*Schnitzer M. 1969. Reactions between fulvic acid, a soil humic compound and inorganic soil constituents. *Soil Sci Soc Amer Proc* 33:75-80.
- \*Schonwald S. 2004. Manganese. In: Dart RC, ed. *Medical toxicology*. 3rd ed. Philadelphia, PA: Lippicott Williams & Wilkins, 1433-1434.
- Schramm VL, Brandt M. 1986. The manganese(II) economy of rat hepatocytes. *Fed Proc* 45:2817-2820.
- \*Schroeder HA, Balassa JJ, Tipton IH. 1966. Essential trace metals in man: Manganese. A study in homeostasis. *J Chron Dis* 19:545-571.
- \*Schroeder WH, Dobson M, Kane DM, et al. 1987. Toxic trace elements associated with airborne particulate matter: A review. *J Air Pollut Control Assoc* 37:1267-1285.
- +\*Schuler P, Oyanguren H, Maturana V, et al. 1957. Manganese poisoning: Environmental and medical study at a Chilean mine. *Ind Med Surg* 26:167-173.
- Schwab AP, Lindsay WL. 1983. The effect of redox on the solubility and availability of manganese in a calcareous soil. *Soil Sci Soc Am J* 47:217-220.
- Scott DT, McKnight DM, Voelker BM, et al. 2002. Redox processes controlling manganese fate and transport in a mountain stream. *Environ Sci Technol* 36(3):453-459.
- +\*Segura-Aguilar J, Lind C. 1989. On the mechanism of the Mn<sup>3+</sup>-induced neurotoxicity of dopamine: Prevention of quinone-derived oxygen toxicity by DT diaphorase and superoxide dismutase. *Chem Biol Interact* 72:309-324.
- Sengupta A, Mense SM, Lan C, et al. 2007. Gene expression profiling of human primary astrocytes exposed to manganese chloride indicates selective effects on several functions of the cells. *Neurotoxicology* 28(3):478-489.
- Serio R, Long RA, Taylor JE, et al. 1984. The antifertility and antiadrenergic actions of thiocarbamate fungicides in laying hens. *Toxicol Appl Pharmacol* 72:333-342.
- \*Setchell BP, Waites GMH. 1975. The blood-testis barrier. In: Creep RO, Astwood EB, Geiger SR, eds. *Handbook of physiology: Endocrinology V*. Washington, DC: American Physiological Society, 143-172.

## 9. REFERENCES

- Seth PK, Chandra SV. 1984. Neurotransmitters and neurotransmitter receptors in developing and adult rats during manganese poisoning. *Neurotoxicology* 5:67-76.
- +Seth PK, Hong JS, Kilts CD, et al. 1981. Alteration of cerebral neurotransmitter receptor function by exposure of rats to manganese. *Toxicol Lett* 9:247-254.
- +\*Seth PK, Nagar N, Husain R, et al. 1973. Effects of manganese on rabbit testes. *Environ Physiol Biochem* 3:263-267.
- Shi XL, Dalal NS. 1990. The glutathionyl radical formation in the reaction between manganese and glutathione and its neurotoxic implications. *Med Hypotheses* 33:83-87.
- Shigan SA, Vitvitskaya BR. 1971. [Experimental substantiation of permissible residual concentration of potassium permanganate in drinking water.] *Gig Sanit* 36:15-18. (Russian)
- Shin YC, Kim E, Cheong HK, et al. 2007. High signal intensity on magnetic resonance imaging as a predictor of neurobehavioral performance of workers exposed to manganese. *Neurotoxicology* 28(2):257-262.
- +\*Shiotsuka RN. 1984. Inhalation toxicity of manganese dioxide and a magnesium oxide-manganese dioxide mixture. Report to U.S. Army Medical Research and Developmental Command, Fort Detrick, Frederick, MD, by Inhalation Toxicology Facility, Medical Department.
- Shukakidze AA, Lazriev IL, Khetsuriani RG, et al. 2002. Changes in neuroglial ultrastructure in various parts of the rat brain during manganese chloride poisoning. *Neurosci Behav Physiol* 32(6):561-566.
- +\*Shukakidze AA, Lazriev IL, Mitagvariya N. 2003. Behavioral impairments in acute and chronic manganese poisoning in white rats. *Neurosci Behav Physiol* 33(3):263-267.
- \*Shukla GS, Chandra SV, Seth KP. 1976. Effect of manganese on the levels of DNA, RNA, DNase and RNase in cerebrum, cerebellum and rest of brain regions of rat. *Acta Pharmacol Toxicol* 39:562-569.
- +Shukla GS, Dubey MP, Chandra SV. 1980. Manganese-induced biochemical changes in growing versus adult rats. *Arch Environ Contam Toxicol* 9:383-391.
- \*Shukla GS, Singh S, Chandra SV. 1978. The interaction between manganese and ethanol in rats. *Acta Pharmacol Toxicol* 43:354-362.
- Shukla Y, Antony M, Kumar S, et al. 1988. Tumour-promoting ability of mancozeb, a carbamate fungicide, on mouse skin. *Carcinogenesis* 9(8):1511-1512.
- Shukla Y, Antony M, Kumar S, et al. 1990. Carcinogenic activity of a carbamate fungicide, mancozeb, on mouse skin. *Cancer Lett* 53:191-195.
- +\*Shuqin K, Haishang D, Peiyi X, et al. 1992. A report of two cases of chronic serious manganese poisoning treated with sodium para-aminosalicylic acid. *Br J Ind Med* 49:66-69.
- Siddiqui A, Ali B, Srivastava SP. 1993. Age-related effects in the inhibition of oxidative metabolism of xenobiotics by mancozeb. *Vet Hum Toxicol* 35(1):4-6.

## 9. REFERENCES

- Siddiqui S, Srivastava SP, Ali B. 1990. Effect of mancozeb on hydrolytic metabolism of xenobiotics. *Res Commun Chem Pathol Pharmacol* 70(2):249-252.
- +Sierra P, Chakrabarti S, Tounkara R, et al. 1998. Bioaccumulation of manganese and its toxicity in feral pigeons (*Columba livia*) exposed to manganese oxide dust (Mn<sub>3</sub>O<sub>4</sub>). *Environ Res* 79:94-101.
- \*Sierra P, Loranger S, Kennedy G, et al. 1995. Occupational and environmental exposure of automobile mechanics and nonautomotive workers to airborne manganese arising from the combustion of methylcyclopentadienyl manganese tricarbonyl (MMT). *Am Ind Hyg Assoc J* 56(7):713-716.
- Sikk K, Taba P, Haldre S, et al. 2007. Irreversible motor impairment in young addicts--ephedrone, managanism or both? *Acta Neurol Scand* 115(6):385-389.
- \*Silbergeld EK. 1982. Current status of neurotoxicology, basic and applied. *Trends Neurosci* 5:291-294.
- Silbergeld EK. 1999. Introduction. MMT: Science and policy. *Environ Res Section A* 80:93-95.
- Sinczuk-Walczak H, Jakubowski M, Matczak W. 2001. Neurological and neurophysiological examinations of workers occupationally exposed to manganese. *Int J Occup Med Environ Health* 14(4):329-337.
- \*Singh I. 1984. Induction of gene conversion and reverse mutation by manganese sulphate and nickel sulphate in *Saccharomyces cerevisiae*. *Mutat Res* 137:47-49.
- +Singh J, Husain R, Tandon SK, et al. 1974. Biochemical and histopathological alterations in early manganese toxicity in rats. *Environ Physiol Biochem* 4:16-23.
- +Singh J, Kaw JL, Zaidi SH. 1977. Early biochemical response of pulmonary tissue to manganese dioxide. *Toxicology* 8:177-184.
- +\*Singh PP, Junnarkar AY. 1991. Behavioural and toxic profile of some essential trace metal salts in mice and rats. *Ind J Pharmacol* 23:153-159.
- +\*Singh S, Shukla GS, Srivastava RS, et al. 1979. The interaction between ethanol and manganese in rat brain. *Arch Toxicol* 41(4):307-316.
- +\*Siqueira ME, Moraes EC. 1989. Homovanillic acid (HVA) and manganese in urine of workers exposed in a ferromanganese alloy plant. *Med Lav* 80:224-228.
- +\*Siqueira ME, Hirata MH, Adballa DS. 1991. Studies on some biochemical parameters in human manganese exposure. *Med Lav* 82(6):504-509.
- +Sitaramayya A, Nagar N, Chandra SV. 1974. Effect of manganese on enzymes in rat brain. *Acta Pharmacol Toxicol* 35:185-190.
- Sittig M. 1985. Handbook of toxic and hazardous chemicals and carcinogens. 2nd ed. Park Ridge, NY: Noyes Publications, 559-562.
- Sjogren B, Gustavsson P, Hogstedt C. 1990. Neuropsychiatric symptoms among welders exposed to neurotoxic metals. *Br J Ind Med* 47:704-707.

## 9. REFERENCES

- +\*Sloot WN, Gramsbergen JP. 1994. Axonal transport of manganese and its relevance to selective neurotoxicity in the rat basal ganglia. *Brain Res* 657:124-132.
- Sly LI, Hodgkinson MC, Arunpairojana V. 1988. Effect of water velocity on the early development of manganese-depositing biofilm in a drinking water distribution system. *FEMS Microbiol Ecol* 53:175-186.
- \*Smargiassi A, Mutti A. 1999. Peripheral biomarkers of exposure to manganese. *Neurotoxicology* 20:401-406.
- +\*Smargiassi A, Mergler D, Bergamaschi E, et al. 1995. Peripheral markers of catecholamine metabolism among workers occupationally exposed to manganese (Mn). *Toxicol Lett* 77:329-333.
- Smargiassi A, Takser L, Masse A, et al. 2002. A comparative study of manganese and lead levels in human umbilical cords and maternal blood from two urban centers exposed to different gasoline additives. *Sci Total Environ* 290:157-164.
- +\*Smialowicz RJ, Luebke RW, Rogers RR, et al. 1985. Manganese chloride enhances natural cell-mediated immune effector cell function: Effects on macrophages. *Immunopharmacology* 9:1-11.
- +\*Smialowicz RJ, Rogers RR, Riddle MM, et al. 1987. Effects of manganese, calcium, magnesium, and zinc on nickel-induced suppression of murine natural killer cell activity. *J Toxicol Environ Health* 20:67-80.
- \*Smith D, Gwiazka R, Bowler R, et al. 2007. Biomarkers of Mn exposure in humans. *Am J Ind Med* 50:801-811.
- \*Smith GW, Palmby AK. 1959. Flame photometric determination of lead and manganese in gasoline. *Anal Chem* 31:1798-1802.
- \*Smith RA, Alexander RB, Wolman MG. 1987. Water-quality trends in the nation's rivers. *Science* 235:1607-1615.
- +Smith SE, Medlicott M, Ellis GH. 1944. Manganese deficiency in the rabbit. *Arch Biochem Biophys* 4:281-289.
- +\*Smyth HF, Carpenter CP, Weil CS, et al. 1969. Range-finding toxicity data: List VII. *Am Ind Hyg Assoc J* 30:470-476.
- +\*Smyth LT, Ruhf RC, Whitman NE, et al. 1973. Clinical manganese and exposure to manganese in the production and processing of ferromanganese alloy. *J Occup Med* 15:101-109.
- Snella MC. 1985. Manganese dioxide induces alveolar macrophage chemotaxis for neutrophils in vitro. *Toxicology* 34:153-159.
- Sobotka T. 1971. Comparative effects of 60-day feeding of maneb and of ethylenethiourea on thyroid electrophoretic patterns of rats. *Food Cosmet Toxicol* 9:537-540.
- Sobotka TJ, Brodie RE, Cook MP. 1972. Behavioral and neuroendocrine effects in rats of postnatal exposure to low dietary levels of maneb. *Dev Psychobiol* 5(2):137-148.



## 9. REFERENCES

- Sobti RC, Kaur H, Sharma M. 1987. Mutagenicity of dithiocarbamate herbicide Dithane M-45 (mancozeb). *Chromosome Inf Serv* 42:20-22.
- Soldin OP, Aschner M. 2007. Effects of manganese on thyroid hormone homeostasis: Potential links. *Neurotoxicology* 28:951-956.
- Soleo L, Difazio G, Scarselli R, et al. 1996. Toxicity of fungicides containing ethylene-bis-dithiocarbamate in serumless dissociated mesencephalic-striatal primary coculture. *Arch Toxicol* 70:678-682.
- +\*Southwood T, Lamb CM, Freeman J. 1987. Ingestion of potassium permanganate crystals by a 3-yr-old boy. *Med J Aust* 146:639-640.
- +\*Spadoni F, Stefani A, Morello M, et al. 2000. Selective vulnerability of pallidal neurons in the early phases of manganese intoxication. *Exp Brain Res* 138:544-551.
- +\*Spahr L, Butterworth RF, Fontaine S, et al. 1996. Increased blood manganese in cirrhotic patients: Relationship to pallidal magnetic resonance signal hyperintensity and neurological symptoms. *Hepatology* 24:1116-1120.
- Spangler JG, Elsner R. 2006. Commentary on possible manganese toxicity from showering: Response to critique. *Med Hypotheses* 66:1231-1233.
- Spranger M, Schwab S, Desiderato S, et al. 1998. Manganese augments nitric oxide synthesis in murine astrocytes: A new pathogenetic mechanism in manganism? *Exp Neurol* 149:277-283.
- \*SRI. 2007. Methylcyclopentadienyl manganese tricarbonyl. 2007 Directory of chemical producers. Menlo Park, CA: SRI Consulting. Access Intelligence, LLC., 739.
- +Srisuchart B, Taylor MJ, Sharma RP. 1987. Alteration of humoral and cellular immunity in manganese chloride-treated mice. *J Toxicol Environ Health* 22:91-99.
- +Srivastava VK, Chauhan SS, Srivastava PK, et al. 1990. Placental transfer of metals of coal fly ash into various fetal organs of rat. *Arch Toxicol* 64:153-156.
- \*St-Pierre A, Normandin L, Carrier G, et al. 2001. Bioaccumulation and locomotor effect of manganese dust in rats. *Inhal Toxicol* 13:623-632.
- \*Stanek EJ, Calabrese EJ. 1995. Daily estimates of soil ingestion in children. *Environ Health Perspect* 103:276-285.
- \*Stauber JL, Florence TM, Webster WS. 1987. The use of scalp hair to monitor manganese in aborigines from Groote Eylandt. *Neurotoxicology* 8:431-435.
- Steenland K, Cedillo L, Tucker J, et al. 1997. Thyroid hormones and cytogenetic outcomes in backpack sprayers using ethylenebis(dithiocarbamate) (EBDC) fungicides in Mexico. *Environ Health Perspect* 105:1126-1130.

## 9. REFERENCES

- Stern RM, Berlin A, Fletcher A, et al. 1986. International conference on health hazards and biological effects of welding fumes and gases, Copenhagen, 18-21 February 1985. Summary report. *Int Arch Occup Environ Health* 57:237-246.
- Stevenson A. 1972. A simple color spot test of distinguishing between maneb, zineb, mancozeb, and selected mixtures. *J Assoc Off Anal Chem* 55(5):939-941.
- Stockl NK. 1989. [Experimental investigations of the retention of lead and other trace elements (Fe, Cu, Zn, Mn) in juvenile and adult rats exposed to different levels of alimentary lead.] Munich, Germany: Institut Fur Ernährungsphysiologic Der Technischen Universitat Munchen [Dissertation]. DE88770330. (German)
- +Stoner GD, Shimkin MB, Troxell MC, et al. 1976. Test for carcinogenicity of metallic compounds by the pulmonary tumor response in strain A mice. *Cancer Res* 36:1744-1747.
- Storey E, Hyman BT, Jenkins B, et al. 1992. 1-Methyl-4-phenylpyridinium produces excitotoxic lesions in rat striatum as a result of impairment of oxidative metabolism. *J Neurochem* 58:1975-1978.
- +Strause LG, Hegenauer J, Saltman P, et al. 1986. Effects of long-term dietary manganese and copper deficiency on rat skeleton. *J Nutr* 116:135-141.
- \*Stredrick DL, Stokes AH, Worst TJ, et al. 2004. Manganese-induced cytotoxicity in dopamine-producing cells. *Neurotoxicology* 25(4):543-553.
- Struve MF, McManus BE, Wong BA, et al. 2007. Basal ganglia neurotransmitter concentrations in rhesus monkeys following subchronic manganese sulfate inhalation. *Am J Ind Med* 50(10):772-778.
- \*Stupar J, Dolinsek F. 1996. Determination of chromium, manganese, lead, and cadmium in biological samples including hair using direct electrothermal atomic absorption spectrometry. *Spectrochim Acta B* 51:665-683.
- +\*Sturaro A, Parvoli G, Doretto L, et al. 1994. The influence of color, age, and sex on the content of zinc, copper, nickel, manganese, and lead in human hair. *Biol Trace Elem Res* 40:1-8.
- +\*Suarez N, Walum E, Eriksson H. 1995. Cellular neurotoxicity of trivalent manganese bound to transferrin or pyrophosphate studied in human neuroblastoma (SH-SY5Y) cell cultures. *Toxicol in Vitro* 9:717-721.
- +\*Subhash MN, Padmashree TS. 1991. Effect of manganese on biogenic amine metabolism in regions of the rat brain. *Food Chem Toxicol* 29:579-582.
- Subramoniam A, Agrawal D, Srivastava SP, et al. 1991. Influence of mancozeb on mitogenically responsive lipids in rat cerebrum and liver. *Indian J Exp Biol* 29(10):943-945.
- Sukandar S, Yasuda K, Tanaka M, et al. 2006. Metals leachability from medical waste incinerator fly ash: A case study on particle size comparison. *Environ Pollut* 144(3):726-735.
- +\*Sumino K, Hayakawa K, Shibata T, et al. 1975. Heavy metals in normal Japanese tissues: Amounts of 15 heavy metals in 30 subjects. *Arch Environ Health* 30:487-494.

## 9. REFERENCES

- \*Sunderman FW, Kasprzak KS, Lau TJ, et al. 1976. Effects of manganese on carcinogenicity and metabolism of nickel subsulfide. *Cancer Res* 36:1790-1800.
- Sunderman FW, Reid MC, Allpass PR, et al. 1980. Manganese inhibition of sarcoma induction by benzo(a)pyrene in Fischer rats. *Proc Am Assoc Cancer Res* 21:72.
- Sung JH, Kim CY, Yang SO, et al. 2007. Changes in blood manganese concentration and MRI T1 relaxation time during 180 days of stainless steel welding-fume exposure in Cynomolgus monkeys. *Inhal Toxicol* 19:47-55.
- Suzuki T, Tsukamoto I. 2005. Manganese-induced apoptosis in hepatocytes after partial hepatectomy. *Eur J Pharmacol* 525(1-3):48-53.
- +\*Suzuki Y, Fujii N, Yano H, et al. 1978. Effects of the inhalation of manganese dioxide dust on monkey lungs. *Tokushima J Exp Med* 25(3-4):119-125.
- Suzuki Y, Mouri T, Suzuki Y et al. 1975. Study of subacute toxicity of manganese dioxide in monkeys. *Tokushima J Exp Med* 22:5-10.
- +\*Svensson O, Engfeldt B, Reinholt FP, et al. 1987. Manganese rickets: A biochemical and stereologic study with special reference to the effect of phosphate. *Clin Orthop (No. 218)*:302-311.
- +\*Svensson O, Hjerpe A, Reinholt FP, et al. 1985. The effect of manganese ingestion, phosphate depletion, and starvation on the morphology of the epiphyseal growth plate: A stereologic study. *Clin Orthop (No. 197)*:286-294.
- \*Sweet CW, Vermette SJ, Landsberger S. 1993. Sources of toxic trace elements in urban air in Illinois. *Environ Sci Technol* 27(12):2502-2510.
- +\*Szakmáry E, Ungvary G, Hudak A, et al. 1995. Developmental effect of manganese in rat and rabbit. *Cent Eur J Occup Environ Med* 1:149-159.
- Sziráki I, Mohanakumar KP, Rauhala P, et al. 1998. Manganese: A transition metal protects nigrostriatal neurons from oxidative stress in the iron-induced animal model of Parkinsonism. *Neuroscience* 85(4):1101-1111.
- +Sziráki I, Rauhala P, Chiueh CC. 1995. Novel protective effect of manganese against ferrous citrate-induced lipid peroxidation and nigrostriatal neurodegeneration in vivo. *Brain Res* 698(1-2):285-287.
- \*Sziráki I, Rauhala P, Kon Koh K, et al. 1999. Implications for atypical antioxidative properties of manganese in iron-induced brain lipid peroxidation and copper-dependent low density lipoprotein conjugation. *Neurotoxicology* 20:455-466.
- Takahashi RN, Rogerio R, Zanin M. 1989. Maneb enhances MPTP neurotoxicity in mice. *Res Commun Chem Pathol Pharmacol* 66(1):167-170.
- Takeda A, Ishiwatari S, Okada S. 1999. Manganese uptake into rat brain during development and aging. *J Neurosci Res* 56(1):93-98.
- Takeda A, Kodama Y, Ishiwatari S, et al. 1998b. Manganese transport in the neural circuit of rat CNS. *Brain Res Bull* 45(2):149-152.

## 9. REFERENCES

- \*Takeda A, Sawashita J, Okada S. 1994. Localization in rat brain of the trace metals, zinc and manganese, after intracerebroventricular injection. *Brain Res* 658:252-254.
- Takeda A, Sawashita J, Okada S. 1998a. Manganese concentration in rat brain: manganese transport from the peripheral tissues. *Neurosci Lett* 242:45-48.
- \*Takeda A, Sotogaku N, Oku N. 2002. Manganese influences the levels of neurotransmitters in synapses in rat brain. *Neuroscience* 114(3):669-674.
- \*Takeda A, Sotogaku N, Oku N. 2003. Influence of manganese on the release of neurotransmitters in rat striatum. *Brain Res* 965:279-282.
- Takser L, Lafond J, Bouchard M, et al. 2004a. Manganese levels during pregnancy and at birth: Relation to environmental factors and smoking in a Southwest Quebec population. *Environ Res* 95(2):119-125.
- Takser L, Mergler D, de Grosbois S, et al. 2004b. Blood manganese content at birth and cord serum prolactin levels. *Neurotoxicol Teratol* 26(6):811-815.
- Takser L, Mergler D, Hellier G, et al. 2003. Manganese, monoamine metabolite levels at birth, and child psychomotor development. *Neurotoxicology* 24(4-5):667-674.
- Talbot V. 1983. Lead and other trace metals in the sediments and selected biota of Princess Royal Harbour, Albany, Western Australia. *Environmental Pollution* 5:35-49.
- Tamm C, Sabri F, Ceccatelli S. 2008. Mitochondrial-mediated apoptosis in neural stem cells exposed to manganese. *Toxicol Sci* 101(2):310-323.
- Tanaka S. 1994. Manganese and its compounds. In: Zenz C, Dickerson OB, Horvath EP, eds. *Occupational medicine*. 3rd edition. St. Louis, MO: Mosby, 542-548.
- +\*Tanaka S, Lieben J. 1969. Manganese poisoning and exposure in Pennsylvania. *Arch Environ Health* 19:674-684.
- Tang LC. 1984. A personal and scientific biography of Dr. George C. Cotzias. *Neurotoxicology* 5:5-12.
- +\*Tapin D, Kennedy G, Lambert J, et al. 2006. Bioaccumulation and locomotor effects of manganese sulfate in Sprague-Dawley rats following subchronic (90 days) inhalation exposure. *Toxicol Appl Pharmacol* 211(2):166-174.
- Tarohda T, Ishida Y, Kawai K, et al. 2005. Regional distributions of manganese, iron, copper, and zinc in the brains of 6-hydroxydopamine-induced parkinsonian rats. *Anal Bioanal Chem* 383(2):224-234.
- \*Taylor HE. 1982. A summary of methods for water-quality analysis of specific species. In: Minear RA, Keith LH, eds. *Water analysis*. Vol. 1. Inorganic Species. Part 1. New York, NY: Academic Press, 235-273.
- \*Taylor MD, Erikson KM, Dobson AW, et al. 2006. Effects of inhaled manganese on biomarkers of oxidative stress in the rat brain. *Neurotoxicology* 27(5):788-797.

## 9. REFERENCES

- \*Teeguarden JG, Dorman DC, Covington TR, et al. 2007a. Pharmacokinetic modeling of manganese. I. Dose dependencies of uptake and elimination. *J Toxicol Environ Health A* 70:1493-1504.
- \*Teeguarden JG, Dorman DC, Nong A, et al. 2007b. Pharmacokinetic modeling of manganese. II. Hepatic processing after ingestion and inhalation. *J Toxicol Environ Health A* 70:1505-1514.
- \*Teeguarden JG, Gearhart J, Clewell HJ, et al. 2007c. Pharmacokinetic modeling of manganese. III. Physiological approaches accounting for background and tracer kinetics. *J Toxicol Environ Health A* 70:1515-1526.
- \*Ter Haar GL, Griffing ME, Brandt M, et al. 1975. Methylcyclopentadienyl manganese tricarbonyl as an antiknock: Composition and fate of manganese exhaust products. *J Air Pollut Control Assoc* 25:858-860.
- Tessier DM, Pascal LE. 2006. Activation of MAP kinases by hexavalent chromium, manganese and nickel in human lung epithelial cells. *Toxicol Lett* 167(2):114-121.
- Tholey G, Ledig M, Kopp P, et al. 1988. Levels and sub-cellular distribution of physiologically important metal ions in neuronal cells cultured from chick embryo cerebral cortex. *Neurochem Res* 13:1163-1167.
- \*Thomas K, Colborn T. 1992. Organochlorine endocrine disruptors in human tissue. In: Colborn T, Clement C, eds. *Chemically induced alterations in sexual and functional development: The wildlife/human connection*. Princeton, NJ: Princeton Scientific Publishing, 365-394.
- +\*Thompson TN, Klaassen CD. 1982. Presystemic elimination of manganese in rats. *Toxicol Appl Pharmacol* 64:236-243.
- \*Thompson K, Molina RM, Donaghey T, et al. 2006. The influence of high iron diet on rat lung manganese absorption. *Toxicol Appl Pharmacol* 210(1-2):17-23.
- \*Thompson K, Molina RM, Donaghey T, et al. 2007. Olfactory uptake of manganese requires DMT1 and is enhanced by anemia. *FASEB J* 21(1):223-230.
- \*Thompson SE, Burton CA, Quinn DJ, et al. 1972. Concentration factors of chemical elements in edible aquatic organisms. Lawrence Livermore Laboratory, Bio-Medical Division, University of California, Livermore, CA.
- Thomsen HS, Svendsen O, Klastrup S. 2004. Increased manganese concentration in the liver after oral intake. *Acad Radiol* 11(1):38-44.
- \*Thomson AB, Olatunbosun D, Valberg LS, et al. 1971. Interrelation of intestinal transport system for manganese and iron. *J Lab Clin Med* 78:642-655.
- +\*Tichy M, Cikrt M. 1972. Manganese transfer into the bile in rats. *Arch Toxicol* 29:51-58.
- Tiffany-Castiglioni E, Qian Y. 2001. Astroglia as metal depots: Molecular mechanisms for metal accumulation, storage and release. *Neurotoxicology* 22:577-592.
- \*Tinggi U, Reilly C, Patterson C. 1997. Determination of manganese and chromium in food by atomic absorption spectrometry after wet digestion. *Food Chem* 60:123-128.

## 9. REFERENCES

- \*Tipton IH, Cook MJ. 1963. Trace elements in human tissue. Part II. Adult subjects from the United States. *Health Phys* 9:103-145.
- Tissue GT, Hsiung T-M. 1987. Manganese speciation in a southeastern USA reservoir. 194th American Chemical Society National Meeting. *Abstr Pap Am Chem Soc* 194:231.
- Tjalkens RB, Liu X, Mohl B, et al. 2008. The peroxisome proliferator-activated receptor- $\gamma$  agonist 1,1-bis(3'-indolyl)-1-(p-trifluoromethylphenyl)methane suppresses manganese-induced production of nitric oxide in astrocytes and inhibits apoptosis in cocultured PC12 cells. *J Neurosci Res* 86:618-629.
- Tjalkens RB, Zoran MJ, Mohl B, et al. 2006. Manganese suppresses ATP-dependent intercellular calcium waves in astrocyte networks through alteration of mitochondrial and endoplasmic reticulum calcium dynamics. *Brain Res* 1119:210-219.
- \*Tjälve H, Henriksson J. 1999. Uptake of metals in the brain via olfactory pathways. *Neurotoxicology* 20:181-195.
- +\*Tjälve H, Henriksson J, Tallkvist J, et al. 1996. Uptake of manganese and cadmium from the nasal mucosa into the central nervous system via olfactory pathways in rats. *Pharmacol Toxicol* 79:347-356.
- +\*Toft KG, Friisk GA, Skotland T. 1997a. Mangafodipir trisodium injection, a new contrast medium for magnetic resonance imaging: Detection and quantification of the parent compound MnDPDP and metabolites in human plasma by high performance liquid chromatography. *J Pharm Biomed Anal* 15:973-981.
- +\*Toft KG, Hustvedt SO, Grant D, et al. 1997b. Metabolism and pharmacokinetics of MnDPDP in man. *Acta Radiol* 38:677-689.
- +\*Toft KG, Hustvedt SO, Grant D, et al. 1997c. Metabolism of mangafodipir trisodium (MnDPDP), a new contrast medium for magnetic resonance imaging, in beagle dogs. *Eur J Drug Metab Pharmacokinet* 22:65-72.
- Toft KG, Kindberg GM, Skotland T. 1997d. Mangafodipir trisodium injection, a new contrast medium for magnetic resonance imaging: In vitro metabolism and protein binding studies of the active component MnDPDP in human blood. *J Pharm Biomed Anal* 15:98.
- Torrente M, Colomina MT, Domingo JL. 2002. Effects of prenatal exposure to manganese on postnatal development and behavior in mice: Influence of maternal restraint. *Neurotoxicol Teratol* 24(2):219-225.
- +\*Torrente M, Colomina MT, Domingo JL. 2005. Behavioral effects of adult rats concurrently exposed to high doses of oral manganese and restraint stress. *Toxicology* 211(1-2):59-69.
- +\*Tran TT, Cowanadisai W, Crinella FM, et al. 2002b. Effect of high dietary manganese intake of neonatal rats on tissue mineral accumulation, striatal dopamine levels, and neurodevelopmental status. *Neurotoxicology* 23:635-643.
- +\*Tran TT, Chowanadisai W, Lonnerdal B, et al. 2002a. Effects of neonatal dietary manganese exposure on brain dopamine levels and neurocognitive functions. *Neurotoxicology* 23(4-5):645-651.

## 9. REFERENCES

- +\*Treinen KA, Gray TJB, Blazak WF. 1995. Developmental toxicity of mangafodipir trisodium and manganese chloride in Sprague-Dawley rats. *Teratol* 52:109-115.
- \*TRI06. 2008. TRI explorer: Providing access to EPA's toxics release inventory data. Washington, DC: Office of Information Analysis and Access. Office of Environmental Information. U.S. Environmental Protection Agency. Toxics Release Inventory. <http://www.epa.gov/triexplorer/>. February 27, 2008.
- Trivedi N, Kakkar R, Srivastava MK, et al. 1993. Effect of oral administration of fungicide-mancozeb on thyroid gland of rat. *Indian J Exp Biol* 31:564-566.
- \*Tsalev DL. 1983. Manganese. In: Tsalev DL. Atomic absorption spectrometry in occupational and environmental health practice. Vol. II. Determination of individual elements. Boca Raton, FL: CRC Press, Inc.
- Tsalev DL, Langmyhr FJ, Gunderson N. 1977. Direct atomic absorption spectrometric determination of manganese in whole blood of unexposed individuals and exposed workers in a Norwegian manganese alloy plant. *Bull Environ Contam Toxicol* 17:660-666.
- Tsuchiya H, Shima S, Kurita H, et al. 1987. Effects of maternal exposure to six heavy metals on fetal development. *Bull Environ Contam Toxicol* 38:580-587.
- \*Tsuda H, Kato K. 1977. Chromosomal aberrations and morphological transformation in hamster embryonic cells treated with potassium dichromate in vitro. *Mutat Res* 46:87-94.
- Tulikoura I, Vuori E. 1986. Effect of total parenteral nutrition on the zinc, copper, and manganese status of patients with catabolic disease. *Scand J Gastroenterol* 21:421-427.
- \*Turner RR, Lindberg SE, Coe JM. 1985. Comparative analysis of trace metal accumulation in forest ecosystems. 5th International Conference on Heavy Metals in the Environment 1:356-358.
- Tutterova M, Mosinger B, Vavrinkova H. 1988. Heart injury in the calcium paradox: The effect of manganese. *Biomed Biochim Acta* 47:57-64.
- \*Uchino A, Noguchi T, Nomiya K, et al. 2007. Manganese accumulation in the brain: MR imaging. *Neuroradiology* 49:715-720.
- \*Ulitzur S, Barak M. 1988. Detection of genotoxicity of metallic compounds by the bacterial bioluminescence test. *J Biol Chem* 2:95-99.
- +\*Ulrich CE, Rinehart W, Brandt M. 1979a. Evaluation of the chronic inhalation toxicity of a manganese oxide aerosol. III - Pulmonary function, electromyograms, limb tremor, and tissue manganese data. *Am Ind Hyg Assoc J* 40:349-353.
- +\*Ulrich CE, Rinehart W, Busey W. 1979b. Evaluation of the chronic inhalation toxicity of a manganese oxide aerosol. I. Introduction, experimental design, and aerosol generation methods. *Am Ind Hyg Assoc J* 40:238-244.
- +\*Ulrich CE, Rinehart W, Busey W, et al. 1979c. Evaluation of the chronic inhalation toxicity of a manganese oxide aerosol. II - Clinical observations, hematology, clinical chemistry and histopathology. *Am Ind Hyg Assoc J* 40:322-329.

## 9. REFERENCES

- \*Umeda M, Nishimura M. 1979. Inducibility of chromosomal aberrations by metal compounds in cultured mammalian cells. *Mutat Res* 67:221-229.
- Underwood EJ. 1971. Manganese. In: Trace elements in human and animal nutrition. 3rd ed. New York, NY: Academic Press, 177-203.
- Underwood EJ. 1981. The incidence of trace element deficiency diseases. *Phil Trans R Soc Lond B* 294:3-8.
- \*U.S. DHEW. 1970. Community water supply study. Analysis of national survey findings. Cincinnati, OH: U.S. Department of Health, Education, and Welfare, Bureau of Water Hygiene. NTIS No. PB-214982.
- U.S. DOT. 1996. U.S. Department of Transportation. 1996 North American emergency response guidebook.
- \*USGS. 1964. Public water supplies of the 100 largest cities in the United States, 1962. Washington, DC: U.S. Geological Survey. Water-supply paper 1812.
- USGS. 1998. Mineral industry surveys: Manganese: 1997 Annual review. U.S. Geological Survey, U.S. Department of the Interior.
- \*USGS. 2001. Manganese recycling in the United States in 1998. U.S. Geological Survey. Open file report 01-304. <http://pubs.usgs.gov/of/2001/of01-304/of01-304.pdf>. April 07, 2008.
- \*USGS. 2007. 2005 Minerals yearbook. Manganese. U.S. Geological Survey. <http://minerals.usgs.gov/minerals/pubs/commodity/manganese/mangamyb05.pdf>. April 07, 2008.
- \*USGS. 2008. Manganese. Mineral commodity summaries. U.S. Geological Survey, 104-105. <http://minerals.usgs.gov/minerals/pubs/commodity/manganese/mcs-2008-manga.pdf>. April 07, 2008.
- \*Utter MF. 1976. The biochemistry of manganese. *Med Clin North Am* 60:713-727.
- Vaccari A, Saba P, Mocchi I, et al. 1999. Dithiocarbamate pesticides affect glutamate transport in the brain synaptic vesicles. *J Pharmacol Exp Ther* 288:1-5.
- \*Vahlquist A, Rask L, Peterson PA, et al. 1975. The concentrations of retinol-binding protein, prealbumin, and transferrin in the sera of newly delivered mothers and children of various ages. *Scand J Clin Lab Invest* 35:369-375.
- \*Valencia R, Mason JM, Woodruff RC, et al. 1985. Chemical mutagenesis testing in *Drosophila*. III. Results of 48 coded compounds tested for the National Toxicology Program. *Environ Mutagen* 7:325-348.
- \*Valentin H, Schiele R. 1983. Manganese. In: Alessio L, et al. Human biological monitoring of industrial chemicals series. Luxembourg: Commission of the European Communities. EUR-8476-EN. NTIS No. PB86-217908.-gov doc
- +van der Elst L, Colet JM, Muller RN. 1997. Spectroscopic and metabolic effects of MnCl<sub>2</sub> and MnDPDP on the isolated and perfused rat heart. *Invest Radiol* 32:581-588.



## 9. REFERENCES

Vasudev V, Krishnamurthy NB. 1994. In vivo cytogenetic analyses of the carbamate pesticides Dithane M-45 and Baygon in mice. *Mutat Res* 323:133-135.

\*Venugopal B, Luckey TD. 1978. Toxicity of group VII metals. In: *Metal toxicity in mammals*. 2. Chemical toxicity of metals and metalloids. New York, NY: Plenum Press, 262-268.

\*Verity MA. 1999. Manganese toxicity: A mechanistic hypothesis. *Neurotoxicology* 20:489-498.

Verschoye RD, Wolf CR, Dinsdale D. 1993. Cytochrome P450 2B isoenzymes are responsible for the pulmonary bioactivation and toxicity of butylated hydroxytoluene, O,O,S-trimethylphosphorothioate and methylcyclopentadienyl manganese tricarbonyl. *J Pharmacol Exp Ther* 266(2):958-963.

Verschueren K. 1983. *Handbook of environmental data on organic chemicals*. 2nd ed. New York: Van Nostrand Reinhold Company, 806.

Versieck J, Cornelis R. 1980. Normal levels of trace elements in human blood plasma or serum. *Anal Chim Acta* 116:217-254.

\*Versieck J, Vanballenberghe L, De Kese A. 1988. More on determination of manganese in biological materials [Letter]. *Clin Chem* 34:1659-1660.

Versieck J, Vanballenberghe L, De Kesel A, et al. 1987. Accuracy of biological trace-element determination. *Biol Trace Elem Res* 12:45-54.

+Vescovi A, Gebbia M, Cappelletti G, et al. 1989. Interactions of manganese with human brain glutathione-S-transferase. *Toxicology* 57:183-191.

\*Veysseyre A, Vondevelde K, Ferrari C, Bourton C, et al. 1998. Searching for manganese pollution from MMT anti-knock gasoline additives in snow from central Greenland. *Sci Total Environ* 221:149-158.

+\*Vezér T, Kurunczi A, Naray M, et al. 2007. Behavioral effects of subchronic inorganic manganese exposure in rats. *Am J Ind Med* 50:841-852.

+\*Vezér T, Papp A, Hoyk Z, et al. 2005. Behavioral and neurotoxicological effects of subchronic manganese exposure in rats. *Environ Toxicol Pharmacol* 19:797-810.

Vidal L, Alfonso M, Campos F, et al. 2005. Effects of manganese on extracellular levels of dopamine in rat striatum: An analysis in vivo by brain microdialysis. *Neurochem Res* 30(9):1147-1154.

\*Vieira I, Sonnier M, Cresteil T. 1996. Developmental expression of CYP2E1 in the human liver: Hypermethylation control of gene expression during the neonatal period. *Eur J Biochem* 238(2):476-483.

+\*Vieregge P, Heinzow B, Korf G, et al. 1995. Long term exposure to manganese in rural well water has no neurological effects. *Can J Neurol Sci* 22:286-289.

Vigeh M, Yokoyama K, Ramezanzadeh F, et al. 2008. Blood manganese concentrations and intrauterine growth restriction. *Reprod Toxicol* 25:219-223.

## 9. REFERENCES

- +\*Vitarella D, Wong BA, Moss OR, et al. 2000. Pharmacokinetics of inhaled manganese phosphate in male Sprague-Dawley rats following subacute (14-day) exposure. *Toxicol Appl Pharmacol* 163:279-285.
- +\*Waalkes MP, Klaassen CD. 1985. Concentration of metallothionein in major organs of rats after administration of various metals. *Fundam Appl Toxicol* 5:473-477.
- Waddell J, Steenbock H, Hart EB. 1931. Growth and reproduction on milk diets. *J Nutr* 4:53-65.
- Wagner A, Boman J. 2003. Biomonitoring of trace elements in muscle and liver tissue of freshwater fish. *Spectrochim Acta, Part B* 58:2215-2226.
- Walash MI, Belal F, Metwally ME, et al. 1993. Spectrophotometric determination of maneb, zineb, and their decomposition products in some vegetables and its application to kinetic studies after greenhouse treatment. *Food Chem* 47:411-416.
- \*Wallace L, Slonecker T. 1997. Ambient air concentrations of fine (PM<sub>2.5</sub>) manganese in U.S. national parks and in California and Canadian cities: The possible impact of adding MMT to unleaded gasoline. *J Air Waste Manag Assoc* 47:642-652.
- \*Walton AP, Wei GT, Liang Z, et al. 1991. Laser-excited atomic fluorescence in a flame as a high-sensitivity detector for organomanganese and organotin compounds following separation by high-performance liquid chromatography. *Anal Chem* 63:232-240.
- +\*Wang C, Gordon PB, Hustvedt SO, et al. 1997. MR imaging properties and pharmacokinetics of MnDPDP in healthy volunteers. *Acta Radiologica* 38:665-676.
- \*Wang D, Du X, Zheng W. 2008. Alteration of saliva and serum concentrations of manganese, copper, zinc, cadmium and lead among career welders. *Toxicol Lett* 176:40-47.
- +Wang JD, Huang CC, Hwang YH, et al. 1989. Manganese induced Parkinsonism: An outbreak due to an unrepaired ventilation control system in a ferromanganese smelter. *Br J Ind Med* 46:856-859.
- Wang RG, Zhu XZ. 2003. Subtoxic concentration of manganese synergistically potentiates 1-methyl-4-phenylpyridinium-induced neurotoxicity in PC12 cells. *Brain Res* 961(1):131-138.
- Wang X, Yang Y, Wang X, et al. 2006. The effect of occupational exposure to metals on the nervous system function in welders. *J Occup Health* 48:100-106.
- \*Warner BB, Papes R, Heile M, et al. 1993. Expression of human MnSOD in Chinese hamster ovary cells confers protection from oxidant injury. *Am J Physiol* 264:L598-L605.
- +\*Wassermann D, Wassermann M. 1977. The ultra structure of the liver cell in subacute manganese administration. *Environ Res* 14:379-390.
- +\*Wasserman GA, Liu X, Parvez F, et al. 2006. Water manganese exposure and children's intellectual function in Araihasar, Bangladesh. *Environ Health Perspect* 114(1):124-129.
- Weast RC, ed. 1985. *CRC handbook of chemistry and physics*. Boca Raton, FL: CRC Press, Inc., B-112-B-114, B-214.

## 9. REFERENCES

- +\*Weber S, Dorman DC, Lash LH, et al. 2002. Effects of manganese (Mn) on the developing rat brain: Oxidative-stress related endpoints. *Neurotoxicology* 23(2):169-175.
- +Webster WS, Valois AA. 1987. Reproductive toxicology of manganese in rodents, including exposure during the postnatal period. *Neurotoxicology* 8:437-444.
- +\*Wedekind KJ, Titgemeyer EC, Twardock AR, et al. 1991. Phosphorus, but not calcium, affects manganese absorption and turnover in chicks. *J Nutr* 121:1776-1786.
- \*Wedler FC. 1994. Biochemical and nutritional role of manganese: An overview. In: Klimis-Tavantzis DJ, ed. *Manganese in health and disease*. Boca Raton, LA: CRC Press, 1-36.
- \*Weiner WJ, Nausieda PA, Klawans HL. 1977. Effect of chlorpromazine on central nervous system concentrations of manganese, iron, and copper. *Life Sci* 20:1181-1186.
- Weiss B. 1999. Manganese in the context of an integrated risk and decision process. *Neurotoxicology* 20:519-526.
- \*Weiss B. 2006. Economic implications of manganese neurotoxicity. *Neurotoxicology* 27:362-368.
- +Wennberg A, Hagman M, Johansson L. 1992. Preclinical neurophysiological signs of Parkinsonism in occupational manganese exposure. *Neurotoxicology* 13:271-274.
- +\*Wennberg A, Iregren A, Struwe G, et al. 1991. Manganese exposure in steel smelters a health hazard to the nervous system. *Scand J Work Environ Health* 17:255-262.
- Weppelman RM, Long RA, Van Iderstine A, et al. 1980. Antifertility effects of dithiocarbamates in laying hens. *Biol Reprod* 23:40-46.
- \*West JR, Smith HW, Chasis H. 1948. Glomerular filtration rate, effective renal blood flow, and maximal tubular excretory capacity in infancy. *J Pediatr* 32:10-18.
- +\*Whitlock CM, Amuso SJ, Bittenbender JB. 1966. Chronic neurological disease in two manganese steel workers. *Am Ind Hyg Assoc J* 27:454-459.
- \*WHO. 1973. Manganese. Trace elements in human nutrition. Report of a WHO committee. Geneva, Switzerland: World Health Organization, 34-36.
- \*WHO. 1981. Environmental health criteria 17: Manganese. World Health Organization, Geneva, Switzerland.
- \*WHO. 1984a. Guidelines for drinking water quality. Vol. 1. Recommendations. World Health Organization, Geneva, Switzerland, 7, 52, 79, 82.
- WHO. 1984b. Guidelines for drinking water quality. Vol. 2. Health criteria and other supporting information. World Health Organization, Geneva, Switzerland, 275-278.
- \*WHO. 1986. Diseases caused by manganese and its toxic compounds. Early detection of occupational diseases, World Health Organization, Geneva, Switzerland, 69-73.

## 9. REFERENCES

- \*WHO. 1987. Manganese. In: Air quality guidelines for Europe. European Series No. 23. Copenhagen, Denmark: World Health Organization Regional Office for Europe, 262-271.
- WHO. 1991. Manganese. Commission of the European Communities; International Programme on Chemical Safety (IPCS) World Health Organization, Geneva, Switzerland.
- \*WHO. 1999. Concise international chemical assessment document 12. Manganese and its compounds. Geneva: United Nations Environment Programme. International Labour Organisation. World Health Organization. <http://whqlibdoc.who.int/publications/1999/924153012X.pdf>. August 04, 2008.
- \*WHO. 2000a. Air quality guidelines. 2nd ed. Geneva, Switzerland: World Health Organization. <http://www.euro.who.int/Document/AIQ/AirQualRepMtg.pdf>. March 08, 2006.
- \*WHO. 2000b. Air quality guidelines for Europe. 2nd ed. World Health Organization. <http://www.euro.who.int/document/e71922.pdf>. August 02, 2008.
- \*WHO. 2001. Manganese. In: Air quality guidelines. 2nd ed. World Health Organization. [http://www.euro.who.int/document/aiq/6\\_8manganese.pdf](http://www.euro.who.int/document/aiq/6_8manganese.pdf). August 02, 2008.
- \*WHO. 2004a. Guidelines for drinking-water quality. Vol. 1. Recommendations. 3rd ed. Geneva, Switzerland: World Health Organization. [http://www.who.int/water\\_sanitation\\_health/dwq/gdwq3/en/](http://www.who.int/water_sanitation_health/dwq/gdwq3/en/). March 08, 2006.
- \*WHO. 2004b. Manganese in drinking-water. Background document for development of WHO guidelines for drinking-water quality. World Health Organization. WHO/SDE/WSH/03.04/104. [http://www.who.int/water\\_sanitation\\_health/dwq/chemicals/manganese.pdf](http://www.who.int/water_sanitation_health/dwq/chemicals/manganese.pdf). April 07, 2008.
- \*WHO/IPSC. 1999. Concise International Chemical Assessment Document 12: Manganese and its compounds. World Health Organization/Inter-Organization Programme for the Sound Management of Chemicals.
- \*Widdowson EM, Dickerson JWT. 1964. Chemical composition of the body. In: Comar CL, Bronner F, eds. Mineral metabolism: An advanced treatise. Volume II: The elements Part A. New York, NY: Academic Press, 1-247.
- +\*Widdowson EM, Chan H, Harrison GE, et al. 1972. Accumulation of Cu, Zn, Mn, Cr and Co in the human liver before birth. *Biol Neonate* 20:360-367.
- +\*Wieczorek H, Oberdörster G. 1989a. Effects of selected chelating agents on organ distribution and excretion of manganese after inhalation exposure to  $^{54}\text{MnCl}_2$ . I. Injection of chelating agents. *Pol J Occup Med* 2:261-267.
- +\*Wieczorek H, Oberdörster G. 1989b. Effects of chelating on organ distribution and excretion of manganese after inhalation exposure to  $^{54}\text{MnCl}_2$ . II: Inhalation of chelating agents. *Pol J Occup Med* 2:389-396.
- \*Wieczorek H, Oberdörster G. 1989c. Kinetics of inhaled  $^{54}\text{MnCl}_2$  aerosols: Influence of inhaled concentrations. *Polish J Occup Med* 2(3):248-260.
- \*Wilgus HS, Patton AR. 1939. Factors affecting manganese utilization in the chicken. *J Nutr* 18:35-45.

## 9. REFERENCES

- +\*Wilson DC, Tubman R, Bell N, et al. 1991. Plasma manganese, selenium and glutathione peroxidase levels in the mother and newborn infant. *Early Hum Dev* 26:223-226.
- \*Windholz M, ed. 1983. *The Merck index: An encyclopedia of chemicals, drugs and biologicals*. 10th ed. Rahway, NJ: Merck and Company, Inc., 816-818.
- Wirth JJ, Rossano MG, Daly DC, et al. 2007. Ambient manganese exposure is negatively associated with human sperm motility and concentration. *Epidemiology* 18(2):270-273.
- Wise K, Manna S, Barr J, et al. 2004. Activation of activator protein-1 DNA binding activity due to low level manganese exposure in pheochromocytoma cells. *Toxicol Lett* 147(3):237-244.
- Without R, Gwiazda RH, Smith DR. 2000. The neurobehavioral effects of subchronic manganese exposure in the presence and absence of pre-parkinsonism. *Neurotoxicol Teratol* 22:851-861.
- +\*Witschi HP, Hakkinen PJ, Kehrer JP. 1981. Modification of lung tumor development in A/J mice. *Toxicology* 21:37-45.
- Witzleben CL, Boyer JL, Ng OC. 1987. Manganese-bilirubin cholestasis. Further studies in pathogenesis. *Lab Invest* 56:151-154.
- +\*Wolters EC, Huang CC, Clark C, et al. 1989. Positron emission tomography in manganese intoxication. *Ann Neurol* 26:647-651.
- \*Wong GHW, Goeddel DV. 1988. Induction of manganous superoxide dismutase by tumor necrosis factor: possible protective mechanism. *Science* 242:941-944.
- \*Wong PK. 1988. Mutagenicity of heavy metals. *Bull Environ Contam Toxicol* 40:597-603.
- Wongwit W, Kaewkungwal J, Chantachum Y, et al. 2004. Comparison of biological specimens for manganese determination among highly exposed welders. *Southeast Asian J Trop Med Public Health* 35(3):764-769.
- Woodrow JE, Seiber JN, Fitzell D. 1995. Analytical method for the dithiocarbamate fungicides ziram and mancozeb in air: Preliminary field results. *J Agric Food Chem* 43:1524-1529.
- +\*Woolf A, Wright R, Amarasiriwardena C, et al. 2002. A child with chronic manganese exposure from drinking water. *Environ Health Perspect* 110:613-616.
- Worley CG, Bombick D, Allen JW, et al. 2002. Effects of manganese on oxidative stress in CATH.a cells. *Neurotoxicology* 23(2):159-164.
- \*Wright RO, Amarasiriwardena C, Woolf AD, et al. 2006. Neuropsychological correlates of hair arsenic, manganese, and cadmium levels in school-age children residing near a hazardous waste site. *Neurotoxicology* 27(2):210-216.
- +\*Wu W, Zhang Y, Zhang F, et al. 1996. [Studies on the semen quality in workers exposed to manganese and electric welding.] *Chin J Prev Med* 30:266-268. (Chinese)
- +\*Yamada M, Ohno S, Okayasu I, et al. 1986. Chronic manganese poisoning: A neuropathological study with determination of manganese distribution in the brain. *Acta Neuropathol (Berl)* 70:273-278.

## 9. REFERENCES

- Yang H, Sun Y, Zheng X. 2007. Manganese-induced apoptosis in rat myocytes. *J Biochem Mol Toxicol* 21(3):94-100.
- \*Yen HC, Oberley TD, Vichitbandha S, et al. 1996. The protective role of superoxide dismutase against adriamycin-induced cardiac toxicity in transgenic mice. *J Clin Invest* 98:1253-1260.
- +\*Yiin SJ, Lin TH, Shih TS. 1996. Lipid peroxidation in workers exposed to manganese. *Scand J Work Environ Health* 22:381-386.
- \*Yokel RA. 2002. Brain uptake, retention, and efflux of aluminum and manganese. *Environ Health Perspect Suppl* 110:699-704.
- Yokel RA, Crossgrove JS, Bukaveckas BL. 2003. Manganese distribution across the blood-brain barrier. II. Manganese efflux from the brain does not appear to be carrier mediated. *Neurotoxicology* 24(1):15-22.
- Yokel RA, Lasley SM, Dorman DC. 2006. The speciation of metals in mammals influences their toxicokinetics and toxicodynamics and therefore human health risk assessment. *J Toxicol Environ Health B Crit Rev* 9:63-85.
- +Yong VW, Perry TL, Godolphin WJ, et al. 1986. Chronic organic manganese administration in the rat does not damage dopaminergic nigrostriatal neurons. *Neurotoxicology* 7:19-24.
- Yoshikawa K, Matsumoto M, Hamanaka M, et al. 2003. A case of manganese induced parkinsonism in hereditary haemorrhagic telangiectasia. *J Neurol Neurosurg Psychiatry* 74(9):1312-1314.
- \*Young T, Myers JE, Thompson ML. 2005. The nervous system effects of occupational exposure to manganese--measured as respirable dust--in a South African manganese smelter. *Neurotoxicology* 26(6):993-1000.
- Yu IJ, Park JD, Park ES, et al. 2003. Manganese distribution in brains of Sprague-Dawley rats after 60 days of stainless steel welding-fume exposure. *Neurotoxicology* 24(6):777-785.
- +Zaidi SH, Dogra RK, Shanker R, et al. 1973. Experimental infective manganese pneumoconiosis in guinea pigs. *Environ Res* 6:287-297.
- \*Zakour RA, Glickman BW. 1984. Metal-induced mutagenesis in the lacI gene of Escherichia coli. *Mutat Res* 126:9-18.
- Zaprianov ZK, Tsalev DL, Gheorghieva RB, et al. 1985. New toxicokinetic exposure tests based on atomic absorption analysis of toenails. I. Manganese. *Proceedings of the 5th International Conference on Heavy Metals in the Environment* 2:95-97.
- Zavanella T, Arias E, Paces Zaffroni N. 1979. Preliminary study on the carcinogenic activity of the fungicide manganese ethylenebisdithiocarbamate in the adult newt, *Triturus cristatus carnifex*. *Tumori* 65:163-167.
- Zavanella T, Zaffaroni NP, Arias E. 1984. Abnormal limb regeneration in adult newts exposed to the fungicide Maneb 80: A histological study. *J Toxicol Environ Health* 13:735-745.

## 9. REFERENCES

- \*Zayed J, Gérin M, Loranger S, et al. 1994. Occupational and environmental exposure of garage workers and taxi drivers to airborne manganese arising from the use of methylcyclopentadienyl manganese tricarbonyl in unleaded gasoline. *Am Ind Hyg Assoc J* 55(1):53-58.
- Zayed J, Guessous A, Lambert J, et al. 2003. Estimation of annual Mn emissions from MMT source in the Canadian environment and the Mn pollution index in each province. *Sci Total Environ* 312:147-154.
- \*Zayed J, Mikhail M, Loranger S, et al. 1996. Exposure of taxi drivers and office workers to total respirable manganese in an urban environment. *Am Ind Hyg Assoc J* 57(4):376-380.
- \*Zayed J, Thibault C, Gareau L, et al. 1999a. Airborne manganese particulates and methylcyclopentadienyl manganese tricarbonyl (MMT) at selected outdoor sites in Montreal. *Neurotoxicology* 20:151-157.
- \*Zayed J, Vyskocil A, Kennedy G. 1999b. Environmental contamination and human exposure to manganese: Contribution of methylcyclopentadienyl manganese tricarbonyl in unleaded gasoline. *Int Arch Occup Environ Health* 72(1):7-13.
- +\*Zhang G, Liu D, He P. 1995. [Effects of manganese on learning abilities in school children.] *Chung Hua Yu Fang I Hsueh Tsa Chih* 29:156-158.
- Zhang P, Hatter A, Liu B. 2007. Manganese chloride stimulates rat microglia to release hydrogen peroxide. *Toxicol Lett* 173(2):88-100.
- Zhang S, Fu J, Zhou Z. 2004. In vitro effect of manganese chloride exposure on reactive oxygen species generation and respiratory chain complexes activities of mitochondria isolated from rat brain. *Toxicol In Vitro* 18(1):71-77.
- Zhang S, Zhou Z, Fu J. 2003a. Effect of manganese chloride exposure on liver and brain mitochondria function in rats. *Environ Res* 93(2):149-157.
- Zhang J, Fitsanakis VA, Gu G, et al. 2003b. Manganese ethylene-bis-dithiocarbamate and selective dopaminergic neurodegeneration in rat: A link through mitochondrial dysfunction. *J Neurochem* 84(2):336-346.
- \*Zheng W, Kim H, Zhao Q. 2000. Comparative toxicokinetics of manganese chloride and methylcyclopentadienyl manganese tricarbonyl (MMT) in Sprague-Dawley rats. *Toxicol Sci* 54:295-301.
- +\*Zheng W, Ren S, Graziano JH. 1998. Manganese inhibits mitochondrial aconitase: A mechanism of manganese neurotoxicity. *Brain Res* 799:334-342.
- Zheng W, Zhao Q, Slavkovich V, et al. 1999. Alteration of iron homeostasis following chronic exposure to manganese in rats. *Brain Res* 833:125-132.
- Zidenberg-Cherr S, Hurley LS, Lönnerdal B, et al. 1985. Manganese deficiency: Effects on susceptibility to ethanol toxicity in rats. *J Nutr* 115:460-467.
- \*Ziegler EE, Edwards BB, Jensen RL, et al. 1978. Absorption and retention of lead by infants. *Pediatr Res* 12(1):29-34.

## 9. REFERENCES

- Zielhuis RL, del Castillo P, Herber RF, et al. 1978. Levels of lead and other metals in human blood: Suggestive relationships, determining factors. *Environ Health Perspect* 25:103-109.
- Zielinski WL, Fishbein L. 1966. Gas chromatography of metallic derivatives of ethylenebis (dithiocarbamic acids). *J Chromatogr* 23:302-304.
- +\*Zlotkin SH, Buchanan BE. 1986. Manganese intakes in intravenously fed infants: Dosages and toxicity studies. *Biol Trace Element Res* 9:271-279.
- Zoni S, Albini E, Lucchini R. 2007. Neuropsychological testing for the assessment of manganese neurotoxicity: A review and a proposal. *Am J Ind Med* 50:812-830.
- Zwingmann C, Leibfritz D, Hazell AS. 2003. Energy metabolism in astrocytes and neurons treated with manganese: Relation among cell-specific energy failure, glucose metabolism, and intercellular trafficking using multinuclear NMR-spectroscopic analysis. *J Cereb Blood Flow Metab* 23(6):756-771.
- \*Zwingmann C, Leibfritz D, Hazell AS. 2004. Brain energy metabolism in a sub-acute rat model of manganese neurotoxicity: An ex vivo nuclear magnetic resonance study using [1-13C]glucose. *Neurotoxicology* 25(4):573-587.
- \*Zwingmann C, Leibfritz D, Hazell AS. 2007. NMR spectroscopic analysis of regional brain energy metabolism in manganese neurotoxicity. *Glia* 55(15):1610-1617.



## 10. GLOSSARY

**Absorption**—The taking up of liquids by solids, or of gases by solids or liquids.

**Acute Exposure**—Exposure to a chemical for a duration of 14 days or less, as specified in the Toxicological Profiles.

**Adsorption**—The adhesion in an extremely thin layer of molecules (as of gases, solutes, or liquids) to the surfaces of solid bodies or liquids with which they are in contact.

**Adsorption Coefficient ( $K_{oc}$ )**—The ratio of the amount of a chemical adsorbed per unit weight of organic carbon in the soil or sediment to the concentration of the chemical in solution at equilibrium.

**Adsorption Ratio ( $K_d$ )**—The amount of a chemical adsorbed by sediment or soil (i.e., the solid phase) divided by the amount of chemical in the solution phase, which is in equilibrium with the solid phase, at a fixed solid/solution ratio. It is generally expressed in micrograms of chemical sorbed per gram of soil or sediment.

**Benchmark Dose (BMD)**—Usually defined as the lower confidence limit on the dose that produces a specified magnitude of changes in a specified adverse response. For example, a  $BMD_{10}$  would be the dose at the 95% lower confidence limit on a 10% response, and the benchmark response (BMR) would be 10%. The BMD is determined by modeling the dose response curve in the region of the dose response relationship where biologically observable data are feasible.

**Benchmark Dose Model**—A statistical dose-response model applied to either experimental toxicological or epidemiological data to calculate a BMD.

**Bioconcentration Factor (BCF)**—The quotient of the concentration of a chemical in aquatic organisms at a specific time or during a discrete time period of exposure divided by the concentration in the surrounding water at the same time or during the same period.

**Biomarkers**—Broadly defined as indicators signaling events in biologic systems or samples. They have been classified as markers of exposure, markers of effect, and markers of susceptibility.

**Cancer Effect Level (CEL)**—The lowest dose of chemical in a study, or group of studies, that produces significant increases in the incidence of cancer (or tumors) between the exposed population and its appropriate control.

**Carcinogen**—A chemical capable of inducing cancer.

**Case-Control Study**—A type of epidemiological study that examines the relationship between a particular outcome (disease or condition) and a variety of potential causative agents (such as toxic chemicals). In a case-controlled study, a group of people with a specified and well-defined outcome is identified and compared to a similar group of people without outcome.

**Case Report**—Describes a single individual with a particular disease or exposure. These may suggest some potential topics for scientific research, but are not actual research studies.

**Case Series**—Describes the experience of a small number of individuals with the same disease or exposure. These may suggest potential topics for scientific research, but are not actual research studies.

## 10. GLOSSARY

**Ceiling Value**—A concentration of a substance that should not be exceeded, even instantaneously.

**Chronic Exposure**—Exposure to a chemical for 365 days or more, as specified in the Toxicological Profiles.

**Cohort Study**—A type of epidemiological study of a specific group or groups of people who have had a common insult (e.g., exposure to an agent suspected of causing disease or a common disease) and are followed forward from exposure to outcome. At least one exposed group is compared to one unexposed group.

**Cross-sectional Study**—A type of epidemiological study of a group or groups of people that examines the relationship between exposure and outcome to a chemical or to chemicals at one point in time.

**Data Needs**—Substance-specific informational needs that if met would reduce the uncertainties of human health assessment.

**Developmental Toxicity**—The occurrence of adverse effects on the developing organism that may result from exposure to a chemical prior to conception (either parent), during prenatal development, or postnatally to the time of sexual maturation. Adverse developmental effects may be detected at any point in the life span of the organism.

**Dose-Response Relationship**—The quantitative relationship between the amount of exposure to a toxicant and the incidence of the adverse effects.

**Embryotoxicity and Fetotoxicity**—Any toxic effect on the conceptus as a result of prenatal exposure to a chemical; the distinguishing feature between the two terms is the stage of development during which the insult occurs. The terms, as used here, include malformations and variations, altered growth, and *in utero* death.

**Environmental Protection Agency (EPA) Health Advisory**—An estimate of acceptable drinking water levels for a chemical substance based on health effects information. A health advisory is not a legally enforceable federal standard, but serves as technical guidance to assist federal, state, and local officials.

**Epidemiology**—Refers to the investigation of factors that determine the frequency and distribution of disease or other health-related conditions within a defined human population during a specified period.

**Genotoxicity**—A specific adverse effect on the genome of living cells that, upon the duplication of affected cells, can be expressed as a mutagenic, clastogenic, or carcinogenic event because of specific alteration of the molecular structure of the genome.

**Half-life**—A measure of rate for the time required to eliminate one half of a quantity of a chemical from the body or environmental media.

**Immediately Dangerous to Life or Health (IDLH)**—The maximum environmental concentration of a contaminant from which one could escape within 30 minutes without any escape-impairing symptoms or irreversible health effects.

**Immunologic Toxicity**—The occurrence of adverse effects on the immune system that may result from exposure to environmental agents such as chemicals.

**Immunological Effects**—Functional changes in the immune response.

## 10. GLOSSARY

**Incidence**—The ratio of individuals in a population who develop a specified condition to the total number of individuals in that population who could have developed that condition in a specified time period.

**Intermediate Exposure**—Exposure to a chemical for a duration of 15–364 days, as specified in the Toxicological Profiles.

**In Vitro**—Isolated from the living organism and artificially maintained, as in a test tube.

**In Vivo**—Occurring within the living organism.

**Lethal Concentration<sub>(LO)</sub> (LC<sub>LO</sub>)**—The lowest concentration of a chemical in air that has been reported to have caused death in humans or animals.

**Lethal Concentration<sub>(50)</sub> (LC<sub>50</sub>)**—A calculated concentration of a chemical in air to which exposure for a specific length of time is expected to cause death in 50% of a defined experimental animal population.

**Lethal Dose<sub>(LO)</sub> (LD<sub>LO</sub>)**—The lowest dose of a chemical introduced by a route other than inhalation that has been reported to have caused death in humans or animals.

**Lethal Dose<sub>(50)</sub> (LD<sub>50</sub>)**—The dose of a chemical that has been calculated to cause death in 50% of a defined experimental animal population.

**Lethal Time<sub>(50)</sub> (LT<sub>50</sub>)**—A calculated period of time within which a specific concentration of a chemical is expected to cause death in 50% of a defined experimental animal population.

**Lowest-Observed-Adverse-Effect Level (LOAEL)**—The lowest exposure level of chemical in a study, or group of studies, that produces statistically or biologically significant increases in frequency or severity of adverse effects between the exposed population and its appropriate control.

**Lymphoreticular Effects**—Represent morphological effects involving lymphatic tissues such as the lymph nodes, spleen, and thymus.

**Malformations**—Permanent structural changes that may adversely affect survival, development, or function.

**Minimal Risk Level (MRL)**—An estimate of daily human exposure to a hazardous substance that is likely to be without an appreciable risk of adverse noncancer health effects over a specified route and duration of exposure.

**Modifying Factor (MF)**—A value (greater than zero) that is applied to the derivation of a Minimal Risk Level (MRL) to reflect additional concerns about the database that are not covered by the uncertainty factors. The default value for a MF is 1.

**Morbidity**—State of being diseased; morbidity rate is the incidence or prevalence of disease in a specific population.

**Mortality**—Death; mortality rate is a measure of the number of deaths in a population during a specified interval of time.

## 10. GLOSSARY

**Mutagen**—A substance that causes mutations. A mutation is a change in the DNA sequence of a cell's DNA. Mutations can lead to birth defects, miscarriages, or cancer.

**Necropsy**—The gross examination of the organs and tissues of a dead body to determine the cause of death or pathological conditions.

**Neurotoxicity**—The occurrence of adverse effects on the nervous system following exposure to a chemical.

**No-Observed-Adverse-Effect Level (NOAEL)**—The dose of a chemical at which there were no statistically or biologically significant increases in frequency or severity of adverse effects seen between the exposed population and its appropriate control. Effects may be produced at this dose, but they are not considered to be adverse.

**Octanol-Water Partition Coefficient ( $K_{ow}$ )**—The equilibrium ratio of the concentrations of a chemical in *n*-octanol and water, in dilute solution.

**Odds Ratio (OR)**—A means of measuring the association between an exposure (such as toxic substances and a disease or condition) that represents the best estimate of relative risk (risk as a ratio of the incidence among subjects exposed to a particular risk factor divided by the incidence among subjects who were not exposed to the risk factor). An OR of greater than 1 is considered to indicate greater risk of disease in the exposed group compared to the unexposed group.

**Organophosphate or Organophosphorus Compound**—A phosphorus-containing organic compound and especially a pesticide that acts by inhibiting cholinesterase.

**Permissible Exposure Limit (PEL)**—An Occupational Safety and Health Administration (OSHA) allowable exposure level in workplace air averaged over an 8-hour shift of a 40-hour workweek.

**Pesticide**—General classification of chemicals specifically developed and produced for use in the control of agricultural and public health pests.

**Pharmacokinetics**—The dynamic behavior of a material in the body, used to predict the fate (disposition) of an exogenous substance in an organism. Utilizing computational techniques, it provides the means of studying the absorption, distribution, metabolism, and excretion of chemicals by the body.

**Pharmacokinetic Model**—A set of equations that can be used to describe the time course of a parent chemical or metabolite in an animal system. There are two types of pharmacokinetic models: data-based and physiologically-based. A data-based model divides the animal system into a series of compartments, which, in general, do not represent real, identifiable anatomic regions of the body, whereas the physiologically-based model compartments represent real anatomic regions of the body.

**Physiologically Based Pharmacodynamic (PBPD) Model**—A type of physiologically based dose-response model that quantitatively describes the relationship between target tissue dose and toxic end points. These models advance the importance of physiologically based models in that they clearly describe the biological effect (response) produced by the system following exposure to an exogenous substance.

## 10. GLOSSARY

**Physiologically Based Pharmacokinetic (PBPK) Model**—Comprised of a series of compartments representing organs or tissue groups with realistic weights and blood flows. These models require a variety of physiological information: tissue volumes, blood flow rates to tissues, cardiac output, alveolar ventilation rates, and possibly membrane permeabilities. The models also utilize biochemical information, such as air/blood partition coefficients, and metabolic parameters. PBPK models are also called biologically based tissue dosimetry models.

**Prevalence**—The number of cases of a disease or condition in a population at one point in time.

**Prospective Study**—A type of cohort study in which the pertinent observations are made on events occurring after the start of the study. A group is followed over time.

**$q_1^*$** —The upper-bound estimate of the low-dose slope of the dose-response curve as determined by the multistage procedure. The  $q_1^*$  can be used to calculate an estimate of carcinogenic potency, the incremental excess cancer risk per unit of exposure (usually  $\mu\text{g/L}$  for water,  $\text{mg/kg/day}$  for food, and  $\mu\text{g/m}^3$  for air).

**Recommended Exposure Limit (REL)**—A National Institute for Occupational Safety and Health (NIOSH) time-weighted average (TWA) concentration for up to a 10-hour workday during a 40-hour workweek.

**Reference Concentration (RfC)**—An estimate (with uncertainty spanning perhaps an order of magnitude) of a continuous inhalation exposure to the human population (including sensitive subgroups) that is likely to be without an appreciable risk of deleterious noncancer health effects during a lifetime. The inhalation reference concentration is for continuous inhalation exposures and is appropriately expressed in units of  $\text{mg/m}^3$  or ppm.

**Reference Dose (RfD)**—An estimate (with uncertainty spanning perhaps an order of magnitude) of the daily exposure of the human population to a potential hazard that is likely to be without risk of deleterious effects during a lifetime. The RfD is operationally derived from the no-observed-adverse-effect level (NOAEL, from animal and human studies) by a consistent application of uncertainty factors that reflect various types of data used to estimate RfDs and an additional modifying factor, which is based on a professional judgment of the entire database on the chemical. The RfDs are not applicable to nonthreshold effects such as cancer.

**Reportable Quantity (RQ)**—The quantity of a hazardous substance that is considered reportable under the Comprehensive Environmental Response, Compensation, and Liability Act (CERCLA). Reportable quantities are (1) 1 pound or greater or (2) for selected substances, an amount established by regulation either under CERCLA or under Section 311 of the Clean Water Act. Quantities are measured over a 24-hour period.

**Reproductive Toxicity**—The occurrence of adverse effects on the reproductive system that may result from exposure to a chemical. The toxicity may be directed to the reproductive organs and/or the related endocrine system. The manifestation of such toxicity may be noted as alterations in sexual behavior, fertility, pregnancy outcomes, or modifications in other functions that are dependent on the integrity of this system.

**Retrospective Study**—A type of cohort study based on a group of persons known to have been exposed at some time in the past. Data are collected from routinely recorded events, up to the time the study is undertaken. Retrospective studies are limited to causal factors that can be ascertained from existing records and/or examining survivors of the cohort.

## 10. GLOSSARY

**Risk**—The possibility or chance that some adverse effect will result from a given exposure to a chemical.

**Risk Factor**—An aspect of personal behavior or lifestyle, an environmental exposure, or an inborn or inherited characteristic that is associated with an increased occurrence of disease or other health-related event or condition.

**Risk Ratio**—The ratio of the risk among persons with specific risk factors compared to the risk among persons without risk factors. A risk ratio greater than 1 indicates greater risk of disease in the exposed group compared to the unexposed group.

**Short-Term Exposure Limit (STEL)**—The American Conference of Governmental Industrial Hygienists (ACGIH) maximum concentration to which workers can be exposed for up to 15 minutes continually. No more than four excursions are allowed per day, and there must be at least 60 minutes between exposure periods. The daily Threshold Limit Value-Time Weighted Average (TLV-TWA) may not be exceeded.

**Standardized Mortality Ratio (SMR)**—A ratio of the observed number of deaths and the expected number of deaths in a specific standard population.

**Target Organ Toxicity**—This term covers a broad range of adverse effects on target organs or physiological systems (e.g., renal, cardiovascular) extending from those arising through a single limited exposure to those assumed over a lifetime of exposure to a chemical.

**Teratogen**—A chemical that causes structural defects that affect the development of an organism.

**Threshold Limit Value (TLV)**—An American Conference of Governmental Industrial Hygienists (ACGIH) concentration of a substance to which most workers can be exposed without adverse effect. The TLV may be expressed as a Time Weighted Average (TWA), as a Short-Term Exposure Limit (STEL), or as a ceiling limit (CL).

**Time-Weighted Average (TWA)**—An allowable exposure concentration averaged over a normal 8-hour workday or 40-hour workweek.

**Toxic Dose<sub>(50)</sub> (TD<sub>50</sub>)**—A calculated dose of a chemical, introduced by a route other than inhalation, which is expected to cause a specific toxic effect in 50% of a defined experimental animal population.

**Toxicokinetic**—The absorption, distribution, and elimination of toxic compounds in the living organism.

**Uncertainty Factor (UF)**—A factor used in operationally deriving the Minimal Risk Level (MRL) or Reference Dose (RfD) or Reference Concentration (RfC) from experimental data. UFs are intended to account for (1) the variation in sensitivity among the members of the human population, (2) the uncertainty in extrapolating animal data to the case of human, (3) the uncertainty in extrapolating from data obtained in a study that is of less than lifetime exposure, and (4) the uncertainty in using lowest-observed-adverse-effect level (LOAEL) data rather than no-observed-adverse-effect level (NOAEL) data. A default for each individual UF is 10; if complete certainty in data exists, a value of 1 can be used; however, a reduced UF of 3 may be used on a case-by-case basis, 3 being the approximate logarithmic average of 10 and 1.

**Xenobiotic**—Any chemical that is foreign to the biological system.

## APPENDIX A. ATSDR MINIMAL RISK LEVELS AND WORKSHEETS

The Comprehensive Environmental Response, Compensation, and Liability Act (CERCLA) [42 U.S.C. 9601 et seq.], as amended by the Superfund Amendments and Reauthorization Act (SARA) [Pub. L. 99–499], requires that the Agency for Toxic Substances and Disease Registry (ATSDR) develop jointly with the U.S. Environmental Protection Agency (EPA), in order of priority, a list of hazardous substances most commonly found at facilities on the CERCLA National Priorities List (NPL); prepare toxicological profiles for each substance included on the priority list of hazardous substances; and assure the initiation of a research program to fill identified data needs associated with the substances.

The toxicological profiles include an examination, summary, and interpretation of available toxicological information and epidemiologic evaluations of a hazardous substance. During the development of toxicological profiles, Minimal Risk Levels (MRLs) are derived when reliable and sufficient data exist to identify the target organ(s) of effect or the most sensitive health effect(s) for a specific duration for a given route of exposure. An MRL is an estimate of the daily human exposure to a hazardous substance that is likely to be without appreciable risk of adverse noncancer health effects over a specified duration of exposure. MRLs are based on noncancer health effects only and are not based on a consideration of cancer effects. These substance-specific estimates, which are intended to serve as screening levels, are used by ATSDR health assessors to identify contaminants and potential health effects that may be of concern at hazardous waste sites. It is important to note that MRLs are not intended to define clean-up or action levels.

MRLs are derived for hazardous substances using the no-observed-adverse-effect level/uncertainty factor approach. They are below levels that might cause adverse health effects in the people most sensitive to such chemical-induced effects. MRLs are derived for acute (1–14 days), intermediate (15–364 days), and chronic (365 days and longer) durations and for the oral and inhalation routes of exposure. Currently, MRLs for the dermal route of exposure are not derived because ATSDR has not yet identified a method suitable for this route of exposure. MRLs are generally based on the most sensitive chemical-induced end point considered to be of relevance to humans. Serious health effects (such as irreparable damage to the liver or kidneys, or birth defects) are not used as a basis for establishing MRLs. Exposure to a level above the MRL does not mean that adverse health effects will occur.

MRLs are intended only to serve as a screening tool to help public health professionals decide where to look more closely. They may also be viewed as a mechanism to identify those hazardous waste sites that

## APPENDIX A

are not expected to cause adverse health effects. Most MRLs contain a degree of uncertainty because of the lack of precise toxicological information on the people who might be most sensitive (e.g., infants, elderly, nutritionally or immunologically compromised) to the effects of hazardous substances. ATSDR uses a conservative (i.e., protective) approach to address this uncertainty consistent with the public health principle of prevention. Although human data are preferred, MRLs often must be based on animal studies because relevant human studies are lacking. In the absence of evidence to the contrary, ATSDR assumes that humans are more sensitive to the effects of hazardous substance than animals and that certain persons may be particularly sensitive. Thus, the resulting MRL may be as much as 100-fold below levels that have been shown to be nontoxic in laboratory animals.

Proposed MRLs undergo a rigorous review process: Health Effects/MRL Workgroup reviews within the Division of Toxicology and Environmental Medicine, expert panel peer reviews, and agency-wide MRL Workgroup reviews, with participation from other federal agencies and comments from the public. They are subject to change as new information becomes available concomitant with updating the toxicological profiles. Thus, MRLs in the most recent toxicological profiles supersede previously published levels. For additional information regarding MRLs, please contact the Division of Toxicology and Environmental Medicine, Agency for Toxic Substances and Disease Registry, 1600 Clifton Road NE, Mailstop F-32, Atlanta, Georgia 30333.



## APPENDIX A

**MINIMAL RISK LEVEL (MRL) WORKSHEET**

Chemical Name: Manganese  
CAS Number: 7439-96-5  
Date: August 8, 2008  
Profile Status: Draft 3, Pre-Public  
Route:  Inhalation  Oral  
Duration:  Acute  Intermediate  Chronic  
Graph Key:  
Species: Human

Minimal Risk Level: 0.0003 mg respirable manganese/m<sup>3</sup> (0.3 µg/m<sup>3</sup>)

Reference: Roels HA, Ghyselen P, Buchet JP, et al. 1992. Assessment of the permissible exposure level to manganese in workers exposed to manganese dioxide dust. Br J Ind Med 49:25-34.

Experimental design: Neurological effects of manganese exposure were evaluated in 92 male workers in a dry alkaline battery factory. The control group was 101 age- and area-matched workers not occupationally exposed to manganese but with similar work schedules and workloads. Workers were exposed for an average duration of 5.3 years (range 0.2–17.7 years) to average (geometric mean) concentrations of 0.215 and 0.948 mg manganese/m<sup>3</sup> in respirable and total dust, respectively. The authors noted that the work processes had not changed significantly in the last 15 years, indicating that past exposures should be comparable to those measured in the study. Neurological function was measured using an audioverbal short term memory test, a simple visual reaction time test using a chronoscope, and three manual tests of hand steadiness, coordination, and dexterity. This report provided good documentation of individual exposure data and characterization of the population studied.

Effects noted in study and corresponding doses: Manganese-exposed workers performed significantly worse than the controls on the neurobehavioral tests, with particular differences in simple reaction time, eye-hand coordination, and hand steadiness. Dr. Harry Roels provided the data on the manganese-exposed group evaluated in this study. These data included individual exposure levels and whether the individual had an abnormal performance in the neurobehavioral tests (scores below the 5<sup>th</sup> percentile score of the control group). Percent precision score in the eye-hand coordination test was the most sensitive end point among the end points showing statistically significantly elevated incidences of abnormal scores and was selected as the basis of the MRL. Average exposure concentration for each worker was calculated by dividing the individual lifetime integrated respirable concentration (LIRD; calculated by Dr. Roels from occupational histories and measurements of workplace air manganese concentrations) by the individual's total number of years working in the factory. Individuals were grouped into eight exposed groups and the control group, and the average of the range in each group was used in benchmark modeling of the incidence data for number of workers with abnormal percent precision eye-hand coordination scores (Table A-1).

## APPENDIX A

**Table A-1. Incidence Data for Abnormal Eye-Hand Coordination Scores in Workers Exposed to Respirable Manganese<sup>a</sup>**

| Group <sup>b</sup> | Range of manganese (respirable) exposure concentrations <sup>c</sup> (µg/m <sup>3</sup> ) | Average manganese (respirable) exposure concentration (µg/m <sup>3</sup> ) | Number of workers with abnormal eye-hand coordination score <sup>d</sup> | Total number of workers |
|--------------------|---|--|--|-------------------------|
| 1                  | Control   | 0  | 5  | 101                     |
| 2                  | 1.0–99  | 33   | 1  | 7                       |
| 3                  | 100–174   | 160  | 3  | 11                      |
| 4                  | 175–199   | 179  | 3  | 28                      |
| 5                  | 200–249   | 208  | 3  | 22                      |
| 6                  | 250–299   | 280  | 1  | 6                       |
| 7                  | 300–399   | 307  | 2  | 3                       |
| 8                  | 400–499   | 451  | 4  | 9                       |
| 9                  | >500 (523–650)  | 564  | 4  | 6                       |

<sup>a</sup>Based on individual exposure and dichotomized response data collected by Roels et al. (1992).

<sup>b</sup>Individuals were sorted into 9 groups, based on manganese exposure, for use in benchmark dose modeling

<sup>c</sup>For each individual, the time-weighted average exposure concentration (respirable manganese) was calculated by dividing the individual lifetime integrated respirable concentrations (LIRD) by the individual's respective total number of years exposed.

<sup>d</sup>An abnormal eye-hand coordination score was defined by Roels as a score below the 5<sup>th</sup> percentile score in the control group for percent precision (52.4) in the eye-hand coordination test.

Available dichotomous models in the EPA Benchmark Dose Software (version 1.4.1c) were fit to the incidence data for abnormal eye-hand coordination scores in workers exposed to respirable manganese (Roels et al. 1992, Table A-1). Results from the modeling are shown in Table A-2, including: (1) the BMC<sub>10</sub> and the 95% lower confidence limit (BMCL<sub>10</sub>) calculated as an estimate of the concentration associated with a 10% extra risk for an abnormal score; (2) BMC<sub>05</sub> and BMCL<sub>05</sub> values; (3) the p-value for the chi-square goodness of fit statistic (adequate fit,  $p > 0.1$ ); and (4) Akaike's Information Criteria (AIC) [lower AIC indicates better fit when comparing models, EPA (2000)]. Based on the chi-square and AIC measures of fit, all of the models provided adequate and comparable fits to the data (the quantal linear and Weibull models had the same parameter values). The model with the lowest AIC, the logistic model, was selected as the best fitting model (Table A-2), and the BMCL<sub>10</sub> from the logistic model, 142 µg/m<sup>3</sup>, was selected as the point of departure for the chronic inhalation MRL. Figure A-1 plots predicted risks for abnormal scores from the logistic model and observed incidence values calculated from data in Table A-1.

## APPENDIX A

**Table A-2. Modeling Results for Incidences of Abnormal Eye-Hand Coordination Scores in Workers Exposed to Respirable Manganese**

| Model                     | BMC <sub>10</sub><br>( $\mu\text{g}/\text{m}^3$ ) | BMCL <sub>10</sub><br>( $\mu\text{g}/\text{m}^3$ ) | BMC <sub>05</sub><br>( $\mu\text{g}/\text{m}^3$ ) | BMCL <sub>05</sub><br>( $\mu\text{g}/\text{m}^3$ ) | $\chi^2$ p-value | AIC    |
|---------------------------|---|--|---|--|------------------|--------|
| Gamma <sup>a</sup>        | 183.82  | 87.00  | 132.27  | 42.36  | 0.42             | 135.47 |
| Logistic                  | 179.80  | 142.61   | 109.29  | 84.14  | 0.58             | 133.15 |
| Log-logistic <sup>b</sup> | 185.53  | 91.70  | 134.25  | 43.83  | 0.42             | 135.48 |
| Multi-stage <sup>c</sup>  | 110.67  | 73.28  | 53.88   | 35.67  | 0.42             | 135.33 |
| Probit                    | 166.66  | 131.67   | 98.75   | 76.14  | 0.59             | 133.19 |
| Log-probit <sup>b</sup>   | 187.21  | 122.99   | 143.17  | 85.52  | 0.39             | 135.63 |
| Quantal linear            | 181.91  | 88.19  | 125.38  | 42.93  | 0.43             | 135.37 |
| Weibull <sup>a</sup>      | 181.91  | 88.19  | 125.38  | 42.93  | 0.43             | 135.37 |

<sup>a</sup>Restrict power  $\geq 1$ <sup>b</sup>Slope restricted to  $> 1$ <sup>c</sup>Restrict betas  $\geq 0$ ; lowest degree polynomial with an adequate fit is reported; degree of polynomial=1

Source: Roels et al. 1992

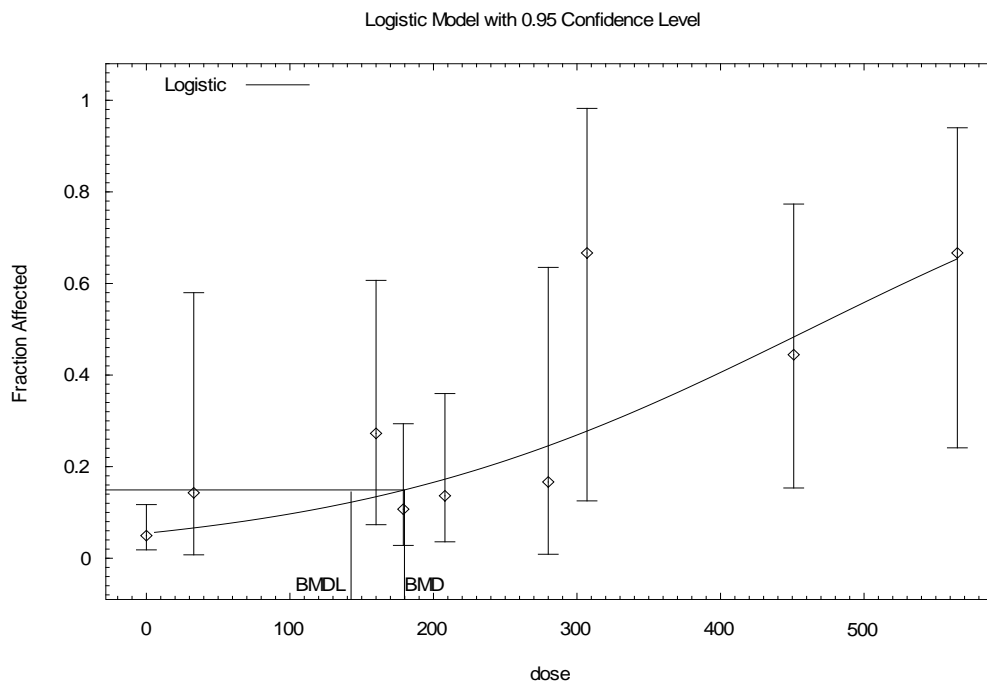
**Figure A-1. Predicted (Logistic Model) and Observed Incidence of Abnormal Eye-Hand Coordination Scores in Workers Exposed to Respirable Manganese (Roels et al. 1992)\***

\*BMD=BMC, BMDL=BMCL; BMDs and BMDLs indicated are associated with a 10% extra risk change from the control, and are in units of  $\mu\text{g}/\text{m}^3$ .

## APPENDIX A

Dose and end point used for MRL derivation:

NOAEL  LOAEL  Other BMCL<sub>10</sub>

Uncertainty and modifying factors used in MRL derivation:

- 10 for the use of a LOAEL
- 10 for extrapolation from animals to humans
- 10 for human variability including possibly enhanced susceptibility of the elderly, infants, and children; individuals with chronic liver disease or parenteral nutrition; and females and individuals with iron deficiency.
- 10 for limitations/uncertainties in the database including the lack of epidemiological data for humans chronically exposed to soluble forms of manganese and the concern that the general population may be exposed to more soluble forms of manganese than most of the manganese-exposed workers in the principal and supporting studies and the uncertainty that a factor of 10 for human variability will provide enough protection for manganese effects on brain development in children. In addition, data on developmental toxicity for this route and duration of exposure are lacking. There is limited information on reproductive effects in females (one study in rat dams) and reported effects on male reproductive organs have not been clearly associated with decreased reproductive function. Though it is clear that the neurological system is the target organ for effects from chronic-duration inhalation exposure to manganese, data are lacking to fully characterize the potential risk for all organ systems from chronic inhalation exposure.

Was a conversion used from ppm in food or water to a mg/body weight dose? No.

If an inhalation study in animals, list the conversion factors used in determining human equivalent dose:  
Not applicable.

Was a conversion used from intermittent to continuous exposure?

- 5/7 to account for intermittent exposure (5 days/week)
- 8/24 to account for intermittent exposure (8 hours/day)

MRL = 0.1426 mg manganese/m<sup>3</sup> x 5d/7d x 8h/24h x 1/100 = 0.0003 mg manganese/m<sup>3</sup> = 0.3 µg manganese/m<sup>3</sup>.

Other additional studies or pertinent information that lend support to this MRL: An alternative approach to selecting a point of departure (averaging BMCL<sub>10</sub> values across all models in Table A-2) arrived at a similar point of departure of 105 µg respirable manganese/m<sup>3</sup>, which would yield an identical MRL value.

Neurological effects from repeated inhalation exposure to manganese are well recognized as effects of high concern based on case reports and epidemiological studies of groups of occupationally exposed people and results from animal inhalation studies. A number of epidemiological studies have used batteries of neurobehavioral tests of neuromotor, cognition, and mood states to study the psychological or neurological effects of exposure to low levels of manganese in the workplace (Bast-Pettersen et al. 2004; Beuter et al. 1999; Blond and Netterstrom 2007; Blond et al. 2007; Bouchard et al. 2003, 2005, 2007a, 2007b; Chia et al. 1993a, 1995; Crump and Rousseau 1999; Deschamps et al. 2001; Gibbs et al. 1999; Iregren 1990; Lucchini et al. 1995, 1999; Mergler et al. 1994; Myers et al. 2003a, 2003b; Roels et al. 1987a, 1992, 1999; Wennberg et al. 1991) or in environmental media close to manganese-emitting industries (Lucchini et al. 2007; Mergler et al. 1999; Rodríguez-Agudelo et al. 2006). Some of these

## APPENDIX A

studies have found statistically significant differences between exposed and non-exposed groups or significant associations between exposure indices and neurological effects (Bast-Pettersen et al. 2004; Chia et al. 1993a; Iregren 1990; Lucchini et al. 1995, 1999; Mergler et al. 1994; Roels et al. 1987a, 1992; Wennberg et al. 1991), whereas others have not found significant associations (Deschamps et al. 2001; Gibbs et al. 1999; Myers et al. 2003a, 2003b; Young et al. 2005). Table A-3 summarizes results from these studies. Comparison of the effect levels in these studies provides support for selection of the Roels et al. (1992) as the basis of the MRL; the advantage of the Roels et al. (1992) study is that individual worker data were available to support a benchmark dose analysis.

**Table A-3. Epidemiological Studies of Neurological End Points in Workers Exposed to Low Levels of Manganese in Workplace Air**

| Reference                          | Place of work              | Estimated exposure (mg manganese/m <sup>3</sup> ) <sup>a</sup> | Years worked <sup>b</sup> | Number of exposed | Number of control | Effects   |
|------------------------------------|----------------------------|--|---------------------------|-------------------|-------------------|---|
| Chia et al. 1993a                  | Mn ore process             | 1.59   | 7.4                       | 17                | 17                | ↓ finger tapping, digit symbol, pursuit aiming  |
| Roels et al. 1987a                 | Mn salt and oxide plant    | 0.97   | 7.1                       | 141               | 104               | ↓ reaction time, short-term memory, eye-hand coordination, hand steadiness  |
| Roels et al. 1992, 1999            | Dry alkaline battery plant | 0.948 (0.215)  | 5.3                       | 92                | 37                | ↓ reaction time, short-term memory, eye-hand coordination, hand steadiness  |
| Iregren 1990; Wennberg et al. 1991 | Mn foundry                 | 0.14   | 9.9                       | 30                | 60                | ↓ finger tapping, reaction time   |
| Lucchini et al. 1995               | Mn alloy plant             | 0.149  | 13                        | 58                | None              | ↓ finger tapping, short-term memory with increasing exposure indices  |
| Lucchini et al. 1999               | Mn alloy plant             | 0.097 (0.038)  | 11.5                      | 61                | 87                | ↓ hand movements, finger tapping, short-term memory   |
| Mergler et al. 1994                | Mn alloy plant             | 0.23 (0.04)  | 16.7                      | 115               | 115               | ↓ rapid hand movements, cognitive flexibility; ↑ indices for tension, anger, fatigue, confusion                                     |
| Gibbs et al. 1999                  | Mn process plant           | 0.18 (0.051)   | 12.7                      | 75                | 75                | No effects on neuromotor tests or self-reported symptoms  |
| Deschamps et al. 2001              | Enamels production plant   | 2.05 (0.035)   | 19.7                      | 134               | 137               | No effects on self-reported symptoms or several cognitive tests; no neuromotor tests given.   |
| Myers et al. 2003a                 | Mn mines                   | 0.21   | 10.8                      | 489               | None              | No associations between indices of exposure and outcomes from tests of neuromotor and cognitive functions or self-reported symptoms |

## APPENDIX A

**Table A-3. Epidemiological Studies of Neurological End Points in Workers Exposed to Low Levels of Manganese in Workplace Air**

| Reference                                     | Place of work  | Estimated exposure (mg manganese/m <sup>3</sup> ) <sup>a</sup> | Years worked <sup>b</sup> | Number of exposed | Number of control | Effects   |
|---|----------------|--|---------------------------|-------------------|-------------------|---|
| Myers et al. 2003b;<br>Young et al. 2005      | Mn smelter     | 0.85<br>(0.58)   | 18.2                      | 509               | 67                | Neurobehavioral test batteries showed significant effects in only a few of the many end points evaluated  |
| Bast-Pettersen et al. 2004                    | Mn alloy plant | 0.753<br>(0.049)   | 20.2                      | 100               | 100               | ↑ scores for hand tremor, but no effect on other neuromotor or cognitive tests or symptoms                |
| Blond and Netterstrom 2007; Blond et al. 2007 | Steel works    | 0.07   | 24                        | 60–92             | 14–19             | ↓ fast hand and finger movement, but no effects on slow movements, reaction time, or cognitive end points |

<sup>a</sup>Mean, median, or midpoint of reported ranges of manganese concentration in total dust. Values for respirable dust are noted in parentheses when they were available.

<sup>b</sup>Mean, median, or midpoint of reported ranges of years employed at the facility.

The neurological effects associated with prolonged low-level manganese exposure generally have been subtle changes including deficits in tests of neuromotor or cognitive functions and altered mood states; they have been referred to by various authors as preclinical or subclinical neurological effects. Manganese air concentrations associated with these effects in chronically exposed workers range from about 0.07 to 1.59 mg manganese/m<sup>3</sup> (manganese in total or inhalable dust measurements; values for manganese in respirable dust are noted in parentheses in Table A-3). For several of these work environments, values of concentrations of manganese in respirable dust (generally particulate diameters <10 μm) represented <20–80% of the total dust values.

Several benchmark analyses of results from other epidemiological data for neurobehavioral deficits in manganese-exposed workers provide support for the MRL.

Dr. Anders Iregren provided ATSDR with individual worker data on total dust manganese exposure and performance on neurobehavioral tests for the occupational cohort that participated in his study (Iregren 1990; Wennberg et al. 1991). A benchmark analysis was also performed with these data under contract with ATSDR (Clewell and Crump 1999) and the BMCL<sub>10</sub> value derived from this evaluation was 0.071 mg manganese/m<sup>3</sup> based upon the reported observation that the respirable fraction ranged upwards to 80% of the total dust measured. This BMCL<sub>10</sub> value is similar to that estimated for the Roels et al. (1992) study (0.105 mg manganese/m<sup>3</sup>), thus giving support to the value obtained for the current MRL study.

Clewell et al. (2003) conducted benchmark analyses on data from three neuromotor tests in the Roels et al. (1992) study (visual reaction time, eye-hand coordination, and hand steadiness) and from five neuromotor tests in the Gibbs et al. (1999) study (hole 6 of the hand steadiness test, percent precision of the eye-hand coordination test, reaction time in the complex reaction test, RMS amplitude in the steady test, and tap time). Exposure measures in these analyses were recent measures of manganese concentrations in respirable dust. BMCL<sub>10</sub> values were 0.257, 0.099, and 0.202 mg manganese/m<sup>3</sup> for the

## APPENDIX A

visual reaction time, eye-hand coordination, and hand steadiness data from the Roels et al. (1992) study. BMCL<sub>10</sub> values from the analyses of outcomes from the Gibbs et al. (1999) study ranged from 0.09 to 0.27 mg manganese/m<sup>3</sup> (averaging the BMCLs within end points across different benchmark dose models applied to the data). Clewell et al. (2003) did not have individual worker data from the Iregren (1990) or Mergler et al. (1994), but, based on some assumptions about exposures (e.g., all exposed workers were exposed to average concentrations for the facilities and respirable manganese concentrations were calculated for the Iregren workers based on an assumption that 50% of total dust manganese was respirable), they calculated BMCL<sub>10</sub> values for six end points from the Mergler et al. (1994) study and the simple reaction time end point in the Iregren (1990) study. BMCL<sub>10</sub> values ranged from 0.1 to 0.3 mg manganese/m<sup>3</sup> from the Mergler et al. (1994) study end points to 0.1 mg manganese/m<sup>3</sup> for the reaction time end point in the Iregren (1990) study.

Health Canada (2008) recently prepared a draft document in which benchmark dose analyses were conducted on data for neurobehavioral end points from the study of Mn alloy workers by Lucchini et al. (1999). Using the average manganese concentrations in respirable dust over the 5-year period before testing as the dose metric, dose-response data for six tests of fine motor control, two aspects of memory tests, and one test of mental arithmetic were fit to linear models, which were used to calculate BMCL<sub>05</sub> values ranging from about 0.019 to 0.0588 mg manganese/m<sup>3</sup>. After adjustment to convert from occupational exposure (5 days/week, 8 hours/24 hours) to continuous exposure, adjusted BMCL<sub>05</sub> values were divided by a total uncertainty factor of 100 to arrive at prospective reference concentrations. The uncertainty factor was comprised of a factor of 10 to account for interindividual variability in response to manganese to protect possibly enhanced susceptibility of the elderly, infants and children, individuals with asymptomatic pre-parkinsonism, individuals with chronic liver disease or parenteral nutrition, and females and individuals with iron deficiency and a second factor of 10 to account for limitations/uncertainties in the database including: (1) the general population may be exposed to more soluble forms of manganese than most of the manganese-exposed workers; (2) the lack of extensive studies of the effect of prenatal exposure to manganese; and (3) the potential effects that manganese exposure early in life may have on health outcomes later in life. The prospective reference concentrations ranged from about 0.05 to 0.08 µg manganese/m<sup>3</sup>.

The 2000 ATSDR Toxicological Profile for Manganese derived a chronic MRL for inorganic manganese of 0.00004 mg manganese/m<sup>3</sup> (manganese in respirable dust), based on a BMCL<sub>10</sub> of 0.074 mg manganese/m<sup>3</sup> (manganese in respirable dust) for abnormal performance in tests of hand steadiness, eye-hand coordination, or reaction time in the same study of 92 male workers in a dry alkaline battery plant (Roels et al. 1992) used in the current assessment. The MRL was derived by adjustment of the BMCL<sub>10</sub> to a continuous exposure basis and division by an uncertainty factor of 500 (10 for human variability, 10 for database deficiencies and limitations, and a modifying factor of 5 for potentially increased susceptibility in children based on differential kinetics in the young).

The current assessment does not use a modifying factor of 5 for potentially increased susceptibility in children based on differential kinetics in the young, because recent studies in lactating rats and their offspring exposed to manganese by the oral or inhalation routes suggest that the human variability factor of 10 provides sufficient protection for the differential kinetics in children and adults. For example, in neonatal rats orally exposed to 25 or 50 mg manganese/kg/day manganese chloride from postnatal day 1 through 21, manganese concentrations in various brain regions were about 2-fold higher than brain manganese concentrations in adult rats exposed to the same oral dose levels for 21 days (Dorman et al. 2000). Similarly, 18-day-old neonatal rats exposed from birth to aerosols of manganese sulfate at 1 mg manganese/m<sup>3</sup>, 6 hours/day showed a 2.6-fold increase in striatum manganese concentrations, compared with controls, while lactating adults exposed to the same aerosol concentration showed a 1.7-fold increase compared with controls (Dorman et al. 2005a).

APPENDIX A

Agency Contact (Chemical Manager): Malcolm Williams, DVM, Ph.D.



APPENDIX A

This page is intentionally blank.

## APPENDIX B. USER'S GUIDE

### Chapter 1

#### Public Health Statement

This chapter of the profile is a health effects summary written in non-technical language. Its intended audience is the general public, especially people living in the vicinity of a hazardous waste site or chemical release. If the Public Health Statement were removed from the rest of the document, it would still communicate to the lay public essential information about the chemical.

The major headings in the Public Health Statement are useful to find specific topics of concern. The topics are written in a question and answer format. The answer to each question includes a sentence that will direct the reader to chapters in the profile that will provide more information on the given topic.

### Chapter 2

#### Relevance to Public Health

This chapter provides a health effects summary based on evaluations of existing toxicologic, epidemiologic, and toxicokinetic information. This summary is designed to present interpretive, weight-of-evidence discussions for human health end points by addressing the following questions:

1. What effects are known to occur in humans?
2. What effects observed in animals are likely to be of concern to humans?
3. What exposure conditions are likely to be of concern to humans, especially around hazardous waste sites?

The chapter covers end points in the same order that they appear within the Discussion of Health Effects by Route of Exposure section, by route (inhalation, oral, and dermal) and within route by effect. Human data are presented first, then animal data. Both are organized by duration (acute, intermediate, chronic). *In vitro* data and data from parenteral routes (intramuscular, intravenous, subcutaneous, etc.) are also considered in this chapter.

The carcinogenic potential of the profiled substance is qualitatively evaluated, when appropriate, using existing toxicokinetic, genotoxic, and carcinogenic data. ATSDR does not currently assess cancer potency or perform cancer risk assessments. Minimal Risk Levels (MRLs) for noncancer end points (if derived) and the end points from which they were derived are indicated and discussed.

Limitations to existing scientific literature that prevent a satisfactory evaluation of the relevance to public health are identified in the Chapter 3 Data Needs section.

#### Interpretation of Minimal Risk Levels

Where sufficient toxicologic information is available, ATSDR has derived MRLs for inhalation and oral routes of entry at each duration of exposure (acute, intermediate, and chronic). These MRLs are not meant to support regulatory action, but to acquaint health professionals with exposure levels at which adverse health effects are not expected to occur in humans.

## APPENDIX B

MRLs should help physicians and public health officials determine the safety of a community living near a chemical emission, given the concentration of a contaminant in air or the estimated daily dose in water. MRLs are based largely on toxicological studies in animals and on reports of human occupational exposure.

MRL users should be familiar with the toxicologic information on which the number is based. Chapter 2, "Relevance to Public Health," contains basic information known about the substance. Other sections such as Chapter 3 Section 3.9, "Interactions with Other Substances," and Section 3.10, "Populations that are Unusually Susceptible" provide important supplemental information.

MRL users should also understand the MRL derivation methodology. MRLs are derived using a modified version of the risk assessment methodology that the Environmental Protection Agency (EPA) provides (Barnes and Dourson 1988) to determine reference doses (RfDs) for lifetime exposure.

To derive an MRL, ATSDR generally selects the most sensitive end point which, in its best judgement, represents the most sensitive human health effect for a given exposure route and duration. ATSDR cannot make this judgement or derive an MRL unless information (quantitative or qualitative) is available for all potential systemic, neurological, and developmental effects. If this information and reliable quantitative data on the chosen end point are available, ATSDR derives an MRL using the most sensitive species (when information from multiple species is available) with the highest no-observed-adverse-effect level (NOAEL) that does not exceed any adverse effect levels. When a NOAEL is not available, a lowest-observed-adverse-effect level (LOAEL) can be used to derive an MRL, and an uncertainty factor (UF) of 10 must be employed. Additional uncertainty factors of 10 must be used both for human variability to protect sensitive subpopulations (people who are most susceptible to the health effects caused by the substance) and for interspecies variability (extrapolation from animals to humans). In deriving an MRL, these individual uncertainty factors are multiplied together. The product is then divided into the inhalation concentration or oral dosage selected from the study. Uncertainty factors used in developing a substance-specific MRL are provided in the footnotes of the levels of significant exposure (LSE) tables.

## **Chapter 3**

### **Health Effects**

#### **Tables and Figures for Levels of Significant Exposure (LSE)**

Tables and figures are used to summarize health effects and illustrate graphically levels of exposure associated with those effects. These levels cover health effects observed at increasing dose concentrations and durations, differences in response by species, MRLs to humans for noncancer end points, and EPA's estimated range associated with an upper-bound individual lifetime cancer risk of 1 in 10,000 to 1 in 10,000,000. Use the LSE tables and figures for a quick review of the health effects and to locate data for a specific exposure scenario. The LSE tables and figures should always be used in conjunction with the text. All entries in these tables and figures represent studies that provide reliable, quantitative estimates of NOAELs, LOAELs, or Cancer Effect Levels (CELs).

The legends presented below demonstrate the application of these tables and figures. Representative examples of LSE Table 3-1 and Figure 3-1 are shown. The numbers in the left column of the legends correspond to the numbers in the example table and figure.

## APPENDIX B

**LEGEND****See Sample LSE Table 3-1 (page B-6)**

- (1) Route of Exposure. One of the first considerations when reviewing the toxicity of a substance using these tables and figures should be the relevant and appropriate route of exposure. Typically when sufficient data exist, three LSE tables and two LSE figures are presented in the document. The three LSE tables present data on the three principal routes of exposure, i.e., inhalation, oral, and dermal (LSE Tables 3-1, 3-2, and 3-3, respectively). LSE figures are limited to the inhalation (LSE Figure 3-1) and oral (LSE Figure 3-2) routes. Not all substances will have data on each route of exposure and will not, therefore, have all five of the tables and figures.
- (2) Exposure Period. Three exposure periods—acute (less than 15 days), intermediate (15–364 days), and chronic (365 days or more)—are presented within each relevant route of exposure. In this example, an inhalation study of intermediate exposure duration is reported. For quick reference to health effects occurring from a known length of exposure, locate the applicable exposure period within the LSE table and figure.
- (3) Health Effect. The major categories of health effects included in LSE tables and figures are death, systemic, immunological, neurological, developmental, reproductive, and cancer. NOAELs and LOAELs can be reported in the tables and figures for all effects but cancer. Systemic effects are further defined in the "System" column of the LSE table (see key number 18).
- (4) Key to Figure. Each key number in the LSE table links study information to one or more data points using the same key number in the corresponding LSE figure. In this example, the study represented by key number 18 has been used to derive a NOAEL and a Less Serious LOAEL (also see the two "18r" data points in sample Figure 3-1).
- (5) Species. The test species, whether animal or human, are identified in this column. Chapter 2, "Relevance to Public Health," covers the relevance of animal data to human toxicity and Section 3.4, "Toxicokinetics," contains any available information on comparative toxicokinetics. Although NOAELs and LOAELs are species specific, the levels are extrapolated to equivalent human doses to derive an MRL.
- (6) Exposure Frequency/Duration. The duration of the study and the weekly and daily exposure regimens are provided in this column. This permits comparison of NOAELs and LOAELs from different studies. In this case (key number 18), rats were exposed to "Chemical x" via inhalation for 6 hours/day, 5 days/week, for 13 weeks. For a more complete review of the dosing regimen, refer to the appropriate sections of the text or the original reference paper (i.e., Nitschke et al. 1981).
- (7) System. This column further defines the systemic effects. These systems include respiratory, cardiovascular, gastrointestinal, hematological, musculoskeletal, hepatic, renal, and dermal/ocular. "Other" refers to any systemic effect (e.g., a decrease in body weight) not covered in these systems. In the example of key number 18, one systemic effect (respiratory) was investigated.
- (8) NOAEL. A NOAEL is the highest exposure level at which no harmful effects were seen in the organ system studied. Key number 18 reports a NOAEL of 3 ppm for the respiratory system, which was used to derive an intermediate exposure, inhalation MRL of 0.005 ppm (see footnote "b").

## APPENDIX B

- (9) LOAEL. A LOAEL is the lowest dose used in the study that caused a harmful health effect. LOAELs have been classified into "Less Serious" and "Serious" effects. These distinctions help readers identify the levels of exposure at which adverse health effects first appear and the gradation of effects with increasing dose. A brief description of the specific end point used to quantify the adverse effect accompanies the LOAEL. The respiratory effect reported in key number 18 (hyperplasia) is a Less Serious LOAEL of 10 ppm. MRLs are not derived from Serious LOAELs.
- (10) Reference. The complete reference citation is given in Chapter 9 of the profile.
- (11) CEL. A CEL is the lowest exposure level associated with the onset of carcinogenesis in experimental or epidemiologic studies. CELs are always considered serious effects. The LSE tables and figures do not contain NOAELs for cancer, but the text may report doses not causing measurable cancer increases.
- (12) Footnotes. Explanations of abbreviations or reference notes for data in the LSE tables are found in the footnotes. Footnote "b" indicates that the NOAEL of 3 ppm in key number 18 was used to derive an MRL of 0.005 ppm.

**LEGEND****See Sample Figure 3-1 (page B-7)**

LSE figures graphically illustrate the data presented in the corresponding LSE tables. Figures help the reader quickly compare health effects according to exposure concentrations for particular exposure periods.

- (13) Exposure Period. The same exposure periods appear as in the LSE table. In this example, health effects observed within the acute and intermediate exposure periods are illustrated.
- (14) Health Effect. These are the categories of health effects for which reliable quantitative data exists. The same health effects appear in the LSE table.
- (15) Levels of Exposure. Concentrations or doses for each health effect in the LSE tables are graphically displayed in the LSE figures. Exposure concentration or dose is measured on the log scale "y" axis. Inhalation exposure is reported in mg/m<sup>3</sup> or ppm and oral exposure is reported in mg/kg/day.
- (16) NOAEL. In this example, the open circle designated 18r identifies a NOAEL critical end point in the rat upon which an intermediate inhalation exposure MRL is based. The key number 18 corresponds to the entry in the LSE table. The dashed descending arrow indicates the extrapolation from the exposure level of 3 ppm (see entry 18 in the table) to the MRL of 0.005 ppm (see footnote "b" in the LSE table).
- (17) CEL. Key number 38m is one of three studies for which CELs were derived. The diamond symbol refers to a CEL for the test species-mouse. The number 38 corresponds to the entry in the LSE table.

## APPENDIX B

- (18) Estimated Upper-Bound Human Cancer Risk Levels. This is the range associated with the upper-bound for lifetime cancer risk of 1 in 10,000 to 1 in 10,000,000. These risk levels are derived from the EPA's Human Health Assessment Group's upper-bound estimates of the slope of the cancer dose response curve at low dose levels ( $q_1^*$ ).
- (19) Key to LSE Figure. The Key explains the abbreviations and symbols used in the figure.

**SAMPLE**

1 →

**Table 3-1. Levels of Significant Exposure to [Chemical x] – Inhalation**

| Key to figure <sup>a</sup>   | Species  | Exposure frequency/<br>duration | System                        | NOAEL (ppm) | LOAEL (effect)     |   | Reference            |
|------------------------------|----------|---------------------------------|-------------------------------|-------------|--------------------|---|----------------------|
|                              |          |                                 |                               |             | Less serious (ppm) | Serious (ppm)                           |                      |
| <b>INTERMEDIATE EXPOSURE</b> |          |                                 |                               |             |                    |   |                      |
|                              | 5        | 6                               | 7                             | 8           | 9                  |   | 10                   |
| 3 →                          | Systemic | ↓                               | ↓                             | ↓           | ↓                  | ↓                                       | ↓                    |
| 4 →                          | 18       | Rat                             | 13 wk<br>5 d/wk<br>6 hr/d     | Resp        | 3 <sup>b</sup>     | 10 (hyperplasia)                        | Nitschke et al. 1981 |
| <b>CHRONIC EXPOSURE</b>      |          |                                 |                               |             |                    |   |                      |
|                              | Cancer   |                                 |                               |             |                    | 11                                      |                      |
|                              |          |                                 |                               |             | ↓                  |   |                      |
|                              | 38       | Rat                             | 18 mo<br>5 d/wk<br>7 hr/d     |             |                    | 20 (CEL, multiple organs)               | Wong et al. 1982     |
|                              | 39       | Rat                             | 89–104 wk<br>5 d/wk<br>6 hr/d |             |                    | 10 (CEL, lung tumors, nasal tumors)     | NTP 1982             |
|                              | 40       | Mouse                           | 79–103 wk<br>5 d/wk<br>6 hr/d |             |                    | 10 (CEL, lung tumors, hemangiosarcomas) | NTP 1982             |

12 →

<sup>a</sup> The number corresponds to entries in Figure 3-1.

<sup>b</sup> Used to derive an intermediate inhalation Minimal Risk Level (MRL) of  $5 \times 10^{-3}$  ppm; dose adjusted for intermittent exposure and divided by an uncertainty factor of 100 (10 for extrapolation from animal to humans, 10 for human variability).

# SAMPLE

### Figure 3-1. Levels of Significant Exposure to [Chemical X] - Inhalation

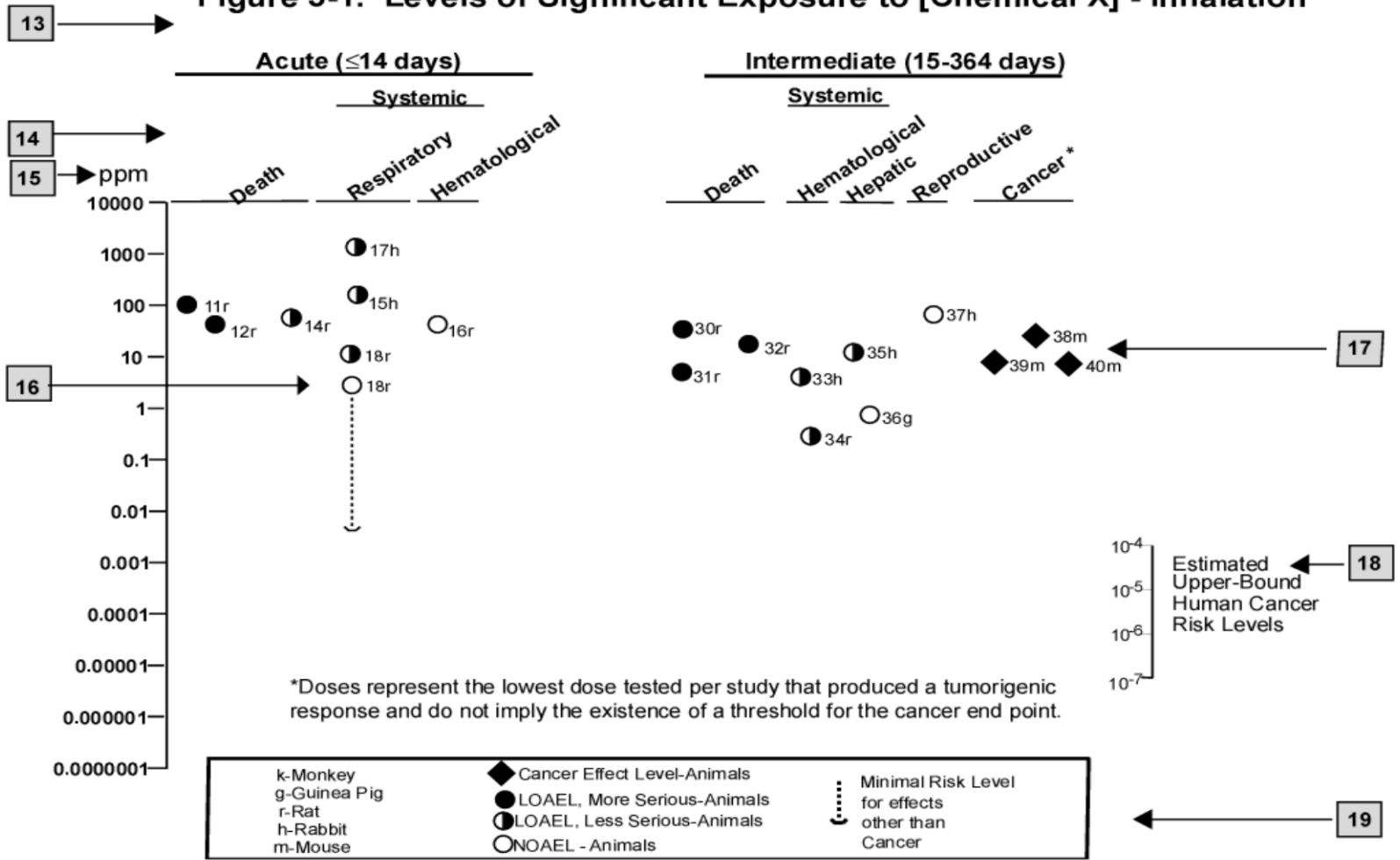

\*\*\*DRAFT FOR PUBLIC COMMENT\*\*\*

APPENDIX B



APPENDIX B

This page is intentionally blank.

## APPENDIX C. ACRONYMS, ABBREVIATIONS, AND SYMBOLS

|                   |   |
|-------------------|---|
| ACGIH             | American Conference of Governmental Industrial Hygienists             |
| ACOEM             | American College of Occupational and Environmental Medicine           |
| ADI               | acceptable daily intake   |
| ADME              | absorption, distribution, metabolism, and excretion                   |
| AED               | atomic emission detection   |
| AFID              | alkali flame ionization detector                                      |
| AFOSH             | Air Force Office of Safety and Health                                 |
| ALT               | alanine aminotransferase  |
| AML               | acute myeloid leukemia  |
| AOAC              | Association of Official Analytical Chemists                           |
| AOEC              | Association of Occupational and Environmental Clinics                 |
| AP                | alkaline phosphatase  |
| APHA              | American Public Health Association                                    |
| AST               | aspartate aminotransferase  |
| atm               | atmosphere  |
| ATSDR             | Agency for Toxic Substances and Disease Registry                      |
| AWQC              | Ambient Water Quality Criteria  |
| BAT               | best available technology   |
| BCF               | bioconcentration factor   |
| BEI               | Biological Exposure Index   |
| BMD/C             | benchmark dose or benchmark concentration                             |
| BMD <sub>x</sub>  | dose that produces a X% change in response rate of an adverse effect  |
| BMDL <sub>x</sub> | 95% lower confidence limit on the BMD <sub>x</sub>                    |
| BMDS              | Benchmark Dose Software   |
| BMR               | benchmark response  |
| BSC               | Board of Scientific Counselors  |
| C                 | centigrade  |
| CAA               | Clean Air Act   |
| CAG               | Cancer Assessment Group of the U.S. Environmental Protection Agency   |
| CAS               | Chemical Abstract Services  |
| CDC               | Centers for Disease Control and Prevention                            |
| CEL               | cancer effect level   |
| CELDS             | Computer-Environmental Legislative Data System                        |
| CERCLA            | Comprehensive Environmental Response, Compensation, and Liability Act |
| CFR               | Code of Federal Regulations   |
| Ci                | curie   |
| CI                | confidence interval   |
| CL                | ceiling limit value   |
| CLP               | Contract Laboratory Program   |
| cm                | centimeter  |
| CML               | chronic myeloid leukemia  |
| CPSC              | Consumer Products Safety Commission                                   |
| CWA               | Clean Water Act   |
| DHEW              | Department of Health, Education, and Welfare                          |
| DHHS              | Department of Health and Human Services                               |
| DNA               | deoxyribonucleic acid   |
| DOD               | Department of Defense   |
| DOE               | Department of Energy  |
| DOL               | Department of Labor   |

## APPENDIX C

|                    |   |
|--------------------|---|
| DOT                | Department of Transportation  |
| DOT/UN/<br>NA/IMDG | Department of Transportation/United Nations/<br>North America/Intergovernmental Maritime Dangerous Goods Code |
| DWEL               | drinking water exposure level   |
| ECD                | electron capture detection  |
| ECG/EKG            | electrocardiogram   |
| EEG                | electroencephalogram  |
| EEGL               | Emergency Exposure Guidance Level   |
| EPA                | Environmental Protection Agency   |
| F                  | Fahrenheit  |
| F <sub>1</sub>     | first-filial generation   |
| FAO                | Food and Agricultural Organization of the United Nations  |
| FDA                | Food and Drug Administration  |
| FEMA               | Federal Emergency Management Agency   |
| FIFRA              | Federal Insecticide, Fungicide, and Rodenticide Act   |
| FPD                | flame photometric detection   |
| fpm                | feet per minute   |
| FR                 | Federal Register  |
| FSH                | follicle stimulating hormone  |
| g                  | gram  |
| GC                 | gas chromatography  |
| gd                 | gestational day   |
| GLC                | gas liquid chromatography   |
| GPC                | gel permeation chromatography   |
| HPLC               | high-performance liquid chromatography  |
| HRGC               | high resolution gas chromatography  |
| HSDB               | Hazardous Substance Data Bank   |
| IARC               | International Agency for Research on Cancer   |
| IDLH               | immediately dangerous to life and health  |
| ILO                | International Labor Organization  |
| IRIS               | Integrated Risk Information System  |
| K <sub>d</sub>     | adsorption ratio  |
| kg                 | kilogram  |
| kgg                | metric ton  |
| K <sub>oc</sub>    | organic carbon partition coefficient  |
| K <sub>ow</sub>    | octanol-water partition coefficient   |
| L                  | liter   |
| LC                 | liquid chromatography   |
| LC <sub>50</sub>   | lethal concentration, 50% kill  |
| LC <sub>Lo</sub>   | lethal concentration, low   |
| LD <sub>50</sub>   | lethal dose, 50% kill   |
| LD <sub>Lo</sub>   | lethal dose, low  |
| LDH                | lactic dehydrogenase  |
| LH                 | lutinizing hormone  |
| LOAEL              | lowest-observed-adverse-effect level  |
| LSE                | Levels of Significant Exposure  |
| LT <sub>50</sub>   | lethal time, 50% kill   |
| m                  | meter   |
| MA                 | <i>trans,trans</i> -muconic acid  |
| MAL                | maximum allowable level   |
| mCi                | millicurie  |

## APPENDIX C

|          |  |
|----------|--|
| MCL      | maximum contaminant level                                    |
| MCLG     | maximum contaminant level goal                               |
| MF       | modifying factor   |
| MFO      | mixed function oxidase                                       |
| mg       | milligram  |
| mL       | milliliter   |
| mm       | millimeter   |
| mmHg     | millimeters of mercury                                       |
| mmol     | millimole  |
| mppcf    | millions of particles per cubic foot                         |
| MRL      | Minimal Risk Level   |
| MS       | mass spectrometry  |
| NAAQS    | National Ambient Air Quality Standard                        |
| NAS      | National Academy of Science                                  |
| NATICH   | National Air Toxics Information Clearinghouse                |
| NATO     | North Atlantic Treaty Organization                           |
| NCE      | normochromatic erythrocytes                                  |
| NCEH     | National Center for Environmental Health                     |
| NCI      | National Cancer Institute                                    |
| ND       | not detected   |
| NFPA     | National Fire Protection Association                         |
| ng       | nanogram   |
| NHANES   | National Health and Nutrition Examination Survey             |
| NIEHS    | National Institute of Environmental Health Sciences          |
| NIOSH    | National Institute for Occupational Safety and Health        |
| NIOSHTIC | NIOSH's Computerized Information Retrieval System            |
| NLM      | National Library of Medicine                                 |
| nm       | nanometer  |
| nmol     | nanomole   |
| NOAEL    | no-observed-adverse-effect level                             |
| NOES     | National Occupational Exposure Survey                        |
| NOHS     | National Occupational Hazard Survey                          |
| NPD      | nitrogen phosphorus detection                                |
| NPDES    | National Pollutant Discharge Elimination System              |
| NPL      | National Priorities List                                     |
| NR       | not reported   |
| NRC      | National Research Council                                    |
| NS       | not specified  |
| NSPS     | New Source Performance Standards                             |
| NTIS     | National Technical Information Service                       |
| NTP      | National Toxicology Program                                  |
| ODW      | Office of Drinking Water, EPA                                |
| OERR     | Office of Emergency and Remedial Response, EPA               |
| OHM/TADS | Oil and Hazardous Materials/Technical Assistance Data System |
| OPP      | Office of Pesticide Programs, EPA                            |
| OPPT     | Office of Pollution Prevention and Toxics, EPA               |
| OPPTS    | Office of Prevention, Pesticides and Toxic Substances, EPA   |
| OR       | odds ratio   |
| OSHA     | Occupational Safety and Health Administration                |
| OSW      | Office of Solid Waste, EPA                                   |
| OTS      | Office of Toxic Substances                                   |

## APPENDIX C

|                  |  |
|------------------|--|
| OW               | Office of Water                                  |
| OWRS             | Office of Water Regulations and Standards, EPA   |
| PAH              | polycyclic aromatic hydrocarbon                  |
| PBPD             | physiologically based pharmacodynamic            |
| PBPK             | physiologically based pharmacokinetic            |
| PCE              | polychromatic erythrocytes                       |
| PEL              | permissible exposure limit                       |
| pg               | picogram   |
| PHS              | Public Health Service                            |
| PID              | photo ionization detector                        |
| pmol             | picomole   |
| PMR              | proportionate mortality ratio                    |
| ppb              | parts per billion                                |
| ppm              | parts per million                                |
| ppt              | parts per trillion                               |
| PSNS             | pretreatment standards for new sources           |
| RBC              | red blood cell                                   |
| REL              | recommended exposure level/limit                 |
| RfC              | reference concentration                          |
| RfD              | reference dose                                   |
| RNA              | ribonucleic acid                                 |
| RQ               | reportable quantity                              |
| RTECS            | Registry of Toxic Effects of Chemical Substances |
| SARA             | Superfund Amendments and Reauthorization Act     |
| SCE              | sister chromatid exchange                        |
| SGOT             | serum glutamic oxaloacetic transaminase          |
| SGPT             | serum glutamic pyruvic transaminase              |
| SIC              | standard industrial classification               |
| SIM              | selected ion monitoring                          |
| SMCL             | secondary maximum contaminant level              |
| SMR              | standardized mortality ratio                     |
| SNARL            | suggested no adverse response level              |
| SPEGL            | Short-Term Public Emergency Guidance Level       |
| STEL             | short term exposure limit                        |
| STORET           | Storage and Retrieval                            |
| TD <sub>50</sub> | toxic dose, 50% specific toxic effect            |
| TLV              | threshold limit value                            |
| TOC              | total organic carbon                             |
| TPQ              | threshold planning quantity                      |
| TRI              | Toxics Release Inventory                         |
| TSCA             | Toxic Substances Control Act                     |
| TWA              | time-weighted average                            |
| UF               | uncertainty factor                               |
| U.S.             | United States                                    |
| USDA             | United States Department of Agriculture          |
| USGS             | United States Geological Survey                  |
| VOC              | volatile organic compound                        |
| WBC              | white blood cell                                 |
| WHO              | World Health Organization                        |

## APPENDIX C

|                  |                          |
|------------------|--------------------------|
| >                | greater than             |
| ≥                | greater than or equal to |
| =                | equal to                 |
| <                | less than                |
| ≤                | less than or equal to    |
| %                | percent                  |
| α                | alpha                    |
| β                | beta                     |
| γ                | gamma                    |
| δ                | delta                    |
| μm               | micrometer               |
| μg               | microgram                |
| q <sub>1</sub> * | cancer slope factor      |
| -                | negative                 |
| +                | positive                 |
| (+)              | weakly positive result   |
| (-)              | weakly negative result   |

APPENDIX C

This page is intentionally blank.

## APPENDIX D. INDEX

|   |  |
|---|--|
| absorbed dose.....                          | 283, 287, 365, 368   |
| acetylcholine.....                          | 175  |
| acetylcholinesterase.....                   | 170, 175, 277  |
| active transport.....                       | 214, 236, 259  |
| adrenal gland.....                          | 139, 184   |
| adsorbed.....                               | 343, 352, 353, 358   |
| adsorption.....                             | 353  |
| alanine aminotransferase.....               | 156, 187   |
| ambient air.....                            | 11, 349, 357, 368  |
| anaerobic.....                              | 354, 355   |
| anemia.....                                 | 205, 295, 374  |
| bioaccumulation.....                        | 353  |
| bioavailability.....                        | 38, 204, 206, 286, 293, 358, 371, 373, 377, 379  |
| bioconcentration factor.....                | 353  |
| biomarker.....                              | 205, 282, 283, 285, 286, 287, 288, 290, 315, 320, 364, 373, 380, 381, 389  |
| blood cell count.....                       | 27, 136, 142   |
| body weight effects.....                    | 64, 140, 141, 182, 188, 189  |
| breast milk.....                            | 165, 204, 206, 210, 233, 281, 293, 319, 362, 370   |
| cancer.....                                 | 5, 15, 184, 225, 272, 308, 395   |
| carcinogenic.....                           | 15, 19, 39, 91, 179, 180, 183, 308   |
| carcinogenicity.....                        | 15, 34, 395  |
| cardiovascular.....                         | 27, 28, 61, 62, 134, 135, 180, 185, 186, 321   |
| cardiovascular effects.....                 | 27, 61, 62, 134, 180, 185, 186   |
| chromosomal aberrations.....                | 194, 197, 199, 210, 309  |
| clearance.....                              | 40, 199, 200, 220, 229, 236, 242, 248, 249, 250, 253, 254, 255, 265, 285, 299, 300   |
| cognitive function.....                     | 24, 70, 81, 152, 173, 265  |
| death.....                                  | 39, 58, 61, 92, 132, 133, 138, 143, 153, 154, 166, 180, 185, 304   |
| deoxyribonucleic acid (see DNA).....        | 196  |
| dermal effects.....                         | 64, 140, 181, 188, 302   |
| developmental effects.....                  | 17, 18, 91, 170, 171, 174, 179, 183, 192, 278, 279, 296, 306, 310, 318   |
| developmental neurotoxicity.....            | 175  |
| DNA (see deoxyribonucleic acid).....        | 194, 196, 283  |
| dopamine.....                               | 27, 28, 86, 156, 158, 160, 161, 163, 164, 170, 173, 174, 175, 176, 177,<br>229, 260, 262, 265, 267, 277, 279, 285, 289, 292, 301, 307, 322 |
| elimination half-time.....                  | 235, 236   |
| elimination rate.....                       | 248, 256   |
| endocrine.....                              | 63, 64, 139, 140, 181, 188, 269, 270   |
| endocrine effects.....                      | 63, 64, 139, 140, 181, 188, 270  |
| erythema.....                               | 181  |
| fetal tissue.....                           | 207, 218, 276  |
| fetus.....                                  | 178, 209, 218, 271, 277, 281, 311, 319, 370  |
| follicle stimulating hormone (see FSH)..... | 63   |
| FSH (see follicle stimulating hormone)..... | 63, 166, 167, 172, 270   |
| gastrointestinal effects.....               | 62, 135, 136, 181, 186   |
| general population.....                     | 12, 23, 25, 209, 279, 282, 294, 302, 305, 341,<br>357, 364, 368, 371, 372, 374, 375, 378, 391  |
| genotoxic.....                              | 39, 197, 199, 309  |
| genotoxicity.....                           | 197, 309   |
| groundwater.....                            | 3, 294, 341, 350, 353, 358, 361  |



## APPENDIX D

|  |  |
|--|--|
| growth retardation.....                                | 166  |
| half-life.....   | 58, 203, 227, 283, 299, 352, 354   |
| hematological effects .....                            | 62, 136, 137, 181, 186   |
| hepatic effects .....                                  | 62, 63, 137, 138, 181, 187, 290  |
| hydroxyl radical .....                                 | 265  |
| immune system .....                                    | 65, 142, 312   |
| immunological .....                                    | 39, 65, 142, 182, 189  |
| immunological effects.....                             | 65, 142  |
| $K_{ow}$ .....   | 327, 328, 329  |
| $LD_{50}$ .....  | 58, 132, 133, 180, 184   |
| lymphatic .....  | 203  |
| lymphoreticular .....                                  | 65, 142, 182, 189  |
| magnetic resonance imaging (see MRI).....              | 2, 7, 12, 39, 339  |
| menstrual.....   | 270  |
| metabolic effects .....                                | 64, 65, 142, 182, 189  |
| micronuclei .....                                      | 197, 199   |
| milk .....   | 14, 28, 150, 173, 178, 179, 204, 206, 209, 210, 214, 233, 280, 281, 293, 311, 362, 370, 377  |
| minimal risk level (see MRL) .....                     | 19   |
| MRI (see magnetic resonance imaging).....              | 7, 12, 39, 66, 68, 150, 152, 153, 183, 213, 220, 224, 226,<br>228, 259, 268, 273, 282, 286, 288, 295, 296, 299, 312,<br>315, 320, 321, 339, 371, 374, 380, 383, 389  |
| MRL (see minimal risk level).....                      | 19, 22, 23, 24, 26, 28, 31, 32, 34, 35, 40, 304, 305, 308, 317, 391  |
| mucociliary .....                                      | 68, 199, 200, 248, 257, 298, 316   |
| musculoskeletal effects .....                          | 63, 137, 181, 187  |
| neonatal.....  | 27, 28, 29, 31, 87, 153, 172, 174, 175, 176, 177, 218, 222,<br>233, 263, 275, 276, 277, 280, 293, 311, 319, 380  |
| neoplastic .....                                       | 39   |
| neurobehavioral.....                                   | 16, 21, 22, 23, 24, 25, 26, 27, 28, 29, 31, 34, 70, 73, 75, 76, 77, 78, 79, 80,<br>81, 82, 84, 86, 147, 163, 170, 266, 267, 268, 270, 274, 281,<br>286, 288, 294, 305, 307, 308, 310, 311, 312, 317, 380   |
| neurochemical.....                                     | 27, 160, 174, 176, 260, 264, 267, 268, 276, 277, 281, 294, 311, 317  |
| neurodevelopmental.....                                | 27, 310  |
| neurological effects.....                              | 14, 15, 16, 17, 19, 21, 23, 33, 38, 66, 69, 70, 73, 78, 82, 84, 86, 88, 91, 143, 144,<br>146, 148, 155, 164, 177, 182, 189, 190, 212, 272, 273, 275, 278, 282, 287, 288,<br>290, 293, 294, 296, 302, 304, 305, 306, 307, 308, 312, 313, 315, 318, 320, 374 |
| neurophysiological.....                                | 294  |
| neurotoxicity .....                                    | 16, 21, 33, 68, 86, 88, 90, 156, 162, 174, 178, 190, 213, 217, 228, 235, 260, 261,<br>262, 263, 265, 266, 267, 268, 269, 273, 274, 275, 277, 294, 299, 300,<br>301, 304, 305, 306, 307, 313, 314, 317, 318, 321, 322, 380                                  |
| neurotransmitter .....                                 | 164, 179, 260, 293, 315  |
| norepinephrine .....                                   | 164, 170, 174, 277   |
| nuclear.....   | 139  |
| ocular effects.....                                    | 64, 140, 182, 188  |
| odds ratio.....  | 71, 85   |
| oxidative phosphorylation.....                         | 264  |
| partition coefficients .....                           | 242, 250   |
| PBTK (see physiologically based pharmacokinetic) ..... | 239, 269, 317, 318   |
| pharmacodynamic .....                                  | 237  |
| pharmacokinetic.....                                   | 202, 237, 238, 240, 250, 256, 271, 280, 282, 317, 319  |
| photolysis .....                                       | 354  |
| physiologically based pharmacokinetic (see PBTK) ..... | 239  |

## APPENDIX D

|                           |  |
|---------------------------|--|
| placenta .....            | 218, 276, 281, 370   |
| rate constant .....       | 242, 247, 248, 250, 251, 253, 254, 255   |
| renal effects .....       | 63, 138, 139, 181, 188   |
| reproductive effects..... | 17, 19, 23, 30, 88, 90, 139, 165, 169, 183, 191, 310, 391  |
| respiratory effects.....  | 17, 20, 59, 61, 133, 180, 185, 272, 288, 296   |
| retention .....           | 14, 62, 81, 147, 203, 204, 206, 222, 227, 229, 233,<br>235, 280, 282, 293, 300, 317, 318, 319, 352 |
| sequestered.....          | 259  |
| solubility .....          | 38, 257, 316, 352, 376, 390  |
| spermatogonia.....        | 197  |
| systemic effects.....     | 27, 59, 133, 180, 185  |
| T3 .....                  | 41, 93   |
| T4 .....                  | 195  |
| thyroid.....              | 139, 179   |
| toxicokinetic.....        | 37, 190, 224, 230, 236, 268, 282, 293, 296, 315, 317, 389  |
| tremors .....             | 14, 16, 87, 143, 151, 182  |
| tumors .....              | 39, 184, 186, 187, 225, 280  |
| vapor pressure .....      | 351  |
| weanling.....             | 134, 159, 166, 167, 171, 172, 201, 222, 278  |

