

**DRAFT  
TOXICOLOGICAL PROFILE FOR  
RADON**

U.S. DEPARTMENT OF HEALTH AND HUMAN SERVICES  
Public Health Service  
Agency for Toxic Substances and Disease Registry

September 2008

## **DISCLAIMER**

The use of company or product name(s) is for identification only and does not imply endorsement by the Agency for Toxic Substances and Disease Registry.

This information is distributed solely for the purpose of pre dissemination public comment under applicable information quality guidelines. It has not been formally disseminated by the Agency for Toxic Substances and Disease Registry. It does not represent and should not be construed to represent any agency determination or policy.

## UPDATE STATEMENT

A Toxicological Profile for Radon was released in 1990. This edition supersedes any previously released draft or final profile.

Toxicological profiles are revised and republished as necessary. For information regarding the update status of previously released profiles, contact ATSDR at:

Agency for Toxic Substances and Disease Registry  
Division of Toxicology and Environmental Medicine/Applied Toxicology Branch  
1600 Clifton Road NE  
Mailstop F-32  
Atlanta, Georgia 30333

This page is intentionally blank.

## FOREWORD

This toxicological profile is prepared in accordance with guidelines developed by the Agency for Toxic Substances and Disease Registry (ATSDR) and the Environmental Protection Agency (EPA). The original guidelines were published in the *Federal Register* on April 17, 1987. Each profile will be revised and republished as necessary.

The ATSDR toxicological profile succinctly characterizes the toxicologic and adverse health effects information for the hazardous substance described therein. Each peer-reviewed profile identifies and reviews the key literature that describes a hazardous substance's toxicologic properties. Other pertinent literature is also presented, but is described in less detail than the key studies. The profile is not intended to be an exhaustive document; however, more comprehensive sources of specialty information are referenced.

The focus of the profiles is on health and toxicologic information; therefore, each toxicological profile begins with a public health statement that describes, in nontechnical language, a substance's relevant toxicological properties. Following the public health statement is information concerning levels of significant human exposure and, where known, significant health effects. The adequacy of information to determine a substance's health effects is described in a health effects summary. Data needs that are of significance to protection of public health are identified by ATSDR and EPA.

Each profile includes the following:

- (A) The examination, summary, and interpretation of available toxicologic information and epidemiologic evaluations on a hazardous substance to ascertain the levels of significant human exposure for the substance and the associated acute, subacute, and chronic health effects;
- (B) A determination of whether adequate information on the health effects of each substance is available or in the process of development to determine levels of exposure that present a significant risk to human health of acute, subacute, and chronic health effects; and
- (C) Where appropriate, identification of toxicologic testing needed to identify the types or levels of exposure that may present significant risk of adverse health effects in humans.

The principal audiences for the toxicological profiles are health professionals at the Federal, State, and local levels; interested private sector organizations and groups; and members of the public. We plan to revise these documents in response to public comments and as additional data become available. Therefore, we encourage comments that will make the toxicological profile series of the greatest use.

Comments should be sent to:

Agency for Toxic Substances and Disease Registry  
Division of Toxicology and Environmental Medicine  
1600 Clifton Road NE  
Mail Stop F-32  
Atlanta, Georgia 30333

### Background Information

The toxicological profiles are developed in response to the Superfund Amendments and Reauthorization Act (SARA) of 1986 (Public Law 99 499) which amended the Comprehensive Environmental Response, Compensation, and Liability Act of 1980 (CERCLA or Superfund). This public law directed ATSDR to prepare toxicological profiles for hazardous substances most commonly found at facilities on the CERCLA National Priorities List and that pose the most significant potential threat to human health, as determined by ATSDR and the EPA. The availability of the revised priority list of 275 hazardous substances was announced in the Federal Register on December 7, 2005 (70 FR 72840). For prior versions of the list of substances, see Federal Register notices dated April 17, 1987 (52 FR 12866); October 20, 1988 (53 FR 41280); October 26, 1989 (54 FR 43619); October 17, 1990 (55 FR 42067); October 17, 1991 (56 FR 52166); October 28, 1992 (57 FR 48801); February 28, 1994 (59 FR 9486); April 29, 1996 (61 FR 18744); November 17, 1997 (62 FR 61332); October 21, 1999 (64 FR 56792); October 25, 2001 (66 FR 54014) and November 7, 2003 (68 FR 63098). Section 104(i)(3) of CERCLA, as amended, directs the Administrator of ATSDR to prepare a toxicological profile for each substance on the list.

This profile reflects ATSDR's assessment of all relevant toxicologic testing and information that has been peer-reviewed. Staff of the Centers for Disease Control and Prevention and other Federal scientists have also reviewed the profile. In addition, this profile has been peer-reviewed by a nongovernmental panel and was made available for public review. Final responsibility for the contents and views expressed in this toxicological profile resides with ATSDR.



Howard Frumkin M.D., Dr.P.H.  
Director  
National Center for Environmental Health/  
Agency for Toxic Substances and  
Disease Registry

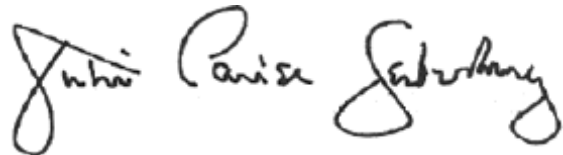

Julie Louise Gerberding, M.D., M.P.H.  
Administrator  
Agency for Toxic Substances and  
Disease Registry

## QUICK REFERENCE FOR HEALTH CARE PROVIDERS

Toxicological Profiles are a unique compilation of toxicological information on a given hazardous substance. Each profile reflects a comprehensive and extensive evaluation, summary, and interpretation of available toxicologic and epidemiologic information on a substance. Health care providers treating patients potentially exposed to hazardous substances will find the following information helpful for fast answers to often-asked questions.

---

### *Primary Chapters/Sections of Interest*

**Chapter 1: Public Health Statement:** The Public Health Statement can be a useful tool for educating patients about possible exposure to a hazardous substance. It explains a substance's relevant toxicologic properties in a nontechnical, question-and-answer format, and it includes a review of the general health effects observed following exposure.

**Chapter 2: Relevance to Public Health:** The Relevance to Public Health Section evaluates, interprets, and assesses the significance of toxicity data to human health.

**Chapter 3: Health Effects:** Specific health effects of a given hazardous compound are reported by type of health effect (death, systemic, immunologic, reproductive), by route of exposure, and by length of exposure (acute, intermediate, and chronic). In addition, both human and animal studies are reported in this section.

**NOTE:** Not all health effects reported in this section are necessarily observed in the clinical setting. Please refer to the Public Health Statement to identify general health effects observed following exposure.

**Pediatrics:** Four new sections have been added to each Toxicological Profile to address child health issues:

**Section 1.6**     **How Can (Chemical X) Affect Children?**  
**Section 1.7**     **How Can Families Reduce the Risk of Exposure to (Chemical X)?**  
**Section 3.8**     **Children's Susceptibility**  
**Section 6.6**     **Exposures of Children**

### **Other Sections of Interest:**

**Section 3.9**     **Biomarkers of Exposure and Effect**  
**Section 3.12**   **Methods for Reducing Toxic Effects**

---

### **ATSDR Information Center**

**Phone:** 1-800-CDC-INFO (800-232-4636) or **Fax:** (770) 488-4178  
1-888-232-6348 (TTY)

**E-mail:** [cdcinfo@cdc.gov](mailto:cdcinfo@cdc.gov)                      **Internet:** <http://www.atsdr.cdc.gov>

The following additional material can be ordered through the ATSDR Information Center:

*Case Studies in Environmental Medicine: Taking an Exposure History*—The importance of taking an exposure history and how to conduct one are described, and an example of a thorough exposure history is provided. Other case studies of interest include *Reproductive and Developmental Hazards*; *Skin Lesions and Environmental Exposures*; *Cholinesterase-Inhibiting Pesticide Toxicity*; and numerous chemical-specific case studies.

*Managing Hazardous Materials Incidents* is a three-volume set of recommendations for on-scene (prehospital) and hospital medical management of patients exposed during a hazardous materials incident. Volumes I and II are planning guides to assist first responders and hospital emergency department personnel in planning for incidents that involve hazardous materials. Volume III—*Medical Management Guidelines for Acute Chemical Exposures*—is a guide for health care professionals treating patients exposed to hazardous materials.

*Fact Sheets (ToxFAQs)* provide answers to frequently asked questions about toxic substances.

---

### ***Other Agencies and Organizations***

*The National Center for Environmental Health (NCEH)* focuses on preventing or controlling disease, injury, and disability related to the interactions between people and their environment outside the workplace. Contact: NCEH, Mailstop F-29, 4770 Buford Highway, NE, Atlanta, GA 30341-3724 • Phone: 770-488-7000 • FAX: 770-488-7015.

*The National Institute for Occupational Safety and Health (NIOSH)* conducts research on occupational diseases and injuries, responds to requests for assistance by investigating problems of health and safety in the workplace, recommends standards to the Occupational Safety and Health Administration (OSHA) and the Mine Safety and Health Administration (MSHA), and trains professionals in occupational safety and health. Contact: NIOSH, 200 Independence Avenue, SW, Washington, DC 20201 • Phone: 800-356-4674 or NIOSH Technical Information Branch, Robert A. Taft Laboratory, Mailstop C-19, 4676 Columbia Parkway, Cincinnati, OH 45226-1998 • Phone: 800-35-NIOSH.

*The National Institute of Environmental Health Sciences (NIEHS)* is the principal federal agency for biomedical research on the effects of chemical, physical, and biologic environmental agents on human health and well-being. Contact: NIEHS, PO Box 12233, 104 T.W. Alexander Drive, Research Triangle Park, NC 27709 • Phone: 919-541-3212.

*Radiation Emergency Assistance Center/Training Site (REAC/TS)* provides support to the U.S. Department of Energy, the World Health Organization, and the International Atomic Energy Agency in the medical management of radiation accidents. A 24-hour emergency response program at the Oak Ridge Institute for Science and Education (ORISE), REAC/TS trains, consults, or assists in the response to all kinds of radiation accidents. Contact: Oak Ridge Institute for Science and Education, REAC/TS, PO Box 117, MS 39, Oak Ridge, TN 37831-0117 • Phone 865-576-3131 • FAX 865-576-9522 • 24-Hour Emergency Phone 865-576-1005 (ask for REAC/TS) • e-mail: [cooleyp@ornl.gov](mailto:cooleyp@ornl.gov) • website (including emergency medical guidance): <http://www.ornl.gov/reacts/default.htm>.

---

### ***Referrals***

*The Association of Occupational and Environmental Clinics (AOEC)* has developed a network of clinics in the United States to provide expertise in occupational and environmental issues. Contact: AOEC, 1010 Vermont Avenue, NW, #513, Washington, DC 20005 • Phone: 202-347-4976 • FAX: 202-347-4950 • e-mail: [AOEC@AOEC.ORG](mailto:AOEC@AOEC.ORG) • Web Page: <http://www.aoec.org/>.



*The American College of Occupational and Environmental Medicine (ACOEM)* is an association of physicians and other health care providers specializing in the field of occupational and environmental medicine. Contact: ACOEM, 25 Northwest Point Boulevard, Suite 700, Elk Grove Village, IL 60007-1030 • Phone: 847-818-1800 • FAX: 847-818-9266.

This page is intentionally blank.

## CONTRIBUTORS

### CHEMICAL MANAGER(S)/AUTHOR(S):

Sam Keith, M.S., C.H.P.

John R. Doyle, M.P.A.

Carolyn Harper, Ph.D.

Moiz Mumtaz, Ph.D.

Oscar Tarrago, M.D., M.P.H., C.H.E.S.

ATSDR, Division of Toxicology and Environmental Medicine, Atlanta, GA

David W. Wohlers, Ph.D.

Gary L. Diamond, Ph.D.

Mario Citra, Ph.D.

Lynn E. Barber, M.S.

Syracuse Research Corporation, North Syracuse, NY

### THE PROFILE HAS UNDERGONE THE FOLLOWING ATSDR INTERNAL REVIEWS:

1. Health Effects Review. The Health Effects Review Committee examines the health effects chapter of each profile for consistency and accuracy in interpreting health effects and classifying end points.
2. Minimal Risk Level Review. The Minimal Risk Level Workgroup considers issues relevant to substance-specific Minimal Risk Levels (MRLs), reviews the health effects database of each profile, and makes recommendations for derivation of MRLs.
3. Data Needs Review. The Research Implementation Branch reviews data needs sections to assure consistency across profiles and adherence to instructions in the Guidance.
4. Green Border Review. Green Border review assures the consistency with ATSDR policy.

This page is intentionally blank.

## PEER REVIEW

A peer review panel was assembled in 2008 for radon. The panel consisted of the following members:

1. R. William Field, Ph.D., M.S., Professor, College of Public Health, Department of Occupational and Environmental Health and Department of Epidemiology, University of Iowa, Iowa City, Iowa;
2. Naomi H. Harley, Ph.D., Research Professor, Department of Environmental Medicine, New York University School of Medicine, New York, New York; and
3. Jonathan Samet, M.D., Professor and Chairman, Department of Epidemiology, Bloomberg School of Public Health, The Johns Hopkins University, Baltimore, Maryland.

These experts collectively have knowledge of radon's physical and chemical properties, toxicokinetics, key health end points, mechanisms of action, human and animal exposure, and quantification of risk to humans. All reviewers were selected in conformity with the conditions for peer review specified in Section 104(I)(13) of the Comprehensive Environmental Response, Compensation, and Liability Act, as amended.

Scientists from the Agency for Toxic Substances and Disease Registry (ATSDR) have reviewed the peer reviewers' comments and determined which comments will be included in the profile. A listing of the peer reviewers' comments not incorporated in the profile, with a brief explanation of the rationale for their exclusion, exists as part of the administrative record for this compound.

The citation of the peer review panel should not be understood to imply its approval of the profile's final content. The responsibility for the content of this profile lies with the ATSDR.

This page is intentionally blank.

## CONTENTS

DISCLAIMER .....	ii
UPDATE STATEMENT .....	iii
FOREWORD .....	v
QUICK REFERENCE FOR HEALTH CARE PROVIDERS.....	vii
CONTRIBUTORS .....	xi
PEER REVIEW .....	xiii
CONTENTS.....	xv
LIST OF FIGURES .....	xix
LIST OF TABLES .....	xxi
1. PUBLIC HEALTH STATEMENT.....	1
1.1 WHAT IS RADON?.....	2
1.2 WHAT HAPPENS TO RADON WHEN IT ENTERS THE ENVIRONMENT?.....	3
1.3 HOW MIGHT I BE EXPOSED TO RADON AND RADON PROGENY?.....	3
1.4 HOW CAN RADON AND RADON PROGENY ENTER AND LEAVE MY BODY?.....	4
1.5 HOW CAN RADON AND RADON PROGENY AFFECT MY HEALTH?.....	4
1.6 HOW CAN RADON AND RADON PROGENY AFFECT CHILDREN?.....	5
1.7 HOW CAN FAMILIES REDUCE THE RISK OF EXPOSURE TO RADON AND RADON PROGENY?.....	5
1.8 IS THERE A MEDICAL TEST TO DETERMINE WHETHER I HAVE BEEN EXPOSED TO RADON AND RADON PROGENY?.....	5
1.9 WHAT RECOMMENDATIONS HAS THE FEDERAL GOVERNMENT MADE TO PROTECT HUMAN HEALTH?.....	5
1.10 WHERE CAN I GET MORE INFORMATION?.....	7
2. RELEVANCE TO PUBLIC HEALTH .....	9
2.1 BACKGROUND AND ENVIRONMENTAL EXPOSURES TO RADON IN THE UNITED STATES.....	9
2.2 SUMMARY OF HEALTH EFFECTS .....	10
2.3 MINIMAL RISK LEVELS (MRLs).....	12
3. HEALTH EFFECTS .....	13
3.1 INTRODUCTION .....	13
3.2 DISCUSSION OF HEALTH EFFECTS OF RADON BY ROUTE OF EXPOSURE.....	16
3.2.1 Inhalation Exposure .....	16
3.2.1.1 Death.....	25
3.2.1.2 Systemic Effects .....	26
3.2.1.3 Immunological and Lymphoreticular Effects.....	27
3.2.1.4 Neurological Effects.....	27
3.2.1.5 Reproductive Effects .....	28
3.2.1.6 Developmental Effects .....	28
3.2.1.7 Cancer.....	28
3.2.2 Oral Exposure.....	32
3.2.2.1 Death.....	32
3.2.2.2 Systemic Effects .....	32
3.2.2.3 Immunological and Lymphoreticular Effects.....	32
3.2.2.4 Neurological Effects.....	32
3.2.2.5 Reproductive Effects .....	32
3.2.2.6 Developmental Effects .....	32

3.2.2.7	Cancer.....	32
3.2.3	Dermal Exposure.....	33
3.2.3.1	Death.....	33
3.2.3.2	Systemic Effects .....	33
3.2.3.3	Immunological and Lymphoreticular Effects.....	33
3.2.3.4	Neurological Effects.....	33
3.2.3.5	Reproductive Effects .....	33
3.2.3.6	Developmental Effects .....	33
3.2.3.7	Cancer.....	33
3.3	GENOTOXICITY .....	33
3.4	TOXICOKINETICS .....	38
3.4.1	Absorption.....	39
3.4.1.1	Inhalation Exposure .....	39
3.4.1.2	Oral Exposure .....	42
3.4.1.3	Dermal Exposure .....	43
3.4.2	Distribution .....	44
3.4.2.1	Inhalation Exposure .....	44
3.4.2.2	Oral Exposure .....	45
3.4.2.3	Dermal Exposure .....	46
3.4.3	Metabolism.....	46
3.4.4	Elimination and Excretion.....	46
3.4.4.1	Inhalation Exposure .....	46
3.4.4.2	Oral Exposure .....	47
3.4.4.3	Dermal Exposure .....	48
3.4.4.4	Other Routes of Exposure.....	48
3.4.5	Physiologically Based Pharmacokinetic (PBPK)/Pharmacodynamic (PD) Models .....	48
3.5	MECHANISMS OF ACTION.....	71
3.5.1	Pharmacokinetic Mechanisms.....	71
3.5.2	Mechanisms of Toxicity.....	72
3.5.3	Animal-to-Human Extrapolations .....	75
3.6	TOXICITIES MEDIATED THROUGH THE NEUROENDOCRINE AXIS .....	76
3.7	CHILDREN'S SUSCEPTIBILITY .....	77
3.8	BIOMARKERS OF EXPOSURE AND EFFECT.....	78
3.8.1	Biomarkers Used to Identify or Quantify Exposure to Radon .....	79
3.8.2	Biomarkers Used to Characterize Effects Caused by Radon .....	80
3.9	INTERACTIONS WITH OTHER CHEMICALS.....	81
3.10	POPULATIONS THAT ARE UNUSUALLY SUSCEPTIBLE .....	83
3.11	METHODS FOR REDUCING TOXIC EFFECTS .....	84
3.11.1	Reducing Peak Absorption Following Exposure.....	84
3.11.2	Reducing Body Burden .....	84
3.11.3	Interfering with the Mechanism of Action for Toxic Effects .....	84
3.12	ADEQUACY OF THE DATABASE.....	85
3.12.1	Existing Information on Health Effects of Radon .....	85
3.12.2	Identification of Data Needs.....	87
3.12.3	Ongoing Studies .....	92
4.	CHEMICAL, PHYSICAL, AND RADIOLOGICAL INFORMATION.....	93
4.1	CHEMICAL IDENTITY .....	93
4.2	PHYSICAL, CHEMICAL, AND RADIOLOGICAL PROPERTIES.....	93



5. PRODUCTION, IMPORT/EXPORT, USE, AND DISPOSAL .....	101
5.1 PRODUCTION.....	101
5.2 IMPORT/EXPORT.....	102
5.3 USE.....	102
5.4 DISPOSAL .....	104
6. POTENTIAL FOR HUMAN EXPOSURE .....	105
6.1 OVERVIEW .....	105
6.2 RELEASES TO THE ENVIRONMENT .....	109
6.2.1 Air .....	110
6.2.2 Water.....	111
6.2.3 Soil .....	112
6.3 ENVIRONMENTAL FATE.....	112
6.3.1 Transport and Partitioning.....	112
6.3.2 Transformation and Degradation .....	115
6.3.2.1 Air .....	115
6.3.2.2 Water.....	116
6.3.2.3 Sediment and Soil .....	116
6.3.2.4 Other Media .....	116
6.4 LEVELS MONITORED OR ESTIMATED IN THE ENVIRONMENT .....	116
6.4.1 Air .....	116
6.4.2 Water.....	118
6.4.3 Sediment and Soil .....	120
6.4.4 Other Environmental Media.....	121
6.5 GENERAL POPULATION AND OCCUPATIONAL EXPOSURE.....	121
6.6 EXPOSURES OF CHILDREN .....	124
6.7 POPULATIONS WITH POTENTIALLY HIGH EXPOSURES .....	126
6.8 ADEQUACY OF THE DATABASE.....	126
6.8.1 Identification of Data Needs .....	127
6.8.2 Ongoing Studies .....	129
7. ANALYTICAL METHODS .....	131
7.1 BIOLOGICAL MATERIALS .....	131
7.2 ENVIRONMENTAL SAMPLES .....	133
7.3 ADEQUACY OF THE DATABASE.....	137
7.3.1 Identification of Data Needs .....	140
7.3.2 Ongoing Studies .....	140
8. REGULATIONS, ADVISORIES, AND GUIDELINES.....	141
9. REFERENCES .....	147
10. GLOSSARY .....	209

APPENDICES

A. ATSDR MINIMAL RISK LEVELS AND WORKSHEETS ..... A-1

B. USER'S GUIDE ..... B-1

C. ACRONYMS, ABBREVIATIONS, AND SYMBOLS..... C-1

D. OVERVIEW OF BASIC RADIATION PHYSICS, CHEMISTRY, AND BIOLOGY ..... D-1

E. INDEX..... E-1

## LIST OF FIGURES

3-1. Conceptual Representation of a Physiologically Based Pharmacokinetic (PBPK) Model for a Hypothetical Chemical Substance.....	51
3-2. Compartment Model to Represent Particle Deposition and Time-Dependent Particle Transport in the Respiratory Tract.....	54
3-3. Reaction of Gases or Vapors at Various Levels of the Gas-Blood Interface.....	57
3-4. The Human Respiratory Tract Model: Absorption into Blood.....	62
3-5. Simplified Version of the Human Respiratory Tract Model (HRTM) .....	64
3-6. Schematic Diagram of the NAS (1999b) PBPK Model Developed to Describe the Fate of Radon within Systemic Tissues.....	66
3-7. Khursheed (2000) PBPK Model for Inhalation and Ingestion of Radon Gas.....	69
3-8. Conceptual Model of the Biology Leading From Alpha Irradiation of Cells by Radon and Radon Progeny to Tumor Development.....	74
3-9. Existing Information on Health Effects of Radon .....	86
4-1. <sup>238</sup> U Decay Series Showing Sources and Decay Products.....	95
4-2. <sup>232</sup> Th Decay Series Showing Sources and Decay Products .....	98
4-3. <sup>235</sup> U Decay Series Showing Sources and Decay Products.....	100
6-1. Frequency of NPL Sites with Radon Contamination.....	106

This page is intentionally blank.

## LIST OF TABLES

3-1. Selected Characteristics and Exposure Data for Individual Miner Cohort Studies Included in the Analysis of Pooled Data from the Individual Studies, and Lung Cancer Mortality Rates and Relative Risks by Cumulative WLM for Pooled Data.....	20
3-2. Selected Results from Analysis of Pooled Data from 11 Mining Cohorts <sup>a</sup> , Based on Deciles of Case Exposures That Were Each Under 100 WLM.....	21
3-3. Selected Characteristics of Study Subjects, Exposure Estimates, and Odds Ratios for Lung Cancer from Combined Analysis of Seven North American Residential Case-control Studies (Using a 5–30-year Exposure Time Window).....	23
3-4. Relative Risk and Excess Relative Risk of Lung Cancer by Radon Level in Homes 5–34 Years Previously, Estimated from the Pooled Data for 13 European Residential Case-control Studies.....	24
3-5. Genotoxicity of Radon and Radon Progeny <i>In Vivo</i> .....	34
3-6. Genotoxicity of Radon and Radon Progeny <i>In Vitro</i> .....	35
3-7. Reference Respiratory Values for a General Caucasian Population at Different Levels of Activity.....	55
3-8. Reference Values of Parameters for the Compartment Model to Represent Time-dependent Particle Transport from the Human Respiratory Tract.....	59
3-9. Parameters in the NAS (1999b) PBPK Model .....	68
3-10. Parameters in Khursheed (2000) PBPK Model for Radon Gas.....	70
4-1. Chemical Identity of Radon.....	94
4-2. Physical and Chemical Properties of Radon.....	96
4-3. Radioactive Properties of <sup>222</sup> Rn and Its Short-lived Progeny .....	99
7-1. Analytical Methods for Determining Radon Progeny in Biological Samples.....	132
7-2. Analytical Methods for Determining Radon and Progeny in Environmental Samples .....	138
8-1. Regulations, Advisories, and Guidelines Applicable to Radon.....	143

This page is intentionally blank.

## 1. PUBLIC HEALTH STATEMENT

This public health statement tells you about radon and the effects of exposure to it.

The Environmental Protection Agency (EPA) identifies the most serious hazardous waste sites in the nation. These sites are then placed on the National Priorities List (NPL) and are targeted for long-term federal clean-up activities. Radon has been found in at least 34 of the 1,699 current or former NPL sites. Although the total number of NPL sites evaluated for this substance is not known, the possibility exists that the number of sites at which radon is found may increase in the future as more sites are evaluated. This information is important because these sites may be sources of exposure and exposure to this substance may harm you.

When a substance is released from a large area, such as an industrial plant, or from a container, such as a drum or bottle, it enters the environment. This release does not always lead to exposure. You are exposed to a substance only when you come in contact with it. You may be exposed by breathing, eating, or drinking the substance, or by skin contact. External exposure to radiation may occur from natural or man-made sources. Naturally occurring sources of radiation are cosmic radiation from space or radioactive materials in soil or building materials. Man-made sources of radioactive materials are found in consumer products, industrial equipment, atom bomb fallout, and to a smaller extent from hospital waste and nuclear reactors.

If you are exposed to radon many factors will determine whether you will be harmed. These factors include the dose (how much), the duration (how long), and how you come in contact with it. You must also consider any other chemicals you are exposed to and your age, sex, diet, family traits, lifestyle, and state of health.

## 1. PUBLIC HEALTH STATEMENT

## 1.1 WHAT IS RADON?

<b>Radioactive gas</b>	<p>Radon (Rn) is a naturally occurring colorless, odorless, tasteless radioactive gas that occurs in different forms with the same atomic number but different atomic mass, called isotopes.</p> <p>As radon undergoes radioactive decay, radiation is released predominantly by high-energy alpha particle emissions, which are the source of health concerns.</p> <p>Radon is measured in terms of its activity (curies or becquerels). Both the curie (Ci) and the becquerel (Bq) tell us how much a radioactive material decays every second (1 Ci = 37 billion Bq = 37 billion decays per second).</p>
<b>Natural product of the environment</b>	<p>Radon isotopes are formed naturally through the radioactive decay of uranium or thorium.</p> <p>Uranium and thorium (solids) are found in rocks, soil, air, and water. Uranium and thorium decay to other elements such as radium (a solid), which in turn decays into radon gas.</p> <p>Uranium and thorium have been present since the earth was formed and have very long half-lives (4.5 billion years for uranium and 14 billion years for thorium). The half-life is the time it takes for half of the atoms of a radionuclide to undergo radioactive decay and change it into a different isotope. Uranium, thorium, radium, and thus radon, will continue to exist indefinitely at about the same levels as they do now.</p> <p>Radon has no commercial uses.</p>
<b>Exists in various forms called isotopes and decays to other radioactive isotopes</b>	<p>The most common radon isotope is radon-222 (<math>^{222}\text{Rn}</math>), which is part of the uranium decay chain.</p> <p>An atom of <math>^{222}\text{Rn}</math> gives off an alpha particle (which is the size of a helium atom without electrons), transforming into an atom of polonium-218 (<math>^{218}\text{Po}</math>), which later gives off an alpha particle of its own, transforming into an atom of radioactive lead (<math>^{214}\text{Pb}</math>). This process is called radioactive decay and radon decay products are called radon progeny or radon daughters. The final step in the radioactive decay of radon progeny results in the formation of an atom of stable lead which is not radioactive.</p> <p>The half-life of <math>^{222}\text{Rn}</math> is 3.82 days. Some of the radon decay products have the following half-lives: <math>^{218}\text{Po}</math> is 3.05 minutes; <math>^{214}\text{Pb}</math> is 26.8 minutes; and <math>^{210}\text{Pb}</math> is 22.3 years.</p>

More information about the properties of radon can be found in Chapters 4, 5, and 6.



## 1. PUBLIC HEALTH STATEMENT

**1.2 WHAT HAPPENS TO RADON WHEN IT ENTERS THE ENVIRONMENT?**

<b>Moves to air, groundwater, and surface water</b>	<p>Radon gas in the rocks and soil can move to air, groundwater, and surface water.</p> <p>Decay products of <math>^{222}\text{Rn}</math>, such as <math>^{218}\text{Po}</math> and <math>^{214}\text{Pb}</math>, are solids that can attach to particles in the air and be transported this way in the atmosphere. They can be deposited on land or water by settling or by rain.</p> <p>Radon will undergo radioactive decay in the environment.</p>
---	--

For more information on radon in the environment, see Chapter 6.

**1.3 HOW MIGHT I BE EXPOSED TO RADON AND RADON PROGENY?**

<b>Air</b>	<p>Since radon progeny are often attached to dust, you are exposed to them primarily by breathing them in. They are present in nearly all air. Depending on the size of the particles, the radioactive particulates can deposit in your lungs and impart a radiation dose to the lung tissue.</p> <p>Background levels of radon in outdoor air are generally quite low, but can vary based on location and the underlying soil geology.</p> <p>In indoor locations, such as homes, schools, or office buildings, levels of radon and radon progeny are generally higher than outdoor levels and may be particularly high in some buildings, especially in newer construction that is more energy-efficient.</p> <p>Cracks in the foundation or basement of your home may allow increased amounts of radon to move into your home. Also, radon is heavier than ambient air, and therefore, the concentrations of radon are generally higher in the lower levels or basement of the homes.</p>
<b>Water</b>	<p>You may be exposed to radon and radon progeny by coming into contact with radon-contaminated surface or groundwater or by drinking water from wells that contain radon.</p> <p>Radon in water can become airborne; it is estimated that 1/1,000<sup>th</sup> of the radon in water may become airborne during indoor activities that use water.</p>

Further information on how you might be exposed to radon and radon progeny is given in Chapter 6.

1. PUBLIC HEALTH STATEMENT

**1.4 HOW CAN RADON AND RADON PROGENY ENTER AND LEAVE MY BODY?**

<p><b>When they are inhaled or swallowed</b></p>	<p>Radon and its radioactive progeny can enter your body when you breathe them in or swallow them.</p> <p>Most of the inhaled radon gas is breathed out again.</p> <p>Some of the radon progeny, both unattached and, attached to particles, may remain in your lungs and undergo radioactive decay. The radiation released during this process passes into lung tissue and can cause lung damage.</p> <p>Some of the radon that you swallow with drinking water passes through the walls of your stomach and intestine.</p> <p>After radon enters your blood stream most of the radon quickly moves to the lungs where you breathe most of it out.</p> <p>Radon that is not breathed out goes to other organs and fat tissue where it may remain and undergo decay.</p>
--	--

Further information on how radon and radon progeny enter and leave the body is given in Chapter 3.

**1.5 HOW CAN RADON AND RADON PROGENY AFFECT MY HEALTH?**

Scientists use many tests to protect the public from harmful effects of toxic chemicals and to find ways for treating persons who have been harmed.

<p><b>Lung cancer</b></p>	<p>Many scientists believe that long-term exposure to elevated levels of radon and radon progeny in air increases your chance of getting lung cancer.</p> <p>The greater your exposure to radon, the greater your chance of developing lung cancer.</p> <p>Smoking cigarettes greatly increases your chance of developing lung cancer if you are exposed to radon and radon progeny at the same levels as people who do not smoke. Because tobacco is naturally sticky, many of the radon decay products actually stick to tobacco products. Therefore, when tobacco is smoked or otherwise used, these radon products may also enter your system. Breathing in other substances that cause lung cancer may also increase your chance of developing lung cancer from exposure to radon progeny.</p>
---------------------------	---

More information on the health effects of radon and radon progeny is presented in Chapters 2 and 3.

## 1. PUBLIC HEALTH STATEMENT

**1.6 HOW CAN RADON AND RADON PROGENY AFFECT CHILDREN?**

This section discusses potential health effects in humans from exposures during the period from conception to maturity at 18 years of age.

<b>Differences between children and adults</b>	Smaller lungs and faster breathing rates in children may result in higher estimated radiation doses to the lungs of children relative to adults. However, limited information from children employed as miners in China do not provide evidence of increased susceptibility to the effects of exposure to radon.
--	--

**1.7 HOW CAN FAMILIES REDUCE THE RISK OF EXPOSURE TO RADON AND RADON PROGENY?**

<b>Reduce indoor exposure levels</b>	Indoor radon levels can be reduced by methods that include the sealing of surfaces between the ground and the building and installation of ventilation systems that route air from materials under the building to outdoor air. Certified radon mitigation experts can be located by contacting your state health or environmental program.
--------------------------------------	---

**1.8 IS THERE A MEDICAL TEST TO DETERMINE WHETHER I HAVE BEEN EXPOSED TO RADON AND RADON PROGENY?**

<b>Radon decay products in urine and in lung and bone tissues</b>	Radon in human tissues is not detectable by routine medical testing.  Some radon decay products can be detected in urine and in lung and bone tissue. Tests for these products are not generally available to the public and are of limited value since they cannot be used to accurately determine how much radon you were exposed to, nor can they be used to predict whether you will develop harmful health effects.
---	--

Further information on how radon and radon progeny can be measured in exposed humans is presented in Chapters 3 and 7.

**1.9 WHAT RECOMMENDATIONS HAS THE FEDERAL GOVERNMENT MADE TO PROTECT HUMAN HEALTH?**

The federal government develops regulations and recommendations to protect public health. Regulations can be enforced by law. Federal agencies that develop regulations for toxic substances include the Environmental Protection Agency (EPA), the Occupational Safety and

## 1. PUBLIC HEALTH STATEMENT

Health Administration (OSHA), the Food and Drug Administration (FDA), and the U.S. Nuclear Regulatory Commission (USNRC).

Recommendations provide valuable guidelines to protect public health but cannot be enforced by law. Federal organizations that develop recommendations for toxic substances include the Agency for Toxic Substances and Disease Registry (ATSDR), the National Institute for Occupational Safety and Health (NIOSH), and the FDA.

Regulations and recommendations can be expressed as “not-to-exceed” levels, that is, levels of a toxic substance in air, water, soil, or food that do not exceed a critical value that is usually based on levels that affect animals; they are then adjusted to levels that will help protect humans. Sometimes these not-to-exceed levels differ among federal organizations because they used different exposure times (an 8-hour workday, a 24-hour day, or a work-year), different animal studies, or other factors.

Recommendations and regulations are also updated periodically as more information becomes available. For the most current information, check with the federal agency or organization that provides it.

<b>Air</b>	<p>EPA recommends fixing your home if measured indoor levels of radon are 4 or more pCi per liter (pCi/L) of air. EPA also notes that radon levels less than 4 pCi/L still pose a health risk and can be reduced in many cases. The EPA recommends using a certified radon mitigation specialist if indoor radon levels need to be reduced to ensure that appropriate methods are used to reduce radon levels.</p> <p>The Mine Safety and Health Administration (MSHA) has adopted an exposure limit of 4 Working Level Months (WLM) per year for people who work in mines (WLMs basically combine the concentration of radon in mine air with length of exposure inside the mine).</p> <p>The Nuclear Regulatory Commission published a table of allowable exposure to radon by workers and allowable releases of radon to the environment by its licensees.</p>
<b>Water</b>	<p>In the 1990s, EPA introduced a proposal to limit levels of radon in drinking water. As of August 2008 the proposal had not been adopted as a regulation.</p>

## 1. PUBLIC HEALTH STATEMENT

Additional information on governmental regulations regarding radon and radon progeny can be found in Chapter 8.

**1.10 WHERE CAN I GET MORE INFORMATION?**

If you have any more questions or concerns, please contact your community or state health or environmental quality department, or contact ATSDR at the address and phone number below.

ATSDR can also tell you the location of occupational and environmental health clinics. These clinics specialize in recognizing, evaluating, and treating illnesses that result from exposure to hazardous substances.

Toxicological profiles are also available on-line at [www.atsdr.cdc.gov](http://www.atsdr.cdc.gov) and on CD-ROM. You may request a copy of the ATSDR ToxProfiles™ CD-ROM by calling the toll-free information and technical assistance number at 1-800-CDCINFO (1-800-232-4636), by e-mail at [cdcinfo@cdc.gov](mailto:cdcinfo@cdc.gov), or by writing to:

Agency for Toxic Substances and Disease Registry  
Division of Toxicology and Environmental Medicine  
1600 Clifton Road NE  
Mailstop F-32  
Atlanta, GA 30333  
Fax: 1-770-488-4178

Organizations for-profit may request copies of final Toxicological Profiles from the following:

National Technical Information Service (NTIS)  
5285 Port Royal Road  
Springfield, VA 22161  
Phone: 1-800-553-6847 or 1-703-605-6000  
Web site: <http://www.ntis.gov/>

1. PUBLIC HEALTH STATEMENT

This page is intentionally blank.

## 2. RELEVANCE TO PUBLIC HEALTH

### 2.1 BACKGROUND AND ENVIRONMENTAL EXPOSURES TO RADON IN THE UNITED STATES

Radon is a noble gas formed from the natural radioactive decay of uranium (U) and thorium (Th), natural components of the earth's crust, which decay to radium (Ra) and then to radon (Rn). Decay chains include  $^{226}\text{Ra}$  and  $^{222}\text{Rn}$  for  $^{238}\text{U}$ ;  $^{223}\text{Ra}$  and  $^{219}\text{Rn}$  for  $^{235}\text{U}$ ; and  $^{224}\text{Ra}$  and  $^{220}\text{Rn}$  for  $^{232}\text{Th}$ . As radium decays, radon is formed and released into pores in the soil. Fissures and pores in the substrate allow the radon to migrate to the surface, where it can be released to the air. Radon may also be released into surface and groundwater from the surrounding soil. Though radon is chemically inert, it decays by normal radioactive processes to other radon progeny. The alpha emitting progeny of radon (primarily polonium isotopes  $^{218}\text{Po}$  and  $^{214}\text{Po}$ ) are the ones that are most likely to damage the lungs and eventually cause cancer.

Radon has few significant commercial uses. While radiation therapy is a potential use, there is no conclusive evidence to support the effectiveness of using radon in this capacity. Radon may be useful in helping to detect seismic activity, as a tracer for leak detection, for flow rate measurements, in radiography, and is used in some chemical laboratory research. It can also be used in the exploration of petroleum or uranium, as a tracer in the identification of NAPL (non-aqueous phase liquid) contamination of the subsurface, and in atmospheric transport studies.

The primary source of radon is its precursors in soil where it is formed and released. On a global scale, it is estimated that 2,400 million curies of radon are released from soil annually. Groundwater provides a secondary source of radon, with an estimated 500 million curies released globally per year. Additional sources of radon include surface water, metal mines (uranium, phosphorus, tin, silver, gold, etc.), coal residues and combustion products, natural gas, and building materials. Fishbein estimates global radon releases from oceans, phosphate residues, uranium mill tailings, coal residues, natural gas emissions, coal combustion, and human exhalation at 34, 3, 2, 0.02, 0.01, 0.009, and 0.00001 millions of curies per year, respectively. Geology, soil moisture conditions, and meteorological conditions can affect the amount of radon released from soil.

The primary pathway for human exposure to radon is inhalation, both indoors and outdoors. Ambient outdoor levels are the result of radon emanating from soil or released from coal, oil, or gas power plants, which can vary temporally and spatially. Outdoor radon levels are typically much lower than indoor

## 2. RELEVANCE TO PUBLIC HEALTH

radon levels. Soil gas intrusion into buildings accounts for the majority of indoor radon. However, indoor radon also can originate from water used for domestic purposes, outdoor air, and building materials.

While certain professions pose a higher risk of occupational exposure to radon, exposure to high concentrations can occur in any location with geologic radon sources. Higher risk of occupational exposure can occur through employment at underground mines (uranium, phosphorus, tin, silver, gold, hard rock, and vanadium). A high exposure risk is also present for employees of radioactive contaminated sites, nuclear waste repositories, natural caverns, phosphate fertilizer plants, oil refineries, utility and subway tunnels, excavators, power plants, natural gas and oil piping facilities, health mines and spas, fish hatcheries, and hospitals. Higher exposure risks are also present for farmers, radon mitigation professionals, and scientists, although exposure to local radon sources can occur in any occupation.

### 2.2 SUMMARY OF HEALTH EFFECTS

The most compelling evidence of radon-induced health effects in humans derives from numerous studies of underground miners, particularly uranium miners exposed in the middle part of the twentieth century in the United States and several European countries. Although these cohort mortality studies typically involved long term estimates of radon exposure levels based on available measurements in the working environment and inherent uncertainty due to confounding factors such as smoking status and coexposure to known or suspected carcinogens (diesel exhaust, arsenic, and silica dust), the results nevertheless consistently demonstrate increased risk of lung cancer with increasing exposure to radon in the working environment. The mining cohorts have been followed for several decades or more. Continued follow-up and refined assessments of the most widely-studied mining cohorts have resulted in improved exposure estimates and more complete categorization of individuals according to cause of death, mining history, and smoking status. Assessments did not necessarily include adjustments for potential confounding exposures to arsenic, silica dust, and/or diesel exhaust, although considerations for arsenic and silica dust were made in several studies. One in-depth analysis included assessment of results pooled from 11 of the most widely-studied mining cohorts using the most recent and comprehensive follow-up results available at the time for each individual cohort. The results provide evidence for increasing risk of lung cancer mortality with increasing cumulative exposure to radon and its progeny.

Reported associations between radon and lung cancer in the mining cohorts raised concern regarding the potential health effects of radon in homes, particularly at levels lower than those experienced in



## 2. RELEVANCE TO PUBLIC HEALTH

mining cohorts. Numerous residential case-control studies of lung cancer have been performed in the United States and in many other countries, including Canada, China, Finland, Germany, Sweden, and the United Kingdom. Some of these studies reported positive or weakly positive associations between lung cancer risk and residential radon concentrations, whereas significant associations were not observed in others. One recent residential case-control study reported a statistically significant negative association (i.e., decreasing cancer risk in association with increasing radon exposure). The individual residential case-control studies typically had insufficiently large numbers of cases and controls and limited statistical power to identify a significant association between radon exposure and an adverse health outcome such as lung cancer. In order to increase the statistical power of individual residential case-control studies, the investigators involved in most of the studies pooled the results of the multiple studies carried out. Assessments of pooled data from major residential case-control studies include a combined analysis of 7 North American case-control studies and a combined analysis of 13 European case-control studies. Independent results of these analyses provide convincing evidence of an association between residential radon and lung cancer risk as demonstrated by increased lung cancer risk with increasing cumulative exposure. An overall pooling of the North American and European case-control studies is in progress.

Excess mortality from noncancer diseases reported in some of the mining cohorts include all noncancer respiratory diseases, pneumoconioses, emphysema, interstitial pneumonitis, other (unspecified) chronic obstructive respiratory diseases, and tuberculosis. However, potential confounding factors such as exposure to other respiratory toxicants, smoking history, and work experience were likely major contributors to mortalities from noncancer respiratory diseases. Alterations in respiratory function in U.S. uranium miners have been reported. Analyses among U.S. uranium miners indicated a loss of pulmonary function associated with increasing cumulative exposure and with the duration of underground mining. Evaluations of these respiratory end points did not permit assessment of the effects of each of the other possible mine pollutants, such as ore dust, silica, or diesel engine exhaust.

Information regarding radon-induced lung cancer in animals exposed to radon and its progeny at concentrations considered relevant to human health includes significantly increased incidences of lung tumors in rats repeatedly exposed to radon and its progeny at cumulative exposures as low as 20–50 Working Level Months (WLM). These results are consistent with the demonstrated associations between lung cancer risk and exposure to radon and radon progeny in occupationally-exposed miners and residentially-exposed individuals.

## 2. RELEVANCE TO PUBLIC HEALTH

**2.3 MINIMAL RISK LEVELS (MRLs)***Inhalation MRLs*

No acute-, intermediate-, or chronic-duration inhalation MRLs were derived for radon due to a lack of suitable human or animal data regarding health effects following inhalation exposure to radon and its progeny. The strongest evidence for radon exposure-response and radiation dose-response relationships in humans is for lung cancer; however, cancer is not an appropriate end point for MRL derivation. Nonneoplastic lesions have been reported in animals exposed to radon and its progeny for acute, intermediate, and chronic exposure durations; however, these effects were consistently observed only at lethal or near lethal exposure levels, which were several orders of magnitude higher than those associated with lung cancer in chronically-exposed humans.

*Oral MRLs*

No acute-, intermediate-, or chronic-duration oral MRLs were derived for radon due to a lack of suitable human or animal data regarding health effects following oral exposure to radon and its progeny. Available human data are limited. In an ecological study, radon levels were measured in 2,000 public and private wells in 14 counties in Maine (Hess et al. 1983). The county averages were compared to cancer rate by county to determine any degree of correlation. Significant correlation was reported for all lung cancer and all cancers combined, when both sexes were combined, and for lung tumors in females. Confounding factors (e.g., smoking) were not considered in this analysis. In addition, exposure to radon in these water supplies could have been by the inhalation route as well as the oral route. No significant associations were observed between cases of bladder or kidney cancer, relative to controls, where mean concentrations of radon in the drinking water were 170, 140, and 130 Bq/L in bladder cancer cases, kidney cancer cases, and controls, respectively (Kurttio et al. 2006).

### 3. HEALTH EFFECTS

#### 3.1 INTRODUCTION

The primary purpose of this chapter is to provide public health officials, physicians, toxicologists, and other interested individuals and groups with an overall perspective on the toxicology of radon. It contains descriptions and evaluations of toxicological studies and epidemiological investigations and provides conclusions, where possible, on the relevance of toxicity and toxicokinetic data to public health.

A glossary and list of acronyms, abbreviations, and symbols can be found at the end of this profile.

Radon (Rn) is an inert noble gas that does not interact chemically with other elements. All of the isotopes of radon are radioactive and evaluation of the adverse health effects due to exposure to radon requires additional consideration of the effects of radiation. Radioactive elements are those that undergo spontaneous transformation (decay) in which energy is released (emitted) either in the form of particles, such as alpha and beta particles, or photons, such as gamma or x-rays. This disintegration, or decay, results in the formation of new elements, some of which may themselves be radioactive, in which case, they will also decay. The process continues until a stable (nonradioactive) state is reached. The isotopes of radon encountered in nature ( $^{219}\text{Rn}$ ,  $^{220}\text{Rn}$ , and  $^{222}\text{Rn}$ ) are part of long decay chains starting with isotopes of uranium (U) or thorium (Th), more precisely  $^{235}\text{U}$ ,  $^{232}\text{Th}$ , and  $^{238}\text{U}$ , respectively, and ending with stable lead (Pb). The intermediates between radon and stable lead are termed radon daughters or radon progeny (see Chapter 4, Figures 4-1, 4-2, and 4-3 for radioactive decay schemes of  $^{235}\text{U}$ ,  $^{232}\text{Th}$ , and  $^{238}\text{U}$ , respectively). The isotope  $^{222}\text{Rn}$  is a direct decay product of radium-226 ( $^{226}\text{Ra}$ ), which is part of the decay series that begins with uranium-238 ( $^{238}\text{U}$ ). Thorium-230 and -234 ( $^{230}\text{Th}$  and  $^{234}\text{Th}$ ) are also part of this decay series. Other isotopes of radon, such as  $^{219}\text{Rn}$  and  $^{220}\text{Rn}$ , are formed in other radioactive decay series. However,  $^{219}\text{Rn}$  usually is not considered in the evaluation of radon-induced health effects because it is not abundant in the environment ( $^{219}\text{Rn}$  is part of the decay chain of  $^{235}\text{U}$ , a relatively rare isotope) and has an extremely short half-life (4 seconds). The isotope  $^{220}\text{Rn}$  has usually not been considered when evaluating radon-related health effects, although many recent assessments have attempted to include measurements of  $^{220}\text{Rn}$  as well as  $^{222}\text{Rn}$ . While the average rate of production of  $^{220}\text{Rn}$  is about the same as  $^{222}\text{Rn}$ , the amount of  $^{220}\text{Rn}$  entering the environment is much less than that of  $^{222}\text{Rn}$  because of the short half-life of  $^{220}\text{Rn}$  (56 seconds). All discussions of radon in the text refer to  $^{222}\text{Rn}$  unless otherwise indicated.

## 3. HEALTH EFFECTS

The decay rate or activity of radioactive elements has traditionally been specified in curies (Ci). The activity defines the number of radioactive transformations (disintegrations) of a radionuclide over unit time. The curie is the amount of radioactive material in which 37 billion disintegrations (decay events) occur each second ( $3.7 \times 10^{10}$  transformations per second). In discussing radon, a smaller unit, the picocurie (pCi), is used, where  $1 \text{ pCi} = 1 \times 10^{-12} \text{ Ci}$ . In international usage, the S.I. unit (the International System of Units) for activity is the Becquerel (Bq), which is the amount of material in which one atom disintegrates each second (1 Bq is approximately 27 pCi). The activity concentration of radon or any radionuclide in air is typically expressed in units of pCi/L or Bq/m<sup>3</sup> of air. One pCi/L is equivalent to 37 Bq/m<sup>3</sup>. The activity concentration is typically a description of the concentration of radioactive material in air or water. The product of concentration and exposure time equals exposure; models are used to estimate a radiation dose to tissue from exposure. Since the isotopes continue to decay for some time, and some excretion occurs, the term dose refers specifically to the amount of radiant energy absorbed in a particular tissue or organ and is expressed in rad (or grays).

When radon and its progeny decay, they emit alpha and beta particles as well as gamma radiation. The health hazard from radon does not come primarily from radon itself, but rather from its radioactive progeny (see Chapter 4 for more information on the chemical and physical properties of radon). When radium transforms to radon, the alpha particles are neutralized to form stable helium (He); the charged decay product particles attach to aerosol particles. Radon progeny are similarly charged, readily aggregate, form clusters, and attach to dust particles in air. The main health problems arise when attached and unattached fractions of radon progeny are inhaled, deposit in the airway (particularly the tracheobronchial tree), and bombard nearby cells with alpha particles as the atoms transform through the decay chain. These alpha particles can deliver a large localized radiation dose. Exposures to radon gas are accompanied by exposure to radon progeny, although the exact mix of radon and progeny are determined by several physical-chemical and environmental factors. In this toxicological profile, unless indicated otherwise, *exposure to radon* refers to exposure to the mixture of radon and progeny.

Because it is not feasible to routinely measure the activities of individual radon progeny in the environment, a unit termed the "Working Level" (WL) is used for the purpose of quantifying exposure to radon and its radioactive progeny. The WL unit is a measure of the amount of alpha radiation emitted from the short-lived progeny of radon. As applied to exposures to <sup>222</sup>Rn, this encompasses the decay series, <sup>222</sup>Rn( $\alpha$ ) → <sup>218</sup>Po( $\alpha$ ) → <sup>214</sup>Pb → <sup>214</sup>Bi → <sup>214</sup>Po( $\alpha$ ) → <sup>210</sup>Pb, and represents any combination of the short-lived progeny of radon. Working Level (WL) means the concentration of short-lived radon progeny

## 3. HEALTH EFFECTS

in 1 L of air that will release  $1.3 \times 10^5$  million electron volts (MeV) of alpha energy during decay. One WL is equivalent to the potential alpha energy of  $2.08 \times 10^5$  joules in 1 cubic meter of air ( $\text{J}/\text{m}^3$ ).

To convert between units of  $^{222}\text{Rn}$  radioactivity (pCi or Bq) and the potential alpha energy concentration (WL or  $\text{J}/\text{m}^3$ ), the equilibrium between radon gas and its progeny must be known or assumed (see Chapter 10 for conversion formula). When radon is in equilibrium with its progeny (i.e., when each of the short-lived radon progeny is present at the same activity concentration in air as  $^{222}\text{Rn}$ ), each pCi of radon in air will give rise to (almost precisely) 0.01WL (EPA 2003). However, when removal processes other than radioactive decay are operative, such as with room air ventilation, the concentration of short-lived progeny will be less than the equilibrium amount. In such cases, an equilibrium factor (F) is applied. The National Research Council Committee on Health Risks of Exposure to Radon (BEIR VI) assumes 40% equilibrium ( $F=0.4$ ) between radon and radon progeny in the home (NAS 1999a), in which case, 1 pCi ( $37 \text{ Bq}/\text{m}^3$ ) of radon in the air is approximately equivalent to 0.004 WL of radon progeny.

The unit of measurement used to describe cumulative human exposure to radon progeny in mines is the Working Level Month (WLM). It is the product of the average concentration in WL and the exposure time in months. One WLM is defined as exposure at a concentration of 1 WL for a period of 1 working month (WM). A working month is assumed to be 170 hours. The S.I. unit for WLM is  $\text{J}\text{-hour}/\text{m}^3$ ;  $1 \text{ WLM} = 3.6 \times 10^3 \text{ J}\text{-hours}/\text{m}^3$ .

Measurements in WLM can be made using special equipment that measures the total alpha emission of short-lived radon progeny. However, measurements in homes are typically made for radon gas and are expressed in  $\text{Bq}/\text{m}^3$  or pCi/L of radon gas. To convert from residential exposures expressed in pCi/L, it is considered that 70% of a person's time is spent indoors and that 1 pCi/L of radon in the indoor air is equivalent to 0.004 WL of radon progeny (EPA 2003; NAS 1999a). These conditions result in the following relationship:

$$1 \text{ pCi}/\text{L} \times 0.004 \text{ WL}/\text{pCi} \times 0.7 \times (8,760 \text{ hours}/\text{WL}\text{-year} \div 170 \text{ hours}/\text{WL}\text{-M}) = 0.144 \text{ WL}\text{-M}/\text{year}$$

Because 1 pCi/L is equivalent to  $37 \text{ Bq}/\text{m}^3$ , a residential exposure scenario using equivalent assumptions to those described above results in the same cumulative exposure to radon progeny (0.114 WLM/year).

As discussed in detail in Section 3.2.1 (Inhalation Exposure), lung cancer is the toxicity concern following long-term exposure to radon and radon progeny. The high-energy alpha emissions from radon

### 3. HEALTH EFFECTS

progeny, deposited predominantly in the tracheobronchial tree, and to a lesser extent in the lung, are the major source of toxicity concern. As shown in Figure 4-1, the radiological half-life for radon ( $^{222}\text{Rn}$ ) is 3.8 days. The radioactive decay of radon to  $^{218}\text{Po}$  (radiological half-life=3.05 minutes) is accompanied by the release of high-energy (5.5 MeV) alpha particles; decay of  $^{218}\text{Po}$  to lead-214 ( $^{214}\text{Pb}$ ; radiological half-life=26.8 minutes) also releases high-energy (6.0 MeV) alpha particles. Subsequent radioactive decay to bismuth-214 ( $^{214}\text{Bi}$ ; radiological half-life=19.7 minutes) and  $^{214}\text{Po}$  involve release of beta and gamma radiation, which are of sufficiently low energy and long range as to be considered of little relative toxicity concern to nearby cells. The decay of  $^{214}\text{Po}$  via release of high-energy (7.69 MeV) alpha particles occurs so rapidly (radiological half-life= $1.6 \times 10^{-4}$  seconds) that, in radiation dose modeling, these alpha emissions are generally attributed to  $^{214}\text{Bi}$  decay (i.e., the rate of decay of  $^{214}\text{Bi}$  is essentially equal to the rate of formation of  $^{210}\text{Pb}$  due to the essentially instantaneous decay of  $^{214}\text{Po}$  from  $^{214}\text{Bi}$ ). The subsequently-formed radioactive radon progeny ( $^{210}\text{Pb}$ ,  $^{210}\text{Bi}$ , and  $^{210}\text{Po}$  in respective order of decay) are not considered to make significant contributions to respiratory tract toxicity (relative to the short-lived progeny). This is, in large part, because the radiological half-life associated with the decay of  $^{210}\text{Pb}$  is 21 years, which is sufficiently long that biological clearance mechanisms limit the radiation dose attributed to it and the other progeny. Therefore, the radon progeny of primary toxicity concern are  $^{218}\text{Po}$  and  $^{214}\text{Po}$  (due to the rapid decay of these alpha emitters).

## 3.2 DISCUSSION OF HEALTH EFFECTS OF RADON BY ROUTE OF EXPOSURE

To help public health professionals and others address the needs of persons living or working near hazardous waste sites, the information in this section is organized first by route of exposure (inhalation, oral, and dermal) and then by health effect (death, systemic, immunological, neurological, reproductive, developmental, genotoxic, and carcinogenic effects). These data are discussed in terms of three exposure periods: acute (14 days or less), intermediate (15–364 days), and chronic (365 days or more).

A User's Guide has been provided at the end of this profile (see Appendix B).

### 3.2.1 Inhalation Exposure

Epidemiological studies designed to assess human health risks from exposure to radon mainly consist of: (1) cohort mortality studies of underground miners that investigated possible associations between lung cancer and individual exposure to radon or radon progeny, (2) residential case-control studies that investigated possible associations between lung cancer cases and residential radon levels using estimates of individual exposure, and (3) ecological studies that investigated possible associations between rates of

### 3. HEALTH EFFECTS

selected diseases within a geographic population and some measure of average radon levels within a defined geographic region.

Compelling evidence of radon-induced health effects in humans derives from numerous studies of underground miners, particularly uranium miners exposed beginning in the middle part of the twentieth century in the United States and several European countries. Although these cohort mortality studies typically involved rather crude estimates of radon exposure levels in the working environment and inherent uncertainty due to confounding factors such as smoking status and coexposure to known or suspected human carcinogens (diesel exhaust, arsenic, and silica dust), the results nevertheless consistently demonstrate increased risk of lung cancer with increasing exposure to radon in the working environment. These results are consistent across the various individual studies of mining cohorts and with analyses of pooled data from multiple cohorts.

Reported associations between radon and lung cancer in the mining cohorts raised concern regarding the potential health effects of radon in homes, where levels are usually lower than those experienced in mining cohorts. Numerous residential case-control studies of lung cancer have been performed in the United States and in many other countries, including Canada, China, Finland, Germany, Sweden, and the United Kingdom. Some of these studies reported positive or weakly positive associations between lung cancer risk and residential radon concentrations, whereas no consistent associations were observed in others. None of the available residential case-control studies reported a statistically significant negative association (i.e., decreasing cancer risk in association with increasing radon exposure). Limitations of these studies include: (1) uncertainty in estimating long-term radon levels from relatively few prospective and/or retrospective periodic measurements of radon levels in a particular location; (2) uncertainty in assumptions regarding radon levels in homes where measurements were not made, length of residence and history of prior residences; and (3) accuracy of reported data on confounding factors such as smoking history. The individual residential case-control studies typically employed relatively low numbers of cases and matched controls, which limits the statistical power of a particular study to identify a statistically significant association between radon exposure and an adverse health outcome such as lung cancer. The statistical power is further reduced by measurement error and residential mobility. In order to more precisely estimate risk, most of the investigators have pooled data from their studies. The pooled analyses have found statistically significant, positive associations between lung cancer and residential radon levels.

### 3. HEALTH EFFECTS

Several ecological studies have been performed to assess possible relationships between selected cancers and estimated radon levels within particular geographic regions where environmental radon levels appear to be higher than other geographic regions. Typically, estimates of mean radon levels for the geographic regions were significantly elevated, but were based on relatively few actual measurements of radon levels in homes in the region and were not matched to individuals. This is problematic because radon (particularly indoor) levels can vary greatly between residences in a particular geographic region. Additional sources of uncertainty in methodology used to estimate radon levels in ecological studies include use of current exposure to represent past exposure, inherent error in measuring devices, use of indirect measures of indoor concentrations as an index of indoor radon exposure, use of sample measurements rather than total-population data, and estimation of individual exposure from group data (Greenland et al. 1989; Morgenstern 1995; Stidley and Samet 1993). Other factors that can lead to inaccurate results regarding associations between exposure to radon and lung cancer include inadequate control of confounding, model misspecification, and misclassification. Results of available ecological studies assessing possible associations between environmental radon levels and lung cancer incidence are mixed; both positive and negative associations, as well as no significant associations, have been suggested. Several ecological studies have indicated positive associations between radon levels and selected leukemias. Statistically significant associations between radon levels and leukemia were also reported in a miner cohort study (Řeřicha et al. 2006), but not in residential case-control studies from which outcomes and exposures were more accurately matched to individuals.

The health effects chapter of this toxicological profile for radon focuses, primarily, on health effects observed in studies of occupationally-exposed miners and results of pooled analyses of residential case-control studies. Results of animal studies provide additional support to the compelling evidence of radon-induced lung cancer in the miner cohorts and to the evidence of radon-induced lung tumors from results of pooled analyses of residential case-control studies. Since these studies are discussed in various sections of the profile, the general design features, attributes, limitations and major findings of the studies that form the bases for conclusions regarding the epidemiological evidence of health effects of radon exposures in humans are provided here.

Mining cohorts have been followed for several decades or more. Continued follow-up and refined assessments of the most widely-studied mining cohorts have resulted in improved exposure estimates and more complete categorization of individuals according to cause of death, mining history, and smoking status. Assessments did not necessarily include adjustments for confounding exposures to arsenic, silica dust, and/or diesel exhaust. The bulk of health effects information for the mining cohorts reported in this



## 3. HEALTH EFFECTS

toxicological profile for radon derives from the most recent analyses of pooled data from 11 mining cohorts (Lubin et al. 1997; NAS 1999b; NIH 1994) using the most recent and comprehensive follow-up results from available studies of individual mining cohorts. Requirements for inclusion of a particular cohort in the analysis of pooled results included: (1) a minimum of 40 lung cancer deaths and (2) estimates of radon progeny exposure in units of WLM for each member of the cohort based on historical measurements of either radon or radon progeny. All 11 studies reported positive associations between lung cancer mortality and radon progeny exposure. For all subjects in each study cohort, person-years were accumulated from the date of entry (based on a minimum time of employment or the occurrence of a medical examination in some studies). A latency period of 5 years was incorporated to represent the expected minimum time necessary for a transformed cell to result in death from lung cancer. Although the accuracy of exposure estimates varied widely among the individual study cohorts, no attempt was made to restrict or limit the role of any particular cohort in the combined analysis. Relative risk for lung cancer was calculated as a function of cumulative WLM after adjustments for cohort, age, other occupational exposures, and ethnicity (NIH 1994). Selected characteristics of the individual cohorts and pooled data are presented in Table 3-1, as well as relative risks of lung cancer mortality for selected categories of cumulative WLM. The results provide evidence for increasing risk of lung cancer mortality with increasing cumulative WLM. Updated analysis of the 11 mining cohorts that contributed to the pooled data of NIH (1994) was particularly focused on relative risk of lung cancer in the miners exposed to relatively low cumulative WLM (Lubin et al. 1997); results demonstrate significant risk of lung cancer mortality at well below 100 WLM (Table 3-2). Excess relative risks (ERRs) for lung cancer mortality (excess risk per WLM) were estimated to be 0.0117/WLM (95% confidence interval [CI] 0.002–0.025) for exposures <50 WLM and 0.0080/WLM (95% CI 0.003–0.014) for exposures <100 WLM.

Assessments of pooled data from major residential case-control studies include a combined analysis of 7 North American case-control studies (Krewski et al. 2005, 2006) and a combined analysis of 13 European case-control studies (Darby et al. 2005, 2006). The individual case-control studies that contributed to the combined analysis of North American case-control studies were performed in regions of New Jersey, Winnipeg, Missouri, Iowa, Connecticut, and Utah-South Idaho. Requirements for inclusion in the combined analysis of North American case-control studies included: (1) ascertainment of at least 200 lung cancer cases with a majority histologically or cytologically confirmed; (2) radon exposure estimates based primarily on long-term  $\alpha$ -track detectors located in living areas of homes; and (3) in-person or telephone interviews with subjects or next of kin to obtain data on a variety of demographic, socioeconomic, and smoking-related factors. Of 10,127 total subjects in the 7 North American case-control studies, 765 subjects were excluded from the pooled analysis due to no radon

## 3. HEALTH EFFECTS

**Table 3-1. Selected Characteristics and Exposure Data for Individual Miner Cohort Studies Included in the Analysis of Pooled Data from the Individual Studies, and Lung Cancer Mortality Rates and Relative Risks by Cumulative WLM for Pooled Data<sup>a</sup>**

Study cohort	Mine type	Follow-up		Non-exposed workers		Exposed workers and mean cumulative WLM		
		Period	Length (years)	Number	Person-years	Number	Person-years	WLM
China	Tin	1976–1987	10.2	3,494	39,985	3,494	39,985	277.4
Czech Republic	Uranium	1952–1990	25.2	0	4,216	0	4,216	198.7
Colorado	Uranium	1950–1987	24.6	0	7,403	0	7,403	807.2
Ontario	Uranium	1955–1986	17.8	0	61,017	0	61,017	30.8
Newfoundland	Fluorspar	1950–1984	23.3	337	13,713	337	13,713	367.3
Sweden	Iron	1951–1991	25.7	0	841	0	841	80.6
New Mexico	Uranium	1943–1985	17.0	12	12,152	12	12,152	110.3
Beaverlodge	Uranium	1950–1980	14.0	1,591	50,345	1,591	50,345	17.2
Port Radium	Uranium	1950–1980	25.2	683	22,222	683	22,222	242.8
Radium Hill	Uranium	1948–1987	21.9	1,059	26,301	1,059	26,301	7.6
France	Uranium	1948–1986	24.7	16	4,556	16	4,556	68.7
Totals <sup>b</sup>			17.2	7,176	242,332	7,176	242,332	161.6

Cumulative WLM	Lung cancer cases	Person-years	Mean WLM	Relative risk <sup>d</sup> (95% CI)
0	107	214,089	0.0	1.00
1–49	367	502,585	14.8	1.03 (0.8–1.4)
50–99	212	118,196	73.0	1.30 (1.0–1.7)
100–199	462	132,207	144.8	1.74 (1.3–2.3)
200–399	511	91,429	280.4	2.24 (1.7–3.0)
400–799	612	65,105	551.7	2.97 (2.2–3.9)
800–1,599	294	27,204	1105.1	4.06 (3.0–5.4)
≥1,600	140	10,336	2408.4	10.2 (7.4–14.0)
Totals	2,705	1,161,150	130.6 <sup>c</sup>	

<sup>a</sup>Table entries include 5-year lag interval for radon progeny exposure.

<sup>b</sup>Totals adjusted for 115 workers (including 12 lung cancer cases) who were included in both New Mexico and Colorado cohorts.

<sup>c</sup>Mean WLM among exposed miners is 160.2.

<sup>d</sup>Adjusted for cohort, age, other occupational exposures, and ethnicity.

CI = confidence interval; WLM = working level months

Source: NIH 1994

## 3. HEALTH EFFECTS

**Table 3-2. Selected Results from Analysis of Pooled Data from 11 Mining Cohorts<sup>a</sup>, Based on Deciles of Case Exposures That Were Each Under 100 WLM<sup>b</sup>**

Cumulative WLM	Lung cancer cases <sup>c</sup>	Person-years	Mean WLM	Relative risk <sup>d</sup> (95% CI)
0	115	274,161	0.0	1.00
0.1–3.5	56	111,424	2.4	1.37 (1.0–2.0)
3.6–6.9	56	95,727	5.3	1.14 (0.8–1.7)
7.0–15.1	56	72,914	12.4	1.16 (0.8–1.7)
15.2–21.2	57	67,149	17.3	1.45 (1.0–2.2)
21.3–35.4	56	57,890	33.1	1.50 (1.0–2.2)
35.5–43.5	57	42,068	38.6	1.53 (1.0–2.2)
43.6–59.4	56	25,622	53.2	1.69 (1.1–2.5)
59.5–70.3	56	40,220	63.3	1.78 (1.2–2.6)
70.4–86.5	56	28,076	81.1	1.68 (1.1–2.5)
86.6–99.9	56	23,682	91.4	1.86 (1.2–2.8)

<sup>a</sup>The 11 mining cohorts and reports used for the pooled analysis included China (Xuan et al. 1993), Sweden (Radford and Renard 1984), Newfoundland (Morrison et al. 1988), Czech Republic (Ševc et al. 1988; Tomášek et al. 1994b), Colorado (Hornung and Meinhardt 1987; Hornung et al. 1995), Ontario (Kusiak et al. 1993), New Mexico (Samet et al. 1991), Beaverlodge (Howe et al. 1986), Port Radium (Howe et al. 1987), Radium Hill (Woodward et al. 1991), and France (Tirmarche et al. 1993).

<sup>b</sup>Table entries include 5-year lag interval for radon progeny exposure.

<sup>c</sup>Totals adjusted for 115 workers (including 12 lung cancer cases) who were included in both New Mexico and Colorado cohorts.

<sup>d</sup>Adjusted for cohort, age, other occupational exposures, and ethnicity; excess relative risks for lung cancer mortality were 0.0117 per WLM (95% CI: 0.002–0.025) for exposures <50 WLM and 0.0080 per WLM (95% CI: 0.003–0.014) for exposures <100 WLM.

CI = confidence interval; WLM = working level months

Source: Lubin et al. 1997

## 3. HEALTH EFFECTS

measurements, no residence data within a 5–30-year time exposure window prior to the index date, or insufficient smoking data. The 5–30-year time exposure window presumes that neither radon exposure within 5 years of lung cancer occurrence nor 30 years prior to the index date contributes to lung cancer, although the window is presumed to be generally reflective of a biologically relevant exposure. Thus, the combined analysis included 4,081 lung cancer cases and 5,281 matched controls (Krewski et al. 2006). Selected characteristics of the study subjects and exposure estimates are presented in Table 3-3, along with odds ratios (ORs) for lung cancer from pooled data without restriction and ORs resulting from restriction to subjects residing in one or two houses with  $\geq 20$  years of the residence time covered by  $\alpha$ -track monitors. All analyses of the data were conducted using conditional likelihood regression for matched or stratified data and included covariates for sex, age at index date, number of cigarettes smoked per day, duration of smoking, and an indicator variable for each study. Excess odds ratios (EORs) were 0.10 per 100 Bq/m<sup>3</sup> (95% CI -0.1–0.28) for the unrestricted dataset and 0.18 per 100 Bq/m<sup>3</sup> (95% CI 0.02–0.43) when restricting to subjects residing in one or two houses with  $\geq 20$  years of the residence time covered by  $\alpha$ -track monitors. This combined analysis provides evidence of an association between residential radon and lung cancer risk (Table 3-3).

The analysis of pooled data from residential case-control studies in 13 European studies (Darby et al. 2005, 2006) included Austria, the Czech Republic, nationwide Finland, south Finland, France, eastern Germany, western Germany, Italy, Spain, nationwide Sweden, never smokers in Sweden, Stockholm Sweden, and the United Kingdom. The pooled data included 7,148 lung cancer cases and 14,208 controls. Results of this analysis provide additional evidence of an association between residential radon and lung cancer risk. This evidence includes statistically significant relative risks at exposure concentrations  $\geq 400$  Bq/m<sup>3</sup> (10.8 pCi/L), an ERR of 0.084 per 100 Bq/m<sup>3</sup> (95% CI 0.03–0.158) for the full range of observed radon concentrations, and ERRs of 0.140 per 100 Bq/m<sup>3</sup> (95% CI 0.004–0.309) for exposure concentrations  $< 200$  Bq/m<sup>3</sup> ( $< 5.4$  pCi/L), 0.095 per 100 Bq/m<sup>3</sup> (95% CI 0.005–0.206) for exposure concentrations  $< 400$  Bq/m<sup>3</sup> ( $< 10.8$  pCi/L), and 0.078 per 100 Bq/m<sup>3</sup> (95% CI 0.012–0.164) for exposure concentrations  $< 800$  Bq/m<sup>3</sup> ( $< 21.6$  pCi/L) (Table 3-4).

Although the dose-response coefficients from the mining studies and residential studies are expressed in different units of exposure (i.e., WLM vs. Bq/m<sup>3</sup>), they can be compared by applying the relationship described above, namely that 1 pCi/L (37 Bq/m<sup>3</sup>) is equivalent to 0.144 WLM/year. Thus, a 25-year exposure at 200 Bq/m<sup>3</sup> (5.4 pCi/L) would be equivalent to a cumulative exposure of 19.5 WLM. Using this conversion factor, an estimated excess relative risk of 0.0117/WLM at occupational exposures  $< 50$  WLM (Lubin et al. 1997) would be roughly equivalent to an ERR of 0.114 per 100 Bq/m<sup>3</sup>. This

## 3. HEALTH EFFECTS

**Table 3-3. Selected Characteristics of Study Subjects, Exposure Estimates, and Odds Ratios for Lung Cancer from Combined Analysis of Seven North American Residential Case-control Studies (Using a 5–30-year Exposure Time Window)**

Region	Number of subjects		Time-weighted average radon concentration in Bq/m <sup>3</sup>		
	Lung cancer cases	Controls	Lung cancer cases	Controls	All subjects
New Jersey	480	442	26.5	24.9	25.7
Winnipeg	708	722	137.4	146.9	142.2
Missouri-I	530	1,177	62.2	62.9	62.7
Missouri-II	477	516	55.3	56.1	55.7
Iowa	412	613	136.2	121.3	127.3
Connecticut	963	949	32.2	32.8	32.5
Utah-Idaho	511	862	55.4	58.1	57.1

## Odds ratios for lung cancer

Radon concentration		Number of subjects		Odds ratio <sup>a</sup> (95% confidence interval)
Bq/m <sup>3</sup>	pCi/L	Cases	Controls	
<25	<0.68	994	1,055	1.00
25–49	0.68–1.32	1,169	1,549	1.13 (0.94–1.31)
50–74	1.35–2.00	704	1,087	1.05 (0.86–1.27)
75–99	2.03–2.68	356	507	1.14 (0.90–1.45)
100–149	2.70–4.03	513	602	1.22 (0.95–1.56)
150–199	4.05–5.38	166	229	1.19 (0.86–1.66)
≥200	≥5.45	179	252	1.29 (0.93–1.80)

Excess odds ratio ( $\beta$ )=0.10 per 100 Bq/m<sup>3</sup> (95% confidence interval -0.01–0.28)<sup>b</sup>

Odds ratios for lung cancer with data restricted to subjects residing in one or two houses in the exposure window with ≥20 years covered by  $\alpha$ -track air monitors

Radon concentration		Number of subjects		Odds ratio <sup>a</sup> (95% confidence interval)
Bq/m <sup>3</sup>	pCi/L	Cases	Controls	
<25	<0.68	503	596	1.00
25–49	0.68–1.32	481	717	1.01 (0.80–1.28)
50–74	1.35–2.00	295	418	1.29 (0.98–1.70)
75–99	2.03–2.68	181	293	1.22 (0.88–1.69)
100–149	2.70–4.03	202	282	1.28 (0.91–1.78)
150–199	4.05–5.38	115	160	1.41 (0.83–2.14)
≥200	≥5.45	133	185	1.29 (0.91–2.06)

Excess odds ratio ( $\beta$ )=0.18 per 100 Bq/m<sup>3</sup> (95% confidence interval 0.02–0.43)<sup>b</sup>

<sup>a</sup>Odds ratios stratified by sex and categories of age, duration of smoking, number of cigarettes smoked per day, number of residences, and years with  $\alpha$ -track measurements in the exposure time window.

<sup>b</sup>Based on linear model:  $OR(x)=1+\beta x$ , where  $x$  is the radon concentration in the exposure time window.

Source: Krewski et al. 2006

## 3. HEALTH EFFECTS

**Table 3-4. Relative Risk and Excess Relative Risk of Lung Cancer by Radon Level in Homes 5–34 Years Previously, Estimated from the Pooled Data for 13 European Residential Case-control Studies**

Radon concentration			Number of subjects		
Range (Bq/m <sup>3</sup> )	Mean (Bq/m <sup>3</sup> )	Mean (pCi/L)	Lung cancer cases	Controls	RR (95% CI)
<25	17	0.46	566	1,474	1.00 (0.87–1.15)
25–49	39	1.05	1,999	3,905	1.06 (0.98–1.15)
50–99	71	1.92	2,618	5,033	1.03 (0.96–1.10)
100–199	136	3.68	1,296	2,247	1.20 (1.08–1.32)
200–399	273	7.38	434	936	1.18 (0.99–1.42)
400–799	542	14.65	169	498	1.43 (1.06–1.92)
≥800	1,204	32.54	66	115	2.02 (1.24–3.31)

Excess relative risk for lung cancer according to selected ranges of radon concentrations

Range of radon concentrations		Lung cancer cases	Controls	ERR per 100 Bq/m <sup>3</sup> (95% CI)
<800 Bq/m <sup>3</sup>	21.6 pCi/L	7,082	14,093	0.078 (0.012–0.164)
<400 Bq/m <sup>3</sup>	10.8 pCi/L	6,913	13,595	0.095 (0.005–0.206)
<200 Bq/m <sup>3</sup>	5.4 pCi/L	6,479	12,659	0.140 (0.004–0.309)
<100 Bq/m <sup>3</sup>	2.7 pCi/L	5,183	10,412	0.025 (-0.192–306)
All radon concentrations		7,148	14,208	0.084 (0.030–0.158)

CI = confidence interval; ERR = excess relative risk; RR = relative risk

Source: Darby et al. 2006

### 3. HEALTH EFFECTS

value is similar to the estimates for excess relative risk ( $0.084/\text{Bq}/\text{m}^3$ ) estimated from the analysis of pooled data from the 13 European case-control studies (Darby et al. 2005, 2006) and EOR ( $0.18$  per  $100 \text{ Bq}/\text{m}^3$ ) estimated from the pooled analysis of the North American residential case-control studies restricted to subjects residing in one or two houses with  $\geq 20$  years of the residence time covered by  $\alpha$ -track monitors (Krewski et al. 2006). Based on this comparison, the studies of mining cohorts and the residential studies appear to converge on similar estimates for the relationship between exposure to radon (and its progeny) and risk of lung cancer mortality.

Animal studies derive mainly from inhalation studies performed at the University of Rochester (UR) in the 1950s and 1960s using rats, mice, and dogs (AEC 1961, 1964, 1966; Morken 1955, 1973); at the Pacific Northwest Laboratory (PNL, presently Pacific Northwest National Laboratory [PNNL]) between the 1960s and 1980s using rats, dogs, and hamsters (Cross 1988, 1994; Cross et al. 1981a, 1981b, 1984; Dagle et al. 1992; Gilbert et al. 1996; NIEHS 1978; Palmer et al. 1973); and at laboratories in France using rats (Chameaud et al. 1974, 1980, 1982a, 1982b, 1984; Monchaux 2004; Monchaux and Morlier 2002; Monchaux et al. 1999; Morlier et al. 1992, 1994). Most of these studies employed exposure levels that were many orders of magnitude higher than those considered to be relevant to human health. Discussion of animal studies in Section 3.2.1 is limited to studies that employed exposure levels considered relevant to plausible human exposure scenarios (Chameaud et al. 1984; Morlier et al. 1994).

#### 3.2.1.1 Death

Possible associations between exposure to radon and lung cancer mortality among underground miners are discussed in Section 3.2.1.7 (Cancer).

Excess mortality from noncancer diseases reported in some of the mining cohorts include all noncancer respiratory diseases, pneumoconioses, emphysema, interstitial pneumonitis, other (unspecified) chronic obstructive respiratory diseases, and tuberculosis (Lundin et al. 1971; Muller et al. 1985; Roscoe 1997; Roscoe et al. 1989, 1995; Samet et al. 1991; Tirmarche et al. 1993; Waxweiler et al. 1981). However, confounding factors such as exposure to other respiratory toxicants, ethnicity, smoking history, and work experience were likely major contributors to mortalities from noncancer respiratory diseases. Mortality due to nonneoplastic respiratory diseases was not significantly elevated in other studies of mining cohorts. A statistically significant excess of mortality due to chronic nephritis and renal sclerosis was also reported in the U.S. uranium miner cohort, although it is unclear whether this was related to exposure to radon, uranium ore, or other mining conditions or to nonmining factors (Waxweiler et al. 1981).

### 3. HEALTH EFFECTS

No significant association was observed between cumulative exposure to radon progeny and death from cardiovascular diseases in cohorts of German uranium miners (Kreuzer et al. 2004) or Newfoundland fluorspar miners (Villeneuve et al. 2007a).

No significant effects on longevity were observed in male Sprague-Dawley rats exposed to atmospheres of radon and radon progeny for 6 hours/day, 5 days/week during 18 months to obtain a cumulative exposure of 25 WLM (Morlier et al. 1994) or in rats exposed to a cumulative exposure of 20 WLM (1 hour exposures twice weekly for 42 total exposures) or 40 WLM (1-hour exposures twice weekly for 82 total exposures) (Chameaud et al. 1984). No additional animal studies were located for which exposure levels were considered relevant to human health.

#### 3.2.1.2 Systemic Effects

No studies were located regarding gastrointestinal, musculoskeletal, hepatic, dermal, body weight, or ocular effects after inhalation exposure to radon and its progeny at exposure levels considered relevant to human health.

**Respiratory Effects.** Possible associations between exposure to radon and lung cancer are discussed in Section 3.2.1.7. Adverse noncancer respiratory effects have been observed in humans under occupational conditions and in laboratory animals exposed to radon and its progeny. Some studies of miner cohorts identified excess cases of pneumoconioses, emphysema, interstitial pneumonitis, pulmonary fibrosis, and tuberculosis (Fox et al. 1981; Lundin et al. 1971; Muller et al. 1985; Roscoe 1997; Roscoe et al. 1989, 1995; Samet et al. 1991; Tirmarche et al. 1993; Waxweiler et al. 1981). However, potential confounding by smoking was likely a major contributor to mortalities from noncancer respiratory diseases. Chronic lung disease was reported to increase with increasing cumulative exposure to radiation and with cigarette smoking (Archer 1980). In addition, nonsmoking uranium miners were also reported to have increased deaths from nonmalignant respiratory disease compared to a nonsmoking U.S. veteran cohort (Roscoe et al. 1989).

Alterations in respiratory function in U.S. uranium miners have been reported (Archer et al. 1964; Samet et al. 1984a; Trapp et al. 1970). Analyses among U.S. uranium miners indicated decrements in pulmonary function with increasing cumulative exposure (Archer et al. 1964) and with the duration of underground mining (Samet et al. 1984a). Evaluations of these respiratory end points did not permit



### 3. HEALTH EFFECTS

assessment of the effects of each of the other possible mine pollutants, such as ore dust, silica, or diesel engine exhaust.

No information was located regarding respiratory effects in animals following exposure to radon and its progeny at concentrations considered relevant to human health.

**Cardiovascular Effects.** No significant association was observed between cumulative exposure to radon progeny and death from cardiovascular diseases in cohorts of German uranium miners (Kreuzer et al. 2004) or Newfoundland fluorspar miners (Villeneuve et al. 2007a).

No information was located regarding cardiovascular effects in animals following exposure to radon and its progeny at concentrations considered relevant to human health.

**Hematological Effects.** No studies were located regarding hematological effects after inhalation exposure to radon at concentrations considered relevant to human health.

**Renal Effects.** Although a statistically significant increase in mortality due to kidney disease, characterized by chronic nephritis and renal sclerosis, was reported among U.S. uranium miners (Waxweiler et al. 1981) and in Canadian miners at the Eldorado mines (Muller et al. 1985), this finding is not generally considered to be related to radon exposure *per se*.

No information was located regarding renal effects in animals following exposure to radon and its progeny.

#### 3.2.1.3 Immunological and Lymphoreticular Effects

No information was located regarding immunological effects after inhalation exposure to radon at concentrations considered relevant to human health.

#### 3.2.1.4 Neurological Effects

No studies were located regarding neurological effects after inhalation exposure to radon at concentrations considered relevant to human health.

### 3. HEALTH EFFECTS

#### 3.2.1.5 Reproductive Effects

No maternal or fetal reproductive effects in humans have been attributed to exposure to radon and its progeny. However, a decrease in the secondary sex ratio (males:females) of the children of male underground miners may be related to exposure to radon and its progeny (Dean 1981; Muller et al. 1967; Wiese and Skipper 1986).

No information was located regarding reproductive effects in animals following exposure to radon and its progeny at concentrations considered relevant to human health.

#### 3.2.1.6 Developmental Effects

No studies were located regarding developmental effects in humans following inhalation exposure to radon and its progeny.

No information was located regarding developmental effects in animals following exposure to radon and its progeny at concentrations considered relevant to human health.

#### 3.2.1.7 Cancer

Associations between exposure to radon and lung cancer mortality have been examined in studies of underground miners at facilities in the United States (Archer et al. 1973, 1976, 1979; Checkoway et al. 1985; Gottlieb and Husen 1982; Hornung and Meinhardt 1987; Hornung et al. 1998; Lubin et al. 1995a, 1995b, 1997; Luebeck et al. 1999; Lundin et al. 1971; Moolgavkar et al. 1993; NIH 1994; Roscoe 1997; Roscoe et al. 1989, 1995; Samet et al. 1984b, 1989, 1991, 1994; Stayner et al. 1985; Stram et al. 1999; Thomas et al. 1994; Wagoner et al. 1963, 1964; Waxweiler et al. 1981), Australia (Woodward et al. 1991); Brazil (Veiga et al. 2006), Canada (Howe and Stager 1996; Howe et al. 1986, 1987; Kusiak et al. 1993; L'Abbé et al. 1991; Morrison et al. 1985, 1998; Muller et al. 1985), China (Qiao et al. 1989, 1997; Yao et al. 1994), the Czech Republic (Ševc et al. 1988, 1993; Tomášek 2002; Tomášek and Darby 1995; Tomášek and Plaček 1999; Tomášek and Žárská 2004; Tomášek et al. 1993, 1994a, 1994b, 2008), England (Fox et al. 1981; Hodgson and Jones 1990b), France (Laurier et al. 2004; Leuraud et al. 2007; Rogel et al. 2002; Tirmarche et al. 1993; Vacquier et al. 2007), Germany (Brüske-Hohlfeld et al. 2006; Kreuzer et al. 2000; Taeger et al. 2006), Italy (Carta et al. 1994), Norway (Solli et al. 1985), and Sweden (Axelson and Sundell 1978; Damber and Larsson 1982; Edling and Axelson 1983; Jorgensen 1984; Radford and Renard 1984; Snihs 1974). The mining cohorts were primarily uranium miners, but included

## 3. HEALTH EFFECTS

some cohorts mining other metals, hard rock, or coal. The results of these studies consistently demonstrate increased risk of mortality from lung cancer with increasing WLM (see Table 3-2). Lubin et al. (1997) provide the most recent report of pooled results from eleven of these cohorts. The pooled data included 115 lung cancer deaths among workers without known occupational exposure to radon and 2,674 lung cancer deaths among exposed miners. Some of these miners had been exposed to more than 10,000 WLM; the mean exposure among the pooled miner data was 162 WLM. Restricting exposed miner groups by cumulative exposure (<50 and <100 WLM) resulted in 353 and 562 lung cancer deaths, respectively. Even in these groups of miners with relatively low-level exposure, relative risk of lung cancer mortality exhibited an apparent linear and statistically significant increasing trend with WLM (in decile categories). ERRs (excess risk per WLM) were estimated to be 0.0117/WLM (95% CI 0.002–0.025) for exposures <50 WLM and 0.0080/WLM (95% CI 0.003–0.014) for exposures <100 WLM. General patterns of declining excess relative risk per WLM with attained age, time since exposure, and exposure rate were observed in both the unrestricted pooled data and in those restricted to <50 and <100 WLM.

Some studies of mining cohorts examined mortality from cancers other than lung cancer. Results of a few of these studies indicate slight excessive mortalities from laryngeal, liver, kidney, and/or gall bladder cancers (Kreuzer et al. 2004; Tirmarche et al. 1992; Tomášek et al. 1993; Vacquier et al. 2007); however, these slight excesses did not appear to be related to cumulative exposure to radon and were not found in excess in other studies of mining cohorts.

The results of the miner studies consistently demonstrate significant positive associations between lung cancer and exposure to radon. However, it must be noted that potential confounding by silica dust inhalation (identified as a known human carcinogen in the 11<sup>th</sup> Report on Carcinogens subsequent to most reports of the miner cohorts [NTP 2005b]) might influence the calculated impact of radon on lung cancer mortality in the mining cohorts. Statistically significant excess lung cancer mortality was associated with average cumulative exposures as low as 36–39 WLM in Czech and French cohorts of uranium miners (Ševc et al. 1988; Vacquier et al. 2007); exposure levels were higher among many of the other uranium miner cohorts. An inverse exposure rate effect (i.e., lower exposure rates for long periods are more hazardous than equivalent cumulative exposure received at higher exposure rates over a shorter time) was evident at relatively high exposure levels (WL) (Hornung et al. 1998; Lubin et al. 1995a, 1997; Luebeck et al. 1999; Moolgavkar et al. 1993; NIH 1994); however, this effect appeared to be attenuated or absent at relatively low exposure levels (Lubin et al. 1995a; NIH 1994; Tomášek et al. 2008). Among smoking and nonsmoking uranium miners, the most frequently reported type of lung cancer was small cell lung

## 3. HEALTH EFFECTS

carcinoma (SCLC) in the early phase of follow-up (Archer et al. 1974; Auerbach et al. 1978; Butler et al. 1986; Gottlieb and Husen 1982; Saccomanno et al. 1971, 1988; Samet 1989). Archer et al. (1974) also noted relatively high rates of epidermoid and adenocarcinomas, while large-cell undifferentiated and other morphological types of lung cancer were seen less frequently. A report on the German uranium mining cohort identified squamous cell carcinoma as the predominant lung tumor cell type, followed by adenocarcinoma and SCLC (Kreuzer et al. 2000). In a subcohort of 516 white nonsmoking uranium miners (drawn from a larger cohort of U.S. uranium miners), mean exposure was reportedly 720 WLM. For this cohort, the mortality risk for lung cancer was found to be 12-fold greater than that of nonsmoking, nonmining U.S. veterans. No lung cancer deaths were found in nonsmoking miners who had exposure <465 WLM (Roscoe et al. 1989).

Most of the reported epidemiological studies of uranium mining cohorts did not find significant associations between radon exposure and cancers other than lung cancer (Kreuzer et al. 2004; Laurier et al. 2004; Möhner et al. 2006; Roscoe 1997; Tomášek et al. 1993). Řeřicha et al. (2006) reported significant positive associations between cumulative radon exposures and incidences of chronic lymphocytic leukemia (relative risk [RR]=1.75; 95% CI 1.10–2.78) and incidences of all leukemias combined (RR=1.98; 95% CI 1.10–3.59) in a cohort of Czech uranium miners at 110 WLM. However, statistically significant associations between radon exposure and leukemias have not been found by other investigators of uranium mining cohorts.

Numerous residential case-control studies of lung cancer have been performed in the United States and other countries, including Brazil, Canada, China, Croatia, the Czech Republic, Finland, France, Germany, Israel, Italy, Japan, Spain, Sweden, and the United Kingdom. Some of these studies reported positive or weakly positive associations between lung cancer risk and residential radon concentrations, whereas no significant associations were observed in others. As discussed earlier, recent assessment of available residential case-control studies includes analyses of pooled data from major residential case-control studies, a combined analysis of seven North American case-control studies (Krewski et al. 2005, 2006) and a combined analysis of 13 European case-control studies (Darby et al. 2005, 2006). Pooling resulted in much larger numbers of lung cancer cases and controls than were achieved in individual case-control studies. The results of these analyses of pooled data provide evidence of increased risk for lung cancer with increasing residential levels of radon (Tables 3-3 and 3-4), including a statistically significant relative risk of lung cancer at mean radon concentrations  $\geq 542$  Bq/m<sup>3</sup> (14.65 pCi/L) reported by Darby et al. (2006) (Table 3-4).

### 3. HEALTH EFFECTS

Assessment of the results of residential case-control studies and comparisons between the presently-available pooled results of the North American case-control studies (Krewski et al. 2005, 2006) and the European case-control studies (Darby et al. 2005, 2006) must take into account the effects of exposure measurement error and methodological differences in final analyses. Estimates based on measured radon concentrations will likely underestimate the true risks associated with residential radon, due to misclassification of exposure from detector measurement error, spatial radon variations within a home, temporal radon variation, missing data from previously occupied homes that currently are inaccessible, failure to link radon concentrations with subject mobility, and measuring radon gas concentration as a surrogate for radon progeny exposure (Field et al. 1996, 2002). Generally, if exposure misclassification does not differ systematically between cases and controls, the observed results tend to be biased toward the null (for example, the true effect is actually underestimated). In fact, Field et al. (2002) demonstrated that empirical models with improved retrospective radon exposure estimates were more likely to detect an association between prolonged residential radon exposure and lung cancer. Direct comparisons between the pooled results of the North American case-control studies (Krewski et al. 2005, 2006) and those of the European case-control studies (Darby et al. 2005, 2006) are problematic because only the pooled results of the European case-control studies included regression calibration in an attempt to adjust for some of the measurement error.

Information regarding radon-induced lung cancer in animals exposed to radon and its progeny at concentrations considered relevant to human health includes significantly increased incidences of lung tumors in rats repeatedly exposed to radon and its progeny at cumulative exposures as low as 20–50 WLM (Chameaud et al. 1984; Morlier et al. 1994). These results are consistent with the demonstrated associations between lung cancer risk and exposure to radon and radon progeny in occupationally-exposed miners and residentially-exposed individuals.

### 3. HEALTH EFFECTS

#### **3.2.2 Oral Exposure**

No studies were located regarding the following health effects, other than cancer, in humans or animals after oral exposure to radon or its progeny:

##### **3.2.2.1 Death**

##### **3.2.2.2 Systemic Effects**

##### **3.2.2.3 Immunological and Lymphoreticular Effects**

##### **3.2.2.4 Neurological Effects**

##### **3.2.2.5 Reproductive Effects**

##### **3.2.2.6 Developmental Effects**

##### **3.2.2.7 Cancer**

Information regarding cancer in humans after exposure to radon and its progeny in water is limited to ecological studies. As noted earlier, ecological studies are limited by several factors that may include bias in estimated indoor radon levels, inadequate control of confounding, model misspecification, and misclassification. Radon levels were measured in 2,000 public and private wells in 14 counties in Maine (Hess et al. 1983). The county averages were compared to cancer rate by county to determine any degree of correlation. Significant correlation was reported for all lung cancer and all cancers combined, when both sexes were combined, and for lung tumors in females. Confounding factors (e.g., smoking) were not considered in this analysis. In addition, exposure from radon in these water supplies could have been by the inhalation route as well as the oral route. Results of some ecological studies suggest positive associations between radon levels in ground water sources and incidences of cancers, including lung cancer (Hess et al. 1983), all cancers combined (Mose et al. 1990), and childhood cancer (leukemias and all cancers combined) (Collman et al. 1990). In another study, Collman et al. (1988) found no consistent associations between radon concentrations in ground water and cancer mortality. More recent case-cohort studies in Finland found no significant associations between mean concentrations of radon in well water and cases of stomach cancer (Auvinen et al. 2005) or bladder or kidney cancer (Kurtio et al. 2006).

No studies were located regarding cancer in animals after oral exposure to radon and its progeny.

### 3. HEALTH EFFECTS

#### 3.2.3 Dermal Exposure

No studies were located regarding the following health effects, other than cancer, in humans or animals after dermal exposure to radon and its progeny:

##### 3.2.3.1 Death

##### 3.2.3.2 Systemic Effects

##### 3.2.3.3 Immunological and Lymphoreticular Effects

##### 3.2.3.4 Neurological Effects

##### 3.2.3.5 Reproductive Effects

##### 3.2.3.6 Developmental Effects

##### 3.2.3.7 Cancer

A statistically significant increase in the incidence of basal cell skin cancers (103.8 observed vs. 13.0 expected) was observed in uranium miners exposed occupationally for 10 years or more to approximately 3.08 pCi/L of air ( $1.74 \times 10^2$  Bq/m<sup>3</sup>) resulting in 6.22 pCi (0.23 Bq) radon/cm<sup>2</sup> skin surface area (Ševcová et al. 1978). Exposure to other agents in the uranium mining environment, as well as minor traumas of the skin, may also have contributed to the observed incidence of skin cancer. Increased incidences of skin cancer have not been reported in other uranium miner cohorts or for workers in other types of mining, such as metal or coal mines; these end points were not examined in most of these studies.

No studies were located regarding cancer in animals after dermal exposure to radon and its progeny.

### 3.3 GENOTOXICITY

Abundant information is available regarding the genotoxicity of ionizing radiation (refer to the Toxicological Profile for Ionizing Radiation for a detailed discussion of the genotoxic effects of various forms of ionizing radiation). The genotoxicity of alpha radiation from radon and its progeny has been investigated in underground miners, in individuals residing in homes with measured radon levels, in laboratory animals *in vivo*, and in a variety of *in vitro* test systems. Tables 3-5 and 3-6 present the results of *in vivo* and *in vitro* genotoxicity assessments, respectively.

Increases in chromosomal aberrations have been reported in peripheral blood lymphocytes of underground miners exposed to relatively high levels of radon and radon progeny (Bilban and Jakopin

## 3. HEALTH EFFECTS

**Table 3-5. Genotoxicity of Radon and Radon Progeny *In Vivo***

Species (test system)	End point	Results	Reference
Mammalian systems:			
Human (peripheral blood lymphocytes)	Chromosomal aberrations	+	Bauchinger et al. 1994; Bilban and Jakopin 2005; Brandom et al. 1978; Hellman et al. 1999; Pohl-Rüling and Fischer 1979, 1982; Pohl-Rüling et al. 1976; Smerhovsky et al. 2001, 2002; Stenstrand et al. 1979
Human (peripheral blood lymphocytes)	Chromosomal aberrations	–	Maes et al. 1996
Human (peripheral blood lymphocytes)	Micronuclei	+	Bilban and Jakopin 2005
Human (peripheral blood lymphocytes)	Gene mutations (HPRT)	–	Shanahan et al. 1996
Human (peripheral blood lymphocytes)	Gene mutations (HPRT)	–	Cole et al. 1996
Human (peripheral blood lymphocytes)	Gene mutations (HPRT)	–	Albering et al. 1992
Human (whole blood)	Gene mutations (glycophorin A)	+	Shanahan et al. 1996
Human (lymphocytes)	DNA repair	+	Tuschl et al. 1980
Rat (tracheal epithelial cells)	Chromosomal aberrations	+	Brooks et al. 1992
Rabbit (somatic cells)	Chromosomal aberrations	–	Leonard et al. 1981
Rat (alveolar macrophages)	Micronuclei	+	Taya et al. 1994
Rat (lung fibroblasts)	Micronuclei	+	Brooks et al. 1994; Khan et al. 1994, 1995
Syrian hamster (lung fibroblasts)	Micronuclei	+	Khan et al. 1995
Chinese hamster (lung fibroblasts)	Micronuclei	+	Khan et al. 1995
Rat (bone marrow)	Sister chromatid exchanges	+	Poncy et al. 1980

– = negative result; + = positive result



## 3. HEALTH EFFECTS

**Table 3-6. Genotoxicity of Radon and Radon Progeny *In Vitro***

Species (test system)	End point	Result		Reference
		With activation	Without activation	
Mammalian cells:				
Human (blood lymphocytes)	Chromosomal aberrations	No data	+	Wolff et al. 1991
Human (fibroblasts)	Chromosomal aberrations	No data	+	Loucas and Geard 1994
Chinese hamster (ovary AA8 cells)	Chromosomal aberrations	No data	+	Schwartz et al. 1990
Chinese hamster (ovary EM9 cells)	Chromosomal aberrations	No data	+	Schwartz et al. 1990
Chinese hamster (ovary K-1 cells)	Chromosomal aberrations	No data	+	Shadley et al. 1991
Chinese hamster (ovary xrs-5 cells)	Chromosomal aberrations	No data	–	Shadley et al. 1991
Chinese hamster (ovary K-1 cells)	Gene mutations	No data	+	Shadley et al. 1991
Chinese hamster (ovary xrs-5 cells)	Gene mutations	No data	+	Shadley et al. 1991
Chinese hamster (ovary AA8 cells)	Gene mutations	No data	+	Schwartz et al. 1990
Chinese hamster (ovary EM9 cells)	Gene mutations	No data	+	Schwartz et al. 1990
Chinese hamster (ovary C18 cells)	Gene mutations	No data	+	Jostes et al. 1994
Mouse (L5178Y cells)	Gene mutations	No data	+	Evans et al. 1993a, 1993b

– = negative result; + = positive result

## 3. HEALTH EFFECTS

2005; Brandom et al. 1978; Smerhovsky et al. 2001, 2002). Significantly increased frequency of micronuclei was also noted in peripheral blood lymphocytes of lead-zinc miners in the Czech Republic (Bilban and Jakopin 2005). Significantly increased frequency of mutations of glycoprotein A was reported in the blood from a cohort of Radium Hill uranium miners in Australia (Shanahan et al. 1996). The mutation rate tended to increase with increasing radon exposure, with the exception of the most highly exposed group (>10 WLM); there was no clear relation between HPRT mutation rates and previous occupational exposure to radon.

Several studies investigated possible associations between residential exposure to radon and radon progeny and genotoxic end points. Significantly increased frequency of chromosomal aberrations was noted in peripheral blood lymphocytes of a small group of individuals in Germany who resided in homes where radon concentrations were 4–60 times higher than the national average of 50 Bq/m<sup>2</sup> (Bauchinger et al. 1994). The prevalence of DNA damage in peripheral blood lymphocytes was significantly associated with increased residential radon levels at airborne levels exceeding 200 Bq/m<sup>3</sup>; no correlation was seen in comparisons of DNA damage to levels of radon in the drinking water for these same individuals, at levels drinking water ranging from 10 to 2,410 Bq/L (Hellman et al. 1999). Results of one small study of 20 individuals indicated a positive association between HPRT mutations in peripheral blood lymphocytes and measured radon levels (Bridges et al. 1991). However, a subsequent assessment by the same investigators using a larger number of exposed subjects (n=66) found no significant positive or negative association between HPRT mutation rates and indoor radon levels (Cole et al. 1996). Radon did not induce increased HPRT mutation rates in another study of a small group (n=11) of residentially-exposed subjects (Albering et al. 1992). No significant increase in the frequency of chromosomal aberrations was found in another small group (n=22) of subjects with residential exposure to radon at concentrations in the range of 50–800 Bq/m<sup>3</sup> (Maes et al. 1996).

Increases in chromosomal aberrations were reported among spa-house personnel and in area residents in Badgastein, Austria, who were chronically exposed to radon and radon decay products present in the environment (Pohl-Rüling and Fischer 1979, 1982; Pohl-Rüling et al. 1976). A study by Tuschl et al. (1980) indicated a stimulating effect of repeated low-dose irradiation on DNA repair in lymphocytes of persons occupationally exposed to radon (3,000 pCi/L of air [ $1.1 \times 10^5$  Bq/m<sup>3</sup>]). The study further indicated higher DNA-repair rates in juvenile cells than in fully differentiated cells.

An increase in chromosomal aberrations in lymphocytes was observed in 18 Finnish people of different ages chronically exposed to radon in household water at concentrations of  $2.9 \times 10^4$ – $1.2 \times 10^6$  pCi radon/L

## 3. HEALTH EFFECTS

of water ( $1.1 \times 10^3$ – $4.4 \times 10^4$  Bq/L) compared with people who did not have a history of exposure to high radon levels (Stenstrand et al. 1979). This study also indicated that the frequencies of chromosomal aberrations and multiple chromosomal breaks were more common in older people than in younger people exposed to radon. Although the radon was in household water, it is probable that much of this radon volatilized and was available to be inhaled. Therefore, this route of exposure includes both oral and inhalation routes.

Available *in vivo* animal data generally support the human data. Significantly increased frequency of micronuclei was observed in lung fibroblasts of Wistar rats, Syrian hamsters, and Chinese hamsters that inhaled radon and radon progeny; cumulative exposures were 115–323 WLM for the rats, 126–278 WLM for the Syrian hamsters, and 496 WLM for the Chinese hamsters (Khan et al. 1994, 1995). The Chinese hamsters appeared to be 3 times more sensitive than rats. Significantly increased frequency of chromosomal aberrations was noted in tracheal epithelial cells of F-344/N rats that had inhaled radon and radon progeny at cumulative exposures of 900 or 1,000 WLM (Brooks et al. 1992). Brooks and coworkers (Brooks et al. 1994) reported significantly increased frequency of micronuclei in lung fibroblasts of Wistar rats exposed to radon at levels resulting in cumulative exposures ranging from 115 to 320 WLM. Significantly increased frequency of alveolar macrophages with micronuclei was observed in rats exposed to radon and its progeny at levels designed to give cumulative exposures ranging from 120 to 990 WLM (Taya et al. 1994). Evidence of chromosomal aberrations was equivocal in two rabbit studies. Rabbits exposed to high natural background levels of radon (12 WLM) for over 28 months displayed an increased frequency of chromosomal aberrations (Leonard et al. 1981). However, when a similar study was conducted under controlled conditions (10.66 WLM), chromosomal aberrations were not found. According to the authors, the increased chromosomal aberrations in somatic cells of rabbits exposed to natural radiation were mainly due to the gamma radiation from sources other than radon. Exposure of Sprague-Dawley male rats to radon at cumulative doses as low as 100 WLM resulted in an increase in sister chromatid exchanges (SCEs) in bone marrow by 600 days postexposure (Poncy et al. 1980). At 750 days postexposure, the number of SCEs reached 3.21 per cell. The SCEs in the 500 and 3,000 WLM groups reached constant values of 3.61 and 4.13 SCEs per cell. In the high-dose group (6,000 WLM), SCEs continued to increase from 100 to 200 days after exposure, reaching a mean value of 3.5 SCE per cell. In controls, SCEs were constant with age (2.4 per cell).

The genotoxicity of radon and radon progeny has been assessed in a variety of mammalian cells *in vitro*. Chromosomal aberrations were reported in human blood lymphocytes (Wolff et al. 1991) and human fibroblasts (Loucas and Gear 1994). Exposure of Chinese hamster ovary (CHO) cells to the radon

### 3. HEALTH EFFECTS

daughter, bismuth-212 ( $^{212}\text{Bi}$ ) caused chromosomal aberrations and gene mutations (Schwartz et al. 1990; Shadley et al. 1991). Gene mutations were induced by irradiation of CHO cells with radiation from radon (Jostes et al. 1994). Another study employed an isotope of helium ( $^4\text{He}$ ) to simulate alpha particles from radon progeny and found exposure-induced gene mutations (Jin et al. 1995). Gene mutations were also induced in mouse L5178Y lymphoblasts exposed to alpha radiation from radon (Evans et al. 1993a, 1993b).

#### 3.4 TOXICOKINETICS

In radiation biology, the term *dose* has a specific meaning. Dose refers to the amount of radiation absorbed by the organ or tissue of interest and is expressed in rad (grays). Estimation of this radiation dose to lung tissue or specific cells in the lung from a given exposure to radon and radon progeny is accomplished by modeling the sequence of events involved in the inhalation, deposition, clearance, and decay of radon progeny within the lung. While based on the current understanding of lung morphometry and experimental toxicokinetics data on radon and radon progeny, different models make different assumptions about these processes, thereby resulting in different estimates of dose and risk. These models are described in numerous reports including ICRP (1982), NEA/OECD (1983), NCRP (1984a), Bair (1985), James (1987), EPA (1988), and NAS (1988).

The focus of this section is on describing the empirical basis for our understanding of the toxicokinetics of radon. Physiologically-based models of radon toxicokinetics used in radon radiation dosimetry are described in Section 3.4.5. A complete discussion of toxicokinetics of radon as it relates to the development of adverse health effects in exposed populations (e.g., respiratory tract cancer) must consider the toxicokinetics of radon progeny, which contribute substantially to the internal radiation dose that occurs in association with exposures to radon. While radioactive decay of the short-lived radon progeny, contribute most of the radiation dose to the respiratory tract following exposures to radon, they are sufficiently long-lived, relative to rates of toxicokinetics processes that govern transport and distribution, to exhibit radionuclide-specific toxicokinetics. Rather than providing a detailed review of the toxicokinetics of bismuth, lead, and polonium in this profile; the reader is referred to relevant literature on the toxicokinetics of each radionuclide (Agency for Toxic Substances and Disease Registry 2007; ICRP 1980, 1994c). Ultimately, the longer-term fate of radon progeny in the body will be reflected in the toxicokinetics of longer-lived progeny, which include  $^{210}\text{Pb}$  (radioactive half-life of approximately 21 years) and  $^{206}\text{Pb}$  (stable end product of the  $^{222}\text{Rn}$  decay chain). The reader is referred to the Toxicological Profile for Lead (Agency for Toxic Substances and Disease Registry 2007) for a discussion

### 3. HEALTH EFFECTS

of the toxicokinetics of lead. A further complication in relating radon toxicokinetics to adverse health effects associated with exposure to radon is that radon progeny are present with radon in the environment and are inhaled or ingested along with radon. Progeny formed in the environment contribute substantially to radiation dose associated with environments that contain radon gas (Kendall and Smith 2002).

#### 3.4.1 Absorption

##### 3.4.1.1 Inhalation Exposure

Inhalation exposures to radon gas deliver the gas into the respiratory tract along with aerosols of radon progeny (e.g.,  $^{214}\text{Bi}$ ,  $^{214}\text{Pb}$ ,  $^{218}\text{Po}$ ) that form as a result of the progeny reacting with natural aerosols in the air (Marsh and Birchall 2000). Longer-lived radon progeny (e.g.,  $^{210}\text{Pb}$  and  $^{210}\text{Po}$ ) contribute little to the radiation dose to lung tissue because they have a greater likelihood of being physically cleared from the lung by mucociliary or cellular transport mechanisms before they can decay and deliver a significant radiation dose.

Progeny aerosol formation involves distinct physical-chemical processes (Butterweck et al. 2002; El-Hussein et al. 1998; Ishikawa et al. 2003b): (1) immediately after formation, progeny react with gases and vapors and form clusters, referred to as *unattached* particles, having diameters of approximately 0.5–3 nm or (2) unattached particles form complexes with other aerosols in air to form *attached* particles, which can undergo hygroscopic growth to achieve diameters ranging from approximately 50 to 1,500 nm. The magnitude of the unattached fraction in inhaled air depends on the concentration and size distribution of aerosols in the ambient environment, and will vary with the exposure conditions (e.g., indoor, outdoor) and activities of the individual (e.g., sleeping, activities that release particulates into the air) (Marsh and Birchall 2000). The unattached fraction for typical indoor environments has been estimated to be 5–20% of the total airborne potential alpha energy concentration (PAEC) (Porstendörfer 1994, 2001). The PAEC gives a measure for the potential energy originating from the alpha decays of radon progeny in air. Smoking and other aerosol-generating activities (e.g., vacuum cleaning, cooking, fireplace and circulating fan usage) will decrease the unattached fraction and dose (Sun 2008).

Deposition and the subsequent absorption of inhaled radon and radioactive decay progeny are influenced by physiological factors as well as chemical and physical characteristics of the radionuclides and carrier aerosols. Radon is a relatively nonreactive gas, and deposition and absorption will be determined largely by its solubility in tissues and blood flow to the lungs. The blood:air partition coefficient for radon has been estimated to be approximately 0.4 (Nussbaum and Hursh 1957; Sharma et al. 1997); therefore, at

## 3. HEALTH EFFECTS

steady-state, the blood concentration of radon will be approximately 0.4 times the concentration of radon in lung air. Assuming rapid (i.e., near-instantaneous) partitioning of radon between air and blood, the absorption clearance of radon gas from air in the lung will be governed by the blood flow to the lung (i.e., absorption rate will be flow-limited). At a blood flow to the lung of 5.3 L/minute in an adult, and lung air volume of 2.82 L, the  $t_{1/2}$  for absorption of radon from lung to blood would be approximately 0.4 min (rate constant=113 hours<sup>-1</sup>) (Peterman and Perkins 1988). A similar value was estimated for the  $t_{1/2}$  for clearance of radon gas from the lung air to external air ( $t_{1/2}$ =0.4 minute; rate constant=115 hours<sup>-1</sup>) (Peterman and Perkins 1988). Rapid clearance of radon gas from the lung by absorption and exhalation will result in steady-state concentrations of radon in blood within 2–3 minutes of initiating exposure to radon gas. Clearance of radon from the blood following removal from exposure will be governed by blood flow rates to major tissue depots for radon (see Section 3.4.2).

Exposures to radon in air occur along with exposures to aerosols of radon progeny, which will deposit on the lung epithelia. The amounts and location of deposition of radon progeny will be determined by factors that influence convection, diffusion, sedimentation, and interception of particles in the airways. These factors include air flow velocities, which are affected by breathing rate and tidal volume; airway geometry; and aerosol particle size (Cohen 1996; James et al. 1994; Kinsara et al. 1995; Marsh and Birchall 2000; Yu et al. 2006). Radon progeny consist of a mixed distribution of unattached and attached particles. Assuming activity median aerodynamic diameters (AMAD) of approximately 1–3 nm for the unattached fraction and 100–200 nm for attached particles (Butterweck et al. 2002; Ishikawa et al. 2003b), deposition fractions of inhaled radon progeny can be estimated from models of particle deposition in the human respiratory tract (ICRP 1994b). The deposition fraction (i.e., percent of total number of inhaled particles that deposit) for unattached particles is predicted to be approximately 97–99%, with most of the deposition (70–80%) occurring in the extrathoracic region of the respiratory tract. The deposition fraction for attached particles is predicted to be approximately 20–40% with most of the deposition occurring in the alveolar region. Deposition will occur more predominantly in the nasal airways when breathing occurs through the nose. These predictions are based on the ICRP (1994b) human respiratory tract model assuming recommended values for deposition fractions for adult members of the general public exposed to homogeneous aerosols, and will vary with different assumptions for breathing rate and ratio of nose-to-mouth breathing (ICRP 2001). Predictions that deposition will be higher for the unattached fraction compared to the attached fraction and higher for nose-breathing exposures are in reasonable agreement with experiments conducted in humans exposed to heterogeneous distributions of aerosols of radon progeny (Booker et al. 1969; George and Breslin 1967, 1969; Holleman et al. 1969; Hursh and Mercer 1970; Hursh et al. 1969a; Ishikawa et al. 2003b; Pillai et al. 1994; Swift

## 3. HEALTH EFFECTS

and Strong 1996) and with experiments conducted using casts of the human respiratory tract (Chamberlain and Dyson 1956; Cohen 1996; Kinsara et al. 1995; Martin and Jacobi 1972). The deposition fraction in subjects who inhaled (nose-only) 0.5–0.6-nm particles of  $^{218}\text{Po}$  was estimated to be approximately 94–99% (Swift and Strong 1996). Near complete deposition (>99%) was observed in an adult subject who inhaled (mouth-only) unattached particles of  $^{212}\text{Pb}$  formed from decay of  $^{220}\text{Rn}$  in a low ambient aerosol environment, whereas the deposition fraction was 34–60% when the exposure was to aerosols formed in room air and having a particle size range of 50–500 nm, more typical of attached particles (Booker et al. 1969). Deposition fractions for radon progeny have been measured during exposures to aerosols in underground uranium mines (George and Breslin 1969; Holleman et al. 1969). Deposition fractions increased with increasing tidal volume, and decreased with increasing aerosol aerodynamic diameter, from 50–70% for diameters <10 nm to 30–40% for diameters >70 nm. Hursh and Mercer (1970) estimated thoracic deposition (i.e., total of bronchi, bronchioles, and alveolar region) based on external gamma counting of the chest area of  $^{212}\text{Pb}$  produced from decay of  $^{220}\text{Rn}$  and inhaled (mouth-only) as aerosols having AMADs of 20–25 or 200–230 nm. The deposition fractions in adult subjects were approximately 50–62% for the smaller particles and 27–38% for the larger particles. When adult subjects inhaled (mouth-only) natural  $^{212}\text{Pb}$  aerosols generated from  $^{220}\text{Rn}$  decay in room air, the measured deposition fractions ranged from 14–45% (Hursh et al. 1969a). Pillai et al. (1994) made chest gamma measurements on four subjects who were exposed to  $^{212}\text{Pb}$  aerosols for 10–60 minutes in a thorium hydroxide storage facility. The particle size of the  $^{212}\text{Pb}$  aerosol was approximately 90 nm. Deposition fraction was estimated to have been 55–76%.

Particles containing radon progeny that deposit in the respiratory tract are subject to three general clearance processes: (1) mucociliary transport to the gastrointestinal tract for progeny deposited in the ciliated airways (i.e., trachea, bronchi, and bronchioles); (2) phagocytosis by lung macrophages and cellular transport to lymph nodes (e.g., lung, tracheobronchial, mediastinal); or (3) absorption and transfer by blood and/or lymph to other tissues. The above processes apply to all forms of deposited radon progeny, although the relative contributions of each pathway and rates associated with each pathway may vary with the physical characteristics (e.g., particle size), chemical form (degree of water solubility), and radiological characteristics (e.g., specific activity).

Absorption half-times ( $t_{1/2}$ ) have been estimated for radon decay progeny in adults who inhaled aerosols of lead and bismuth isotopes generated from decay of  $^{220}\text{Rn}$  or  $^{222}\text{Rn}$ . Values for  $^{212}\text{Pb}$  and  $^{212}\text{Bi}$  in an aerosol having an activity median particle diameter of approximately 160 nm (range 50–500 nm), a value typical of attached radon progeny particles, were estimated to be approximately 10 and 13 hours,

## 3. HEALTH EFFECTS

respectively (Marsh and Birchall 1999). The latter estimates were based on an analysis of data from human inhalation exposures to  $^{212}\text{Pb}$  and  $^{212}\text{Bi}$  progeny of  $^{220}\text{Rn}$  (Booker et al. 1969; Hursh and Mercer 1970; Hursh et al. 1969a; Jacobi 1964; Pillai et al. 1994). However, absorption of unattached radon progeny may be faster than that of attached progeny. Butterweck et al. (2002) exposed nose- or mouth-breathing human subjects to  $^{222}\text{Rn}$ -derived aerosols that had diameters of approximately 0.3–3 nm, typical of unattached progeny particles. Absorption half-times were estimated to be approximately 68 minutes (range 56–86) for  $^{218}\text{Po}/^{214}\text{Pb}$  and 18 minutes (range 17–21) for  $^{214}\text{Bi}$ . Binding of unattached radon progeny in the respiratory tract may result in slower absorption kinetics. Butterweck et al. (2002) proposed that a 10-hour  $t_{1/2}$  would apply to the unattached fraction after binding in the respiratory tract, and that the unbound fraction may have an absorption  $t_{1/2} < 10$  minutes. This behavior would be consistent with dissolution of deposited particles being the rate-limiting step in absorption and smaller particles dissolving faster than larger particles.

**3.4.1.2 Oral Exposure**

Exposure to radon by the oral route can occur as a result of radon gas dissolving in water. At equilibrium, the concentration of radon dissolved in water will be approximately 0.25 of that in air (i.e., Henry's law constant=4.08 at 20°C) (NAS 1999b). Radioactive decay of radon in water produces radon progeny; therefore, ingestion of water containing dissolved radon will also result in ingestion of radon progeny. Absorption of radon is thought to occur primarily in the stomach and small intestine, although some absorption may also occur in the large intestine (Ishikawa et al. 2003a; Khursheed 2000; NAS 1999b). Radon is relatively nonreactive and its absorption from the stomach will be determined largely by rates of diffusion of radon from stomach contents to vascularized mucosa; its solubility in the stomach tissues and blood; blood flow to the stomach; and rates of transfer of stomach contents into the intestine (Ishikawa et al. 2003a; NAS 1999b). Diffusion of radon from stomach contents to stomach tissues may be rate-limiting in absorption (NAS 1999b). However, assuming rapid (i.e., near-instantaneous) partitioning of radon from vascularized mucosa to blood, the absorption clearance of radon from stomach mucosa will be governed by the blood flow rate to the stomach (i.e., absorption rate will be flow-limited). At a stomach blood flow of 1% of cardiac output (1% of 6.5 L/minute in an adult), and stomach wall volume of approximately 0.15 L (NAS 1999b), the  $t_{1/2}$  for absorption of radon from the stomach wall to blood would be approximately 1.6 minutes (rate constant=0.43  $\text{minute}^{-1}$ ). An absorption  $t_{1/2}$  of 1–2 minutes is consistent with observations of peak blood radon concentrations and peak radon concentrations in exhaled air within 5 minutes following ingestion of radon in water by adults (Brown and Hess 1992; Hursh et al. 1965; Sharma et al. 1997).



### 3. HEALTH EFFECTS

Kinetics of absorption of radon progeny are more complex, reflecting different mechanisms (e.g., membrane cation transport proteins and channels) and sites of absorption for radon and progeny. Absorption of radon progeny following oral exposure is thought to occur largely in the small intestine (Agency for Toxic Substances and Disease Registry 2007; ICRP 1994c). As a result, absorption of ingested progeny, and progeny formed from radon after ingestion, will be influenced by rates of transfer of stomach contents into the small intestine, as well as rates of absorption of progeny from the small intestine. Ishikawa et al. (2003a) used external gamma counting to measure the kinetics of elimination of  $^{214}\text{Pb}$  and  $^{214}\text{Bi}$  from the stomach following ingestion of water containing radon. Elimination kinetics from the stomach exhibited multiple components, with a fast phase (40–50% of ingested activity) having a  $t_{1/2}$  value of approximately 10 minutes and two slower phases having  $t_{1/2}$  values of 150 and 240 minutes. The presence of food in the stomach delays stomach emptying and may alter the absorption kinetics of radon and progeny (Brown and Hess 1992; Hursh et al. 1965; Suomela and Kahlos 1972). ICRP (1995, 2001) recommends values of 0.05 and 0.1 as gastrointestinal absorption fractions for bismuth and polonium, respectively. The absorption fraction for ingested inorganic lead varies with age; from 40 to 50% in infants and children to approximately 8–15% in adults (Agency for Toxic Substances and Disease Registry 2007; Leggett 1993; O’Flaherty 1993).

#### 3.4.1.3 Dermal Exposure

Data regarding the absorption of radon following dermal exposure are very limited. Dermal absorption of radon has been measured in subjects after bathing in a radon-water spa (Furuno 1979; Pohl 1965) or after application of a radon-containing ointment to the intact skin (Lange and Evans 1947). After bathing for 5–15 minutes, radon concentrations in expired air reached approximately 0.9% of that in the water and ranged from 17.9 to 49.1 pCi/L of air ( $662\text{--}1,817\text{ Bq/m}^3$ ) compared to pre-bath levels of  $<1$  pCi/L of air ( $37\text{ Bq/m}^3$ ). Radon concentrations in the water were reported by the authors as 5,800 pCi (215 Bq)/kg. However, the relative contributions of the dermal and inhalation routes of absorption cannot be determined in these studies (Furuno 1979). Radon concentrations in blood reached 0.85–1% of the radon concentration in the bath water, which was  $1.8 \times 10^5$  pCi ( $4.9 \times 10^6$  Bq)/L of water after 30–40 minutes of bathing while breathing compressed air (Pohl 1965). Approximately 4.5% of the radon applied in ointment to intact skin was measured in expired air within 24 hours following application (Lange and Evans 1947).

### 3. HEALTH EFFECTS

Peterman and Perkins (1988) proposed a model for simulating the absorption of radon, based on a model largely parameterized to simulate absorption of xenon gas through the skin. Although parameter values for radon were not reported and skin penetration of radon was not modeled, the general structure is potentially relevant to estimating radon absorption rates. In the Peterman and Perkins (1988) model, the rate-limiting step in dermal absorption was considered to be the diffusion of xenon through the skin to the subcutaneous fat. Transfer from subcutaneous fat to blood was assumed to be flow-limited and determined by blood flow to subcutaneous fat. Peterman and Perkins (1988) estimated the dermal diffusion rate of xenon to be approximately  $0.18 \text{ hour}^{-1}$ . This rate would be equivalent to a  $t_{1/2}$  value of approximately 4 hours and is substantially slower than the  $t_{1/2}$  for absorption from lung ( $t_{1/2}=0.4$  minutes; rate constant= $115 \text{ hours}^{-1}$ ) (Peterman and Perkins 1988). The corresponding  $t_{1/2}$  value for absorption from subcutaneous fat was approximately 38 minutes (rate= $0.018 \text{ minute}^{-1}$ ), assuming a blood flow of  $0.16 \text{ L/minutes}$  and a tissue volume of  $8.2 \text{ L}$ .

#### 3.4.2 Distribution

##### 3.4.2.1 Inhalation Exposure

Based on studies conducted in animals, the distribution of absorbed radon appears to reflect its solubility in water and fat. Nussbaum and Hursh (1957) exposed rats to radon gas in an enclosed exposure chamber (whole body) for periods of 30 minutes to 48 hours and measured tissue radon levels at the conclusion of the exposure. The highest radon concentrations were observed in fat. Tissue:air concentration ratios were as follows (mean $\pm$ standard error [SE]): omental fat  $4.83\pm 0.07$ , venous blood  $0.405\pm 0.016$ , brain  $0.309\pm 0.008$ , liver  $0.306\pm 0.004$ , kidney  $0.285\pm 0.012$ , heart  $0.221\pm 0.013$ , testis  $0.184\pm 0.007$ , and skeletal muscle  $0.154\pm 0.005$ . Tissue:air ratios for soft tissues reported by Nussbaum and Hursh (1957) are close to those expected for a Henry's law constant of 4 (i.e., water:air=0.25) and a lipid:air partition coefficient of 6 (Nussbaum and Hursh 1957). For example, assuming fat and water contents of soft tissue of 5 and 70%, respectively, in the rat (Davies and Morris 1993), the tissue:air ratio for soft tissue would be approximately 0.36 if solubility in water and fat were the only determinants of tissue radon levels. The corresponding fat:air ratio would be 5.85 for a lipid content of adipose tissue of 80% and water content of 15%. The tissue:air ratios reported in Nussbaum and Hursh (1957) are the bases of tissue:blood partition coefficients that have been used in various biokinetics models (e.g., Khursheed 2000; NAS 1999b; Peterman and Perkins 1988; Sharma et al. 1997).

Nussbaum and Hursh (1957) also reported information on the kinetics of uptake of inhaled radon in tissues. In all tissues studied, except fat, steady-state levels of radon were achieved within 1 hour of

## 3. HEALTH EFFECTS

initiating a continuous inhalation exposure. Uptake into omental fat was slower and exhibited fast and slow components having  $t_{1/2}$  values of 21 and 138 minutes, respectively. The slower uptake kinetics of fat may reflect, in part, the relatively slower blood perfusion of adipose tissue (per unit mass of tissue) compared to other soft tissues. Similarly, relatively slow perfusion of fat should contribute a slower component to total body elimination kinetics following cessation of exposure to radon (see Section 3.4.3).

Information about the distribution of absorbed radon progeny, bismuth, lead, and polonium can be found in reviews of these subjects (Agency for Toxic Substances and Disease Registry 2007; ICRP 1980, 1994c, 1995). A relatively large fraction of inhaled  $^{212}\text{Pb}$  (inhaled as natural  $^{212}\text{Pb}$  aerosols generated from  $^{220}\text{Rn}$  decay in room air) distributes to red blood cells (Booker et al. 1969; Hursh et al. 1969a). Red cell  $^{212}\text{Pb}$  burdens, expressed as percent of the lead initially deposited in the respiratory tract, increased from approximately 5% within 1–2 hours following exposure to approximately 50% at times >24 hours following exposure (Hursh et al. 1969a). Long-lived ( $^{210}\text{Pb}$ ) and stable progeny ( $^{206}\text{Pb}$ ,  $^{207}\text{Pb}$ , and  $^{208}\text{Pb}$ ), can be expected to deposit and be retained in bone, where approximately 90% of the total lead body burden resides (Agency for Toxic Substances and Disease Registry 2007). Following chronic exposure in humans,  $^{210}\text{Pb}$  has been found in bone (Black et al. 1968; Blanchard et al. 1969; Cohen et al. 1973; Fry et al. 1983) and teeth (Clemente et al. 1982, 1984). ICRP (1980, 2001) recommends, for the purpose of modeling bismuth-derived radiation doses, that 40% of absorbed bismuth distributes to kidneys and 30% to other tissues; the remaining 30% is assumed to be excreted rapidly and does not contribute to distribution beyond the central compartment. Retention in kidneys and other tissues are assumed to be the same (elimination  $t_{1/2}$  values of 0.6 and 5 days for fast and slow phases); therefore, approximately 40% of the body burden of bismuth would be in the kidneys. ICRP (1994c, 2001) recommends the following values for percentages of absorbed polonium distributed to tissues: 30% liver, 10% kidney, 10% red marrow, 5% spleen, and 45% other tissues. Retention in all tissues is assumed to be the same (elimination  $t_{1/2}$ =50 days); therefore, the latter percent distributions will reflect the distribution of the body burden of polonium (e.g., 30% in liver).

### 3.4.2.2 Oral Exposure

Measurements of the tissue distribution of radon or progeny following ingestion of radon have not been reported. However, as discussed in Section 3.4.2.1, the distribution of absorbed radon appears to reflect its solubility in water and fat; therefore, steady-state distribution following absorption from the gastrointestinal tract would be determined by tissue:blood partition coefficients and the rate of approach to steady state would be determined by tissue blood flows. Based on tissue:air ratios reported by

### 3. HEALTH EFFECTS

Nussbaum and Hursh (1957) during inhalation exposures of rats (see Section 3.4.2.1 for further discussion), the following tissue:blood ratios (i.e., tissue:blood=tissue:air/blood:air) can be estimated for radon in the rat: omental fat 12, brain 0.76, liver 0.76, kidney 0.70, heart 0.55, testes 0.45, and skeletal muscle 0.38. Therefore, the highest concentrations of radon would be predicted for adipose tissues.

Distribution of absorbed radon progeny would be expected to be similar to the distribution following inhalation exposures, although, first-pass delivery to the liver from the gastrointestinal tract may influence the tissue distribution. As discussed in Section 3.4.2.1, the largest fractions of the body burdens for radon progeny would be expected to be found in bone for lead, kidney for bismuth, and liver for polonium (Agency for Toxic Substances and Disease Registry 2007; ICRP 1980, 1994c, 2001).

#### 3.4.2.3 Dermal Exposure

No studies were located regarding distribution in humans or laboratory animals after dermal exposure to radon or its progeny. However, as discussed in Sections 3.4.2.1 and 3.4.2.2, the distribution of absorbed radon appears to reflect its solubility in water and fat; therefore, steady-state distribution following absorption from the skin would be determined by tissue:blood partition coefficients and the rate of approach to steady state would be determined by tissue blood flows.

#### 3.4.3 Metabolism

Radon is an inert noble gas that does not interact chemically with cellular macromolecules. Radon does not undergo metabolism in biological systems.

#### 3.4.4 Elimination and Excretion

##### 3.4.4.1 Inhalation Exposure

Measurements of exhaled radon following ingestion of radon dissolved in water indicate that absorbed radon is rapidly excreted in exhaled air (see Section 3.4.4.2). Inhaled  $^{212}\text{Pb}$  is excreted in urine and feces. Hursh et al. (1969a) estimated that, following inhalation of natural  $^{212}\text{Pb}$  aerosols generated from  $^{220}\text{Rn}$  decay in room air, 3% of the amount initially deposited in the respiratory tract was excreted in urine per day and approximately 3%/day was excreted in feces. Longer-term kinetics of excretion of  $^{210}\text{Pb}$  following chronic exposures to radon progeny may be contributed from slow release of  $^{210}\text{Pb}$  accumulated in bone (Black et al. 1968). Additional information on the elimination of inhaled radon progeny can be found in reviews of the biokinetics of bismuth, lead, and polonium (Agency for Toxic Substances and

## 3. HEALTH EFFECTS

Disease Registry 2007; ICRP 1980, 1994c, 2001). ICRP (1995, 2001) recommends the following values for the purpose of modeling bismuth-derived radiation doses: a urine:fecal excretion ratio of 1:1 and elimination  $t_{1/2}$  values of 0.6 (60% of issue burden) and 5 days (40% of tissue burden) for fast and slow phases, respectively. ICRP (1995, 2001) recommends the following values for elimination of polonium from tissues into urine and feces: a urine:fecal excretion ratio of 1:2 and an elimination  $t_{1/2}$  value of 50 days.

#### 3.4.4.2 Oral Exposure

Measurements of exhaled radon following ingestion of radon dissolved in water indicate that exhaled air is the dominant route of excretion of ingested radon (Brown and Hess 1992; Gosink et al. 1990; Hursh et al. 1965). Biological elimination kinetics of absorbed radon in exhaled air exhibit multiple phases, with the first half-time ranging from 15 to 80 minutes (Brown and Hess 1992; Gosink et al. 1990; Hursh et al. 1965). Hursh et al. (1965) estimated the following  $t_{1/2}$  values for fast, moderate and slow phases of biological elimination: approximately 13 minutes (61% of body burden), 19 minutes (34%), and 207 minutes (5%), respectively; 95% of the dose was eliminated within 100 minutes. The slow phase of elimination is consistent with observations made in rats of relatively slow accumulation of radon in adipose tissue during continuous inhalation exposures to radon (Nussbaum and Hursh 1957). The latter  $t_{1/2}$  values were estimated for subjects who ingested radon in water during fasting. In a subject who ingested radon in water with a meal, moderate and slow phases of elimination appeared to be delayed, with approximate  $t_{1/2}$  values of 12 minutes (39% of body burden), 60 minutes (51%), and 300 minutes (10%), respectively. Slowing of elimination when radon is ingested with a meal or with lipid has been observed in several studies and may be related to a delay in stomach emptying that alters the absorption kinetics of radon and progeny (Brown and Hess 1992; Hursh et al. 1965; Meyer 1937; Suomela and Kahlos 1972; Vaternahm 1922).

Suomela and Kahlos (1972) estimated radon elimination kinetics in adults who ingested radon in water by monitoring external gamma-radiation from  $^{214}\text{Bi}$  (i.e., assuming  $^{214}\text{Bi}$ : $^{222}\text{Rn}$  disequilibrium ratios ranging from 0.4 to 1). Biological elimination  $t_{1/2}$  values ranged from 30 to 50 minutes; these are consistent with estimates based on exhaled radon as described above. Out of 10 subjects,  $^{214}\text{Bi}$  was detected in urine in two subjects (0.4 and 1.8% of ingested  $^{214}\text{Bi}$  dose; duration of urine collection was not reported). Additional information on the elimination of ingested radon progeny can be found in reviews of the biokinetics of bismuth, lead, and polonium (Agency for Toxic Substances and Disease Registry 2007; ICRP 1980, 1994c, 2001). In general, the rates and routes of elimination of each progeny absorbed from

### 3. HEALTH EFFECTS

the gastrointestinal and respiratory tracts are likely to be similar. Information on elimination of inhaled radon progeny is discussed in Section 3.4.4.1.

#### **3.4.4.3 Dermal Exposure**

Information on the excretion of radon and its progeny following dermal exposure is very limited. Within 24 hours, 4.5% of the radon, which was applied as a salve to intact human skin, was eliminated by exhalation, while 10% was exhaled after application of the radon to an open wound (Lange and Evans 1947). Bathers breathing compressed air while immersed in radon-containing water had exhaled approximately one-third of radon measured in blood immediately after bathing (Pohl 1965). By 6–8 minutes after bathing, these persons were exhaling one-half of the amounts exhaled immediately after bathing. The author stated that the remaining radon which distributed to fatty tissue was excreted more slowly.

#### **3.4.4.4 Other Routes of Exposure**

Experiments in animals have reported the retention of radon after exposure by the intraperitoneal and intravenous routes. Following intravenous administration, 1.6–5.0% of the administered activity was retained in the animals after 120 minutes (Hollcroft and Lorenz 1949). Retention was greatest at 120 minutes following intraperitoneal administration, but by 240 minutes, it was nearly the same for both routes of administration. These authors also reported that the amount of radon retained in tissues was greater in obese mice than in normal mice, especially after intraperitoneal administration (Hollcroft and Lorenz 1949). Radon retention has also been studied in dogs following intravenous administration of  $^{226}\text{Ra}$ . The amount of radon in bone was found to increase with increasing time after injection (Mays et al. 1975).

#### **3.4.5 Physiologically Based Pharmacokinetic (PBPK)/Pharmacodynamic (PD) Models**

Physiologically based pharmacokinetic (PBPK) models use mathematical descriptions of the uptake and disposition of chemical substances to quantitatively describe the relationships among critical biological processes (Krishnan et al. 1994). PBPK models are also called biologically based tissue dosimetry models. PBPK models are increasingly used in risk assessments, primarily to predict the concentration of potentially toxic moieties of a chemical that will be delivered to any given target tissue following various combinations of route, dose level, and test species (Clewell and Andersen 1985). Physiologically based

## 3. HEALTH EFFECTS

pharmacodynamic (PBPD) models use mathematical descriptions of the dose-response function to quantitatively describe the relationship between target tissue dose and toxic end points.

PBPK/PD models refine our understanding of complex quantitative dose behaviors by helping to delineate and characterize the relationships between: (1) the external/exposure concentration and target tissue dose of the toxic moiety, and (2) the target tissue dose and observed responses (Andersen and Krishnan 1994; Andersen et al. 1987). These models are biologically and mechanistically based and can be used to extrapolate the pharmacokinetic behavior of chemical substances from high to low dose, from route to route, between species, and between subpopulations within a species. The biological basis of PBPK models results in more meaningful extrapolations than those generated with the more conventional use of uncertainty factors.

The PBPK model for a chemical substance is developed in four interconnected steps: (1) model representation, (2) model parameterization, (3) model simulation, and (4) model validation (Krishnan and Andersen 1994). In the early 1990s, validated PBPK models were developed for a number of toxicologically important chemical substances, both volatile and nonvolatile (Krishnan and Andersen 1994; Leung 1993). PBPK models for a particular substance require estimates of the chemical substance-specific physicochemical parameters, and species-specific physiological and biological parameters. The numerical estimates of these model parameters are incorporated within a set of differential and algebraic equations that describe the pharmacokinetic processes. Solving these differential and algebraic equations provides the predictions of tissue dose. Computers then provide process simulations based on these solutions.

The structure and mathematical expressions used in PBPK models significantly simplify the true complexities of biological systems. If the uptake and disposition of the chemical substance(s) are adequately described, however, this simplification is desirable because data are often unavailable for many biological processes. A simplified scheme reduces the magnitude of cumulative uncertainty. The adequacy of the model is, therefore, of great importance, and model validation is essential to the use of PBPK models in risk assessment.

PBPK models improve the pharmacokinetic extrapolations used in risk assessments that identify the maximal (i.e., the safe) levels for human exposure to chemical substances (Andersen and Krishnan 1994). PBPK models provide a scientifically sound means to predict the target tissue dose of chemicals in humans who are exposed to environmental levels (for example, levels that might occur at hazardous waste

### 3. HEALTH EFFECTS

sites) based on the results of studies where doses were higher or were administered in different species. Figure 3-1 shows a conceptualized representation of a PBPK model.

PBPK models for radon are discussed in this section in terms of their use in risk assessment, tissue dosimetry, and dose, route, and species extrapolations. For radionuclides, the PBPK model depicted in Figure 3-1 is replaced with a set of physiologically based biokinetic (PBBK) models for inhalation, ingestion, and submersion. These were developed to accomplish virtually the same end as the PBPK models above, while integrating additional parameters (for radioactive decay, particle and photon transport, and compound-specific factors). Goals are to facilitate interpreting chest monitoring and bioassay data, assessing risk, and calculating radiation doses to a variety of tissues throughout the body. The standard for these models has been set by the ICRP, and their models receive international support and acceptance. ICRP periodically considers newer science in a type of weight of evidence approach toward improving the state of knowledge and reducing uncertainties associated with applying the model to any given radionuclide. ICRP publications also allow for the use of situation- and individual-specific data to reduce the overall uncertainty in the results. Even though there may be conflicting data for some parameters, such as absorption factors, one can use conservative values and still reach conclusions on whether the dose is below recommended limits. One of the strengths of the ICRP model is that it permits the use of experimentally determined material-specific absorption parameter values rather than requiring the use of those provided for default types. If the material of interest does not include absorption parameter values that correspond to those in the model (e.g., Type F, M, or S), the difference can have a profound effect on the assessment of intake and dose from bioassay measurements. This has been discussed in National Radiological Protection Board (NRPB) published reports on uranium (NRPB 2002).

The ICRP (1994b, 1996a) developed a Human Respiratory Tract Model for Radiological Protection, which contains respiratory tract deposition and clearance compartmental models for inhalation exposure that may be applied to particulate aerosols and gases. The National Council on Radiation Protection and Measurements (NCRP) has also developed a respiratory tract model for inhaled radionuclides (NCRP 1997). At this time, the NCRP recommends the use of the ICRP model for calculating exposures for radiation workers and the general public. Readers interested in this topic are referred to NCRP Report No. 125; Deposition, Retention and Dosimetry of Inhaled Radioactive Substances (NCRP 1997).

Models developed to simulate radiation doses emanating from inhalation exposures to radon account for the deposition and clearance of radon gas as well as aerosols of radon progeny (Yu et al. 2006). Several radiation dose models for inhaled and/or ingested radon gas and progeny in humans have been reported



## 3. HEALTH EFFECTS

**Figure 3-1. Conceptual Representation of a Physiologically Based Pharmacokinetic (PBPK) Model for a Hypothetical Chemical Substance**

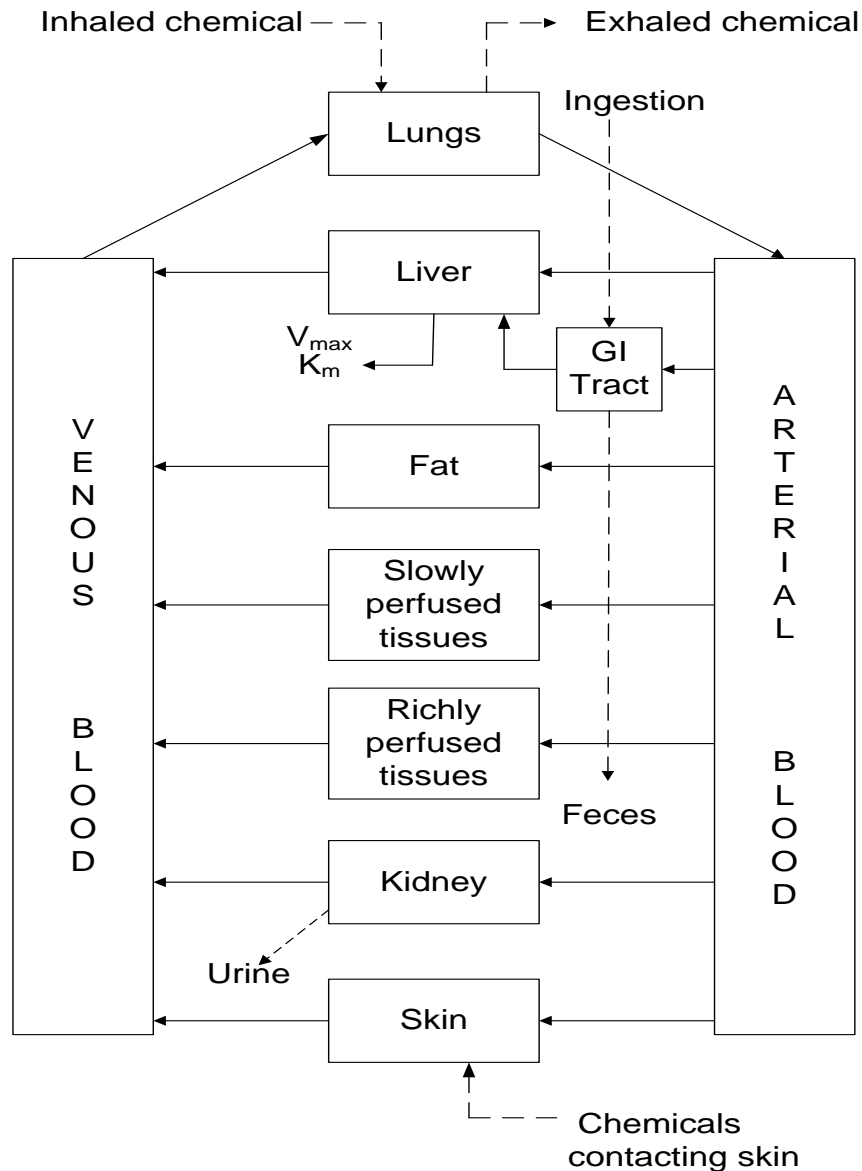

Note: This is a conceptual representation of a physiologically based pharmacokinetic (PBPK) model for a hypothetical chemical substance. The chemical substance is shown to be absorbed via the skin, by inhalation, or by ingestion, metabolized in the liver, and excreted in the urine or by exhalation.

Source: adapted from Krishnan and Andersen 1994

## 3. HEALTH EFFECTS

(Birchall and James 1994; Crawford-Brown 1989; El-Hussein et al. 1998; Harley and Robbins 1994; Ishikawa et al. 2003a, 2003b; James et al. 2004; Khursheed 2000; Marsh and Birchall 2000; NAS 1999b; Peterman and Perkins 1988; Porstendörfer, 2001; Sharma et al. 1997). Some of these are extensions or modifications of the ICRP (1994b) model that simulates deposition, clearance, and absorption of inhaled gaseous and particulate radionuclides in the human respiratory tract. An example of the latter is the Radon Dose Evaluation Program (RADEP), which has been used extensively in risk assessment of exposures to radon and radon progeny (Birchall and James 1994; Marsh and Birchall 2000). Two other extensions of the ICRP (1994b) model that have been widely applied to radon radiation risk assessment are those of Porstendörfer (2001) and James et al. (2004), which implement different approaches to the simulation of attached and unattached particles (e.g., fractional distributions in inhaled air and hygroscopic growth) and/or effective radiation dose calculations (e.g., tissue weighting factors for radon progeny in respiratory tract tissues). The structure of the biokinetics portion of the generic ICRP human respiratory tract model is described below, along with modifications that have been reported for applications to radon (e.g., RADEP). Systemic distribution and excretion of radon progeny are simulated with models specific for the progeny radionuclides. Descriptions of ICRP models for bismuth, lead, and polonium are reported elsewhere (Agency for Toxic Substances and Disease Registry 2007; ICRP 1979, 1994c, 1995; Leggett 1993).

Most physiologically based models of radon biokinetics simulate radon transfers between tissues and blood as flow-limited processes in which clearance is determined by tissue blood flow and tissue concentrations are defined by tissue:blood partition coefficients (Crawford-Brown 1989; Harley and Robbins 1994; Khursheed 2000; NAS 1999b; Peterman and Perkins 1988; Sharma et al. 1997). The model proposed by Peterman and Perkins (1988) was actually developed to simulate noble gases (e.g., xenon); however, it has been applied to radon biokinetics (Peterman and Perkins 1988; Sharma et al. 1997). A unique feature of the model is that it included parameters for simulating absorption of xenon gas through the skin, although parameter values for radon were not reported and skin penetration of radon was not modeled (see Section 3.4.1.3 for discussion of possible implications of this model for dermal absorption of radon). The NAS (1999b) and Khursheed (2000) models are described below as examples of flow-limited models that simulate absorption, distribution, and excretion of inhaled or ingested radon gas. Both were developed to be used in conjunction with ICRP models of progeny to simulate radiation doses from inhalation or ingestion of radon gas in drinking water.

## 3. HEALTH EFFECTS

**Human Respiratory Tract Model for Radiological Protection (ICRP 1994b)**

**Deposition.** The ICRP (1994b) has developed a deposition model for behavior of aerosols and vapors in the respiratory tract. It was developed to estimate the fractions of radioactivity in breathing air that are deposited in each anatomical region of the respiratory tract. ICRP (1994b) provides inhalation dose coefficients that can be used to estimate radiation doses to organs and tissues throughout the body based on a unit intake of radioactive material. The model applies to three levels of particle solubility, a wide range of particle sizes (approximately 0.0005–100  $\mu\text{m}$  in diameter), and parameter values that can be adjusted for various segments of the population (e.g., sex, age, and level of physical exertion). This model also allows one to evaluate the bounds of uncertainty in deposition estimates. Uncertainties arise from natural biological variability among individuals and the need to interpret some experimental evidence that remains inconclusive. The model has been used for estimating radiation doses from inhalation of radon gas and aerosols of radon progeny; however, it was developed to be applied to a wide variety of radionuclides and their chemical forms.

The ICRP deposition model estimates the fraction of inhaled material initially retained in each compartment (see Figure 3-2). The model was developed with five compartments: (1) the anterior nasal passages ( $\text{ET}_1$ ); (2) all other extrathoracic airways ( $\text{ET}_2$ ) (posterior nasal passages, the naso- and oropharynx, and the larynx); (3) the bronchi (BB); (4) the bronchioles (bb); and (5) the alveolar interstitium (AI). Particles deposited in each of the regions may be removed and redistributed either upward into the respiratory tree or to the lymphatic system and blood by different particle removal mechanisms.

For extrathoracic deposition of particles, the model uses measured airway diameters and experimental data, where deposition is related to particle size and airflow parameters, and scales deposition for women and children from adult male data. Similar to the extrathoracic region, experimental data served as the basis for lung (bronchi, bronchioles, and alveoli) aerosol transport and deposition. A theoretical model of gas transport and particle deposition was used to interpret data and to predict deposition for compartments and subpopulations other than adult males. Table 3-7 provides reference respiratory values for the general Caucasian population during various intensities of physical exertion.

Deposition of inhaled gases and vapors is modeled as a partitioning process that depends on the physiological parameters noted above as well as the solubility and reactivity of a compound in the

3. HEALTH EFFECTS

**Figure 3-2. Compartment Model to Represent Particle Deposition and Time-Dependent Particle Transport in the Respiratory Tract\***

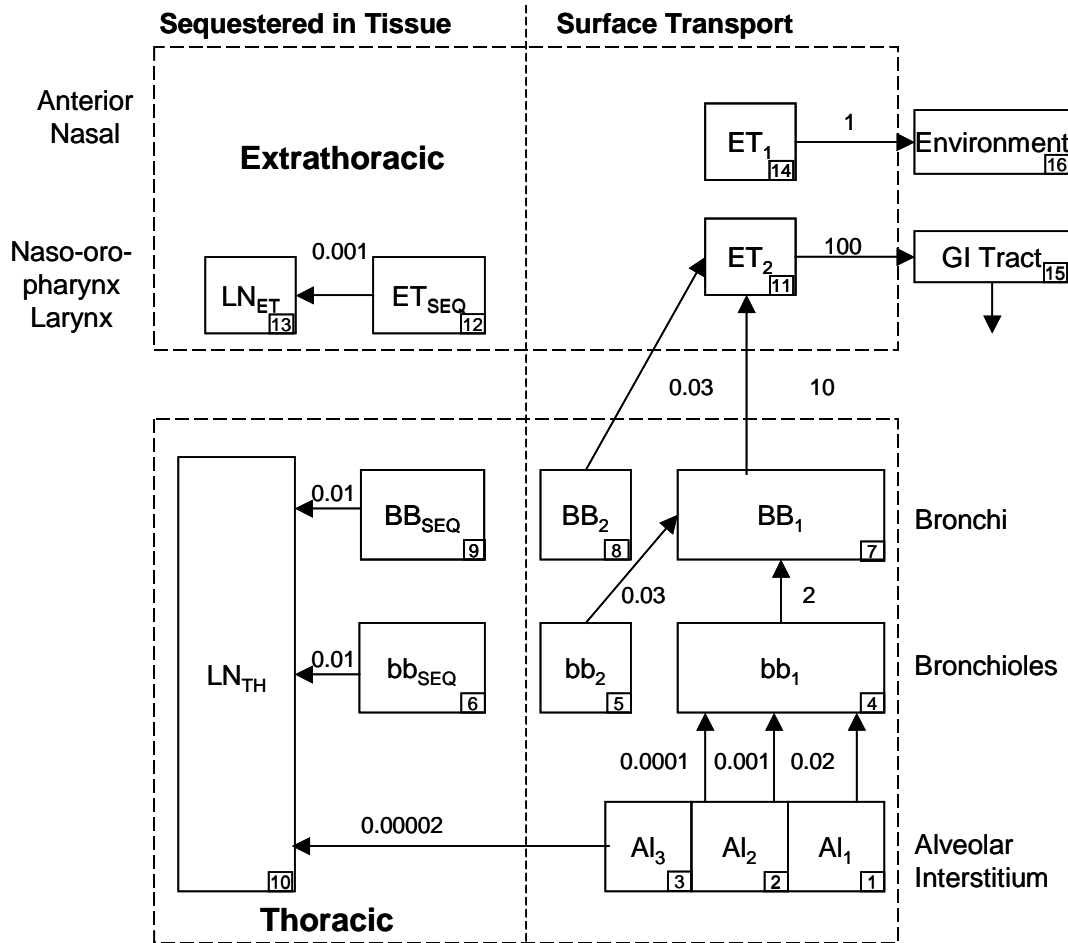

\*Compartment numbers shown in lower right corners are used to define clearance pathways. The clearance rates, half-lives, and fractions by compartment, as well as the compartment abbreviations are presented in Table 3-8.

Source: ICRP 1994b

## 3. HEALTH EFFECTS

**Table 3-7. Reference Respiratory Values for a General Caucasian Population at Different Levels of Activity**

Breathing parameters:	3 Months	1 Year	5 Years	10 Years			15 Years		Adult	
				Male	Female	Both	Male	Female	Male	Female
Resting (sleeping); maximal workload 8%										
Breathing parameters:										
$V_T(L)$	0.04	0.07	0.17	—	—	0.3	0.500	0.417	0.625	0.444
$B(m^3hour^{-1})$	0.09	0.15	0.24	—	—	0.31	0.42	0.35	0.45	0.32
$f_R(minute^{-1})$	38	34	23	—	—	17	14	14	12	12
Sitting awake; maximal workload 12%										
Breathing parameters:										
$V_T(L)$	NA	0.1	0.21	—	—	0.33	0.533	0.417	0.750	0.464
$B(m^3hour^{-1})$	NA	0.22	0.32	—	—	0.38	0.48	0.40	0.54	0.39
$f_R(minute^{-1})$	NA	36	25	—	—	19	15	16	12	14
Light exercise; maximal workload 32%										
Breathing parameters:										
$V_T(L)$	0.07	0.13	0.24	—	—	0.58	1.0	0.903	1.25	0.992
$B(m^3hour^{-1})$	0.19	0.35	0.57	—	—	1.12	1.38	1.30	1.5	1.25
$f_R(minute^{-1})$	48	46	39	—	—	32	23	24	20	21
Heavy exercise; maximal workload 64%										
Breathing parameters:										
$V_T(L)$	NA	NA	NA	0.841	0.667	—	1.352	1.127	1.923	1.364
$B(m^3hour^{-1})$	NA	NA	NA	2.22	1.84	—	2.92	2.57	3.0	2.7
$f_R(minute^{-1})$	NA	NA	NA	44	46	—	36	38	26	33

B = ventilation rate;  $f_R$  = respiration frequency; NA = not applicable;  $V_T$  = tidal volume

Source: See Annex B (ICRP 1994b) for data from which these reference values were derived.

## 3. HEALTH EFFECTS

respiratory tract (see Figure 3-3). The ICRP (1994b) model defines three categories of solubility and reactivity: SR-0, SR-1, and SR-2:

- Type SR-0 compounds include insoluble and nonreactive gases (e.g., inert gases such as H<sub>2</sub>, He). These compounds do not significantly interact with the respiratory tract tissues, and essentially all compound inhaled is exhaled. Radiation doses from inhalation exposure of SR-0 compounds are assumed to result from the irradiation of the respiratory tract from the air spaces.
- Type SR-1 compounds include soluble or reactive gases and vapors which are expected to be taken up by the respiratory tract tissues and may deposit in any or all of the regions of the respiratory tract, depending on the dynamics of the airways and properties of the surface mucous and airway tissues, as well as the solubility and reactivity of the compound.
- Type SR-2 compounds include soluble and reactive gases and vapors which are completely retained in the extrathoracic regions of the respiratory tract. SR-2 compounds include sulfur dioxide (SO<sub>2</sub>) and hydrogen fluoride (HF).

Radon gas is categorized by ICRP (1994b) as SR-1, because, even though it has a low reactivity, it is sufficiently soluble to be taken up in the alveolar region where it can be absorbed into blood. ICRP (1994b) recommended default values for regional distribution of inhaled gases (except for those having low solubility) as follows: 10% ET<sub>1</sub>, 20% ET<sub>2</sub>, 10% BB, 20% bb, and 40% AI. Radon progeny, such as <sup>218</sup>Po, <sup>214</sup>Pb, and <sup>214</sup>Bi are sufficiently reactive to attach to aerosols in the respiratory tract (and external air) and deposit in the respiratory tract according to factors that determine particulate deposition (e.g., sedimentation, inertial impaction, diffusion, and interception). Radon progeny are represented in the ICRP (1994b) model and in extensions of the model (e.g., RADEP) as a mixed distribution of unattached particles (i.e., products of the initial reactions between progeny with gases and vapors) and attached particles (i.e., products of hygroscopic growth of complexes between unattached particles and aerosols in air). AMADs for the two fractions are typically represented in the ICRP model as 1 nm for unattached particles and 200 nm for attached particles (Butterweck et al. 2002; Ishikawa et al. 2003b), although the use of more complex mixed distributions for attached particles has also been used (Marsh and Birchall 2000; Porstendörfer 1994, 2001).

The magnitude of the unattached fraction in inhaled air depends on the concentration and size distribution of aerosols in the ambient environment, and will vary with the exposure conditions (e.g., indoor, outdoor) and activities of the individual (e.g., sleeping, activities that release particulates into the air such as smoking) (Marsh and Birchall 2000). The unattached fraction for typical indoor environments has been estimated to be 5–20% (Porstendörfer 1994, 2001). NRC (1991) recommended a default value of 3% for modeling exposures in homes where smoking occurs and 5% for exposures during cooking or vacuum

3. HEALTH EFFECTS

**Figure 3-3. Reaction of Gases or Vapors at Various Levels of the Gas-Blood Interface**

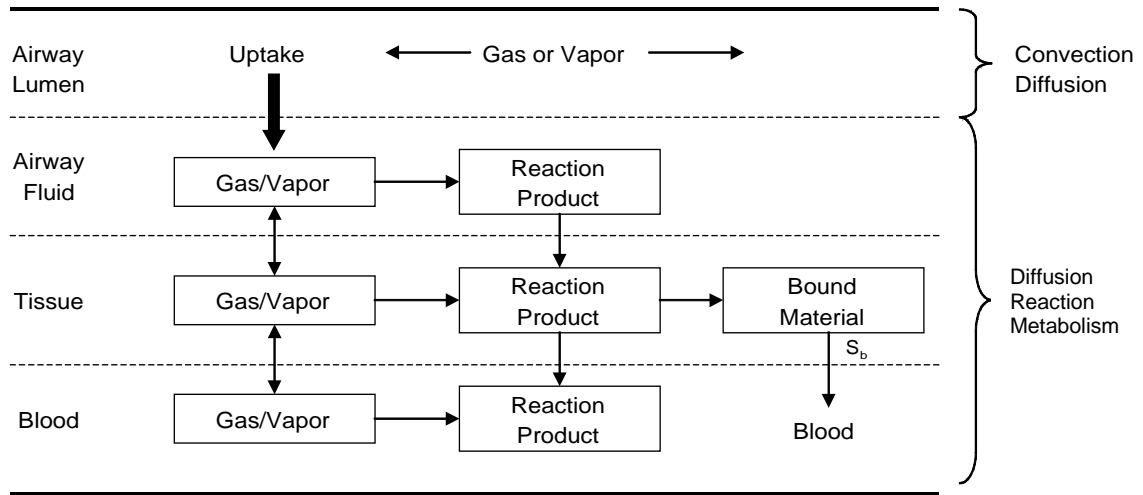

Source: ICRP 1994b

## 3. HEALTH EFFECTS

cleaning activities. The Commission of European Communities recommended a default value of 8% (Monchaux et al. 1999).

***Respiratory Tract Clearance.*** This portion of the model identifies the principal clearance pathways within the respiratory tract. The model was developed to predict the retention of various radioactive materials. The compartmental model represents particle deposition and time-dependent particle transport in the respiratory tract (see Figure 3-2) with reference values presented in Table 3-8. This table provides clearance rates, expressed as a fraction per day and also as half-time (Part A), and deposition fractions (Part B) for each compartment for insoluble particles. ICRP (1994b) also developed modifying factors for some of the parameters, such as age, smoking, and disease status. Parameters of the clearance model are based on human evidence for the most part, although particle retention in airway walls is based on experimental data from animal experiments.

The clearance of particles from the respiratory tract is a dynamic process. The rate of clearance generally changes with time from each region and by each route. Following deposition of large numbers of particles (acute exposure), transport rates change as particles are cleared from the various regions. Physical and chemical properties of deposited material determine the rate of dissolution and, as particles dissolve, absorption rates tend to change over time. By creating a model with compartments of different clearance rates within each region (e.g.,  $BB_1$ ,  $BB_2$ ,  $BB_{seq}$ ), the ICRP model overcomes problems associated with time-dependent functions. Each compartment clears to other compartments by constant rates for each pathway.

Particle transport from all regions is toward both the lymph nodes and the pharynx, and a majority of deposited particles end up being swallowed. In the front part of the nasal passages ( $ET_1$ ), nose blowing, sneezing, and wiping remove most of the deposited particles. Particles remain here for about a day. For particles with AMADs of a few micrometers or greater, the  $ET_1$  compartment is probably the largest deposition site. A majority of particles deposited at the back of the nasal passages and in the larynx ( $ET_2$ ) are removed quickly by the fluids that cover the airways. In this region, particle clearance is completed within 15 minutes.

Ciliary action removes deposited particles from both the bronchi and bronchioles. Though it is generally thought that mucociliary action rapidly transports most particles deposited here toward the pharynx, a fraction of these particles is cleared more slowly. Evidence for this is found in human studies. For humans, retention of particles deposited in the lungs ( $BB$  and  $bb$ ) is apparently biphasic. The “slow”



## 3. HEALTH EFFECTS

**Table 3-8. Reference Values of Parameters for the Compartment Model to Represent Time-dependent Particle Transport from the Human Respiratory Tract**

**Part A**

Clearance rates for insoluble particles				
Pathway	From	To	Rate (d <sup>-1</sup> )	Half-life <sup>a</sup>
m <sub>1,4</sub>	Al <sub>1</sub>	bb <sub>1</sub>	0.02	35 days
m <sub>2,4</sub>	Al <sub>2</sub>	bb <sub>1</sub>	0.001	700 days
m <sub>3,4</sub>	Al <sub>3</sub>	bb <sub>1</sub>	1x10 <sup>-4</sup>	7,000 days
m <sub>3,10</sub>	Al <sub>3</sub>	LN <sub>TH</sub>	2x10 <sup>-5</sup>	No data
m <sub>4,7</sub>	bb <sub>1</sub>	BB <sub>1</sub>	2	8 hours
m <sub>5,7</sub>	bb <sub>2</sub>	BB <sub>1</sub>	0.03	23 days
m <sub>6,10</sub>	bb <sub>seq</sub>	LN <sub>TH</sub>	0.01	70 days
m <sub>7,11</sub>	BB <sub>1</sub>	ET <sub>2</sub>	10	100 minutes
m <sub>8,11</sub>	BB <sub>2</sub>	ET <sub>2</sub>	0.03	23 days
m <sub>9,10</sub>	BB <sub>seq</sub>	LN <sub>TH</sub>	0.01	70 days
m <sub>11,15</sub>	ET <sub>2</sub>	GI tract	100	10 minutes
m <sub>12,13</sub>	ET <sub>seq</sub>	LN <sub>ET</sub>	0.001	700 days
m <sub>14,16</sub>	ET <sub>1</sub>	Environment	1	17 hours

See next page for Part B

## 3. HEALTH EFFECTS

**Table 3-8. Reference Values of Parameters for the Compartment Model to Represent Time-dependent Particle Transport from the Human Respiratory Tract**

**Part B**

Partition of deposit in each region between compartments <sup>b</sup>		
Region or deposition site	Compartment	Fraction of deposit in region assigned to compartment <sup>c</sup>
ET <sub>2</sub>	ET <sub>2</sub>	0.9995
	ET <sub>seq</sub>	0.0005
BB	BB <sub>1</sub>	0.993-f <sub>s</sub>
	BB <sub>2</sub>	f <sub>s</sub>
	BB <sub>seq</sub>	0.007
bb	bb <sub>1</sub>	0.993-f <sub>s</sub>
	bb <sub>2</sub>	f <sub>s</sub>
	bb <sub>seq</sub>	0.007
Al	Al <sub>1</sub>	0.3
	Al <sub>2</sub>	0.6
	Al <sub>3</sub>	0.1

<sup>a</sup>The half-lives are approximate since the reference values are specified for the particle transport rates and are rounded in units of days<sup>-1</sup>. A half-life is not given for the transport rate from Al<sub>3</sub> to LN<sub>TH</sub>, since this rate was chosen to direct the required amount of material to the lymph nodes. The clearance half-life of compartment Al<sub>3</sub> is determined by the sum of the clearance rates.

<sup>b</sup>See paragraph 181, Chapter 5 (ICRP 1994b) for default values used for relating f<sub>s</sub> to d<sub>ae</sub>.

<sup>c</sup>It is assumed that f<sub>s</sub> is size-dependent. For modeling purposes, f<sub>s</sub> is taken to be:

$$f_s = 0.5 \text{ for } d_{ae} \leq 2.5\sqrt{\rho/\chi} \text{ } \mu\text{m} \text{ and}$$

$$f_s = 0.5e^{0.63(d_{ae}\sqrt{\rho/\chi}-2.5)} \text{ for } d_{ae} > 2.5\sqrt{\rho/\chi} \text{ } \mu\text{m}$$

where

f <sub>s</sub>	=	fraction subject to slow clearance
d <sub>ae</sub>	=	aerodynamic particle diameter/(μm)
ρ	=	particle density (g/cm <sup>3</sup> )
χ	=	particle shape factor

Al = alveolar-interstitial region; BB = bronchial region; bb = bronchiolar region; BB<sub>seq</sub> = compartment representing prolonged retention in airway walls of small fraction of particles deposited in the bronchial region; bb<sub>seq</sub> = compartment representing prolonged retention in airway walls of small fraction of particles deposited in the bronchiolar region; ET = extrathoracic region; ET<sub>seq</sub> = compartment representing prolonged retention in airway tissue of small fraction of particles deposited in the nasal passages; GI = gastrointestinal; LN<sub>ET</sub> = lymphatics and lymph nodes that drain the extrathoracic region; LN<sub>TH</sub> = lymphatics and lymph nodes that drain the thoracic region

Source: ICRP 1994b

## 3. HEALTH EFFECTS

action of the cilia may remove as much as half of the bronchi- and bronchiole-deposited particles. In human bronchi and bronchiole regions, mucus moves more slowly when it is closer to the alveoli. For the faster compartment, it has been estimated that it takes about 2 days for particles to travel from the bronchioles to the bronchi and 10 days from the bronchi to the pharynx. The second (slower) compartment is assumed to have approximately equal fractions deposited between  $BB_2$  and  $bb_2$ , with both fractions having clearance half-times estimated at 20 days. Particle size is a primary determinant of the fraction deposited in this slow thoracic compartment. A small fraction of particles deposited in the BB and bb regions is retained in the airway wall for even longer periods ( $BB_{seq}$  and  $bb_{seq}$ ).

If particles reach and become deposited in the alveoli, they tend to become imbedded in the fluid on the alveolar surface or move into the lymph nodes. Coughing is the one mechanism by which particles are physically resuspended and removed from the AI region. For modeling purposes, the AI region is divided into three subcompartments to represent different clearance rates, all of which are slow.

In the alveolar-interstitial region, human lung clearance has been measured. The ICRP model uses 2 half-times to represent clearance: about 30% of the particles have a 30-day half-time, and the remaining 70% are assigned a half-time of several hundred days. Over time, AI particle transport falls, and some compounds have been found in lungs 10–50 years after exposure.

**Absorption into Blood.** The ICRP model assumes that absorption into blood occurs at equivalent rates in all parts of the respiratory tract, except in the anterior nasal passages ( $ET_1$ ), where no absorption occurs. It is essentially a 2-stage process, as shown in Figure 3-4. First, there is a dissociation (dissolution) of particles; then the dissolved molecules or ions diffuse across capillary walls and are taken up by the blood. Immediately following dissolution, rapid absorption is observed. For some elements, rapid absorption does not occur because of binding to respiratory-tract components. In the absence of specific data for specific compounds, the model uses the following default absorption rate values for those specific compounds that are classified as Types F (fast), M (medium), S (slow), and V (instantaneous):

- For Type F, there is rapid 100% absorption within 10 minutes of the material deposited in the BB, bb, and AI regions, and 50% of material deposited in  $ET_2$ . Thus, for nose breathing, there is rapid absorption of approximately 25% of the deposit in ET; for mouth breathing, the value is 50%.
- For Type M, about 70% of the deposit in AI reaches the blood eventually. There is rapid absorption of about 10% of the deposit in BB and bb, and 5% of material deposited in  $ET_2$ . Thus, there is rapid absorption of approximately 2.5% of the deposit in ET for nose breathing, and 5% for mouth breathing.

3. HEALTH EFFECTS

**Figure 3-4. The Human Respiratory Tract Model: Absorption into Blood**

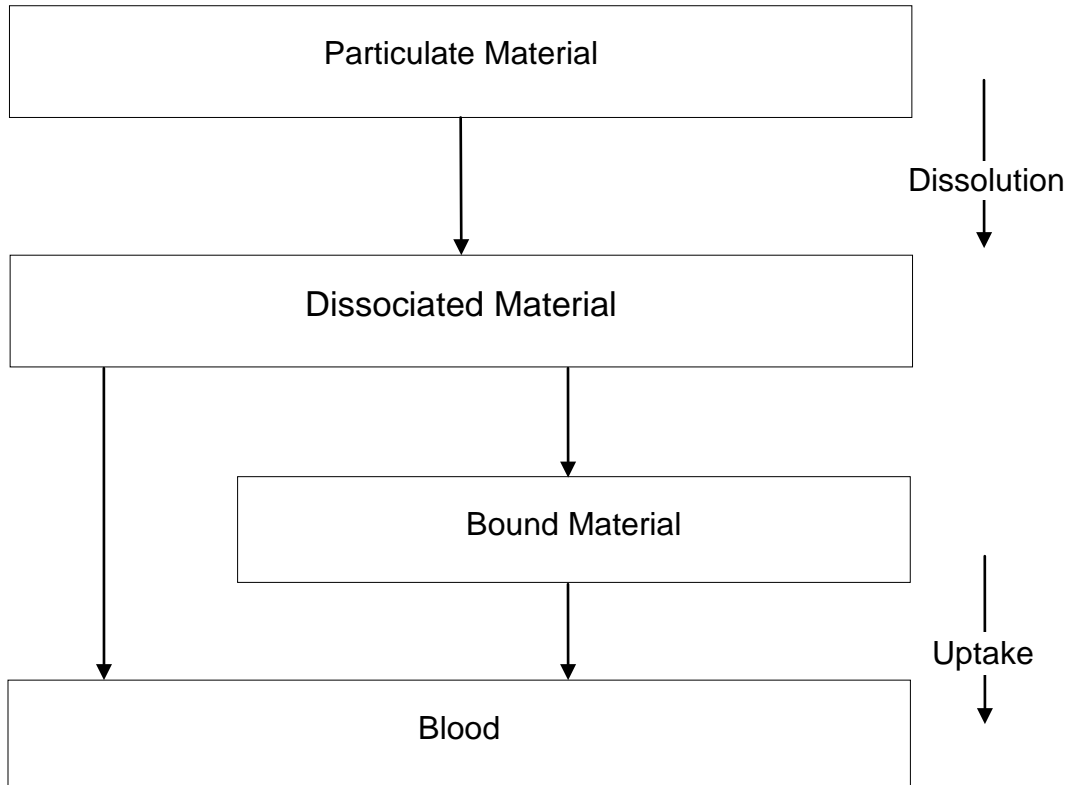

Source: ICRP 1994b

## 3. HEALTH EFFECTS

- For Type S, 0.1% is absorbed within 10 minutes and 99.9% is absorbed within 7,000 days, so there is little absorption from ET, BB, or bb, and about 10% of the deposit in AI reaches the blood eventually.
- For Type V, complete absorption (100%) is considered to occur instantaneously.

ICRP (1994b) assigned gases and vapors to Type F, unless alternative values for absorption rates are available. However, alternatives to this assumption have been explored, including instantaneous partitioning of radon gas into dissolved blood (Butterweck et al. 2002). Radiation doses from exposures to radon have been estimated assuming radon and its progeny behave as Type F or Type M (Kendall and Smith 2002). The difference between the two categories is important for estimating tissue specific radiation dose coefficients (e.g., Sv/Bq<sup>-1</sup> inhaled) because of the relatively fast decay of radon ( $t_{1/2}=3.8$  days) and its short-lived progeny (e.g., <sup>218</sup>Po,  $t_{1/2}=3.05$  minutes; <sup>214</sup>Pb,  $t_{1/2}=26.8$  minutes; <sup>214</sup>Bi,  $t_{1/2}=19.7$  minutes). Type F materials (absorption  $t_{1/2}=10$  minutes) will have a smaller proportion of progeny formed in the respiratory tract (i.e., prior to clearance) and, as a result, will deliver a smaller internal radiation dose and smaller dose to the respiratory tract relative to systemic tissues. Type M materials (absorption  $t_{1/2}=100$  days for 90% of deposited material,  $t_{1/2}=10$  minutes for 10%) will have a larger portion of progeny formed in the respiratory tract, which will deliver a larger internal radiation dose and larger dose to the respiratory tract relative to systemic tissues (Kendall and Smith 2002). Absorption  $t_{1/2}$  values for <sup>212</sup>Pb and <sup>212</sup>Bi, in an aerosol having an activity median particle diameter of approximately 160 nm (range 50–500 nm), a value typical of attached radon progeny particles, were estimated to be approximately 10 and 13 hours, respectively (Marsh and Birchall 1999). Use of a  $t_{1/2}$  value of 10 hours for radon progeny in the ICRP (1994b) model results in predicted radiation dose coefficients that are similar in magnitude to the Type M assumption (Kendall and Smith 2002). However, absorption of unattached radon progeny may be faster than that of attached particles. Absorption half-times for aerosols having approximately 0.3–3 nm in diameter, typical of unattached progeny particles, were estimated to be approximately 68 minutes (range 56–86) for <sup>218</sup>Po and <sup>214</sup>Pb and 18 minutes (range 17–21) for <sup>214</sup>Bi (Butterweck et al. 2002). Butterweck et al. (2002) proposed that binding of unattached radon progeny in the respiratory tract may result in slower absorption kinetics. They proposed that a 10-hour  $t_{1/2}$  would apply to the unattached fraction after binding in the respiratory tract and that the unbound fraction may have an absorption  $t_{1/2}<10$  minutes (see Section 3.4.1.1 for further discussion of absorption estimates).

RADEP implements a simplified version of the ICRP (1994b) model and is designed to simulate radon and radon progeny radiation dosimetry (Marsh and Birchall 2000; Figure 3-5): (1) the alveolar

3. HEALTH EFFECTS

Figure 3-5. Simplified Version of the Human Respiratory Tract Model (HRTM)

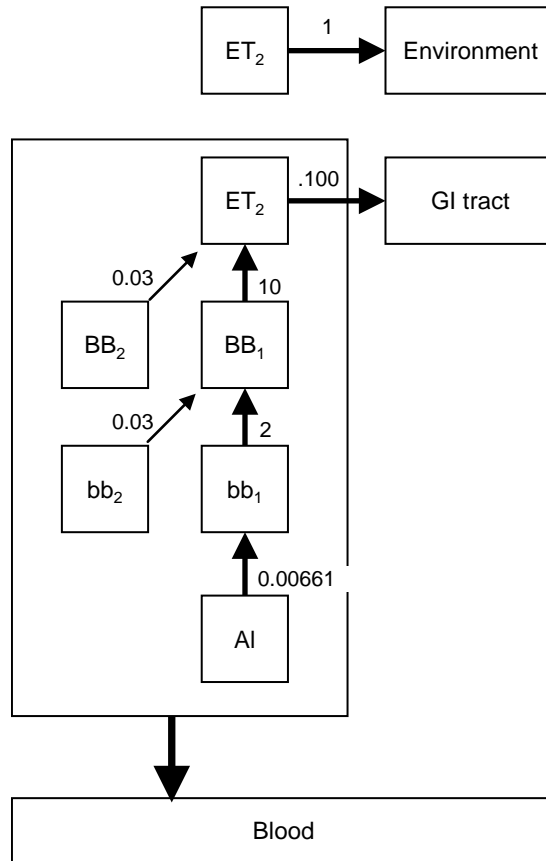

Source: Marsh and Birchall 2000

### 3. HEALTH EFFECTS

interstitial compartment is represented as a single compartment that has a particle transport rate of  $0.00661 \text{ d}^{-1}$  to the fast bronchiolar compartment,  $bb_1$ ; (2) sequestered compartments,  $ET_{\text{seq}}$ ,  $BB_{\text{seq}}$ , and  $bb_{\text{seq}}$  are not considered; (3) radon progeny are assumed to not bind to the respiratory tract; and (4) hygroscopic growth of unattached particles is simulated.

**Validation of the Model.** ICRP (1994b) and RADEP have been evaluated with data on deposition and clearance of inhaled particulate aerosol and gases in humans and absorption of radon progeny (ICRP 1994b; Ishikawa et al. 2003b; Marsh and Birchall 1999). Sensitivity and uncertainty analyses of model predictions have been reported (Marsh and Birchall 2000; Yu et al. 2006).

**Risk Assessment.** The model has been used to establish the radiation dose (Sv) per unit of inhaled radon (Bq) for ages 3 months to 70 years (Kendall and Smith 2002).

**Target Tissues.** The model is designed to calculate radiation dose coefficients (Sv/Bq) corresponding to specific inhalation exposures to radionuclides. Dose coefficients for radon and progeny have been estimated for all major organs, including the bone surfaces, bone marrow, and liver, and other tissues (Kendall and Smith 2002).

**Species Extrapolation.** The model is based on both human and animal data. However, it is intended for applications to human dosimetry. Applications to other species would require consideration of species-specific adjustments in modal parameters.

**Interroute Extrapolation.** The ICRP model is designed to simulate kinetics of inhaled radionuclides. [Note: ICRP/NCRP models are for normal lungs, not those of smokers.]

#### **National Research Council Radon PBPK Model (NAS 1999b)**

NAS (1999b) developed a PBPK model for simulating absorption and distribution of ingested or inhaled radon gas (Figure 3-6). The model simulates absorption of inhaled radon and distribution to tissues as flow-limited processes (i.e., tissue clearance equivalent to tissue blood flow) with parameters for tissue volumes, blood flow, and blood:tissue partition coefficients. Absorption of radon gas from the stomach and small intestine is simulated as diffusion-limited transfer from the lumen to the wall (i.e., vascularized submucosa), and flow-limited exchange between blood and wall. A separate model is described in NAS (1999b) for estimating wall diffusion rate constants, which predicts a time-integrated radon concentration

3. HEALTH EFFECTS

**Figure 3-6. Schematic Diagram of the NAS (1999b) PBPK Model Developed to Describe the Fate of Radon within Systemic Tissues**

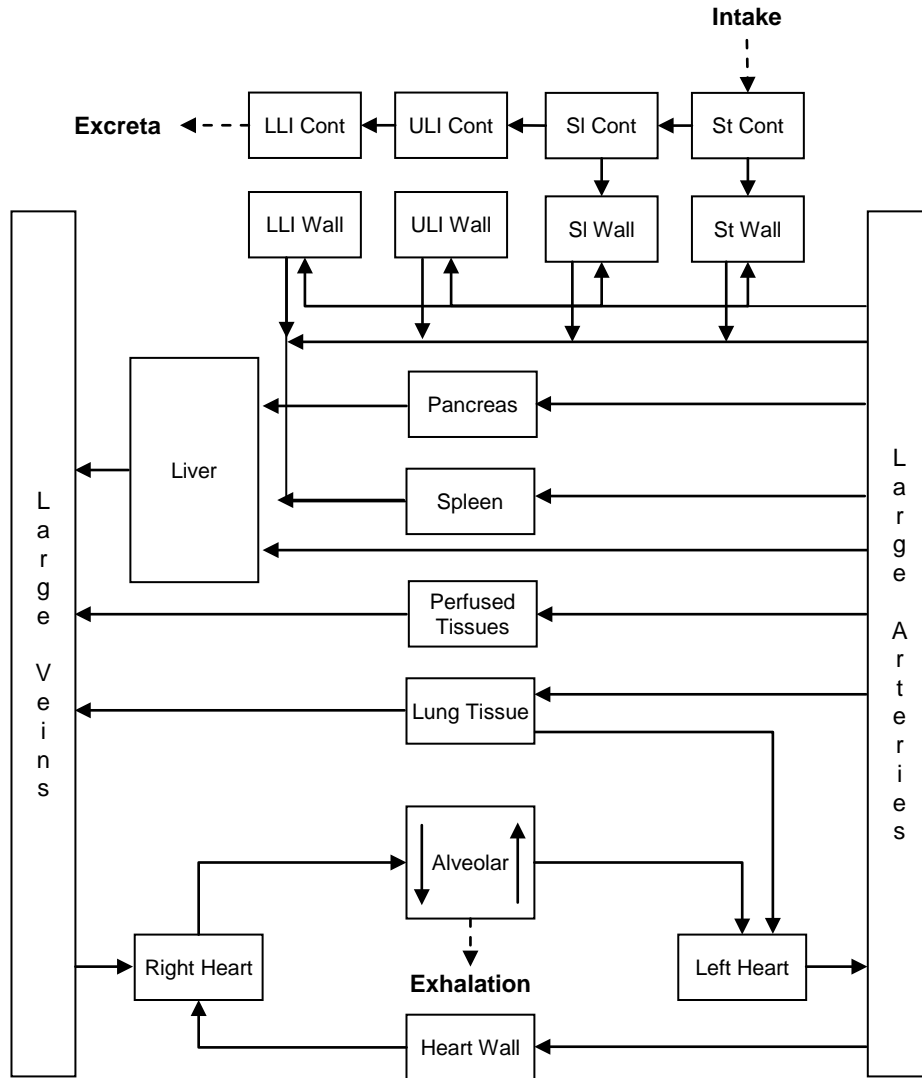

Source: NAS 1999b



## 3. HEALTH EFFECTS

in the stomach wall of approximately 30% of that of the lumen. Parameter values for adults are presented in Table 3-9. Values for blood flows were derived from Leggett and Williams (1991, 1995); volumes and densities from ICRP (1990); and tissue:blood partition coefficients from Nussbaum and Hursh (1957). Parameter values for infants, children, and adolescents are also presented in NAS (1999b).

**Validation of the Model.** The NRC model has been evaluated with data on deposition and clearance of inhaled particulate aerosols and gases in humans and absorption of radon progeny (Correia et al. 1988; Crawford-Brown 1989; Harley and Robbins 1994; Harley et al. 1994; Hursh et al. 1965; NAS 1999b).

**Risk Assessment.** The model has been used to establish the radiation dose (Sv) per unit of inhaled or ingested radon (Bq) for ages 3 months to 70 years (NAS 1999b).

**Target Tissues.** The model is designed to calculate radiation dose coefficients (Sv/Bq) corresponding to inhalation or ingestion exposures to radon. Dose coefficients for radon and progeny have been estimated for all major organs, including the bone surfaces, bone marrow, and liver, and other tissues (NAS 1999b).

**Species Extrapolation.** The model is based on both human and animal data. However, it is intended for applications to human dosimetry. Applications to other species would require consideration of species-specific adjustments in modal parameters.

**Interroute Extrapolation.** The model is designed to simulate kinetics of inhaled or ingested radon. Extrapolation to other routes of external exposure would require modifications of the model to simulate absorption from those routes.

### **Khursheed (2000) Model**

Khursheed (2000) developed a PBPK model for simulating absorption and distribution of ingested or inhaled radon gas (Figure 3-7). The model is similar in structure to the NRC (NAS 1999) model, with the addition of a tissue compartment representing breast. The model has not had widespread use in risk assessment, relative to that of ICRP (1994b), RADEP, or the NRC (1999) models. Absorption of inhaled and ingested radon, and distribution to tissues, are simulated as flow-limited processes (i.e., tissue clearance equivalent to tissue blood flow) with parameters for tissue volumes, blood flow, and blood:tissue partition coefficients (Table 3-10). Values for blood flows were derived from Leggett and Williams (1991, 1995); and tissue volumes were derived from ICRP (1990). Tissue:blood partition

## 3. HEALTH EFFECTS

**Table 3-9. Parameters in the NAS (1999b) PBPK Model<sup>a</sup>**

Compartment	Flow (percent cardiac output)	Tissue mass (kg)	Tissue density	Tissue:blood partition coefficient
Stomach wall	1.0	0.15	1.05	0.7
Small intestine wall	10.0	0.64	1.04	0.7
Upper large intestine wall	2.0	0.21	1.04	0.7
Lower large intestine wall	2.0	0.16	1.04	0.7
Pancreas	1.0	0.10	1.05	0.4
Spleen	3.0	0.18	1.05	0.7
Adrenals	0.3	0.014	1.02	0.7
Brain	12.0	1.4	1.03	0.7
Heart wall	4.0	0.33	1.03	0.5
Liver	6.5	1.8	1.04	0.7
Lung tissue	2.5	0.47	1.05	0.7
Kidneys	19.0	0.31	1.05	0.66
Muscle	17.0	28.0	1.04	0.36
Red marrow	3.0	1.5	1.03	8.2
Yellow marrow	3.0	1.5	0.98	8.2
Trabecular bone	0.9	1.0	1.92	0.36
Cortical bone	0.6	4.0	1.99	0.36
Adipose tissue	5.0	12.5	0.92	11.2
Skin	5.0	2.6	1.05	0.36
Thyroid	1.5	0.02	1.05	0.7
Testes	0.05	0.035	1.04	0.43
Other	3.2	3.2	1.04	0.7

<sup>a</sup>Values shown for physiological parameters (flows, masses, densities) are for adults.

Source: NAS 1999b

3. HEALTH EFFECTS

**Figure 3-7. Khursheed (2000) PBPK Model for Inhalation and Ingestion of Radon Gas**

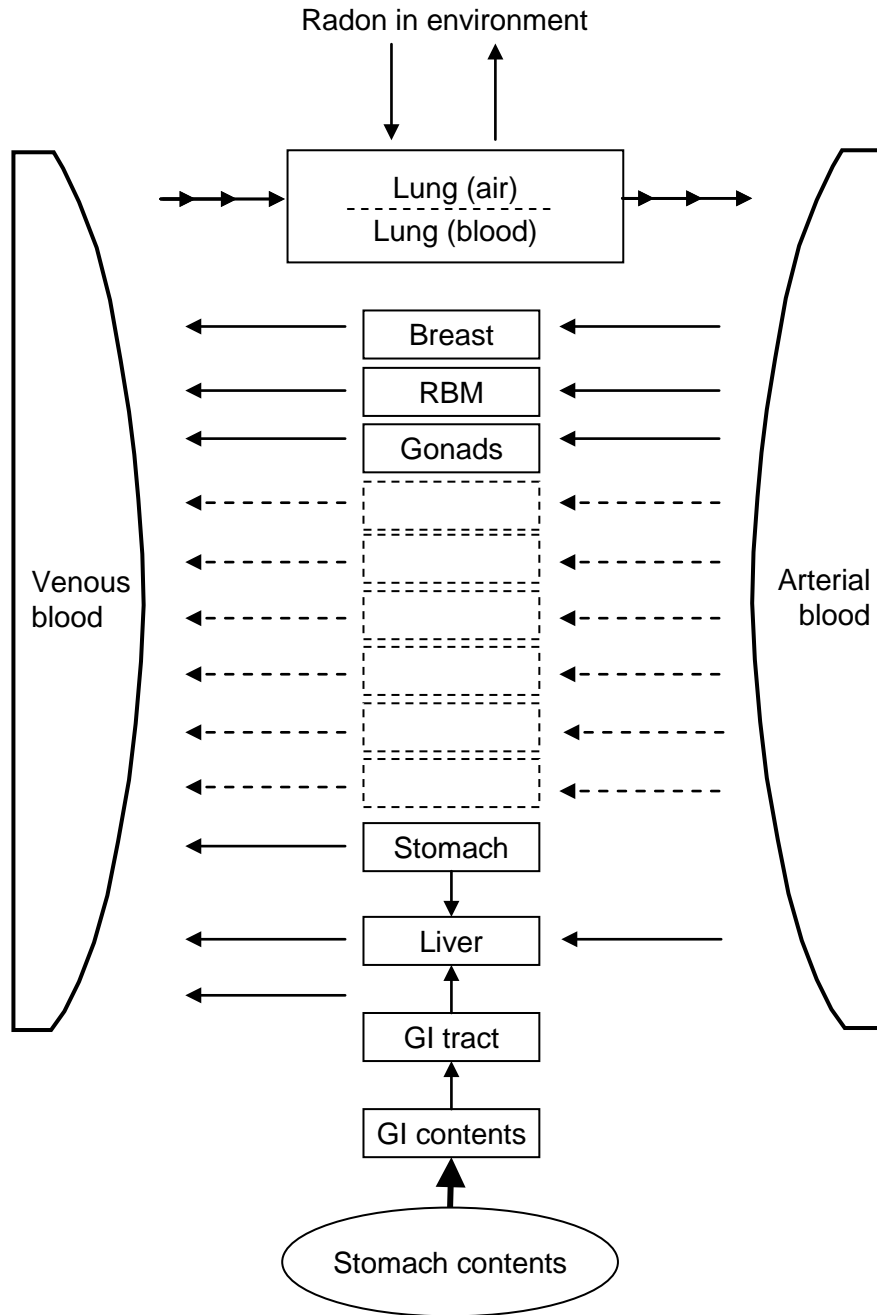

Source: Khursheed 2000

## 3. HEALTH EFFECTS

**Table 3-10. Parameters in Khursheed (2000) PBPK Model for Radon Gas**

Tissue	Tissue:blood partition coefficient	Tissue blood flow (L/minute)	Tissue volume (L)
Lung (blood)		6.5	0.52
Lung (air)	2.33		2.82
Breast	3.07	0.015	0.35
Red bone marrow	4.70	0.195	1.46
Gonads	0.360	0.00325	0.033
Brain	0.411	0.78	1.25
Kidneys	0.33	1.23	0.295
Muscle	0.36	1.11	26.5
Other	0.36	1.05	25.1
Adipose	11.2	0.325	16.4
Bone	0.21	0.13	2.27
Liver	0.36	1.66	1.7
Gastrointestinal (upper intestines)	0.411	1.17	0.95
Stomach wall	0.411	0.065	0.14
Arterial blood		6.5	0.556
Venous blood		6.5	1.19

Source: Khursheed 2000

### 3. HEALTH EFFECTS

coefficients were derived from Nussbaum and Hursh (1957); however, a single value (0.36) was adopted for all soft tissues, with a higher value used for the gastrointestinal tract and stomach to account for higher fat content of these tissues. Values for partition coefficients for breast and red marrow assumed 30 and 40% fat content, respectively. Although age-dependence of radon biokinetics is discussed in Khursheed (2000), age-specific parameter values for the model are not reported.

**Validation of the Model.** The model has been evaluated with data on whole body retention kinetics of radon following ingestion of radon in water (Hursh et al. 1965; Khursheed 2000).

**Risk Assessment.** The model has been used to predict tissue-specific annual radiation doses associated with continuous inhalation exposures to 20 Bq/m<sup>3</sup> of radon, or following ingestion of 1 Bq of radon (Khursheed 2000).

**Target Tissues.** The model is designed to calculate radiation dose coefficients (Sv/Bq) corresponding to inhalation or ingestion exposures to radon. Dose coefficients for radon and progeny have been estimated for major organs, including the bone surfaces, bone marrow, and liver, and other tissues (Khursheed 2000).

**Species Extrapolation.** The model is based on both human and animal data (e.g., partition coefficients). However, it is intended for applications to human dosimetry. Applications to other species would require consideration of species-specific adjustments in modal parameters.

**Interroute Extrapolation.** The model is designed to simulate kinetics of inhaled or ingested radon. Extrapolation to other routes of external exposure would require modifications of the model to simulate absorption from those routes.

## 3.5 MECHANISMS OF ACTION

### 3.5.1 Pharmacokinetic Mechanisms

As discussed in Section 3.4 (Toxicokinetics), the radionuclide radon (<sup>222</sup>Rn; radioactive half) is a relatively inert noble gas found in air and some deep well water sources. Radon occurs with aerosols of short-lived radioactive progeny (i.e., <sup>214</sup>Bi, <sup>214</sup>Pb, <sup>218</sup>Po) that form as a result of the progeny reacting with natural aerosols in the air and water. Deposition and absorption of inhaled or ingested radon gas will be determined largely by its solubility in tissues and blood flow to the lungs or gastrointestinal tract (i.e.,

### 3. HEALTH EFFECTS

absorption rate will be flow-limited). Distribution of radon and its clearance from the blood following exposure will be governed by its solubility in water and fat and blood flow rates to major tissue depots for radon (i.e., fatty tissues). Absorbed radon is quickly eliminated from the blood by diffusion across the lung, followed by exhalation. Radon can be absorbed through the skin, as demonstrated by its appearance in the blood following dermal exposure; however, underlying mechanisms have not been elucidated.

The pharmacokinetics of inhaled radon progeny will be determined by physiological and physico-chemical characteristics (i.e., relative proportions of particular radon progeny and particle size (unattached particles with diameters of 0.5–3 nm to attached particles with diameters of 50–1,500 nm). The relative proportions vary with exposure conditions (i.e., indoor, outdoor), activities of the individual (e.g., sleeping, activities that release particulates into the air), smoking, and other aerosol-generating activities (i.e., vacuum cleaning, cooking, fireplace and circulating fan usage). Amounts and location of deposition of radon progeny will be determined by factors that influence convection, diffusion, sedimentation, and interception of particles in the airways. Absorption of ingested radon progeny, and progeny formed from radon after ingestion, will be influenced by rates of transfer of stomach contents into the small intestine, as well as rates of absorption of progeny from the small intestine. Specific mechanisms involved in absorption of radon progeny from the small intestine have not been completely elucidated; however, based on our understanding of lead absorption, it is likely that the mechanisms include those common to other divalent cations (e.g., membrane cation transporters and channels). Information regarding the distribution and elimination of radon progeny (bismuth, lead, and polonium) can be found in reviews of these subjects (Agency for Toxic Substances and Disease Registry 2007; ICRP 1980, 1994c, 1995). The largest fractions of the body burdens for radon progeny would be expected to be found in bone for lead, kidney for bismuth, and liver for polonium (Agency for Toxic Substances and Disease Registry 2007; ICRP 1980, 1994c, 2001).

#### **3.5.2 Mechanisms of Toxicity**

Extensive efforts have been made to elucidate mechanisms responsible for ionizing radiation-induced adverse effects. The Toxicological Profile for Ionizing Radiation (Agency for Toxic Substances and Disease Registry 1999b) includes an in-depth discussion of mechanisms of biological effects of ionizing radiation in general. Summaries of available information regarding underlying mechanisms of radon-induced lung cancer include Evans (1991, 1992) and, more recently, Jostes (1996) and NAS (1999a, 1999b). The intent of this Toxicological Profile for Radon is to provide a brief overview of the present state of the science regarding mechanisms that may play roles in radon-induced lung cancer. The

## 3. HEALTH EFFECTS

information in this section is summarized predominantly from Chapter 6 (Molecular and Cellular Mechanisms of Radon-Induced Carcinogenesis) of the Risk Assessment of Radon in Drinking Water produced for the National Academy of Sciences (NAS 1999b). The reader is referred to this source for more detailed information on mechanisms of radon-induced lung cancer.

Toxicity of radon derives primarily from the biological effects of alpha radiation released during the radiological decay of radon progeny, particularly  $^{218}\text{Po}$  and  $^{214}\text{Bi}$  (attributed to essentially instantaneous decay of  $^{214}\text{Po}$  to  $^{210}\text{Pb}$  following its formation via beta and gamma decay of  $^{214}\text{Bi}$ ). The sequence of events leading from irradiation of living cells involves ionization that causes cellular damage that includes DNA breakage, accurate or inaccurate repair, apoptosis, gene mutations, chromosomal change, and genetic instability (Kronenberg 1994; Ward 1988, 1990). Figure 3-8 depicts a general conceptual model of the biology leading from alpha irradiation of cells by radon and radon progeny to tumor development (NAS 1999b). The process includes a series of events by which radiation-induced molecular changes affect the normal functions of regulatory genes, leading to genomic instability, loss of normal cell and tissue homeostasis, and development of malignancy.

One pathway leading to tumor formation begins with the induction of DNA damage to irradiated cells (Figure 3-8). Double-strand breaks are the most prominent form of DNA damage to cells irradiated by radon alpha particles. Such double-strand breaks can be repaired by homologous or nonhomologous (illegitimate) rejoining. In homologous repair, pairing proteins such as rad51 and associated modulatory proteins, pair a DNA terminus with the intact DNA homolog. A major signaling protein (p53) that regulates cell-cycle control, apoptosis, and the transcription of many downstream genes may interact with rad51 and suppress rad51-dependent DNA pairing. However, homologous repair of DNA is likely to be highly accurate because sequence information from the intact chromatid is used to repair the broken DNA. The nonhomologous recombination pathway involves end-to-end rejoining of broken DNA ends by supporting proteins including Ku70, Ku86, p450 kinase, and DNA ligase IV. The end result of DNA breakage and rejoining via this pathway may include some degree of deletion, insertion, or rearrangement of genetic material, which can persist over many cell generations.

Ionizing radiation that does not directly damage DNA can produce reactive oxygen intermediates that directly affect the stability of p53, resulting in downstream effects on cell regulation and activate cellular systems sensitive to the cellular redox states. Reactive oxygen intermediates can also produce oxidative damage to individual bases in DNA and point mutations by mispairing during DNA replication. Such

3. HEALTH EFFECTS

**Figure 3-8. Conceptual Model of the Biology Leading From Alpha Irradiation of Cells by Radon and Radon Progeny to Tumor Development**

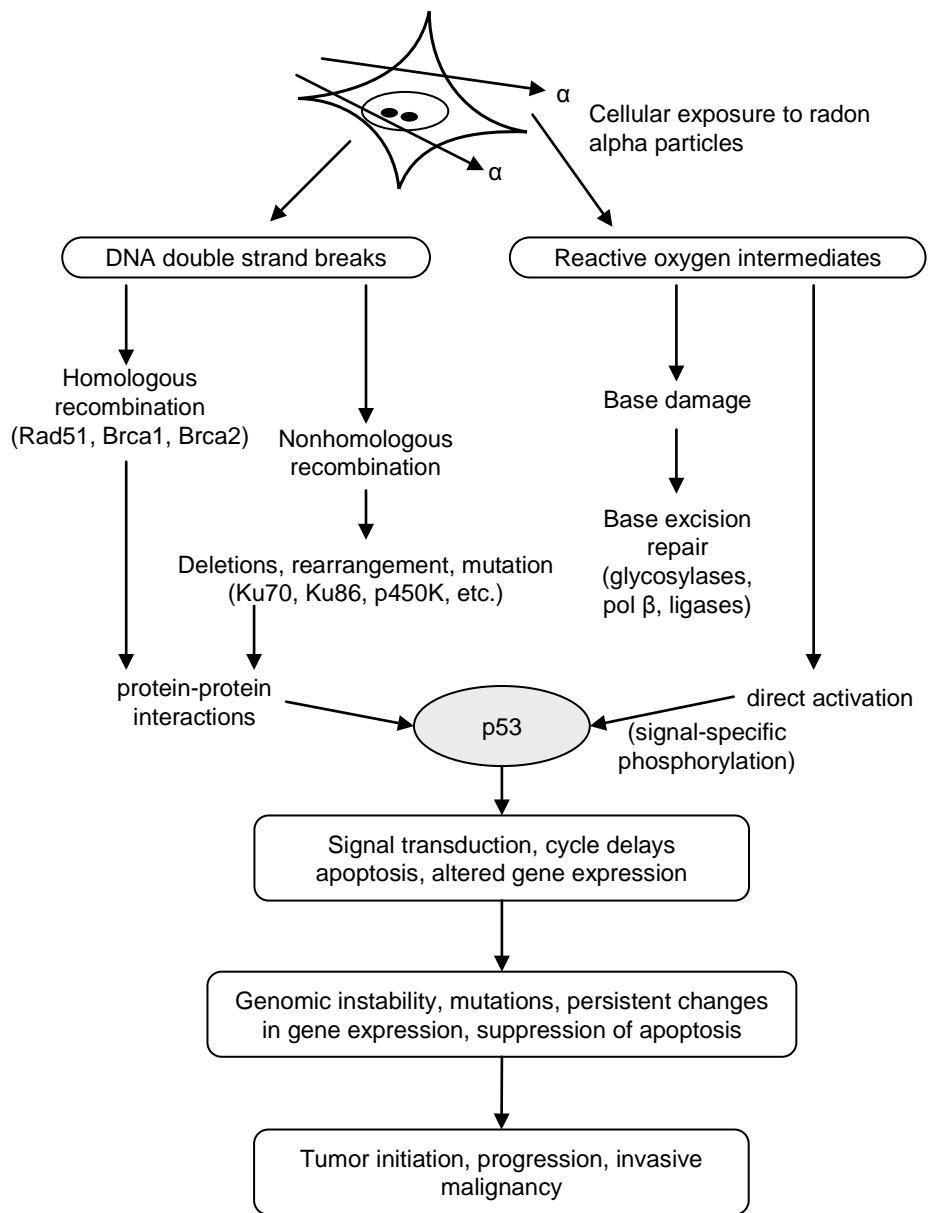

Source: NAS 1999b



### 3. HEALTH EFFECTS

damage can be repaired by the base-excision repair system which involves glycosylases, polymerase  $\beta$ , and ligases.

The p53 protein plays a critical role in regulating responses that are elicited in damaged cells, particularly responses involving cell-cycle arrest and apoptosis. The p53 protein also interacts with other regulatory and repair proteins. In the presence of cellular damage via direct DNA damage or via reactive oxygen intermediates, the lifetime of p53 increases, which can result in cell cycle delays and apoptosis. Surviving cells may contain gene deletions, rearrangements, amplifications, and persistent genomic instability. Resultant mutations in oncogenes, loss of function in tumor suppressors, and loss of heterozygosity can lead to tumor initiation, progression, and invasive malignancy.

The cells most likely involved in a carcinogenic response to ionizing radiation such as alpha irradiation of the lung by inhaled radon and radon progeny are the cells that incur genetic damage or altered genomic stability, not cells that receive lethal damage. At relatively low exposure levels, most irradiated cells would be expected to survive. The strong synergism between radon exposure and cigarette smoking may be the result of initial radon exposure that produces damaged, yet viable, cells that are further affected by carcinogens in cigarette smoke (Brenner and Ward 1992; Moolgavkar et al. 1993).

Both tobacco smoke and ionizing radiation are known to induce oxidative stress via reactive oxygen species (ROS). Under the assumption that glutathione-S-transferase M1 (*GSTM1*) null homozygotes would exhibit decreased ability to neutralize ROS, Bonner et al. (2006) used a case-only design to assess the *GSTM1* genotype of lung cancer cases for whom long-term  $\alpha$ -track radon detectors had been used to measure residential radon concentrations. Second-hand smoke levels were also estimated. Radon concentrations in excess of 121 Bq/m<sup>3</sup> (3.27 pCi/L) were significantly associated with *GSTM1* null homozygotes compared to *GSTM1* carriers; an odds ratio for second-hand smoke and *GSTM1* interaction among never smokers was elevated as well. The results provide suggestive evidence that radon and second-hand smoke might promote carcinogenic responses via a common pathway.

#### 3.5.3 Animal-to-Human Extrapolations

Epidemiological studies clearly identify lung cancer as the health effect of greatest concern, both from occupational and residential exposure to radon and its progeny. Results of studies assessing the health effects of exposure to radon in a variety of animal species indicate that rats and dogs are relatively sensitive to radon-induced lung tumor development, whereas hamsters and mice did not develop tumors,

### 3. HEALTH EFFECTS

even at cumulative exposures >10,000 WLM. This species difference may represent a real difference in sensitivity to radon; however, other factors may also have contributed to the lack of tumors in mice and hamsters, including decreased longevity in some exposed groups (i.e., animals die before tumors could develop) and termination of exposure or observations prior to the development of lung tumors. The lack of demonstrated exposure-related lung cancer in the hamsters may reflect species-specific resistance to alpha radiation-induced lung tumors since similar negative results were observed in hamsters exposed to plutonium, another alpha-emitting radionuclide (Sanders 1977). Based on a wide range of species differences in susceptibility to radon-induced lung cancer and insufficient information regarding mechanisms of interspecies differences in susceptibility, animal-to-human extrapolations for purposes of risk assessment do not appear useful at this time, nor are they needed given the wealth of epidemiological data.

#### **3.6 TOXICITIES MEDIATED THROUGH THE NEUROENDOCRINE AXIS**

Recently, attention has focused on the potential hazardous effects of certain chemicals on the endocrine system because of the ability of these chemicals to mimic or block endogenous hormones. Chemicals with this type of activity are most commonly referred to as endocrine disruptors. However, appropriate terminology to describe such effects remains controversial. The terminology endocrine disruptors, initially used by Thomas and Colborn (1992), was also used in 1996 when Congress mandated the EPA to develop a screening program for "...certain substances [which] may have an effect produced by a naturally occurring estrogen, or other such endocrine effect[s]...". To meet this mandate, EPA convened a panel called the Endocrine Disruptors Screening and Testing Advisory Committee (EDSTAC), and in 1998, the EDSTAC completed its deliberations and made recommendations to EPA concerning endocrine disruptors. In 1999, the National Academy of Sciences released a report that referred to these same types of chemicals as hormonally active agents. The terminology endocrine modulators has also been used to convey the fact that effects caused by such chemicals may not necessarily be adverse. Many scientists agree that chemicals with the ability to disrupt or modulate the endocrine system are a potential threat to the health of humans, aquatic animals, and wildlife. However, others think that endocrine-active chemicals do not pose a significant health risk, particularly in view of the fact that hormone mimics exist in the natural environment. Examples of natural hormone mimics are the isoflavonoid phytoestrogens (Adlercreutz 1995; Livingston 1978; Mayr et al. 1992). These chemicals are derived from plants and are similar in structure and action to endogenous estrogen. Although the public health significance and descriptive terminology of substances capable of affecting the endocrine system remains controversial, scientists agree that these chemicals may affect the synthesis, secretion, transport, binding, action, or

### 3. HEALTH EFFECTS

elimination of natural hormones in the body responsible for maintaining homeostasis, reproduction, development, and/or behavior (EPA 1997). Stated differently, such compounds may cause toxicities that are mediated through the neuroendocrine axis. As a result, these chemicals may play a role in altering, for example, metabolic, sexual, immune, and neurobehavioral function. Such chemicals are also thought to be involved in inducing breast, testicular, and prostate cancers, as well as endometriosis (Berger 1994; Giwercman et al. 1993; Hoel et al. 1992).

No studies were located regarding endocrine disruption in humans and/or animals after exposure to radon or its progeny.

No *in vitro* studies were located regarding endocrine disruption of radon or its progeny.

#### **3.7 CHILDREN'S SUSCEPTIBILITY**

This section discusses potential health effects from exposures during the period from conception to maturity at 18 years of age in humans, when all biological systems will have fully developed. Potential effects on offspring resulting from exposures of parental germ cells are considered, as well as any indirect effects on the fetus and neonate resulting from maternal exposure during gestation and lactation. Relevant animal and *in vitro* models are also discussed.

Children are not small adults. They differ from adults in their exposures and may differ in their susceptibility to hazardous chemicals. Children's unique physiology and behavior can influence the extent of their exposure. Exposures of children are discussed in Section 6.6, Exposures of Children.

Children sometimes differ from adults in their susceptibility to hazardous chemicals, but whether there is a difference depends on the chemical (Guzelian et al. 1992; NRC 1993). Children may be more or less susceptible than adults to health effects, and the relationship may change with developmental age (Guzelian et al. 1992; NRC 1993). Vulnerability often depends on developmental stage. There are critical periods of structural and functional development during both prenatal and postnatal life, and a particular structure or function will be most sensitive to disruption during its critical period(s). Damage may not be evident until a later stage of development. There are often differences in pharmacokinetics and metabolism between children and adults. For example, absorption may be different in neonates because of the immaturity of their gastrointestinal tract and their larger skin surface area in proportion to body weight (Morselli et al. 1980; NRC 1993); the gastrointestinal absorption of lead is greatest in infants

### 3. HEALTH EFFECTS

and young children (Ziegler et al. 1978). Distribution of xenobiotics may be different; for example, infants have a larger proportion of their bodies as extracellular water, and their brains and livers are proportionately larger (Altman and Dittmer 1974; Fomon 1966; Fomon et al. 1982; Owen and Brozek 1966; Widdowson and Dickerson 1964). The infant also has an immature blood-brain barrier (Adinolfi 1985; Johanson 1980) and probably an immature blood-testis barrier (Setchell and Waites 1975). Many xenobiotic metabolizing enzymes have distinctive developmental patterns. At various stages of growth and development, levels of particular enzymes may be higher or lower than those of adults, and sometimes unique enzymes may exist at particular developmental stages (Komori et al. 1990; Leeder and Kearns 1997; NRC 1993; Vieira et al. 1996). Whether differences in xenobiotic metabolism make the child more or less susceptible also depends on whether the relevant enzymes are involved in activation of the parent compound to its toxic form or in detoxification. There may also be differences in excretion, particularly in newborns who all have a low glomerular filtration rate and have not developed efficient tubular secretion and resorption capacities (Altman and Dittmer 1974; NRC 1993; West et al. 1948). Children and adults may differ in their capacity to repair damage from chemical insults. Children also have a longer remaining lifetime in which to express damage from chemicals; this potential is particularly relevant to cancer.

Certain characteristics of the developing human may increase exposure or susceptibility, whereas others may decrease susceptibility to the same chemical. For example, although infants breathe more air per kilogram of body weight than adults breathe, this difference might be somewhat counterbalanced by their alveoli being less developed, which results in a disproportionately smaller surface area for alveolar absorption (NRC 1993).

Differences in lung morphometry and breathing rates in children may result in higher estimated radiation doses relative to adults (NCRP 1984a; Samet et al. 1989). However, available information from children employed as miners in China does not provide evidence of increased susceptibility to the effects of exposure to radon (Lubin et al. 1990; NIH 1994).

#### **3.8 BIOMARKERS OF EXPOSURE AND EFFECT**

Biomarkers are broadly defined as indicators signaling events in biologic systems or samples. They have been classified as markers of exposure, markers of effect, and markers of susceptibility (NAS/NRC 1989).

### 3. HEALTH EFFECTS

A biomarker of exposure is a xenobiotic substance or its metabolite(s) or the product of an interaction between a xenobiotic agent and some target molecule(s) or cell(s) that is measured within a compartment of an organism (NAS/NRC 1989). The preferred biomarkers of exposure are generally the substance itself, substance-specific metabolites in readily obtainable body fluid(s), or excreta. However, several factors can confound the use and interpretation of biomarkers of exposure. The body burden of a substance may be the result of exposures from more than one source. The substance being measured may be a metabolite of another xenobiotic substance (e.g., high urinary levels of phenol can result from exposure to several different aromatic compounds). Depending on the properties of the substance (e.g., biologic half-life) and environmental conditions (e.g., duration and route of exposure), the substance and all of its metabolites may have left the body by the time samples can be taken. It may be difficult to identify individuals exposed to hazardous substances that are commonly found in body tissues and fluids (e.g., essential mineral nutrients such as copper, zinc, and selenium). Biomarkers of exposure to radon are discussed in Section 3.9.1.

Biomarkers of effect are defined as any measurable biochemical, physiologic, or other alteration within an organism that, depending on magnitude, can be recognized as an established or potential health impairment or disease (NAS/NRC 1989). This definition encompasses biochemical or cellular signals of tissue dysfunction (e.g., increased liver enzyme activity or pathologic changes in female genital epithelial cells), as well as physiologic signs of dysfunction such as increased blood pressure or decreased lung capacity. Note that these markers are not often substance specific. They also may not be directly adverse, but can indicate potential health impairment (e.g., DNA adducts). Biomarkers of effects caused by radon are discussed in Section 3.9.2.

A biomarker of susceptibility is an indicator of an inherent or acquired limitation of an organism's ability to respond to the challenge of exposure to a specific xenobiotic substance. It can be an intrinsic genetic or other characteristic or a preexisting disease that results in an increase in absorbed dose, a decrease in the biologically effective dose, or a target tissue response. If biomarkers of susceptibility exist, they are discussed in Section 3.11, Populations That Are Unusually Susceptible.

#### **3.8.1 Biomarkers Used to Identify or Quantify Exposure to Radon**

Biomarkers of exposure to radon and its progeny include the presence of radon progeny in several human tissues and fluids, including bone, teeth, blood, hair, and whiskers; these progeny can be quantified by methods which are both specific and reliable (Blanchard et al. 1969; Clemente et al. 1984; Gotchy and

### 3. HEALTH EFFECTS

Schiager 1969). Although the presence of radon progeny in these tissues and fluids indicates exposure to radon, particularly as a consequence of ingestion of food or water, exposure to uranium or radium may also result in the presence of these decay products. The isotope  $^{210}\text{Po}$  may also be found in tissues after exposure to cigarette smoke. Levels of  $^{210}\text{Pb}$  in teeth have been associated with levels of radon in the environment in an area with high natural background levels of radon and its progeny (Clemente et al. 1984). Black et al. (1968) reported a correlation between radiation exposure and  $^{210}\text{Pb}$  levels in bone from uranium miners. However, cumulative exposure to these individuals was estimated. Biomarkers of exposure to radon or its progeny may be present after any exposure duration (e.g., acute, intermediate, chronic). Because of the relatively short half-lives of most radon progeny, with respect to a human lifetime, the time at which the biological sample is taken related to time of exposure may be important. However, for the longer-lived progeny the time factor is less critical.

Models are available which estimate exposure to radon from levels of stable radon progeny,  $^{210}\text{Pb}$  and  $^{210}\text{Po}$ , in bone, teeth, and blood (Blanchard et al. 1969; Clemente et al. 1982, 1984; Eisenbud et al. 1969; Gotchy and Schiager 1969; Weissbuch et al. 1980). However, these models make numerous assumptions, and uncertainties inherent in all models are involved in these estimates. Therefore, at present, these estimated levels of biomarkers of exposure are not useful for quantifying exposure to radon and its progeny. Quantification of exposure to radon is further complicated by the fact that radon is a ubiquitous substance, and background levels of radon and its progeny are needed to quantify higher than "average" exposures.

#### **3.8.2 Biomarkers Used to Characterize Effects Caused by Radon**

The principal target organ identified in both human and animal studies following exposure to radon and its progeny is the lung. Alterations in sputum cytology have been evaluated as an early indicator of radiation damage to lung tissue. The frequency of abnormalities in sputum cytology, which may indicate potential lung cancer development, increased with increasing cumulative exposures to radon and its progeny (Band et al. 1980; Saccomanno et al. 1974). Although abnormal sputum cytology may be observed following radon exposure, this effect is also seen following exposure to other carcinogens such as cigarette smoke. In addition, even though increases in the frequency of abnormal sputum cytology parameters can be measured, they may not provide reliable information regarding predicted health effects in exposed individuals.

### 3. HEALTH EFFECTS

Associations between chromosomal aberrations and environmental levels of radon have been reported (Pohl-Rüling and Fischer 1983; Pohl-Rüling et al. 1976, 1987). Signs of genotoxicity in underground miners exposed to radon and other potentially genotoxic substances include increased frequencies of chromosomal aberrations and micronuclei in lymphocytes (Bilban and Jakopin 2005; Bandom et al. 1978; Smerhovsky et al. 2001, 2002) and increased frequency of mutations of glycoporphin A in blood (Shanahan et al. 1996). However, these genotoxic effects can not be exclusively attributed to exposure to radon and its progeny.

#### 3.9 INTERACTIONS WITH OTHER CHEMICALS

The interaction of cigarette smoke with radon and the possible effect on radon-induced toxicity is a complex one and is still an issue under consideration. Cigarette smoke appears to interact with radon and its progeny to potentiate their effects. In general, epidemiological studies have reported synergistic, multiplicative, or additive effects of cigarette smoke in lung cancer induction among miners exposed to radon and its progeny (see NAS 1999a for an in-depth discussion of interactions between smoking and exposure to radon). Studies by Lundin et al. (1969, 1971) reported 10 times more lung cancer among U.S. uranium miners who smoked. In a case-control study of U.S. uranium miners, Archer (1985) reported that smoking miners with lung cancer had significantly reduced latency- induction periods than nonsmokers. Cigarette smoking also appeared to shorten the latency period for lung cancer among Swedish lead-zinc miners (Axelson and Sundell 1978) and Swedish iron miners (Damber and Larsson 1982). Miners who smoke cigarettes may be at higher risk because of possible synergistic effects between radon and its progeny and cigarette smoking (Klaassen et al. 1986). For example, modeling results of Thomas et al. (1994), using data on lung cancer mortality in the Colorado Plateau uranium mining cohort, indicated a multiplicative synergistic relationship between lung cancer mortality and exposure to radon among smokers. The strongest modifier of the synergistic effect between radon and smoking in this cohort was the timing of exposures. Exposure to radon followed by the onset of smoking resulted in a more-than-multiplicative effect, whereas when smoking was initiated prior to occupational radon exposure, the synergistic effect was sub-multiplicative. Modeling results of data from another mining cohort in China (Yao et al. 1994) suggested that the synergistic effect of radon exposure and smoking was greater than additive and less than multiplicative; furthermore, the risk of lung cancer was higher if smoking and exposure to radon progeny occurred together rather than if smoking was initiated following the cessation of occupational exposure to radon progeny. Results of analysis of pooled results from 13 European residential case-control studies indicate that the proportionate increase in lung cancer risk per unit increase in radon concentration is similar in lifelong nonsmokers and cigarette smokers. At

## 3. HEALTH EFFECTS

the level of the individual, radon-induced lung cancer risk following exposure to radon concentrations up to 400 Bq/m<sup>3</sup> (10.8 pCi/L) is thought to be approximately 25 times greater than the risk for cigarette smokers (Darby et al. 2005, 2006).

Some animal studies support the theory that cigarette smoke potentiates the effects of radon and its progeny alone or in conjunction with uranium ore dust. A study by Chameaud et al. (1982b) reported an increase in the incidence of lung cancer, as well as a decrease in the cancer latency period in rats exposed to radon and then to cigarette smoke, compared to rats exposed to radon and its progeny alone. This study did not include untreated controls. Alterations in normal blood parameters, including carboxyhemoglobin levels and leukocyte counts, were observed in dogs exposed to cigarette smoke followed by exposure to radon progeny plus uranium ore dust, compared to animals exposed to only radon progeny plus uranium ore (Filipy et al. 1974). In contrast, some studies suggest an antagonistic interaction between smoking and radon progeny-induced lung cancer. Dogs exposed daily to cigarette smoke followed immediately by exposure to radon and its progeny and uranium ore dust exhibited a decrease in the incidence of lung tumors, compared to dogs exposed to radon and its progeny plus uranium ore dust (Cross et al. 1982b). Cross (1988) reported that this was possibly due to a thickening of the mucus layer as a result of smoking and, to a lesser extent, a stimulatory effect of cigarette smoke on mucociliary clearance, although no empirical evidence was collected during the experiment to test these possibilities.

In rats, administration of chemicals present in cigarette smoke after exposure to radon and its progeny resulted in a decrease in the lung cancer latency period when compared to the time-to-tumor induction in animals treated with radon alone. This effect was seen with 5,6-benzoflavon (Queval et al. 1979) and cerium hydroxide (Chameaud et al. 1974).

Other airborne irritants, as well as ore dust and diesel exhaust, may act synergistically with radon and its progeny to increase the incidence of adverse health effects. Epidemiological studies report the presence of other airborne irritants in mining environments, including arsenic, hexavalent chromium, nickel, cobalt (Ševc et al. 1984), serpentine (Radford and Renard 1984), iron ore dust (Damber and Larsson 1982; Edling and Axelson 1983; Radford and Renard 1984), and diesel exhaust (Damber and Larsson 1982; Ševc et al. 1984).

Cross and colleagues at Pacific Northwest Laboratory have conducted extensive experiments involving exposure of dogs, mice, rats, and hamsters to radon and its progeny in conjunction with uranium ore dust



### 3. HEALTH EFFECTS

and/or diesel exhaust (Cross 1988; Cross et al. 1981a, 1982b, 1984; NIEHS 1978; Palmer et al. 1973). Studies in hamsters, mice, and rats have shown that exposure to uranium ore dust and/or diesel exhaust increases the pulmonary effects of radon. Radon and combinations of uranium ore dust and/or diesel exhaust produced greater incidences of pulmonary emphysema and fibrosis in hamsters than radon and its progeny alone (Cross 1988). Exposure to uranium ore dust or diesel exhaust alone caused significant bronchial hyperplasia, but not as great an effect as combining either of these with radon and its progeny. The incidence of severe lesions of the upper respiratory tract (nasal passages and trachea) of mice and rats was increased following exposure to radon and uranium ore dust, compared to animals exposed to radon and its progeny alone (Palmer et al. 1973). An increased incidence of thoracic cancer (40%) was observed in rats treated with asbestos (mineral dust) after inhalation of radon and its progeny, compared with animals exposed to radon alone (Bignon et al. 1983). However, these tumors may have been due to asbestos rather than to an interaction between agents. This experiment did not include a group exposed only to mineral dusts. Inhalation exposure to radon and its progeny in conjunction with silicon dioxide increased the incidence of nodular fibrosis of the lungs in rats (Kushneva 1959).

#### **3.10 POPULATIONS THAT ARE UNUSUALLY SUSCEPTIBLE**

A susceptible population will exhibit a different or enhanced response to radon than will most persons exposed to the same level of radon in the environment. Reasons may include genetic makeup, age, health and nutritional status, and exposure to other toxic substances (e.g., cigarette smoke). These parameters result in reduced detoxification or excretion of radon, or compromised function of organs affected by radon. Populations who are at greater risk due to their unusually high exposure to radon are discussed in Section 6.7, Populations with Potentially High Exposures.

Populations that may be more susceptible to the respiratory effects of radon and its progeny are people who have chronic respiratory disease, such as asthma, emphysema, or fibrosis. People with chronic respiratory disease often have reduced expiration efficiency and increased residual volume (i.e., greater than normal amounts of air left in the lungs after normal expiration) (Guyton 1977). Therefore, radon and its progeny would be resident in the lungs for longer periods of time, increasing the risk of damage to the lung tissue. Persons who have existing lung lesions may be more susceptible to the tumor-causing effects of radon (Morken 1973). In an assessment of lung cancer cases pooled from three residential case-control studies, radon concentrations  $>121 \text{ Bq/m}^3$  (3.3 pCi/L) were associated with more than a 3-fold interaction odds ratio among glutathione-S-transferase M1 (GSTM1) null homozygotes compared to GSTM1 carriers (Bonner et al. 2006). In the study, it had been hypothesized that GSTM1 null homozygotes would have

### 3. HEALTH EFFECTS

decreased ability to neutralize reactive oxygen species induced by ionizing radiation and tobacco smoke. Thus, GSTM1 null homozygotes may exhibit increased susceptibility to the respiratory effects of radon and its progeny.

#### **3.11 METHODS FOR REDUCING TOXIC EFFECTS**

As discussed in detail in Section 3.2.1 (Inhalation Exposure), lung cancer is the primary toxicity concern following long-term exposure to radon and radon progeny. The high-energy alpha emissions from radon progeny deposited in the airways are the source of toxicity concern. The sequence of events leading from irradiation of living cells is generally believed to involve ionization that causes cellular damage including DNA breakage, accurate or inaccurate repair, apoptosis, gene mutations, chromosomal change, and genetic instability. Cigarette smoke appears to interact with radon and its progeny to potentiate their effects.

Methods for reducing the potential for radon-induced toxic effects consist of monitoring indoor air for radon levels, reducing potentially hazardous levels by ventilation and other accepted radon removal methods, and cessation of cigarette smoking.

##### **3.11.1 Reducing Peak Absorption Following Exposure**

No data are available.

##### **3.11.2 Reducing Body Burden**

No data are available.

##### **3.11.3 Interfering with the Mechanism of Action for Toxic Effects**

There is an increasing amount of information regarding the possible efficacy of dietary micronutrients at reducing lung cancer risk in smokers. Alavanja (2002) published a review of tobacco smoke- and radon-induced damage and potential preventive interventions. It was noted that available data indicate that micronutrients associated with a reduction in lung cancer risk among smokers might also reduce the risk in nonsmokers, possibly via antioxidant properties. Thus, diets high in fruits and vegetables might be of benefit in neutralizing reactive oxygen species produced by cigarette smoke and radon.

## 3. HEALTH EFFECTS

**3.12 ADEQUACY OF THE DATABASE**

Section 104(I)(5) of CERCLA, as amended, directs the Administrator of ATSDR (in consultation with the Administrator of EPA and agencies and programs of the Public Health Service) to assess whether adequate information on the health effects of radon is available. Where adequate information is not available, ATSDR, in conjunction with the National Toxicology Program (NTP), is required to assure the initiation of a program of research designed to determine the health effects (and techniques for developing methods to determine such health effects) of radon.

The following categories of possible data needs have been identified by a joint team of scientists from ATSDR, NTP, and EPA. They are defined as substance-specific informational needs that if met would reduce the uncertainties of human health assessment. This definition should not be interpreted to mean that all data needs discussed in this section must be filled. In the future, the identified data needs will be evaluated and prioritized, and a substance-specific research agenda will be proposed.

**3.12.1 Existing Information on Health Effects of Radon**

The existing data on health effects of inhalation, oral, and dermal exposure of humans and animals to radon are summarized in Figure 3-9. The purpose of this figure is to illustrate the existing information concerning the health effects of radon. Each dot in the figure indicates that one or more studies provide information associated with that particular effect. The dot does not necessarily imply anything about the quality of the study or studies, nor should missing information in this figure be interpreted as a “data need”. A data need, as defined in ATSDR’s *Decision Guide for Identifying Substance-Specific Data Needs Related to Toxicological Profiles* (Agency for Toxic Substances and Disease Registry 1989), is substance-specific information necessary to conduct comprehensive public health assessments.

Generally, ATSDR defines a data gap more broadly as any substance-specific information missing from the scientific literature.

Figure 3-9 graphically describes whether a particular health effect end point has been studied for a specific route and duration of exposure. Most of the information on health effects in humans caused by exposure to radon and radon progeny was obtained from epidemiological studies of uranium and other hard rock miners. These studies of chronic occupational exposure to radon via inhalation provide information on cancer and lethality, and limited insight into reproductive and genetic effects. Limited information is also available regarding cancer following dermal exposure to radon and its progeny. No information on the health effects of radon and its progeny in humans was available following acute or

3. HEALTH EFFECTS

**Figure 3-9. Existing Information on Health Effects of Radon**

	Systemic									
	Death	Acute	Intermediate	Chronic	Immunologic/Lymphoretic	Neurologic	Reproductive	Developmental	Genotoxic	Cancer
Inhalation	●			●			●		●	●
Oral										●
Dermal										
External										

**Human**

	Systemic									
	Death	Acute	Intermediate	Chronic	Immunologic/Lymphoretic	Neurologic	Reproductive	Developmental	Genotoxic	Cancer
Inhalation	●	●	●	●					●	●
Oral										
Dermal										
External										

**Animal**

● Existing Studies

### 3. HEALTH EFFECTS

intermediate exposure by any route. No information on the health effects of radon and its progeny in animals following acute, intermediate, or chronic oral or dermal exposure was located. The only information available from animal studies was by the inhalation route of exposure, which provides data on systemic and genetic effects, as well as cancer.

#### 3.12.2 Identification of Data Needs

**Acute-Duration Exposure.** No data were located regarding adverse health effects in humans following acute exposure to radon and its progeny by any route. Single dose studies are available for laboratory animals that have been exposed by the inhalation and parenteral routes. No information is available on acute oral exposure in laboratory animals. Information is available on lethality following acute inhalation exposure to high doses. However, this study did not provide information on target organs, sensitive tissues, or cause of death. No information is available on effects in humans or animals following relatively low-level acute exposure to radon and its progeny. However, the greatest health concern for radon and its progeny is lung cancer, which results from long-term exposure, not acute-duration exposure. Studies designed to assess the potential for adverse health effects in humans following acute-duration exposure to radon and its progeny do not appear necessary at this time.

**Intermediate-Duration Exposure.** No data were located regarding adverse health effects associated with intermediate-duration exposure of humans to radon and its progeny by any exposure route. Epidemiological miner-based studies, in general, have focused on cohorts exposed to radon and its progeny for durations >1 year. Animal studies demonstrate that intermediate exposure to high levels of radon and its progeny can cause chronic respiratory toxicity and lung cancers and indicate that similar effects might occur following intermediate-duration exposure in humans. The relationship between the nature and severity of the respiratory toxicity and the amount of radon exposure is not clearly defined; nor is there any information regarding systemic toxicity following intermediate-duration exposure. Additional research on the dose-duration-response relationship between radon exposure and the type and permanence of resulting toxicity would provide pertinent information. If populations exposed to radon and its progeny for intermediate durations can be identified, such populations could be assessed for potential adverse health outcomes.

**Chronic-Duration Exposure and Cancer.** Knowledge of the adverse health effects in occupationally-exposed humans following chronic-duration exposure to radon and its progeny is historically based on studies in adult male underground miners. These studies describe predominantly

### 3. HEALTH EFFECTS

respiratory end points, such as pneumoconiosis, emphysema, interstitial pneumonitis, pulmonary fibrosis, tuberculosis, and cancer. One study of a cohort of uranium miners in the Czech Republic included a finding of significant positive associations between cumulative radon exposures and incidences of chronic lymphocytic leukemia and all leukemias combined (Řeřicha et al. 2006). Additional studies of occupationally- and residentially-exposed individuals are needed to more completely assess the potential for radon-induced leukemias. To a large extent, other health effects have not been studied; additional studies assessing health effects other than respiratory and cancer end points do not appear necessary.

Numerous residential case-control studies are available for which possible associations between lung cancer and residential radon levels have been assessed. Collectively, these studies provide evidence of radon-induced lung cancer from long-term residential exposure. Continued assessment of residential radon exposure is needed to more accurately assess health risks associated with long-term residential exposure to radon and radon progeny. These assessments should include improved methods such as glass-based retrospective radon detectors (Field et al. 1999b; Steck et al. 2002; Sun 2008) and validation of such methods to more accurately estimate exposure scenarios. In addition, extensive data regarding radon exposure in non-residential buildings are needed.

Although radon dissolved in drinking water is a source of human exposure, few studies have reported on the potential health implications associated with ingested radon and radon progeny. However, additional studies do not appear necessary at this time.

**Genotoxicity.** The genotoxicity of alpha radiation from radon and radon progeny has been investigated in underground miners, in individuals residing in homes with measured radon levels, in laboratory animals *in vivo*, and in a variety of *in vitro* test systems. Increases in chromosomal abnormalities have been reported in peripheral blood lymphocytes of underground miners and occupants of residences where relatively high levels of radon were measured. Results of numerous *in vivo* and *in vitro* studies support the findings of radiation-induced chromosomal abnormalities associated with exposure to radon and radon progeny. Additional studies do not appear necessary at this time.

**Reproductive Toxicity.** Results of a few epidemiological studies indicated that exposure to radon and its progeny during uranium mining may be associated with alterations in the secondary sex ratio among offspring (Dean 1981; Muller et al. 1967; Wiese and Skipper 1986). More recent assessments of mining cohorts did not focus on reproductive end points. Limited animal data are available regarding potential reproductive effects following exposure to radon and radon progeny. Available toxicokinetic

### 3. HEALTH EFFECTS

data do not implicate reproductive tissues as particularly vulnerable tissues of concern following exposure to radon and radon progeny.

**Developmental Toxicity.** Available information regarding the potential for radiation-induced developmental effects following exposure to radon and radon progeny is limited to negative findings in rats following inhalation exposure to 12 WLM of radon and radon progeny (absorbed onto ore dust) for 18 hours/day at a rate of 124 WLM/day on destination days 6–19 (Sikov et al. 1992). Additional animal studies could be designed to support or refute the results of Sikov et al. (1992).

**Immunotoxicity.** No information was located regarding potential radon-induced effects on the immune system of humans or in animals exposed to radon and its progeny at concentrations considered relevant to human health.

**Neurotoxicity.** Cells and tissues in the nervous system may be less radiosensitive, due to a lack of cell turnover or cellular regeneration, than faster regenerating cells of the gastrointestinal tract or pulmonary epithelium. Consequently, neuronal impairment as a result of radon alpha emissions is not expected. Therefore, studies that specifically or directly measure either pathological or functional damage to the nervous system following exposure to radon do not appear to be necessary at this time.

**Epidemiological and Human Dosimetry Studies.** Knowledge of the adverse health effects in occupationally-exposed humans following chronic-duration exposure to radon and its progeny is based on studies in primarily adult male underground miners. These studies describe predominantly respiratory end points, such as pneumoconiosis, emphysema, interstitial pneumonitis, pulmonary fibrosis, tuberculosis, and cancer. However, lung cancer is the only respiratory effect that has been clearly associated with exposure to radon and radon progeny. One study of a cohort of uranium miners in the Czech Republic included a finding of significant positive associations between cumulative radon exposures and incidences of chronic lymphocytic leukemia and all leukemias combined (Řeřicha et al. 2006). Additional studies of occupationally- and residentially-exposed individuals are needed to more completely assess the potential for radon-induced leukemias. To a large extent, other health effects have not been studied; additional studies assessing health effects other than respiratory and cancer end points do not appear necessary.

Numerous residential case-control studies are available for which possible associations between lung cancer and residential radon levels have been assessed. Collectively, these studies provide evidence of

### 3. HEALTH EFFECTS

radon-induced lung cancer from long-term residential exposure. Continued monitoring of residential radon exposure is needed to more completely characterize exposure-response relationships. These assessments should include improved methods such as glass-based retrospective radon detectors (Field et al. 1999b; Steck et al. 2002; Sun 2008) and validation of such methods to more accurately estimate exposure scenarios. In addition, extensive data regarding radon exposure in non-residential buildings are needed.

#### **Biomarkers of Exposure and Effect.**

*Exposure.* Potential biomarkers of exposure may include the presence of radon progeny in urine, blood, bone, teeth, or hair. Although the detection of radon progeny in these media is not a direct measurement of an exposure level, estimates may be derived from mathematical models. Quantification of exposure to radon is further complicated by the fact that radon is a ubiquitous substance and background levels of radon and radon progeny are needed to quantify higher than "average" exposures.

*Effect.* It has been reported (Brandom et al. 1978; Pohl-Rüling et al. 1976) that chromosome aberrations in the peripheral blood lymphocytes may be a biological dose-response indicator of radiation exposure. In addition, the frequency of abnormalities in sputum cytology has been utilized as an early indicator of radiation damage to lung tissue (Band et al. 1980). However, more extensive research is needed in order to correlate these effects with radon exposure levels and subsequent development of lung cancer or other adverse effects.

**Absorption, Distribution, Metabolism, and Excretion.** The toxicokinetics of inhaled and ingested radon and radon progeny has been fairly well studied, but information regarding the toxicokinetics of radon and radon progeny following dermal exposure is limited. Additional information on the deposition patterns in airways for radon progeny and the relationship of these deposition patterns to the onset of respiratory disease could help to enhance understanding of the disease process and delineate health protective measures to reduce deposition.

**Comparative Toxicokinetics.** Similar target organs have been identified in both humans and laboratory animals exposed to radon and radon progeny. More information on respiratory physiology, target cells, lung deposition, and absorption of radon and its progeny in different animal species is needed to clarify observed differences in species-sensitivity and tumor types. For example, rats generally develop lung tumors in the bronchioalveolar region of the lung while humans develop lung tumors in



### 3. HEALTH EFFECTS

higher regions (tracheobronchial area). These studies could identify the appropriate animal model for further study of radon-induced adverse effects, although differences in anatomy and physiology of the respiratory system between animals and humans require careful consideration. Most of the information available on the toxicokinetics of radon and progeny has been obtained from studies of inhalation exposure. Studies on the transport of radon and progeny following oral and dermal exposures would be of use for comparing different routes of exposure, although oral and dermal exposure routes do not appear to be of particular toxicity concern.

**Methods for Reducing Toxic Effects.** Lung cancer is generally considered to be the only toxicity concern following long-term exposure to radon and radon progeny. The high-energy alpha emissions from radon progeny deposited in the lung are the source of toxicity concern. The sequence of events leading from irradiation of living cells is generally believed to involve ionization that causes cellular damage that includes DNA breakage, accurate or inaccurate repair, apoptosis, gene mutations, chromosomal change, and genetic instability. Cigarette smoke appears to interact with radon and its progeny to potentiate their effects.

Methods for reducing the potential for radon-induced toxic effects consist of monitoring indoor air for radon levels, reducing potentially hazardous levels by ventilation and other accepted radon removal methods, and cessation of cigarette smoking.

There are no known methods for reducing peak absorption or body burden of radon progeny. There is some indication that diets high in fruits and vegetables might be of benefit in neutralizing reactive oxygen species produced by cigarette smoke and radon (see Alavanja 2002).

**Children's Susceptibility.** If data needs, relating to both prenatal and childhood exposures, and developmental effects expressed either prenatally or during childhood, are identified, they are discussed in detail in the Developmental Toxicity subsection above.

Differences in lung morphometry and breathing rates in children may result in higher estimated radiation doses relative to adults (NCRP 1984a; Samet et al. 1989). However, available information from children employed as miners in China does not provide evidence of increased susceptibility to the effects of exposure to radon (Lubin et al. 1990; NIH 1994).

### 3. HEALTH EFFECTS

Child health data needs relating to exposure are discussed in Section 6.8.1, Identification of Data Needs: Exposures of Children.

#### **3.12.3 Ongoing Studies**

The following ongoing studies were identified in the Federal Research in Progress database (FEDRIP 2008).

Dr. Martha Linet, from the National Cancer Institute Division of Cancer Epidemiology and Genetics, is assessing the modification of risk from smoking intensity using tobacco data from a comprehensive case-control study of lung cancer in rural China in which high indoor radon levels were associated with increased risk of lung cancer.

Dr. David Mendez, from the University of Michigan, is modifying an existing population-based model that predicts tobacco use, radon exposure, and lung cancer mortality. The modified model will be used to elucidate the relative impact and cost-effectiveness of residential radon remediation strategies versus smoking reductions on radon-related lung cancer.

Additional research known to be underway includes pooling of results from Iowa and Missouri residential radon studies using glass-based detectors that are undergoing final calibration (field, personal communication) and pooling of results from the residential radon studies that contributed to the results of Krewski et al. (2005, 2006; North American studies) and Darby et al. (2005, 2006; European studies).

## 4. CHEMICAL, PHYSICAL, AND RADIOLOGICAL INFORMATION

### 4.1 CHEMICAL IDENTITY

Radon is a naturally occurring radionuclide. The largest source of radon in the environment is due to the ambient levels produced by the widespread distribution of uranium and its decay products in the soil (Buttafuoco et al. 2007; Weast 1980). Radon is a decay product of radium and part of the uranium decay chain (see Figure 4-1) (Buttafuoco et al. 2007; O'Neil et al. 2006). The chemical formula and identification numbers for radon are listed in Table 4-1.

### 4.2 PHYSICAL, CHEMICAL, AND RADIOLOGICAL PROPERTIES

Radon is the densest of all the gases. Important physical and chemical properties of radon are listed in Table 4-2. The radioactive properties of the important, short-lived daughters of  $^{222}\text{Rn}$  are listed in Table 4-3. The  $^{222}\text{Rn}$  decay series is depicted in Figure 4-1; the  $^{220}\text{Rn}$  (thoron) and  $^{219}\text{Rn}$  (actinon) decay series are depicted in Figures 4-2 and 4-3, respectively.

## 4. CHEMICAL AND PHYSICAL INFORMATION

**Table 4-1. Chemical Identity of Radon**

Characteristic	Radon	Reference
Isotope(s)	Recognized isotopes: $^{195}\text{Rn}$ through $^{228}\text{Rn}$ . Naturally-occurring isotopes: $^{222}\text{Rn}$ (radon) $^{220}\text{Rn}$ (thoron) $^{219}\text{Rn}$ (actinon)	DOE 2008
Registered trade name(s)	No data	
Chemical formula	Rn	
Chemical structure	Monatomic	
Identification numbers:		
CAS Registry	14859-67-7 ( $^{222}\text{Rn}$ ) 22481-48-7 ( $^{220}\text{Rn}$ ) 14835-02-0 ( $^{219}\text{Rn}$ )	ChemIDPlus 2008
NIOSH RTECS	No data	
EPA Hazardous Waste	No data	
OHM/TADS	No data	
DOT/UN/NA/IMDG	No data	
HSDB	6369 (radon radioactive)	HSDB 2008
NCI	No data	

CAS = Chemical Abstracts Services; DOT/UN/NA/IMDG = Department of Transportation/United Nations/North America/International Maritime Dangerous Goods Code; DOE = Department of Energy; Environmental Protection Agency; HSDB = Hazardous Substance Data Bank; NCI = National Cancer Institute; NIOSH = National Institute for Occupational Safety and Health; OHM/TADS = Oil and Hazardous Materials/Technical Assistance Data System; RTECS = Registry of Toxic Effects of Chemical Substances

4. CHEMICAL AND PHYSICAL INFORMATION

Figure 4-1. <sup>238</sup>U Decay Series Showing Sources and Decay Products

<sup>238</sup> U Series							
Np							
U	<sup>238</sup> U 4.468x10 <sup>9</sup> years		<sup>234</sup> U 2.455x10 <sup>5</sup> years				
Pa		<sup>234m</sup> Pa 1.159 minutes <sup>234</sup> Pa 6.70 hours					
Th		<sup>234</sup> Th 24.10 days	<sup>230</sup> Th 7.54x10 <sup>4</sup> years				
Ac							
Ra			<sup>226</sup> Ra 1,600 years				
Fr							
Rn			<sup>222</sup> Rn 3.82 days				
At				<sup>218</sup> At 1.5 seconds			
Po			<sup>218</sup> Po 3.098 minutes		<sup>214</sup> Po 1.643x10 <sup>-4</sup> seconds		<sup>210</sup> Po 138.4 days
Bi				<sup>214</sup> Bi 19.9 minutes		<sup>210</sup> Bi 5.01 days	
Pb			<sup>214</sup> Pb 26.8 minutes		<sup>210</sup> Pb 22.20 years		<sup>206</sup> Pb stable
Tl				<sup>210</sup> Tl 1.30 minutes		<sup>206</sup> Tl 4.20 minutes	

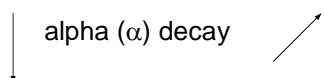
 alpha (α) decay      beta (β) decay or internal transition (IT)

Source: DOE 2008

## 4. CHEMICAL AND PHYSICAL INFORMATION

**Table 4-2. Physical and Chemical Properties of Radon**

Property	Radon	Reference
Molecular weight	222 (radon), 220 (thoron), 219 (actinon)	Cothern 1987a
Color	Colorless	Lewis 2001
Physical state	Gas at 0 °C and 760 mm Hg	Lewis 2001
Melting point	-71 °C	Lide 2005
Boiling point	-61.8 °C	Lewis 2001
Density at -20 °C	9.96x10 <sup>-3</sup> g/cm <sup>3</sup>	Cothern 1987a
Odor <sup>b</sup>	Odorless	O'Neil et al. 2006
Odor threshold:		
Water	Odorless	
Air	Odorless	
Solubility:		
Water at 20 °C	230 cm <sup>3</sup> /L	O'Neil et al. 2006
Organic solvents	Organic liquid, slightly soluble in alcohol	Weast 1980
Vapor pressure at 25 °C <sup>a</sup>	395.2 mm Hg	Cothern 1987a
Henry's Law constant	No data	
Autoignition temperature	Noble gas; does not autoignite	
Flash point	Noble gas; does not burn	
Flammability limits	Noble gas; is not flammable	
Half-life:		
<sup>222</sup> Rn	3.8235 days	DOE 2008
<sup>220</sup> Rn	55.6 seconds	DOE 2008
<sup>219</sup> Rn	3.96 seconds	DOPE 2008
Decay energies (MeV), and intensities (%)		
<sup>222</sup> Rn	Alpha particles: 4.826 (0.0005%) 4.986 (0.078%) 5.48948 (99.920%)	DOE 2008
<sup>220</sup> Rn	Gamma rays: 0.510 (0.076%) Alpha particles: 5.747 (0.114%) 6.288 (99.886%)  Gamma rays: 0.5497 (0.114%)	DOE 2008

## 4. CHEMICAL AND PHYSICAL INFORMATION

**Table 4-2. Physical and Chemical Properties of Radon**

Property	Radon	Reference
$^{219}\text{Rn}$	Alpha particles (15 reported): 6.425 (7.5%) 6.530 (0.12%) 6.553 (12.9%) 6.819 (79.4%)  Gamma rays (dozens reported): 0.0111 (9.6%) 0.0769 (5.0%) 0.0793 (8.4%) 0.2712 (10.8%)	U.S. DHEW 1970
Specific activity, nλ (Ci/g):		
$^{222}\text{Rn}$	$1.538 \times 10^5$	Based on DOE 2008
$^{220}\text{Rn}$	$9.135 \times 10^8$	Based on DOE 2008
$^{219}\text{Rn}$	$1.301 \times 10^{10}$	Based on DOE 2008
Decay products:	Radon progeny (daughters)	
$^{222}\text{Rn}$ (see Figure 4-1)	$^{218}\text{Po}$ $^{214}\text{Pb}$ $^{214}\text{Bi}$ $^{214}\text{Po}$ $^{210}\text{Tl}$ $^{210}\text{Pb}$ $^{210}\text{Bi}$ $^{210}\text{Po}$ $^{206}\text{Tl}$ $^{206}\text{Pb}$	DOE 2008
$^{220}\text{Rn}$ (see Figure 4-2)	$^{216}\text{Po}$ $^{212}\text{Pb}$ $^{212}\text{Bi}$ $^{212}\text{Po}$ $^{208}\text{Tl}$ $^{208}\text{Pb}$	DOE 2008
$^{219}\text{Rn}$ (see Figure 4-3)	$^{215}\text{Po}$ $^{215}\text{At}$ $^{211}\text{Pb}$ $^{211}\text{Bi}$ $^{211}\text{Po}$ $^{207}\text{Tl}$ $^{207}\text{Pb}$	DOE 2008

MeV = million electron volts

4. CHEMICAL AND PHYSICAL INFORMATION

Figure 4-2. <sup>232</sup>Th Decay Series Showing Sources and Decay Products

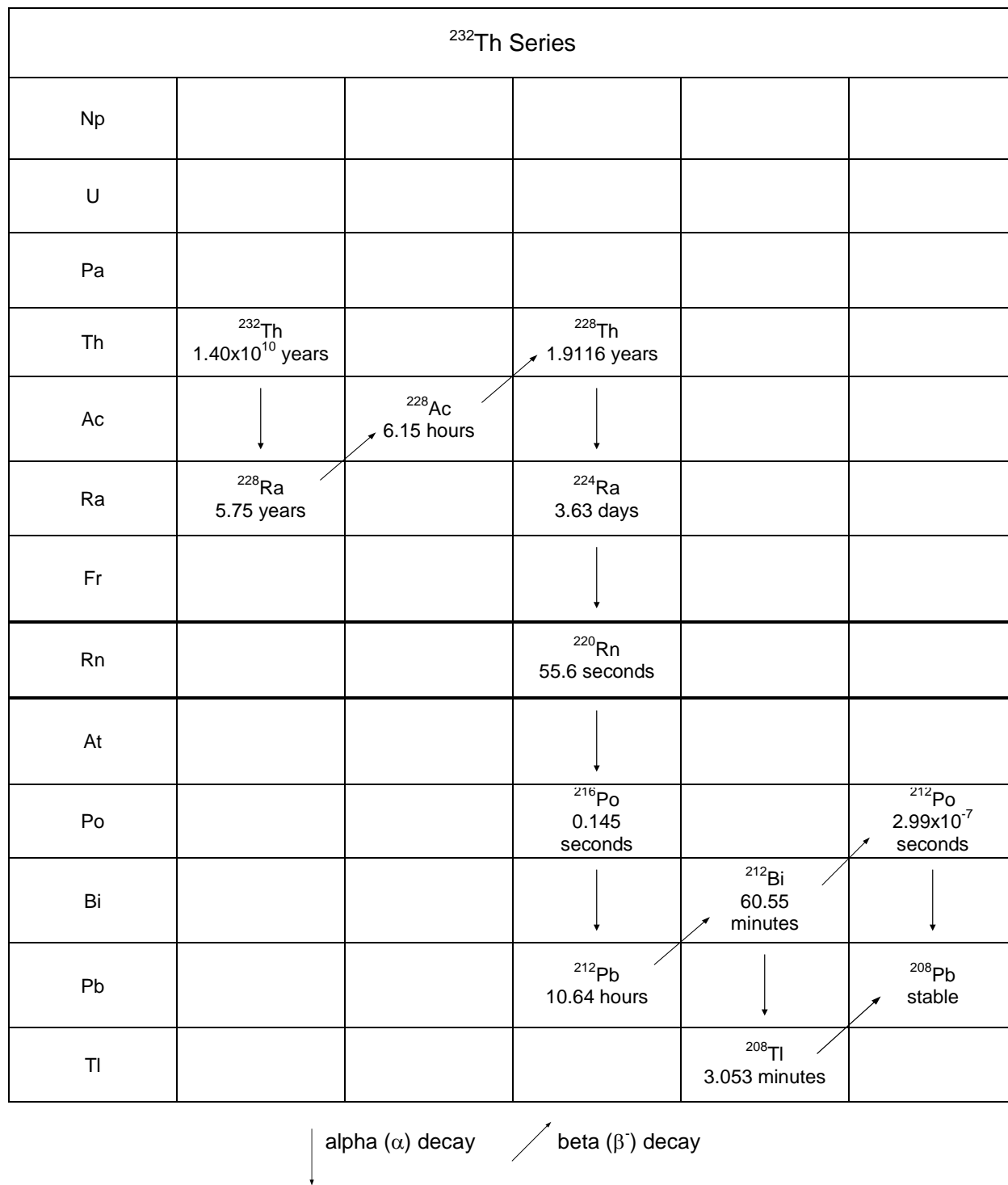

Source: DOE 2008



## 4. CHEMICAL AND PHYSICAL INFORMATION

**Table 4-3. Radioactive Properties of  $^{222}\text{Rn}$  and Its Short-lived Progeny**

Isotope	Historical symbol	Principal radiation(s)	Q-Value of principal decay mode (MeV)	Half-life	Specific activity (Ci/g)
$^{222}\text{Rn}$	Rn	$\alpha$	5.5903	3.8235 days	$1.54 \times 10^5$
$^{218}\text{Po}^a$	RaA	$\alpha$	6.1147	3.098 minutes	$2.78 \times 10^8$
$^{218}\text{At}$	At	$\alpha$	6.874	1.5 seconds	$3.45 \times 10^{10}$
$^{214}\text{Pb}$	RaB	$\beta, \gamma$	1.023	26.8 minutes	$3.28 \times 10^7$
$^{214}\text{Bi}$	RaC	$\beta, \gamma$	5.6168	19.9 minutes	$4.41 \times 10^7$
$^{214}\text{Po}^a$	RaC'	$\alpha$	7.8335	164.3 $\mu$ seconds	$3.21 \times 10^{14}$
$^{210}\text{Tl}$	RaC''	$\beta$	5.489	1.30 minutes	$6.89 \times 10^8$

<sup>a</sup>Isotopes of primary radiological interest due to the potential for retention in the lung and subsequent alpha decay.

MeV = million electron volts

Source: DOE 2008

4. CHEMICAL AND PHYSICAL INFORMATION

Figure 4-3. <sup>235</sup>U Decay Series Showing Sources and Decay Products

<sup>235</sup> U Series					
Np					
U	<sup>235</sup> U 7.04x10 <sup>8</sup> years				
Pa	↓	<sup>231</sup> Pa 3.276x10 <sup>4</sup> years			
Th	<sup>231</sup> Th 25.52 hours	↗	<sup>227</sup> Th 18.68 days		
Ac		<sup>227</sup> Ac 21.772 years	↓		
Ra		↓	<sup>223</sup> Ra 11.43 days		
Fr		<sup>223</sup> Fr 22.00 minutes	↓		
Rn			<sup>219</sup> Rn 3.96 seconds		
At			↓	<sup>215</sup> At 1.0x10 <sup>-4</sup> second	
Po			<sup>215</sup> Po 1.781x10 <sup>-3</sup> second	↓	<sup>211</sup> Po 0.516 second
Bi			↓	<sup>211</sup> Bi 2.14 minutes	↓
Pb			<sup>211</sup> Pb 36.1 minutes	↓	<sup>207</sup> Pb stable
Tl				<sup>207</sup> Tl 4.77 minutes	

↓ alpha (α) decay      ↗ beta (β<sup>-</sup>) decay or internal transition (IT)

Source: DOE 2008

## 5. PRODUCTION, IMPORT/EXPORT, USE, AND DISPOSAL

### 5.1 PRODUCTION

No information is available in the TRI database on facilities that manufacture or process radon because this chemical is not required to be reported under Section 313 of the Emergency Planning and Community Right-to-Know Act (Title III of the Superfund Amendments and Reauthorization Act of 1986) (EPA 1998).

Radon is a naturally occurring element; the isotope of primary health concern is  $^{222}\text{Rn}$ . The largest source of radon in the environment is widely distributed uranium and its decay products in the soil (Buttafuoco et al. 2007; UNSCEAR 2000; Weast 1980). Radon is a decay product of radium and part of the uranium decay chain (see Figure 4-1) (Buttafuoco et al. 2007; O'Neil et al. 2006; UNSCEAR 2000). Every square mile of surface soil, to a depth of 6 inches, contains approximately 1 gram of radium, which slowly releases radon to the atmosphere (Weast 1980) when conditions of secular equilibrium exist.

The total production rate of radon in soil equates to the decay rate of radium present, which can range from 10 to 100 Bq/kg (270–2,700 pCi/kg) in the surface soil and from ~15 to ~50 Bq/kg (~400–~1,350 pCi/kg) in rock (Buttafuoco et al. 2007). The release of radon from the soil-gas or water to ambient air is affected by the soil porosity, meteorological factors, variations in atmospheric pressure, and concentration of radon in the soil-gas or water (WHO 1983). The concentration of radon in soil gas is affected by grain size, mineralogy, porosity, density permeability, and moisture, radium, and uranium content of the soil (Ericson and Pham 2001; Price et al. 1994; USNRC 1981). Meteorological factors, such as temperature and precipitation, may both enhance and inhibit transport of radon from the soil into other media. Radon progeny in the air can be removed by rainfall, soil moisture, and snow (UNSCEAR 2000). Alternatively, radon may be temporarily increased at ground level when trapped by snowfall or frozen soil, but will be released from the soil surface into water during snowmelt (Bunzl et al. 1998; Fujiyoshi et al. 2002). Vertical temperature gradients can help release radon from the soil, while temperature inversions inhibit this movement. The mechanism of radon transport in soil is described more fully in Section 6.3.1.

Outdoor radon levels vary significantly with geographic location. The ambient outdoor radon level goes through a daily cycle of concentrations ranging from approximately 0.03 to 3.50 pCi /L (Martin and Mills 1973) with the average level in the United States, based on a natural residential radon survey, being about 0.4 pCi L of outdoor air (EPA 2008c). Radon levels can be highly elevated in indoor spaces (UNSCEAR

## 5. PRODUCTION, IMPORT/EXPORT, USE, AND DISPOSAL

2000). Indoor radon levels in the United States were found to range from approximately 0 to >80 pCi/L (3,000 Bq/m<sup>3</sup>) (Fleischer 1986; Steck et al. 1999; White et al. 1992). EPA estimates that the average indoor radon level is 1.25 pCi/L in the United States (EPA 2003; Marcinowski et al. 1994).

The amount of naturally occurring radon released to the atmosphere is increased in areas with uranium and thorium ore deposits and granite formations, which have a high concentration of natural uranium. It is the presence of granite formations that has greatly increased radon concentrations in eastern Pennsylvania and parts of New York and New Jersey. Sources of radon in the global atmosphere include natural emissions from radium in soil and water, tailings from metal mines (uranium, thorium, silver, tin, and phosphorus), agricultural lands utilizing phosphate fertilizers, and from construction materials and the burning of coal (EPA 2003; NAS 1999b; NCRP 1984a; Nero 1987). In a few locations, tailings have been used for landfills and were subsequently built on, resulting in possible increased exposure to radon (Eichholz 1987). There is also an increased radon concentration in spring water due to the deposition of radium isotopes in the sinter areas around hot springs, where it is coprecipitated with calcium carbonate or silica (NCRP 1975). In groundwater, radon may be present due to migration from rock and soil into surrounding groundwater (Hess et al. 1985; Lam et al. 1994).

Radon is not distributed commercially (Hwang et al. 2005). It has been produced commercially for use in radiation therapy, but for the most part, it has been replaced by radionuclides made in accelerators and nuclear reactors. Although no longer used, radiopharmaceutical companies and a few hospitals had pumped the radon from a radium source into tubes called "seeds" or "needles", which may be implanted in patients (Cohen 1979). Due to the short half-life, research laboratories and universities typically produce radon in the laboratory for experimental studies (Hwang et al. 2005). Radon gas is collected by bubbling air through a radium salt solution (Hwang et al. 2005; Lewis 2001). The evolved gas containing radon, hydrogen, and oxygen is cooled to condense the radon and the gaseous hydrogen and oxygen are removed (Hwang et al. 2005).

### 5.2 IMPORT/EXPORT

Radon is not imported into or exported from the United States.

### 5.3 USE

While there are currently few significant technical uses for radon (Hwang et al. 2005), it does have several potentially useful applications. Medical uses of radon in the United States began as early as 1914.

## 5. PRODUCTION, IMPORT/EXPORT, USE, AND DISPOSAL

Treatments were primarily for malignant tumors. The radon was encapsulated in gold seeds and then implanted into the site of malignancy. During the period of 1930–1950, radon seeds were used for dermatological disorders, including acne. Radon therapy was still being studied and applied as recent as 1980 (Morken 1980), although no current significant uses of radon in medicine were found.

Water or air containing naturally high levels of  $^{222}\text{Rn}$  has been used for therapeutic treatment of various diseases, such as arthritis (Becker 2003; Dobbin 1987; Pohl-Rüling and Fischer 1982). Small "radon mines" (caves with a high radon concentration in the air, such as abandoned mines) have been used as a health treatment (Cohen 1979). People would seek medical cures through exposure to radon gas for ailments ranging from arthritis, asthma, and allergies to diabetes and ulcers (Dobbin 1987), as well as for cancer treatment (Dobbin 1987; Lewis 2001). Radon "spas," with their commensurately high radon levels, have been used in Europe for the treatment of hypertension and a number of other disorders. In the former Soviet Union., for example, radon baths were often prescribed by the National Health System (Uzunov et al. 1981). As there is no sufficiently convincing evidence to support the therapeutic effects of radon, there will be no further discussion of this particular use.

Radon may be utilized in the prediction of earthquakes (Cothorn 1987b). Large quantities of radon have been found to migrate to the atmosphere from the earth from active fault zones, varying with atmospheric conditions and potentially with seismic activity (Buttafuoco et al. 2007). The emission of radon from soil and the concentration measured in groundwater appear to be good indicators of crustal activity. Other uses of radon include the study of atmospheric transport, the exploration for petroleum or uranium (Cothorn 1987b), as a tracer in leak detection, for flow-rate measurement, and in radiography. Radon is also used in chemical research (Lewis 2001) to initiate and influence reactions, as a label in surface study reactions, for radium and thorium determination, and in determining the behavior of filters (O'Neil et al. 2006).

As a tracer, radon can also be used in the identification and quantification of non-aqueous phase liquid (NAPL) contamination of the subsurface (Semprini et al. 2000). In the subsurface, naturally occurring  $^{222}\text{Rn}$  exists as a dissolved gas in the saturated zone. While groundwater radon concentrations vary with the mineral composition of the substrate, they rapidly equilibrate in the absence of NAPL. The groundwater radon concentration, however, may be much less when NAPL is present due to its affinity for partitioning into the organic NAPL phase. Reduced radon concentration correlates to the amount of NAPL in the subsurface pores. Scientists may then predict the location and saturation levels of NAPL by examining the distribution of radon in the subsurface (Semprini et al. 2000).

## 5. PRODUCTION, IMPORT/EXPORT, USE, AND DISPOSAL

**5.4 DISPOSAL**

Disposal of radon would only be applicable to those facilities producing and/or using it for medical or experimental purposes where its release may be controlled. Regulations regarding the land disposal of radionuclides, as set forth in 10 CFR 61 (USNRC 2008a), do not apply to radium, radon, or its daughters. Since radon is naturally occurring, it is not regulated by the U.S. Nuclear Regulatory Commission (USNRC) with the exception of emissions from uranium mill tailings. Uranium mill tailings contain radium, the precursor to radon. The Uranium Mill Tailings Radiation Control Act of 1978 (UMTRCA) established programs to control the disposal and stabilization of uranium mill tailings to minimize public health hazards associated with the decay of radium within the tailings (EPA 1995). Any other regulation of radon is up to the individual states. See Chapter 8 for a listing of regulations concerning radon.

While radioactive effluents from facilities operating under a USNRC license are regulated by 10 CFR 20 (2008b), these do not apply to radon. The USNRC regulations regarding uranium are listed in Table 8-1. Since radon is relatively short lived, it may be compressed and stored in tanks until it decays or, if the quantity is small, it may be adsorbed on activated charcoal (Cember 1983). Particulate matter may be removed from the gas by a variety of different devices including detention chambers, adsorbent beds, and liquefaction columns. After filtration, the remaining radioactive particulates are discharged into the atmosphere for dispersion of the nonfilterable low levels of activity (Cember 1983).

Discharge via combustion stream from a natural gas incinerator power plant may contain high levels of radon when the natural gas is retrieved from an area with high concentrations of radium. Radon can be released to the environment from fossil-fueled power plants since radon cannot be scrubbed from the combustion stream by standard methods. The average concentration of radon in the combustion stream of a plant reported by Ericson and Pham (2001) was 370 pCi /L (13,700 Bq/m<sup>3</sup>). Federal and State of California regulations do not control radioactive emissions such as these, which are considered to be “natural” emissions (Ericson and Pham 2001).

## 6. POTENTIAL FOR HUMAN EXPOSURE

### 6.1 OVERVIEW

Radon has been identified in at least 34 of the 1,699 hazardous waste sites that have been proposed for inclusion on the EPA National Priorities List (NPL) (HazDat 2008). However, the number of sites evaluated for radon is not known. The frequency of these sites can be seen in Figure 6-1. Of these sites, 33 are located within the United States and 1 is located in Guam (not shown).

$^{222}\text{Rn}$  is a naturally occurring radioactive noble gas that is part of the  $^{238}\text{U}$  decay chain, and is the daughter of  $^{226}\text{Ra}$ . Similarly,  $^{219}\text{Rn}$  and  $^{220}\text{Rn}$  are in the  $^{235}\text{U}$  and  $^{232}\text{Th}$  decay chains and immediate daughters of  $^{223}\text{Ra}$  and  $^{224}\text{Ra}$ . As radium decays, radon is formed and is released into small air or water-containing pores between soil and rock particles. If this occurs within radon's diffusion length of the soil surface, the radon may be released to ambient air (EPA 2003). Similarly, radon may migrate into groundwater. If this groundwater reaches the surface, some of the radon gas will release into the ambient air, but small amounts remain dissolved in the water. By far, the major sources of radon are its formation in and release from soil and groundwater, with soil contributing the greater amount (EPA 2003; Planinić et al. 1994). Radon is also released from the near surface water of oceans, tailings from mines (particularly uranium, phosphate, silver, and tin mines), coal residues, the combustion of fossil fuels (coal, oil, and natural gas), and building products (concrete, drywall, and brick) (Ericson and Pham 2001; Nero 1987). Global radon emissions from soil are estimated to be 2,400 million Ci  $^{222}\text{Rn}$  ( $8,880 \times 10^{16}$  Bq), followed by release from groundwater (500 million Ci), oceans (34 million Ci), phosphate residues (3 million Ci), uranium mill tailings (2 million Ci), coal residues (0.02 million Ci), natural gas emissions (0.01 million Ci), coal combustion (0.009 million Ci), and human exhalation ( $1 \times 10^{-5}$  million Ci) annually (Fishbein 1992). Monitoring data in this chapter are reported for  $^{222}\text{Rn}$  unless otherwise specified. The two other naturally occurring radioactive isotopes of radon,  $^{219}\text{Rn}$  and  $^{220}\text{Rn}$ , are not discussed due to their short half-lives (3.96 and 55.6 seconds, respectively; see Figures 4-2 and 4-3) (DOE 2008).

The ultimate fate of radon is transformation through radioactive decay. Radon decays only by normal radioactive processes (i.e., an atom of radon emits an alpha particle resulting in an atom of polonium, which itself undergoes radioactive decay to other radon daughters or progeny) (EPA 2003). There are no sinks for radon, since its radioactive half-life is so short (3.8 days) (O'Neil et al. 2006).

6. POTENTIAL FOR HUMAN EXPOSURE

**Figure 6-1. Frequency of NPL Sites with Radon Contamination**

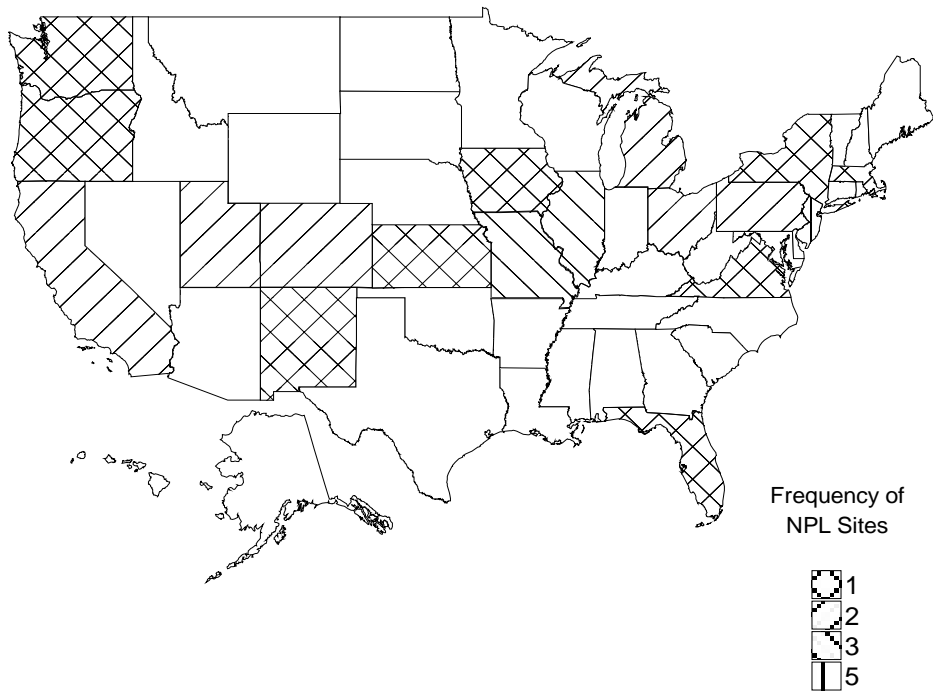

Derived from HazDat 2008



## 6. POTENTIAL FOR HUMAN EXPOSURE

In soil, radium atoms decay to radon, which can be released from the soil mineral matrix and transported through the soil column, ultimately being released to air. Alpha recoil is the process by which radon, when it is formed by radium emitting an alpha particle, actually recoils in the opposite direction from the path of particle ejection. Alpha recoil is important because this process dislodges radon from the edge of the soil mineral matrix and allows it to enter pore space between the soil grains. After radon is released into the pore spaces, its ultimate release to ambient air is a function of the soil porosity, soil moisture content, and meteorological factors, such as precipitation, atmospheric pressure, and the temperature versus altitude profile. Once radon is released to ambient air, its dispersion is primarily determined by atmospheric stability, including vertical temperature gradients and effects of wind. Transport of radon in indoor air is almost entirely controlled by the ventilation flow path and rate. Generally, the indoor radon concentrations increase as ventilation rates decrease. These transport processes are discussed in more detail in Section 6.3.1.

In groundwater, radon moves by diffusion and, primarily, by the mechanical flow of the water. Radon solubility in water is relatively low and, with its short radioactive half-life of 3.825 days (O'Neil et al. 2006), much of it will decay before it can be released from groundwater. Groundwater supplies in the United States have been surveyed for radon levels. In larger aquifers, average radon concentrations were reported to be 240 pCi (8.8 Bq)/L of water, while in smaller aquifers and wells, average levels were considerably higher (780 pCi/L of water; 28.9 Bq/L) (Cothorn et al. 1986). These differences in radon levels between large and small groundwater supplies are a reflection of the type of rock that surrounds them. For public groundwater-derived water supplies, the average radon concentration is estimated at 540 pCi/L (20 Bq/L), although some wells have been found to have radon concentrations up to 400 times the average concentration (up to  $1 \times 10^7$  Bq/m<sup>3</sup>; 270,000 pCi/L). Surface water tends to have the lowest radon concentrations (NAS 1999b).

Radon levels in ambient air vary with the type of soil and underlying bedrock of the area. The average outdoor radon concentration in the United States is about 0.4 pCi/L (14.8 Bq/m<sup>3</sup>) (NAS 1999b). Measurements in Iowa and Minnesota show higher levels, with average outdoor concentrations of 0.60–0.82 pCi/L (22.2–30.3 Bq/m<sup>3</sup>) (Steck et al. 1999). Concentrations as high as 2,000 pCi/L (74,000 Bq/m<sup>3</sup>) have been observed in certain locations in the United States (EPA 2008c). Based on the Natural Residential Radon Survey, EPA estimates that the average indoor radon level is 1.25 pCi/L (46.25 Bq/m<sup>3</sup>) in the United States (EPA 2003; Marcinowski et al. 1994); however, several locations in the country have

## 6. POTENTIAL FOR HUMAN EXPOSURE

been documented where the average indoor air levels are several times greater than the national average (Field 2005; Steck et al. 1999).

Measurements of radon in soil are expressed in terms of levels in soil-gas. However, these measurements do not directly relate to rates of radon released to the atmosphere. Factors that affect radon soil-gas levels include soil properties such as radium content, mineral composition, moisture content, density, and soil porosity. Radon concentrations in soil may also be affected by meteorological conditions on the surface, such as snow (Fujiyoshi et al. 2002).

The primary pathway for human exposure to radon is inhalation from soil vapor intrusion to dwellings and buildings; however, indoor radon levels can also originate from water usage, outdoor air infiltration, and the presence of building materials containing radium (EPA 2003). The committed dose from radon and its progeny is estimated by complex mathematical models and simplified tables have been published by EPA as Federal Guidance Report No. 13 (EPA 1999). Exposure, both occupational and environmental, will be discussed primarily in terms of radon or radon progeny levels in the air. However, some estimates of daily intake can be made. For example, using an average indoor air radon concentration of 1.25 pCi/L (EPA 2003; Marcinowski et al. 1994) and an assumed breathing rate of 20 m<sup>3</sup>/day, the radon daily intake from indoor air is 25,000 pCi/day. Using an estimated outdoor concentration of 0.4 pCi/L (NAS 1999b) and the same inhalation rate, the radon daily intake from outdoor air is 8,000 pCi/day.

Radon releases from groundwater also contribute to exposure. The daily intake of radon originating from drinking water only is estimated at 100–600 pCi (3.7–22.2 Bq)/day both from ingestion of drinking water and inhalation of radon released from drinking water (Cothorn et al. 1986).

The highest occupational exposures to radon typically result from employment in underground uranium and other hard rock mining, or in phosphate mining due to the high airborne levels of radon and its progeny (NIOSH 2006). For example, an abandoned uranium mine located in Hungary had an average radon concentration of 410 kBq/m<sup>3</sup> (11,100 pCi/L) at a depth of 15–55 m below the surface (Somlai et al. 2006). Although persons engaged in uranium mining are believed to receive the greatest exposures, the number of persons employed in uranium mining has greatly decreased. Furthermore, continuous improvements in engineering controls have lessened radon exposure in underground mines (NIOSH 1987). Measurements of radon progeny in U.S. mines from 1976 to 1985 showed annual mean concentrations of 0.11–0.36 working level (WL). A working level is “any combination of short-lived

## 6. POTENTIAL FOR HUMAN EXPOSURE

radon progeny in 1 liter of air that will ultimately release  $1.3 \times 10^5$  million electron volts of alpha energy during decay to lead-210" (NIOSH 1987). However, levels in phosphate mines measured during the same period showed a larger range of mean levels (0.12–1.20 WL) (NIOSH 1987). In 2006, assessments of radon exposure during phosphate plant operations resulted in an estimated mean concentration of 0.003 WL, based on limited data (NIOSH 2006).

While certain professions pose a higher risk of occupational exposure to radon (employment at underground mines for instance), exposure to high concentrations can occur in any location with geologic radon sources (Field 1999). A list of common occupations that have the potential for high radon and progeny exposure was developed by Field (1999). These occupations include employees of water treatment plants, radioactive contaminated sites, nuclear waste repositories, natural caverns, phosphate fertilizer plants, oil refineries, utility and subway tunnels, excavators, power plants, natural gas and oil piping facilities, health mines and spas, fish hatcheries, and hospitals (EPA 2003; Field 1999; Fisher et al. 1996). Higher exposure risks can also be present for farmers, radon mitigation professionals, and scientists studying radon or other radionuclides, although exposure to local radon sources can occur in any occupation (Field 1999).

### 6.2 RELEASES TO THE ENVIRONMENT

The Toxics Release Inventory (TRI) data should be used with caution because only certain types of facilities are required to report (EPA 2005). This is not an exhaustive list. Manufacturing and processing facilities are required to report information to the TRI only if they employ 10 or more full-time employees; if their facility is included in Standard Industrial Classification (SIC) Codes 10 (except 1011, 1081, and 1094), 12 (except 1241), 20–39, 4911 (limited to facilities that combust coal and/or oil for the purpose of generating electricity for distribution in commerce), 4931 (limited to facilities that combust coal and/or oil for the purpose of generating electricity for distribution in commerce), 4939 (limited to facilities that combust coal and/or oil for the purpose of generating electricity for distribution in commerce), 4953 (limited to facilities regulated under RCRA Subtitle C, 42 U.S.C. section 6921 et seq.), 5169, 5171, and 7389 (limited S.C. section 6921 et seq.), 5169, 5171, and 7389 (limited to facilities primarily engaged in solvents recovery services on a contract or fee basis); and if their facility produces, imports, or processes  $\geq 25,000$  pounds of any TRI chemical or otherwise uses  $>10,000$  pounds of a TRI chemical in a calendar year (EPA 2005).

## 6. POTENTIAL FOR HUMAN EXPOSURE

**6.2.1 Air**

There is no information on releases of radon to the atmosphere from manufacturing and processing facilities because these releases are not required to be reported (EPA 1998).

Because of the extended half-lives of uranium and radium and their abundance in the earth's surface, radon is continually being formed in soil and released to air. This normal emission of radon from  $^{226}\text{Ra}$  in soils is the largest single source of radon in the global atmosphere (NAS 1999b; NCRP 1984a; Planinić et al. 1994). Using an average soil emanation rate of 1,600 pCi/cm<sup>2</sup>-year and an estimated global surface area of  $1.5 \times 10^{18}$  cm<sup>2</sup>, Harley (1973) estimated soil emanation of radon to be on the order of  $2.4 \times 10^9$  Ci ( $7.4 \times 10^{19}$  Bq)/year. Some solubilized radon is removed from the soil by plants through evapotranspiration where it is subsequently released to the atmosphere by diffusion through the leaf (Kozak et al. 2003; Taskayev et al. 1986).

Radon levels in outdoor air are affected by the composition of the substrate in the region. A monitoring study of radon in outdoor air conducted at 50 sites with varying geological characteristics in the state of Nevada indicated that the median statewide concentration of radon was essentially that of the nationwide average level of 0.4 pCi/L (Price et al. 1994). However, concentrations as large as 1.4 pCi/L were observed and these high levels usually correlated with silica rich igneous rocks (rhyolite and granite). Groundwater radon concentrations are also affected by the type of substrate. According to a study of North Carolina groundwater from private wells, areas with soil comprised on sand, silt, sandstones, and shales tend to have lower groundwater radon concentrations (67–1,700 pCi/L [2.5–63 Bq/L]) than groundwater in areas with metamorphic and granitic rocks (21–59,000 pCi/L [0.8–2,200 Bq/L]) (Watson et al. 1993).

Groundwater that is in contact with radium-containing rock and soil will be a receptor of radon emanating from the surroundings. When the groundwater reaches the surface by natural or mechanical means, this radon will start to be released to air. Although most of the radon present in groundwater will decay before reaching the surface, groundwater is considered to be the second largest source of environmental radon and is estimated to contribute  $5 \times 10^8$  Ci ( $1.85 \times 10^{19}$  Bq)/year to the global atmosphere (Fishbein 1992; NCRP 1984a). Radon is also released from oceans, but only from the near surface water, and in amounts that are an order of magnitude less than that from groundwater. As radium in oceans is largely restricted to bottom sediments, most radon would decay before water could carry it to the surface. Radon emissions from oceans were estimated as  $2.3 \times 10^7$  Ci/year (Harley 1973).

## 6. POTENTIAL FOR HUMAN EXPOSURE

Radon in indoor air may also originate from volatilization of radon gas from water supplies used within homes for drinking, bathing, cooking, etc. Approximately 1–5% of the radon in indoor air was estimated to originate from water (Lam et al. 1994). Radon can also be released from water during the aeration portion of the water treatment process. In a study of the water treatment process, water-plant workers were found to be exposed to an average annual air concentration of 3.4 pCi/L (126 Bq/m<sup>3</sup>), from the water. According to the study, the average U.S. groundwater concentrations range from 200 to 600 pCi/L (Fisher et al. 1996), which implies an air-to-water ratio of approximately 1.7–5.7%.

Tailings from uranium mines and residues from phosphate mines both contribute to global radon in the approximate amount of  $2\text{--}3 \times 10^6$  Ci ( $7.4 \times 10^{16}$ – $1.11 \times 10^{17}$  Bq)/year. An abandoned mine in Hungary, with a subsurface radon concentration of 410 kBq/m<sup>3</sup> (11,100 pCi/L), was thought to have a significant effect on the air concentration of radon in houses above the mine. Indoor air concentrations, which averaged 667 Bq/m<sup>3</sup> (18.0 pCi/L), were likely elevated due to gas concentration within fissures reaching from the mine to the surface (Somlai et al. 2006). Fishbein (1992) reported that  $3 \times 10^6$  Ci of <sup>222</sup>Rn is emitted from phosphate residues and  $2 \times 10^6$  Ci of <sup>222</sup>Rn originates from uranium mill tailings each year.

Coal residues and fossil fuel (coal, oil, and natural gas) combustion products each contribute to atmospheric radon levels to a minor extent (NCRP 1984a). The portion from coal residues, such as fly ash, is very small. As natural gas retrieved from an area with concentrations of radium may contain high levels of radon, discharge via a combustion stream from a natural gas incinerator power plant may also have high radon levels. Emissions from one plant were measured as having an average concentration of 370 pCi/L (13,700 Bq/m<sup>3</sup>). Radon is a noble gas, so it is not feasible to scrub it from any combustion stream. As of 2001, federal and State of California regulations did not control radioactive emissions such as these, which are considered to be “natural” emissions. Liquefied natural gas products from these sites may contain radon and progeny (Ericson and Pham 2001). Fishbein (1992) reported that coal residue and natural gas emissions release 20,000 and 10,000 Ci of <sup>222</sup>Rn each year, respectively, while coal combustion results in 900 Ci of <sup>222</sup>Rn production annually.

### 6.2.2 Water

There is no information on releases of radon to the water from manufacturing and processing facilities because these releases are not required to be reported (EPA 1998).

## 6. POTENTIAL FOR HUMAN EXPOSURE

The amount of radon released to groundwater is a function of the chemical concentration of  $^{226}\text{Ra}$  in the surrounding soil or rock and in the water itself (Hess et al. 1985). Radon can dissolve in groundwater following radioactive decay of the radium. High radon concentrations are associated with groundwater running over granitic rock or through alluvial soils originating from granite (Hess et al. 1985; Lam et al. 1994). The physical characteristics of the rock matrix are also important since it is believed that much of the radon released diffuses along microcrystalline imperfections in the rock matrix (Hess et al. 1985). Radon can also enter surface water through decay of radium.

### 6.2.3 Soil

There is no information on releases of radon to the soil from manufacturing and processing facilities because these releases are not required to be reported (EPA 1998).

As stated in Section 6.2.1, soil is the primary source of radon (NCRP 1984a; Planinić et al. 1994). As such, radon is not released to soil but is the result of radioactive decay of  $^{226}\text{Rn}$  within the soil. Hopke (1987) states that normal soil-gas radon measurements are in the range of 270–675 pCi/L of air (10,000–25,000 Bq/m<sup>3</sup>). However, levels exceeding 10,000 pCi/L of air (370,000 Bq/m<sup>3</sup>) have been documented.

## 6.3 ENVIRONMENTAL FATE

### 6.3.1 Transport and Partitioning

The transport of radon from subsurface soil to air is a complex process that is dependent upon characteristics of the soil and meteorological conditions.

Emanation is the process by which radon is transported from the edge of a solid soil matrix to a gas or liquid pore space between the soil grains (Michel 1987). The mechanism by which this process occurs is primarily through alpha recoil. When a  $^{226}\text{Ra}$  atom decays, it emits a 5+ MeV alpha particle, which results in the formation of a radon atom. The alpha particle takes a virtually straight line path in one direction, heavily ionizing the matrix in one direction and temporarily weakening the local mineral structure. At the same time, the radon atom experiences a 5+ MeV equal, yet opposite reaction push, called a recoil, that physically moves the atom away from its original location. This recoil aids in moving a radon atom near the surface of a grain to a soil pore. The rate of emanation is typically slower in very dry soils since alpha recoil may also result in moving the recoiled atoms into an adjacent wall of another soil particle rather than an open pore space. On the other hand, if there is a small amount of water in the

## 6. POTENTIAL FOR HUMAN EXPOSURE

pore space, the kinetic energy of the recoiling atom can be dissipated and radon atoms can be slowed sufficiently before becoming embedded into an adjacent soil particle. Sasaki et al. (2004) reported that the alpha recoil range for radon was 0.02–0.07  $\mu\text{m}$  in common minerals, 0.1  $\mu\text{m}$  in water, and 63  $\mu\text{m}$  in air. Once held within the pore space, radon may be transported by diffusion and convection to the surface where it is ultimately released to air.

The actual release of radon from the pore space or soil-gas to ambient air is called exhalation, while its release from water is called evaporation. The rates of these processes are functions of many variables including the concentration of radon in the soil-gas or water, soil porosity and moisture, meteorological factors (such as temperature and precipitation), and variations in atmospheric pressure (NAS 1999b; WHO 1983). Soil moisture has an important but varying effect on radon release to the air. While lower levels of soil moisture greatly increase emanation by preventing recoil atoms from embedding into adjacent walls of soil particles as described above, saturated soil conditions in which the pores are filled with water tend to slow the rate of diffusion to the surface since the diffusion coefficient of radon is about 3 orders of magnitude lower in water as compared to air (Markkanen and Arvela 1992; Michel 1987; WHO 1983). The influence of moisture and temperature on the radon exhalation rate in concrete, alum shale, and alum shale bearing soil was studied in laboratory experiments (Stranden et al. 1984). The results indicated that for each material, increasing the rate of moisture up to a certain point increased the radon exhalation rate from the material due to enhanced emanation. For concrete samples, the maximum exhalation rate occurred at a moisture content of 4.5–5.5%, for the alum shale, the maximum rate occurred at 10–15%, and for the soil samples, the maximum exhalation rate occurred at 20–30% moisture content (Stranden et al. 1984). As the moisture content increased beyond these levels, a dramatic decrease in the exhalation rate was observed. The authors concluded that when the pores were completely filled with water, the reduced rate of diffusion significantly attenuated the exhalation rate of radon from the material. If the porosity of the samples is high as in the case of the soil, more water can be absorbed by the sample before the pores are filled and the maximum rate of radon exhalation will occur at a higher moisture content than for low porosity materials.

Vertical temperature gradients in the atmosphere can create slight vacuum conditions that pull radon from the soil, or temperature inversions that inhibit this movement. Therefore, meteorological events may both enhance and inhibit transport of radon from the soil into other media. For instance, radon may be released from the soil surface into water from melting snow (Fujiyoshi et al. 2002). Alternatively, winter conditions may cause radon-containing soil-gas to become trapped in frozen soil, thus decreasing transmission of radon to the atmosphere (Bunzl et al. 1998).

## 6. POTENTIAL FOR HUMAN EXPOSURE

Diurnal and seasonal changes affect the behavior of radon at the interface between soil and ambient air by impacting temperature and atmospheric mixing (NAS 1999b; UNSCEAR 2000). Once radon reaches a height of approximately 1 meter above the soil surface, its dispersion is predominantly determined by atmospheric stability (Cohen 1979). This stability is a function of vertical temperature gradient, direction and force of the wind, and turbulence. Temperature inversions in the early morning act to produce a stable atmosphere which keeps radon in the soil or near the ground or water surface. Solar radiation breaks up the inversion, leading to upward dispersion of radon which reverses with radiant cooling in late afternoon (Gesell 1983; NAS 1999b; UNSCEAR 2000). In general, radon levels in air typically decrease exponentially with altitude (Cohen 1979). In a study by Chandrashekara et al. (2006), outdoor radon concentrations at 1 meter above the ground were found to increase during the night, peak in the very early morning, and decrease during the day. In the United States, radon concentrations typically reach their maximum in the summer to early winter, whereas from late winter to spring, concentrations are usually at a minimum as a result of meteorological changes and soil moisture conditions (NAS 1999b).

Sources of indoor radon include entry of amounts released beneath the structure, entry in utilities such as water and natural gas, and release from building materials. Normally, the greatest contribution is that from radon released from soil or rock (Nero 1987; Planinić et al. 1994). Entry occurs primarily by bulk flow of soil-gas driven by small pressure differences between the lower and upper parts of the house interior and the outdoors. The pressure differences are primarily due to differences in indoor/outdoor temperature and the effects of wind (Nero 1987).

In cases where uranium or other metal mine or mill tailings are used for construction purposes, the primary source of indoor radon can be from these materials (Agency for Toxic Substances and Disease Registry 2006). Mill tailings are a rather uniform sand that may be superior to local supplies in quality and price. They have been used for under slab foundations, for concrete and mortar mix (used in laying foundations, block, brick, and stone work), and even as a supplement for vegetable gardens. Radon buildup in such homes, along with direct gamma emissions from radium and radon progeny, contribute to elevated radiation exposure.

Transport of radon in indoor air is primarily a function of the outflow ventilation rate of the enclosure. Most residential heating and air conditioning systems operate in a total recirculation mode, which doesn't contribute to a ventilation rate. Under most conditions, the indoor radon concentration increases in direct proportion to the decrease in ventilation rates (WHO 1983). However, in some indoor radon studies,



## 6. POTENTIAL FOR HUMAN EXPOSURE

radon concentrations showed greater variability than could be accounted for by ventilation rates. This was said to suggest that the strength of the radon source was the main cause of the wide range in observed indoor radon levels (Nero 1987). Behavior of radon in enclosed areas has also been extensively studied and predicted by modeling (Bowring 1992; Eichholz 1987; Kitto 2003).

Transport is primarily a function of the fraction of attachment of radon daughters to dust and dirt particles in the air, the concentration and size of the particles, and the rate of deposition. A major complication of modeling both radon and radon daughter transport indoors is that the outflow ventilation rate acts both to increase flow of radon into the structure and to remove radon and radon daughters from the structure through cracks and openings (Nero 1987). Air circulation rate also acts on the movement of air indoors causing variations in radon concentrations from room to room, as well as within a room.

Mechanisms for transport of radon in groundwater are complex. Just as transport in air is primarily governed by air flow patterns, the transport of radon in groundwater is accomplished by diffusion and, primarily, by the mechanical flow patterns of groundwater (Watson et al. 1993). As previously stated, the diffusion coefficient of radon in water is sufficiently low so that diffusion is only important for movement in very small and poorly ventilated spaces (such as pore spaces). The solubility of radon in water is relatively low (230 cm<sup>3</sup>/L of water at 20 °C) and, due to radon's relatively short half-life, much of it will have decayed to polonium and other non-volatile progeny before the groundwater reaches the surface. However, that remaining in solution can be released to ambient air once it is encountered. In areas where groundwater has high levels of radon, release from groundwater may significantly affect ambient air levels.

### 6.3.2 Transformation and Degradation

#### 6.3.2.1 Air

Regardless of the surrounding media, radon is a noble gas that transforms or degrades only by radioactive decay. There are no sinks for radon, and it is estimated that only negligible amounts escape to the stratosphere (Harley 1973). Therefore, the degradation of <sup>222</sup>Rn proceeds by alpha-emission with a half-life of 3.825 days (O'Neil et al. 2006). The half-lives of its first four progeny are much shorter, ranging from approximately 0.0002 seconds for <sup>214</sup>Po to 30 minutes for <sup>214</sup>Pb. The half-lives and progeny for <sup>219</sup>Rn, <sup>220</sup>Rn, and <sup>222</sup>Rn are internationally maintained by DOE (DOE 2008) and are shown in Figures 4-1 through 4-3.

## 6. POTENTIAL FOR HUMAN EXPOSURE

**6.3.2.2 Water**

Radon undergoes natural radioactive decay in water by the mechanisms described in Chapter 4.

**6.3.2.3 Sediment and Soil**

Radon undergoes natural radioactive decay in soil by the mechanisms described in Chapter 4.

**6.3.2.4 Other Media**

Though radon is inert, it can react with highly electronegative elements, such as oxygen, fluorine, and chlorine, to form relatively stable compounds (Hwang et al. 2005; O'Neil et al. 2006). For example, radon reacts with fluorine to form radon fluoride, which has a fairly low volatility (Chernick et al. 1962).

**6.4 LEVELS MONITORED OR ESTIMATED IN THE ENVIRONMENT**

Reliable evaluation of the potential for human exposure to radon depends in part on the reliability of supporting analytical data from environmental samples and biological specimens. Concentrations of radon in unpolluted atmospheres and in pristine surface waters are typically within the limits of current analytical methods. In reviewing data on radon levels monitored or estimated in the environment, it should also be noted that the amount of chemical identified analytically is not necessarily equivalent to the amount that is available. The analytical methods available for monitoring radon in a variety of environmental media are detailed in Chapter 7.

**6.4.1 Air**

Outdoor radon levels vary with geographic location and their proximity to radon sources in rocks and soil, water bodies, mines or mill tailings, and fossil-fuel combustion facilities (NAS 1999b). Gesell (1983) provided a compilation of data on radon levels in outdoor air. Measurements were taken over the continental United States, Hawaii, and Alaska. The highest concentrations were found in the Colorado Plateau, which is a region containing high levels of uranium as well as mines and uranium tailings. Measurements in this region ranged from 0.5 to 0.75 pCi/L of air (18.5–30 Bq/m<sup>3</sup>). Average values from the continental United States ranged from 0.12 to 0.3 pCi/L of air (4.4–11 Bq/m<sup>3</sup>). More recent estimates based on an analysis of the available data of radon concentrations outdoors and on the transfer from water to air approximate the average outdoor air concentration over the entire United States as approximately 0.4 pCi/L (14.8 Bq/m<sup>3</sup>) (NAS 1999b).

## 6. POTENTIAL FOR HUMAN EXPOSURE

Price et al. (1994) reported the statewide median outdoor air concentration in Nevada to be 0.4 pCi/L (15 Bq/m<sup>3</sup>), with a range of 0.07–1.40 pCi/L (2.6–52 Bq/m<sup>3</sup>) for 50 sites. The ranges correlated to various concentrations of radon in soil as well as uranium and progeny in rocks. In Iowa and Minnesota, Steck et al. (1999) reported average outdoor radon concentrations of 0.82 pCi/L (30 Bq/m<sup>3</sup>) and 0.60 pCi/L (22 Bq/m<sup>3</sup>), respectively. Values in Iowa ranged from 0.2 to 1.5 pCi/L (7–55 Bq/m<sup>3</sup>), while those in Minnesota ranged from 0.1 to 1.5 pCi/L (4–55 Bq/m<sup>3</sup>).

Radon concentrations in air decrease with height from the soil surface (NAS 1999b). Several investigators have measured radon levels in the troposphere. Machta and Lucas (1962) measured 0.007 pCi/L of air (0.26 Bq/m<sup>3</sup>) at 25,000 feet. Comparable measurements have been taken over Alaska and the southwestern United States (Harley 1973). Radon concentrations measured at a few centimeters above the ground surface may be a factor of 10 higher than measurements from 1 meter above the surface, although this factor would vary with atmospheric conditions (UNSCEAR 2000). The changes in radon concentration with height are thought to be the result of atmospheric conditions (mixing and turbulence) (NAS 1999b).

Numerous studies have been conducted to measure the radon concentrations of indoor air. Nero et al. (1986) reanalyzed up to 38 small data sets, of which 22 were considered unbiased. Biased data were those collected from areas where high radon concentrations were expected. On the basis of the unbiased data, the geometric mean of indoor radon levels was reported to be approximately 0.9 pCi/L of air (33 Bq/m<sup>3</sup>). The arithmetic mean concentration was 1.5 pCi/L of air (56 Bq/m<sup>3</sup>). Distribution studies of household levels indicated that from 1 to 3% of single-family houses may exceed 8 pCi/L of air (296 Bq/m<sup>3</sup>). In this study, many of the measurements were made in main-floor living rooms or average living areas (Nero et al. 1986). On average the relative air concentrations of radon in residential dwellings are 1.8, 1.0, 0.9, and 0.5 pCi/L (66.6, 37, 33.3, and 18.5 Bq/m<sup>3</sup>) for the basement, first, second, and third floors, respectively (Planinić et al. 1994), indicating that radon concentrations decrease with distance from the earth's surface. The National Residential Radon Survey conducted in 1989 and 1990 determined that the indoor average concentration of radon for U.S. homes was approximately 1.25 pCi/L (46.3 Bq/m<sup>3</sup>) (Marcinowski et al. 1994). Approximately 5% of homes studied (5.8 million homes) had radon levels exceeding the EPA's action level of 4 pCi/L (148 Bq/m<sup>3</sup>) (Marcinowski et al. 1994).

A screening assessment conducted by the EPA of 55,000 homes located in 38 different states indicated that six counties in the Three Mile Island vicinity of Pennsylvania (Cumberland, Dauphin, Lancaster,

## 6. POTENTIAL FOR HUMAN EXPOSURE

Lebanon, Perry, and York) had the highest regional average indoor air levels of radon (17.8 pCi/L) (Field 2005). The author suggested that these high radon levels are the main source of radiation exposure to residents in this area and have not often been accounted for in epidemiological studies of residents in this area. Homes built in contact with bedrock may have a higher likelihood of elevated radon concentrations in indoor air. Brookins (1991) reported high indoor radon levels in residential dwellings of Albuquerque, New Mexico. These values correspond to high soil radon levels in the area, although they may have also been affected by the type of building materials used in the homes. Four of five adobe buildings showed radon levels >4 pCi/L (ranging from 2.0 to 10.7 pCi/L), while smaller percentages of homes utilizing other construction methods had elevated levels.

In an EPA assisted survey of indoor radon concentrations within 30 states, concentrations were found to vary widely between states. Additionally, houses with livable basements had higher radon concentrations than houses without basements. The mean concentration for those with basements ranged from 1.8 pCi/L (67 Bq/m<sup>3</sup>) in Arizona and California to 9.4 pCi/L (348 Bq/m<sup>3</sup>) in Iowa. Those without basements had mean concentrations ranging from 0.5 pCi/L (19 Bq/m<sup>3</sup>) in Louisiana to 5.5 pCi/L (204 Bq/m<sup>3</sup>) in Iowa (White et al. 1992).

Indoor radon levels were measured in homes located in the Reading Prong area of Pennsylvania. This area has an unusual abundance of homes with high radon concentrations that is presumed to be from geologically produced emanation of radon. Indoor levels of radon in this area ranged from 4–20 pCi/L (150–740 Bq/m<sup>3</sup>) in 29% of the homes to >80 pCi/L (3,000 Bq/m<sup>3</sup>) in 1% of the homes (Fleischer 1986). During a hot spot survey, indoor residential radon levels, also in the Reading Prong area, ranged from 0.2 to 360 pCi/L (Lewis 1996).

#### 6.4.2 Water

In a nationwide survey by the EPA, almost 2,500 public drinking water supplies were sampled (nonrandom) with most of these serving greater than 1,000 people (Cothorn et al. 1986). Average concentrations for U.S. groundwater were estimated to be 240 pCi/L of water (8.8 Bq/L) for larger systems (>1,000 persons served) and 780 pCi/L of water (28.9 Bq/L) for smaller systems. The nationwide average for all groundwater samples tested in this study was 351 pCi/L (13 Bq/L). The highest levels reported were in smaller groundwater systems in Maine that averaged 10,000 pCi/L (370 Bq/L); lowest average levels were found in larger systems in Tennessee with levels of 24 pCi/L (0.9 Bq/L). Small, private groundwater systems appear to have a greater risk of radon contamination than

## 6. POTENTIAL FOR HUMAN EXPOSURE

larger systems (Swistock et al. 1993; Watson et al. 1993). The average radon concentration in groundwater-derived public water supplies is approximately 540 pCi/L (20 Bq/L), although some public water supplies have been found to have radon concentrations up to  $1 \times 10^7$  Bq/m<sup>3</sup> (270,000 pCi/L) (NAS 1999b). Longtin (1988, 1990) has compiled the results of a comprehensive monitoring study (1984–1986) regarding the levels of radon, radium, and uranium in public drinking water supplies in the United States. The results indicated that over 72% of the sites sampled had radon concentrations greater than the minimum reporting limit of 100 pCi/L (3.7 Bq/L), and a maximum concentration of 25,700 pCi/L (951 Bq/L) was observed.

The relationship between radon concentrations in groundwater and system size (concentrations tend to increase with decreasing system size) was previously reported by Hess et al. (1985). This correlation may reflect a relationship between system size and aquifer composition. Those rock types that are associated with high radon levels (granitic rock) do not form aquifers large enough to support large systems. However, smaller systems may tap into such aquifers. Alternatively, this may indicate the decay of radon in the distribution system of the municipal water supply, thereby increasing the radon concentration, versus concentrations in heavily used private wells (Field and Kross 1998).

Crystalline aquifers of igneous and metamorphic rocks generally have higher radon levels than other aquifer types. Aquifers comprised of granites or alluvial soils derived from granite consistently show the highest levels (Lam et al. 1994; Michel 1987), though sandstone and feldspar substrates are also correlated to high radon levels (Lam et al. 1994). Average radon levels in water from granite aquifers are usually  $\geq 2,703$  pCi/L of water (100 Bq/L) (Michel 1987). This is indicated in the data of Cothorn et al. (1986) which report the following trends in groundwater radon levels: in New England and the Piedmont and Appalachian Mountain Provinces, where igneous and metamorphic rocks form the aquifers, concentrations are in the range of 1,000–10,000 pCi/L of water (37–370 Bq/L); in the sandstone and sand aquifers that extend from the Appalachian Mountains west to the Plains, concentrations are generally  $< 1,000$  pCi/L of water (37 Bq/L). NAS (1999b) also reported high radon concentrations in public water supplies for New England, the Appalachian states, and the Rocky Mountain states, as well as areas of the Southwest and Great Plains. A granitic substrate in the San Joaquin Valley of California contributes to high radon concentration in groundwater. The groundwater of several California counties contains levels of radon as high as 1,000–10,000 pCi/L (Lam et al. 1994).

A study of groundwater from 48 Pennsylvania counties indicated a median radon concentration of 1,100 pCi/L for all samples, with a maximum concentration of 141,270 pCi/L. The highest

## 6. POTENTIAL FOR HUMAN EXPOSURE

concentrations were present in samples obtained from Southeastern Pennsylvania, which includes geologic formations typical of high radon emission (Swistock et al. 1993). In North Carolina, the arithmetic mean radon concentration tested in groundwater supplies of 400 homes was 1,800 pCi/L (67 Bq/L) (Watson et al. 1993).

It has been reported that the radon concentration in surface waters is usually  $<4,000 \text{ Bq/m}^3$  (108 pCi/L) NAS (1999b).

### 6.4.3 Sediment and Soil

Because radon is a gas, its occurrence in soil is most appropriately referred to as its occurrence in "soil-gas," which is the gas or water-filled space between individual particles of soil. Factors that affect radon soil-gas levels include radium content and distribution, soil porosity, moisture, and density. However, soil as a source of radon is seldom characterized by radon levels in soil-gas, but is usually characterized directly by emanation measurements or indirectly by measurements of members of the  $^{238}\text{U}$  series (NRC 1981). Radon content is not a direct function of the radium concentration of the soil, but radium concentration is an important indicator of the potential for radon production in soils and bedrock. However, Michel (1987) stated that average radium content cannot be used to estimate radon soil-gas levels, primarily due to differences in soil porosity. Similarly, Fujiyoshi et al. (2002) found that radium content may not control radon concentration in soil. In the study, radium concentrations were fairly consistent across various sites though the radon concentrations varied.

Despite such caveats, theoretical rates of radon formation in soil have been estimated as demonstrated by the following (Nevissi and Bodansky 1987):

Consider a cube which is 1 meter in each dimension. Using rounded numbers, if the average density of the soil is 2.0 grams per cubic-centimeter and the average radium-226 concentration is 1.0 pCi/g (0.037 Bq/g), the cube will contain 2 million grams of soil and  $2 \times 10^6 \text{ Ci}$  ( $7.4 \times 10^4 \text{ Bq}$ ) of radium-226. This corresponds to the production of  $7.4 \times 10^4$  radon atoms per cubic-meter per.

For a discussion of  $^{238}\text{U}$  and  $^{226}\text{Ra}$  levels in soil, see the ATSDR Toxicological Profiles for uranium and radium (Agency for Toxic Substances and Disease Registry 1990, 1999a).

Brookins (1991) reported the average concentration of radon in soil-gas in the United States is approximately 100 pCi/L. However, this value does not compare well with two soil-gas measurements

## 6. POTENTIAL FOR HUMAN EXPOSURE

for U.S. locations found in the literature: one from Spokane, Washington, with soil-gas radon levels of 189–1,000 pCi/L (7,000–37,000 Bq/m<sup>3</sup>) in soils formed from coarse glacial outwash deposits with 2.3 ppm uranium, and the other from Reading Prong, New Jersey, with soil-gas radon levels of 1,081–27,027 pCi/L of air (40,000–1,000,000 Bq/m<sup>3</sup>) (Michel 1987). Hopke (1987) states that normal soil-gas radon measurements are in the range of 270–675 pCi/L (10,000–25,000 Bq/m<sup>3</sup>).

Radon levels in soil-gas can fluctuate greatly, both temporally and spatially (Bunzl et al. 1998). A Bavarian study found that the concentration of radon in soil-gas of a high gravel content soil was higher at a depth of 0.5 m than at 1.0 m during the winter months, whereas in the summer, concentrations at the 1.0-m depth were higher. Bunzl et al. (1998) reasoned that high levels exhibited during the winter months were most likely the result of frozen soil conditions, whereby transmission of radon to the atmosphere is decreased and thus, levels in soil-gas are increased. The annual mean concentration at a depth of 0.5 m was observed to be 17.1 kBq/m<sup>3</sup> (462 pCi/L) while the mean level at a depth of 1.0 m was 15.2 kBq/m<sup>3</sup> (411 pCi/L) (Bunzl et al. 1998). At a depth of 38 cm, radon levels were found to range from 40 to 890 pCi/L in Albuquerque, New Mexico. The average summer value was 360 pCi/L, while the average winter levels were 200 pCi/L (Brookins 1991).

#### 6.4.4 Other Environmental Media

Limited information exists to indicate that plants absorb both <sup>226</sup>Ra and <sup>222</sup>Rn from the soil layer and that these compounds are translocated to above ground plant parts (Taskayev et al. 1986). However, there is little information on the quantitative contribution of this process to exposure from ingestion of plant crops or of emanation rates from these plants. A measurement of the emission rates of radon from field corn was located in the literature. <sup>222</sup>Rn flux from leaves was reported to be 2.47x10<sup>-4</sup> pCi (9.15x10<sup>-6</sup> Bq)/cm<sup>2</sup>/second. This rate was 1.8 times greater than the exhalation rate from local soil (Pearson 1967). Solubilized radon can be removed from the soil by plants through evapotranspiration, where it is subsequently released to the atmosphere by diffusion through the leaf. Kozak et al. (2003) designed a flow and transport model to describe the transport of radon and radium through soil and vegetation.

## 6.5 GENERAL POPULATION AND OCCUPATIONAL EXPOSURE

In the following section, exposure to radon is discussed in terms of environmental levels rather than in terms of actual or estimated dose. The estimation of whole body or target tissue dose of radionuclides is extremely complex and must be accomplished by mathematical models for the specific radionuclide.

## 6. POTENTIAL FOR HUMAN EXPOSURE

Although such models are available to estimate whole body and target tissue dose for radon, discussion of these lies outside the scope of this document. For a discussion of these models, the reader is referred to NCRP (1984a) or NAS (1999a).

The general population is exposed to radon by inhalation, both outdoors and indoors, as well as by ingestion. Radon concentrations in outdoor air often correspond to soil gas levels (Price et al. 1994), although concentrations vary widely with geographical location, depending on factors such as the radium content, soil porosity, and moisture content. Comparing data from multiple studies, NAS (1999b) reports that the mean radon concentrations range from 1 to 63 Bq/m<sup>3</sup> (0.027–1.7 pCi/L) with the highest values reported in Iowa and Maine, with an overall average radon concentration of 0.32 pCi/L (12 Bq/L). Measurements in Iowa and Minnesota show average outdoor concentrations of 0.60–0.82 pCi/L (Steck et al. 1999). The average outdoor air concentration of radon over the entire United States is approximately 0.4 pCi/L (NAS 1999b).

Due to the gaseous nature of radon, radon levels will decrease with increasing height from the soil surface. Studies of this vertical gradient indicate that a child who is 0.5 m tall would be exposed to 16% more radon than an adult who is 1.5 m tall (Michel 1987). Price et al. (1994), however, reported that radon concentrations in Nevada obtained at heights of 0.5, 1.0, and 2.0 m from the surface were not statistically different from each other.

Average radon levels indoors are found to be higher than ambient outdoor levels (Steck et al. 1999). Exposure to radon by the general population occurs primarily in residential settings where concentrations exceed the EPA action level of 4 pCi/L (CDC 1999). The National Residential Radon Survey conducted in 1989 and 1990 determined that the indoor average annual concentration for U.S. homes was approximately 1.25 pCi/L (EPA 2003; Marcinowski et al. 1994). Approximately 5% of homes studied (5.8 million homes) had radon levels exceeding the EPA's action level of 4 pCi/L (Marcinowski et al. 1994). Two large indoor monitoring efforts in the United States reported arithmetic mean levels ranging from 1.5 to 4.2 pCi/L of air (55–157 Bq/m<sup>3</sup>) (Alter and Oswald 1987; Nero et al. 1986). The data from Alter and Oswald (1987) are limited in that the dwellings do not represent a random sample and individual measurement values were reported rather than average concentrations from a residence.

Although the primary source of indoor radon is from soil, release of radon from water may contribute to indoor levels (Fishbein 1992; Lam et al. 1994). Nazaroff et al. (1987) performed an analysis that combined information on water use, efficiency of radon release from water, house volumes, and



## 6. POTENTIAL FOR HUMAN EXPOSURE

ventilation rates to determine the impact on indoor radon levels. Their analysis estimated that use of groundwater contributes an average of 2% to the mean indoor radon concentration in houses. Lam et al. (1994) concluded that groundwater may contribute 1–5% of indoor radon. As with levels in other media, levels of radon in groundwater vary greatly. In areas with high groundwater levels, the relative contribution to indoor radon levels will increase accordingly. Cothorn et al. (1986) report a daily intake of radon originating from drinking water of 100–600 pCi (3.7–22.2 Bq)/day, assuming that consumption was 2 L/day of groundwater. Additionally, small groundwater systems appear to have a greater risk of radon contamination than larger systems (Swistock et al. 1993).

The contribution of building materials to indoor radon (other than homes where metal mine or mill tailings have been used in construction) is estimated to be low in comparison with amounts which originate from soil and rock. In general, among common building materials, concrete and gypsum board release more radon than other materials. Renken and Rosenberg (1995) estimated that a typical basement with a 1,500 ft<sup>2</sup> (140 m<sup>2</sup>) concrete slab would have approximately 7.1 Bq/hour of radon entering through the concrete slab. As the volume of the house increase, the effective radon entry rate will decrease.

Persons who are occupationally exposed to radon typically are those employed in mining, primarily mining of uranium and hard rock (NIOSH 1987), but which also include silver, tin, and other mines (Lubin et al. 1994). Exposure to radon in underground mines has been shown by numerous studies to be a high risk factor for developing lung cancer (EPA 2003), particularly for miners in China, the Czech Republic, the United States, and Canada (Lubin et al. 1994).

NIOSH reports that in 2005, 22,838 workers were employed in underground metal and nonmetal mines in the United States, with 29,705 workers employed at all underground mines (including metal, nonmetal, coal, and stone mines) (NIOSH 2008a). In 2005, 263 metal mines and 739 nonmetal mines were reported (NIOSH 2008b). The number of underground uranium mines has decreased from 300 in 1980 to 16 in 1984 (NIOSH 1987) to 17 in 1992 (EPA 1995), although the number may have increased to <100 in 2003 (IAEA 2004). The number of employees in underground uranium mines has decreased from 9,000 in 1979 to 448 in 1986 (NIOSH 1987), although figures were not available for later years. Measurements of radon progeny concentrations in these mines from 1976 to 1985 showed annual geometric mean concentrations in uranium mines of 0.11–0.36 WL (equivalent to 22–72 pCi/L of air [800–2,664 Bq/m<sup>3</sup>] assuming an equilibrium factor of 0.5), with 95<sup>th</sup> percentile levels ranging up to 2.73 WL (546 pCi/L of air; 20,202 Bq/m<sup>3</sup>). Annual geometric mean levels in phosphate mines for the same period were 0.12–1.20 WL (24–240 pCi/L of air [888–8,880 Bq/m<sup>3</sup>]) with 95<sup>th</sup> percentile levels as high as 1.69 WL

## 6. POTENTIAL FOR HUMAN EXPOSURE

(338 pCi/L of air; 12,506 Bq/m<sup>3</sup>). Measurements in uranium/vanadium mines showed annual geometric mean concentrations similar to those in uranium mines. However, 95<sup>th</sup> percentile levels ranged up to 4.80 WL (960 pCi/L of air [3.6x10<sup>4</sup> Bq/m<sup>3</sup>]), which was the highest annual concentration reported among the different types of mines (NIOSH 1987). Estimates of annual cumulative radon progeny exposures indicated that of the 1,405 underground uranium miners working in 1984, 28% had exposures >1 WL (200 pCi/L of air; 7,400 Bq/m<sup>3</sup>).

Radon exposure in underground mines has been vastly reduced by installation of improved engineering controls. In New Mexico mines, the median annual exposure in 1967 of 5.4 Working Level Month (WLM) was reduced to 0.5 WLM by 1980 due to these improvements (Eichholz 1987). For 1982, Samet et al. (1986) reported a mean WLM of 0.7. A WLM expresses both intensity and duration of exposure (see Chapter 3 for further discussion).

Occupational exposure to radon can extend beyond mining. Water-plant operators may be exposed to high levels of radon gas created during the water treatment process. This occurs when radon emanates from water to air during the aeration process or when filter material to strip out uranium or radium is removed for disposal as radioactive waste. The geometric annual mean air concentration of radon in 31 water plants was 3.4 pCi/L (126 Bq/m<sup>3</sup>), with a maximum value of 133 pCi/L (4,921 Bq/m<sup>3</sup>) (Fisher et al. 1996). A high exposure risk is also present for employees at radioactive contaminated sites, nuclear waste repositories, natural caverns, phosphate fertilizer plants, oil refineries, utility and subway tunnels, excavators, power plants, natural gas and oil piping facilities, health mines and spas, fish hatcheries, and hospitals (EPA 2003; Field 1999; Fisher et al. 1996). Higher exposure risks are also present for farmers, radon mitigation professionals, and scientists, although exposure to local radon sources can occur in any occupation (Field 1999).

## 6.6 EXPOSURES OF CHILDREN

This section focuses on exposures from conception to maturity at 18 years in humans. Differences from adults in susceptibility to hazardous substances are discussed in Section 3.7, Children's Susceptibility.

Children are not small adults. A child's exposure may differ from an adult's exposure in many ways. Children drink more fluids, eat more food, breathe more air per kilogram of body weight, and have a larger skin surface in proportion to their body volume. A child's diet often differs from that of adults. The developing human's source of nutrition changes with age: from placental nourishment to breast milk

## 6. POTENTIAL FOR HUMAN EXPOSURE

or formula to the diet of older children who eat more of certain types of foods than adults. A child's behavior and lifestyle also influence exposure. Children crawl on the floor, put things in their mouths, sometimes eat inappropriate things (such as dirt or paint chips), and spend more time outdoors. Children also are closer to the ground, and they do not use the judgment of adults to avoid hazards (NRC 1993).

As radon levels decrease with increasing height from the soil surface, a child would likely face higher radon exposure than an adult. Studies of this vertical gradient indicate that a child who is 0.5 m tall would be exposed to 16% more radon than an adult who is 1.5 m tall (Michel 1987). Exposure levels at schools were utilized to provide an estimate of radon levels to which children may be exposed during the school day. However, limited U.S. data were available to address radon exposure of children.

Public locations, such as schools, have been surveyed rather extensively to determine levels of childhood exposure to radon. Ambient radon levels of over 10,000 Bq/m<sup>3</sup> (270 pCi/L) were reported in the basement of a public school in Jerusalem. The outlet of a pipe leading from the phosphate-rich soil into the basement was found to have radon levels of over 100,000 Bq/m<sup>3</sup> (2,700 pCi/L). While radon levels in the upper floors of the school only reached around 1,300 Bq/m<sup>3</sup> (35 pCi/L), children were exposed to high radon levels in the basement during certain classes. The school was closed, and remediation techniques were utilized to reduce the indoor radon concentration to below 75 Bq/m<sup>3</sup> (2.0 pCi/L) (Richter et al. 1997). The indoor radon concentrations were also monitored in a school in Kosovo during the spring and winter. Levels in 7 of 30 rooms were found to exceed 400 Bq/m<sup>3</sup> (11 pCi/L) during the winter (Bahtijari et al. 2006).

Additionally, higher respiration rates of children may influence the extent of radon and radon progeny inhaled. MacDonald and Laverock (1998) studied the exposure levels of soil-dwelling mammals in a radon-rich environment, concluding that larger mammals with higher lung capacities were least affected by radon. Most affected were smaller mammals with higher respiration rates. Using this logic, small children with high respiration rates, as compared to adults, may receive relatively higher radiation doses from inhaled radon and radon progeny.

Kendall and Smith (2005) examined the doses of radon and its decay products inhaled or ingested by 1-year-old infants and 10-year-old children in the United Kingdom. The largest internal doses were found to be associated with the organ of intake (the respiratory tract and stomach). Dose coefficients (or the dose per unit intake factors) were found to be higher for children than for adults, although the overall

## 6. POTENTIAL FOR HUMAN EXPOSURE

annual doses were fairly consistent between children and adults (likely due to the smaller amount of air and water consumed by children).

### 6.7 POPULATIONS WITH POTENTIALLY HIGH EXPOSURES

Populations with potentially high exposures include those occupationally exposed. Those employed at underground mines (uranium, hard rock, and vanadium), water treatment plants, radioactive contaminated sites, nuclear waste repositories, natural caverns, phosphate fertilizer plants, oil refineries, utility and subway tunnels, excavators, power plants, natural gas and oil piping facilities, health mines and spas, fish hatcheries, and hospitals have a higher risk of exposure (EPA 2003; Field 1999; Fisher et al. 1996). Higher exposure risks are also present for farmers, radon mitigation professionals, and scientists (Field 1999).

High radon exposure can occur in any location with geologic radon sources (Field 1999). High outdoor air radon concentrations were reported in Iowa, Main, and Minnesota NAS (1999b). NAS (1999b) also reported high radon concentrations in public water supplies for New England, the Appalachian states, and the Rocky Mountain states, as well as areas of the Southwest and Great Plains. Though the average radon concentration in groundwater-derived public water supplies is approximately 540 pCi/L (20 Bq/L), some public water supplies have been found to have radon concentrations up to  $1 \times 10^7$  Bq/m<sup>3</sup> (270,000 pCi/L) (NAS 1999b).

Communities that are very near uranium or phosphate mill tailing piles may have increased environmental radon levels. In addition, in some areas, mill tailings have been used for landfills and were subsequently developed (for example, Grand Junction, Colorado). Six counties around the Three Mile Island area of Pennsylvania were found to have high indoor air levels of radon (Field 2005). Persons in these communities could be exposed to levels of radon exceeding normal background levels.

### 6.8 ADEQUACY OF THE DATABASE

Section 104(i)(5) of CERCLA, as amended, directs the Administrator of ATSDR (in consultation with the Administrator of EPA and agencies and programs of the Public Health Service) to assess whether adequate information on the health effects of radon is available. Where adequate information is not available, ATSDR, in conjunction with NTP, is required to assure the initiation of a program of research designed to determine the health effects (and techniques for developing methods to determine such health effects) of radon.

## 6. POTENTIAL FOR HUMAN EXPOSURE

The following categories of possible data needs have been identified by a joint team of scientists from ATSDR, NTP, and EPA. They are defined as substance-specific informational needs that if met would reduce the uncertainties of human health assessment. This definition should not be interpreted to mean that all data needs discussed in this section must be filled. In the future, the identified data needs will be evaluated and prioritized, and a substance-specific research agenda will be proposed.

### 6.8.1 Identification of Data Needs

**Physical and Chemical Properties.** Information is available on the physical and chemical properties of radon, and parameters that influence the behavior of radon in the environment have been determined. Therefore, no data needs are identified concerning physical and chemical properties of radon.

**Production, Import/Export, Use, Release, and Disposal.** According to the Emergency Planning and Community Right-to-Know Act of 1986, 42 U.S.C. Section 11023, industries are required to submit substance release and off-site transfer information to the EPA. The TRI, which contains this information for 2006, became available in March of 2008. This database is updated yearly and should provide a list of industrial production facilities and emissions.

The production of radon occurs directly from a radium source either in the environment or in a laboratory environment. The disposal of gaseous radioactive effluents has been documented. Increased radon concentrations have been detected in waste generated by uranium and phosphate mining; therefore, these sites should be monitored on a continual basis. Although there are regulations for disposal of radionuclides in general, there are none that specifically address disposal of materials due to their radon content. If such regulations were promulgated, they would be developed by states since the Federal government has no authority in this area.

**Environmental Fate.** Information is available on the environmental fate of radon in air and water and on the transport of radon in environmental media. Factors that affect the partitioning of radon from soil or water to air have been identified. Movement of radon into and within homes and the influence of meteorological conditions and other parameters on this movement should continue to be investigated. Transformation of radon has been adequately characterized. There is limited information on the uptake and release of radon by plants. Additional research of this phenomenon is needed in order to determine

## 6. POTENTIAL FOR HUMAN EXPOSURE

the relative contribution plants provide to atmospheric levels. Exposure from smoking tobacco should be explored.

**Bioavailability from Environmental Media.** Radon and radon progeny are known to be released from air and water and information is available, which characterizes the relative contribution of various media to levels of radon in air and water.

**Food Chain Bioaccumulation.** Information on bioaccumulation of radon and radon daughters in the food chain is not available. Therefore, the potential for bioconcentration in plants, aquatic organisms or animals, or for biomagnification in the food chain is unknown. However, since radon is a noble gas, it will not bioaccumulate. Studies of the bioaccumulation of radon in the food chain are not relevant.

**Exposure from Environmental Media.** Reliable monitoring data for the levels of radon in contaminated media at hazardous waste sites might be helpful, particularly if uranium mine tailings have been disposed of at these sites.

Information is available regarding the levels of radon in indoor air, outdoor air, and water. Continued comprehensive data on levels of radon in ambient air are needed in order to assess potential human exposure. The measured indoor and ambient radon levels are not mandated except by a limited number of communities. EPA has found that most homeowners do not choose to spend the money to have these measurements made.

**Exposure of the General Population.** There is a lack of comprehensive information associating radon and radon progeny levels in the environment and effects of exposure of the general population. Although levels of radon may be measured in exhaled air, this information is of no value unless used to estimate the body burden of ingested radium (as would have been historically relevant for radium dial painters). Concentrations of radon progeny are measurable in urine, blood, bone, teeth, and hair; however, these levels are not direct measurements of levels of exposure. These estimates may be derived through use of mathematical models.

This information is necessary for assessing the need to conduct health studies on these populations.

**Exposures of Children.** Limited information is available to address radon exposure of children, particularly within the United States. Available data were not always in agreement, and thus, conclusions

## 6. POTENTIAL FOR HUMAN EXPOSURE

were difficult to assess. Studies are needed to better characterize exposure levels specific to children in the United States.

Child health data needs relating to susceptibility are discussed in Section 3.12.2, Identification of Data Needs: Children's Susceptibility.

**Exposure Registries.** No exposure registries for radon were located. This substance is not currently one of the compounds for which a sub-registry has been established in the National Exposure Registry. The substance will be considered in the future when chemical selection is made for sub-registries to be established. The information that is amassed in the National Exposure Registry facilitates the epidemiological research needed to assess adverse health outcomes that may be related to exposure to this substance.

The Hanford Environmental Foundation in Richland, Washington, maintains a registry of United States uranium miners and millers. The data in the registry are derived from autopsy material and include exposure information. Since uranium decays to radon, this exposure registry on miners and millers may provide information on radon exposure. The NIOSH dose reconstruction and worker compensation programs should also be addressed.

### 6.8.2 Ongoing Studies

The Federal Research in Progress (FEDRIP 2008) database provides additional information obtainable from a few ongoing studies that may fill in some of the data needs identified in Section 6.8.1. Affiliated with Duke University in Durham, North Carolina and sponsored by ACRIG, Vengosh and colleagues are involved in "An integrative investigation of the sources and effects of groundwater contamination for local communities and homeowners in North Carolina".

6. POTENTIAL FOR HUMAN EXPOSURE

This page is intentionally blank.



## 7. ANALYTICAL METHODS

The purpose of this chapter is to describe the analytical methods that are available for detecting, measuring, and/or monitoring radon and its progeny. The intent is not to provide an exhaustive list of analytical methods. Rather, the intention is to identify well-established methods that are used as the standard methods of analysis. Many of the analytical methods used for environmental samples are the methods approved by federal agencies and organizations such as EPA and the National Institute for Occupational Safety and Health (NIOSH). Other methods presented in this chapter are those that are approved by groups such as the Association of Official Analytical Chemists (AOAC) and the American Public Health Association (APHA). Additionally, analytical methods are included that modify previously used methods to obtain lower detection limits and/or to improve accuracy and precision.

### 7.1 BIOLOGICAL MATERIALS

Table 7-1 lists various methods used to detect radon progeny in biological samples. Since the half-life of radon is short, its measurement in biological samples, such as serum, urine, blood, etc., is not practical. Measurements of the longer lived radon progeny  $^{210}\text{Pb}$  and  $^{210}\text{Po}$  in biological samples may be used as an indication of radon exposure; however, ingestion of these isotopes from food and drinking water or direct exposure from other environmental media are considered the primary sources of exposure for these isotopes. Therefore, while this chapter discusses the analysis of  $^{210}\text{Pb}$  and  $^{210}\text{Po}$  in biological media, their presence in the body arises from a variety of sources, not just direct inhalation of radon, and should not be considered unique biomarkers of radon exposure.

A method of estimating individual, chronic human exposure to natural waterborne radionuclides using *in vivo* skull measurements and *in vitro* urine measurements of  $^{210}\text{Pb}$  and natural uranium ( $^{234,235,238}\text{U}$ ) is described by Muikku et al. (2003). Four, high-purity broad energy Ge detectors, situated near the top and back of the head, measure the activity of the 186 keV  $^{235}\text{U}$  and 46 keV  $^{210}\text{Pb}$  gamma rays. Urine samples were analyzed with inductively coupled plasma mass spectrometry (ICP-MS) for uranium content (Muikku et al. 2003). *In vivo* measurements of  $^{210}\text{Pb}$  in the knee have also been reported (by measuring the 46 keV gamma ray); however, calibration for the skull is generally simpler than for the knee (Johnston et al. 2005).

Urine analysis and whole body counting have been used to measure levels of radon progeny in humans. It is generally known that  $^{210}\text{Pb}$  is deposited primarily in bone with a relatively long biological half-life,

## 7. ANALYTICAL METHODS

**Table 7-1. Analytical Methods for Determining Radon Progeny in Biological Samples**

Sample matrix	Preparation method	Analytical method	Sample detection limit	Reference
Tooth	Clean and dry tooth; dry overnight and grind to fine powder; separate enamel from dentin and compress into pellets; coat with titanium nitride	PIXE for total lead content in teeth	0.5 ppm	Anttila 1987
Urine, blood, hair, feces	Wet ash in HNO <sub>3</sub> -NClO <sub>4</sub> , electrostatic precipitation	Alpha spectrometry	0.1 pCi (3.7x10 <sup>-3</sup> Bq)	Gotchy and Schiager 1969
Urine, blood, hair	Wet ashing with concentrated nitric acid and hydrogen peroxide, followed by drying and dissolution in hydrochloric acid solution	Alpha particle counting of <sup>209</sup> Po (4.866 MeV) and <sup>210</sup> Po (5.305 MeV) using silicon surface barrier detectors	1.1–1.5 mBq/L (24-hour counting time)	Al-Arifi et al. (2006)
Blood	Wet ash and plate on disk	Autoradio-graphy of tracks, using nuclear emulsion	No data	Weissbuch et al. 1980
Bone	Wash with acetone, hydrogen peroxide and isopropanol followed by drying and homogenization to a grain size of 1–3 mm	Gamma ray spectrometry (46.5 keV <sup>210</sup> Pb) using multidispersive HPGe detector	0.4–0.7 mBq per gram of sample	Johnston et al. 2005
Bone	Extract fat with anhydrous benzene; wet ash using nitric acid and perchloric acid	Alpha particle counting <sup>210</sup> Po using a ZnS(Ag) scintillation counter	No data	Blanchard et al. 1969
Bone	<i>In vivo</i>	Whole body gamma ray spectroscopy (46 keV <sup>210</sup> Pb)	No data	Eisenbud et al. 1969
Tissue	Immediate measurement of dissected tissue samples following inhalation exposure	Gamma ray activity using a sodium iodide scintillation counter	No data	Nussbaum and Hursh 1957
Tissue (Brain)	Homogenize tissue in trichloroacetic acid solution followed by centrifugation	Alpha particle counting of <sup>210</sup> Po and beta counting of <sup>210</sup> Bi	1x10 <sup>-5</sup> Bq per gram tissue	Momčilović et al. 1999

HPGe = High purity germanium; PIXE = proton induced X-ray emission analysis

## 7. ANALYTICAL METHODS

which enables it to reach transient radioactive equilibrium conditions with its descendant,  $^{210}\text{Po}$  (Clemente et al. 1984). The short half-lives of radon and the daughters,  $^{218}\text{Po}$  through  $^{214}\text{Po}$ , preclude their detection through normal bioassay techniques that typically require a day or more after the sample has been collected before counting can commence (Gotchy and Schiager 1969).

Al-Arifi et al. (2006) discussed an analytical method for measuring levels of  $^{210}\text{Po}$  in samples of blood, urine, and hair for various populations using a high resolution alpha spectrometer. Although the main route of  $^{210}\text{Po}$  intake by the human body is the ingestion of food, smoking, ingestion of drinking water, and inhalation of radon may also contribute to the body burden.

Radon exposure in humans is typically assessed by monitoring air levels indoors, outdoors, and under occupational settings as discussed in Section 7.2.

### 7.2 ENVIRONMENTAL SAMPLES

Most methods of measuring radon and its decay products in environmental samples are based on the detection of alpha particles emitted during the radioactive decay process, although some methods are based on the detection of emitted gamma rays. Detailed reviews of the measurement of radon and its progeny in environmental samples can be found in NCRP (1988), George (1988), and European Commission (1995). In addition, EPA has issued two reports recommending measurement techniques and strategies. The initial 1986 report, "Interim Radon and Radon Decay Product Measurement Protocols," provides procedures for measuring  $^{222}\text{Rn}$  concentrations with continuous monitors, charcoal canisters, alpha-track detectors, and grab techniques (EPA 1986b). The second report, "Interim Protocols for Screening and Follow-up Radon and Radon Decay Product Measurements" (EPA 1987a), outlines the recommendations for making reliable, cost-effective radon measurements in homes (Ronca-Battista et al. 1988). These recommendations were updated in 1992 and provide general guidelines for optimal measurement conditions, device placement, and documentation of results (EPA 1992).

There are several generalizations about the measurement of radon that apply regardless of the specific measurement technique used. Radon concentrations in the same location may differ by a factor of 2 over a period of 1 hour. Also, the concentration in one room of a building may be significantly different than the concentration in an adjoining room. Therefore, the absolute accuracy of a single measurement is not critical, but improvements in sampling methodology would be helpful.

## 7. ANALYTICAL METHODS

Activated charcoal adsorption devices are inexpensive, passive detectors used for monitoring radon in air samples. Commercially available devices are often sold at hardware or home improvement stores for estimating radon levels in households or buildings. A typical detector consists of a circular, 6–10 cm diameter container that is approximately 2.5 cm deep and filled with 25–100 g of activated charcoal (EPA 1992). One side of the container is fitted with a screen that encloses the charcoal sample and allows air to diffuse in. The passive nature of these detectors allows for the continuous adsorption and desorption of radon, and the adsorbed radon undergoes radioactive decay during the measurement period. Following a brief exposure period (2–7 days), the charcoal detectors are returned to a laboratory and analyzed directly by counting gamma rays emitted by the radon decay products on the charcoal using a sodium iodide gamma detector. The detector may be used in conjunction with a multi-channel gamma spectrometer or with a single-channel analyzer with the window set to include the appropriate gamma energy window. The detector system and detector geometry must be the same used to derive the calibration factors for the device (EPA 1992). Alternatively, the sample may be desorbed by an aromatic solvent (typically toluene or benzene) and analyzed using liquid scintillation counting using an appropriate fluor solution.

Prichard and Marlen (1983) described a method in which atmospheric levels of radon were analyzed by collecting samples on activated charcoal followed by direct analysis of the gamma ray emissions (0.295 and 0.352 MeV) of  $^{214}\text{Pb}$  using a Ge(Li) detector. Background levels of gamma rays can interfere with these measurements; therefore, to improve sensitivity, radon was desorbed from the charcoal filters using toluene and analyzed using a commercial scintillation counter following the addition of 1–2 mL of concentrated fluor solution.

Flow through alpha scintillation cells (Lucas type cells) are frequently used to measure radon concentrations in air for field measurements and in occupational settings (NCRP 1988). The cell consists of a silver activated zinc sulfide (ZnS) phosphor screen that emits photons of visible light when impacted by alpha particles. Air is drawn continuously through the cell by an air pump and the cell is coupled to a photomultiplier tube for continuous analysis. The scintillations or flashes of light caused by the alpha particles from radon, and its decay progeny, which strike the ZnS screen, are recorded by the photomultiplier tube. Using appropriate calibration and decay scheme factors, the radon gas concentration may be determined from the rate at which the pulses are recorded (European Commission 1995).

Indoor radon levels are also frequently measured using alpha track detection devices (EPA 1992). The detector consists of a small piece of plastic or film enclosed in a container with a filter-covered opening or

## 7. ANALYTICAL METHODS

similar design. Some common materials used in this capacity for radon detection are the cellulose nitrate film (LR-115), the thermoset polymer plastic (CR-39), and the polycarbonate plastic (Makrofol) (European Commission 1995). Radon gas diffuses into the container and alpha particles emitted by the radon and its progeny strike the detector and produce submicroscopic damage tracks to the enclosed plastic material. Following the analysis period, the plastic detectors are placed in a caustic solution that accentuates the damage tracks so they can be counted using a microscope or an automated counting system. The number of tracks per unit area is correlated to the radon concentration in air, using a conversion factor derived from data generated at a laboratory. The number of tracks per unit of analyzed detector area produced per unit of time (minus the background) is proportional to the radon concentration. When compared to charcoal adsorption detectors, alpha track detectors have the advantage that they can be used for measurements over long time frames (about 1 month to a year) and thus, they measure true time-integrated average concentrations (EPA 1992).

Personal and occupational exposure to radon is frequently assessed using personal dosimeters. An early personal radon dosimeter used in occupational settings by miners, called a radon film badge, was described by Geiger (1967). It consisted of a plastic holder, which encompassed a nuclear track film to detect emitted alpha particles. Radon gas diffused through the central opening of the badge and into the film emulsion. The number of alpha particles was determined by counting the tracks in the processed film emulsion. Another example of a passive radon dosimeter based on alpha particle etched track detection used to assess personal exposure is described by Taheri et al. (2006). This particular dosimeter employs a polycarbonate detector and a porous fiberglass filter to collect the radon progeny,  $^{218}\text{Po}$  and  $^{214}\text{Po}$ . A thin aluminum foil is placed between the filter and the detector in order to attenuate the energy of the emitted alpha particles.

A method was developed to retrospectively or prospectively determine radon concentrations in air using glass surfaces inside a building. By determining the historical average concentration, the methodology provides an estimate of the indoor radon level to which a person was exposed over a period of time. The surface activity is measured for a glass object that was present in the location of interest during the exposure assessment period. The average radon concentration over several decades is related to the surface activity of the glass. This results from the radon progeny  $^{210}\text{Pb}$ , which has a long half-life (22.26 years) and is found implanted within the glass (or other hard surface) due to the kinetic energy transferred by alpha decay to the radon progeny atoms plating out on the surface. This method is thought to provide a more accurate representation of radon exposure than surface monitors. It also allows for continuous monitoring of a subject's radon exposure, and can continue to be used to track radon when

## 7. ANALYTICAL METHODS

moving to a new residence (Lagarde et al. 2002; Mahaffey et al. 1993; Samuelsson 1988; Steck and Field 1999). A field calibration study conducted from 2005 to 2007 in 38 homes in Iowa using glass-based retrospective radon detectors was researched by Sun (2008). Radon progeny deposited on the surface of these detectors was shown to be effective for predicting the airborne dose rate for individuals.

Pressyanov et al. (2003) explored the use of compact disks as retrospective radon detectors. After exposure, a surface layer is removed and electrochemically etched marks are counted. The study results indicated that compact disks may be useful for retrospectively obtaining radon measurements for levels above  $3 \text{ Bq/m}^3$  (0.08 pCi/L).

Radon volume trap detectors also provide a convenient method to estimate average radon concentrations in dwellings over several years in time (Oberstedt and Vanmarcke 1996). Sponge-like materials, such as mattresses and cushions, build-up  $^{210}\text{Pb}$ , which reaches an equilibrium with the alpha emitter  $^{210}\text{Po}$ , which is used to estimate the average radon concentration over the exposure period. In the initial laboratory tests of this method, polyester foam samples simulating mattress material of differing densities and rigidity were exposed to a radon source (Oberstedt and Vanmarcke 1996). Following the initial exposure period, the materials were stored in a radon-free environment for at least one half-life of  $^{210}\text{Po}$  (138 days). The  $^{210}\text{Po}$  was separated from the polyester materials in a series of extraction steps and the activity was analyzed by alpha spectrometry. The results indicated that home dwelling materials, such as cushions and mattress material, could be used as an accurate and sensitive retrospective radon monitor. Wooden furniture material has also been tested as a volume trap; however, the natural varying background concentrations of  $^{210}\text{Po}$  in different wood types make these materials a less attractive retrospective detection system.

A standard test method for the detection of radon in drinking water has been developed by the American Society for Testing and Materials (ASTM) based on scintillation counting of radon and its progeny (ASTM 1999). A sample of unaerated water is injected into a vial containing toluene or a scintillation cocktail mix and analyzed using a commercially available liquid scintillation spectrometer. This method has a reported detection limit of 0.04 Bq/L (1.1 pCi/L).

A method for measuring radon in soil gas that utilizes liquid scintillation counting for determining concentration is given by Wadach and Hess (1985). A description of this method may be found in Table 7-2. A detection system for continuous soil radon concentration measurements was developed

## 7. ANALYTICAL METHODS

using a continuous monitor RM-3. The system detects radon based on an airflow ionization chamber. Details are available in Fronka et al. (2008).

The accuracy of any measurement will depend upon the calibration of the instrument used. The calibration of an instrument determines its response to a known amount or concentration of radioactivity. This allows a correlation to be made between the instrument reading and the actual amount or concentration present. A range of activities of  $^{226}\text{Ra}$  standard reference materials (SRM) is available from the National Institute of Standards and Technology (NIST) as solutions for calibrating detection systems. Also, an elevated radon atmosphere may be produced in a chamber, and samples drawn and measured in systems previously calibrated by radon emanation from  $^{226}\text{Ra}$  SRM. Other radon detectors may then be filled from or exposed in the chamber and standardized based on this "secondary" standard (NCRP 1988). Ionization pulse chambers are often used for instrumental calibration and measurement systems in interlaboratory comparisons (NCRP 1988). Analytical methods for measuring radon in environmental samples are given in Table 7-2. To quantify the sensitivity of a particular analytical method, the lower limits of detection (LLD) are given when possible. The LLD is typically defined as the minimum activity that would result in a quantifiable signal on some analytical instrument that would yield a net count for which there is confidence at a predetermined level (usually the 95<sup>th</sup> percentile confidence limit) that activity is present (Harley and Pasternack 1982; NCRP 1988). In order to calculate the LLD, the measurement system characteristics, detection system efficiency, background count rate, sampling volume, and sampling period must be known.

### 7.3 ADEQUACY OF THE DATABASE

Section 104(i)(5) of CERCLA, as amended, directs the Administrator of ATSDR (in consultation with the Administrator of EPA and agencies and programs of the Public Health Service) to assess whether adequate information on the health effects of radon is available. Where adequate information is not available, ATSDR, in conjunction with NTP, is required to assure the initiation of a program of research designed to determine the health effects (and techniques for developing methods to determine such health effects) of radon.

## 7. ANALYTICAL METHODS

**Table 7-2. Analytical Methods for Determining Radon and Progeny in Environmental Samples**

Sample matrix	Preparation method	Analytical method	Sample detection limit	Percent recovery	Reference
Radon					
Air	Adsorb onto activated charcoal; 2–7 days	Gamma spectroscopy	No data	No data	Cohen and Nason 1986
Air	Adsorb onto activated charcoal followed by direct analysis; extract with toluene add 1–2 mL fluor	Gamma counting of 0.295 and 0.352 $\gamma$ MeV lines of $^{214}\text{Pb}$ ; liquid scintillation analysis of desorbed sample	No data	0.94 of true concentration	Prichard and Marlen 1983
Air	Scintillation cell method; allow air to enter detection chamber through millipore filter until equilibrated, or collect sample in bag (Mylar or Tedlar); transfer to chamber as soon as possible	ZnS(Ag) scintillation/photomultiplier tube	No data	No data	Crawford-Brown and Michel 1987
Air	Two-filter method: draw air into fixed length tube with entry and exit filters; monitor exit filter activity	ZnS(Ag) scintillation/photomultiplier tube	No data	90	Schery et al. 1980
Air	Diffuse through a filter into a cup containing alpha track material (cellulose nitrate film) for up to 1 year ; etch in acidic or basic solution operated upon an alternating electric field	Solid state nuclear track detector Microscopic examination of damaged material	14 pCi/m <sup>3</sup> (0.519 Bq/m <sup>3</sup> )	No data	NCRP 1988
Air	Adsorb onto compact disks; remove surface layer at 25 °C with aqueous 45% KOH and 40% methanol; apply electrochemical etching	Marks counted using video camera	No data	No data	Pressyanov et al. 2003
Air	Dissolve material in nitric acid followed by additional digestion in hydrochloric acid. Auto deposit polonium on a silver plate during drying with an infrared source	Volume trap detector using alpha spectrometer	54 pCi/L		Oberstedt and Vanmarcke 1996



## 7. ANALYTICAL METHODS

**Table 7-2. Analytical Methods for Determining Radon and Progeny in Environmental Samples**

Sample matrix	Preparation method	Analytical method	Sample detection limit	Percent recovery	Reference
Soil	Dry in 55 °C oven for 24 hours; place 5 g in 20 mL borosilicate glass scintillation; cover with 10 mL distilled water; allow soil to become wet; add 5 mL high-efficiency mineral oil; allow to age 30 days	Scintillation counter	No data	No data	Rangarajan and Eapen 1987; Wadach and Hess 1985
Soil	None	Track etch detector buried 30 cm deep	No data	No data	Rangarajan and Eapen 1987
Drinking Water	Draw an aliquot of unaerated water into a syringe and inject in a scintillation vial containing the liquid scintillation cocktail solution	ASTM Method D5072 (Scintillation counter)	0.04 Bq/L (1.1 pCi/L)	94-96%	ASTM 1999
Water	Pass carrier gas through samples in a bubbler flask to purge out dissolved radon; transfer radon to evacuated scintillation cell	Scintillation counter	1.4 pCi/L (52 Bq/m <sup>3</sup> )	90	Crawford-Brown and Michel 1987
Water	Inject into glass vial containing liquid scintillation solution; shake vigorously	Liquid scintillation counter	10 pCi/L (370 Bq/m <sup>3</sup> )	No data	Crawford-Brown and Michel 1987
Water	Direct measurement	Gamma ray spectroscopy	10 pCi/L for 1-L sample (370 Bq/m <sup>3</sup> )	No data	Yang 1987

TLD = thermoluminescent dosimeter

## 7. ANALYTICAL METHODS

The following categories of possible data needs have been identified by a joint team of scientists from ATSDR, NTP, and EPA. They are defined as substance-specific informational needs that if met would reduce the uncertainties of human health assessment. This definition should not be interpreted to mean that all data needs discussed in this section must be filled. In the future, the identified data needs will be evaluated and prioritized, and a substance-specific research agenda will be proposed.

### 7.3.1 Identification of Data Needs

#### **Methods for Determining Biomarkers of Exposure and Effect.**

*Exposure.* Methods are available to measure the presence of radon progeny in urine, blood, bone, teeth, and hair. However, these radon progeny detected in biological systems arise from ingestion of these progeny from food and drinking water as well as from the inhalation of radon. Therefore, these methods cannot be considered as specific biomarkers for radon inhalation.

*Effect.* The frequency of abnormalities in sputum cytology has been utilized as a possible early indicator of radiation damage to lung tissue (Band et al. 1980; Brandom et al. 1978; Saccomanno et al. 1974). The accuracy and precision of this measurement is not known.

#### **Methods for Determining Parent Compounds and Degradation Products in Environmental**

**Media.** Analytical methods are available that allow for the quantification of radon in air, water, and soil. However, methods for the measurement of radon concentrations in soil-gas are limited. The ability to accurately measure soil-gas is needed to provide a better understanding of the emanation rate of radon gas from soil.

### 7.3.2 Ongoing Studies

Researchers at the University of Iowa are involved in ongoing studies that include pooling results from Iowa and Missouri residential radon studies using glass-based detectors that are undergoing final calibration (field, personal communication) and pooling results from the residential radon studies that contributed to the results of Krewski et al. (2005, 2006; North American studies) and Darby et al. (2005, 2006; European studies).

## 8. REGULATIONS, ADVISORIES, AND GUIDELINES

Recommendations for radiation protection for people in the general population as a result of exposure to radon in the environment are found in the International Commission on Radiological Protection (ICRP) Publication 65 (ICRP 1994a). National guidelines for occupational radiation protection are found in the "Federal Radiation Protection Guidance for Occupational Exposure" (EPA 1987b). The guidance presents general principles for the radiation protection of workers and specifies the numerical primary guides for limiting occupational exposure. These recommendations are consistent with the ICRP (ICRP 1994a).

The basic philosophy of radiation protection is the concept of ALARA (As Low As Reasonably Achievable). As a rule, all exposure should be kept as low as reasonably achievable and the regulations and guidelines are meant to give an upper limit to exposure. Based on the primary guides, guides for Annual Limits on Intake (ALIs) have been calculated (USNRC 2008b). The ALI is defined as "that activity of a radionuclide which, if inhaled or ingested by Reference Man (ICRP 1975), will result in a dose equal to the most limiting primary guide for committed dose" (EPA 1988).

MRLs are substance specific estimates, which are intended to serve as screening levels, are used by ATSDR health assessors and other responders to identify contaminants and potential health effects that may be of concern at hazardous waste sites.

No inhalation or oral MRLs were derived for radon.

The international and national regulations, advisories, and guidelines regarding radon in air, water, and other media are summarized in Table 8-1.

The EPA IRIS database (IRIS 2008) has withdrawn its cancer classification for radionuclides, but the EPA Office of Air and Radiation believes that all radionuclides, including radon and its radioactive progeny, should be considered to be known carcinogens, and has assigned them to Group A. The EPA has not derived reference concentrations (RfCs) or reference doses (RfDs) for radon (IRIS 2008), but has proposed a maximum contaminant level (MCL) of 300 pCi/L and an alternative maximum contaminant level (AMCL) of 4,000 pCi/L for radon and a  $10^{-4}$  cancer risk at 150 pCi/L (EPA 2006a).

## 8. REGULATIONS, ADVISORIES, AND GUIDELINES

The EPA website contains a publication called A Citizen's Guide to Radon (EPA 2007k) that includes information regarding radon hazards, methods for testing radon levels in the home, ways to lower radon levels, and a recommendation to use a certified radon mitigation specialist to ensure that appropriate methods are used to reduce radon levels. EPA recommends fixing your home if measured indoor levels of radon are  $\geq 4$  pCi/L and notes that radon levels  $< 4$  pCi/L still pose a health risk and can be reduced in many cases.

## 8. REGULATIONS, ADVISORIES, AND GUIDELINES

**Table 8-1. Regulations, Advisories, and Guidelines Applicable to Radon**

Agency	Description	Information	Reference
<u>INTERNATIONAL</u>			
Guidelines:			
IARC	Carcinogenicity classification <sup>222</sup> Rn and its decay products	Group 1 <sup>a</sup>	IARC 2008
ICRP	Summary of values recommended		ICRP 1994a
	Nominal fatality and detriment coefficient at home and at work	$8 \times 10^{-5} \text{ (mJ h m}^{-3}\text{)}^{-1}$	
	Dose conversion convention, effective dose per unit of exposure		
	At home	1.1 mSv (mJ h m <sup>-3</sup> )	
	At work	1.4 mSv (mJ h m <sup>-3</sup> )	
	Action level (dwellings)		
	Radon concentration	200–600 (Bq m <sup>-3</sup> ) <sup>b</sup>	
	Annual effective dose	3–10 mSv	
	Action level (workplace)		
	Radon concentration	500–1,500 (Bq m <sup>-3</sup> ) <sup>b</sup>	
Annual effective dose	3–10 mSv		
Occupational annual limit on exposure			
	Per year, averaged over 5 years	14 (mJ h m <sup>-3</sup> )	
	In a single year	35 (mJ h m <sup>-3</sup> )	
WHO	Air quality guidelines		WHO 2000
	Risk estimates and recommended action level for radon progeny for exposure to 1 Bq/m <sup>3</sup>		
	Lung cancer excess lifetime risk estimate	$3\text{--}6 \times 10^{-5}$	
	Recommended level for remedial action in buildings	$\geq 100 \text{ Bq/m}^3$ (annual average)	
WHO	Drinking water quality guidelines		WHO 2004
	Radon	100 Bq/L	
<u>NATIONAL</u>			
Regulations and Guidelines:			
a. Air			
ACGIH	Guidelines for exposure to ionizing radiation		ACGIH 2007
	Radon daughters	4 WLM/year	

## 8. REGULATIONS, ADVISORIES, AND GUIDELINES

**Table 8-1. Regulations, Advisories, and Guidelines Applicable to Radon**

Agency	Description	Information	Reference
<b>NATIONAL (cont.)</b>			
EPA	AEGL-1, -2, and -3	No data	EPA 2007a
	Hazardous air pollutant		EPA 2007b
	Radon	Yes	42 USC 7412
	Radiation dose to public from $^{222}\text{Rn}$ not to exceed 10 mrem/year	From operating uranium mine	EPA 2007c (40CFR61.22)
		From a DOE facility	EPA 2007d (40CFR61.92)
	$^{222}\text{Rn}$ emissions rate from soil not to exceed 20 pCi/m <sup>2</sup> -second	From a DOE facility	EPA 2007e (40CFR61.192)
		From an active phosphogypsum stack	EPA 2007f (40CFR61.202)
		From a non-operational uranium mill tailings pile	EPA 2007g (40CFR61.222)
		From an existing uranium mill tailings pile	EPA 2007h (40CFR61.252)
	$^{220}\text{Rn}$ emissions rate from soil	Provisions from soil for $^{222}\text{Rn}$ from uranium mill tailings are applicable to $^{220}\text{Rn}$ from thorium mill tailings	EPA 2007j (40CFR192.41)
MSHA	$^{210}\text{Po}$ ( $^{222}\text{Rn}$ progeny)	2 Ci/year elemental phosphorus plant emissions	EPA 2007i (40CFR61.122)
	Monitoring of radon in homes		EPA 2007k
	No action necessary	<4 pCi/L, 0.02 WL	
	Take necessary action to decrease indoor radon levels	≥4 pCi/L	
NIOSH	Annual exposure limits		MSHA 2007
	Radon daughters	4 WLM in any calendar year	30 CFR 57.5037
OSHA	Maximum permissible concentration		
	Radon daughters	1 WL in active workings	
OSHA	REL (10-hour TWA)	No data	
	Exposure limits of individuals to ionizing radiation in restricted areas (rem per calendar quarter)		OSHA 2007 29 CFR 1910.1096
	Whole body: head and trunk; active blood-forming organs; lens of eyes; or gonads	1.25 rem	
	Hands and forearms; feet and ankles	18.75 rem	
	Skin of whole body	7.5 rem	

## 8. REGULATIONS, ADVISORIES, AND GUIDELINES

**Table 8-1. Regulations, Advisories, and Guidelines Applicable to Radon**

Agency	Description	Information	Reference
<b>NATIONAL (cont.)</b>			
USNRC	ALI for occupational exposure (values for oral ingestion)		USNRC 2008b 10 CFR 20, Appendix B
	<sup>220</sup> Rn (with daughters removed)	Not listed	
	<sup>220</sup> Rn (with daughters present)	Not listed	
	<sup>222</sup> Rn (with daughters removed)	Not listed	
	<sup>222</sup> Rn (with daughters present)	Not listed	
	ALI for occupational exposure (values for inhalation)		
	<sup>220</sup> Rn (with daughters removed)	20,000 µCi	
	<sup>220</sup> Rn (with daughters present)	20 µCi (or 12 WLM)	
	<sup>222</sup> Rn (with daughters removed)	10,000 µCi	
	<sup>222</sup> Rn (with daughters present)	100 µCi (or 4 WLM)	
	Derived air concentrations for occupational exposure (values for inhalation)		
	<sup>220</sup> Rn (with daughters removed)	7x10 <sup>-6</sup> µCi/mL	
	<sup>220</sup> Rn (with daughters present)	9x10 <sup>-9</sup> µCi/mL (or 1.0 WL)	
	<sup>222</sup> Rn (with daughters removed)	4x10 <sup>-6</sup> µCi/mL	
	<sup>222</sup> Rn (with daughters present)	3x10 <sup>-8</sup> µCi/mL (or 0.33 WL)	
	Annual average effluent air concentration (no values provided for effluent water)		
<sup>220</sup> Rn (with daughters removed)	2x10 <sup>-8</sup> µCi/mL		
<sup>220</sup> Rn (with daughters present)	3x10 <sup>-11</sup> µCi/mL		
<sup>222</sup> Rn (with daughters removed)	1x10 <sup>-8</sup> µCi/mL		
<sup>222</sup> Rn (with daughters present)	1x10 <sup>-10</sup> µCi/mL		
b. Water			
EPA	Drinking water standards and health advisories for gross alpha particle activity		EPA 2006a
	Radon		
	Proposed MCL	300 pCi/L	
	Proposed AMCL	4,000 pCi/L	
	10 <sup>-4</sup> lifetime cancer risk	150 pCi/L	

## 8. REGULATIONS, ADVISORIES, AND GUIDELINES

**Table 8-1. Regulations, Advisories, and Guidelines Applicable to Radon**

Agency	Description	Information	Reference
<b>NATIONAL (cont.)</b>			
EPA	Cancer classification		
	Radon	Group A <sup>c</sup>	
	National recommended water quality criteria	No data	EPA 2006b
c. Food		No data	
d. Other			
ACGIH	Carcinogenicity classification	No data	ACGIH 2007
EPA	Carcinogenicity classification		IRIS 2008
	<sup>222</sup> Rn	Withdrawn	
	RfC		
	<sup>222</sup> Rn	No data	
	RfD		
	<sup>222</sup> Rn	No data	
	Superfund, emergency planning, and community right-to-know		EPA 2008a 40 CFR 302.4
	Designated CERCLA hazardous substance		
	<sup>220</sup> Rn <sup>d</sup>	0.1 Ci	
	<sup>222</sup> Rn <sup>d</sup>	0.1 Ci	
NTP	Carcinogenicity classification		NTP 2005a
	Ionizing radiation (includes <sup>220</sup> Rn and <sup>222</sup> Rn)	Known to be a human carcinogen	

<sup>a</sup>Group 1: carcinogenic to humans

<sup>b</sup>Assuming 7,000 hours/year indoors or 2,000 hours/year at work and an equilibrium factor of 0.4.

<sup>c</sup>Group A: known human carcinogen

<sup>d</sup>Designated CERCLA hazardous substance pursuant to Section 112 of the Clean Air Act.

ACGIH = American Conference of Governmental Industrial Hygienists; AEGL = Acute Exposure Guideline Levels; ALI = annual limit on intake; AMCL = alternative maximum contaminant level; CERCLA = Comprehensive Environmental Response, Compensation, and Liability Act; CFR = Code of Federal Regulations; EPA = Environmental Protection Agency; IARC = International Agency for Research on Cancer; ICRP = International Commission on Radiological Protection; MCL = maximum contaminant level; MCLG = maximum contaminant level goal; MSHA = Mine Safety and Health Administration; NAS = National Academy of Sciences; NIOSH = National Institute for Occupational Safety and Health; NTP = National Toxicology Program; OSHA = Occupational Safety and Health Administration; REL = recommended exposure limit; RfC = inhalation reference concentration; RfD = oral reference dose; TWA = time-weighted average; USC = United States Code; USNRC = U.S. Nuclear Regulatory Commission; WHO = World Health Organization; WL = working level; WLM = working level months



## 9. REFERENCES

- \*ACGIH. 2007. Ionizing radiation. Threshold limit values for chemical substances and physical agents and biological exposure indices. Cincinnati, OH: American Conference of Governmental Industrial Hygienists, 172-173.
- \*Adinolfi M. 1985. The development of the human blood-CSF-brain barrier. *Dev Med Child Neurol* 27(4):532-537.
- \*Adlercreutz H. 1995. Phytoestrogens: Epidemiology and a possible role in cancer protection. *Environ Health Perspect Suppl* 103(7):103-112.
- +\*AEC. 1961. The effect of inhaled radon on the survival, body weight and hemogram of the mouse following single exposures. Rochester, NY: U.S. Atomic Energy Commission. University of Rochester. UR-593.
- +\*AEC. 1964. The effect of inhaled radon on the survival, body weight and hemogram of the mouse following multiple exposures. Rochester, NY: U.S. Atomic Energy Commission. University of Rochester. UR-624.
- +\*AEC. 1966. The effects on mice of continual exposure to radon and its decay products on dust. Rochester, NY: U.S. Atomic Energy Commission. University of Rochester. UR-669.
- \*Agency for Toxic Substances and Disease Registry. 1989. Decision guide for identifying substance-specific data needs related to toxicological profiles; Notice. Agency for Toxic Substances and Disease Registry, Division of Toxicology. *Fed Regist* 54(174):37618-37634.
- \*Agency for Toxic Substances and Disease Registry. 1990. Toxicological profile for radium. Atlanta, GA: U.S. Department of Health and Human Services. Public Health Service. Agency for Toxic Substances and Disease Registry.
- \*Agency for Toxic Substances and Disease Registry. 1999a. Toxicological profile for uranium. Agency for Toxic Substances and Disease Registry. <http://www.atsdr.cdc.gov/toxprofiles/tp150.pdf>. August 28, 2008.
- \*Agency for Toxic Substances and Disease Registry. 1999b. Toxicological profile for ionizing radiation. Agency for Toxic Substances and Disease Registry. <http://www.atsdr.cdc.gov/toxprofiles/tp149.pdf>. May 15, 2008.
- \*Agency for Toxic Substances and Disease Registry. 2006. Health consultation. An investigation of cancer incidence in Monticello, Utah. Atlanta, Georgia: U.S. Department of Health and Human Services, Agency for Toxic Substances and Disease Registry, Division of Health Assessment and Consultation. <http://www.atsdr.cdc.gov/HAC/pha/CancerIncidenceInMonticelloUT/CancerIncidence-MonticelloHC051706.pdf>. August 08, 2008.

---

\*Cited in text

+Cited in Supplemental Document

## 9. REFERENCES

- \*Agency for Toxic Substances and Disease Registry. 2007. Draft. Toxicological profile for plutonium. Agency for Toxic Substances and Disease Registry. <http://www.atsdr.cdc.gov/toxprofiles/tp143.pdf>. May 15, 2008.
- Ahlman K, Koskela RS, Kuikka P, et al. 1991. Mortality among sulfide ore miners. *Am J Ind Med* 19(5):603-617.
- Aieta E, Singley J, Trussell A, et al. 1987. Radionuclides in drinking water: An overview. *J Am Water Works Assoc* 79(4):144-152.
- Al-Affan IAM, Haque AKMM. 1989. Transformation of lung cells from inhalation of radon daughters in dwellings: A preliminary study. *Int J Radiat Biol* 56(4):413-422.
- \*Al-Arifi MN, Alkartyf KM, Al-Suwayeh SA, et al. 2006. Levels of  $^{210}\text{Po}$  in blood, urine and hair of some Saudi smokers. *J Radioanal Nucl Chem* 269(1):115-118.
- \*Alavanja MCR. 2002. Biologic damage resulting from exposure to tobacco smoke and from radon: Implication for preventive interactions. *Oncogene* 21:7365-7375.
- \*Alavanja MC, Brownson RC, Lubin JH, et al. 1994. Residential radon exposure and lung cancer among nonsmoking women. (Comment in: *J Natl Cancer Inst* 86(24):1813-1814). *J Natl Cancer Inst* 86(24):1829-1837.
- \*Alavanja MC, Lubin JH, Mahaffey JA, et al. 1999. Residential radon exposure and risk of lung cancer in Missouri. *Am J Public Health* 89(7):1042-1048.
- Alavanja MC, Lubin JH, Mahaffey JA, et al. 2000. Re: "Residential radon gas exposure and lung cancer: The Iowa Radon Lung Cancer Study". (Comment on: *Am J Epidemiol* 151(11):1091-1102). *Am J Epidemiol* 152(9):895-896.
- Albering HJ, Engelen JJ, Koulischer L, et al. 1994. Indoor radon, an extrapulmonary genetic risk? *Lancet* 344(8924):750-751.
- \*Albering HJ, Hageman GJ, Kleinjans JC, et al. 1992. Indoor radon exposure and cytogenetic damage. *Lancet* 340(8821):739.
- Alexander DD. 2007. An environmental cause of orofacial cleft defects or an unexplained cluster? (Comment on: *South Med J* 100(6):560-569). *South Med J* 100(6):553-554.
- \*Alter H, Oswald R. 1987. Nationwide distribution of indoor radon measurements: A preliminary database. *J Air Pollut Control Assoc* 37(3):227-231.
- \*Altman PL, Dittmer DS. 1974. Biological handbooks: Biology data book. Vol. III. 2nd ed. Bethesda, MD: Federation of American Societies for Experimental Biology, 1987-2008, 2041.
- Altshuler B, Pasternack B. 1963. Statistical measures of the lower limit of detection of a radioactivity counter. *Health Phys* 9:293-298.
- Altshuler B, Nelson N, Kushner M. 1964. Estimation of lung tissue dose from the inhalation of radon and daughters. *Health Phys* 10:1137-1161.

## 9. REFERENCES

Amandus H, Costello J. 1991. Silicosis and lung cancer in the U.S. metal miners. *Arch Environ Health* 46(2):82-89.

Amrani D, Cherouati DE. 1999. Health effects from radon-222 in drinking water in Algiers. *J Radiol Prot* 19(3):275-279.

\*Andersen ME, Krishnan K. 1994. Relating *in vitro* to *in vivo* exposures with physiologically based tissue dosimetry and tissue response models. In: Salem H, ed. *Animal test alternatives: Refinement, reduction, replacement*. New York, NY: Marcel Dekker, Inc., 9-25.

\*Andersen ME, Clewell HJ, Gargas ML, et al. 1987. Physiologically based pharmacokinetics and the risk assessment process for methylene chloride. *Toxicol Appl Pharmacol* 87(2):185-205.

Andersson I, Nilsson I. 1964. Exposure following ingestion of water containing radon-222. In: *Assessment of radioactivity in man. Proceedings of symposium on assessment of radioactive body burdens in man. Vol. II*. Vienna: International Atomic Energy Agency, International Labor Organization and World Health Organization, 317-326.

Andersson M, Wallin H, Jönsson M, et al. 1995. Lung carcinoma and malignant mesothelioma in patients exposed to Thorotrast: Incidence, histology and *p53* status. *Int J Cancer* 63(3):333-336.

Andrlíková J, Wagner V, Pálek V. 1975. Investigation of immunoglobulin levels in the blood serum of uranium miners after higher and lower exposure to ionizing radiation. *Strahlentherapie* 149(2):212-218.

\*Anttila A. 1987. Lead content of deciduous tooth enamel from a high-radon area. *Acta Odontol Scand* 45(4):283-288.

Archer VE. 1979. Effects of exposure to low levels of radon daughters. *Trans Am Nucl Soc* 33:145-146.

\*Archer VE. 1980. Epidemiologic studies of lung disease among miners exposed to increased levels of radon daughters. In: Rom W, Archer V, eds. *Health implications of new energy technologies*. Ann Arbor, MI: Ann Arbor Science, 13-22.

Archer VE. 1981. Health concerns in uranium mining and milling. *J Occup Med* 23(7):502-505.

\*Archer VE. 1985. Enhancement of lung cancer by cigarette smoking in uranium and other miners. *Carcinogenesis* 8:23-37.

Archer VE. 1988. Lung cancer risks of underground miners: Cohort and case-control studies. *Yale J Biol Med* 61(3):183-193.

Archer VE. 1995. Re: "Case-control study of residential radon and lung cancer in Winnipeg, Manitoba, Canada". (Comment on: *Am J Epidemiol* 140(4):310-322). *Am J Epidemiol* 142(8):884-886.

Archer VE. 1996. Radon, silicosis, and lung cancer. (Comment on: *Health Phys* 69(3):396-399). *Health Phys* 70(2):268-269.

Archer VE. 1997a. Residential radon and lung cancer in Sweden. (Comment on: *Health Phys* 72(2):169-276). *Health Phys* 73(2):394-395.

## 9. REFERENCES

- Archer VE. 1997b. Response to Cohen's plea for help. (Comment on: Health Phys 72(4):623-628). Health Phys 73(3):530-532.
- Archer VE. 1998. Errors in Cohen's home radon-lung cancer analyses. (Comment on: Health Phys 72(4):623-628). Health Phys 75(6):652-654.
- Archer VE, Brown M. 1970. American uranium miners and lung cancer. In: Shapiro H, ed. Pneumoconiosis. New York, NY: Oxford University Press, 569-571.
- \*Archer VE, Brinton HP, Wagoner JK. 1964. Pulmonary function of uranium miners. Health Phys 10:1183-1194.
- Archer VE, Gillam JD, James LA. 1978. Radiation, smoking and height relationships to lung cancer in uranium miners. In: Nieburgs H, ed. Prevention and detection of cancer. Part 1. Vol. 2. New York, NY: Marcel Dekker, Inc., 1689-1712.
- \*Archer VE, Gillam JD, Wagoner JK. 1976. Respiratory disease mortality among uranium miners. Ann NY Acad Sci 271:280-293.
- \*Archer VE, Radford EP, Axelson O. 1979. Radon daughter cancer in man: Factors in exposure-response relationships at low levels. In: Conference workshop on lung cancer epidemiology and industrial applications of sputum cytology. Golden, CO: Colorado School of Mines Press.
- \*Archer VE, Saccomanno G, Jones JH. 1974. Frequency of different histologic types of bronchogenic carcinoma as related to radiation exposure. Cancer 34(6):2056-2060.
- \*Archer VE, Wagoner JK, Lundin FE. 1973. Lung cancer among uranium miners in the United States. Health Phys 25(4):351-371.
- \*ASTM. 1999. Method D 5072-98. Standard test method for radon in drinking water. 1999 Annual book of ASTM methods. Vol. 11.02 Water (III). West Conshohocken, PA: American Society for Testing and Materials, 673-675.
- \*Auerbach O, Saccomanno G, Kuschner M, et al. 1978. Histologic findings in the tracheobronchial tree of uranium miners and non-miners with lung cancer. Cancer 42:483-489.
- Auvinen A. 1996. Lung cancer risk from indoor radon. Lancet 348(9042):1662-1663.
- \*Auvinen A, Mäkeläinen I, Hakama M, et al. 1996. Indoor radon exposure and risk of lung cancer: A nested case-control study in Finland. (Erratum in: J Natl Cancer Inst 90(5):401-402). (Comment in: J Natl Cancer Inst 89(8):584-585). J Natl Cancer Inst 88(14):966-972.
- Auvinen A, Mäkeläinen I, Hakama M, et al. 1998. Erratum. (Erratum to: J Natl Cancer Inst 88(14):966-972). J Natl Cancer Inst 90(5):401-402.
- \*Auvinen A, Salonen L, Pekkanen J, et al. 2005. Radon and other natural radionuclides in drinking water and risk of stomach cancer: A case-cohort study in Finland. Int J Cancer 114(1):109-113.
- Axelson O. 1980. Interaction between smoking and exposure to radon daughters. In: Rom W, Archer V, eds. Health implications of new energy technologies. Ann Arbor, MI: Ann Arbor Science, 23-28.

## 9. REFERENCES

- Axelsson O. 1990. Cancer risks from exposure to radon progeny in mines and dwellings. Recent results. *Cancer Res* 120:146-165.
- Axelsson O. 1991. Occupational and environmental exposures to radon: Cancer risks. *Ann Rev Public Health* 12:235-255.
- Axelsson O. 1995. Cancer risks from exposure to radon in homes. *Environ Health Perspect* 103(Suppl 2):37-43.
- Axelsson O, Edling C. 1980. Health hazards from radon daughters in dwellings in Sweden. In: Rom W, Archer V, eds. Health implications of new energy technologies. Ann Arbor, MI: Ann Arbor Science, 79-87.
- Axelsson O, Flodin U. 1989. Radon and leukaemia. (Comment on: *Lancet* 2(8654):99-100). *Lancet* 2(8664):673-674.
- Axelsson O, Rehn M. 1971. Lung cancer in miners. *Lancet* 2(7726):706-707.
- \*Axelsson O, Sundell L. 1978. Mining, lung cancer and smoking. *Scand J Work Environ Health* 4(1):46-52.
- Axelsson O, Andersson K, Desai G, et al. 1988. Indoor radon exposure and active and passive smoking in relation to the occurrence of lung cancer. *Scand J Work Environ Health* 14(5):286-292.
- Axelsson O, Edling C, Kling H. 1979. Lung cancer and residency -- a case- referent study on the possible impact of exposure to radon and its daughters in dwellings. *Scand J Work Environ Health* 5(1):10-15.
- Axelsson O, Edling C, Kling H, et al. 1981. Lung cancer and radon in dwellings. *Lancet* 2(8253):995-996.
- Axelsson O, Josefson H, Rehn M, et al. 1971. Svensk pilotstudie over lung cancer hos gruvarbetare. *Lakartidningen* 68:5687-5693.
- Ayotte P, Lévesque B, Gauvin D, et al. 1998. Indoor exposure to <sup>222</sup>Rn: A public health perspective. *Health Phys* 75(3):297-302.
- Baeza A, Miró C, Paniagua JM, et al. 1994. Natural and artificial radioactivity levels in Livingston Island (Antarctic regions). *Bull Environ Contam Toxicol* 52(1):117-124.
- \*Bahtijari M, Stegnar P, Shemsidini Z, et al. 2006. Indoor air radon concentration in schools in Prizren, Kosovo. *Radiat Prot Dosimetry* 121(4):469-473.
- \*Bair W. 1985. ICRP work in progress: Task group to review models of the respiratory tract. *Radiol Prot Bull* 63:5-6.
- Balásházy I, Hofmann W. 2000. Quantification of local deposition patterns of inhaled radon decay products in human bronchial airway bifurcations. *Health Phys* 78(2):147-158.
- Balásházy I, Hofmann W, Farkas Á, et al. 2002. Modelling carcinogenic effects of low doses of inhaled radon progenies. *J Radiol Prot* 22(3A):A89-A93.

## 9. REFERENCES

- Baldwin F, Hovey A, McEwen T, et al. 1991. Surface to nuclear distances in human bronchial epithelium: Relationships to penetration by Rn daughters. *Health Phys* 60(2):155-162.
- Bale WF. 1980. Memorandum to the files, March 14, 1951: Hazards associated with radon and thoron. *Health Phys* 38(6):1062-1066.
- Balonov MI, Krisyuk EM, Ramel C. 1999. Environmental radioactivity, population exposure and related health risks in the east Baltic region. *Scand J Work Environ Health* 25(Suppl 3):17-32.
- \*Band P, Feldstein M, Saccomanno G, et al. 1980. Potentiation of cigarette smoking and radiation: Evidence from a sputum cytology survey among uranium miners and controls. *Cancer* 45(6):1273-1277.
- \*Barnes DG, Dourson M. 1988. Reference dose (RfD): Description and use in health risk assessments. *Regul Toxicol Pharmacol* 8(4):471-486.
- Barnett JM, Holbert KE, Stewart BD, et al. 1995. Lung dose estimates from <sup>222</sup>Rn in Arizona groundwater based on liquid scintillation measurements. *Health Phys* 68(5):699-703.
- \*Barros-Dios JM, Barreiro MA, Ruano-Ravina A, et al. 2002. Exposure to residential radon and lung cancer in Spain: A population-based case-control study. (Erratum in: *Am J Epidemiol* 157(9):859). *Am J Epidemiol* 156(6):548-555.
- Barros-Dios JM, Barreiro MA, Ruano-Ravina A, et al. 2003. Errata. (Erratum to: *Am J Epidemiol* 156(6):548-555). *Am J Epidemiol* 157(9):859.
- Bartsch H, Hollstein M, Mustonen R, et al. 1995. Screening for putative radon-specific p53 mutation hotspot in German uranium miners. (Comment on: *Lancet* 343(8889):86-87). *Lancet* 346(8967):121.
- Batkin I, Brun del Re R, Boutin JG, et al. 1998.  $\gamma$ -Spectroscopy investigation of radon daughter deposition on electrostatically charged surfaces. *Phys Med Biol* 43(3):487-499.
- Battista G, Belli S, Carboncini F, et al. 1988. Mortality among pyrite miners with low-level exposure to radon daughters. *Scand J Work Environ Health* 14(5):280-285.
- \*Bauchinger M, Schmid E, Braselmann H, et al. 1994. Chromosome aberrations in peripheral lymphocytes from occupants of houses with elevated indoor radon concentrations. *Mutat Res* 310(1):135-142.
- \*Baysson H, Tirmarche M, Tymen G, et al. 2004. Indoor radon and lung cancer in France. (Comment in: *Epidemiology* 17(1):121, author reply 121-122). *Epidemiology* 15(6):709-716.
- Bean JA, Isacson P, Hahne RMA, et al. 1982. Drinking water and cancer incidence in Iowa. *Am J Epidemiol* 116(6):924-932.
- \*Becker K. 2003. Health effects of high radon environments in central Europe: Another test for the LNT hypothesis? *Dose Response Int J* 1(1):3-35.
- Belli S, Comba P, Germani M, et al. 1989. Mortality study among lead-zinc (Val Seriana) Italian miners. *Med Lav* 6:467-478.

## 9. REFERENCES

- \*Berger GS, ed. 1994. Epidemiology of endometriosis. In: Endometriosis: Advanced management and surgical techniques. New York, NY: Springer-Verlag, 3-7.
- \*Biberman R, Lusky A, Schlesinger T, et al. 1993. Increased risk for small cell lung cancer following residential exposure to low-dose radon: A pilot study. *Arch Environ Health* 48(4):209-212.
- \*Bignon J, Monchaux G, Chameaud J, et al. 1983. Incidence of various types of thoracic malignancy induced in rats by intrapleural injection of 2 mg of various mineral dusts after inhalation of <sup>222</sup>Ra. *Carcinogenesis* 4(5):621-628.
- Bijwaard H, Brugmans MJ, Rispen SM. 2005. Comment on "Studies of radon-exposed miner cohorts using a biologically based model: Comparison of current Czech and French data with historic data from China and Colorado" by W.F. Heidenreich, L. Tomàsek, A. Rogel, D. Laurier and M. Tirmarche (2004) *Radiat Environ Biophys* 43:247-256. (Comment on: *Radiat Environ Biophys* 43(4):247-256). *Radiat Environ Biophys* 44(2):149-151, author reply 153-154.
- \*Bilban M, Jakopin CB. 2005. Incidence of cytogenetic damage in lead-zinc mine workers exposed to radon. *Mutagenesis* 20(3):187-191.
- Binks K. 1989. Radon exposure and leukaemia. (Comment on: *Lancet* 2(8654):99-100). *Lancet* 2(8662):562.
- \*Birchall A, James AC. 1994. Uncertainty analysis of the effective dose per unit exposure from radon progeny and implications for ICRP risk-weighting factors. *Radiat Prot Dosimetry* 53(1):133-140.
- Birovljev A, Falk R, Walsh C, et al. 2001. Retrospective assessment of historic radon concentrations in Norwegian dwellings by measuring glass implanted Po-210: An international field intercomparison. *Sci Total Environ* 272(1-3):181-188.
- \*Black SC, Archer VE, Dixon WC, et al. 1968. Correlation of radiation exposure and lead-210 in uranium miners. *Health Phys* 14(2):81-93.
- \*Blanchard RL, Archer VE, Saccomanno G. 1969. Blood and skeletal levels of <sup>210</sup>Pb–<sup>210</sup>Po as a measure of exposure to inhaled radon daughter products. *Health Phys* 16(5):585-596.
- \*Blot WJ, Xu ZY, Boice JD, et al. 1990. Indoor radon and lung cancer in China. (Comment in: *J Natl Cancer Inst* 82(21):1722-1723). *J Natl Cancer Inst* 82(12):1025-1030.
- Bohicchio F, Forastiere F, Abeni D, et al. 1998. Epidemiologic studies on lung cancer and residential exposure to radon in Italy and other countries. *Radiat Prot Dosimetry* 78(1):33-38.
- \*Bohicchio F, Forastiere F, Farchi S, et al. 2005. Residential radon exposure, diet and lung cancer: A case-control study in a Mediterranean region. *Int J Cancer* 114(6):983-991.
- Bodansky D. 1990. Radon induced lung cancer and mortality. In: Majumdar SK, Schmalz RF, Miller EW, eds. *Environmental radon: Occurrence, control and health hazards*. Easton, PA: Pennsylvania Academy of Science, 248-265.
- Bodansky D, Jackson KL, Geraci JP. 1987. Comparisons of indoor radon to other radiation hazards. In: Bodansky D, Robkin M, Stadler D, eds. *Indoor radon and its hazards*. Seattle: University of Washington Press, 122-137.

## 9. REFERENCES

- \*Boice JD. 1997. Radon, your home or mine? (Comment on: Radiat Res 147(2):126-134). Radiat Res 147(2):135-137.
- Boice JD, Cohen SS, Mumma MT, et al. 2007. Mortality among residents of Uravan, Colorado who lived near a uranium mill, 1936-84. J Radiol Prot 27(3):299-319.
- Boice JD, Mumma MT, Blot WJ. 2007. Cancer and noncancer mortality in populations living near uranium and vanadium mining and milling operations in Montrose County, Colorado, 1950-2000. Radiat Res 167(6):711-726.
- \*Bonner MR, Bennett WP, Xiong W, et al. 2006. Radon, secondhand smoke, glutathione-S-transferase M1 and lung cancer among women. Int J Cancer 119(6):1462-1467.
- \*Booker DV, Chamberlain AC, Newton D, et al. 1969. Uptake of radioactive lead following inhalation and injection. Br J Radiol 42:457-466.
- Böse-O'Reilly S, Heudorf U, Lob-Corzilius T, et al. 2007. Children's environment in Central Europe: Threats and chances. Int J Hyg Environ Health 210(5):503-507.
- \*Bowring CS. 1992. Short term radon measurements in buildings. J Radiol Prot 12(4):239-241.
- Brandom WF, Saccomanno G, Archer VE, et al. 1972. Chromosome aberrations in uranium miners occupationally exposed to <sup>222</sup>radon. Radiat Res 52:204-215.
- \*Brandom WF, Saccomanno G, Archer VE, et al. 1978. Chromosome aberrations as a biological dose-response indicator of radiation exposure in uranium miners. Radiat Res 76(1):159-171.
- Braun A, Straif K, Konietzko N, et al. 1995. Detection of oncogene and tumor suppressor gene products in serum of former uranium miners for secondary prevention of radon-induced lung cancer. Clin Chem 41(12):1913-1915.
- \*Brenner DJ, Ward JF. 1992. Constraints on energy deposition and target size of multiply damaged sites associated with DNA double-strand breaks. Int J Radiat Biol 61(6):737-748.
- \*Breslin A. 1980. Techniques for measuring radon in buildings. Washington, DC: National Bureau of Standards Special Publication 581, In: Proceedings of a Roundtable Discussion of Radon in Buildings held at NSB, Gaithersburg, Maryland.
- \*Bridges BA, Cole J, Arlett CF, et al. 1991. Possible association between mutant frequency in peripheral lymphocytes and domestic radon concentrations. (Comment in: Lancet 337(8755):1476). Lancet 337(8751):1187-1189.
- \*Brookins DG. 1991. Correlation of soil radon and uranium with indoor radon in the Albuquerque, New Mexico (USA). Environ Geol Water Sci 17(3):209-218.
- \*Brooks AL, Khan MA, Duncan A, et al. 1994. Effectiveness of radon relative to acute <sup>60</sup>Co  $\gamma$ -rays for induction of micronuclei *in vitro* and *in vivo*. Int J Radiat Biol 66(6):801-808.



## 9. REFERENCES

- \*Brooks AL, Rithidech K, Kitchin RM, et al. 1992. Evaluating chromosome damage to estimate dose to tracheal epithelial cells. Indoor radon and lung cancer: Reality or myth? Twenty-ninth Hanford Symposium on health and the environment, October 15-19, 1990. Columbus, OH: Battelle Press, 601-614.
- \*Brown WL, Hess CT. 1992. Measurement of the biotransfer and time constant of radon from ingested water by human breath analysis. *Health Phys* 62(2):162-170.
- Brugmans MJ, Rispens SM, Bijwaard H, et al. 2004. Radon-induced lung cancer in French and Czech miner cohorts described with a two-mutation cancer model. (Comment in: *Radiat Environ Biophys* 44(2):155-156). *Radiat Environ Biophys* 43(3):153-163.
- \*Brüske-Hohlfeld I, Rosario AS, Wölke G, et al. 2006. Lung cancer risk among former uranium miners of the WISMUT Company in Germany. (Comment in: *Health Phys* 91(4):390-391, author reply 392). *Health Phys* 90(3):208-216.
- \*Bunzl K, Ruckerbauer F, Winkler R. 1998. Temporal and small-scale spatial variability of <sup>222</sup>Rn gas in a soil with a high gravel content. *Sci Total Environ* 220(2-3):157-166.
- \*Butler C, Samet JM, Black WC, et al. 1986. Histopathologic findings of lung cancer in Navajo men: Relationship to U mining. *Health Phys* 51(3):365-368.
- \*Buttafuoco G, Tallarico A, Falcone G. 2007. Mapping soil gas radon concentration: A comparative study of geostatistical methods. *Environ Monit Assess* 131(1-3):135-151.
- \*Butterweck G, Schuler C, Vezzù G, et al. 2002. Experimental determination of the absorption rate of unattached radon progeny from respiratory tract to blood. *Radiat Prot Dosimetry* 102(4):343-348.
- Butterweck G, Vezzù G, Schuler C, et al. 2001. *In vivo* measurement of unattached radon progeny deposited in the human respiratory tract. *Radiat Prot Dosimetry* 94(3):247-250.
- Carta P, Aru G, Manca P. 2001. Mortality from lung cancer among silicotic patients in Sardinia: An update study with 10 more years of follow up. *Occup Environ Med* 58(12):786-793.
- \*Carta P, Cocco P, Picchiri G. 1994. Lung cancer mortality and airways obstruction among metal miners exposed to silica and low levels of radon daughters. *Am J Ind Med* 25(4):489-506.
- Cartwright RA, Miles JC, Kendall GM. 2003. Childhood cancers and radon. (Comment on: *Lancet* 360(9344):1437-1438). *Lancet* 361(9369):1658.
- Catelinois O, Rogel A, Laurier D, et al. 2006. Lung cancer attributable to indoor radon exposure in France: Impact of the risk models and uncertainty analysis. *Environ Health Perspect* 114(9):1361-1366.
- Cauwels P, Poffijn A. 2000. An improved model for the reconstruction of past radon exposure. *Health Phys* 78(5):528-532.
- Cavallo AJ. 2004. Comment on "The U.S. Environmental Protection Agency's assessment of risks from indoor radon". (Comment on: *Health Phys* 87(1):68-74). *Health Phys* 87(6):671-672, author reply 672.
- CDC. 1989. Lung cancer and exposure to radon in women - New Jersey. Centers for Disease Control. *MMWR Morb Mortal Wkly Rep* 38(42):715-718.

## 9. REFERENCES

- \*CDC. 1999. Radon testing in households with a residential smoker - United States, 1993-1994. Centers for Disease Control. MMWR Morb Mortal Wkly Rep 48(31):683-686.
- Cech I, Burau KD, Walston J. 2007. Spatial distribution of orofacial cleft defect births in Harris County, Texas, 1990 to 1994, and historical evidence for the presence of low-level radioactivity in tap water. (Comment in: South Med J 100(6):553-554). South Med J 100(6):560-569.
- \*Cember H. 1983. Introduction to health physics. 2nd ed. New York, NY: Pergamon Press, 335-341.
- \*Chamberlain AC, Dyson ED. 1956. The dose to the trachea and bronchi from the decay products of radon and thoron. Br J Radiol 29(342):317-325.
- +\*Chameaud J, Masse R, Lafuma J. 1984. Influence of radon daughter exposure at low doses on occurrence of lung cancer in rats. Radiation Protection Dosimetry 7:385-388.
- \*Chameaud J, Perraud R, Chrétien J, et al. 1980. Combined effects of inhalation of radon daughter products and tobacco smoke. In: Sanders CL, Cross FT, Dagle GE, et al., eds. Pulmonary toxicology of respirable particles. Oak Ridge, TN: U.S. Department of Energy, 551-557.
- +\*Chameaud J, Perraud R, Chrétien J, et al. 1982b. Lung carcinogenesis during *in vivo* cigarette smoking and radon daughter exposure in rats. Recent Results Cancer Res 82:11-20.
- +\*Chameaud J, Perraud R, LaFuma J, et al. 1974. Lesions and lung cancers induced in rats by inhaled radon 222 at various equilibriums with radon daughters. In: Karbe E, Park J, eds. Experimental lung cancer. Carcinogenesis and bioassays. New York, NY: Springer-Verlag, 410-421.
- +\*Chameaud J, Perraud R, LaFuma J, et al. 1982a. Cancers induced by Rn-222 in the rat. In: Clemente C, Nero A, Steinhausler F, et al., eds. Proceedings of the specialist meeting on the assessment of radon and daughter exposure and related biological effects. Salt Lake City, UT: RD Press, 198-209.
- Chameaud J, Perraud R, Masse R, et al. 1976. Lung cancer induced in rats by radon and its daughter nuclides at different concentrations. In: Biological and environmental effects of low-level radiation. Vol. II. Vienna: International Atomic Energy Agency, 223-228.
- \*Chandrashekara MS, Sannappa J, Paramesh L. 2006. Studies on atmospheric electrical conductivity related to radon and its progeny concentrations in the lower atmosphere at Mysore. Atmos Environ 40(11):87-95.
- Chang SY, Ha CW, Lee BH. 1992. Estimate of lifetime excess lung cancer risk due to <sup>222</sup>Rn daughter exposure in Korea. Radiat Prot Dosimetry 42(2):127-132.
- Charles MW. 2007a. Radon exposure of the skin: I. Biological effects. J Radiol Prot 27(3):231-252.
- Charles MW. 2007b. Radon exposure of the skin: II. Estimation of the attributable risk for skin cancer incidence. J Radiol Prot 27(3):253-274.
- \*Checkoway H, Matthe RM, Hickey JL, et al. 1985. Mortality among workers in the Florida phosphate industry. J Occup Med 27(12):885-892.

## 9. REFERENCES

- \*ChemIDplus. 2008. Radon isotopes. ChemIDplus. Bethesda, MD: U.S. National Library of Medicine. <http://sis.nlm.nih.gov/chemical.html>. June 24, 2008.
- Chen J. 2005. Canadian individual risks of radon-induced lung cancer for different exposure profiles. *Can J Public Health* 96(5):360-363.
- Chen W, Chen J. 2002. Nested case-control study of lung cancer in four Chinese tin mines. *Occup Environ Med* 59(2):113-118.
- Chen CJ, Weng PS, Chu TC. 1993. Evaluation of natural radiation in houses built with black schist. *Health Phys* 64(1):74-78.
- Chen SY, Hayes RB, Liang SR, et al. 1990. Mortality experience of haematite mine workers in China. *Br J Ind Med* 47(3):175-181.
- \*Chernick CL, Claassen HH, Fields PR, et al. 1962. Fluorine compounds of xenon and radon. *Science* 138(3537):136-138.
- Cheung TT, Yu KN, Nikezic D. 2001. Bronchial dosimeter for radon progeny. *Appl Radiat Isot* 55(5):707-713.
- \*Clemente GF, Renzetti A, Santori G, et al. 1982. Pb-210-Po-210 tooth content and radon daughter exposure. In: Vohra K, Pillai K, Mishra U, et al., eds. *Proceedings of the second special symposium on natural radiation environment*. New York, NY: John Wiley and Sons, 269-274.
- \*Clemente GF, Renzetti A, Santori G, et al. 1984. Relationship between the <sup>210</sup>Pb content of teeth and exposure to Rn and Rn daughters. *Health Phys* 47(2):253-262.
- \*Clewell HJ, Andersen ME. 1985. Risk assessment extrapolations and physiological modeling. *Toxicol Ind Health* 1(4):111-131.
- Cocco PL, Carta P, Belli S, et al. 1994. Mortality of Sardinian lead and zinc miners: 1960-88. *Occup Environ Med* 51(10):674-682.
- \*Cohen BL. 1979. Radon: Characteristics, natural occurrence, technological enhancement, and health effects. *Prog Nucl Energy* 4:1-24.
- \*Cohen BL. 1986. A national survey of 222-Rn in U.S. homes and correlating factors. *Health Phys* 51:175-183.
- Cohen BL. 1992. Compilation and integration of studies of radon levels in U.S. homes by states and counties. *Crit Rev Environ Control* 22(3/4):243-364.
- Cohen BL. 1993. Relationship between exposure to radon and various types of cancer. *Health Phys* 65(5):529-531.
- Cohen BL. 1995. Test of the linear-no threshold theory of radiation carcinogenesis for inhaled radon decay products. (Comment in: *Health Phys* 75(1):11-17). *Health Phys* 68(2):157-174.
- Cohen BL. 1997a. Lung cancer rate vs mean radon level in U.S. counties of various characteristics. *Health Phys* 72(1):114-119.

## 9. REFERENCES

- Cohen BL. 1997b. Problems in the radon vs lung cancer test of the linear no-threshold theory and a procedure for resolving them. (Comment in: Health Phys 73(3):530-532; 75(1):4-10; 75(1):11-17; 75(6):652-654). Health Phys 72(4):623-628.
- Cohen BL. 1998a. Response to criticisms of Smith et al. (Comment on: Health Phys 75(1):11-17). Health Phys 75(1):23-28, discussion 31-33.
- Cohen BL. 1998b. Response to Lubin's proposed explanations of our discrepancy. (Comment in: Health Phys 76(4):437-439). (Comment on: Health Phys 75(1):4-10). Health Phys 75(1):18-22, discussion 29-30.
- Cohen BL. 1999a. Response to "Rejoinder" by Field et al. (Comment in: Health Phys 77(3):328-329). Health Phys 76(4):439-440.
- Cohen BL. 1999b. Response to the Lubin rejoinder. (Comment on: Health Phys 75(1):18-22, discussion 29-30). Health Phys 76(4):437-439.
- Cohen BL. 2000a. Explaining the lung cancer versus radon exposure data for USA counties. (Comment in: J Radiol Prot 21(1):64-66). J Radiol Prot 20(2):219-222.
- Cohen BL. 2000b. Re: "Parallel analyses of individual and ecologic data on residential radon, cofactors, and lung cancer in Sweden". (Comment on: Am J Epidemiol 149(3):268-274). Am J Epidemiol 152(2):194-195.
- Cohen BL. 2001. Radon exposure and the risk of lung cancer. (Comment on: J Radiol Prot 20(2):219-222). J Radiol Prot 21(1):64-66.
- Cohen BL. 2002. Response to 'The potential for bias in Cohen's ecological analysis of lung cancer and residential radon'. (Comment on: J Radiol Prot 22(2):141-148). J Radiol Prot 22(3):305-307, author reply 307-309.
- Cohen BL. 2004a. The Puskin observation on smoking as a confounder in ecologic correlations of cancer mortality rates with average county radon levels. (Comment on: Health Phys 84(4):526-532). Health Phys 86(2):203-204, author reply 204-205.
- Cohen BL. 2004b. The Van Pelt reassessment of our lung cancer vs. radon study. (Comment on: Health Phys 85(4):397-403). Health Phys 86(3):316-318, author reply 318.
- \*Cohen BS. 1996. Particle deposition in human and canine tracheobronchial casts: A determinant of radon dose to the critical cells of the respiratory tract. Health Phys 70(5):695-705.
- Cohen BL, Gromicko N. 1988. Adequacy of time averaging with diffusion barrier charcoal adsorption collectors for <sup>222</sup>Rn measurements in homes. Health Phys 54(2):195-202.
- Cohen BL, Gromicko N. 1989. Radon-222 levels in low income households. Health Phys 56(3):349-354.
- \*Cohen BL, Nason R. 1986. A diffusion barrier charcoal adsorption collector for measuring Rn concentrations in indoor air. Health Phys 50(4):457-463.

## 9. REFERENCES

Cohen BL, Nelson D. 1987. Radon. A homeowner's guide to detection and control. Mount Vernon, NY: Consumers Union, 185.

Cohen BL, Shah RS. 1991. Radon levels in United States homes by states and counties. *Health Phys* 60(2):243-259.

Cohen BL, Stone CA, Schilken CA. 1994. Indoor radon maps of the United States. *Health Phys* 66(2):201-205.

\*Cohen N, Jaakkola T, Wrenn ME. 1973. Lead-210 concentrations in the bone, blood and excreta of a former uranium miner. *Health Phys* 24(6):601-609.

Cohn SH, Skow RK, Gong JK. 1953. Radon inhalation studies in rats. *Arch Ind Hyg Occup Med* 7(6):508-515.

\*Cole J, Green MH, Bridges BA, et al. 1996. Lack of evidence for an association between the frequency of mutants or translocations in circulating lymphocytes and exposure to radon gas in the home. *Radiat Res* 145(1):61-69.

Collier CG, Strong JC, Baker ST, et al. 1999. Effects of continuous inhalation exposure of rats to radon and its progeny at various levels of dose and dose rate: Interim results. *Radiat Res* 152(Suppl 6):S141-S144.

Collman GW, Loomis DP, Sandler DP. 1988. Radon-222 concentrations in groundwater and cancer mortality in North Carolina. *Int Arch Occup Environ Health* 61:13-18.

Collman GW, Loomis DP, Sandler DP. 1991. Childhood cancer mortality and radon concentration in drinking water in North Carolina. *Br J Cancer* 63(4):626-629.

Conrady VJ, Martin K, Nagel M. 1996. Weniger modelle – spezifischere analytische studien zum radonrisiko in Wohnungen sind notwendig. *Bundesgesundheitsblatt* 3:106-110.

\*Correia JA, Weise S, Callahan RJ, et al. 1988. Cumulative organ radioactivity concentrations of 222-radon and its progeny following ingestion. *Journal of Nuclear Medicine* 29(5):872-873.

\*Cothorn CR. 1987a. Properties. In: Cothorn C, Smith J, eds. *Environmental radon*. New York, NY: Plenum Press, 1-29.

\*Cothorn CR. 1987b. History and uses. In: Cothorn C, Smith J, eds. *Environmental radon*. New York, NY: Plenum Press, 31-58.

Cothorn CR. 1990. Indoor air radon. *Rev Environ Contam Toxicol* 111:1-60.

\*Cothorn CR, Lappenbusch WL, Michel J. 1986. Drinking-water contribution to natural background radiation. *Health Phys* 50(1):33-47.

Crawford-Brown DJ. 1983. An age-dependent model for the kinetics of uptake and removal of radionuclides from the G.I. tract. *Health Phys* 44(6):609-622.

Crawford-Brown DJ. 1987. Age-dependent lung doses from ingested <sup>222</sup>Rn in drinking water. *Health Phys* 52(2):149-156.

## 9. REFERENCES

- \*Crawford-Brown DJ. 1989. The biokinetics and dosimetry of radon-222 in the human body following ingestion of ground water. *Environmental Geochemistry and Health* 11:10-17.
- Crawford-Brown DJ. 1991. Cancer fatalities from waterborne radon (Rn-222). *Risk Anal* 11(1):135-143.
- Crawford-Brown DJ, Cothorn CR. 1987. A Bayesian analysis or scientific judgment of uncertainties in estimating risk due to <sup>222</sup>Rn in U.S. public drinking water supplies. *Health Phys* 53(1):11-21.
- \*Crawford-Brown DJ, Michel J. 1987. Measurement. In: Cothorn C, Smith J, eds. *Environmental radon*. New York, NY: Plenum Press, 59-80.
- \*Cross FT. 1988. Radon inhalation studies in animals. *Radiat Prot Dosim* 24(1):463-466.
- \*Cross FT. 1994. Invited commentary: Residential radon risks from the perspective of experimental animal studies. (Comment on: *Am J Epidemiol* 140(4):310-322). *Am J Epidemiol* 140(4):333-339.
- Cross FT. 1995. Evidence of cancer risk from experimental animal radon studies. In: Young JP, Yalow RS, eds. *Radiation and public perception: Benefits and risks*. Washington, DC: American Chemical Society.
- Cross FT, Buschbom R, Dagle G, et al. 1985. Inhalation hazards to uranium miners. Pacific Northwest Laboratory annual report for 1984 to the DOE Office of Energy Research. Part 1. Biomedical sciences. PNL-550-Pt 1, 39-41.
- Cross FT, Dagle GE, Gies RA, et al. 1992. Experimental animal studies of radon and cigarette smoke. Indoor radon and lung cancer: Reality or myth? Twenty-ninth Hanford Symposium on health and the environment, October 15-19, 1990. Columbus, OH: Battelle Press, 821-844.
- \*Cross FT, Filipy RE, Loscutoff SM, et al. 1981a. Histopathologic, morphometric and physiologic investigation of lungs of dogs exposed to uranium ore dust. International conference on radiation hazards in mining, 228-235.
- \*Cross FT, Palmer RF, Busch RH, et al. 1981b. Development of lesions in Syrian golden hamsters following exposure to radon daughters and uranium ore dust. *Health Phys* 41(1):135-153.
- \*Cross FT, Palmer RF, Busch RH, et al. 1982a. Influence of radon daughter exposure rate and uranium ore dust concentration on occurrence of lung tumors. In: Clement C, Nero A, Steinhausler F, et al., eds. *Proceedings of the specialist meeting on the assessment of radon and daughter exposure and related biological effects*. Salt Lake City: RD Press, 189-197.
- \*Cross FT, Palmer RF, Busch RH, et al. 1986. An overview of PNL radon experiments with reference to epidemiological data. In: Thompson R, Mahaffey J, eds. *Life-span radiation effects studies in animals: What can they tell us?* Proceedings 22nd Hanford Life Sciences Symposium, Richland, WA. Springfield, VA: U.S. Department of Energy. DE87000490.
- \*Cross FT, Palmer RF, Dagle G, et al. 1984. Influence of radon daughter exposure rate, unattachment fraction, and disequilibrium on occurrence of lung tumours. *Radiation Protection Dosimetry* 7:381-384.

## 9. REFERENCES

- \*Cross FT, Palmer RF, Filipy RE, et al. 1982b. Carcinogenic effects of radon daughters, uranium ore dust and cigarette smoke in beagle dogs. *Health Phys* 42(1):33-52.
- \*Dagle GE, Cross FT, Gies RA. 1992. Morphology of respiratory tract lesions in rats exposed to radon progeny. Indoor radon and lung cancer: Reality or myth? Twenty-ninth Hanford Symposium on health and the environment, October 15-19, 1990. Columbus, OH: Battelle Press, 659-676.
- \*Damber L, Larsson LG. 1982. Combined effects of mining and smoking in the causation of lung carcinoma. *Acta Radiol Oncol* 21(5):305-313.
- Damber L, Larsson LG. 1985. Underground mining, smoking, and lung cancer: A case-control study in the iron ore municipalities in Northern Sweden. *J Natl Cancer Inst* 74(6):1207-1213.
- Dano L, Guilly MN, Dutrillaux B, et al. 2001. Clonal evolution of a radon-induced rat lung tumor. *Cancer Genet Cytogenet* 125(1):52-58.
- Darby SC. 1990. Higher risk coefficients associated with lower average exposure rates among epidemiological studies of the effects of radon in miners. *Int J Radiat Biol* 58(5):860-864.
- \*Darby S, Hill D, Auvinen A, et al. 2005. Radon in homes and risk of lung cancer: Collaborative analysis of individual data from 13 European case-control studies. (Comment in: *BMJ* 330(7485):226-227; 330(7500):1151). *BMJ* 330(7485):223.
- \*Darby S, Hill D, Deo H, et al. 2006. Residential radon and lung cancer--detailed results of a collaborative analysis of individual data on 7148 persons with lung cancer and 14,208 persons without lung cancer from 13 epidemiologic studies in Europe. (Erratum in: *Scand J Work Environ Health* 33(1):80). *Scand J Work Environ Health* 32(Suppl 1):1-83.
- Darby S, Hill D, Deo H, et al. 2007. Corrections to residential radon and lung cancer--detailed results of a collaborative analysis of individual data on 7148 persons with lung cancer and 14,208 persons without lung cancer from 13 epidemiologic studies in Europe. (Erratum to: *Scand J Work Environ Health* 32(Suppl 1):1-83). *Scand J Work Environ Health* 33(1):80.
- Darby S, Hill D, Doll R. 2001. Radon: A likely carcinogen at all exposures. *Ann Oncol* 12(10):1341-1351.
- Darby S, Radford E, Whitley E. 1995a. Radon exposure and cancers other than lung cancer in Swedish iron miners. *Environ Health Perspect Suppl* 103(2):45-47.
- Darby S, Whitley E, Howe GR, et al. 1995b. Radon and cancers other than lung cancer in underground miners: A collaborative analysis of 11 studies. *J Natl Cancer Inst* 87(5):378-384.
- \*Darby S, Whitley E, Silcocks P, et al. 1998. Risk of lung cancer associated with residential radon exposure in south-west England: A case-control study. (Comment in: *Br J Cancer* 79(9-10):1621-1623). *Br J Cancer* 78(3):394-408.
- Davis AJ, Strom DJ. 2008. Uncertainty and variability in historical time-weighted average exposure data. *Health Phys* 94(2):145-160.
- \*Davies B, Morris T. 1993. Physiological parameters in laboratory animals and humans. *Pharmacology Research* 10:1093-1095.

## 9. REFERENCES

- \*Dean R. 1981. Semen analyses among uranium miners. In: Wiese W, ed. Birth defects in the Four Corners area. Transcript of a meeting. Albuquerque, NM: University of New Mexico School of Medicine, 51-54.
- Deluca S, Castronovo F. 1988. Radon. *Am Fam Physician* 37(2):233-234.
- Denman AR, Eatough JP, Gillmore G, et al. 2003. Assessment of health risks to skin and lung of elevated radon levels in abandoned mines. *Health Phys* 85(6):733-739.
- Denman AR, Parkinson S, Groves-Kirkby CJ, et al. 2004. ICRP draft recommendations 2005 and radon exposure. *J Radiol Prot* 24(4):423-425.
- De Villiers AJ, Windish JP. 1964. Lung cancer in a fluorspar mining community. I. Radiation, dust, and mortality experience. *Br J Ind Med* 21:94-109.
- De Villiers AJ, Windish JP, Brent FN, et al. 1971. Mortality experience of the community and of the fluorspar mining employees at St. Lawrence, Newfoundland. *Occup Health Rev* 22(1):1-15.
- Distenfeld C, Distenfeld J, Distenfeld L. 2001. Radon measurements and analysis for central Pennsylvania counties having elevated radon levels. *Health Phys* 80(Suppl 5):S55-S61.
- Djuric D, Kilibarda M, Novak L, et al. 1964. Studies on airborne radioactive contamination of miners in a Yugoslav uranium mine. *Health Phys* 10:1059-1064.
- \*Dobbin M. 1987. Deep breath down under. *US News World Rep* 102:40.
- \*DOE. 1990. Model for assessing radiation dose to epithelial cells of the human respiratory tract from radon progeny. Washington, DC: U.S. Department of Energy. DE91005614.
- \*DOE. 2008. NuDat 2.4. National Nuclear Data Center. U.S. Department of Energy. <http://www.nndc.bnl.gov/nudat2/>. June 23, 2008.
- Doi M, Kobayashi S. 1994. Vertical distribution of outdoor radon and thoron in Japan using a new discriminative dosimeter. *Health Phys* 67(4):385-392.
- Doi M, Nakamura Y, Sakashita T, et al. 2001. Lifetime risk of lung cancer due to radon exposure projected to Japanese and Swedish populations. *Health Phys* 80(6):552-562.
- Doke T, Oshima T, Takahashi H, et al. 1973. A radon exposure experiment of rats and mice. *J Radiat Res (Tokyo)* 14(2):153-168.
- Dua SK, Hopke PK, Kotrappa P. 1995. Electret method for continuous measurement of the concentration of radon in water. *Health Phys* 68(1):110-114.
- Dundulis WP, Bell WJ, Keene BE, et al. 1984. Radon-222 in the gastrointestinal tract: A proposed modification of the ICRP Publication 30 model. *Health Phys* 47(2):243-252.
- Duport P. 2002. Is the radon risk overestimated? Neglected doses in the estimation of the risk of lung cancer in uranium underground miners. *Radiat Prot Dosimetry* 98(3):329-338.



## 9. REFERENCES

- Duport P. 2003. Exposure to residential radon causes lung cancer. Against the proposition. (Comment on: Med Phys 30(4):485-486). Med Phys 30(4):486-488.
- Duport P. 2004. Danger in extrapolating indoor radon risk from underground miner data. (Comment on: Health Phys 87(1):68-74). Health Phys 87(6):670-671, author reply 672.
- Eatough JP. 2004. Radon and leukemia risk in underground miners: Are working level months the most appropriate exposure parameter? (Comment on: Health Phys 81(3):272-288). Health Phys 86(4):425-426, author reply 427-428.
- Eatough JP, Henshaw DL. 1994. Radon exposure and myeloid leukaemia. Int J Epidemiol 23(2):430-431.
- Eatough JP, Worley A, Moss GR. 1999. Personal monitoring of  $^{218}\text{Po}$  and  $^{214}\text{Po}$  radionuclide deposition onto individuals under normal environmental exposure conditions. Phys Med Biol 44(9):2227-2239.
- EC. 1999. High residential radon health effects in Saxony (Schneeberg study). European Commission. <http://igp-institut.de/Radon.pdf>. April 24, 2008.
- Edling C. 1982. Lung cancer and smoking in a group of iron ore miners. Am J Ind Med 3(2):191-199.
- \*Edling C, Axelson O. 1983. Quantitative aspects of radon daughter exposure and lung cancer in underground miners. Br J Ind Med 40(2):182-187.
- Edling C, Kling H, Axelson O. 1984. Radon in homes--a possible cause of lung cancer. Scand J Work Environ Health 10(1):25-34.
- \*Eichholz G. 1987. Human exposure. In: Cothorn C, Smith J, eds. Environmental radon. New York, NY: Plenum Press, 131-172.
- Eigenwillig GG. 2006. Errors and blunders in the estimation of radiation exposure for the uranium miners of WISMUT in Germany. (Comment on: Health Phys 90(3):208-216). Health Phys 91(4):390-391, author reply 392.
- Einer-Jensen N, Hunter RHF. 2005. Counter-current transfer in reproductive biology. Reproduction 129:9-18.
- \*Eisenbud M, Laurer GR, Rosen JC, et al. 1969. *In vivo* measurement of lead-210 as an indicator of cumulative radon daughter exposure in uranium miners. Health Phys 16(5):637-646.
- \*El-Hussein A, Ahmed AA, Mohammed A. 1998. Radiation dose to the human respiratory tract from inhalation of radon-222 and its progeny. Appl Radiat Isot 49(7):783-790.
- \*Ellenhorn MJ, Schoenwald S, Ordog G, et al., eds. 1997. Radiation poisoning. In: Ellenhorn's medical toxicology: Diagnosis and treatment of human poisoning. Baltimore, MD: Williams & Wilkins, 1682-1723.
- Enflo A. 2002. Lung cancer risks from residential radon among smokers and non-smokers. J Radiol Prot 22(3A):A95-A99.

## 9. REFERENCES

- Ennemoser O, Ambach W, Brunner P, et al. 1993a. Exposure to unusually high indoor radon levels. *Lancet* 341(8848):828-829.
- Ennemoser O, Ambach W, Brunner P, et al. 1993b. High domestic and occupational radon exposures: A comparison. (Comment on: *Lancet* 341(8850):919-923). *Lancet* 342(8862):47.
- Ennemoser O, Ambach W, Brunner P, et al. 1994. Unusual high radon exposure in homes and lung cancer. *Lancet* 344(8915):127-128.
- EPA. 1985. Drinking water criteria document for radon. Washington, DC: U.S. Environmental Protection Agency, Office of Drinking Water.
- EPA. 1986a. A citizen's guide to radon - what it is and what to do about it. Washington, DC: U.S. Environmental Protection Agency, Office of Air and Radiation.
- \*EPA. 1986b. Interim radon and radon decay product measurement protocols. Washington, DC: U.S. Environmental Protection Agency, Office of Radiation Programs. EPA52018604.
- EPA. 1986c. Radon reduction methods a homeowner's guide. Washington, DC: U.S. Environmental Protection Agency, Research and Development Office.
- \*EPA. 1987a. Interim protocols for screening and follow-up radon and radon decay product measurements. Washington, DC: U.S. Environmental Protection Agency. EPA520860141. PB89224265.
- \*EPA. 1987b. Radiation protection guidance to federal agencies for occupational exposure; approval of U.S. Environmental Protection Agency recommendations. U.S. Environmental Protection Agency. *Fed Regist* 52:2823-2834.
- \*EPA. 1988. Limiting values of radionuclide intake and air concentration and dose conversion factors for inhalation, submersion, and ingestion. Federal Guidance Report No. 11. Washington, DC: U.S. Environmental Protection Agency, Office of Radiation Programs. EPA520188020.
- \*EPA. 1989. Risk assessment methodology. Environmental impact statement for NESHAPS radionuclides. Background information document. Vol. 1. Washington, DC: U.S. Environmental Protection Agency, Office of Radiation Programs. EPA520189005.
- EPA. 1990. Interim methods for development of inhalation reference concentrations. Washington, DC: U.S. Environmental Protection Agency, Office of Health and Environmental Assessment, Office of Research and Development, Environmental Criteria and Assessment Office. EPA600890066A.
- \*EPA. 1992. Indoor radon and radon decay product measurement device protocols. U.S. Environmental Protection Agency. [http://www.smallbiz-enviroweb.org/pub\\_video/epadocs/jdocs/j08.pdf](http://www.smallbiz-enviroweb.org/pub_video/epadocs/jdocs/j08.pdf). August 12, 2008.
- EPA. 1993. External exposure to radionuclides in air, water, and soil. Washington, DC: U.S. Environmental Protection Agency. Office of Radiation and Indoor Air. EPA402R93081. <http://www.epa.gov/radiation/federal/>. May 11, 2007.
- \*EPA. 1995. Technical resource document. Extraction and beneficiation of ores and minerals. Vol. 5. Uranium. Washington, DC: U.S. Environmental Protection Agency.

## 9. REFERENCES

- \*EPA. 1997. Special report on environmental endocrine disruption: An effects assessment and analysis. Washington, DC: U.S. Environmental Protection Agency, Risk Assessment Forum. EPA630R96012.
- \*EPA. 1998. Automated Form R for Windows: User's guide (RY97). Washington, DC: U.S. Environmental Protection Agency, Office of Pollution Prevention and Toxics.
- \*EPA. 1999. Cancer risk coefficients for environmental exposure to radionuclides. Federal Guidance Report No. 13. Washington, DC: U.S. Environmental Protection Agency. EPA402R99001.
- \*EPA. 2001. Radionuclide table: Radionuclide carcinogenicity – slope factors. Washington, DC: Office of Radiation and Indoor Air, U.S. Environmental Protection Agency. [http://www.epa.gov/radiation/heat/docs/heat2\\_table\\_4-d2\\_0401.wpd](http://www.epa.gov/radiation/heat/docs/heat2_table_4-d2_0401.wpd). May 18, 2007.
- \*EPA. 2003. EPA assessment of risks from radon in homes. U.S. Environmental Protection Agency. EPA402R03003. <http://www.epa.gov/radon/pdfs/402-r-03-003.pdf>. May 13, 2008.
- \*EPA. 2005. Toxic chemical release inventory reporting forms and instructions: Revised 2004 version. Section 313 of the Emergency Planning and Community Right-to-Know Act (Title III of the Superfund Amendments and Reauthorization Act of 1986). U.S. Environmental Protection Agency. Office of Environmental Information. EPA260B05001.
- \*EPA. 2006a. 2006 Edition of the drinking water standards and health advisories. Washington, DC: Office of Water, U.S. Environmental Protection Agency. EPA822R06013. <http://www.epa.gov/waterscience/criteria/drinking/dwstandards.pdf>. April 11, 2007.
- \*EPA. 2006b. National recommended water quality criteria. Washington, DC: U.S. Environmental Protection Agency, Office of Water, Office of Science and Technology. <http://www.epa.gov/waterscience/criteria/nrwqc-2006.pdf>. January 08, 2008.
- \*EPA. 2006c. Consumer's guide to radon reduction. How to fix your home. U.S. Environmental Protection Agency. <http://www.epa.gov/radon/pubs/consguid.html>. August 28, 2008.
- \*EPA. 2007a. Acute exposure guideline levels (AEGs). Washington, DC: Office of Pollution Prevention and Toxics, U.S. Environmental Protection Agency. <http://www.epa.gov/oppt/aegl/pubs/compiled.pdf>. April 24, 2008.
- \*EPA. 2007b. The Clean Air Act amendments of 1990 list of hazardous air pollutants. Clean Air Act. U.S. Environmental Protection Agency. United States Code. 42 USC 7412. <http://www.epa.gov/ttn/atw/orig189.html>. April 24, 2008.
- \*EPA. 2007c. Standard. U.S. Environmental Protection Agency. Code of Federal Regulations. 61 CFR 22. [http://edocket.access.gpo.gov/cfr\\_2007/julqtr/pdf/40cfr61.22.pdf](http://edocket.access.gpo.gov/cfr_2007/julqtr/pdf/40cfr61.22.pdf). June 25, 2008.
- \*EPA. 2007d. Standard. U.S. Environmental Protection Agency. Code of Federal Regulations. 61 CFR 92. [http://edocket.access.gpo.gov/cfr\\_2007/julqtr/pdf/40cfr61.92.pdf](http://edocket.access.gpo.gov/cfr_2007/julqtr/pdf/40cfr61.92.pdf). June 25, 2008.
- \*EPA. 2007e. Standard. U.S. Environmental Protection Agency. Code of Federal Regulations. 61 CFR 192. [http://edocket.access.gpo.gov/cfr\\_2007/julqtr/pdf/40cfr61.192.pdf](http://edocket.access.gpo.gov/cfr_2007/julqtr/pdf/40cfr61.192.pdf). June 25, 2008.

## 9. REFERENCES

- \*EPA. 2007f. Standard. U.S. Environmental Protection Agency. Code of Federal Regulations. 61 CFR 202. [http://edocket.access.gpo.gov/cfr\\_2007/julqtr/pdf/40cfr61.202.pdf](http://edocket.access.gpo.gov/cfr_2007/julqtr/pdf/40cfr61.202.pdf). June 25, 2008.
- \*EPA. 2007g. Standard. Code of Federal Regulations. U.S. Environmental Protection Agency. 61 CFR 222. [http://edocket.access.gpo.gov/cfr\\_2007/julqtr/pdf/40cfr61.222.pdf](http://edocket.access.gpo.gov/cfr_2007/julqtr/pdf/40cfr61.222.pdf). June 25, 2008.
- \*EPA. 2007h. Standard. Code of Federal Regulations. U.S. Environmental Protection Agency. 61 CFR 252. [http://edocket.access.gpo.gov/cfr\\_2007/julqtr/pdf/40cfr61.252.pdf](http://edocket.access.gpo.gov/cfr_2007/julqtr/pdf/40cfr61.252.pdf). June 25, 2008.
- \*EPA. 2007i. Emission standard. Code of Federal Regulations. 40 CFR 61.122 [http://edocket.access.gpo.gov/cfr\\_2007/julqtr/pdf/40cfr61.122.pdf](http://edocket.access.gpo.gov/cfr_2007/julqtr/pdf/40cfr61.122.pdf). June 26, 2008.
- \*EPA. 2007j. Provisions. Code of Federal Regulations. 40 CFR 192.41 U.S. Environmental Protection Agency. [http://edocket.access.gpo.gov/cfr\\_2006/julqtr/pdf/40cfr192.41.pdf](http://edocket.access.gpo.gov/cfr_2006/julqtr/pdf/40cfr192.41.pdf). June 26, 2008.
- \*EPA. 2007k. A citizen's guide to radon: The guide to protecting yourself and your family from radon. U.S. Environmental Protection Agency. <http://www.epa.gov/radon/pubs/citguide.html>. August 28, 2008.
- \*EPA. 2008a. Designation of hazardous substances. U.S. Environmental Protection Agency. Code of Federal Regulations. 40 CFR 302.4. <http://www.epa.gov/lawsregs/search/40cfr.html>.
- EPA. 2008b. Radon. U.S. Environmental Protection Agency. <http://www.epa.gov/radon/>. May 13, 2008.
- \*EPA. 2008c. More action needed to protect public from indoor radon risks. Report No. 08-P-0174. Washington, DC: U.S. Environmental Protection Agency.
- \*Ericson JE, Pham PG. 2001. Radon levels in combustion stream of a natural gas incinerator power plant. *Bull Environ Contam Toxicol* 66(1):59-63.
- Etherington DJ, Pheby DF, Bray FI. 1996. An ecological study of cancer incidence and radon levels in South West England. *Eur J Cancer* 32A(7):1189-1197.
- \*European Commission. 1995. European collaborative action. Indoor air quality and its impact on man. Environment and quality of life. Report no. 15. Radon in indoor air. Luxembourg: European Commission. [http://www.inive.org/medias/ECA/ECA\\_Report15.pdf](http://www.inive.org/medias/ECA/ECA_Report15.pdf). August 28, 2008.
- European Community. 2003. Quantification of lung cancer risk after low radon exposure and low exposure rate: Synthesis from epidemiological and experimental data. European Community under the Fifth Programme (1998-2002). [http://net-science.irsn.org/net-science/liblocal/docs/docs\\_DRPH/uminers\\_an\\_data\\_sum.pdf](http://net-science.irsn.org/net-science/liblocal/docs/docs_DRPH/uminers_an_data_sum.pdf). April 07, 2008.
- \*Evans HH. 1991. Cellular and molecular effects of radon and other alpha particle emitters. In: Obe G, ed. *Advances in mutagenesis research*. Vol. 3. Berlin, Germany: Springer-Verlag, 28-52.
- \*Evans HH. 1992. Relationship of the cellular and molecular effects of alpha-particle irradiation to radon-induced lung cancer. *Indoor radon and lung cancer: Reality or myth?* Twenty-ninth Hanford Symposium on health and the environment, October 15-19, 1990. Columbus, OH: Battelle Press, 537-552.

## 9. REFERENCES

- \*Evans HH, Mencl J, Bakale G, et al. 1993a. Interlaboratory comparison of the effects of radon on L5178Y cells: Dose contribution of radon daughter association with cells. *Radiat Res* 136(1):48-56.
- \*Evans HH, Mencl J, Hui TE, et al. 1993b. Cytotoxic and mutagenic effects of radon and radon daughters on murine L5178Y lines differing in DNA repair. *Radiat Res* 136(1):57-64.
- Evrard AS, Hémon D, Billon S, et al. 2005. Ecological association between indoor radon concentration and childhood leukaemia incidence in France, 1990-1998. *Eur J Cancer Prev* 14(2):147-157.
- Fabrikant JJ. 1990. Shelter and indoor air in the twenty-first century--radon, smoking, and lung cancer risks. *Environ Health Perspect* 86:275-280.
- Fakir H, Hofmann W, Caswell RS, et al. 2005. Microdosimetry of inhomogeneous radon progeny distributions in bronchial airways. *Radiat Prot Dosimetry* 113(2):129-139.
- Fakir H, Hofmann W, Caswell RS. 2008. Radon progeny microdosimetry in human and rat bronchial airways: The effect of crossfire from the alveolar region. *Radiat Prot Dosimetry* [Epub ahead of print].
- \*FEDRIP. 2008. Radon. Federal Research in Progress database. Springfield, VA: National Technical Information Service.
- Fernau A, Smereker H. 1933. Über das verbleiben radioaktiver substanz im organismus bei radium-emanationstrinkkuren. *Strahlentherapie* 46:365-373.
- \*Field RW. 1999. Radon occurrence and health risk. Iowa City, IA: University of Iowa. [http://www.cheec.uiowa.edu/misc/radon\\_occ.pdf](http://www.cheec.uiowa.edu/misc/radon_occ.pdf). August 28, 2008.
- Field RW. 2001. A review of residential radon case-control epidemiologic studies performed in the United States. *Rev Environ Health* 16(3):151-167.
- Field RW. 2003. Exposure to residential radon causes lung cancer. For the proposition. (Comment in: *Med Phys* 30(4):486-488). *Med Phys* 30(4):485-486.
- \*Field RW. 2005. Three Mile Island epidemiologic radiation dose assessment revisited: 25 years after the accident. *Radiat Prot Dosimetry* 113(2):214-217.
- Field RW, Kross BC. 1996. Intercomparison of waterborne <sup>222</sup>Rn collection methods: Professional vs. homeowner collection. *Ground Water Monit Remed* 16:106-112.
- \*Field RW, Kross BC. 1998. Iowa survey of waterborne <sup>222</sup>Rn concentrations in private wells. *Health Phys* 74(2):249-252.
- Field RW, Fisher EL, Valentine RL, et al. 1995. Radium-bearing pipe scale deposits: Implications for national waterborne radon sampling methods. *Am J Public Health* 85:567-570.
- Field RW, Krewski D, Lubin JH, et al. 2006. An overview of the North American residential radon and lung cancer case-control studies. *J Toxicol Environ Health A* 69(7):599-631.
- Field RW, Kross BC, Weih LM, et al. 1993. Factors associated with elevated <sup>222</sup>Rn levels in Iowa. *Health Phys* 65(2):178-184.

## 9. REFERENCES

Field RW, Smith BJ, Lynch CF. 1999a. Cohen's paradox. (Comment on: Health Phys 76(4):439-440). Health Phys 77(3):328-329.

\*Field RW, Smith BJ, Steck DJ, et al. 2002. Residential radon exposure and lung cancer: Variation in risk estimates using alternative exposure scenarios. J Expo Anal Environ Epidemiol 12(3):197-203.

\*Field RW, Steck DJ, Lynch CF, et al. 1996. Residential radon-222 exposure and lung cancer: Exposure assessment methodology. J Expo Anal Environ Epidemiol 6(2):181-195.

Field RW, Steck DJ, Neuberger JS. 1997. Accounting for random error in radon exposure assessment. (Comment on: Health Phys 72(2):269-276). Health Phys 73(1):272-273.

\*Field RW, Steck DJ, Parkhurst MA, et al. 1999b. Intercomparison of retrospective radon detectors. Environ Health Perspect 107(11):905-910.

\*Field RW, Steck DJ, Smith BJ, et al. 2000. Residential radon gas exposure and lung cancer: The Iowa Radon Lung Cancer Study. (Comment in: Am J Epidemiol 152(9):895-896). Am J Epidemiol 151(11):1091-1102.

\*Field RW, Steck DJ, Smith BJ, et al. 2001. The Iowa radon lung cancer study - phase I: Residential radon gas exposure and lung cancer. Sci Total Environ 272(1-3):67-72.

\*Filipy R, Stuart B, Palmer R, et al. 1974. The effects of inhaled uranium mine air contaminants in beagle dogs. In: Karbe E, Park J, eds. Experimental lung cancer. Carcinogenesis and bioassays. New York, NY: Springer-Verlag, 403-410.

Finkelstein MM. 1995. Silicosis, radon, and lung cancer risk in Ontario miners. Health Phys 69(3):396-399.

Finkelstein MM. 1996. Clinical measures, smoking, radon exposure, and risk of lung cancer in uranium miners. Occup Environ Med 53(10):697-702.

Fisenne I. 1987. Radon concentrations at Chester, New Jersey and New York City. Personal communication. Environmental Measurements Laboratory. New York, NY. (As cited in NCRP 1987)

\*Fishbein L. 1992. Exposure from occupational versus other sources. Scand J Work Environ Health 18(1):5-16.

Fisher EL, Field RW, Smith BJ, et al. 1998. Spatial variation of residential radon concentrations: The Iowa radon lung cancer study. Health Phys 75(5):506-513.

\*Fisher EL, Fuortes LJ, Field RW. 1996. Occupational exposure of water-plant operators to high concentrations of radon-222 gas. J Occup Environ Med 38(8):759-764.

\*Fitzgerald B, Hopke PK, Datye V, et al. 1997. Experimental assessment of the short- and long-term effects of <sup>222</sup>Rn from domestic shower water on the dose burden incurred in normally occupied homes. Environ Sci Technol 31:1822-1829.

\*Fleischer R. 1986. A possible association between lung cancer and a geological outcrop. Health Phys 50:823-827.

## 9. REFERENCES

- \*Fomon SJ. 1966. Body composition of the infant: Part I: The male reference infant. In: Falkner F, ed. Human development. Philadelphia, PA: WB Saunders, 239-246.
- \*Fomon SJ, Haschke F, Ziegler EE, et al. 1982. Body composition of reference children from birth to age 10 years. *Am J Clin Nutr* 35(Suppl 5):1169-1175.
- Forastiere F, Sperati A, Cherubini G, et al. 1998. Adult myeloid leukaemia, geology, and domestic exposure to radon and gamma radiation: A case control study in central Italy. *Occup Environ Med* 55(2):106-110.
- Foreman ME, McCoy LS, Frazier ME. 1992. Involvement of oncogenes in radon-induced lung tumors in rats. Indoor radon and lung cancer: Reality or myth? Twenty-ninth Hanford Symposium on health and the environment, October 15-19, 1990. Columbus, OH: Battelle Press, 649-655.
- \*Fox A, Goldblatt P, Kinlen L. 1981. A study of the mortality of Cornish tin miners. *Br J Ind Med* 38:378-380.
- FRC. 1960. Radiation protection guidance for federal agencies. Federal Radiation Council. *Fed Regist* 60:4402-4403.
- \*Fronka A, Moucka L, Jerabek M. 2008. Detection properties of a measuring system for a continuous soil radon concentrations monitoring. *Radiat Prot Dosimetry* 130(1):56-59.
- \*Fry F, Smith-Briggs J, O'Riordan M. 1983. Skeletal lead-210 as an index of exposure to radon decay products in mining. *Br J Ind Med* 40:58-60.
- Fu H, Gu XQ. 1991. Excess risk of lung cancer among metal miners. *J Occup Med* 3(2):71-74.
- \*Fujiyoshi R, Morimoto H, Sawamura S. 2002. Investigation of the soil radon variation during the winter months in Sapporo, Japan. *Chemosphere* 47(4):369-373.
- Furrer D, Cramer R, Burkart W. 1991. Dynamics of Rn transport from the cellar to the living area in an unheated house. *Health Phys* 60(3):393-398.
- \*Furuno K. 1979. [Applications of radioactive spring water and excretion of radon in the expired air.] *Okayama Daigaku Onsen Kenkyusho Hokoku* 49:1-6. (Japanese)
- \*Geiger EL. 1967. Radon film badge. *Health Phys* 13(4):407-411.
- \*George AC. 1988. Instruments and methods for measuring indoor radon and radon progeny concentrations. In: Makofske WJ, Edelstein MR, eds. *Radon and the environment*. Park Ridge, NJ: Noyes Publications, 118-136.
- \*George A, Breslin A. 1967. Deposition of natural radon daughters in human subjects. *Health Phys* 13:375-378.
- \*George A, Breslin A. 1969. Deposition of radon daughters in humans exposed to uranium mine atmospheres. *Health Phys* 17:115-124.
- Geraskin SA, Kim JK, Oudalova AA, et al. 2005. Bio-monitoring the genotoxicity of populations of Scots pine in the vicinity of a radioactive waste storage facility. *Mutat Res* 583(1):55-66.

## 9. REFERENCES

- Geraskin SA, Zimina LM, Dikarev VG, et al. 2003. Bioindication of the anthropogenic effects on micropopulations of *Pinus sylvestris*, L. in the vicinity of a plant for the storage and processing of radioactive waste and in the Chernobyl NPP zone. *J Environ Radioact* 66(1-2):171-180.
- Gerken M, Kreienbrock L, Wellmann J, et al. 2000. Models for retrospective quantification of indoor radon exposure in case-control studies. *Health Phys* 78(3):268-278.
- \*Gesell T. 1983. Background atmospheric <sup>222</sup>Rn concentrations outdoors and indoors: A review. *Health Phys* 45:289-302.
- Gies R, Cross F, Dagle G. 1987. A histologic study of the influence of cigarette smoking in suppressing Rn daughter carcinogenesis in dogs. *Health Phys* 53:527-529.
- \*Gilbert ES, Cross FT, Dagle GE. 1996. Analysis of lung tumor risks in rats exposed to radon. *Radiat Res* 145(3):350-360.
- \*Giwerzman A, Carlsen E, Keiding N, et al. 1993. Evidence for increasing incidence of abnormalities of the human testis: A review. *Environ Health Perspect Suppl* 101(2):65-71.
- \*Gosink TA, Baskaran M, Holleman DF. 1990. Radon in the human body from drinking water. *Health Phys* 59(6):919-924.
- \*Gotchy R, Schiager K. 1969. Bioassay methods for estimating current exposures to short-lived radon progeny. *Health Phys* 17:199-218.
- \*Gottlieb L, Husen L. 1982. Lung cancer among Navajo uranium miners. *Chest* 81:449-452.
- Goyer N. 1990. Chemical contaminants in office buildings. *Am Ind Hyg Assoc J* 51:615-619.
- Grasty RL. 1994. Summer outdoor radon variations in Canada and their relation to soil moisture. *Health Phys* 66(2):185-193.
- Green BMR, Cliff KD, Miles JCH, et al. 1992. Radon studies in UK homes. *Radiat Prot Dosimetry* 45(1):519-522.
- \*Greenland S, Morgenstern H. 1989. Ecological bias, confounding, and effect modification. *Int J Epidemiol* 18(1):269-274.
- Groch KM, Khan MA, Brooks AL, et al. 1997. Lung cancer response following inhaled radon in the A/J and C57BL/6J mouse. *Int J Radiat Biol* 71(3):301-308.
- Grosche B, Kreuzer M, Kreisheimer M, et al. 2006. Lung cancer risk among German male uranium miners: A cohort study, 1946-1998. *Br J Cancer* 95(9):1280-1287.
- Gudernatsch J, Bagg H. 1920. Disturbances in the development of mammalian embryos caused by radium emanation. *Proc Soc Exp Biol Med* 17:183-187.
- Gunby JA, Darby SC, Miles JC, et al. 1993. Factors affecting indoor radon concentrations in the United Kingdom. *Health Phys* 64(1):2-12.



## 9. REFERENCES

- Gustavsson P, Jakobsson R, Nyberg F, et al. 2000. Occupational exposure and lung cancer risk: A population-based case-referent study in Sweden. *Am J Epidemiol* 152(1):32-40.
- \*Guyton A. 1977. Physiologic peculiarities of specific pulmonary abnormalities. In: *Basic human physiology*. Philadelphia, PA: W.B. Saunders Company, 434-438.
- \*Guzelian PS, Henry CJ, Olin SS, eds. 1992. *Similarities and differences between children and adults: Implications for risk assessment*. Washington, DC: International Life Sciences Institute Press.
- Haque AKMM. 1990. Effects of inhalation of radon daughters in the lungs. In: Majumdar SK, Schmalz RF, Miller EW, eds. *Environmental radon: Occurrence, control and health hazards*. Easton, PA: Pennsylvania Academy of Science, 282-303.
- \*Harley J. 1973. Environmental radon. In: Stanley R, Moghissi A, eds. *Noble gases*. Washington, DC: U.S. Energy Development and Research Agency, National Environmental Research Center, CONF-730915, 109-114.
- Harley NH. 1991a. Methodology issues in risk assessment for radon. *Environ Health Perspect* 90:177-180.
- Harley NH. 1991b. Radon levels in a high-rise apartment. *Health Phys* 61(2):263-265.
- \*Harley N, Pasternack B. 1982. Environmental radon daughter alpha dose factors in a five-lobed human lung. *Health Phys* 42:789-799.
- \*Harley NH, Robbins ES. 1994. A biokinetic model for <sup>222</sup>Rn gas distribution and alpha dose in humans following ingestion. *Environ Int* 20(5):605-610.
- \*Harley JH, Jetter ES, Nelson N. 1994. Elimination of Rn-222 from the body. *Environ Int* 20:573-584.
- \*HazDat. 2008. Radon. HazDat Database: ATSDR's Hazardous Substance Release and Health Effects Database. Atlanta, GA: Agency for Toxic Substances and Disease Registry. <http://www.atsdr.cdc.gov/hazdat.html>. May 10, 2008.
- Hazelton WD, Luebeck EG, Heidenreich WF, et al. 2001. Analysis of a historical cohort of Chinese tin miners with arsenic, radon, cigarette smoke, and pipe smoke exposures using the biologically based two-stage clonal expansion model. *Radiat Res* 156(1):78-94.
- Heath CW, Bond PD, Hoel DG, et al. 2004. Residential radon exposure and lung cancer risk: Commentary on Cohen's county-based study. *Health Phys* 87(6):647-655, discussion 656-658.
- Hei TK, Bedford J, Waldren CA. 1994a. 53 Mutation hotspot in radon-associated lung cancer. (Comment on: *Lancet* 343(8889):86-87). *Lancet* 343(8906):1158-1159.
- Hei TK, Piao CQ, Willey JC, et al. 1994b. Malignant transformation of human bronchial epithelial cells by radon-simulated alpha-particles. *Carcinogenesis* 15(3):431-437.
- Heid IM, Küchenhoff H, Miles J, et al. 2004. Two dimensions of measurement error: Classical and Berkson error in residential radon exposure assessment. *J Expo Anal Environ Epidemiol* 14(5):365-377.

## 9. REFERENCES

- Heid IM, Küchenhoff H, Rosario AS, et al. 2006. Impact of measurement error in exposures in German radon studies. *J Toxicol Environ Health A* 69(7):701-721.
- Heid IM, Küchenhoff H, Wellmann J, et al. 2002. On the potential of measurement error to induce differential bias on odds ratio estimates: An example from radon epidemiology. *Stat Med* 21(21):3261-3278.
- Heidenreich WF, Paretzke HG. 2004. Interpretation by modelling of observations in radon radiation carcinogenesis. *Radiat Prot Dosimetry* 112(4):501-507.
- Heidenreich WF, Brugmans MJ, Little MP, et al. 2000. Analysis of lung tumour risk in radon-exposed rats: An intercomparison of multi-step modelling. *Radiat Environ Biophys* 39(4):253-264.
- Heidenreich WF, Collier C, Morlier JP, et al. 2004a. Age-adjustment in experimental animal data and its application to lung cancer in radon-exposed rats. *Radiat Environ Biophys* 43(3):183-188.
- Heidenreich WF, Jacob P, Paretzke HG, et al. 1999. Two-step model for the risk of fatal and incidental lung tumors in rats exposed to radon. *Radiat Res* 151(2):209-217.
- Heidenreich WF, Tomasek L, Rogel A, et al. 2004b. Studies of radon-exposed miner cohorts using a biologically based model: Comparison of current Czech and French data with historic data from China and Colorado. (Comment in: *Radiat Environ Biophys* 44(2):149-151, author reply 153-154; 44(2):155-156). *Radiat Environ Biophys* 43(4):247-256.
- \*Hellman B, Friis L, Vaghef H, et al. 1999. Alkaline single cell gel electrophoresis and human biomonitoring for genotoxicity: A study on subjects with residential exposure to radon. *Mutat Res* 442(2):121-132.
- Henshaw D. 1991. Radon and leukaemia. *Leukemia* 5(9):826-827.
- Henshaw DL, Eatough JP, Richardson RB. 1990. Radon as a causative factor in induction of myeloid leukaemia and other cancers. (Comment in: *Lancet* 335(8701):1336-1340; 337(8739):503-504; 338(8781):1537-1538). *Lancet* 335(8696):1008-1012.
- \*Hess C, Michel J, Horton T, et al. 1985. The occurrence of radioactivity in public water supplies in the United States. *Health Phys* 48(5):553-586.
- \*Hess C, Weiffenbach C, Norton S. 1983. Environmental radon and cancer correlations in Maine. *Health Phys* 45(2):339-348.
- Hodgson JT, Jones RD. 1990a. Corrections for mortality of a cohort of tin miners 1941-86. (Erratum to: *Br J Ind Med* 47(10):665-676). *Br J Ind Med* 47(12):846.
- \*Hodgson JT, Jones RD. 1990b. Mortality of a cohort of tin miners 1941-1986. (Erratum in: *Br J Ind Med* 47(12):846). *Br J Ind Med* 47(10):665-676.
- \*Hoel DG, Davis DL, Miller AB, et al. 1992. Trends in cancer mortality in 15 industrialized countries, 1969-1986. *J Natl Cancer Inst* 84(5):313-320.
- Hofmann W, Balashazy I, Heistracher T, et al. 1996. The significance of particle deposition patterns in bronchial airway bifurcations for extrapolation modeling. *Aerosol Sci Technol* 25(3):305-327.

## 9. REFERENCES

- Hofmann W, Crawford-Brown DJ, Fakir H, et al. 2002. Energy deposition, cellular radiation effects and lung cancer risk by radon progeny alpha particles. *Radiat Prot Dosimetry* 99(1-4):453-456.
- Hofmann W, Crawford-Brown DJ, Ménache MG, et al. 1991. Carcinogenic risk of non-uniform alpha particle irradiation in the lungs: Radon progeny effects at bronchial bifurcations. *Radiat Prot Environ* 38(1):91-97.
- Hofmann W, Fakir H, Pihet P. 2007. Internal microdosimetry of inhaled radon progeny in bronchial airways: Advantages and limitations. *Radiat Prot Dosimetry* [Epub ahead of print].
- Hofmann W, Johnson JR, Freedman N. 1990. Lung dosimetry of thorotrast patients. *Health Phys* 59(6):777-790.
- Hofmann W, Ménache MG, Graham RC. 1993. Radon progeny dosimetry in the rat lung. *Health Phys* 64(3):279-290.
- \*Hofmann W, Steinhausler F, Pohl E. 1979. Dose calculations for the respiratory tract from inhaled natural radioactive nuclides as a function of age. I. *Health Phys* 37:517-532.
- \*Hollcroft J, Lorenz E. 1949. Retention of radon by the mouse. I. Experimental determination of biodecay and energy absorbed. *Nucleonics* 9:63-71.
- \*Hollcroft J, Lorenz E, Matthews M, et al. 1955. Long-term survival following X irradiation and the irradiation of the alpha particles from radon and its decay products. *J Natl Cancer Inst* 15:1059-1067.
- \*Holleman D, Martz D, Schiager K. 1969. Total respiratory deposition of radon daughters from inhalation of uranium mine atmospheres. *Health Phys* 17:187-192.
- Holaday DA. 1955. The radon problem in deep-level mining. *AMA Arch Ind Health* 12(2):163-166.
- Holaday DA. 1969. History of the exposure of miners to radon. *Health Phys* 16:547-552.
- Holloway C, Turner J. 1981. Guide to literature on the dosimetry, metabolism, pathology, epidemiology and environmental aspects of radon, its daughters and its parents. Oak Ridge, TN: Oak Ridge National Laboratory. ORNL/CF-81/276.
- \*Hopke P. 1987. The indoor radon problem explained for the layman. In: Hopke P, ed. *Radon and its decay products*. Washington, DC: American Chemical Society, 572-586.
- \*Hornung R, Meinhardt T. 1987. Quantitative risk assessment of lung cancer in U.S. uranium miners. *Health Phys* 52:417-430.
- \*Hornung RW, Deddens J, Roscoe R. 1995. Modifiers of exposure-response estimates for lung cancer among miners exposed to radon progeny. *Environ Health Perspect Suppl* 103:49-53.
- \*Hornung RW, Deddens JA, Roscoe RJ. 1998. Modifiers of lung cancer risk in uranium miners from the Colorado Plateau. *Health Phys* 74(1):12-21.
- \*Howe GR, Stager RH. 1996. Risk of lung cancer mortality after exposure to radon decay products in the Beaverlodge cohort based on revised exposure estimates. *Radiat Res* 146(1):37-42.

## 9. REFERENCES

- \*Howe GR, Nair R, Newcombe H, et al. 1986. Lung cancer mortality (1950-80) in relation to radon daughter exposure in a cohort of workers at the Eldorado Beaverlodge uranium mine. *J Natl Cancer Inst* 77:357-362.
- \*Howe GR, Nair R, Newcombe H, et al. 1987. Lung cancer mortality (1950-80) in relation to radon daughter exposure in a cohort of workers at the Eldorado Port Radium uranium mine: Possible modification of risk by exposure rate. *J Natl Cancer Inst* 79:1255-1260.
- \*HSDB. 2008. Radon, radioactive. Hazardous Substances Data Bank. National Library of Medicine. <http://toxnet.nlm.nih.gov>. June 25, 2008.
- \*Hursh JB, Mercer TT. 1970. Measurement of  $^{212}\text{Pb}$  loss rate from human lungs. *J Appl Physiol* 28:268-274.
- \*Hursh JB, Schraub A, Sattler EL, et al. 1969a. Fate of  $^{212}\text{Pb}$  inhaled by human subjects. *Health Phys* 16:257-267.
- \*Hursh JB, Neuman WR, Toribara T, et al. 1969b. Oral ingestion of uranium by man. *Health Phys* 17:619-621.
- \*Hursh J, Morken D, Davis T, et al. 1965. The fate of radon ingested by man. *Health Phys* 11:465-476.
- \*Hwang S, Lein RD, Morgan DA. 2005. Noble gases. In: Kirk-Othmer encyclopedia of chemical technology. John Wiley & Sons. <http://mrw.interscience.wiley.com/emrw/9780471238966/kirk/article/gasehwan.a01/current/pdf>. May 13, 2008.
- \*IAEA. 2004. The long-term stabilisation of uranium mill tailings. Final report on the co-ordinated research project 2000-2004. Vienna, Austria: International Atomic Energy Agency. IAEA-TECDOC-1403. <http://www-pub.iaea.org/MTCD/publications/PubDetails.asp?pubId=7054>. August 26, 2008.
- IARC. 1988. IARC monographs on the evaluation of carcinogenic risks to humans. Man-made mineral fibers and radon. Lyon, France: International Agency for Research on Cancer 43:189.
- \*IARC. 2008. Agents reviewed by the IARC monographs: Vol. 1-99. Lyon, France: International Agency for Research on Cancer. <http://monographs.iarc.fr/ENG/Classification/index.php>. April 24, 2008.
- ICRP. 1966. Deposition and retention models for internal dosimetry of the human respiratory tract. Task Group on Lung Dynamics for Committee II of the International Commission on Radiological Protection. International Commission on Radiological Protection. *Health Phys* 12:173-207.
- \*ICRP. 1975. Report of the Task Group on Reference Man. ICRP Publication 23. New York, NY: International Commission on Radiological Protection. Pergamon Press.
- \*ICRP. 1977. Recommendations of the International Commission on Radiological Protection. ICRP Publication No. 26. New York, NY: International Commission on Radiological Protection. Pergamon Press.

## 9. REFERENCES

- \*ICRP. 1978. Limits for inhaled radionuclides by workers. ICRP Publication 23. New York, NY: International Commission on Radiological Protection. Pergamon Press.
- \*ICRP. 1979. Limits for intakes of radionuclides by workers. ICRP Publication 30 Part 1. New York, NY: International Commission on Radiological Protection. Pergamon Press.
- \*ICRP. 1980. Limits for intakes of radionuclides by workers. ICRP Publication 30 Part 2. New York, NY: International Commission on Radiological Protection. Pergamon Press.
- \*ICRP. 1982. Limits for inhalation of radon daughters by workers. ICRP Publication 32. New York, NY: International Commission on Radiological Protection. Pergamon Press.
- ICRP. 1988. Lung cancer risk from indoor exposures to radon daughters: ICRP publication 50. *J Radiol Prot* 8(1):55.
- \*ICRP. 1990. Age-dependent doses to members of the public from intake of radionuclides, Part 1. ICRP Publication 56. Elmsford, NY: International Commission on Radiological Protection. Pergamon Press, 6-12.
- \*ICRP. 1994a. Protection against radon-222 at home and at work. ICRP Publication 65. Vol. 23, No. 2. Tarrytown, NY: International Commission on Radiological Protection. Elsevier Science, Inc.
- \*ICRP. 1994b. Human respiratory tract model for radiological protection. Oxford: International Commission on Radiological Protection. Pergamon Press.
- \*ICRP. 1994c. Age-dependent doses to members of the public from intake of radionuclides. Part 2. Ingestion dose coefficients. ICRP Publication 67. Tarrytown, NY: International Commission on Radiological Protection. Elsevier Sciences, Inc., 75-84.
- \*ICRP. 1995. Dose coefficients for intakes of radionuclides by workers. ICRP Publication 68. Tarrytown, NY: International Commission on Radiological Protection. Elsevier Science Inc., 1-13, 64-65.
- \*ICRP. 1996a. Age-dependent doses to members of the public from intake of radionuclides: Part 4. Inhalation dose coefficients. Publication No. 71. Tarrytown, NY: Elsevier Science Inc., 9-23, 328-345.
- ICRP. 1996b. Age-dependent doses to members of the public from intake of radionuclides: Part 5. Compilation of ingestion and inhalation dose coefficients. Publication No. 72. Tarrytown, NY: Elsevier Science Inc., 3-13, 38-39, 75-77.
- \*ICRP. 2001. Bismuth, lead, polonium. The ICRP database of dose coefficients workers and members of the public. Version 2.01. International Commission on Radiological Protection. Elsevier Science Ltd.
- \*IRIS. 2008. Radon-222. Integrated Risk Information System. Washington, DC: U.S. Environmental Protection Agency. <http://www.epa.gov/iris/subst/index.html>. April 24, 2008.
- Ishikawa Y, Mori T, Kato Y, et al. 1992. Lung cancers associated with thorotrast exposure: High incidence of small-cell carcinoma and implications for estimation of radon risk. *Int J Cancer* 52(4):570-574.

## 9. REFERENCES

- \*Ishikawa T, Narazaki Y, Yasuoka Y, et al. 2003b. Bio-kinetics of radon ingested from drinking water. *Radiat Prot Dosimetry* 105(1-4):65-70.
- \*Ishikawa T, Yamada Y, Fukutsu K, et al. 2003a. Deposition and clearance for radon progeny in the human respiratory tract. *Radiat Prot Dosimetry* 105(1-4):143-148.
- Ishimori Y. 2007. Time-integrated monitoring of radon progeny around a closed uranium mine in Japan. *J Environ Radioact* 93(1):51-61.
- \*Israeli M. 1985. Deposition rates on Rn progeny in houses. *Health Phys* 49:1069-1083.
- \*Jacobi W. 1964. The dose to the human respiratory tract by inhalation of short-lived  $^{222}\text{Rn}$ - and  $^{220}\text{Rn}$ -decay products. *Health Phys* 10:1163-1175.
- Jacobi W. 1972. Relations between the inhaled potential alpha-energy of  $^{222}\text{Rn}$ - and  $^{222}\text{Rn}$ -daughters and the absorbed alpha-energy in the bronchial and pulmonary region. *Health Phys* 23:3-11.
- Jagger J. 1994. Reply to Stidley and Samet. (Comment on: *Health Phys* 65(3):234-251). *Health Phys* 66(2):212.
- \*Jaki S, Hess V. 1958. Study of the distribution radon, thoron and their decay products above and below the ground. *J Geophys Res* 63:373-390.
- \*James A. 1987. A reconsideration of cells at risk and other key factors in radon daughter dosimetry. In: Hopke P, ed. *Radon and its decay products: Occurrence, properties and health effects*. ACS Symposium Series 331. Washington, DC: American Chemical Society, 400-418.
- \*James AC, Birchall A, Akabani G. 2004. Comparative dosimetry of BEIR VI revisited. *Radiat Prot Dosimetry* 108(1):3-26.
- \*James AC, Stahlhofen W, Rudolf G, et al. 1994. Deposition of inhaled particles. *Ann ICRP* 24:231-299.
- \*Jin Y, Yie TA, Carothers AM. 1995. Non-random deletions at the dihydrofolate reductase locus of Chinese hamster ovary cells induced by alpha-particles simulating radon. *Carcinogenesis* 16(8):1981-1991.
- \*Johanson CE. 1980. Permeability and vascularity of the developing brain: Cerebellum vs cerebral cortex. *Brain Res* 190(1):3-16.
- Johnson NF, Newton GJ. 1994. Estimation of the dose of radon progeny to the peripheral lung and the effect of exposure to radon progeny on the alveolar macrophage. *Radiat Res* 139(2):163-169.
- Johnson NF, Newton GJ, Guilmette RA. 1992. Effects of acute radon progeny exposure on rat alveolar macrophage number and function. *Indoor radon and lung cancer: Reality or myth? Twenty-ninth Hanford Symposium on health and the environment, October 15-19, 1990*. Columbus, OH: Battelle Press, 627-636.
- \*Johnston PN, Hult M, Gasparro J, et al. 2005. The distribution of  $^{210}\text{Pb}$  in human bone and its impact on methods for the retrospective estimation of  $^{222}\text{Rn}$  exposure from *in vivo* measurements. *J Environ Radioact* 80:245-257.

## 9. REFERENCES

- \*Jonassen N. 1975. On the effect of atmospheric pressure variations on the radon-222 concentration in unventilated rooms. *Health Phys* 29:216-220.
- \*Jorgensen H. 1984. Lung cancer among underground workers in the iron ore mine of Kiruna based on thirty years of observation. *Ann Acad Med Singapore* 13:371-377.
- \*Jostes RF. 1996. Genetic, cytogenetic, and carcinogenic effects of radon: A review. *Mutat Res* 340:(2-3) 125-139.
- \*Jostes RF, Fleck EW, Morgan TL, et al. 1994. Southern blot and polymerase chain reaction exon analyses of HPRT<sup>-</sup> mutations induced by radon and radon progeny. *Radiat Res* 137(3):371-379.
- Kaiser JC, Heidenreich WF, Monchaux G, et al. 2004. Lung tumour risk in radon-exposed rats from different experiments: Comparative analysis with biologically based models. *Radiat Environ Biophys* 43(3):189-201.
- Kaletsch U, Kaatsch P, Meinert R, et al. 1999. Childhood cancer and residential radon exposure- results of a population-based case-control study in Lower Saxony (Germany). *Radiat Environ Biophys* 38(3):211-215.
- Kellington JP, Eldred TM, Ambrose K, et al. 1997. Effects of radiation quality on lung tumour induction in CBA/Ca mice. Proceedings of international conference on the health effects of low level radiation. London, England: BNED, 44-51.
- \*Kendall GM, Smith TJ. 2002. Doses to organs and tissues from radon and its decay products. *J Radiol Prot* 22:389-406
- \*Kendall GM, Smith TJ. 2005. Doses from radon and its decay products to children. *J Radiol Prot* 25(3):241-256.
- Kennel SJ, Lankford T, Garland M, et al. 2005. Biodistribution of <sup>225</sup>Ra citrate in mice: Retention of daughter radioisotopes in bone. *Nucl Med Biol* 32(8):859-867.
- Khan AJ. 1994. Estimation of dose rate for indoor radon from building materials. *Radiat Environ Biophys* 33(1):81-84.
- \*Khan AJ, Phillips C. 1984. Electrets for passive radon daughter dosimetry. *Health Phys* 46:141-149.
- \*Khan MA, Cross FT, Buschbom RL, et al. 1995. Inhaled radon-induced genotoxicity in Wistar rat, Syrian hamster, and Chinese hamster deep-lung fibroblasts *in vivo*. *Mutat Res* 334(2):131-137.
- \*Khan MA, Cross FT, Jostes R, et al. 1994. Micronuclei induced by radon and its progeny in deep-lung fibroblasts of rats *in vivo* and *in vitro*. *Radiat Res* 139(1):53-59.
- \*Khursheed A. 2000. Doses to systemic tissues from radon gas. *Radiat Prot Dosimetry* 88(2):171-181.
- Kildea PM, Lee TC. 1996. Radon plateout on synthetic fibers as a possible risk factor in breast cancer. (Comment in: *Risk Anal* 16(6):729-730). *Risk Anal* 16(1):1-2.

## 9. REFERENCES

- Kim DW, Kim KY, Choi BS, et al. 2007. Regulation of metal transporters by dietary iron, and the relationship between body iron levels and cadmium uptake. *Arch Toxicol* 81(5):327-334.
- \*Kinsara AA, Loyalka SK, Tompson RV, et al. 1995. Deposition patterns of molecular phase radon progeny ( $^{218}\text{Po}$ ) in lung bifurcations. *Health Phys* 68(3):371-382.
- \*Kitto ME. 2003. Assessing radon concentrations in areas with few measurements. *Environ Monit Assess* 83(2):163-175.
- \*Kitto ME, Kuhland MK, Dansereau RE. 1996. Direct comparison of three methods for the determination of radon in well water. *Health Phys* 70(3):358-362.
- \*Klaassen C, Amdur M, Doull J. 1986. Casarett and Doull's toxicology. 3rd edition. New York, NY: MacMillan Publishing Company, 128.
- Klotz JB, Petix JR, Zaganiski RT. 1989. Mortality of a residential cohort exposed to radon from industrially contaminated soil. *Am J Epidemiol* 129(6):1179-1186.
- Klotz JB, Schoenberg JB, Wilcox HB. 1993. Relationship among short- and long-term radon measurements within dwellings: Influence of radon concentrations. *Health Phys* 65(4):367-374.
- Kohli S, Noorlind Brage H, Löfman O. 2000. Childhood leukaemia in areas with different radon levels: A spatial and temporal analysis using GIS. *J Epidemiol Community Health* 54(11):822-826.
- \*Komori M, Nishio K, Kitada M, et al. 1990. Fetus-specific expression of a form of cytochrome P-450 in human livers. *Biochemistry* 29(18):4430-4433.
- \*Kozak JA, Reeves HW, Lewis BA. 2003. Modeling radium and radon transport through soil and vegetation. *J Contam Hydrol* 66(3-4):179-200.
- \*Kreienbrock L, Kreuzer M, Gerken M, et al. 2001. Case-control study on lung cancer and residential radon in western Germany. *Am J Epidemiol* 153(1):42-52.
- \*Kreuzer M, Gerken M, Kreienbrock L, et al. 2001. Lung cancer in lifetime nonsmoking men: Results of a case-control study in Germany. *Br J Cancer* 84(1):134-140.
- \*Kreuzer M, Heinrich J, Kreienbrock L, et al. 2002. Risk factors for lung cancer among nonsmoking women. *Int J Cancer* 100(6):706-713.
- \*Kreuzer M, Heinrich J, Wölke G, et al. 2003. Residential radon and risk of lung cancer in Eastern Germany. *Epidemiology* 14(5):559-568.
- \*Kreuzer M, Müller KM, Brachner A, et al. 2000. Histopathologic findings of lung carcinoma in German uranium miners. *Cancer* 89(12):2613-2621.
- \*Kreuzer M, Schneizer M, Tschense A, et al. 2004. Risk of lung cancer and other cancers in the German uranium miners cohort study. <http://irpall.net/pdfs/lbl6.pdf>. June 30, 2008.
- \*Krewski D, Lubin JH, Zielinski JM, et al. 2005. Residential radon and risk of lung cancer: A combined analysis of 7 North American case-control studies. *Epidemiology* 16(2):137-145.



## 9. REFERENCES

- \*Krewski D, Lubin JH, Zielinski JM, et al. 2006. A combined analysis of North American case-control studies of residential radon and lung cancer. *J Toxicol Environ Health A* 69(7):533-597.
- \*Krishnan K, Andersen ME. 1994. Physiologically based pharmacokinetic modeling in toxicology. In: Hayes AW, ed. *Principles and methods of toxicology*. 3rd ed. New York, NY: Raven Press, Ltd., 149-188.
- \*Krishnan K, Andersen ME, Clewell HJ, et al. 1994. Physiologically based pharmacokinetic modeling of chemical mixtures. In: Yang RSH, ed. *Toxicology of chemical mixtures: Case studies, mechanisms, and novel approaches*. San Diego, CA: Academic Press, 399-437.
- \*Kronenberg A. 1994. Radiation-induced geometric instability. *Int J Radiat Biol* 66:603-609.
- Kunz E, Sevc J, Placek V. 1978. Lung cancer mortality in uranium miners (methodological aspects). *Health Phys* 35:579-580.
- Kunz E, Sevc J, Placek V, et al. 1979. Lung cancer in man in relation to different time distribution of radiation exposure. *Health Phys* 36:699-706.
- \*Kurttio P, Salonen L, Ilus T, et al. 2006. Well water radioactivity and risk of cancers of the urinary organs. *Environ Res* 102(3):333-338.
- Kushneva VS. 1959. On the problem of the long-term effects of the combined injury to animals of silicon dioxide and radon. In: Zakutinskii D, ed. *Long term effects of injuries caused by the action of ionizing radiation*. Medgiz, Moscow: State Publishers of Medical Literature, 21-28.
- \*Kusiak RA, Ritchie AC, Muller J, et al. 1993. Mortality from lung cancer in Ontario uranium miners. *Br J Ind Med* 50(10):920-928.
- Kusiak RA, Springer J, Ritchie AC, et al. 1991. Carcinoma of the lung in Ontario gold miners: Possible aetiological factors. *Br J Ind Med* 48(12):808-817.
- \*L'Abbé KA, Howe GR, Burch JD, et al. 1991. Radon exposure, cigarette smoking, and other mining experience in the Beaverlodge uranium miners cohort. *Health Phys* 60(4):489-495.
- Lachet B. 2006. Indoor radon and lung cancer. (Comment on: *Epidemiology* 15(6):709-716). *Epidemiology* 17(1):121, author reply 121-122.
- Lafuma J, Chmelevsky D, Chameaud J, et al. 1989. Lung carcinomas in Sprague-Dawley rats after exposure to low doses of radon daughters, fission neutrons, or gamma rays. *Radiat Res* 118(2):230-245.
- Lagarde F, Pershagen G. 1997. Re: Indoor radon exposure and risk of lung cancer: A nested case-control study in Finland. (Comment on: *J Natl Cancer Inst* 88(14):966-972). *J Natl Cancer Inst* 89(8):584-585.
- Lagarde F, Pershagen G. 1999. Parallel analyses of individual and ecologic data on residential radon, cofactors, and lung cancer in Sweden. (Comment in: *Am J Epidemiol* 152(2):194-195). *Am J Epidemiol* 149(3):268-274.
- \*Lagarde F, Axelsson G, Damber L, et al. 2001. Residential radon and lung cancer among never-smokers in Sweden. *Epidemiology* 12(4):396-404.

## 9. REFERENCES

- \*Lagarde F, Falk R, Almrén K, et al. 2002. Glass-based radon-exposure assessment and lung cancer risk. *J Expo Anal Environ Epidemiol* 12(5):344-354.
- \*Lagarde F, Pershagen G, Åkerblom G, et al. 1997. Residential radon and lung cancer in Sweden: Risk analysis accounting for random error in the exposure assessment. (Comment in: *Health Phys* 73(2):393; 73(2):394-395; 73(1):272-273). *Health Phys* 72(2):269-276.
- \*Lam RHF, Brown JP, Fan AM. 1994. Chemicals in California drinking water: Source of contamination, risk assessment, and drinking water standards. In: Wang RGM, ed. *Water contamination and health: Integration of exposure assessment, toxicology, and risk assessment*. New York: Marcel Dekker, Inc., 15-44.
- \*Lange K, Evans R. 1947. Absorption of radon through the skin and its exhalation through the lungs. *Radiology* 48:514-516.
- Langholz B, Borgan O. 1997a. Correction to: Estimation of absolute risk from nested case-control data. (Erratum to: *Biometrics* 53(2):767-774). *Biometrics* 59(2):451.
- Langholz B, Borgan O. 1997b. Estimation of absolute risk from nested case-control data. (Erratum in: *Biometrics* 59(2):451). *Biometrics* 53(2):767-774.
- Laurier D, Rogel A, Tomasek L, et al. 2005. Comment on "Studies of radon-exposed miner cohorts using a biologically based model: comparison of current Czech and French data with historic data from China and Colorado" by W.F. Heidenreich, L. Tomasek, A. Rogel, D. Laurier, M. Tirmarche (2004) *Radiat Environ Biophys* 43:247-256, and "Radon-induced lung cancer in French and Czech miner cohorts described with a two-mutation cancer model" by M.J.P. Brugmans, S.M. Rispens, H. Bijwaard, D. Laurier, A. Rogel, L. Tomasek, M. Tirmarche (2004) *Radiat Environ Biophys* 43:153-163. (Comment on: *Radiat Environ Biophys* 43(3):153-163; *Radiat Environ Biophys* 43(4):247-256). *Radiat Environ Biophys* 44(2):155-156.
- \*Laurier D, Tirmarche M, Mitton N, et al. 2004. An update of cancer mortality among the French cohort of uranium miners: Extended follow-up and new source of data for causes of death. *Eur J Epidemiol* 19(2):139-146.
- Laurier D, Valenty M, Tirmarche M. 2001. Radon exposure and the risk of leukemia: A review of epidemiological studies. (Comment in: *Health Phys* 86(4):425-426, author reply 427-428). *Health Phys* 81(3):272-288.
- Law GR, Kane EV, Roman E, et al. 2000. Residential radon exposure and adult acute leukaemia. *Lancet* 355(9218):1888.
- Lawrence EP, Wanty RB, Nyberg P. 1992. Contribution of <sup>222</sup>Rn in domestic water supplies to <sup>222</sup>Rn in indoor air in Colorado homes. *Health Phys* 62(2):171-177.
- Lee SC, Kim CK, Lee DM, et al. 2001. Natural radionuclides contents and radon exhalation rates in building materials used in South Korea. *Radiat Prot Dosimetry* 94(3):269-274.
- \*Leeder JS, Kearns GL. 1997. Pharmacogenetics in pediatrics: Implications for practice. *Pediatr Clin North Am* 44(1):55-77.

## 9. REFERENCES

- Leenhouts HP. 1999. Radon-induced lung cancer in smokers and non-smokers: Risk implications using a two-mutation carcinogenesis model. *Radiat Environ Biophys* 38(1):57-71.
- Lees R, Steele R, Roberts J. 1987. A case-control study of lung cancer relative to domestic radon exposure. *Int J Epidemiol* 16:7-12.
- \*Leggett RW. 1993. An age-specific kinetic model of lead metabolism in humans. *Environ Health Perspect* 101:598-616.
- \*Leggett RW, Williams LR. 1991. Suggested reference values for regional blood volumes in humans. *Health Phys* 60(2):139-154.
- \*Leggett RW, Williams LR. 1995. A proposed blood circulation model for Reference Man. *Health Phys* 69(2):187-201.
- Lehnert BE, Goodwin EH. 1997. A new mechanism for DNA alterations induced by alpha particles such as those emitted by radon and radon progeny. *Environ Health Perspect* 105(Suppl 5):1095-1101.
- \*Leonard BE. 1996. High  $^{222}\text{Rn}$  levels, enhanced surface deposition, increased diffusion coefficient, humidity, and air change effects. *Health Phys* 70(3):372-387.
- Leonard BE. 2005. The radon inverse dose rate effect and high-LET galactic hazards. *Radiat Prot Dosimetry* 115(1-4):310-315.
- Leonard BE. 2007. Examination of underground miner data for radon progeny size reduction as cause of high radon "inverse" dose rate effect. *Health Phys* 93(2):133-150.
- \*Leonard A, Delpoux M, Chameaud J, et al. 1981. Biological effects observed in mammals maintained in an area of very high natural radioactivity. *Can J Genet Cytol* 23:321-326.
- \*Létourneau EG, Krewski D, Choi NW, et al. 1994. Case-control study of residential radon and lung cancer in Winnipeg, Manitoba, Canada. (Comment in: *Am J Epidemiol* 140(4):323-332; 140(4):333-339; 142(8):884-886; 142(10):1121-1122). *Am J Epidemiol* 140(4):310-322.
- Létourneau EG, Zielinski JM, Krewski D, et al. 1992. Levels of radon gas in Winnipeg homes. *Radiat Prot Dosimetry* 45(1):531-534.
- \*Leung HW. 1993. Physiologically-based pharmacokinetic modelling. In: Ballentyne B, Marrs T, Turner P, eds. *General and applied toxicology*. Vol. 1. New York, NY: Stockton Press, 153-164.
- Leung JK, Tso MY, Ho CW. 1998. Behavior of  $^{222}\text{Rn}$  and its progeny in high-rise buildings. *Health Phys* 75(3):303-312.
- \*Leuraud K, Billon S, Bergot D, et al. 2007. Lung cancer risk associated to exposure to radon and smoking in a case-control study of French uranium miners. *Health Phys* 92(4):371-378.
- \*Lewis RJ, ed. 2001. *Hawley's condensed chemical dictionary*. 14th ed. New York, NY: John Wiley & Sons, Inc., 951.

## 9. REFERENCES

- \*Lewis, RK. 1996. A Hot Spot Survey in the Reading Prong Area of Pennsylvania. Pennsylvania DEP, Bureau of Radiation Protection. 1996 International Radon Symposium IP-4.1. The American Association of Radon Scientists and Technologists, Proceedings  
[http://www.aarst.org/proceedings/1996/1996\\_11\\_A%20HotSpot\\_Survey\\_in\\_the\\_Reading\\_Prong\\_Area\\_of\\_Penns.pdf](http://www.aarst.org/proceedings/1996/1996_11_A%20HotSpot_Survey_in_the_Reading_Prong_Area_of_Penns.pdf). August 28, 2008.
- Li BY, Tong J. 2007. Adverse effects attributed to long-term radon inhalation in rats. *J Toxicol Environ Health A* 70(11):925-930.
- Li JX, Fu CL, Chen R, et al. 2007. Screening of differential expression genes in bone marrow cells of radon-exposed mice. *J Toxicol Environ Health A* 70(11):964-969.
- \*Lide DR, ed. 2005. CRC Handbook of chemistry and physics. New York, NY: CRC Press LLC, 4-81.
- Linnet MS, Schubauer-Berigan MK, Weisenburger DD, et al. 2007. Chronic lymphocytic leukaemia: An overview of aetiology in light of recent developments in classification and pathogenesis. *Br J Haematol* 139:672-686.
- Liu KS, Hayward SB, Girman JR, et al. 1991. Annual average radon concentrations in California residences. *J Air Waste Manage Assoc* 41(9):1207-1212.
- Little J, McGandy R, Kennedy A. 1978. Interactions between polonium-210 alpha-radiation, benzo(a)pyrene, and 0.9% NaCl solution instillations in the induction of experimental lung cancer. *Cancer Res* 38:1929-1935.
- \*Livingston AL. 1978. Forage plant estrogens. *J Toxicol Environ Health* 4(2-3):301-324.
- Lloyd RD, Angus W, Taylor GN, et al. 1995. Soft tissue tumors among beagles injected with  $^{90}\text{Sr}$ ,  $^{228}\text{Ra}$ , or  $^{228}\text{Th}$ . *Health Phys* 69(2):272-277.
- Lloyd RD, Taylor GN, Miller SC. 1993. Does leukemia result from the presence of radon or thoron in the body? *Health Phys* 65(4):439-440.
- \*Longtin J. 1990. Occurrence of radionuclides in drinking water, a national study. In: Cothorn CR, Rebers PA, eds. Radon, radium and uranium in drinking water. Chelsea, MI: Lewis Publishers, 97-139.
- \*Longtin JP. 1988. Occurrence of radon, radium, and uranium in groundwater. *J Am Water Works Assoc* 80(7):84-93.
- Lopez MA, Currivan L, Falk R, et al. 2004. Workplace monitoring for exposures to radon and to other natural sources in Europe: Integration of monitoring for internal and external exposures. *Radiat Prot Dosimetry* 112(1):121-139.
- \*Loucas BD, Geard CR. 1994. Initial damage in human interphase chromosomes from alpha particles with linear energy transfers relevant to radon exposure. *Radiat Res* 139(1):9-14.
- Lowry JD. 1991. Measuring low radon levels in drinking water supplies. *J Am Water Works Assoc* 83:149-153.
- Lubin JH. 1994. Invited commentary: Lung cancer and exposure to residential radon. (Comment on: *Am J Epidemiol* 140(4):310-322). *Am J Epidemiol* 140(4):323-332.

## 9. REFERENCES

- Lubin JH. 1998. On the discrepancy between epidemiologic studies in individuals of lung cancer and residential radon and Cohen's ecologic regression. (Comment in: *Health Phys* 75(1):18-22, discussion 29-30; 76(3):316-319). (Comment on: *Health Phys* 68(2):157-174; 72(4):623-628). *Health Phys* 75(1):4-10.
- Lubin JH. 2002. The potential for bias in Cohen's ecological analysis of lung cancer and residential radon. (Comment in: *J Radiol Prot* 22(3):305-307, author reply 307-309). *J Radiol Prot* 22(2):141-148.
- Lubin JH. 2003. Studies of radon and lung cancer in North America and China. *Radiat Prot Dosimetry* 104(4):315-319.
- \*Lubin JH, Boice JD. 1997. Lung cancer risk from residential radon: Meta-analysis of eight epidemiologic studies. (Comment in: *J Natl Cancer Inst* 89(1):4-6; 89(9):663-664, author reply 664-665). *J Natl Cancer Inst* 89(1):49-57.
- \*Lubin JH, Boice JD, Edling C, et al. 1995a. Lung cancer in radon-exposed miners and estimation of risk from indoor exposure. *J Natl Cancer Inst* 87(11):817-827.
- \*Lubin JH, Boice JD, Edling C, et al. 1995b. Radon-exposed underground miners and inverse dose-rate (protraction enhancement) effects. *Health Phys* 69(4):494-500.
- \*Lubin JH, Liang Z, Hrubec Z, et al. 1994. Radon exposure in residences and lung cancer among women: Combined analysis of three studies. *Cancer Causes Control* 5(2):114-128.
- Lubin JH, Linet MS, Boice JD, et al. 1998. Case-control study of childhood acute lymphoblastic leukemia and residential radon exposure. *J Natl Cancer Inst* 90:294-299.
- \*Lubin JH, Qiao Y, Taylor PR, et al. 1990. Quantitative evaluation of the radon and lung cancer association in a case control study of Chinese tin miners. *Cancer Res* 50(1):174-180.
- \*Lubin JH, Tomasek L, Edling C, et al. 1997. Estimating lung cancer mortality from residential radon using data for low exposures of miners. (Comment in: *Radiat Res* 147(2):135-137). *Radiat Res* 147:126-134.
- Lubin JH, Wang ZY, Boice JD, et al. 2004. Risk of lung cancer and residential radon in China: Pooled results of two studies. *Int J Cancer* 109(1):132-137.
- Lucie NP. 1989. Radon exposure and leukaemia. (Comment in: *Lancet* 2(8662):562; 2(8664):673-674). *Lancet* 2(8654):99-100.
- Luebeck EG, Curtis SB, Cross FT, et al. 1996. Two-stage model of radon-induced malignant lung tumors in rats: Effects of cell killing. *Radiat Res* 145(2):163-173.
- \*Luebeck EG, Heidenreich WF, Hazelton WD, et al. 1999. Biologically based analysis of the data for the Colorado uranium miners cohort: Age, dose and dose-rate effects. *Radiat Res* 152(4):339-351.
- Luetzelschwab JW, Hastings L, Ellis SM. 1994. Adsorption of <sup>222</sup>Rn by open-faced and diffusion-barrier canisters at different conditions of temperature and humidity. *Health Phys* 66(1):63-71.

## 9. REFERENCES

- \*Lundin F, Lloyd J, Smith E. 1969. Mortality of uranium miners in relation to radiation exposure, hard-rock mining and cigarette smoking--1950 through September 1967. *Health Phys* 16:571-578.
- \*Lundin F, Wagoner J, Archer V. 1971. Radon daughter exposure and respiratory cancer quantitative and temporal aspects. Report from the epidemiological study of U.S. uranium miners. Washington, DC: National Institute of Occupational Safety and Health and National Institute for Environmental Health Sciences, Joint Monograph No. 1. Department of Health, Education, and Welfare.
- Lutze LH, Winegar RA, Jostes R, et al. 1992. Radon-induced deletions in human cells: Role of nonhomologous strand rejoining. *Cancer Res* 52(18):5126-5129.
- \*Macdonald CR, Laverock MJ. 1998. Radiation exposure and dose to small mammals in radon-rich soils. *Arch Environ Contam Toxicol* 35(1):109-120.
- \*Machta L, Lucas H. 1962. Radon in the upper atmosphere. *Science* 135:296-299.
- \*Maes A, Poffijn A, Verschaeve L. 1996. Case report: Karyotypic and chromosome aberration analysis of subjects exposed to indoor radon. *Health Phys* 71(5):641-643.
- Magnus K, Engeland A, Green BM, et al. 1994. Residential radon exposure and lung cancer: An epidemiological study of Norwegian municipalities. *Int J Cancer* 58(1):1-7.
- \*Mahaffey JA, Parkhurst MA, James AC, et al., 1993. Estimating past exposures to indoor radon from household glass. *Health Physics* 64(4):381-391.
- \*Maiello M, Harley N. 1987. Egard: An environmental gamma-ray and <sup>222</sup>Rn detector. *Health Phys* 53:301-305.
- \*Marcinowski F, Lucas RM, Yeager WM. 1994. National and regional distributions of airborne radon concentrations in U.S. homes. *Health Phys* 66(6):699-706.
- \*Markkanen M, Arvela H. 1992. Radon emanation from soils. *Radiat Prot Dosimetry* 45(1/4):269-272.
- \*Marsh JW, Birchall A. 1999. Determination of lung-to-blood absorption rates for lead and bismuth which are appropriate for radon progeny. *Radiat Prot Dosimetry* 83(4):331-337.
- \*Marsh JW, Birchall A. 2000. Sensitivity analysis of the weighted equivalent lung dose per unit exposure from radon progeny. *Radiat Prot Dosimetry* 87(3):167-178.
- \*Martin D, Jacobi W. 1972. Diffusion deposition of small-sized particles in the bronchial tree. *Health Phys* 23:23-29.
- \*Martin J, Mills W. 1973. Environmental radiation standards considerations for krypton-85 and radon. In: Stanley R, Moghissi A, eds. *Noble gases*. Washington, DC: U.S. Energy Development and Research Agency, National Environmental Research Center, CONF-730915, 647-653.
- Martin SG, Miller RC, Geard CR, et al. 1995. The biological effectiveness of radon-progeny alpha particles. IV. Morphological transformation of Syrian hamster embryo cells at low doses. *Radiat Res* 142(1):70-77.

## 9. REFERENCES

Masse R, Chameaud J, Lafuma J. 1984. Cocarcinogenic effect of tobacco smoke in rats. In: Cumming G, Bonsignore G, eds. Smoking and the lung. New York, NY: Plenum Press, 61-72.

\*Mayr U, Butsch A, Schneider S. 1992. Validation of two *in vitro* test systems for estrogenic activities with zearalenone, phytoestrogens and cereal extracts. Toxicology 74(2-3):135-149.

\*Mays C, Lloyd R, Van Dilla M. 1975. Fractional radon retention in bone. Health Phys 29:761-765.

McDonald JW, Taylor JA, Watson MA, et al. 1995. p53 and K-ras in radon-associated lung adenocarcinoma. Cancer Epidemiol Biomarkers Prev 4(7):791-793.

\*McPherson R. 1980. Environmental radon and radon daughter dosimetry in the respiratory tract. Health Phys 39:929-936.

Metting NF, Palayoor ST, Macklis RM, et al. 1992. Induction of mutations by bismuth-212  $\alpha$  particles at two genetic loci in human B-lymphoblasts. Radiat Res 132(3):339-345.

Meurman LO, Kiviluoto R, Hakama M. 1974. Mortality and morbidity among the working population of anthophyllite asbestos miners in Finland. Br J Ind Med 31:105-112.

\*Meyer S. 1937. Physikalische grundlagen von emanationskuren. Strahlentherapie 58:656-663.

\*Michel J. 1987. Sources. In: Cothorn C, Smith J, eds. Environmental radon. New York, NY: Plenum Press, 81-130.

Mifune M, Sobue T, Arimoto H, et al. 1992. Cancer mortality survey in a spa area (Misasa, Japan) with a high radon background. Jpn J Cancer Res 83(1):1-5.

Miles DP. 1992. Lung cancer and radon. (Comment in: BMJ 305(6851):475). (Comment on: BMJ 304(6841):1571). BMJ 305(6846):181.

Miles D, O'Brien J, Owen M. 1999. Involvement of radon levels in lung cancer. (Comment on: Br J Cancer 78(3):394-408). Br J Cancer 79(9-10):1621-1623.

Miller AS, Harwick RD, Alfaro-Miranda M, et al. 1993. Search for correlation of radon levels and incidence of salivary gland tumors. Oral Surg Oral Med Oral Pathol 75(1):58-63.

Miller D, Morrison H, Semenciw R, et al. 1993. Leukemia and residential exposure to radon. Can J Public Health 84(3):205-206.

Miller RC, Marino SA, Brenner DJ, et al. 1995. The biological effectiveness of radon-progeny alpha particles. II. Oncogenic transformation as a function of linear energy transfer. Radiat Res 142(1):54-60.

Miller RL, Kraemer TF, McPherson BF. 1990. Radium and radon in Charlotte Harbor Estuary, Florida. Estuarine Coastal Shelf Sci 31:439-457.

Misdaq MA, Ezzahery H, Elabboubi D. 2001. Determination of equivalent dose rates and committed effective doses in the respiratory system from the inhalation of radon decay products by using SSNTD and a dosimetric compartmental model. Radiat Prot Dosimetry 93(4):347-355.

## 9. REFERENCES

- Mitchel RE, Jackson JS, Heinmiller B. 1999. Inhaled uranium ore dust and lung cancer risk in rats. *Health Phys* 76(2):145-155.
- Mohamed A. 2005. Influence of radioactive aerosol and biological parameters of inhaled radon progeny on human lung dose. *Radiat Prot Dosimetry* 113(1):115-122.
- Möhner M. 2007. Risk of lymphohematopoietic malignancies in uranium miners. (Comment on: *Environ Health Perspect* 114(6):818-822). *Environ Health Perspect* 115(4):A184; author reply A184-A185.
- \*Möhner M, Lindtner M, Otten H, et al. 2006. Leukemia and exposure to ionizing radiation among German uranium miners. *Am J Ind Med* 49(4):238-248.
- Mole RH, Bowie SHU, Alexander FE, et al. 1990. Radon and leukaemia. (Comment on: *Lancet* 335(8689):1008-1012). *Lancet* 335(8701):1336-1340.
- \*Momčilović B, Alkhatib HA, Duerre HA, et al. 1999. Environmental radon daughters reveal pathognomonic changes in the brain proteins and lipids in patients with Alzheimer's disease and Parkinson's disease, and cigarette smokers. *Arh Hig Rada Toksikol* 50:347-369.
- Momčilović B, Alkhatib HA, Duerre JA, et al. 2001. Environmental lead-210 and bismuth-210 accrue selectively in the brain proteins in Alzheimer disease and brain lipids in Parkinson disease. *Alzheimer Dis Assoc Disord* 15(2) :106-115.
- Momčilović B, Lykken GJ. 2007. Seasonality of  $^{214}\text{Bi}$  activity in the human body and of  $^{222}\text{Rn}$  concentration in home in ambient air. *Health Phys* 92(5) :484-487.
- Momčilović B, Lykken GI, Cooley M. 2006. Natural distribution of environmental radon daughters in the different brain areas of an Alzheimer disease victim. *Mol Neurodegener* 1(11) :1-11.
- \*Monchaux G. 2004. Risk of fatal versus incidental lung cancer in radon-exposed rats: A reanalysis of French data. *Arch Oncol* 12(1):7-12.
- \*Monchaux G, Morlier JP. 2002. Influence of exposure rate on radon-induced lung cancer in rats. *J Radiol Prot* 22(3A):A81-A87.
- \*Monchaux G, Morlier JP, Altmeyer S, et al. 1999. Influence of exposure rate on lung cancer induction in rats exposed to radon progeny. *Radiat Res* 152(Suppl 6):S137-S140.
- Monchaux G, Morlier JP, Morin M, et al. 1994a. Carcinogenic and cocarcinogenic effects of radon and radon daughters in rats. *Environ Health Perspect* 102(1):64-73.
- Monchaux G, Morlier JP, Morin M, et al. 1994b. Carcinogenic effects in rats of exposure to different minerals from metallic mine ores, radon and radon daughters. In: Davis JMG, Jaurand MC, eds. *Cellular and molecular effects of mineral and synthetic dusts and fibres*. Berlin, Germany: Springer-Verlag, 159-164.
- Monchaux G, Morlier JP, Morin M, et al. 1996. Co-carcinogenic effects in rats of combined exposure to radon and ozone. *Environ Int* 22(Suppl 1):909-915.



## 9. REFERENCES

- Moolgavkar SH, Cross FT, Luebeck G, et al. 1990. A two-mutation model for radon-induced lung tumors in rats. *Radiat Res* 121(1):28-37.
- \*Moolgavkar SH, Luebeck EG, Krewski D, et al. 1993. Radon, cigarette smoke, and lung cancer: A re-analysis of the Colorado Plateau uranium miners' data. *Epidemiology* 4(3):204-217.
- \*Morgenstern H. 1995. Ecologic studies in epidemiology: Concepts, principles, and methods. *Annu Rev Public Health* 16:61-81.
- +\*Morken D. 1955. Acute toxicity of radon. *AMA Arch Ind Health* 12:435-438.
- +\*Morken D. 1973. The biological effects of radon on the lung. In: Stanley R, Moghissi A, eds. *Noble gases*. Washington, DC: U.S. Energy Development and Research Agency, National Environmental Research Center, CONF-730915, 501-506.
- \*Morken D. 1980. The biological and health effects of radon: A review. National Bureau of Standards Special Publication 581, Proceedings of a roundtable discussion of radon in buildings held at NBS, Gaithersburg, MD, 21-26.
- Morlier JP, Bisson M, Fritsch P, et al. 1996. Deposition of  $^{214}\text{Pb}$  and nuclear aberrations in the respiratory tract of rats after exposure to radon progeny under different aerosol conditions. *Environ Int* 22(Suppl 1):S927-S930.
- Morlier JP, Janot M, Pineau JP, et al. 1996. Compared deposition of radon-222 and radon-220 (thoron) progeny and nuclear aberrations in the respiratory tract of rats after exposure under different aerosol conditions. In: Duftschmid KE, ed. 1996 International congress on radiation protection. Proceedings. Vol. 2. Washington, DC: International Radiation Protection Association.
- \*Morlier JP, Morin M, Chameaud J, et al. 1992. [Importance of exposure rate on tumour induction in rats after exposure.] *C R Acad Sci III* 315:463-466. (French)
- \*Morlier JP, Morin M, Monchaux G, et al. 1994. Lung cancer incidence after exposure of rats to low doses of radon: Influence of dose rate. *Radiat Prot Dosimetry* 56(1-4):93-97.
- \*Morrison H, Semenciw R, Mao Y, et al. 1985. Lung cancer mortality and radiation exposure among the Newfoundland fluorspar miners. In: Stocker H, ed. *Proceedings of the international conference*. Toronto: Canadian Nuclear Association, 354-364.
- \*Morrison HI, Semenciw RM, Mao Y, et al. 1988. Cancer mortality among a group of fluorspar miners exposed to radon progeny. *Am J Epidemiol* 128(6):1266-1275.
- \*Morrison HI, Villeneuve PJ, Lubin JH, et al. 1998. Radon-progeny exposure and lung cancer risk in a cohort of Newfoundland fluorspar miners. *Radiat Res* 150(1):58-65.
- Morrison HI, Wigle D, Stocker H, et al. 1981. Lung cancer mortality and radiation exposure among the Newfoundland fluorspar miners. In: Gomez M, ed. *International conference: Radiation hazards in mining*. New York, NY: Society of Mining Engineers of American Institute of Mining, Metallurgical, and Petroleum Engineers, Inc., 372-376.
- \*Morselli PL, Franco-Morselli R, Bossi L. 1980. Clinical pharmacokinetics in newborns and infants: Age-related differences and therapeutic implications. *Clin Pharmacokin* 5(6):485-527.

## 9. REFERENCES

Mose DG, Mushrush GW, Chrosniak C. 1990. Radioactive hazard of potable water in Virginia and Maryland. *Bull Environ Contam Toxicol* 44(4):508-513.

Mossman KL. 1998. Is indoor radon a public health hazard? The BEIR VI report. *Radiat Prot Dosimetry* 80(4):357-360.

\*MSHA. 2007. Radon daughter exposure monitoring, annual exposure limits, and maximum permissible concentration. U.S. Mine Safety and Health Administration. Code of Federal Regulations. 30 CFR 57. <http://www.access.gpo.gov/cgi-bin/cfrassemble.cgi?title=200730>. May 09, 2008.

\*Muikku M, Rahola T, Pusa S, et al. 2003. Estimation of human exposure to natural radionuclides using *in vivo* skull measurements. *Radiat Prot Dosimetry* 105(1-4):615-618.

Muirhead CR, Butland BK, Green BMR, et al. 1991. Childhood leukaemia and natural radiation. (Comment on: *Lancet* 335(8696):1008-1012). *Lancet* 337(8739):503-504.

Muirhead CR, Butland BK, Green BMR, et al. 1992. An analysis of childhood leukaemia and natural radiation in Britain. *Radiat Prot Dosimetry* 45(1):657-660.

\*Muller C, Ruzicka L, Bakstein J. 1967. The sex ratio in the offsprings of uranium miners. *Acta Univ Carolinae [Med] (Praha)* 13:599-603.

\*Muller J, Wheeler W, Gentleman J, et al. 1985. Study of mortality of Ontario miners. Presented International Conference Occupational Radiation Safety in Mining, October 14-18, 1984, Toronto, Ontario.

Nadoolman W. 1994. Radon exposure and lung cancer. (Comment on: *N Engl J Med* 330(3):159-164). *N Engl J Med* 330(23):1684, author reply 1685.

\*Nagarkatti M, Nagarkatti PS, Brooks A. 1996. Effect of radon on the immune system: Alterations in the cellularity and functions of T cells in lymphoid organs of mouse. *J Toxicol Environ Health* 47(6):535-552.

\*NAS. 1988. Health risks of radon and other internally deposited alpha-emitters: BEIR IV. Committee on the Biological Effects of Ionizing Radiations, National Research Council. Washington, DC: National Academy of Sciences, National Academy Press, 1-23, 367-395, 430-496.

\*NAS. 1990. Background information and scientific principles. Health effects of exposure to low levels of ionizing radiation: BEIR V. Committee on the Biological Effects of Ionizing Radiations, National Research Council. Washington, DC: National Academy of Sciences, National Academy Press, 9-64.

\*NAS. 1999a. Health effects of exposure to radon: Beir VI. Washington, DC: National Academy of Sciences. [http://books.nap.edu/catalog.php?record\\_id=5499](http://books.nap.edu/catalog.php?record_id=5499). April 25, 2008.

\*NAS. 1999b. Risk assessment of radon in drinking water. Washington, DC: National Academy of Sciences. [http://www.nap.edu/catalog.php?record\\_id=6287](http://www.nap.edu/catalog.php?record_id=6287). April 25, 2008.

\*NAS/NRC. 1989. Report of the oversight committee. In: *Biologic markers in reproductive toxicology*. Washington, DC: National Academy of Sciences, National Research Council, National Academy Press, 15-35.

## 9. REFERENCES

- \*Nazaroff W, Doyle S, Nero A, et al. 1987. Potable water as a source of airborne <sup>222</sup>Rn in U.S. dwellings: A review and assessment. *Health Phys* 52:281-295.
- \*NCRP. 1975. Natural background radiation in the United States. National Council on Radiation Protection and Measurements. NCRP Report No. 45.
- \*NCRP. 1984a. Evaluation of occupational and environmental exposures to radon and radon daughters in the United States. National Council on Radiation Protection and Measurements. NCRP Report No. 78.
- \*NCRP. 1984b. Exposures from the uranium series with emphasis on radon and its daughters. National Council on Radiation Protection and Measurements. NCRP Report No. 77.
- \*NCRP. 1987. Exposure of the population in the United States and Canada from natural background radiation. National Council on Radiation Protection and Measurements. NCRP Report No. 94.
- \*NCRP. 1988. Measurement of radon and radon daughters in air. National Council on Radiation Protection and Measurements. NCRP Report No. 97.
- \*NCRP. 1997. Deposition, retention and dosimetry of inhaled radioactive substances. Bethesda, MD: National Council on Radiation Protection and Measurements. NCRP Report No. 125.
- \*NEA/OECD. 1983. Dosimetry aspects of exposure to radon and thoron daughter products. Paris: Nuclear Energy Agency/Organisation for Economic Co-operation and Development.
- Neilson S, Robinson I, Clifford Rose F. 1996. Ecological correlates of motor neuron disease mortality: A hypothesis concerning an epidemiological association with radon gas and gamma exposure. *J Neurol* 243(4):329-336.
- \*Nero A. 1987. Indoor concentrations of radon-222 and its daughters: Sources, range, and environmental influences. In: Gammage R, Kaye S, eds. *Indoor air and human health*. Chelsea, MI: Lewis Publishers, Inc., 43-67.
- \*Nero A, Schwehr M, Nazaroff W, et al. 1986. Distribution of airborne radon- 222 concentrations in U.S. homes. *Science* 234:992-997.
- Neuberger JS. 1991a. Errata. (Erratum to: *Cancer Detect Prev* 15(6):435-443). *Cancer Detect Prev* 16(1):87.
- Neuberger JS. 1991b. Residential radon exposure and lung cancer: An overview of published studies. (Erratum in: *Cancer Detect Prev* 16(1):87). *Cancer Detect Prev* 15(6):435-443.
- Neuberger JS, Allen A. 1997. Lung cancer risk from residential radon: Meta-analysis of eight epidemiologic studies. (Comment on: *J Natl Cancer Inst* 89(1):49-57). *J Natl Cancer Inst* 89(9):663-664, author reply 664-665.
- Neuberger JS, Field RW. 1996. Radon and breast cancer. (Comment on: *Risk Anal* 16(1):1-2). *Risk Anal* 16(6):729-730.

## 9. REFERENCES

- Neuberger JS, Gesell TF. 2002a. Childhood cancers, radon, and gamma radiation. (Comment in: *Lancet* 361(9369):1658). *Lancet* 360(9344):1437-1438.
- Neuberger JS, Gesell TF. 2002b. Residential radon exposure and lung cancer: Risk in nonsmokers. *Health Phys* 83(1):1-18.
- Neuberger JS, Rundo J. 1996. Indoor radon and lung cancer in the radium dial workers. Winter meeting of the American Nuclear Society (ANS) and the European Nuclear Society (ENS), Washington, DC (United States), 1-14 Nov 1996. Washington, DC: U.S. Department of Energy. ANL/ESH/CP 90664. DE97004673.
- \*Nevissi A, Bodansky D. 1987. Radon sources and levels in the outside environment. In: Bodansky D, Robkin M, Stadler D, eds. *Indoor radon and its hazards*. Seattle, WA: University of Washington Press, 42-50.
- New Mexico. 1981. New Mexico mine safety code for all mines including open-cut and open-pit. Albuquerque, NM: Bureau of Mine Inspection. Rule No. 81-1. 117, 139-141.
- +\*NIEHS. 1978. Study of the combined effects of smoking and inhalation of uranium ore dust, radon daughters and diesel oil exhaust fumes in hamsters and dogs. Research Triangle Park, NC: National Institute of Environmental Health Sciences. PNL-2744.
- \*NIH. 1994. Radon and lung cancer risk: A joint analysis of 11 underground miners studies. Bethesda, MD: National Institutes of Health. NIH publication no. 94-3644.
- \*NIOSH. 1987. A recommended standard for occupational exposure to radon progeny in underground mines. U.S. Department Health and Human Services, National Institute for Occupational Safety and Health, 1-4, 16-23, 32-63, 65-107, 126, 134-137.
- \*NIOSH. 2006. Characterization of occupational exposure to radium and radon progeny during recovery of uranium from phosphate materials. ORAUT-OTIB-0043. <http://www.cdc.gov/NIOSH/ocas/pdfs/tibs/or-t43-r0.pdf>. August 08, 2008.
- \*NIOSH. 2008a. Number of mining employees by detailed commodity and type of operation, 2005. National Institute for Occupational Safety and Health. <http://www.cdc.gov/niosh/mining/statistics/pdfs/emp.pdf>. August 28, 2008.
- \*NIOSH. 2008b. Summary of mine-level characteristics by commodity, 2005. National Institute for Occupational Safety and Health. <http://www.cdc.gov/niosh/mining/statistics/tables/char.html>. August 28, 2008.
- Noumoff JS, LiVolsi VA, Deger RB, et al. 2001. Chromosome analysis and comparison of the benign cystic and malignant squamous component of an ovarian teratoma. *Cancer Genet Cytogenet* 125(1):59-62.
- \*NRC. 1981. *Indoor pollutants*. Washington, DC: National Academy Press, 63-69, 505, 509-510, 514-515.
- NRC. 1988. *Standards for protection against radiation*. Nuclear Regulatory Commission. Code of Federal Regulations. 10 CFR 20.

## 9. REFERENCES

- \*NRC. 1991. Comparative dosimetry of radon in mines and homes. National Research Council. Washington, DC: National Academy Press.
- \*NRC. 1993. Pesticides in the diets of infants and children. Washington, DC: National Research Council. National Academy Press.
- \*NRPB. 2002. Industrial uranium compounds: Exposure limits, assessment of intake and toxicity after inhalation. Chilton: National Radiological Protection Board. NRPB-W22.
- \*NTP. 2005a. Ionizing radiation. Report on carcinogens. 11th ed. Research Triangle Park, NC: U.S. Department of Health and Human Services, Public Health Service, National Toxicology Program. <http://ntp-server.niehs.nih.gov/ntp/roc/toc11.html>. May 11, 2007.
- \*NTP. 2005b. Report on carcinogens. 11th ed. Research Triangle Park, NC: U.S. Department of Health and Human Services, Public Health Service, National Toxicology Program. <http://ntp-server.niehs.nih.gov/ntp/roc/toc11.html>. April 24, 2008.
- \*Nussbaum E, Hursh JB. 1957. Radon solubility in rat tissues. *Science* 125:552-553.
- Nussbaum E, Hursh JB. 1958. Radon solubility in fatty acids and triglycerides. *J Phys Chem* 62(1):81-84.
- \*Oberaigner W, Kreienbrock L, Schaffrath Rosario A, et al. 2002. [Radon and lung cancer in the district of Imst, Austria]. Landberg am Lech, Germany: Ecomed Verlagsgesellschaft, Fortschritte in der Umweltmedizin. (German)
- \*Oberstedt S, Vanmarcke H. 1996. Volume traps-a new retrospective radon monitor. *Health Phys* 70(2):222-226.
- \*O'Flaherty EJ. 1993. Physiologically based models for bone-seeking elements. IV. Kinetics of lead disposition in humans. *Toxicol Appl Pharmacol* 118(1):16-29.
- \*O'Neil MJ, Heckelman PE, Koch CB, et al., eds. 2006. The Merck index. 14th ed. Whitehouse Station, NJ: Merck & Co., Inc., 1393-1394.
- O'Riordan MC. 1992. Exposure to radon. (Comment on: *BMJ* 305(6846):181). *BMJ* 305(6851):475.
- \*OSHA. 2007. Ionizing radiation. Toxic and hazardous substances. Occupational Safety and Health Administration. Code of Federal Regulations. 29 CFR 1910.1096. <http://www.osha.gov/comp-links.html>. April 24, 2008.
- OTA. 1990. Neurotoxicity, identifying and controlling poisons of the nervous system, new developments in neuroscience. Office of Technology Assessment, Congress of the United States.
- Otake M, Schull W. 1984. *In utero* exposure to A-bomb radiation and mental retardation; a reassessment. *Br J Radiol* 57:409-414.
- \*Owen GM, Brozek J. 1966. Influence of age, sex and nutrition on body composition during childhood and adolescence. In: Falkner F, ed. *Human development*. Philadelphia, PA: WB Saunders, 222-238.

## 9. REFERENCES

Palmer H, Perkins R, Stuart B. 1964. The distribution and deposition of radon daughters attached to dust particles in the respiratory system of humans exposed to uranium mine atmospheres. *Health Phys* 10:1129-1135.

+\*Palmer R, Stuart B, Filipy R. 1973. Biological effects of daily inhalation of radon and its short-lived daughters in experimental animals. In: Stanley R, Moghissi A, eds. *Noble gases*. Washington, DC: U.S. Energy Development and Research Agency, National Environmental Research Center. CONF-730915, 507-519.

Parker L, Craft AW. 1996. Radon and childhood cancers. (Comment on: *Eur J Cancer* 32A(2):282-285). *Eur J Cancer* 32A(2):201-204.

Pavia M, Bianco A, Pileggi C, et al. 2003. Meta-analysis of residential exposure to radon gas and lung cancer. *Bull World Health Organ* 81(10):732-738.

Pawel DJ. 2005. Can confounding by smoking explain the ecologic correlation between lung cancer and radon? *Health Phys* 89(2):181-182.

Pawel DJ, Puskin JS. 2004. The U.S. Environmental Protection Agency's assessment of risks from indoor radon. (Comment in: *Health Phys* 87(6):670-671; 87(6):671-672, author reply 672). *Health Phys* 87(1):68-74.

Pearce J, Boyle P. 2005. Examining the relationship between lung cancer and radon in small areas across Scotland. *Health Place* 11(3):275-282.

\*Pearson J. 1967. *Natural environmental radioactivity from radon-222*. Rockville, MD: U.S. Department of Health, Education, and Welfare, Public Health Service, Bureau of Disease Prevention and Environmental Control. Publication No. 999-RH-26.

Pershagen G, Lagarde F. 1995. Re: "Case-control study of residential radon and lung cancer in Winnipeg, Manitoba, Canada". (Comment on: *Am J Epidemiol* 140(4):310-322). *Am J Epidemiol* 142(10):1121-1122.

\*Pershagen G, Liang ZH, Hrubec Z, et al. 1992. Residential radon exposure and lung cancer in women. *Health Phys* 63:179-186.

\*Pershagen G, Akerblom G, Axelson O, et al. 1994. Residential radon exposure and lung cancer in Sweden. (Comment in: *N Engl J Med* 330(23):1684, author reply 1685). *N Engl J Med* 330(3):159-164.

\*Peterman BF, Perkins CJ. 1988. Dynamics of radioactive chemically inert gases in the human body. *Radiat Prot Dosimetry* 22(1):5-12.

Piao CQ, Hei TK. 1993. The biological effectiveness of radon daughter alpha particles. I. Radon, cigarette smoke and oncogenic transformation. *Carcinogenesis* 14(3):497-501.

\*Pillai PM, Paul AC, Bhat IS, et al. 1994. Deposition and clearance of <sup>212</sup>Pb in humans. *Health Phys* 66(3):343-345.

\*Pisa FE, Barbone F, Betta A, et al. 2001. Residential radon and risk of lung cancer in an Italian alpine area. *Arch Environ Health* 56(3):208-215.

## 9. REFERENCES

- Placek V, Sevc J. 1975. Hazard of cancer of the larynx in uranium miners. *Pracovni Lekarstvi* 27:113-115.
- \*Planinić J, Šuveljak B, Faj Z. 1994. Radon distribution in dwellings. *J Radiol Prot* 14(3):235-239.
- Pohl E. 1964. Dose distribution received on inhalation of Ra222 and its decay products. In: *Radiological health and safety in mining and milling of nuclear materials. Vol 1. Vienna, Austria: International Atomic Energy Agency, 221-236.*
- \*Pohl E. 1965. *Biophysikalische untersuchungen über die inkorporation der natürlich radioaktiven emanationen und deren zerfallsprodukte.* New York, NY: Springer-Verlag, 406-409.
- \*Pohl-Rüling J, Fischer P. 1979. The dose-effect relationship of chromosome aberrations to alpha and gamma irradiation in a population subjected to an increased burden of natural radioactivity. *Radiat Res* 80:61-81.
- \*Pohl-Rüling J, Fischer P. 1982. An epidemiological study of chromosome aberrations in a radon spa. In: Clemente C, Nero A, Steinhausler F, et al., eds. *Proceedings of the specialist meeting on the assessment of radon and daughter exposure and related biological effects.* Salt Lake City: RD Press, 210-219.
- \*Pohl-Rüling J, Fischer P. 1983. Chromosome aberrations in inhabitants of areas with elevated natural radioactivity. In: Ishihara T, Sasaki M eds. *Radiation-induced chromosome damage in man.* New York, NY: Alan R. Liss, Inc., 527-560.
- \*Pohl-Rüling J, Fischer P, Pohl E. 1976. Chromosome aberrations in peripheral blood lymphocytes dependent on various dose levels of natural radioactivity. In: *Biological and environmental effects of low-level radiation. Vol. II.* Vienna: International Atomic Energy Agency, 317-324.
- \*Pohl-Rüling J, Fischer P, Pohl E. 1987. Effect on peripheral blood chromosomes. In: Hopke P, ed. *Radon and its decay products.* Washington, DC: American Chemical Society, 487-501.
- Pohl-Rüling J, Lettner H, Hofmann W, et al. 2000. Chromosomal aberrations of blood lymphocytes induced *in vitro* by radon-222 daughter  $\alpha$ -irradiation. *Mutat Res* 449(1-2):7-19.
- Poncy JL, Laroque P, Fritsch P, et al. 1992. An experimental two-scale rat model of lung carcinoma initiated by radon exposure. *Indoor radon and lung cancer: Reality or myth? Twenty-ninth Hanford Symposium on health and the environment, October 15-19, 1990.* Columbus, OH: Battelle Press, 803-819.
- \*Poncy JL, Walter C, Fritsch P, et al. 1980. Delayed SCE frequency in rat bone-marrow cells after radon inhalation. In: Sanders C, Cross F, Dagle G, et al., eds. *Pulmonary toxicology of respirable particles. 19th Hanford Life Sciences Symposium, Richland, Washington, Oct 22-24, 1979.* Oak Ridge, TN: US Department of Energy, 479-485.
- \*Porstendörfer J. 1994. Properties and behaviour of radon and thoron and their decay products in the air. *J Aerosol Sci* 25(2):219-263.
- \*Porstendörfer J. 2001. Physical parameters and dose factors of the radon and thoron decay products. *Radiat Prot Dosimetry* 94(4):365-373.

## 9. REFERENCES

\*Pressyanov D, Buysse J, Poffijn A, et al. 2003. The compact disk as radon detector - a laboratory study of the method. *Health Phys* 84(5):642-651.

Pressyanov D, Minev L, Uzunov P, et al. 1999. Excess lung cancer incidence and radon indoors in a Bulgarian town. *J Epidemiol Community Health* 53(7):448.

\*Price JG, Rigby JG, Christensen L, et al. 1994. Radon in outdoor air in Nevada. *Health Phys* 66(4):433-438.

\*Prichard H, Marlen K. 1983. Desorption of radon from activated carbon into a liquid scintillator. *Anal Chem* 55:155-157.

+\*Proescher F. 1913. The pathological anatomical changes in guinea pigs killed by exposure to high concentration of radium emanation. *Radium* 1:5-14.

Puskin JS. 2003. Smoking as a confounder in ecologic correlations of cancer mortality rates with average county radon levels. (Comment in: *Health Phys* 86(2):203-204, author reply 204-205). *Health Phys* 84(4):526-532.

Puskin JS, Pawel DJ. 2005. Attributable lung cancer risk from radon in homes may be low. (Comment on: *BMJ* 330(7485):223). *BMJ* 330(7500):1151.

\*Qiao YL, Taylor PR, Yao SX, et al. 1989. Relation of radon exposure and tobacco use to lung cancer among tin miners in Yunnan Province, China. *Am J Ind Med* 16(5):511-521.

\*Qiao YL, Taylor PR, Yao SX, et al. 1997. Risk factors and early detection of lung cancer in a cohort of Chinese tin miners. *Ann Epidemiol* 7(8):533-541.

\*Queval P, Beaumatin J, Morin M, et al. 1979. Inducibility of microsomal enzymes in normal and pre-cancerous lung tissue. *Biomedicine* 31:182-186.

Quindos LS, Soto J, Fernández PL, et al. 1991. Radon and lung cancer in Spain. *Radiat Prot Dosimetry* 36(2):331-333.

Raaschou-Nielsen O, Andersen CE, Andersen HP, et al. 2008. Domestic radon and childhood cancer in Denmark. *Epidemiology* 19:536-543.

\*Radford E, Renard K. 1984. Lung cancer in Swedish iron miners exposed to low doses of radon daughters. *New Engl J Med* 310:1485-1494.

Ramola RC, Kandari MS, Rawat RBC, et al. 1998. A study of seasonal variations of radon levels in different types of houses. *J Environ Radioact* 39(1):1-7.

Rand PW, Lacombe EH, Perkins WD. 1991. Radon in homes following its reduction in a community water supply. *J Am Water Works Assoc* 83(4):154-158.

\*Rangarajan C, Eapen C. 1987. Optimizing the gross alpha counting method for determining Rn progeny levels in the atmosphere. *Health Phys* 52:469-471.

Rechavi G, Berkowicz M, Rosner E, et al. 1990. Chromosomal aberrations suggestive of mutagen-related leukemia after 21 years of "therapeutic" radon exposure. *Cancer Genet Cytogenet* 48(1):125-130.



## 9. REFERENCES

- Rehman FU, Jamil K, Zakaullah M, et al. 2003. Experimental and Monte Carlo simulation studies of open cylindrical radon monitoring device using CR-39 detector. *J Environ Radioact* 65(2):243-254.
- \*Rella J. 2002. Radiation. In: Goldfrank LR, Flomenbaum NE, Lewis NA, et al., eds. *Goldfrank's toxicologic emergencies*. 7th ed. New York, NY: McGraw-Hill, 1515-1526.
- \*Renken KJ, Rosenberg T. 1995. Laboratory measurements of the transport of radon gas through concrete samples. *Health Phys* 68(6):800-808.
- Repace JL. 1989. Passive smoking is risky. *J Am Med Womens Assoc* 44(2):50-54.
- \*Řeřicha V, Kulich M, Řeřicha R, et al. 2006. Incidence of leukemia, lymphoma, and multiple myeloma in Czech uranium miners: A case-cohort study. (Comment in: *Environ Health Perspect* 115(4):A184, author reply A184-A185). *Environ Health Perspect* 114(6):818-822.
- Revzan KL, Fisk WJ, Sextro RG. 1993. Modeling radon entry into Florida slab-on-grade houses. *Health Phys* 65(4):375-385.
- Richardson RB. 1992. Transfer of radiobismuth to the fetus in guinea-pigs. *Radiat Prot Dosimetry* 41(2):169-172.
- Richardson RB, Henshaw DL. 1992. Age-dependent dose to red bone marrow from natural radon, thoron and <sup>40</sup>K. *Radiat Prot Dosimetry* 41(2):255.
- Richardson S, Monfort C, Green M, et al. 1995. Spatial variation of natural radiation and childhood leukaemia incidence in Great Britain. *Stat Med* 14(21-22):2487-2501.
- \*Richter ED, Neeman E, Fischer I, et al. 1997. Radon exposures in a Jerusalem public school. *Environ Health Perspect* 105(Suppl 6):1411-1416.
- \*Rogel A, Laurier D, Tirmarche M, et al. 2002. Lung cancer risk in the French cohort of uranium miners. *J Radiol Prot* 22(3A):A101-A106.
- \*Ronca-Battista M, Magno P, Nyberg P. 1988. Standard measurement techniques and strategies for indoor <sup>222</sup>Rn measurements. *Health Phys* 55:67-69.
- \*Roscoe RJ. 1997. An update of mortality from all causes among white uranium miners from the Colorado Plateau study group. *Am J Ind Med* 31:211-222.
- \*Roscoe RJ, Deddens JA, Salvan A, et al. 1995. Mortality among Navajo uranium miners. *Am J Public Health* 85(4):535-540.
- \*Roscoe RJ, Steenland K, Halperin W, et al. 1989. Lung cancer mortality among nonsmoking uranium miners exposed to radon daughters. *JAMA* 262:629-633.
- Ruckerbauer F, Winkler R. 2001. Radon concentration in soil gas: A comparison of methods. *Appl Radiat Isot* 55(2):273-280.
- \*Ruosteenoja E, Mäkeläinen I, Rytömaa T, et al. 1996. Radon and lung cancer in Finland. *Health Phys* 71(2):185-189.

## 9. REFERENCES

Rutovitz J. 1995. Are underdwellings at risk from elevated levels of radon? An examination of radon levels in 201 houses in Hebden bridge. *J Radiol Prot* 15(1):53-66.

\*Saccomanno G, Archer V, Auerbach O, et al. 1971. Histologic types of lung cancer among uranium miners. *Cancer* 27:515-523.

\*Saccomanno G, Archer V, Auerbach O, et al. 1974. Development of carcinoma of the lung as reflected in exfoliated cells. *Cancer* 33:256-270.

Saccomanno G, Archer V, Saunder R, et al. 1976. Early indices of cancer risk among uranium miners with reference to modifying factors. *Ann NY Acad Sci* 271:377-383.

\*Saccomanno G, Huth G, Auerbach O, et al. 1988. Relationship of radioactive radon daughters and cigarette smoking in the genesis of lung cancer in uranium miners. *Cancer* 62:1402-1408.

Saccomanno G, Yale C, Dison W, et al. 1986. An epidemiological analysis of the relationship between exposure to Rn progeny, smoking and bronchogenic carcinoma in the U-mining population of the Colorado Plateau--1960-1980. *Health Phys* 50:605-618.

\*Samet JM. 1989. Radon and lung cancer. *J Natl Cancer Inst* 81:745-757.

Samet JM. 1994. Indoor radon and lung cancer: Risky or not? (Comment on: *J Natl Cancer Inst* 86(24):1829-37). *J Natl Cancer Inst* 86(24):1813-1814.

Samet JM. 1997. Indoor radon exposure and lung cancer: Risky or not? All over again. (Comment on: *J Natl Cancer Inst* 89(1):49-57). *J Natl Cancer Inst* 89(1):4-6.

\*Samet JM, Kutvirt D, Waxweiler R, et al. 1984b. Uranium mining and lung cancer in Navajo men. *New Engl J Med* 310:1481-1484.

\*Samet JM, Morgan MV, Key CR, et al. 1986. Studies of uranium miners in New Mexico. *Ann Am Conf Gov Ind Hyg* 14:351-355.

\*Samet JM, Pathak DR, Morgan MV, et al. 1989. Radon progeny exposure and lung cancer risk in New Mexico U miners: A case-control study. *Health Phys* 56:415-421.

\*Samet JM, Pathak DR, Morgan MV, et al. 1991. Lung cancer mortality and exposure to radon progeny in a cohort of New Mexico underground uranium miners. *Health Phys* 61(6):745-752.

\*Samet JM, Pathak DR, Morgan MV, et al. 1994. Silicosis and lung cancer risk in underground uranium miners. *Health Phys* 66(4):450-453.

\*Samet JM, Young R, Morgan M, et al. 1984a. Prevalence survey of respiratory abnormalities in New Mexico uranium miners. *Health Phys* 46:361-370.

\*Samuelsson C. 1988. Retrospective determination of radon in houses. *Nature* 334:338-340.

\*Sanders CL. 1977. Inhalation toxicology of  $^{238}\text{PuO}_2$  and  $^{239}\text{PuO}_2$  in Syrian golden hamsters. *Radiat Res* 70(2):334-344.

## 9. REFERENCES

- \*Sandler DP, Weinberg CR, Archer VE, et al. 1999. Indoor radon and lung cancer risk: A case-control study in Connecticut and Utah. *Radiat Res* 151:103-104.
- \*Sandler DP, Weinberg CR, Shore DL, et al. 2006. Indoor radon and lung cancer risk in Connecticut and Utah. *J Toxicol Environ Health A* 69(7):633-654.
- \*Sasaki T, Gunji Y, Okuda T. 2004. Mathematical modeling of radon emanation. *J Nucl Sci Technol* 41(2):142-151.
- \*Schery S, Gaeddert D, Wilkening M. 1980. Two-filter monitor for atmospheric <sup>222</sup>Rn. *Rev Sci Instrum* 51:338-343.
- \*Schoenberg JB, Klotz JB, Wilcox HB, et al. 1990. Case-control study of residential radon and lung cancer among New Jersey women. *Cancer Res* 50(20):6520-6524.
- \*Schoenberg JB, Klotz JB, Wilcox HB, et al. 1992. A case-control study of residential radon and lung cancer among New Jersey women. In: Cross FT, ed. *Twenty-ninth Hanford symposium on health and the environment. Indoor radon and lung cancer: Reality or myth?* Sponsored by the United States Department of Energy and Battelle, Pacific Northwest Laboratories; Richland, Washington, Columbus: Battelle Press, 905-918.
- Schüttmann W. 1993. Schneeberg lung disease and uranium mining in the Saxon Ore Mountains (Erzgebirge). *Am J Ind Med* 23(2):355-368.
- \*Schwartz JL, Shadley JD, Atcher RW, et al. 1990. Comparison of radon-daughter-induced effects in repair-proficient and repair-deficient CHO cell lines. *Environ Mol Mutagen* 16(3):178-184.
- Sedláč A. 1996. Microdosimetric approach to the problem of lung cancer induced by radon progeny. *Health Phys* 70(5):680-688.
- Seed TM, Niiro GK, Kretz ND. 1992. Radon-exposed-mediated changes in lung macrophage morphology and function, *in vitro*. *Indoor radon and lung cancer: Reality or myth?* Twenty-ninth Hanford Symposium on health and the environment, October 15-19, 1990. Columbus, OH: Battelle Press, 581-597.
- Segovia N, Gaso MI, Armienta MA. 2007. Environmental radon studies in Mexico. *Environ Geochem Health* 29(2):143-153.
- \*Semprini L, Hopkins OS, Tasker BR. 2000. Laboratory, field and modeling studies of radon-222 as a natural tracer for monitoring NAPL contamination. *Transp Porous Media* 38:223-240.
- \*Setchell BP, Waites GMH. 1975. The blood-testis barrier. In: Creep RO, Astwood EB, Geiger SR, eds. *Handbook of physiology: Endocrinology V*. Washington, DC: American Physiological Society, 143-172.
- Ševc J, Kunz E, Plaček V. 1976. Lung cancer in uranium and long-term exposure to radon daughter products. *Health Phys* 30:433-437.
- \*Ševc J, Kunz E, Plaček V, et al. 1984. Comments on lung cancer risk estimates. *Health Phys* 46:961-964.

## 9. REFERENCES

- \*Ševc J, Kunz E, Tomášek L, et al. 1988. Cancer in man after exposure to Rn daughters. *Health Phys* 54:27-46.
- \*Ševc J, Tomášek L, Kunz E, et al. 1993. A survey of the Czechoslovak follow-up of lung cancer mortality in uranium miners. *Health Phys* 64(4):355-369.
- \*Ševcová M, Ševc J, Thomas J. 1978. Alpha irradiation of the skin and the possibility of late effects. *Health Phys* 35:803-806.
- \*Shadley JD, Whitlock JL, Rotmensch J, et al. 1991. The effects of radon daughter  $\alpha$ -particle irradiation in K1 and xrs-5 CHO cell lines. *Mutat Res* 248(1):73-83.
- \*Shanahan EM, Peterson D, Roxby D, et al. 1996. Mutation rates at the glycoporphin A and HPRT loci in uranium miners exposed to radon progeny. *Occup Environ Med* 53(7):439-444.
- Shapiro J. 1956. Radiation dosage from breathing radon and its daughter products. *AMA Arch Ind Health* 14:169-177.
- \*Sharma N, Hess CT, Thrall KD. 1997. A compartmental model of water radon contamination in the human body. *Health Phys* 72(2):261-268.
- +\*Sikov MR, Cross FT, Mast TJ, et al. 1992. Developmental toxicology of radon exposures. In: Cross FT, ed. *Indoor radon and lung cancer: Reality or myth?* Columbus, OH: Battelle Press, 677-691.
- Simpson S, Comstock G. 1983. Lung cancer and housing characteristics. *Arch Environ Health* 38:248-251.
- \*Smerhovský Z, Landa K, Rössner P, et al. 2001. Risk of cancer in an occupationally exposed cohort with increased level of chromosomal aberrations. *Environ Health Perspect* 109(1):41-45.
- \*Smerhovský Z, Landa K, Rössner P, et al. 2002. Increased risk of cancer in radon-exposed miners with elevated frequency of chromosomal aberrations. *Mutat Res* 514(1-2):165-176.
- Smith BJ, Field RW, Lynch CF. 1998. Residential  $^{222}\text{Rn}$  exposure and lung cancer: Testing the linear no-threshold theory with ecologic data. (Comment in: *Health Phys* 75(1):23-28, discussion 31-33; 76(3):316-319). (Comment on: *Health Phys* 68(2):157-174; 72(4):623-628). *Health Phys* 75(1):11-17.
- Smith BJ, Zhang L, Field RW. 2007. Iowa radon leukaemia study: A hierarchical population risk model for spatially correlated exposure measured with error. *Stat Med* 26:4619-4642.
- \*Snihs J. 1974. The approach to radon problems in non-uranium mines in Sweden. In: Snyder W, ed. *Proceedings of the third International Congress of the International Radiation Protection Association*. U.S. Atomic Energy Commission. CONF-730907-P2, 900-911.
- \*Sobue T, Lee VS, Ye W, et al. 2000. Residential radon exposure and lung cancer risk in Misasa, Japan: A case-control study. *J Radiat Res (Tokyo)* 41(2):81-92.
- \*Solli H, Andersen A, Strandén E, et al. 1985. Cancer incidence among workers exposed to radon and thoron daughters in a niobium mine. *Scand J Work Environ Health* 11:7-13.

## 9. REFERENCES

- Solomon SB, O'Brien RS, Wilks M, et al. 1994. Application of the ICRP's new respiratory tract model to an underground uranium mine. *Radiat Prot Dosimetry* 53(1-4):119-125.
- \*Somlai J, Gorjánác Z, Várhegyi A, et al. 2006. Radon concentration in houses over a closed Hungarian uranium mine. *Sci Total Environ* 367(2-3):653-665.
- Sont WN. 1994. A summary of data on accumulated occupational radiation doses among Canadian workers. *Health Phys* 67(4):393-398.
- Sperlich D, Karlik A, Pohl E. 1967. Versuche über die mutationsauslösende Wirkung von Radon 222 bei *Drosophila melanogaster*. *Strahlentherapie* 132:105-112.
- Šrám RJ, Dobiáš L, Rössner P, et al. 1993. Monitoring genotoxic exposure in uranium mines. *Environ Health Perspect* 101(Suppl 3):155-158.
- Srivastava G, Raghavayya M, Kotrappa P, et al. 1986. Radium-226 body burden in U miners by measurement of Rn in exhaled breath. *Health Phys* 50:217-221.
- \*Stayner L, Meinhardt T, Lemen R, et al. 1985. A retrospective cohort mortality study of a phosphate fertilizer production facility. *Arch Environ Health* 40:133-138.
- \*Stranden E, Kolstad AK, Lind B. 1984. Radon exhalation: Moisture and temperature dependence. *Health Phys* 47(3):480-484.
- Stebbing JH, Dignam JJ. 1988. Contamination of individuals by radon daughters: A preliminary study. *Arch Environ Health* 43(2):149-154.
- Steck DJ. 1990. A comparison of EPA screening measurements and annual <sup>222</sup>Rn concentrations in statewide surveys. *Health Phys* 58(4):523-530.
- \*Steck DJ, Field RW. 1999. The use of track registration detectors to reconstruct contemporary and historical airborne radon (222Rn) and radon progeny concentrations for a radon-lung cancer epidemiologic study. *Radiat Meas* 31:401-406.
- \*Steck DJ, Field RW, Lynch CF. 1999. Exposure to atmospheric radon. *Environ Health Perspect* 107(2):123-127.
- Steenland K. 1994. Age specific interactions between smoking and radon among United States uranium miners. *Occup Environ Med* 51(3):192-194.
- Steinbuch M, Weinberg CR, Buckley JD, et al. 1999. Indoor residential radon exposure and risk of childhood acute myeloid leukemia. *Br J Cancer* 81(5):900-906.
- Steindorf K, Lubin J, Wichmann HE, et al. 1995. Lung cancer deaths attributable to indoor radon exposure in West Germany. *Int J Epidemiol* 24(3):485-492.
- \*Stenström K, Annamäki M, Rytömaa T. 1979. Cytogenetic investigation of people in Finland using household water with high natural radioactivity. *Health Phys* 36:441-444.
- Sterling T. 1983. Possible effects on occupational lung cancer from smoking related changes in the mucus content of the lung. *J Chronic Dis* 36:669-676.

## 9. REFERENCES

- \*Stidley CA, Samet JM. 1993. A review of ecologic studies of lung cancer and indoor radon. (Comment in: *Health Phys* 66(2):212). *Health Phys* 65(3):234-251.
- Storm DL. 1994. Chemical monitoring of California's public drinking water sources: Public exposure and health impacts. In: Wang RGM, ed. *Water contamination and health*. New York, NY: Marcel Dekker, Inc., 67-124.
- Straja SR, Moghissi AA. 1999. Comment on "On the discrepancies between epidemiologic studies of lung cancer and residential radon and Cohen's ecologic regression". (Comment on: *Health Phys* 75(1):11-17). *Health Phys* 76(3):316-319.
- \*Stram DO, Langholz B, Huberman M, et al. 1999. Correcting for exposure measurement error in a reanalysis of lung cancer mortality for the Colorado Plateau Uranium Miners cohort. *Health Phys* 77(3):265-275.
- Stranden E, Magnus K, James AC, et al. 1988. A summary of data on accumulated occupational radiation doses among Canadian workers. *Radiat Prot Dosimetry* 24(1):471-474.
- Strong JC, Swift DL. 1992. Deposition of "unattached" radon daughters in models of human nasal and oral airways. *Indoor radon and lung cancer: Reality or myth? Twenty-ninth Hanford Symposium on health and the environment, October 15-19, 1990*. Columbus, OH: Battelle Press, 227-234.
- Strong JC, Walsh M, Black A. 1990. A facility for studying the carcinogenic and synergistic effects of radon daughters in rodents. *J Aerosol Sci* 21(Suppl 1):S459-S462.
- Stuart B, Willard D, Howard E. 1970. Studies of inhaled radon daughters, uranium ore dust, diesel exhaust, and cigarette smoke in dogs and hamsters. In: *Inhaled particles*. Surrey, England: Unwin Brothers, 3:543-558.
- Suess M. 1988. Indoor air quality: Radon--report on a WHO Working Group. *J Environ Radioact* 8:73-91.
- \*Sun K. 2008. Field calibration of the glass-based retrospective radon detectors for epidemiologic applications. Ph.D. dissertation from the University of Iowa. August 2008.
- \*Suomela M, Kahlos H. 1972. Studies on the elimination rate and the radiation exposure following ingestion of <sup>222</sup>Rn rich water. *Health Phys* 23:641-652.
- Suzuki Y, Honjo S, Kawamura H, et al. 1994. Cancer mortality in low radon spa area. *Jpn J Cancer Res* 85(11):1063-1066.
- Svensson C, Pershagen G, Klominek J. 1989. Lung cancer in women and type of dwelling in relation to radon exposure. *Cancer Res* 49(7):1861-1865.
- \*Swift DL, Strong JC. 1996. Nasal deposition of ultrafine <sup>218</sup>Po aerosols in human subjects. *J Aerosol Sci* 27(7):1125-1132.
- \*Swistock BR, Sharpe WE, Robillard PD. 1993. A survey of lead nitrate and radon contamination of private individual water systems in Pennsylvania. *J Environ Health* 55(5):6-12.

## 9. REFERENCES

- Szöke I, Balásházy I, Farkas Á, et al. 2006. Alpha-hit, cellular dose, cell transformation and inactivation probability distributions of radon progenies in the bronchial epithelium. *Radiat Prot Dosimetry* 122(1-4):540-542.
- \*Taeger D, Fritsch A, Wiethage T, et al. 2006. Role of exposure to radon and silicosis on the cell type of lung carcinoma in German uranium miners. *Cancer* 106(4):881-889.
- \*Taheri M, Jafarizadeh M, Baradaran S, et al. 2006. Development of a high efficiency personal/environmental radon dosimeter using polycarbonate detectors. *J Radiol Prot* 26(4):389-395.
- \*Taskayev A, Popova O, Alexakhin R, et al. 1986. Root absorption of  $^{222}\text{Rn}$  and its transfer into above-ground plant organs. *Health Phys* 50:589-594.
- \*Taya A, Morgan A, Baker ST, et al. 1994. Changes in the rat lung after exposure to radon and its progeny: Effects on incorporation of bromodeoxyuridine in epithelial cells and on the incidence of nuclear aberrations in alveolar macrophages. *Radiat Res* 139(2):170-177.
- Taylor JA, Watson MA, Devereux TR, et al. 1994. p53 mutation hotspot in radon-associated lung cancer. (Comment in: *Lancet* 343(8900):795; 343(8906):1158-1159; 346(8967):121). *Lancet* 343(8889):86-87.
- \*Thomas K, Colborn T. 1992. Organochlorine endocrine disruptors in human tissue. In: Colborn T, Clement C, eds. *Chemically induced alterations in sexual and functional development: The wildlife/human connection*. Princeton, NJ: Princeton Scientific Publishing, 365-394.
- \*Thomas D, Pogoda J, Langholz B, et al. 1994. Temporal modifiers of the radon-smoking interaction. *Health Phys* 66(3):257-262.
- Thomassen DG, Newton GJ, Guilmette RA. 1992. Preneoplastic transformation of rat tracheal epithelial cells by inhaled radon progeny. *Indoor radon and lung cancer: Reality or myth? Twenty-ninth Hanford Symposium on health and the environment, October 15-19, 1990*. Columbus, OH: Battelle Press, 637-647.
- \*Thompson RE, Nelson DF, Popkin JH, et al. 2008. Case-control study of lung cancer risk from residential radon exposure in Worcester county, Massachusetts. *Health Phys* 94(3):228-241.
- Thorne R, Foreman NK, Mott MG. 1996. Radon in Devon and Cornwall and paediatric malignancies. (Comment in: *Eur J Cancer* 32A(2):201-204). *Eur J Cancer* 32A(2):282-285.
- \*Tirmarche M, Raphalen A, Allin F, et al. 1993. Mortality of a cohort of French uranium miners exposed to relatively low radon concentrations. *Br J Cancer* 67(5):1090-1097.
- \*Tirmarche M, Raphalen A, Chameaud J. 1992. Epidemiological study of French uranium miners. *Cancer Detect Prev* 16(3):169-172.
- Titov VC, Lashkov DP, Khaykovich IM, et al. 1997. Strategies for revealing dangerous concentrations of radon in buildings. *Appl Radiat Isot* 48(7):997-1001.
- Tobias C, Jones H, Lawrence J, et al. 1949. The uptake and elimination of Krypton and other inert gases by the human body. *J Clin Invest* 28:1375-1385.

## 9. REFERENCES

- \*Tomášek L. 2002. Czech miner studies of lung cancer risk from radon. *J Radiol Prot* 22(3A):A107-A112.
- \*Tomášek L, Darby SC. 1995. Recent results from the study of West Bohemian uranium miners exposed to radon and its progeny. *Environ Health Perspect* 103(Suppl 2):55-57.
- \*Tomášek L, Plaček V. 1999. Radon exposure and lung cancer risk: Czech cohort study. *Radiat Res* 152(Suppl 6):S59-S63.
- \*Tomášek L, Žárská H. 2004. Lung cancer risk among Czech tin and uranium miners--comparison of lifetime detriment. *Neoplasma* 51(4):255-260.
- \*Tomášek L, Darby SC, Fearn T, et al. 1994b. Patterns of lung cancer mortality among uranium miners in West Bohemia with varying rates of exposure to radon and its progeny. *Radiat Res* 137(2):251-261.
- \*Tomášek L, Darby SC, Swerdlow AJ, et al. 1993. Radon exposure and cancers other than lung cancer among uranium miners in West Bohemia. (Comment in: *Lancet* 342(8862):47). *Lancet* 341:919-923.
- \*Tomášek L, Kunz E, Müller T, et al. 2001. Radon exposure and lung cancer risk - Czech cohort study on residential radon. *Sci Total Environ* 272(1-3):43-51.
- \*Tomášek L, Rogel A, Tirmarche M, et al. 2008. Lung cancer in French and Czech uranium miners: Radon-associated risk at low exposure rates and modifying effects of time since exposure and age at exposure. *Radiat Res* 169(2):125-137.
- \*Tomášek L, Swerdlow AJ, Darby SC, et al. 1994a. Mortality in uranium miners in west Bohemia: A long-term cohort study. *Occup Environ Med* 51(5):308-315.
- Tracy BL, Krewski D, Chen J, et al. 2006. Assessment and management of residential radon health risks: A report from the health Canada radon workshop. *J Toxicol Environ Health A* 69(7):735-758.
- Tsoufanidis N. 1997. Residential radon and lung cancer in Sweden. (Comment on: *Health Phys* 72(2):269-276). *Health Phys* 73(2):393.
- \*Trapp E, Renzetti A, Kobayashi T, et al. 1970. Cardiopulmonary function in uranium miners. *Am Rev Respir Dis* 101:27-43.
- Turk BH, Harrison J, Prill RJ, et al. 1990. Developing soil gas and <sup>222</sup>Rn entry potentials for substructure surfaces and assessing <sup>222</sup>Rn control diagnostic techniques. *Health Phys* 59(4):405-419.
- Turk BH, Prill RJ, Fisk WJ, et al. 1991. Effectiveness of radon control techniques in fifteen homes. *J Air Waste Manage Assoc* 41(5):723-734.
- \*Tuschl H, Altmann H, Kovac R, et al. 1980. Effects of low-dose radiation on repair processes in human lymphocytes. *Radiat Res* 81:1-9.
- \*United Nations Scientific Committee on the Effects of Atomic Radiation. 1982. Ionizing radiation: Sources and biological effects. New York, NY: United Nations.



## 9. REFERENCES

- \*UNSCEAR. 2000. Annex B. Exposures from natural radiation sources. In: Sources and effects of ionizing radiation. United Nations Scientific Committee on the Effects of Atomic Radiation. <http://www.unscear.org/docs/reports/annexb.pdf>. August 28, 2008.
- Upfal MJ, Johnson GA, Jacobson AP, et al. 1990. Indoor radon and lung cancer in China. (Comment on: J Natl Cancer Inst 82(12):1025-1030). J Natl Cancer Inst 82(21):1722-1723.
- US DHHS. 1985. The health consequences of smoking. Cancer and chronic lung disease in the workplace -- a report of the Surgeon General. Chapter 11. Ionizing radiation and lung cancer.
- US DHEW. 1970. Radiological health handbook. Bureau of Radiological Health. U.S. Department of Health, Education and Welfare. Rockville, MD.
- \*USNRC. 2008a. Licensing requirements for land disposal of radioactive waste. U.S. Nuclear Regulatory Commission. Code of Federal Regulations. 10 CFR 61. <http://www.nrc.gov/reading-rm/doc-collections/cfr/part061/full-text.html>. May 13, 2008.
- \*USNRC. 2008c. Annual limits on intakes (ALIs) and derived air concentrations (DACs) of radionuclides for occupational exposure; effluent concentrations; concentrations for release to sewerage. U.S. Nuclear Regulatory Commission. Code of Federal Regulations. 10 CFR 20, Appendix B. <http://www.nrc.gov/reading-rm/doc-collections/cfr/part020/part020-appb.html>. April 24, 2008.
- \*Uzunov I, Steinhausler F, Pohl E. 1981. Carcinogenic risk of exposure to radon daughters associated with radon spas. Health Phys 41:807-813.
- \*Vacquier B, Caer S, Rogel A, et al. 2007. Mortality risk in the French cohort of uranium miners: Extended follow-up 1946-1999. Occup Environ Med [Epub ahead of print].
- \*Vaternahm T. 1922. Vergleichende untersuchungen über den emanationsgehalt der ausatemungsluft nach trinken von emanationshaltigem wasser und Öl. Z phys diät Ther 26:361-364.
- Vähäkangas KH. 2003. TP53 mutations in workers exposed to occupational carcinogens. Hum Mutat 21(3):240-251.
- Vähäkangas KH, Samet JM, Metcalf RA, et al. 1992. Mutations of p53 and ras genes in radon-associated lung cancer from uranium miners. Lancet 339(8793):576-580.
- Valentine RL, Stearns SW. 1994. Radon release from water distribution system deposits. Environ Sci Technol 28(3):534-537.
- Van Pelt WR. 2003. Epidemiological associations among lung cancer, radon exposure and elevation above sea level - a reassessment of Cohen's county level radon study. (Comment in: Health Phys 86(3):316-318, author reply 318). Health Phys 85(4):397-403.
- \*Veiga LH, Amaral EC, Colin D, et al. 2006. A retrospective mortality study of workers exposed to radon in a Brazilian underground coal mine. Radiat Environ Biophys 45(2):125-134.
- \*Veiga LH, Koifman S, Melo VP, et al. 2003. Preliminary indoor radon risk assessment at the Pocos de Caldas Plateau, MG-Brazil. J Environ Radioact 70(3):161-176.

## 9. REFERENCES

- Veiga LH, Melo V, Koifman S, et al. 2004. High radon exposure in a Brazilian underground coal mine. *J Radiol Prot* 24(3):295-305.
- Venitt S, Biggs PJ. 1994. Radon, mycotoxins, p53, and uranium mining. (Comment on: *Lancet* 343(8889):86-87). *Lancet* 343(8900):795.
- Vich Z, Brychtova V, Prochazka J, et al. 1973. Changes of some properties of erythrocytes in workers occupationally exposed to radon and its daughters products: Radiation effect or heavy metal poisoning? *Agressologie* 14:331-338.
- \*Vieira I, Sonnier M, Cresteil T. 1996. Developmental expression of CYP2E1 in the human liver: Hypermethylation control of gene expression during the neonatal period. *Eur J Biochem* 238(2):476-483.
- Viel JF. 1993. Radon exposure and leukaemia in adulthood. *Int J Epidemiol* 22(4):627-631.
- \*Vilenskiy V. 1969. Distribution of lead 210 and radium 226 in some soils. *Geokhimiya* 12:691-695.
- Villeneuve PJ, Morrison HI. 1997. Coronary heart disease mortality among Newfoundland fluorspar miners. *Scand J Work Environ Health* 23(3):221-226.
- \*Villeneuve PJ, Lane RS, Morrison HI. 2007a. Coronary heart disease mortality and radon exposure in the Newfoundland fluorspar miners' cohort, 1950-2001. *Radiat Environ Biophys* 46(3):291-296.
- Villeneuve PJ, Morrison HI, Lane R. 2007b. Radon and lung cancer risk: An extension of the mortality follow-up of the Newfoundland fluorspar cohort. *Health Phys* 92(2):157-169.
- Von Döbeln W, Lindell B. 1964. Some aspects of radon contamination following ingestion. *Arkiv Fys* 27:531-572.
- \*Vuković B, Faj D, Radolić V, et al. 2005. Indoor radon and lung cancer: A case-control study. *Isotopes Environ Health Stud* 41(2):169-176.
- \*Wadach J, Hess C. 1985. Radon-222 concentration measurements in soil using liquid scintillation and track etch. *Health Phys* 48:805-808.
- Wagner V, Andriškova J, Palet V, et al. 1978. The levels of immunoglobulins (IgG, IgA, IgM) under the effect of age and exposure to the mining environment in uranium industry. *Strahlentherapie* 154:406-412.
- Wagner V, Andriškova J, Sevc J. 1973. Investigation of immunoglobulin levels in blood-serum of uranium miners after a higher exposure to ionizing radiation. In: Bujdosó E (ed). *Health physics problems of internal contamination*. Budapest: Akademiai Kiadó, 341-347.
- \*Wagoner J, Archer V, Carroll B, et al. 1964. Cancer mortality patterns among U.S. uranium miners and millers, 1950 through 1962. *J Natl Cancer Inst* 32:787-801.
- \*Wagoner J, Miller R, Lundin F, et al. 1963. Unusual cancer mortality among a group of underground metal miners. *New Engl J Med* 269:284-289.
- Wakefield M, Kohler JA. 1991. Indoor radon and childhood cancer. (Comment on: *Lancet* 335(8696):1008-1012). *Lancet* 338(8781):1537-1538.

## 9. REFERENCES

- \*Wang RY, Chiang WK. 1998. Radiation poisoning. In: Haddad LM, Shannon MW, Winchester JF, eds. *Clinical management of poisoning and drug overdose*. 3rd ed. Philadelphia, PA: W.B Sanders Company, 413-425.
- \*Wang Z, Lubin JH, Wang L, et al. 2002. Residential radon and lung cancer risk in a high-exposure area of Gansu Province, China. *Am J Epidemiol* 155(6):554-564.
- \*Ward JF. 1988. DNA damage produced by ionizing radiation in mammalian cells: Identities, mechanism of formation, and repairability. *Prog Nucl Acid Res Mol Biol* 35:95-125.
- \*Ward JF. 1990. The yield of DNA double-strand breaks produced intracellularly by ionizing radiation: A review. *Int J Radiat Biol* 57:1141-1150.
- \*Waselenko JK, MacVittle TJ, Blakely WF, et al. 2004. Medical management of the acute radiation syndrome: Recommendations of the strategic National Stockpile Radiation Working Group. *Ann Intern Med* 140(12):1037-1055.
- Watson JE, Adams WC, Xie Y, et al. 1988. Survey of  $^{222}\text{Rn}$  in North Carolina USA homes. *Health Phys* 55(1):71-76.
- \*Watson JE, Evans JP, Mabry AM. 1993. Analysis of  $^{222}\text{Rn}$  concentration in North Carolina household water supplies derived from private wells. *Health Phys* 65(2):156-160.
- Watts G. 2005. Radon blues. (Comment on: *BMJ* 330(7485):223). *Br Med J* 330(7485):226-227.
- \*Waxweiler R, Roscoe R, Archer V, et al. 1981. Mortality follow-up through 1977 of the white underground uranium miners cohort examined by the United States Public Health Service. In: Gomez M, ed. *International conference: Radiation hazards in mining*. New York, NY: Society of Mining Engineers of American Institute of Mining, Metallurgical, and Petroleum Engineers, Inc., 823-830.
- \*Weast R. 1980. *CRC handbook of chemistry and physics*. Boca Raton, FL: CRC Press, Inc., B-19, B-119.
- Weaver DA, Hei TK, Hukku B, et al. 1997. Cytogenetic and molecular genetic analysis of tumorigenic human bronchial epithelial cells induced by radon alpha particles. *Carcinogenesis* 18(6):1251-1257.
- \*Weissbuch H, Gradinaru M, Mihail G. 1980. Correlation between concentrations of  $^{210}\text{Pb}$  in the biologic samples from miners and individual levels of exposure to short lived radon-222 daughter products. In: *Radiation protection*. Vol 2. New York, NY: Pergamon Press, 1072-1074.
- \*West JR, Smith HW, Chasis H. 1948. Glomerular filtration rate, effective renal blood flow, and maximal tubular excretory capacity in infancy. *J Pediatr* 32:10-18.
- \*White SB, Bergsten JW, Alexander BV, et al. 1992. Indoor  $^{222}\text{Rn}$  concentrations in a probability sample of 43,000 houses across 30 states. *Health Phys* 62(1):41-50.
- Whittemore A, McMillan A. 1983. Lung cancer mortality among U.S. uranium miners: A reappraisal. *J Natl Cancer Inst* 71:489-499.
- \*WHO. 1983. *Selected radionuclides. Environmental Health Criteria 25*. Geneva: World Health Organization.

## 9. REFERENCES

- \*WHO. 2000. Air quality guidelines. 2nd ed. Geneva, Switzerland: World Health Organization. <http://www.euro.who.int/Document/AIQ/AirQualRepMtg.pdf>. March 08, 2006.
- \*WHO. 2004. Guidelines for drinking-water quality. Vol. 1. Recommendations. 3rd ed. Geneva, Switzerland: World Health Organization. [http://www.who.int/water\\_sanitation\\_health/dwq/gdwq3/en/](http://www.who.int/water_sanitation_health/dwq/gdwq3/en/). March 08, 2006.
- \*Wichmann HE, Rosario AS, Heid IM, et al. 2005. Increased lung cancer risk due to residential radon in a pooled and extended analysis of studies in Germany. *Health Phys* 88(1):71-79.
- \*Widdowson EM, Dickerson JWT. 1964. Chemical composition of the body. In: Comar CL, Bronner F, eds. Mineral metabolism: An advanced treatise. Vol. II: The elements Part A. New York, NY: Academic Press, 1-247.
- \*Wiese W, Skipper B. 1986. Survey of reproductive outcomes in uranium and potash mine workers: Results of first analysis. *Ann Am Conf Gov Ind Hyg* 14:187-192.
- Wiethage T, Wesch H, Wegener K, et al. 1999. German uranium miner study - pathological and molecular genetic findings. German Uranium Miner Study, Research Group Pathology. *Radiat Res* 152(Suppl 6):S52-S55.
- \*Wilcox HB, Al-Zoughool M, Garner MJ, et al. 2008. Case-control study of radon and lung cancer in New Jersey. *Radiat Prot Dosimetry* 128(2):169-179.
- Windholz M. 1983. The Merck index. 10th edition. Rahway, NJ: Merck and Company, Inc., 1171.
- Wolff SP. 1991. Radon and socioeconomic indicators. (Comment on: *Lancet* 337(8751):1187-1189). *Lancet* 337(8755):1476.
- Wolff S, Afzal V, Jostes RF, et al. 1993. Indications of repair of radon-induced chromosome damage in human lymphocytes: An adaptive response induced by low doses of X-rays. *Environ Health Perspect* 101(Suppl 3):73-77.
- \*Wolff S, Jostes R, Cross FT, et al. 1991. Adaptive response of human lymphocytes for the repair of radon-induced chromosomal damage. *Mutat Res* 250(1-2):299-306.
- \*Woodward A, Roder D, McMichael AJ, et al. 1991. Radon daughter exposures at the Radium Hill uranium mine and lung cancer rates among former workers, 1952-87. *Cancer Causes Control* 2(4):213-220.
- Wozniak SJ. 1992. Lung cancer and radon. (Comment in: *BMJ* 305(6846):181). *BMJ* 304(6841):1571.
- \*Xuan XZ, Lubin JH, Li JY, et al. 1993. A cohort study in southern China of tin miners exposed to radon and radon decay products. *Health Phys* 64(2):120-131.
- Yamada Y, Oghiso Y, Morlier JP, et al. 2004. Comparative study on *Tp53* gene mutations in lung tumors from rats exposed to <sup>239</sup>Pu, <sup>237</sup>Np and <sup>222</sup>Rn. *J Radiat Res (Tokyo)*45(1):69-76.
- Yamaoka K, Komoto Y, Suzuka I, et al. 1992. Effects of inhalation of radon spring water on biological functions - sod activities, lipid peroxides, and membrane fluidity. In: Yagi K, Kondo M, Niki E, et al.

## 9. REFERENCES

eds. Oxygen radicals. Proceedings of the 5th International Congress on oxygen radicals: Active oxygen, lipid peroxides and antioxidants, Kyoto, 17-21 November 1991. Amsterdam, Netherlands: Elsevier Science Publishers B.V, 777-780.

Yamaoka K, Komoto Y, Suzuka I, et al. 1993. Effects of radon inhalation on biological function--lipid peroxide level, superoxide dismutase activity, and membrane fluidity. *Arch Biochem Biophys* 302(1):37-41.

Yamaoka K, Mitsunobu F, Hanamoto K, et al. 2004a. Biochemical comparison between radon effects and thermal effects on humans in radon hot spring therapy. *J Radiat Res (Tokyo)*45(1):83-88.

Yamaoka K, Mitsunobu F, Hanamoto K, et al. 2004b. Study on biologic effects of radon and thermal therapy on osteoarthritis. *J Pain* 5(1):20-25.

\*Yang I. 1987. Sampling and analysis of dissolved radon-222 in surface and ground water. In: Graves B, ed. Radon, radium, and other radioactivity in ground water. Chelsea, MI: Lewis Publishers, 193-203.

Yang M, Ye C, Yao S, et al. 1999. Preliminary studies on tin miners' lung cancer tissue related genes by differential display mRNA. *Chin Med J (Engl)*112(6):529-533.

Yang Q, Wesch H, Mueller KM, et al. 2000. Analysis of radon-associated squamous cell carcinomas of the lung for a p53 gene hotspot mutation. *Br J Cancer* 82(4):763-766.

\*Yao SX, Lubin JH, Qiao YL, et al. 1994. Exposure to radon progeny, tobacco use and lung cancer in a case-control study in southern China. *Radiat Res* 138(3):326-336.

Yarmoshenko IV, Kirdin IA, Zhukovsky MV, et al. 2005. Meta-analysis of twenty radon and lung cancer case-control studies. *Radioact Environ* 7:762-771.

Ye W, Sobue T, Lee VS, et al. 1998. Mortality and cancer incidence in Misasa, Japan, a spa area with elevated radon levels. *Jpn J Cancer Res* 89(8):789-796.

Yeh HC, Cheng YS, Su YF, et al. 1992. Deposition of radon progeny in nonhuman primate nasal airways. Indoor radon and lung cancer: Reality or myth? Twenty-ninth Hanford Symposium on health and the environment, October 15-19, 1990. Columbus, OH: Battelle Press, 235-248.

Yngveson A, Williams C, Hjerpe A, et al. 1999. p53 Mutations in lung cancer associated with residential radon exposure. *Cancer Epidemiol Biomarkers Prev* 8(5):433-438.

Yu D, Kim JK. 2004. A physiologically based assessment of human exposure to radon released from groundwater. *Chemosphere* 54(5):639-645.

Yu KN, Guan ZJ. 1998. A portable bronchial dosimeter for radon progenies. *Health Phys* 75(2):147-152.

Yu KN, Guan ZJ, Young EC, et al. 1998. Measurement of tracheobronchial dose from simultaneous exposure to environmental radon and thoron progeny. *Health Phys* 75(2):153-158.

\*Yu KN, Lau BM, Nikezic D. 2006. Assessment of environmental radon hazard using human respiratory tract models. *J Hazard Mater* 132(1):98-110.

## 9. REFERENCES

- Yu-tang L, Zhen C. 1996. A retrospective lung cancer mortality study of people exposed to insoluble arsenic and radon. *Lung Cancer* 14(Suppl 1):S137-S148.
- Zhiheng T, Detac X, Fuqi Z, et al. 1994. Passive radon monitoring techniques with and without electret collection. *J Radiol Prot* 14(3):241-249.
- Zhou H, Zhu LX, Li K, et al. 1999. Radon, tobacco-specific nitrosamine and mutagenesis in mammalian cells. *Mutat Res* 430(1):145-153.
- \*Ziegler EE, Edwards BB, Jensen RL, et al. 1978. Absorption and retention of lead by infants. *Pediatr Res* 12(1):29-34.
- Zielinski J, Field RW. 2006. Residential radon and lung cancer - preface. *J Toxicol Environ Health* 69(7-8):525-526.

## 10. GLOSSARY

**Some terms in this glossary are generic and may not be used in this profile.**

**Absorbed Dose, Chemical**—The amount of a substance that is either absorbed into the body or placed in contact with the skin. For oral or inhalation routes, this is normally the product of the intake quantity and the uptake fraction divided by the body weight and, if appropriate, the time, expressed as mg/kg for a single intake or mg/kg/day for multiple intakes. For dermal exposure, this is the amount of material applied to the skin, and is normally divided by the body mass and expressed as mg/kg.

**Absorbed Dose, Radiation**—The mean energy imparted to the irradiated medium, per unit mass, by ionizing radiation. Units: rad (rad), gray (Gy).

**Absorbed Fraction**—A term used in internal dosimetry. It is that fraction of the photon energy (emitted within a specified volume of material) which is absorbed by the volume. The absorbed fraction depends on the source distribution, the photon energy, and the size, shape and composition of the volume.

**Absorption**—The process by which a chemical penetrates the exchange boundaries of an organism after contact, or the process by which radiation imparts some or all of its energy to any material through which it passes.

**Self-Absorption**—Absorption of radiation (emitted by radioactive atoms) by the material in which the atoms are located; in particular, the absorption of radiation within a sample being assayed.

**Absorption Coefficient**—Fractional absorption of the energy of an unscattered beam of x- or gamma-radiation per unit thickness (linear absorption coefficient), per unit mass (mass absorption coefficient), or per atom (atomic absorption coefficient) of absorber, due to transfer of energy to the absorber. The total absorption coefficient is the sum of individual energy absorption processes (see Compton Effect, Photoelectric Effect, and Pair Production).

**Absorption Coefficient, Linear**—A factor expressing the fraction of a beam of x- or gamma radiation absorbed in a unit thickness of material. In the expression  $I = I_0 e^{-\mu x}$ ,  $I_0$  is the initial intensity,  $I$  the intensity of the beam after passage through a thickness of the material  $x$ , and  $\mu$  is the linear absorption coefficient.

**Absorption Coefficient, Mass**—The linear absorption coefficient per cm divided by the density of the absorber in grams per cubic centimeter. It is frequently expressed as  $\mu/\rho$ , where  $\mu$  is the linear absorption coefficient and  $\rho$  the absorber density.

**Absorption Ratio, Differential**—Ratio of concentration of a nuclide in a given organ or tissue to the concentration that would be obtained if the same administered quantity of this nuclide were uniformly distributed throughout the body.

**Activation**—The process of making a material radioactive by bombardment with neutrons or protons.

**Activity**—The number of radioactive nuclear transformations occurring in a material per unit time (see Curie, Becquerel). The term for activity per unit mass is specific activity.

**Activity Median Aerodynamic Diameter (AMAD)**—The diameter of a unit-density sphere with the same terminal settling velocity in air as that of the aerosol particle whose activity is the median for the entire size distribution of the aerosol.

## 10. GLOSSARY

**Acute Exposure, Chemical**—Exposure to a chemical for a duration of 14 days or less, as specified in the Toxicological Profiles.

**Acute Exposure, Radiation**—The absorption of a relatively large amount of radiation (or intake of a radioactive material) over a short period of time.

**Acute Radiation Syndrome**—The symptoms which taken together characterize a person suffering from the effects of intense radiation. The effects occur within hours or days.

**Ad libitum**—Available in excess and freely accessible.

**Adsorption Coefficient ( $K_{oc}$ )**—The ratio of the amount of a chemical adsorbed per unit surface area or per unit weight of organic carbon of a specific particle size in the soil or sediment to the concentration of the chemical in solution at equilibrium.

**Adsorption Ratio ( $K_d$ )**—See Distribution Coefficient

**Alpha Particle**—A positively charged particle ejected spontaneously from the nuclei of some radioactive elements. It is identical to a helium nucleus, i.e., 2 neutrons and two protons, with a mass number of 4 and an electrostatic charge of +2.

**Alpha Track**—The track of ionized atoms (pattern of ionization) left in a medium by an alpha particle that has traveled through the medium.

**Annihilation (Positron-Electron)**—An interaction between a positive and a negative electron in which they both disappear; their rest mass, being converted into electromagnetic radiation (called annihilation radiation) with two 0.51 MeV gamma photons emitted at an angle of 180° to each other.

**Annual Limit on Intake (ALI)**—The derived limit for the amount of radioactive material taken into the body of an adult worker by inhalation or ingestion in a year. It is the smaller value of intake of a given radionuclide in a year by the reference man that would result in a committed effective dose equivalent of 5 rem or a committed dose equivalent of 50 rem to any organ or tissue.

**Atom**—The smallest particle of an element that cannot be divided or broken up by chemical means. It consists of a central core called the *nucleus*, which contains *protons* and *neutrons* and an outer shell of *electrons*.

**Atomic Mass ( $u$ )**—The mass of a neutral atom of a nuclide, usually expressed in terms of "atomic mass units." The "atomic mass unit" is one-twelfth the mass of one neutral atom of carbon-12; equivalent to  $1.6604 \times 10^{-24}$  g.

**Atomic Mass Number**—See Mass Number.

**Atomic Number**—The number of protons in the nucleus of an atom. The "effective atomic number" is calculated from the composition and atomic numbers of a compound or mixture. An element of this atomic number would interact with photons in the same way as the compound or mixture. (Symbol: Z).

**Atomic Weight**—The weighted mean of the masses of the neutral isotopes of an element expressed in atomic mass units.



## 10. GLOSSARY

**Attenuation**—A process by which a beam from a source of radiation is reduced in intensity by absorption and scattering when passing through some material.

**Attenuation Coefficient**—The fractional reduction in the intensity of a beam of radiation as it passes through an absorbing medium. It may be expressed as reduction per unit distance, per unit mass thickness, or per atom, and is called the linear, mass, or atomic attenuation coefficient, respectively.

**Auger Effect**—The emission of an electron from the extranuclear portion of an excited atom when the atom undergoes a transition to a less excited state.

**Background Radiation**—The amount of radiation to which a member of the general population is exposed from natural sources, such as terrestrial radiation from naturally occurring radionuclides in the soil, cosmic radiation originating from outer space, and naturally occurring radionuclides deposited in the human body.

**Becquerel (Bq)**—International System of Units unit of activity and equals that quantity of radioactive material in which one transformation (disintegration) occurs per second (see Units).

**Terabecquerel (TBq)**—One trillion becquerel.

**Gigabecquerel (GBq)**—One billion becquerel.

**Megabecquerel (MBq)**—One million becquerel.

**Kilobecquerel (kBq)**—One thousand becquerel.

**Millibecquerel (mBq)**—One-thousandth of a becquerel.

**Microbecquerel ( $\mu$ Bq)**—One-millionth of a becquerel.

**Benchmark Dose (BMD)**—Usually defined as the lower confidence limit on the dose that produces a specified magnitude of changes in a specified adverse response. For example, a BMD<sub>10</sub> would be the dose at the 95% lower confidence limit on a 10% response, and the benchmark response (BMR) would be 10%. The BMD is determined by modeling the dose response curve in the region of the dose response relationship where biologically observable data are feasible.

**Benchmark Dose Model**—A statistical dose-response model applied to either experimental toxicological or epidemiological data to calculate a BMD.

**Beta Particle**—An electron that is emitted from the nucleus of an atom during one type of radioactive transformation. A beta particle has a mass and charge equal in magnitude to that of the electron. The charge may be either +1 or -1. Beta particles with +1 charges are called positrons (symbolized  $\beta^+$ ), and beta particles with -1 charges are called negatrons (symbolized  $\beta^-$ ).

**Bioconcentration Factor (BCF)**—The quotient of the concentration of a chemical in aquatic organisms at a specific time or during a discrete time period of exposure divided by the concentration in the surrounding water at the same time or during the same period.

**Biologic Effectiveness of Radiation**—See Relative Biological Effectiveness.

**Biological Half-time**—The time required for a biological system, such as that of a human, to eliminate by natural process half of the amount of a substance (such as a chemical substance, either stable or radioactive) that has entered it.

**Biomagnification**—The progressive increase in the concentration of a bioaccumulated chemical in organisms as that chemical is passed from the bottom to the top of the food web.

## 10. GLOSSARY

**Biomarkers**—Broadly defined as indicators signaling events in biologic systems or samples. They have been classified as markers of exposure, markers of effect, and markers of susceptibility.

**Body Burden, Chemical**—The total amount of a chemical found in an animal or human body.

**Body Burden, Radioactivity**—The amount of radioactive material found in an animal or human body.

**Bone Seeker**—Any compound or ion which migrates in the body and preferentially deposits into bone.

**Branching**—The occurrence of two or more modes by which a radionuclide can undergo radioactive decay. For example,  $^{214}\text{Bi}$  can undergo alpha or beta minus decay,  $^{64}\text{Cu}$  can undergo beta minus, beta plus, or electron capture decay. An individual atom of a nuclide exhibiting branching disintegrates by one mode only. The fraction disintegrating by a particular mode is the "branching fraction" for that mode. The "branching ratio" is the ratio of two specified branching fractions (also called multiple disintegration).

**Bremsstrahlung**—X rays that are produced when a charged particle accelerates (speeds up, slows down, or changes direction) in the strong field of a nucleus.

**Buildup Factor**—The ratio of the radiation intensity, including both primary and scattered radiation, to the intensity of the primary (unscattered) radiation.

**Cancer Effect Level (CEL)**—The lowest dose of chemical or radiation in a study, or group of studies, that produces significant increases in the incidence of cancer (or tumors) between the exposed population and its appropriate control.

**Capture, Electron**—A mode of radioactive decay involving the capture of an orbital electron by its nucleus. Capture from a particular electron shell, e.g., K or L shells, is designated as "K-electron capture" or "L-electron capture."

**Capture, K-Electron**—Electron capture from the K shell by the nucleus of the atom. Also loosely used to designate any orbital electron capture process.

**Carcinogen**—A chemical or radiation that is capable of inducing cancer.

**Carcinoma**—Malignant neoplasm composed of epithelial cells, regardless of their derivation.

**Case-Control Study**—A type of epidemiological study which examines the relationship between a particular outcome (disease or condition) and a variety of potential causative agents (such as toxic chemicals). In a case-controlled study, a group of people with a specified and well-defined outcome is identified and compared to a similar group of people without outcome.

**Case Report**—Describes a single individual with a particular disease or exposure. These may suggest some potential topics for scientific research but are not actual research studies.

**Case Series**—Describes the experience of a small number of individuals with the same disease or exposure. These may suggest potential topics for scientific research, but are not actual research studies.

**Cataract**—A clouding of the crystalline lens of the eye which obstructs the passage of light.

**Ceiling Value**—A concentration of a substance that should not be exceeded, even temporarily.

## 10. GLOSSARY

**Charged Particle**—A nuclear particle, atom, or molecule carrying a positive or negative charge.

**Chronic Exposure**—A long-term, continuous exposure to a chemical or radioactive material. For example, exposure to a chemical for 365 days or more, as specified in the Toxicological Profiles.

**Cohort Study**—A type of epidemiological study of a specific group or groups of people who have had a common insult (e.g., exposure to an agent suspected of causing disease or a common disease) and are followed forward from exposure to outcome. At least one exposed group is compared to one unexposed group.

**Collective Dose**—The sum of the individual doses received in a given period of time by a specified population from exposure to a specified source of radiation. Collective dose is expressed in units such as man-rem and person-sievert.

**Compton Effect**—An attenuation process observed for x- or gamma radiation in which an incident photon interacts with an orbital electron of an atom to produce a recoil electron and a scattered photon whose energy is less than the incident photon.

**Containment**—The confinement of a chemical or radioactive substance in such a way that it is prevented from being dispersed from its container or into the environment, or is released only at a specified rate.

**Contamination**—Deposition of a stable or radioactive substance in any place where it is not desired.

**Cosmic Rays**—High-energy particulate and electromagnetic radiations that originate outside the earth's atmosphere and interact with the atmosphere to produce a shower of secondary cosmic rays.

**Count (Radiation Measurements)**—The external indication of a radiation-measuring device designed to enumerate ionizing events. It refers to a single detected event. The term "count rate" refers to the total number registered in a given period of time. The term is sometimes erroneously used to designate a disintegration, ionizing event, or voltage pulse.

**Counter, Gas-flow Proportional (GPC)**—An instrument for detecting beta particle radiation. Beta particles are detected by ionization of the counter gas which results in an electrical impulse at an anode wire.

**Counter, Geiger-Mueller (GM counter)**—Highly sensitive, gas-filled radiation-measuring device that detects (counts) individual photons or particulate radiation.

**Counter, Scintillation**—The combination of a crystal or phosphor, photomultiplier tube, and associated circuits for counting light emissions produced in the phosphors by ionizing radiation. Scintillation counters generally are more sensitive than GM counters for gamma radiation.

**Counting, Cerenkov**—Relatively energetic  $\beta$ -particles pass through a transparent medium of high refractive index and a highly-directional, bluish-white light ("Cerenkov" light) is emitted. This light is detected using liquid scintillation counting equipment.

**Cross-sectional Study**—A type of epidemiological study of a group or groups which examines the relationship between exposure and outcome to a chemical or to chemicals at one point in time.

## 10. GLOSSARY

**Curie (Ci)**—A unit of radioactivity. One curie equals that quantity of radioactive material in which there are  $3.7 \times 10^{10}$  nuclear transformations per second. The activity of 1 gram of radium is approximately 1 Ci.

**Attocurie (aCi)**—One-thousandth of a femtocurie ( $3.7 \times 10^{-8}$  disintegrations per second).

**Femtocurie (fCi)**—One-billionth of a microcurie ( $3.7 \times 10^{-5}$  disintegrations per second).

**Megacurie (MCi)**—One million curies ( $3.7 \times 10^{16}$  disintegrations per second).

**Microcurie ( $\mu$ Ci)**—One-millionth of a curie ( $3.7 \times 10^4$  disintegrations per second).

**Millicurie (mCi)**—One-thousandth of a curie ( $3.7 \times 10^7$  disintegrations per second).

**Nanocurie (nCi)**—One-billionth of a curie ( $3.7 \times 10^1$  disintegrations per second).

**Picocurie (pCi)**—One-millionth of a microcurie ( $3.7 \times 10^{-2}$  disintegrations per second).

**Data Needs**—Substance-specific informational needs that if met would reduce the uncertainties of human health assessment.

**Daughter Products**—See Progeny and Decay Product

**Decay Chain or Decay Series**—A sequence of radioactive decays (transformations) beginning with one nucleus. The initial nucleus, the parent, decays into a daughter or progeny nucleus that differs from the first by whatever particles were emitted during the decay. If further decays take place, the subsequent nuclei are also usually called daughters or progeny. Sometimes, to distinguish the sequence, the daughter of the first daughter is called the granddaughter, etc.

**Decay Constant ( $\lambda$ )**—The fraction of the number of atoms of a radioactive nuclide which decay in unit time (see Disintegration Constant).

**Decay Product, Daughter Product, Progeny**—A new nuclide formed as a result of radioactive decay. A nuclide resulting from the radioactive transformation of a radionuclide, formed either directly or as the result of successive transformations in a radioactive series. A decay product (daughter product or progeny) may be either radioactive or stable.

**Decay, Radioactive**—Transformation of the nucleus of an unstable nuclide by spontaneous emission of radiation, such as charged particles and/or photons (see Disintegration).

**Delta Ray**—An electron removed from an atom of a medium that is irradiated, or through which radiation passes, during the process of ionization (also called secondary electron). Delta rays cause a track of ionizations along their path.

**Derived Air Concentration (DAC)**—The concentration of radioactive material in air that, if breathed by the reference man for a working year of 2000 hours under conditions of light work (at a rate of 1.2 liters of air per hour), would result in an intake of one ALI (see Annual Limit on Intake).

**Deterministic Effect**—A health effect, the severity of which varies with the dose and for which a threshold is believed to exist (also called a non-stochastic effect).

**Developmental Toxicity**—The occurrence of adverse effects on the developing organism that may result from exposure to a chemical or radiation prior to conception (either parent), during prenatal development, or postnatally to the time of sexual maturation. Adverse developmental effects may be detected at any point in the life span of the organism.

**Disintegration Constant**—Synonymous with decay constant. The fraction of the number of atoms of a radioactive material that decays per unit time (see Decay Constant.)

## 10. GLOSSARY

**Disintegration, Nuclear**—A spontaneous nuclear transformation (radioactivity) characterized by the emission of energy and mass from the nucleus. When large numbers of nuclei are involved, the process is characterized by a definite half-life (see Transformation, Nuclear).

**Distribution Coefficient ( $K_d$ )**—Describes the distribution of a chemical between the solid and aqueous phase at thermodynamic equilibrium, is given as follows:

$$K_d = \frac{[C]_s}{[C]_w}, \text{ Units} = (\text{L solution})/(\text{kg solid}),$$

where  $[C]_s$  is the concentration of the chemical associated with the solid phase in units of (mg)/(kg solid), and  $[C]_w$  is the concentration of the chemical in the aqueous phase in units of (mg)/(L solution). As the magnitude of  $K_d$  decreases, the potential mobility of the chemical to groundwater systems increases and vice versa.

**Dose**—A general term denoting the quantity of a substance, radiation, or energy absorbed. For special purposes it must be appropriately qualified. If unqualified, it refers to radiation absorbed dose.

**Absorbed Dose**—The energy imparted to matter by ionizing radiation per unit mass of irradiated material at the place of interest. The unit of absorbed dose is the rad. One rad equals 100 ergs per gram. In SI units, the absorbed dose is the gray which is 1 J/kg (see Rad).

**Cumulative Dose (Radiation)**—The total dose resulting from repeated or continuous exposures to radiation.

**Dose Assessment**—An estimate of the radiation dose to an individual or a population group usually by means of predictive modeling techniques, sometimes supplemented by the results of measurement.

**Dose Equivalent (DE)**—A quantity used in radiation safety practice to account for the relative biological effectiveness of the several types of radiation. It expresses all radiations on a common scale for calculating the effective absorbed dose. The NRC defines it as the product of the absorbed dose, the quality factor, and all other modifying factors at the location of interest. ICRP has changed its definition to be the product of the absorbed dose and the radiation weighting factor. (The unit of dose equivalent is the rem. In SI units, the dose equivalent is the sievert, which equals 100 rem.)

**Dose, Fractionation**—A method of administering therapeutic radiation in which relatively small doses are given daily or at longer intervals.

**Dose, Protraction**—A method of administering therapeutic radiation by delivering it continuously over a relatively long period at a low dose rate.

**Dose, Radiation**—The amount of energy imparted to matter by ionizing radiation per unit mass of the matter, usually expressed as the unit rad, or in SI units, the gray. 100 rad=1 gray (Gy) (see Absorbed Dose).

**Committed Dose Equivalent ( $H_{T,50}$ )**—The dose equivalent to organs or tissues of reference (T) that will be received from an intake of radioactive material by an individual during the 50 years following the intake.

## 10. GLOSSARY

**Committed Effective Dose Equivalent ( $H_{E,50}$ )**—The sum of the products of the weighting factors applicable to each of the body organs or tissues that are irradiated and the committed dose equivalent to those organs or tissues.

**Effective Dose** —A dose value that attempts to normalize the detriment to the body (for cancer mortality and morbidity, hereditary effects, and years of life lost) from a non-uniform exposure to that of a uniform whole body exposure. Effective dose is calculated as the sum of products of the equivalent dose and the tissue weighting factor ( $w_T$ ) for each tissue exposed. ( $E = \sum D_{T,R} w_R w_T$ ).

**Effective Dose Equivalent ( $H_E$ )**—This dose type is limited to internal exposures and is the sum of the products of the dose equivalent to the organ or tissue ( $H_T$ ) and the weighting factors ( $w_T$ ) applicable to each of the body organs or tissues that are irradiated. ( $H_E = \sum w_T H_T$ ).

**Equivalent Dose**—A dose quantity that places the biological effect of all radiation types on a common scale for calculating tissue damage. Alpha particles, for example, are considered to cause 20 times more damage than gamma rays. Equivalent dose is calculated as the sum of products of the average absorbed dose (in gray) in an organ or tissue ( $D_{T,R}$ ) from each type of radiation and the radiation weighting factor ( $w_R$ ) for that radiation ( $\sum D_{T,R} w_R$ ).

**External Dose**—That portion of the dose equivalent received from radiation sources outside the body.

**Internal Dose**—That portion of the dose equivalent received from radioactive material taken into the body.

**Limit**—A permissible upper bound on the radiation dose.

**Maximum Permissible Dose (MPD)**—The greatest dose equivalent that a person or specified part thereof shall be allowed to receive in a given period of time.

**Median Lethal Dose (MLD)**—Dose of radiation required to kill, within a specified period (usually 30 days), 50% of the individuals in a large group of animals or organisms. Also called the  $LD_{50}$ , or  $LD_{50/30}$  if for 30 days.

**Threshold Dose**—The minimum absorbed dose that will produce a detectable degree of any given effect.

**Tissue Dose**—Absorbed dose received by tissue in the region of interest, expressed in rad (see Dose, Gray, and Rad).

**Dose Rate**—The amount of radiation dose delivered per unit time. Generically, the rate at which radiation dose is delivered to any material or tissue.

**Dose-Response Relationship**—The quantitative relationship between the amount of exposure to a toxicant and the incidence of the adverse effects.

**Dosimetry**—Quantification of radiation doses to cells, tissues, organs, individuals or populations resulting from radiation exposures.

**Early Effects (of radiation exposure)**—Effects that appear within 60 days of an acute exposure.

## 10. GLOSSARY

**Electron**—A stable elementary particle having an electric charge equal to  $\pm 1.60210 \times 10^{-19}$  C (Coulombs) and a rest mass equal to  $9.1091 \times 10^{-31}$  kg. A positron is a positively charged "electron" (see Positron).

**Electron Volt**—A unit of energy equivalent to the energy gained by an electron in passing through a potential difference of one volt. Larger multiple units of the electron volt are frequently used: keV for thousand or kilo electron volts; MeV for million or mega electron volts (eV).  $1 \text{ eV} = 1.6 \times 10^{-12}$  erg.

**Embryotoxicity and Fetotoxicity**—Any toxic effect on the conceptus as a result of prenatal exposure to a chemical; the distinguishing feature between the two terms is the stage of development during which the insult occurred. The terms, as used here, include malformations and variations, altered growth, and *in utero* death.

**Energy**—Capacity for doing work. Gravitationally, "potential energy" is the energy inherent in a mass because of its spatial relation to other masses. Chemically or radiologically, "potential energy" is the energy released when a chemical reaction or radiological transformation goes to completion. "Kinetic energy" is the energy possessed by a mass because of its motion (SI unit: joules):

**Binding Energy (Electron)**—The amount of energy that must be expended to remove an electron from an atom.

**Binding Energy (Nuclear)**—The energy represented by the difference in mass between the sum of the component parts and the actual mass of the nucleus. It represents the amount of energy that must be expended to break a nucleus into its component neutrons and protons.

**Excitation Energy**—The energy required to change a system from its ground state to an excited state. Each different excited state has a different excitation energy.

**Ionizing Energy**—The energy required to knock an electron out of an atom. The average energy lost by electrons or beta particles in producing an ion pair in air or in soft tissue is about 34 eV.

**Radiant Energy**—The energy of electromagnetic radiation, such as radio waves, visible light, x and gamma rays.

**Enrichment, Isotopic**—An isotopic separation process by which the relative abundances of the isotopes of a given element are altered, thus producing a form of the element that has been enriched in one or more isotopes and depleted in others. In uranium enrichment, the percentage of uranium-235 in natural uranium can be increased from 0.7% to >90% in a gaseous diffusion process based on the different thermal velocities of the constituents of natural uranium ( $^{234}\text{U}$ ,  $^{235}\text{U}$ ,  $^{238}\text{U}$ ) in the molecular form  $\text{UF}_6$ .

**EPA Health Advisory**—An estimate of acceptable drinking water levels for a chemical substance based on health effects information. A health advisory is not a legally enforceable federal standard, but serves as technical guidance to assist federal, state, and local officials.

**Epidemiology**—Refers to the investigation of factors that determine the frequency and distribution of disease or other health-related conditions within a defined human population during a specified period.

**Equilibrium, Radioactive**—In a radioactive series, the state which prevails when the ratios between the activities of two or more successive members of the series remains constant.

**Secular Equilibrium**—If a parent element has a very much longer half-life than the daughters (so there is not appreciable change in its amount in the time interval required for later products to

## 10. GLOSSARY

attain equilibrium) then, after equilibrium is reached, equal numbers of atoms of all members of the series disintegrate in unit time. This condition is never exactly attained, but is essentially established in such a case as  $^{226}\text{Ra}$  and its transformation series to stable  $^{206}\text{Pb}$ . The half-life of  $^{226}\text{Ra}$  is about 1,600 years; of  $^{222}\text{Rn}$ , approximately 3.82 days, and of each of the subsequent members, a few minutes. After about a month, essentially the equilibrium amount of radon is present; then (and for a long time) all members of the series disintegrate the same number of atoms per unit time. At this time, the activity of the daughter is equal to the activity of the parent.

**Transient Equilibrium**—If the half-life of the parent is short enough so the quantity present decreases appreciably during the period under consideration, but is still longer than that of successive members of the series, a stage of equilibrium will be reached after which all members of the series decrease in activity exponentially with the period of the parent. At this time, the ratio of the parent activity to the daughter activity is constant.

**Equilibrium, Electron**—The condition in a radiation field where the energy of the electrons entering a volume equals the energy of the electrons leaving that volume.

**Excitation**—The addition of energy to a system, thereby transferring it from its ground state to an excited state. Excitation of a nucleus, an atom, or a molecule can result from absorption of photons or from inelastic collisions with other particles. The excited state of an atom is an unstable or metastable state and will return to ground state by radiation of the excess energy.

**Exposure (Chemical)**—Contact of an organism with a chemical or physical agent. Exposure is quantified as the amount of the agent available at the exchange boundaries of the organism (e.g., skin, lungs, gut) and available for absorption.

**Exposure (Radiation)**—Subjection to ionizing radiation or to a radioactive material. For example, exposure in air is a measure of the ionization produced in air by x or gamma radiation; the sum of the electric charges on all ions of one sign produced in air when all electrons liberated by photons in a volume of air are completely stopped in air ( $dQ$ ), divided by the mass of the air in the volume ( $dm$ ). The unit of exposure in air is the roentgen, or coulomb per kilogram (SI units). One roentgen is equal to  $2.58 \times 10^{-4}$  coulomb per kilogram (C/kg).

**Fission, Nuclear**—A nuclear transformation characterized by the splitting of a nucleus into at least two other nuclei with emission of several neutrons, accompanied by the release of a relatively large amount of energy.

**Gamma Ray, Penetrating**—Short wavelength electromagnetic radiation of nuclear origin.

**Genetic Effect of Radiation**—Inheritable change, chiefly mutations, produced by the absorption of ionizing radiation by germ cells. Genetic effects have not been observed in any human population exposed at any dose level.

**Genotoxicity**—A specific adverse effect on the genome of living cells that, upon the duplication of affected cells, can be expressed as a mutagenic, clastogenic or carcinogenic event because of specific alteration of the molecular structure of the genome.

**Gray (Gy)**—SI unit of absorbed dose, 1 J/kg. One gray equals 100 rad (see Units).

**Half-life, Effective**—See Half-Time, Effective.



## 10. GLOSSARY

**Half-life, Radioactive**—Time required for a radioactive substance to lose 50% of its activity by decay. Each radio-nuclide has a unique physical half-life. Known also as physical half-time and symbolized as  $T_r$  or  $T_{rad}$ .

**Half-time, Biological**—Time required for an organ, tissue, or the whole body to eliminate one-half of any absorbed substance by regular processes of elimination. This is the same for both stable and radioactive isotopes of a particular element, and is sometimes referred to as half-time, symbolized as  $t_{biol}$  or  $T_b$ .

**Half-time, Effective**—Time required for a radioactive element in an organ, tissue, or the whole body to be diminished 50% as a result of the combined action of radioactive decay and biological elimination, symbolized as  $T_e$  or  $T_{eff}$ .

$$\text{Effective half-time} = \frac{\text{Biological half-time} \times \text{Radioactive half-life}}{\text{Biological half-time} + \text{Radioactive half-life}}$$

**Immediately Dangerous to Life or Health (IDLH)**—The maximum environmental concentration of a contaminant from which one could escape within 30 minutes without any escape-impairing symptoms or irreversible health effects.

**Immunologic Toxicity**—The occurrence of adverse effects on the immune system that may result from exposure to environmental agents such as chemicals.

**Immunological Effects**—Functional changes in the immune response.

**Incidence**—The ratio of individuals in a population who develop a specified condition to the total number of individuals in that population who could have developed that condition in a specified time period.

**Intensity**—Amount of energy per unit time passing through a unit area perpendicular to the line of propagation at the point in question.

**Intermediate Exposure**—Exposure to a chemical for a duration of 15–364 days, as specified in the Toxicological Profiles.

**Internal Conversion**—Process in which a gamma ray knocks an electron out of the same atom from which the gamma ray was emitted. The ratio of the number of internal conversion electrons to the number of gamma quanta emitted in the de-excitation of the nucleus is called the "conversion ratio."

**In Vitro**—Isolated from the living organism and artificially maintained, as in a test tube. Literally, "in glass."

**In Vivo**—Occurring within the living organism. Literally, "in life."

**Ion**—Atomic particle, atom or chemical radical bearing a net electrical charge, either negative or positive.

**Ion Pair**—Two particles of opposite charge, usually referring to the electron and positive atomic or molecular residue resulting after the interaction of ionizing radiation with the orbital electrons of atoms.

**Ionization**—The process by which a neutral atom or molecule acquires a positive or negative charge.

## 10. GLOSSARY

**Primary Ionization**—(1) In collision theory: the ionization produced by the primary particles as contrasted to the "total ionization" which includes the "secondary ionization" produced by delta rays. (2) In counter tubes: the total ionization produced by incident radiation without gas amplification.

**Specific Ionization**—Number of ion pairs per unit length of path of ionizing radiation in a medium; e.g., per centimeter of air or per micrometer of tissue.

**Total Ionization**—The total electric charge of one sign on the ions produced by radiation in the process of losing its kinetic energy. For a given gas, the total ionization is closely proportional to the initial ionization and is nearly independent of the nature of the ionizing radiation. It is frequently used as a measure of absorption of radiation energy.

**Ionization Density**—Number of ion pairs per unit volume.

**Ionization Path (Track)**—The trail of ion pairs produced by an ionizing particle in its passage through matter.

**Ionizing Radiation**—Any radiation capable of knocking electrons out of atoms and producing ions. Examples: alpha, beta, gamma and x rays, and neutrons.

**Isobars**—Nuclides having the same mass number but different atomic numbers.

**Isomers**—Nuclides having the same number of neutrons and protons but capable of existing, for a measurable time, in different quantum states with different energies and radioactive properties. Commonly the isomer of higher energy decays to one with lower energy by the process of isomeric transition.

**Isotopes**—Nuclides having the same number of protons in their nuclei, and hence the same atomic number, but differing in the number of neutrons, and therefore in the mass number. Identical chemical properties exist in isotopes of a particular element. The term should not be used as a synonym for nuclide because isotopes refer specifically to different nuclei of the same element.

**Stable Isotope**—A nonradioactive isotope of an element.

**Joule**—The S.I. unit for work and energy. It is equal to the work done by raising a mass of one newton through a distance of one meter ( $J = Nm$ ), which corresponds to about 0.7 ft-pound.

**Kerma (k)**—A measure of the kinetic energy transferred from gamma rays or neutrons to a unit mass of absorbing medium in the initial collision between the radiation and the absorber atoms. The SI unit is J/kg. The special name of this unit is the rad (traditional system of units) or Gray (SI).

**Labeled Compound**—A compound containing one or more radioactive atoms intentionally added to its structure. By observations of radioactivity or isotopic composition, this compound or its fragments may be followed through physical, chemical, or biological processes.

**Late Effects (of radiation exposure)**—Effects which appear 60 days or more following an acute exposure.

**LD<sub>50/30</sub>**—The dose of a chemical or radiation expected to cause 50% mortality in those exposed within 30 days. For radiation, this is about 350 rad (3.5 gray) received by humans over a short period of time.

## 10. GLOSSARY

**Lethal Concentration<sub>(L<sub>0</sub>)</sub> (LC<sub>L<sub>0</sub></sub>)**—The lowest concentration of a chemical in air that has been reported to have caused death in humans or animals.

**Lethal Concentration<sub>(50)</sub> (LC<sub>50</sub>)**—A calculated concentration of a chemical in air to which exposure for a specific length of time is expected to cause death in 50% of a defined experimental animal population within a specified time, usually 30 days.

**Lethal Dose<sub>(L<sub>0</sub>)</sub> (LD<sub>L<sub>0</sub></sub>)**—The lowest dose of a chemical introduced by a route other than inhalation that is expected to have caused death in humans or animals within a specified time, usually 30 days.

**Lethal Dose<sub>(50)</sub> (LD<sub>50</sub>)**—The dose of a chemical which has been calculated to cause death in 50% of a defined experimental animal population.

**Lethal Time<sub>(50)</sub> (LT<sub>50</sub>)**—A calculated period of time within which a specific concentration of a chemical is expected to cause death in 50% of a defined experimental animal population.

**Linear Energy Transfer (LET)**—A measure of the energy that a charged particle transfers to a material per unit path length.

**Average LET**—The energy of a charged particle divided by the length of the path over which it deposits all its energy in a material. This is averaged over a number of particles.

**High-LET**—Energy transfer characteristic of heavy charged particles such as protons and alpha particles where the distance between ionizing events is small on the scale of a cellular nucleus.

**Low-LET**—Energy transfer characteristic of light charged particles such as electrons produced by x and gamma rays where the distance between ionizing events is large on the scale of a cellular nucleus.

**Lowest-Observed-Adverse-Effect Level (LOAEL)**—The lowest dose of chemical in a study, or group of studies, that produces statistically or biologically significant increases in frequency or severity of adverse effects between the exposed population and its appropriate control.

**Lung Clearance Class (fast, F; medium, M; slow, S)**—A classification scheme for inhaled material according to its rate of clearance from the pulmonary region of the lungs to the blood and the gastrointestinal tract.

**Lymphoreticular Effects**—Represent morphological effects involving lymphatic tissues such as the lymph nodes, spleen, and thymus.

**Malformations**—Permanent structural changes that may adversely affect survival, development, or function.

**Mass Numbers (A)**—The number of nucleons (protons and neutrons) in the nucleus of an atom.

**Minimal Risk Level**—An estimate of daily human exposure to a substance that is likely to be without an appreciable risk of adverse noncancerous effects over a specified duration of exposure.

## 10. GLOSSARY

**Modifying Factor (MF)**—A value (greater than zero) that is applied to the derivation of a Minimal Risk Level (MRL) to reflect additional concerns about the database that are not covered by the uncertainty factors. The default value for a MF is 1.

**Morbidity**—State of being diseased; morbidity rate is the incidence or prevalence of disease in a specific population.

**Mortality**—Death; mortality rate is a measure of the number of deaths in a population during a specified interval of time.

**Mutagen**—A substance that causes changes (mutations) in the genetic material in a cell. Mutations can lead to birth defects, miscarriages, or cancer.

**Necropsy**—The gross examination of the organs and tissues of a dead body to determine the cause of death or pathological conditions.

**Neurotoxicity**—The occurrence of adverse effects on the nervous system following exposure to a substance.

**Neutrino ( $\nu$ )**—A neutral particle of infinitesimally small rest mass emitted during beta plus or beta minus decay. This particle accounts for conservation of energy in beta plus and beta minus decays. It plays no role in damage from radiation.

**Noble Gas**—Any of a group of rare gases that include helium, neon, argon, krypton, xenon, and radon. Because the outermost electron shell of atoms of these gases is full, they do not react chemically with other substances except under certain special conditions. Also called inert gas.

**No-Observed-Adverse-Effect Level (NOAEL)**—The dose of a substance at which there were no statistically or biologically significant increases in frequency or severity of adverse effects seen between the exposed population and its appropriate control. Effects may be produced at this dose, but they are not considered to be adverse.

**Nuclear Reactor**—A power plant that heats the medium (typically water) by using the energy released from the nuclear fission of uranium or plutonium isotopes instead of burning coal, oil, or natural gas. All of these sources of energy simply heat water and use the steam which is produced to turn turbines that make electricity or propel a ship.

**Nucleon**—Common name for a constituent particle of the nucleus. Applied to a proton or neutron.

**Nuclide**—A species of atom characterized by the constitution of its nucleus. The nuclear constitution is specified by the number of protons ( $Z$ ), number of neutrons ( $N$ ), and energy content; or, alternatively, by the atomic number ( $Z$ ), mass number  $A(N+Z)$ , and atomic mass. To be regarded as a distinct nuclide, the atom must be capable of existing for a measurable time. Thus, nuclear isomers are separate nuclides, whereas promptly decaying excited nuclear states and unstable intermediates in nuclear reactions are not so considered.

**Octanol-Water Partition Coefficient ( $K_{ow}$ )**—The equilibrium ratio of the concentrations of a chemical in n-octanol and water, in dilute solution.

## 10. GLOSSARY

**Odds Ratio (OR)**—A means of measuring the association between an exposure (such as toxic substances and a disease or condition) which represents the best estimate of relative risk (risk as a ratio of the incidence among subjects exposed to a particular risk factor divided by the incidence among subjects who were not exposed to the risk factor). An odds ratio of greater than 1 is considered to indicate greater risk of disease in the exposed group compared to the unexposed.

**Organophosphate or Organophosphorus Compound**—A phosphorus-containing organic compound and especially a pesticide that acts by inhibiting cholinesterase.

**Pair Production**—An absorption process for x- and gamma radiation in which the incident photon is absorbed in the vicinity of the nucleus of the absorbing atom, with subsequent production of an electron and positron pair (see annihilation). This reaction can only occur for incident photon energies exceeding 1.02 MeV.

**Parent**—Any radionuclide nuclide which, upon disintegration, yields a new nuclide (termed the progeny or daughter), either directly or as a later member of a radioactive series.

**Permissible Exposure Limit (PEL)**—A maximum allowable atmospheric level of a substance in workplace air averaged over an 8-hour shift.

**Pesticide**—General classification of chemicals specifically developed and produced for use in the control of agricultural and public health pests.

**Pharmacokinetic Model**—A set of equations that can be used to describe the time course of a parent chemical or metabolite in an animal system. There are two types of pharmacokinetic models: data-based and physiologically-based. A data-based model divides the animal system into a series of compartments which, in general, do not represent real, identifiable anatomic regions of the body whereas the physiologically-based model compartments represent real anatomic regions of the body.

**Pharmacokinetics**—The dynamic behavior of a material in the body, used to predict the fate (disposition) of an exogenous substance in an organism. Utilizing computational techniques, it provides the means of studying the absorption, distribution, metabolism and excretion of chemicals by the body.

**Physiologically Based Pharmacodynamic (PBPD) Model**—A type of physiologically-based dose-response model which quantitatively describes the relationship between target tissue dose and toxic end points. These models advance the importance of physiologically based models in that they clearly describe the biological effect (response) produced by the system following exposure to an exogenous substance.

**Physiologically Based Pharmacokinetic (PBPK) Model**—A model comprising a series of compartments representing organs or tissue groups with realistic weights and blood flows. These models require a variety of physiological information: tissue volumes, blood flow rates to tissues, cardiac output, alveolar ventilation rates and, possibly membrane permeabilities. The models also utilize biochemical information such as air/blood partition coefficients, and metabolic parameters. PBPK models are also called biologically based tissue dosimetry models.

**Photoelectric Effect**—An attenuation process observed for x and gamma radiation in which an incident photon interacts with a tightly bound inner orbital electron of an atom delivering all of its energy to knock the electron out of the atom. The incident photon disappears in the process.

## 10. GLOSSARY

**Photon**—A quantum of electromagnetic energy (E) whose value is the product of its frequency ( $\nu$ ) in hertz and Planck's constant (h). The equation is:  $E = h\nu$ .

**Population dose**—See Collective dose.

**Positron**—A positively charged electron.

**Potential, Ionization**—The energy expressed as electron volts (eV) necessary to separate one electron from an atom, resulting in the formation of an ion pair.

**Power, Stopping**—A measure of the ability of a material to absorb energy from an ionizing particle passing through it; the greater the stopping power, the greater the energy absorbing ability (see Linear Energy Transfer).

**Prevalence**—The number of cases of a disease or condition in a population at one point in time.

**Progeny**—The decay product or daughter products resulting after a radioactive decay or a series of radioactive decays. The progeny can also be radioactive, and the chain continues until a stable nuclide is formed.

**Prospective Study**—A type of cohort study in which the pertinent observations are made on events occurring after the start of the study. A group is followed over time.

**Proton**—Elementary nuclear particle with a positive electric charge equal numerically to the charge of the electron and a rest mass of 1.007 mass units.

**$q_1^*$** —The upper-bound estimate of the low-dose slope of the dose-response curve as determined by the multistage procedure. The  $q_1^*$  can be used to calculate an estimate of carcinogenic potency, the incremental excess cancer risk per unit of exposure (usually  $\mu\text{g/L}$  for water,  $\text{mg/kg/day}$  for food, and  $\mu\text{g/m}^3$  for air).

**Quality**—A term describing the distribution of the energy deposited by a particle along its track; radiations that produce different densities of ionization per unit intensity are said to have different "qualities."

**Quality Factor (Q)**—The linear-energy-transfer-dependent factor by which absorbed doses are multiplied to obtain (for radiation protection purposes) a quantity that expresses - on a common scale for all ionizing radiation - the approximate biological effectiveness of the absorbed dose.

Type of radiation	Quality Factor
X, gamma, or beta	1
Alpha particles	20
Neutrons of unknown energy	10
High energy protons	10

**Rad**—The traditional unit of absorbed dose equal to 100 ergs per gram, or 0.01 joule per kilogram (0.01 Gy) in any medium (see Absorbed Dose).

## 10. GLOSSARY

**Radiation**—The emission and propagation of energy through space or through a material medium in the form of waves (e.g., the emission and propagation of electromagnetic waves, or of sound and elastic waves). The term radiation or radiant energy, when unqualified, usually refers to electromagnetic radiation. Such radiation commonly is classified according to frequency, as microwaves, infrared, visible (light), ultraviolet, and x and gamma rays (see Photon.) and, by extension, corpuscular emission, such as alpha and beta radiation, neutrons, or rays of mixed or unknown type, as cosmic radiation.

**Radiation, Annihilation**—Photons produced when an electron and a positron unite and cease to exist. The annihilation of a positron-electron pair results in the production of two photons, each of 0.51 MeV energy.

**Radiation, Background**—See Background Radiation.

**Radiation, Characteristic (Discrete)**—Radiation originating from an excited atom after removal of an electron from an atom. The wavelength of the emitted radiation is specific, depending only on the element and particular energy levels involved.

**Radiation, External**—Radiation from a source outside the body.

**Radiation, Internal**—Radiation from a source within the body (as a result of deposition of radionuclides in body tissues).

**Radiation, Ionizing**—Any electromagnetic or particulate radiation capable of producing ions, directly or indirectly, in its passage through matter (see Radiation).

**Radiation, Monoenergetic**—Radiation of a given type in which all particles or photons originate with and have the same energy.

**Radiation, Scattered**—Radiation which during its passage through a substance, has been deviated in direction. It may also have been modified by a decrease in energy.

**Radiation, Secondary**—A particle or ray that is produced when the primary radiation interacts with a material, and which has sufficient energy to produce its own ionization, such as bremsstrahlung or electrons knocked from atomic orbitals with enough energy to then produce ionization (see Delta Rays).

**Radiation Weighting Factor (also called Quality Factor)**—In radiation protection, a factor (1 for x-rays, gamma rays, beta particles; 20 for alpha particles) weighting the absorbed dose of radiation of a specific type and energy for its effect on tissue.

**Radioactive Material**—Material containing radioactive atoms.

**Radioactivity**—Spontaneous nuclear transformations that result in the formation of new elements. These transformations are accomplished by emission of alpha or beta particles from the nucleus or by the capture of an orbital electron. Each of these reactions may or may not be accompanied by a gamma photon.

**Radioactivity, Artificial**—Man-made radioactivity produced by particle bombardment or nuclear fission, as opposed to naturally occurring radioactivity.

## 10. GLOSSARY

**Radioactivity, Induced**—Radioactivity produced in a substance after bombardment with neutrons or other particles. The resulting activity is "natural radioactivity" if formed by nuclear reactions occurring in nature and "artificial radioactivity" if the reactions are caused by man.

**Radioactivity, Natural**—The property of radioactivity exhibited by more than 50 naturally occurring radionuclides.

**Radioisotope**—An unstable or radioactive isotope of an element that decays or disintegrates spontaneously, emitting radiation.

**Radionuclide**—Any radioactive isotope of any element. Approximately 5,000 natural and artificial radioisotopes have been identified.

**Radiosensitivity**—Relative susceptibility of cells, tissues, organs, organisms, or any living substance to the injurious action of radiation. Radiosensitivity and its antonym, radioresistance, are used comparatively, rather than absolutely.

**Recommended Exposure Limit (REL)**—A National Institute for Occupational Safety and Health (NIOSH) time-weighted average (TWA) concentration for up to a 10-hour workday during a 40-hour workweek.

**Reference Concentration (RfC)**—An estimate (with uncertainty spanning perhaps an order of magnitude) of a continuous inhalation exposure to the human population (including sensitive subgroups) that is likely to be without an appreciable risk of deleterious noncancer health effects during a lifetime. The inhalation reference concentration is for continuous inhalation exposures and is appropriately expressed in units of mg/m<sup>3</sup> or ppm.

**Reference Dose (RfD)**—An estimate of the daily exposure of the human population to a potential hazard that is likely to be without risk of deleterious effects during a lifetime. The RfD is operationally derived from the NOAEL (from animal and human studies) by a consistent application of uncertainty factors that reflect various types of data used to estimate RfDs and an additional modifying factor, which is based on a professional judgment of the entire database on the chemical. The RfDs are not applicable to non-threshold effects such as cancer.

**Relative Biological Effectiveness (RBE)**—The RBE is a factor used to compare the biological effectiveness of absorbed radiation doses (i.e., rad) due to different types of ionizing radiation. More specifically, it is the experimentally determined ratio of an absorbed dose of a radiation in question to the absorbed dose of a reference radiation (typically <sup>60</sup>Co gamma rays or 200 kVp x rays) required to produce an identical biological effect in a particular experimental organism or tissue (see Quality Factor).

**Rem**—The traditional unit of dose equivalent that is used in the regulatory, administrative, and engineering design aspects of radiation safety practice. The dose equivalent in rem is numerically equal to the absorbed dose in rad multiplied by the quality factor (1 rem is equal to 0.01 sievert).

**Reportable Quantity (RQ)**—The quantity of a hazardous substance that is considered reportable under CERCLA. Reportable quantities are (1) 1 pound or greater or (2) for selected substances, an amount established by regulation either under CERCLA or under Sect. 311 of the Clean Water Act. Quantities are measured over a 24-hour period.



## 10. GLOSSARY

**Reproductive Toxicity**—The occurrence of adverse effects on the reproductive system that may result from exposure to a chemical. The toxicity may be directed to the reproductive organs and/or the related endocrine system. The manifestation of such toxicity may be noted as alterations in sexual behavior, fertility, pregnancy outcomes, or modifications in other functions that are dependent on the integrity of this system.

**Roentgen (R)**—A unit of exposure (in air) to ionizing radiation. It is the amount of x or gamma rays required to produce ions carrying 1 electrostatic unit of electrical charge in 1 cubic centimeter of dry air under standard conditions. Named after William Roentgen, a German scientist who discovered x rays in 1895.

**Retrospective Study**—A type of cohort study based on a group of persons known to have been exposed at some time in the past. Data are collected from routinely recorded events, up to the time the study is undertaken. Retrospective studies are limited to causal factors that can be ascertained from existing records and/or examining survivors of the cohort.

**Risk**—The possibility or chance that some adverse effect will result from a given exposure to a chemical.

**Risk Factor**—An aspect of personal behavior or lifestyle, an environmental exposure, or an inborn or inherited characteristic that is associated with an increased occurrence of disease or other health-related event or condition.

**Risk Ratio**—The ratio of the risk among persons with specific risk factors compared to the risk among persons without risk factors. A risk ratio greater than 1 indicates greater risk of disease in the exposed group compared to the unexposed group.

**Self-Absorption**—Absorption of radiation (emitted by radioactive atoms) by the material in which the atoms are located; in particular, the absorption of radiation within a sample being assayed.

**Short-Term Exposure Limit (STEL)**—The maximum concentration to which workers can be exposed for up to 15 minutes continually. No more than four excursions are allowed per day, and there must be at least 60 minutes between exposure periods. The daily TLV-TWA may not be exceeded.

**SI Units**—The International System of Units as defined by the General Conference of Weights and Measures in 1960. These units are generally based on the meter/kilogram/second units, with special quantities for radiation including the becquerel, gray, and sievert.

**Sickness, Acute Radiation (Syndrome)**—The complex symptoms and signs characterizing the condition resulting from excessive exposure of the whole body (or large part) to ionizing radiation. The earliest of these symptoms are nausea, fatigue, vomiting, and diarrhea, and may be followed by loss of hair (epilation), hemorrhage, inflammation of the mouth and throat, and general loss of energy. In severe cases, where the radiation dose is relatively high (over several hundred rad or several gray), death may occur within two to four weeks. Those who survive six weeks after exposure of a single high dose of radiation may generally be expected to recover.

**Sievert (Sv)**—The SI unit of any of the quantities expressed as dose equivalent. The dose equivalent in sieverts is equal to the absorbed dose, in gray, multiplied by the quality factor (1 sievert equals 100 rem). The sievert is also the SI unit for effective dose equivalent, which is the sum of the products of the dose equivalent to each organ or tissue and its corresponding tissue weighting factor.

## 10. GLOSSARY

**Specific-Activity**—Radioactivity per unit mass of a radionuclide, expressed, for example, as Ci/gram or Bq/kilogram.

**Specific Energy**—The actual energy per unit mass deposited per unit volume in a small target, such as the cell or cell nucleus, as the result of one or more energy-depositing events. This is a stochastic quantity as opposed to the average value over a large number of instance (i.e., the absorbed dose).

**Standardized Mortality Ratio (SMR)**—A ratio of the observed number of deaths and the expected number of deaths in a specific standard population.

**Stochastic Effect**—A health effect that occurs randomly and for which the probability of the effect occurring, rather than its severity, is assumed to be a linear function of dose without a threshold (also called a nondeterministic effect).

**Stopping Power**—The average rate of energy loss of a charged particle per unit thickness of a material or per unit mass of material traversed.

**Surface-seeking Radionuclide**—A bone-seeking internal emitter that deposits and remains on the bone surface for a long period of time, although it may eventually diffuse into the bone mineral. This contrasts with a volume seeker, which deposits more uniformly throughout the bone volume.

**Target Organ Toxicity**—This term covers a broad range of adverse effects on target organs or physiological systems (e.g., renal, cardiovascular) extending from those arising through a single limited exposure to those assumed over a lifetime of exposure to a chemical.

**Target Theory (Hit Theory)**—A theory explaining some biological effects of radiation on the basis that ionization, occurring in a discrete volume (the target) within the cell, directly causes a lesion which subsequently results in a physiological response to the damage at that location. One, two, or more "hits" (ionizing events within the target) may be necessary to elicit the response.

**Teratogen**—A chemical that causes birth defects.

**Threshold Limit Value (TLV)**—The maximum concentration of a substance to which most workers can be exposed without adverse effect. TLV is a term used exclusively by the ACGIH. Other terms used to express similar concepts are the MAC (Maximum Allowable Concentration) and PEL (Permissible Exposure Limits).

**Time-Weighted Average (TWA)**—An allowable exposure concentration averaged over a normal 8-hour workday or 40-hour workweek.

## 10. GLOSSARY

**Tissue Weighting Factor ( $W_t$ )**—Organ- or tissue-specific factor by which the equivalent dose is multiplied to give the portion of the effective dose for that organ or tissue. Recommended values of tissue weighting factors are:

Tissue/Organ	Tissue Weighting Factor
Gonads	0.70
Bone marrow (red)	0.12
Colon	0.12
Lung	0.12
Stomach	0.12
Bladder	0.05
Breast	0.05
Liver	0.05
Esophagus	0.05
Thyroid	0.05
Skin	0.01
Bone surface	0.01
Remainder (adrenals, brain, upper large intestine, small intestine, pancreas, spleen, thymus, and uterus)	0.05

**Toxic Dose ( $TD_{50}$ )**—A calculated dose of a chemical, introduced by a route other than inhalation, which is expected to cause a specific toxic effect in 50% of a defined experimental animal population.

**Toxicokinetic**—The absorption, distribution and elimination of toxic compounds in the living organism.

**Toxicosis**—A diseased condition resulting from poisoning.

**Transformation, Nuclear**—The process of radioactive decay by which a nuclide is transformed into a different nuclide by absorbing or emitting particulate or electromagnetic radiation.

**Transition, Isomeric**—The process by which a nuclide decays to an isomeric nuclide (i.e., one of the same mass number and atomic number) of lower quantum energy. Isomeric transitions (often abbreviated I.T.) proceed by gamma ray and internal conversion electron emission.

**Tritium**—The hydrogen isotope with one proton and two neutrons in the nucleus (Symbol:  $^3\text{H}$ ). It is radioactive and has a physical half-life of 12.3 years.

**Unattached Fraction**—That fraction of the radon daughters, usually  $^{218}\text{Po}$  and  $^{214}\text{Po}$ , which has not yet attached to a dust particle or to water vapor. As a free atom, it has a high probability of being exhaled and not retained within the lung. It is the attached fraction which is primarily retained.

**Uncertainty Factor (UF)**—A factor used in operationally deriving the RfD from experimental data. UFs are intended to account for (1) the variation in sensitivity among the members of the human population, (2) the uncertainty in extrapolating animal data to the case of human, (3) the uncertainty in extrapolating from data obtained in a study that is of less than lifetime exposure, and (4) the uncertainty in using LOAEL data rather than NOAEL data. Usually each of these factors is set equal to 10.

## 10. GLOSSARY

**Units, Prefixes**—Many units of measure are expressed as submultiples or multiples of the primary unit (e.g.,  $10^{-3}$  curie is 1 mCi and  $10^3$  becquerel is 1 kBq).

Factor	Prefix	Symbol	Factor	Prefix	Symbol
$10^{-18}$	atto	A	$10^3$	kilo	k
$10^{-15}$	femto	F	$10^6$	mega	M
$10^{-12}$	pico	p	$10^9$	giga	G
$10^{-9}$	nano	N	$10^{12}$	tera	T
$10^{-6}$	micro	M	$10^{15}$	peta	P
$10^{-3}$	milli	M	$10^{18}$	exa	E
$10^{-2}$	centi	C			

**Units, Radiological**—

Units	Equivalents
Becquerel* (Bq)	1 disintegration per second = $2.7 \times 10^{-11}$ Ci
Curie (Ci)	$3.7 \times 10^{10}$ disintegrations per second = $3.7 \times 10^{10}$ Bq
Gray* (Gy)	1 J/kg = 100 rad
Rad (rad)	100 erg/g = 0.01 Gy
Rem (rem)	0.01 sievert
Sievert* (Sv)	100 rem

\*International Units, designated (SI)

**Working Level (WL)**—Any combination of short-lived radon daughters in 1 liter of air that will result in the ultimate emission of  $1.3 \times 10^5$  MeV of potential alpha energy.

**Working Level Month (WLM)**—A unit of exposure to radon daughters corresponding to the product of the radon daughter concentration in Working Level (WL) and the exposure time in nominal months (1 nominal month = 170 hours). Inhalation of air with a concentration of 1 WL of radon daughters for 170 working hours results in an exposure of 1 WLM.

**Xenobiotic**—Any chemical that is foreign to the biological system.

**X rays**—Penetrating electromagnetic radiations whose wave lengths are very much shorter than those of visible light. They are usually produced by bombarding a metallic target with fast electrons in a high vacuum. X rays (called characteristic x rays) are also produced when an orbital electron falls from a high energy level to a low energy level.

**Zero-Threshold Linear Hypothesis (or No-Threshold Linear Hypothesis)**—The assumption that a dose-response curve derived from data in the high dose and high dose-rate ranges may be extrapolated through the low dose and low dose range to zero, implying that, theoretically, any amount of radiation will cause some damage.

## APPENDIX A. ATSDR MINIMAL RISK LEVELS AND WORKSHEETS

The Comprehensive Environmental Response, Compensation, and Liability Act (CERCLA) [42 U.S.C. 9601 et seq.], as amended by the Superfund Amendments and Reauthorization Act (SARA) [Pub. L. 99–499], requires that the Agency for Toxic Substances and Disease Registry (ATSDR) develop jointly with the U.S. Environmental Protection Agency (EPA), in order of priority, a list of hazardous substances most commonly found at facilities on the CERCLA National Priorities List (NPL); prepare toxicological profiles for each substance included on the priority list of hazardous substances; and assure the initiation of a research program to fill identified data needs associated with the substances.

The toxicological profiles include an examination, summary, and interpretation of available toxicological information and epidemiologic evaluations of a hazardous substance. During the development of toxicological profiles, Minimal Risk Levels (MRLs) are derived when reliable and sufficient data exist to identify the target organ(s) of effect or the most sensitive health effect(s) for a specific duration for a given route of exposure. An MRL is an estimate of the daily human exposure to a hazardous substance that is likely to be without appreciable risk of adverse noncancer health effects over a specified duration of exposure. MRLs are based on noncancer health effects only and are not based on a consideration of cancer effects. These substance-specific estimates, which are intended to serve as screening levels, are used by ATSDR health assessors to identify contaminants and potential health effects that may be of concern at hazardous waste sites. It is important to note that MRLs are not intended to define clean-up or action levels.

MRLs are derived for hazardous substances using the no-observed-adverse-effect level/uncertainty factor approach. They are below levels that might cause adverse health effects in the people most sensitive to such chemical-induced effects. MRLs are derived for acute (1–14 days), intermediate (15–364 days), and chronic (365 days and longer) durations and for the oral and inhalation routes of exposure. Currently, MRLs for the dermal route of exposure are not derived because ATSDR has not yet identified a method suitable for this route of exposure. MRLs are generally based on the most sensitive chemical-induced end point considered to be of relevance to humans. Serious health effects (such as irreparable damage to the liver or kidneys, or birth defects) are not used as a basis for establishing MRLs. Exposure to a level above the MRL does not mean that adverse health effects will occur.

MRLs are intended only to serve as a screening tool to help public health professionals decide where to look more closely. They may also be viewed as a mechanism to identify those hazardous waste sites that are not expected to cause adverse health effects. Most MRLs contain a degree of uncertainty because of

## APPENDIX A

the lack of precise toxicological information on the people who might be most sensitive (e.g., infants, elderly, nutritionally or immunologically compromised) to the effects of hazardous substances. ATSDR uses a conservative (i.e., protective) approach to address this uncertainty consistent with the public health principle of prevention. Although human data are preferred, MRLs often must be based on animal studies because relevant human studies are lacking. In the absence of evidence to the contrary, ATSDR assumes that humans are more sensitive to the effects of hazardous substance than animals and that certain persons may be particularly sensitive. Thus, the resulting MRL may be as much as 100-fold below levels that have been shown to be nontoxic in laboratory animals.

Proposed MRLs undergo a rigorous review process: Health Effects/MRL Workgroup reviews within the Division of Toxicology and Environmental Medicine, expert panel peer reviews, and agency-wide MRL Workgroup reviews, with participation from other federal agencies and comments from the public. They are subject to change as new information becomes available concomitant with updating the toxicological profiles. Thus, MRLs in the most recent toxicological profiles supersede previously published levels. For additional information regarding MRLs, please contact the Division of Toxicology and Environmental Medicine, Agency for Toxic Substances and Disease Registry, 1600 Clifton Road NE, Mailstop F-32, Atlanta, Georgia 30333.

For reasons discussed in Section 2.3, MRLs were not derived for radon.

## APPENDIX B. USER'S GUIDE

### Chapter 1

#### Public Health Statement

This chapter of the profile is a health effects summary written in non-technical language. Its intended audience is the general public, especially people living in the vicinity of a hazardous waste site or chemical release. If the Public Health Statement were removed from the rest of the document, it would still communicate to the lay public essential information about the chemical.

The major headings in the Public Health Statement are useful to find specific topics of concern. The topics are written in a question and answer format. The answer to each question includes a sentence that will direct the reader to chapters in the profile that will provide more information on the given topic.

### Chapter 2

#### Relevance to Public Health

This chapter provides a health effects summary based on evaluations of existing toxicologic, epidemiologic, and toxicokinetic information. This summary is designed to present interpretive, weight-of-evidence discussions for human health end points by addressing the following questions:

1. What effects are known to occur in humans?
2. What effects observed in animals are likely to be of concern to humans?
3. What exposure conditions are likely to be of concern to humans, especially around hazardous waste sites?

The chapter covers end points in the same order that they appear within the Discussion of Health Effects by Route of Exposure section, by route (inhalation, oral, and dermal) and within route by effect. Human data are presented first, then animal data. Both are organized by duration (acute, intermediate, chronic). *In vitro* data and data from parenteral routes (intramuscular, intravenous, subcutaneous, etc.) are also considered in this chapter.

The carcinogenic potential of the profiled substance is qualitatively evaluated, when appropriate, using existing toxicokinetic, genotoxic, and carcinogenic data. ATSDR does not currently assess cancer potency or perform cancer risk assessments. Minimal Risk Levels (MRLs) for noncancer end points (if derived) and the end points from which they were derived are indicated and discussed.

Limitations to existing scientific literature that prevent a satisfactory evaluation of the relevance to public health are identified in the Chapter 3 Data Needs section.

#### Interpretation of Minimal Risk Levels

Where sufficient toxicologic information is available, ATSDR has derived MRLs for inhalation and oral routes of entry at each duration of exposure (acute, intermediate, and chronic). These MRLs are not meant to support regulatory action, but to acquaint health professionals with exposure levels at which adverse health effects are not expected to occur in humans.

## APPENDIX B

MRLs should help physicians and public health officials determine the safety of a community living near a chemical emission, given the concentration of a contaminant in air or the estimated daily dose in water. MRLs are based largely on toxicological studies in animals and on reports of human occupational exposure.

MRL users should be familiar with the toxicologic information on which the number is based. Chapter 2, "Relevance to Public Health," contains basic information known about the substance. Other sections such as Chapter 3 Section 3.9, "Interactions with Other Substances," and Section 3.10, "Populations that are Unusually Susceptible" provide important supplemental information.

MRL users should also understand the MRL derivation methodology. MRLs are derived using a modified version of the risk assessment methodology that the Environmental Protection Agency (EPA) provides (Barnes and Dourson 1988) to determine reference doses (RfDs) for lifetime exposure.

To derive an MRL, ATSDR generally selects the most sensitive end point which, in its best judgement, represents the most sensitive human health effect for a given exposure route and duration. ATSDR cannot make this judgement or derive an MRL unless information (quantitative or qualitative) is available for all potential systemic, neurological, and developmental effects. If this information and reliable quantitative data on the chosen end point are available, ATSDR derives an MRL using the most sensitive species (when information from multiple species is available) with the highest no-observed-adverse-effect level (NOAEL) that does not exceed any adverse effect levels. When a NOAEL is not available, a lowest-observed-adverse-effect level (LOAEL) can be used to derive an MRL, and an uncertainty factor (UF) of 10 must be employed. Additional uncertainty factors of 10 must be used both for human variability to protect sensitive subpopulations (people who are most susceptible to the health effects caused by the substance) and for interspecies variability (extrapolation from animals to humans). In deriving an MRL, these individual uncertainty factors are multiplied together. The product is then divided into the inhalation concentration or oral dosage selected from the study. Uncertainty factors used in developing a substance-specific MRL are provided in the footnotes of the levels of significant exposure (LSE) tables.

## **Chapter 3**

### **Health Effects**

#### **Tables and Figures for Levels of Significant Exposure (LSE)**

Tables and figures are used to summarize health effects and illustrate graphically levels of exposure associated with those effects. These levels cover health effects observed at increasing dose concentrations and durations, differences in response by species, MRLs to humans for noncancer end points, and EPA's estimated range associated with an upper-bound individual lifetime cancer risk of 1 in 10,000 to 1 in 10,000,000. Use the LSE tables and figures for a quick review of the health effects and to locate data for a specific exposure scenario. The LSE tables and figures should always be used in conjunction with the text. All entries in these tables and figures represent studies that provide reliable, quantitative estimates of NOAELs, LOAELs, or Cancer Effect Levels (CELs).

The legends presented below demonstrate the application of these tables and figures. Representative examples of LSE Table 3-1 and Figure 3-1 are shown. The numbers in the left column of the legends correspond to the numbers in the example table and figure.



## APPENDIX B

**LEGEND****See Sample LSE Table 3-1 (page B-6)**

- (1) **Route of Exposure.** One of the first considerations when reviewing the toxicity of a substance using these tables and figures should be the relevant and appropriate route of exposure. Typically when sufficient data exist, three LSE tables and two LSE figures are presented in the document. The three LSE tables present data on the three principal routes of exposure, i.e., inhalation, oral, and dermal (LSE Tables 3-1, 3-2, and 3-3, respectively). LSE figures are limited to the inhalation (LSE Figure 3-1) and oral (LSE Figure 3-2) routes. Not all substances will have data on each route of exposure and will not, therefore, have all five of the tables and figures.
- (2) **Exposure Period.** Three exposure periods—acute (less than 15 days), intermediate (15–364 days), and chronic (365 days or more)—are presented within each relevant route of exposure. In this example, an inhalation study of intermediate exposure duration is reported. For quick reference to health effects occurring from a known length of exposure, locate the applicable exposure period within the LSE table and figure.
- (3) **Health Effect.** The major categories of health effects included in LSE tables and figures are death, systemic, immunological, neurological, developmental, reproductive, and cancer. NOAELs and LOAELs can be reported in the tables and figures for all effects but cancer. Systemic effects are further defined in the "System" column of the LSE table (see key number 18).
- (4) **Key to Figure.** Each key number in the LSE table links study information to one or more data points using the same key number in the corresponding LSE figure. In this example, the study represented by key number 18 has been used to derive a NOAEL and a Less Serious LOAEL (also see the two "18r" data points in sample Figure 3-1).
- (5) **Species.** The test species, whether animal or human, are identified in this column. Chapter 2, "Relevance to Public Health," covers the relevance of animal data to human toxicity and Section 3.4, "Toxicokinetics," contains any available information on comparative toxicokinetics. Although NOAELs and LOAELs are species specific, the levels are extrapolated to equivalent human doses to derive an MRL.
- (6) **Exposure Frequency/Duration.** The duration of the study and the weekly and daily exposure regimens are provided in this column. This permits comparison of NOAELs and LOAELs from different studies. In this case (key number 18), rats were exposed to "Chemical x" via inhalation for 6 hours/day, 5 days/week, for 13 weeks. For a more complete review of the dosing regimen, refer to the appropriate sections of the text or the original reference paper (i.e., Nitschke et al. 1981).
- (7) **System.** This column further defines the systemic effects. These systems include respiratory, cardiovascular, gastrointestinal, hematological, musculoskeletal, hepatic, renal, and dermal/ocular. "Other" refers to any systemic effect (e.g., a decrease in body weight) not covered in these systems. In the example of key number 18, one systemic effect (respiratory) was investigated.
- (8) **NOAEL.** A NOAEL is the highest exposure level at which no harmful effects were seen in the organ system studied. Key number 18 reports a NOAEL of 3 ppm for the respiratory system, which was used to derive an intermediate exposure, inhalation MRL of 0.005 ppm (see footnote "b").

## APPENDIX B

- (9) LOAEL. A LOAEL is the lowest dose used in the study that caused a harmful health effect. LOAELs have been classified into "Less Serious" and "Serious" effects. These distinctions help readers identify the levels of exposure at which adverse health effects first appear and the gradation of effects with increasing dose. A brief description of the specific end point used to quantify the adverse effect accompanies the LOAEL. The respiratory effect reported in key number 18 (hyperplasia) is a Less Serious LOAEL of 10 ppm. MRLs are not derived from Serious LOAELs.
- (10) Reference. The complete reference citation is given in Chapter 9 of the profile.
- (11) CEL. A CEL is the lowest exposure level associated with the onset of carcinogenesis in experimental or epidemiologic studies. CELs are always considered serious effects. The LSE tables and figures do not contain NOAELs for cancer, but the text may report doses not causing measurable cancer increases.
- (12) Footnotes. Explanations of abbreviations or reference notes for data in the LSE tables are found in the footnotes. Footnote "b" indicates that the NOAEL of 3 ppm in key number 18 was used to derive an MRL of 0.005 ppm.

**LEGEND****See Sample Figure 3-1 (page B-7)**

LSE figures graphically illustrate the data presented in the corresponding LSE tables. Figures help the reader quickly compare health effects according to exposure concentrations for particular exposure periods.

- (13) Exposure Period. The same exposure periods appear as in the LSE table. In this example, health effects observed within the acute and intermediate exposure periods are illustrated.
- (14) Health Effect. These are the categories of health effects for which reliable quantitative data exists. The same health effects appear in the LSE table.
- (15) Levels of Exposure. Concentrations or doses for each health effect in the LSE tables are graphically displayed in the LSE figures. Exposure concentration or dose is measured on the log scale "y" axis. Inhalation exposure is reported in mg/m<sup>3</sup> or ppm and oral exposure is reported in mg/kg/day.
- (16) NOAEL. In this example, the open circle designated 18r identifies a NOAEL critical end point in the rat upon which an intermediate inhalation exposure MRL is based. The key number 18 corresponds to the entry in the LSE table. The dashed descending arrow indicates the extrapolation from the exposure level of 3 ppm (see entry 18 in the table) to the MRL of 0.005 ppm (see footnote "b" in the LSE table).
- (17) CEL. Key number 38m is one of three studies for which CELs were derived. The diamond symbol refers to a CEL for the test species-mouse. The number 38 corresponds to the entry in the LSE table.

## APPENDIX B

- (18) Estimated Upper-Bound Human Cancer Risk Levels. This is the range associated with the upper-bound for lifetime cancer risk of 1 in 10,000 to 1 in 10,000,000. These risk levels are derived from the EPA's Human Health Assessment Group's upper-bound estimates of the slope of the cancer dose response curve at low dose levels ( $q_1^*$ ).
- (19) Key to LSE Figure. The Key explains the abbreviations and symbols used in the figure.

**SAMPLE**

1 →

**Table 3-1. Levels of Significant Exposure to [Chemical x] – Inhalation**

Key to figure <sup>a</sup>	Species	Exposure frequency/ duration	System	NOAEL (ppm)	LOAEL (effect)		Reference
					Less serious (ppm)	Serious (ppm)	
<b>INTERMEDIATE EXPOSURE</b>							
	5	6	7	8	9		10
3 →	Systemic	↓	↓	↓	↓	↓	↓
4 →	18	Rat	13 wk 5 d/wk 6 hr/d	Resp	3 <sup>b</sup>	10 (hyperplasia)	Nitschke et al. 1981
<b>CHRONIC EXPOSURE</b>							
	Cancer					11	
					↓		
	38	Rat	18 mo 5 d/wk 7 hr/d			20 (CEL, multiple organs)	Wong et al. 1982
	39	Rat	89–104 wk 5 d/wk 6 hr/d			10 (CEL, lung tumors, nasal tumors)	NTP 1982
	40	Mouse	79–103 wk 5 d/wk 6 hr/d			10 (CEL, lung tumors, hemangiosarcomas)	NTP 1982

12 →

<sup>a</sup> The number corresponds to entries in Figure 3-1.

<sup>b</sup> Used to derive an intermediate inhalation Minimal Risk Level (MRL) of  $5 \times 10^{-3}$  ppm; dose adjusted for intermittent exposure and divided by an uncertainty factor of 100 (10 for extrapolation from animal to humans, 10 for human variability).

# SAMPLE

### Figure 3-1. Levels of Significant Exposure to [Chemical X] - Inhalation

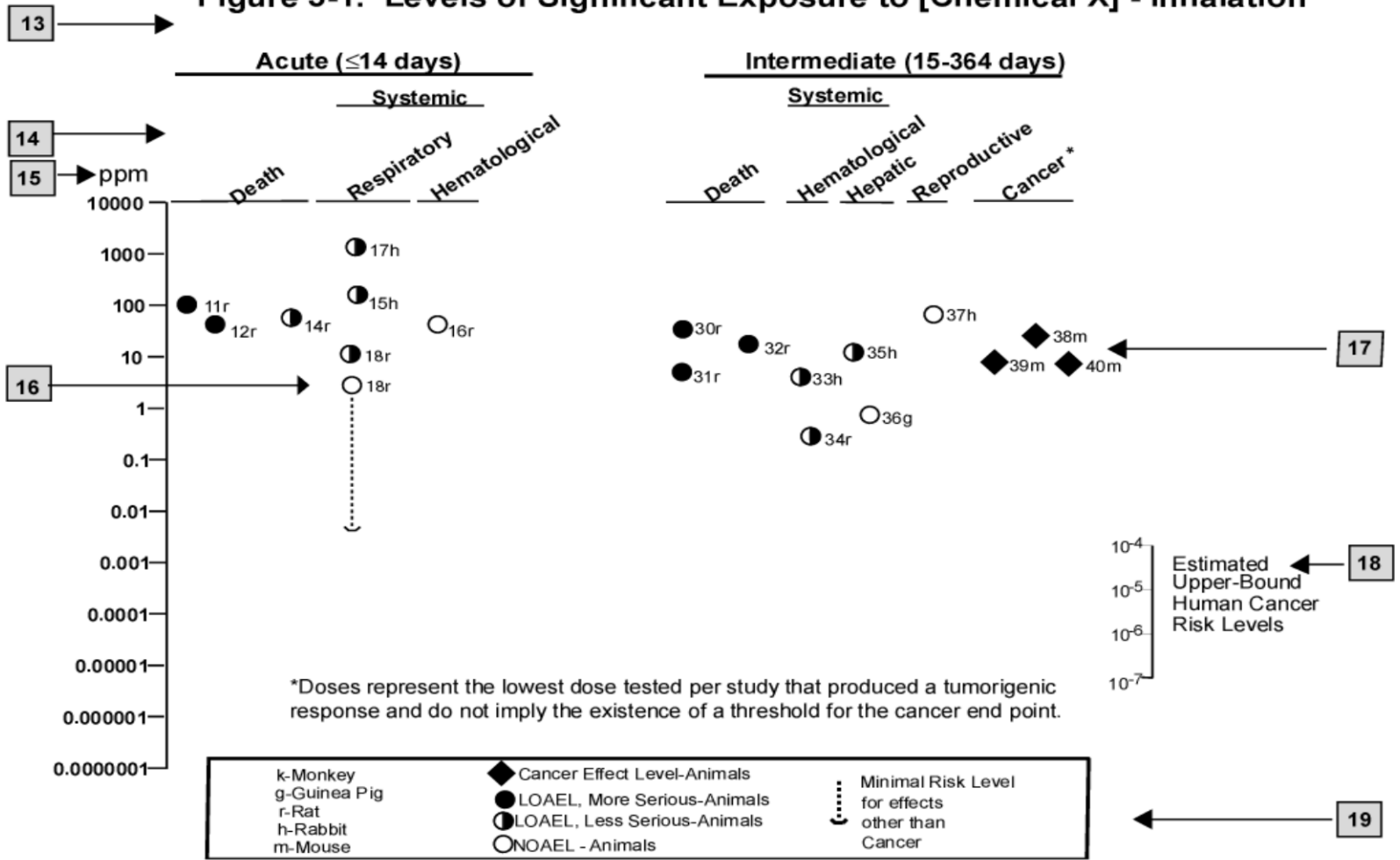

\*\*\*DRAFT FOR PUBLIC COMMENT\*\*\*

APPENDIX B

APPENDIX B

This page is intentionally blank.

## APPENDIX C. ACRONYMS, ABBREVIATIONS, AND SYMBOLS

ACGIH	American Conference of Governmental Industrial Hygienists
ACOEM	American College of Occupational and Environmental Medicine
ADI	acceptable daily intake
ADME	absorption, distribution, metabolism, and excretion
AED	atomic emission detection
AFID	alkali flame ionization detector
AFOSH	Air Force Office of Safety and Health
ALT	alanine aminotransferase
AML	acute myeloid leukemia
AOAC	Association of Official Analytical Chemists
AOEC	Association of Occupational and Environmental Clinics
AP	alkaline phosphatase
APHA	American Public Health Association
AST	aspartate aminotransferase
atm	atmosphere
ATSDR	Agency for Toxic Substances and Disease Registry
AWQC	Ambient Water Quality Criteria
BAT	best available technology
BCF	bioconcentration factor
BEI	Biological Exposure Index
BMD	benchmark dose
BMD/C	benchmark dose or benchmark concentration
BMD <sub>x</sub>	dose that produces a X% change in response rate of an adverse effect
BMDL <sub>x</sub>	95% lower confidence limit on the BMD <sub>x</sub>
BMDS	Benchmark Dose Software
BSC	Board of Scientific Counselors
C	centigrade
CAA	Clean Air Act
CAG	Cancer Assessment Group of the U.S. Environmental Protection Agency
CAS	Chemical Abstract Services
CDC	Centers for Disease Control and Prevention
CEL	cancer effect level
CELDS	Computer-Environmental Legislative Data System
CERCLA	Comprehensive Environmental Response, Compensation, and Liability Act
CFR	Code of Federal Regulations
Ci	curie
CI	confidence interval
CL	ceiling limit value
CLP	Contract Laboratory Program
cm	centimeter
CML	chronic myeloid leukemia
CPSC	Consumer Products Safety Commission
CWA	Clean Water Act
DHEW	Department of Health, Education, and Welfare
DHHS	Department of Health and Human Services
DNA	deoxyribonucleic acid
DOD	Department of Defense
DOE	Department of Energy
DOL	Department of Labor

## APPENDIX C

DOT	Department of Transportation
DOT/UN/ NA/IMDG	Department of Transportation/United Nations/ North America/Intergovernmental Maritime Dangerous Goods Code
DWEL	drinking water exposure level
ECD	electron capture detection
ECG/EKG	electrocardiogram
EEG	electroencephalogram
EEGL	Emergency Exposure Guidance Level
EPA	Environmental Protection Agency
F	Fahrenheit
F <sub>1</sub>	first-filial generation
FAO	Food and Agricultural Organization of the United Nations
FDA	Food and Drug Administration
FEMA	Federal Emergency Management Agency
FIFRA	Federal Insecticide, Fungicide, and Rodenticide Act
FPD	flame photometric detection
fpm	feet per minute
FR	Federal Register
FSH	follicle stimulating hormone
g	gram
GC	gas chromatography
gd	gestational day
GLC	gas liquid chromatography
GPC	gel permeation chromatography
HPLC	high-performance liquid chromatography
HRGC	high resolution gas chromatography
HSDB	Hazardous Substance Data Bank
IARC	International Agency for Research on Cancer
IDLH	immediately dangerous to life and health
ILO	International Labor Organization
IRIS	Integrated Risk Information System
K <sub>d</sub>	adsorption ratio
kg	kilogram
kkg	metric ton
K <sub>oc</sub>	organic carbon partition coefficient
K <sub>ow</sub>	octanol-water partition coefficient
L	liter
LC	liquid chromatography
LC <sub>50</sub>	lethal concentration, 50% kill
LC <sub>Lo</sub>	lethal concentration, low
LD <sub>50</sub>	lethal dose, 50% kill
LD <sub>Lo</sub>	lethal dose, low
LDH	lactic dehydrogenase
LH	lutinizing hormone
LOAEL	lowest-observed-adverse-effect level
LSE	Levels of Significant Exposure
LT <sub>50</sub>	lethal time, 50% kill
m	meter
MA	<i>trans,trans</i> -muconic acid
MAL	maximum allowable level
mCi	millicurie



## APPENDIX C

MCL	maximum contaminant level
MCLG	maximum contaminant level goal
MF	modifying factor
MFO	mixed function oxidase
mg	milligram
mL	milliliter
mm	millimeter
mmHg	millimeters of mercury
mmol	millimole
mppcf	millions of particles per cubic foot
MRL	Minimal Risk Level
MS	mass spectrometry
NAAQS	National Ambient Air Quality Standard
NAS	National Academy of Science
NATICH	National Air Toxics Information Clearinghouse
NATO	North Atlantic Treaty Organization
NCE	normochromatic erythrocytes
NCEH	National Center for Environmental Health
NCI	National Cancer Institute
ND	not detected
NFPA	National Fire Protection Association
ng	nanogram
NHANES	National Health and Nutrition Examination Survey
NIEHS	National Institute of Environmental Health Sciences
NIOSH	National Institute for Occupational Safety and Health
NIOSHTIC	NIOSH's Computerized Information Retrieval System
NLM	National Library of Medicine
nm	nanometer
nmol	nanomole
NOAEL	no-observed-adverse-effect level
NOES	National Occupational Exposure Survey
NOHS	National Occupational Hazard Survey
NPD	nitrogen phosphorus detection
NPDES	National Pollutant Discharge Elimination System
NPL	National Priorities List
NR	not reported
NRC	National Research Council
NS	not specified
NSPS	New Source Performance Standards
NTIS	National Technical Information Service
NTP	National Toxicology Program
ODW	Office of Drinking Water, EPA
OERR	Office of Emergency and Remedial Response, EPA
OHM/TADS	Oil and Hazardous Materials/Technical Assistance Data System
OPP	Office of Pesticide Programs, EPA
OPPT	Office of Pollution Prevention and Toxics, EPA
OPPTS	Office of Prevention, Pesticides and Toxic Substances, EPA
OR	odds ratio
OSHA	Occupational Safety and Health Administration
OSW	Office of Solid Waste, EPA
OTS	Office of Toxic Substances

## APPENDIX C

OW	Office of Water
OWRS	Office of Water Regulations and Standards, EPA
PAH	polycyclic aromatic hydrocarbon
PBPD	physiologically based pharmacodynamic
PBPK	physiologically based pharmacokinetic
PCE	polychromatic erythrocytes
PEL	permissible exposure limit
pg	picogram
PHS	Public Health Service
PID	photo ionization detector
pmol	picomole
PMR	proportionate mortality ratio
ppb	parts per billion
ppm	parts per million
ppt	parts per trillion
PSNS	pretreatment standards for new sources
RBC	red blood cell
REL	recommended exposure level/limit
RfC	reference concentration
RfD	reference dose
RNA	ribonucleic acid
RQ	reportable quantity
RTECS	Registry of Toxic Effects of Chemical Substances
SARA	Superfund Amendments and Reauthorization Act
SCE	sister chromatid exchange
SGOT	serum glutamic oxaloacetic transaminase
SGPT	serum glutamic pyruvic transaminase
SIC	standard industrial classification
SIM	selected ion monitoring
SMCL	secondary maximum contaminant level
SMR	standardized mortality ratio
SNARL	suggested no adverse response level
SPEGL	Short-Term Public Emergency Guidance Level
STEL	short term exposure limit
STORET	Storage and Retrieval
TD <sub>50</sub>	toxic dose, 50% specific toxic effect
TLV	threshold limit value
TOC	total organic carbon
TPQ	threshold planning quantity
TRI	Toxics Release Inventory
TSCA	Toxic Substances Control Act
TWA	time-weighted average
UF	uncertainty factor
U.S.	United States
USDA	United States Department of Agriculture
USGS	United States Geological Survey
VOC	volatile organic compound
WBC	white blood cell
WHO	World Health Organization

## APPENDIX C

>	greater than
$\geq$	greater than or equal to
=	equal to
<	less than
$\leq$	less than or equal to
%	percent
$\alpha$	alpha
$\beta$	beta
$\gamma$	gamma
$\delta$	delta
$\mu\text{m}$	micrometer
$\mu\text{g}$	microgram
$q_1^*$	cancer slope factor
-	negative
+	positive
(+)	weakly positive result
(-)	weakly negative result

APPENDIX C

This page is intentionally blank.

## APPENDIX D. OVERVIEW OF BASIC RADIATION PHYSICS, CHEMISTRY, AND BIOLOGY

Understanding the basic concepts in radiation physics, chemistry, and biology is important to the evaluation and interpretation of radiation-induced adverse health effects and to the derivation of radiation protection principles. This appendix presents a brief overview of the areas of radiation physics, chemistry, and biology and is based to a large extent on the reviews of Mettler and Moseley (1985), Hobbs and McClellan (1986), Eichholz (1982), Hendee (1973), Cember (1996), and Early et al. (1979).

### D.1 RADIONUCLIDES AND RADIOACTIVITY

The substances we call elements are composed of atoms. Atoms in turn are made up of neutrons, protons and electrons: neutrons and protons in the nucleus and electrons in a cloud of orbits around the nucleus. Nuclide is the general term referring to any nucleus along with its orbital electrons. The nuclide is characterized by the composition of its nucleus and hence by the number of protons and neutrons in the nucleus. All atoms of an element have the same number of protons (this is given by the atomic number) but may have different numbers of neutrons (this is reflected by the atomic mass numbers or atomic weight of the element). Atoms with different atomic mass but the same atomic numbers are referred to as isotopes of an element.

The numerical combination of protons and neutrons in most nuclides is such that the nucleus is quantum mechanically stable and the atom is said to be stable, i.e., not radioactive; however, if there are too few or too many neutrons, the nucleus is unstable and the atom is said to be radioactive. Unstable nuclides undergo radioactive transformation, a process in which a neutron or proton converts into the other and a beta particle is emitted, or else an alpha particle is emitted. Each type of decay is typically accompanied by the emission of gamma rays. These unstable atoms are called radionuclides; their emissions are called ionizing radiation; and the whole property is called radioactivity. Transformation or decay results in the formation of new nuclides some of which may themselves be radionuclides, while others are stable nuclides. This series of transformations is called the decay chain of the radionuclide. The first radionuclide in the chain is called the parent; the subsequent products of the transformation are called progeny, daughters, or decay products.

In general there are two classifications of radioactivity and radionuclides: natural and artificial (man-made). Naturally-occurring radioactive material (NORM) exists in nature and no additional energy is necessary to place them in an unstable state. Natural radioactivity is the property of some naturally occurring, usually heavy elements, that are heavier than lead. Radionuclides, such as radium and uranium, primarily emit alpha particles. Some lighter elements such as carbon-14 and tritium (hydrogen-3) primarily emit beta particles as they transform to a more stable atom. Natural radioactive atoms heavier than lead cannot attain a stable nucleus heavier than lead. Everyone is exposed to background radiation from naturally-occurring radionuclides throughout life. This background radiation is the major source of radiation exposure to man and arises from several sources. The natural background exposures are frequently used as a standard of comparison for exposures to various artificial sources of ionizing radiation.

Artificial radioactive atoms are produced either as a by-product of fission of uranium or plutonium atoms in a nuclear reactor or by bombarding stable atoms with particles, such as neutrons or protons, directed at the stable atoms with high velocity. These artificially produced radioactive elements usually decay by emission of particles, such as positive or negative beta particles and one or more high energy photons (gamma rays). Unstable (radioactive) atoms of any element can be produced.

## APPENDIX D

Both naturally occurring and artificial radioisotopes find application in medicine, industrial products, and consumer products. Some specific radioisotopes, called fall-out, are still found in the environment as a result of nuclear weapons use or testing.

## D.2 RADIOACTIVE DECAY

### D.2.1 Principles of Radioactive Decay

The stability of an atom is the result of the balance of the forces of the various components of the nucleus. An atom that is unstable (radionuclide) will release energy (decay) in various ways and transform to stable atoms or to other radioactive species called daughters, often with the release of ionizing radiation. If there are either too many or too few neutrons for a given number of protons, the resulting nucleus may undergo transformation. For some elements, a chain of daughter decay products may be produced until stable atoms are formed. Radionuclides can be characterized by the type and energy of the radiation emitted, the rate of decay, and the mode of decay. The mode of decay indicates how a parent compound undergoes transformation. Radiations considered here are primarily of nuclear origin, i.e., they arise from nuclear excitation, usually caused by the capture of charged or uncharged nucleons by a nucleus, or by the radioactive decay or transformation of an unstable nuclide. The type of radiation may be categorized as charged or uncharged particles, protons, and fission products) or electromagnetic radiation (gamma rays and x rays). Table D-1 summarizes the basic characteristics of the more common types of radiation encountered.

### D.2.2 Half-Life and Activity

For any given radionuclide, the rate of decay is a first-order process that is constant, regardless of the radioactive atoms present and is characteristic for each radionuclide. The process of decay is a series of random events; temperature, pressure, or chemical combinations do not effect the rate of decay. While it may not be possible to predict exactly which atom is going to undergo transformation at any given time, it is possible to predict, on average, the fraction of the radioactive atoms that will transform during any interval of time.

The *activity* is a measure of the quantity of radioactive material. For these radioactive materials it is customary to describe the activity as the number of disintegrations (transformations) per unit time. The unit of activity is the curie (Ci), which was originally related to the activity of one gram of radium, but is now defined as that quantity of radioactive material in which there are:

1 curie (Ci) =  $3.7 \times 10^{10}$  disintegrations (transformations)/second (dps) or  $2.22 \times 10^{12}$  disintegrations (transformations)/minute (dpm).

The SI unit of activity is the becquerel (Bq); 1 Bq = that quantity of radioactive material in which there is 1 transformation/second. Since activity is proportional to the number of atoms of the radioactive material, the quantity of any radioactive material is usually expressed in curies, regardless of its purity or concentration. The transformation of radioactive nuclei is a random process, and the number of transformations is directly proportional to the number of radioactive atoms present. For any pure radioactive substance, the rate of decay is usually described by its radiological half-life,  $T_R$ , i.e., the time it takes for a specified source material to decay to half its initial activity. The specific activity is an indirect measure of the rate of decay, and is defined as the activity per unit mass or per unit volume. The higher the specific activity of a radioisotope, the faster it is decaying.

The activity of a radionuclide at time  $t$  may be calculated by:

## APPENDIX D

$$A = A_0 e^{-0.693t/T_{\text{rad}}}$$

where A is the activity in dps or curies or becquerels,  $A_0$  is the activity at time zero, t is the time at which measured, and  $T_{\text{rad}}$  is the radiological half-life of the radionuclide ( $T_{\text{rad}}$  and t must be in the same units of time). The time when the activity of a sample of radioactivity becomes one-half its original value is the radioactive half-life and is expressed in any suitable unit of time.

**Table D-1. Characteristics of Nuclear Radiations**

Radiation	Rest mass <sup>a</sup>	Charge	Typical energy range	Path length <sup>b</sup>		Comments
				Air	Solid	
Alpha ( $\alpha$ )	4.00 amu	+2	4–10 MeV	5–10 cm	25–80 $\mu\text{m}$	Identical to ionized He nucleus
Negatron ( $\beta^-$ )	5.48x10 <sup>-4</sup> amu; 0.51 MeV	-1	0–4 MeV	0–10 m	0–1 cm	Identical to electron
Positron ( $\beta^+$ )	5.48x10 <sup>-4</sup> amu; 0.51 MeV	+1	0–4 MeV	0–10 m	0–1 cm	Identical to electron except for sign of charge
Neutron	1.0086 amu; 939.55 MeV	0	0–15 MeV	b	b	Free half-life: 16 minutes
X ray (e.m. photon)	–	0	5 keV–100 keV	b	b	Photon from transition of an electron between atomic orbits
Gamma ( $\gamma$ ) (e.m. photon)	–	0	10 keV–3 MeV	b	b	Photon from nuclear transformation

<sup>a</sup> The rest mass (in amu) has an energy equivalent in MeV that is obtained using the equation  $E=mc^2$ , where 1 amu = 932 MeV.

<sup>b</sup> Path lengths are not applicable to x- and gamma rays since their intensities decrease exponentially; path lengths in solid tissue are variable, depending on particle energy, electron density of material, and other factors.

amu = atomic mass unit; e.m. = electromagnetic; MeV = MegaElectron Volts

The specific activity is a measure of activity, and is fined as the activity per unit mass or per unit volume. This activity is usually expressed in curies per gram and may be calculated by

$$\text{curies/gram} = 1.3 \times 10^8 / (T_{\text{rad}}) (\text{atomic weight}) \quad \text{or}$$

$$[3.577 \times 10^5 \times \text{mass(g)}] / [T_{\text{rad}} \times \text{atomic weight}]$$

where  $T_{\text{rad}}$  is the radiological half-life in days.

In the case of radioactive materials contained in living organisms, an additional consideration is made for the reduction in observed activity due to regular processes of elimination of the respective chemical or biochemical substance from the organism. This introduces a rate constant called the biological half-life

## APPENDIX D

( $T_{\text{biol}}$ ) which is the time required for biological processes to eliminate one-half of the activity. This time is virtually the same for both stable and radioactive isotopes of any given element.

Under such conditions the time required for a radioactive element to be halved as a result of the combined action of radioactive decay and biological elimination is the effective clearance half-time:

$$T_{\text{eff}} = (T_{\text{biol}} \times T_{\text{rad}}) / (T_{\text{biol}} + T_{\text{rad}}).$$

Table D-2 presents representative effective half-lives of particular interest.

**Table D-2. Half-Lives of Some Radionuclides in Adult Body Organs**

Radionuclide	Critical organ	Half-life <sup>a</sup>		
		Physical	Biological	Effective
Uranium 238	Kidney	4,460,000,000 y	4 d	4 d
Hydrogen 3 <sup>b</sup> (Tritium)	Whole body	12.3 y	10 d	10 d
Iodine 131	Thyroid	8 d	80 d	7.3 d
Strontium 90	Bone	28 y	50 y	18 y
Plutonium 239	Bone surface	24,400 y	50 y	50 y
	Lung	24,400 y	500 d	500 d
Cobalt 60	Whole body	5.3 y	99.5 d	95 d
Iron 55	Spleen	2.7 y	600 d	388 d
Iron 59	Spleen	45.1 d	600 d	42 d
Manganese 54	Liver	303 d	25 d	23 d
Cesium 137	Whole body	30 y	70 d	70 d

<sup>a</sup>d = days, y = years

<sup>b</sup>Mixed in body water as tritiated water

### D.2.3 Interaction of Radiation with Matter

Both ionizing and nonionizing radiation will interact with materials; that is, radiation will lose kinetic energy to any solid, liquid or gas through which it passes by a variety of mechanisms. The transfer of energy to a medium by either electromagnetic or particulate radiation may be sufficient to cause formation of ions. This process is called ionization. Compared to other types of radiation that may be absorbed, such as ultraviolet radiation, ionizing radiation deposits a relatively large amount of energy into a small volume.

The method by which incident radiation interacts with the medium to cause ionization may be direct or indirect. Electromagnetic radiations (x rays and gamma photons) are indirectly ionizing; that is, they give up their energy in various interactions with cellular molecules, and the energy is then utilized to produce a fast-moving charged particle such as an electron. It is the electron that then may react with a target molecule. This particle is called a “primary ionizing particle. Charged particles, in contrast, strike the tissue or medium and directly react with target molecules, such as oxygen or water. These particulate radiations are directly ionizing radiations. Examples of directly ionizing particles include alpha and beta particles. Indirectly ionizing radiations are always more penetrating than directly ionizing particulate radiations.



## APPENDIX D

Mass, charge, and velocity of a particle all affect the rate at which ionization occurs. The higher the charge of the particle and the lower the velocity, the greater the propensity to cause ionization. Heavy, highly charged particles, such as alpha particles, lose energy rapidly with distance and, therefore, do not penetrate deeply. The result of these interaction processes is a gradual slowing down of any incident particle until it is brought to rest or "stopped" at the end of its range.

## D.2.4 Characteristics of Emitted Radiation

**D.2.4.1 Alpha Emission.** In alpha emission, an alpha particle consisting of two protons and two neutrons is emitted with a resulting decrease in the atomic mass number by four and reduction of the atomic number of two, thereby changing the parent to a different element. The alpha particle is identical to a helium nucleus consisting of two neutrons and two protons. It results from the radioactive decay of some heavy elements such as uranium, plutonium, radium, thorium, and radon. All alpha particles emitted by a given radioisotope have the same energy. Most of the alpha particles that are likely to be found have energies in the range of about 4 to 8 MeV, depending on the isotope from which they came.

The alpha particle has an electrical charge of +2. Because of this double positive charge and their size, alpha particles have great ionizing power and, thus, lose their kinetic energy quickly. This results in very little penetrating power. In fact, an alpha particle cannot penetrate a sheet of paper. The range of an alpha particle (the distance the charged particle travels from the point of origin to its resting point) is about 4 cm in air, which decreases considerably to a few micrometers in tissue. These properties cause alpha emitters to be hazardous only if there is internal contamination (i.e., if the radionuclide is inside the body).

**D.2.4.2 Beta Emission.** A beta particle ( $\beta$ ) is a high-velocity electron ejected from a disintegrating nucleus. The particle may be either a negatively charged electron, termed a negatron ( $\beta^-$ ) or a positively charged electron, termed a positron ( $\beta^+$ ). Although the precise definition of "beta emission" refers to both  $\beta^-$  and  $\beta^+$ , common usage of the term generally applies only to the negative particle, as distinguished from the positron emission, which refers to the  $\beta^+$  particle.

**D.2.4.2.1 Beta Negative Emission.** Beta particle ( $\beta^-$ ) emission is another process by which a radionuclide, with a neutron excess achieves stability. Beta particle emission decreases the number of neutrons by one and increases the number of protons by one, while the atomic mass number remains unchanged.<sup>1</sup> This transformation results in the formation of a different element. The energy spectrum of beta particle emission ranges from a certain maximum down to zero with the mean energy of the spectrum being about one-third of the maximum. The range in tissue is much less. Beta negative emitting radionuclides can cause injury to the skin and superficial body tissues, but mostly present an internal contamination hazard.

**D.2.4.2.2 Positron Emission.** In cases in which there are too many protons in the nucleus, positron emission may occur. In this case a proton may be thought of as being converted into a neutron, and a positron ( $\beta^+$ ) is emitted.<sup>1</sup> This increases the number of neutrons by one, decreases the number of protons by one, and again leaves the atomic mass number unchanged. The gamma radiation resulting from the annihilation (see glossary) of the positron makes all positron emitting isotopes more of an external radiation hazard than pure  $\beta$  emitters of equal energy.

**D.2.4.2.3 Gamma Emission.** Radioactive decay by alpha, beta, or positron emission, or electron capture often leaves some of the energy resulting from these changes in the nucleus. As a result, the nucleus is raised to an excited level. None of these excited nuclei can remain in this high-energy state.

---

<sup>1</sup> Neutrinos also accompany negative beta particles and positron emissions

## APPENDIX D

Nuclei release this energy returning to ground state or to the lowest possible stable energy level. The energy released is in the form of gamma radiation (high energy photons) and has an energy equal to the change in the energy state of the nucleus. Gamma and x rays behave similarly but differ in their origin; gamma emissions originate in the nucleus while x rays originate in the orbital electron structure or from rapidly changing the velocity of an electron (e.g., as occurs when shielding high energy beta particles or stopping the electron beam in an x ray tube).

### D.3 ESTIMATION OF ENERGY DEPOSITION IN HUMAN TISSUES

Two forms of potential radiation exposures can result: internal and external. The term exposure denotes physical interaction of the radiation emitted from the radioactive material with cells and tissues of the human body. An exposure can be "acute" or "chronic" depending on how long an individual or organ is exposed to the radiation. Internal exposures occur when radionuclides, which have entered the body (e.g., through the inhalation, ingestion, or dermal pathways), undergo radioactive decay resulting in the deposition of energy to internal organs. External exposures occur when radiation enters the body directly from sources located outside the body, such as radiation emitters from radionuclides on ground surfaces, dissolved in water, or dispersed in the air. In general, external exposures are from material emitting gamma radiation, which readily penetrate the skin and internal organs. Beta and alpha radiation from external sources are far less penetrating and deposit their energy primarily on the skin's outer layer. Consequently, their contribution to the absorbed dose of the total body dose, compared to that deposited by gamma rays, may be negligible.

Characterizing the radiation dose to persons as a result of exposure to radiation is a complex issue. It is difficult to: (1) measure internally the amount of energy actually transferred to an organic material and to correlate any observed effects with this energy deposition; and (2) account for and predict secondary processes, such as collision effects or biologically triggered effects, that are an indirect consequence of the primary interaction event.

#### D.3.1 Dose/Exposure Units

**D.3.1.1 Roentgen.** The roentgen (R) is a unit of x or gamma-ray exposure and is measured by the amount of ionization caused in air by gamma or x radiation. One roentgen produces  $2.58 \times 10^{-4}$  coulomb per kilogram of air. In the case of gamma radiation, over the commonly encountered range of photon energy, the energy deposition in tissue for a dose of 1 R is about 0.0096 joules (J) /kg of tissue.

**D.3.1.2 Absorbed Dose and Absorbed Dose Rate.** The absorbed dose is defined as the energy imparted by the incident radiation to a unit mass of the tissue or organ. The unit of absorbed dose is the rad; 1 rad = 100 erg/gram = 0.01 J/kg in any medium. An exposure of 1 R results in a dose to soft tissue of approximately 0.01 J/kg. The SI unit is the gray which is equivalent to 100 rad or 1 J/kg. Internal and external exposures from radiation sources are not usually instantaneous but are distributed over extended periods of time. The resulting rate of change of the absorbed dose to a small volume of mass is referred to as the absorbed dose rate in units of rad/unit time.

**D.3.1.3 Working Levels and Working Level Months.** Working level (WL) is a measure of the atmospheric concentration of radon and its short-lived progeny. One WL is defined as any combination of short-lived radon daughters (through polonium-214), per liter of air, that will result in the emission of  $1.3 \times 10^5$  MeV of alpha energy. An activity concentration of 100 pCi radon-222/L of air, in equilibrium with its daughters, corresponds approximately to a potential alpha-energy concentration of 1 WL. The WL unit can also be used for thoron daughters. In this case,  $1.3 \times 10^5$  MeV of alpha energy (1 WL) is released by the thoron daughters in equilibrium with 7.5 pCi thoron/L. The potential alpha energy exposure of miners is commonly expressed in the unit Working Level Month (WLM). One WLM

## APPENDIX D

corresponds to exposure to a concentration of 1 WL for the reference period of 170 hours, or more generally

$$\text{WLM} = \text{concentration (WL)} \times \text{exposure time (months)} \quad (\text{one "month"} = 170 \text{ working hours}).$$

### D.3.2 Dosimetry Models

Dosimetry models are used to estimate the dose from internally deposited radioactive substances. The models for internal dosimetry consider the amount of radionuclides entering the body, the factors affecting their movement or transport through the body, distribution and retention of radionuclides in the body, and the energy deposited in organs and tissues from the radiation that is emitted during spontaneous decay processes. The dose pattern for radioactive materials in the body may be strongly influenced by the route of entry of the material. For industrial workers, inhalation of radioactive particles with pulmonary deposition and puncture wounds with subcutaneous deposition have been the most frequent. The general population has been exposed via ingestion and inhalation of low levels of naturally occurring radionuclides as well as radionuclides from nuclear weapons testing.

The models for external dosimetry consider only the photon doses to organs of individuals who are immersed in air or are exposed to a contaminated object.

**D.3.2.1 Ingestion.** Ingestion of radioactive materials is most likely to occur from contaminated foodstuffs or water or eventual ingestion of inhaled compounds initially deposited in the lung. Ingestion of radioactive material may result in toxic effects as a result of either absorption of the radionuclide or irradiation of the gastrointestinal tract during passage through the tract, or a combination of both. The fraction of a radioactive material absorbed from the gastrointestinal tract is variable, depending on the specific element, the physical and chemical form of the material ingested, and the diet, as well as some other metabolic and physiological factors. The absorption of some elements is influenced by age, usually with higher absorption in the very young.

**D.3.2.2 Inhalation.** The inhalation route of exposure has long been recognized as being a major portal of entry for both nonradioactive and radioactive materials. The deposition of particles within the lung is largely dependent upon the size of the particles being inhaled. After the particle is deposited, the retention will depend upon the physical and chemical properties of the dust and the physiological status of the lung. The retention of the particle in the lung depends on the location of deposition, in addition to the physical and chemical properties of the particles. The converse of pulmonary retention is pulmonary clearance. There are three distinct mechanisms of clearance which operate simultaneously. Ciliary clearance acts only in the upper respiratory tract. The second and third mechanisms act mainly in the deep respiratory tract. These are phagocytosis and absorption. Phagocytosis is the engulfing of foreign bodies by alveolar macrophages and their subsequent removal either up the ciliary "escalator" or by entrance into the lymphatic system. Some inhaled soluble particles are absorbed into the blood and translocated to other organs and tissues.

### D.3.3 Internal Emitters

An internal emitter is a radionuclide that is inside the body. The absorbed dose from internally deposited radioisotopes depends on the energy absorbed per unit tissue by the irradiated tissue. For a radioisotope distributed uniformly throughout an infinitely large medium, the concentration of absorbed energy must be equal to the concentration of energy emitted by the isotope. An infinitely large medium may be approximated by a tissue mass whose dimensions exceed the range of the particle. All alpha and most beta radiation will be absorbed in the organ (or tissue) of reference. Gamma-emitting isotope emissions are penetrating radiation, and a substantial fraction of gamma energy may be absorbed in tissue. The dose

## APPENDIX D

to an organ or tissue is a function of the effective retention half-time, the energy released in the tissue, the amount of radioactivity initially introduced, and the mass of the organ or tissue.

## D.4 BIOLOGICAL EFFECTS OF RADIATION

When biological material is exposed to ionizing radiation, a chain of cellular events occurs as the ionizing particle passes through the biological material. A number of theories have been proposed to describe the interaction of radiation with biologically important molecules in cells and to explain the resulting damage to biological systems from those interactions. Many factors may modify the response of a living organism to a given dose of radiation. Factors related to the exposure include the dose rate, the energy of the radiation, and the temporal pattern of the exposure. Biological considerations include factors such as species, age, sex, and the portion of the body exposed. Several excellent reviews of the biological effects of radiation have been published, and the reader is referred to these for a more in-depth discussion (Brodsky 1996; Hobbs and McClellan 1986; ICRP 1984; Mettler and Moseley 1985; Rubin and Casarett 1968).

### D.4.1 Radiation Effects at the Cellular Level

According to Mettler and Moseley (1985), at acute doses up to 10 rad (100 mGy), single strand breaks in DNA may be produced. These single strand breaks may be repaired rapidly. With doses in the range of 50–500 rad (0.5–5 Gy), irreparable double-stranded DNA breaks are likely, resulting in cellular reproductive death after one or more divisions of the irradiated parent cell. At large doses of radiation, usually greater than 500 rad (5 Gy), direct cell death before division (interphase death) may occur from the direct interaction of free-radicals with essentially cellular macromolecules. Morphological changes at the cellular level, the severity of which are dose-dependent, may also be observed.

The sensitivity of various cell types varies. According to the Bergonie-Tribondeau law, the sensitivity of cell lines is directly proportional to their mitotic rate and inversely proportional to the degree of differentiation (Mettler and Moseley 1985). Rubin and Casarett (1968) devised a classification system that categorized cells according to type, function, and mitotic activity. The categories range from the most sensitive type, "vegetative intermitotic cells," found in the stem cells of the bone marrow and the gastrointestinal tract, to the least sensitive cell type, "fixed postmitotic cells," found in striated muscles or long-lived neural tissues.

Cellular changes may result in cell death, which if extensive, may produce irreversible damage to an organ or tissue or may result in the death of the individual. If the cell recovers, altered metabolism and function may still occur, which may be repaired or may result in the manifestation of clinical symptoms. These changes may also be expressed at a later time as tumors or cellular mutations, which may result in abnormal tissue.

### D.4.2 Radiation Effects at the Organ Level

In most organs and tissues the injury and the underlying mechanism for that injury are complex and may involve a combination of events. The extent and severity of this tissue injury are dependent upon the radiosensitivity of the various cell types in that organ system. Rubin and Casarett (1968) describe and schematically display the events following radiation in several organ system types. These include: a rapid renewal system, such as the gastrointestinal mucosa; a slow renewal system, such as the pulmonary epithelium; and a nonrenewal system, such as neural or muscle tissue. In the rapid renewal system, organ injury results from the direct destruction of highly radiosensitive cells, such as the stem cells in the bone marrow. Injury may also result from constriction of the microcirculation and from edema and inflammation of the basement membrane, designated as the histohematic barrier (HHB), which may

## APPENDIX D

progress to fibrosis. In slow renewal and nonrenewal systems, the radiation may have little effect on the parenchymal cells, but ultimate parenchymal atrophy and death over several months result from HHB fibrosis and occlusion of the microcirculation.

#### **D.4.3 Low Level Radiation Effects**

Cancer is the major latent harmful effect produced by ionizing radiation and the one that most people exposed to radiation are concerned about. The ability of alpha, beta, and gamma radiation to produce cancer in virtually every tissue and organ in laboratory animals has been well-demonstrated. The development of cancer is not an immediate effect. Radiation-induced leukemia has the shortest latent period at 2 years, while other radiation induced cancers have latent periods >20 years. The mechanism by which cancer is induced in living cells is complex and is a topic of intense study. Exposure to ionizing radiation can produce cancer at any site within the body; however, some sites appear to be more common than others, such as the breast, lung, stomach, and thyroid.

DNA is a major target molecule during exposure to ionizing radiation. Other macromolecules, such as lipids and proteins, are also at risk of damage when exposed to ionizing radiation. The genotoxicity of ionizing radiation is an area of intense study, as damage to the DNA is ultimately responsible for many of the adverse toxicological effects ascribed to ionizing radiation, including cancer. Damage to genetic material is basic to developmental or teratogenic effects, as well. However, for effects other than cancer, there is little evidence of human effects at low levels of exposure.

### **D.5 UNITS IN RADIATION PROTECTION AND REGULATION**

#### **D.5.1 Dose Equivalent and Dose Equivalent Rate**

Dose equivalent or rem is a special radiation protection quantity that is used, for administrative and radiation safety purposes only, to express the absorbed dose in a manner which considers the difference in biological effectiveness of various kinds of ionizing radiation. The ICRU has defined the dose equivalent,  $H$ , as the product of the absorbed dose,  $D$ , and the quality factor,  $Q$ , at the point of interest in biological tissue. This relationship is expressed as  $H = D \times Q$ . The dose equivalent concept is applicable only to doses that are not great enough to produce biomedical effects.

The quality factor is a dimensionless quantity that depends in part on the stopping power for charged particles, and it accounts for the differences in biological effectiveness found among the types of radiation. Originally relative biological effectiveness (RBE) was used rather than  $Q$  to define the quantity, rem, which was of use in risk assessment. The generally accepted values for quality factors for various radiation types are provided in Table D-3. The dose equivalent rate is the time rate of change of the dose equivalent to organs and tissues and is expressed as rem/unit time or sievert/unit time.

## APPENDIX D

**Table D-3. Quality Factors (Q) and Absorbed Dose Equivalencies**

Type of radiation	Quality factor (Q)	Absorbed dose equal to a unit dose equivalent*
X, gamma, or beta radiation	1	1
Alpha particles, multiple-charged particles, fission fragments and heavy particles of unknown charge	20	0.05
Neutrons of unknown energy	10	0.1
High-energy protons	10	0.1

\*Absorbed dose in rad equal to 1 rem or the absorbed dose in gray equal to 1 sievert.

Source: USNRC. 1999. Standards for the protection against radiation, table 1004(b).1. 10 CFR 20.1004. U.S. Nuclear Regulatory Commission, Washington, D.C.

### D.5.2 Relative Biological Effectiveness

RBE is used to denote the experimentally determined ratio of the absorbed dose from one radiation type to the absorbed dose of a reference radiation required to produce an identical biologic effect under the same conditions. Gamma rays from cobalt-60 and 200–250 keV x-rays have been used as reference standards. The term RBE has been widely used in experimental radiobiology, and the term quality factor used in calculations of dose equivalents for radiation safety purposes (ICRP 1977; NCRP 1971; UNSCEAR 1982). RBE applies only to a specific biological end point, in a specific exposure, under specific conditions to a specific species. There are no generally accepted values of RBE.

### D.5.3 Effective Dose Equivalent and Effective Dose Equivalent Rate

The absorbed dose is usually defined as the mean absorbed dose within an organ or tissue. This represents a simplification of the actual problem. Normally when an individual ingests or inhales a radionuclide or is exposed to external radiation that enters the body (gamma), the dose is not uniform throughout the whole body. The simplifying assumption is that the detriment will be the same whether the body is uniformly or non-uniformly irradiated. In an attempt to compare detriment from absorbed dose of a limited portion of the body with the detriment from total body dose, the ICRP (1977) has derived a concept of effective dose equivalent. The effective dose equivalent,  $H_E$ , is

$$H_E = (\text{the sum of}) W_t H_t$$

where  $H_t$  is the dose equivalent in the tissue,  $W_t$  is the weighting factor, which represents the estimated proportion of the stochastic risk resulting from tissue, T, to the stochastic risk when the whole body is uniformly irradiated for occupational exposures under certain conditions (ICRP 1977). Weighting factors for selected tissues are listed in Table D-4.

The ICRU (1980), ICRP (1984), and NCRP (1985) now recommend that the rad, roentgen, curie, and rem be replaced by the SI units: gray (Gy), Coulomb per kilogram (C/kg), Becquerel (Bq), and sievert (Sv), respectively. The relationship between the customary units and the international system of units (SI) for radiological quantities is shown in Table D-5.

## APPENDIX D

**Table D-4. Weighting Factors for Calculating Effective Dose Equivalent for Selected Tissues**

Tissue	Weighting factor		
	ICRP60	NCRP115/ ICRP60	NRC
Bladder	0.040	0.05	–
Bone marrow	0.143	0.12	0.12
Bone surface	0.009	0.01	0.03
Breast	0.050	0.05	0.15
Colon	0.141	0.12	–
Liver	0.022	0.05	–
Lung	0.111	0.12	0.12
Esophagus	0.034	0.05	–
Ovary	0.020	0.05	–
Skin	0.006	0.01	–
Stomach	0.139	0.12	–
Thyroid	0.021	0.05	0.03
Gonads	0.183	0.20	0.25
subtotal	0.969	1	0.70
Remainder	0.031	0.05	0.30

ICRP60 = International Commission on Radiological Protection, 1990 Recommendations of the ICRP  
 NCRP115 = National Council on Radiation Protection and Measurements. 1993. Risk Estimates for Radiation Protection, Report 115. Bethesda, Maryland  
 NRC = Nuclear Regulatory Commission, Title 10, Code of Federal Regulations, Part 20

**Table D-5. Comparison of Common and SI Units for Radiation Quantities**

Quantity	Customary units	Definition	SI units	Definition
Activity (A)	curie (Ci)	$3.7 \times 10^{10}$ transformations s <sup>-1</sup>	becquerel (Bq)	s <sup>-1</sup>
Absorbed dose (D)	rad (rad)	$10^{-2}$ Jkg <sup>-1</sup>	gray (Gy)	Jkg <sup>-1</sup>
Absorbed dose rate ( $\dot{D}$ )	rad per second (rad s <sup>-1</sup> )	$10^{-2}$ Jkg <sup>-1</sup> s <sup>-1</sup>	gray per second (Gy s <sup>-1</sup> )	Jkg <sup>-1</sup> s <sup>-1</sup>
Dose equivalent (H)	rem (rem)	$10^{-2}$ Jkg <sup>-1</sup>	sievert (Sv)	Jkg <sup>-1</sup>
Dose equivalent rate ( $\dot{H}$ )	rem per second (rem s <sup>-1</sup> )	$10^{-2}$ Jkg <sup>-1</sup> s <sup>-1</sup>	sievert per second (Sv s <sup>-1</sup> )	Jkg <sup>-1</sup> s <sup>-1</sup>
Linear energy transfer (LET)	kiloelectron volts per micrometer (keV $\mu\text{m}^{-1}$ )	$1.602 \times 10^{-10}$ Jm <sup>-1</sup>	kiloelectron volts per micrometer (keV $\mu\text{m}^{-1}$ )	$1.602 \times 10^{-10}$ Jm <sup>-1</sup>

Jkg<sup>-1</sup> = Joules per kilogram; Jkg<sup>-1</sup>s<sup>-1</sup> = Joules per kilogram per second; Jm<sup>-1</sup> = Joules per meter; s<sup>-1</sup> = per second

## APPENDIX D

**REFERENCES FOR APPENDIX D**

ATSDR. 1990a. Toxicological profile for thorium. U.S. Department of Health and Human Services. Public Health Service. Agency for Toxic Substances and Disease Registry. Atlanta, GA.

ATSDR. 1990b. Toxicological profile for radium. U.S. Department of Health and Human Services. Public Health Service. Agency for Toxic Substances and Disease Registry. Atlanta, GA.

ATSDR. 1990c. Toxicological profile for radon. U.S. Department of Health and Human Services. Public Health Service. Agency for Toxic Substances and Disease Registry. Atlanta, GA.

ATSDR. 1999. Toxicological profile for uranium. U.S. Department of Health and Human Services. Public Health Service. Agency for Toxic Substances and Disease Registry. Atlanta, GA.

BEIR III. 1980. The effects on populations of exposure to low levels of ionizing radiation. Committee on the Biological Effects of Ionizing Radiations, National Research Council. Washington, DC: National Academy Press.

BEIR IV. 1988. Health risks of radon and other internally deposited alpha emitters. Committee on the Biological Effects of Ionizing Radiations, National Research Council. Washington, DC: National Academy Press.

BEIR V. 1988. Health effects of exposure to low levels of ionizing radiation. Committee on the Biological Effects of Ionizing Radiations, National Research Council. Washington, DC: National Academy Press.

Brodsky A. 1996. Review of radiation risks and uranium toxicity with application to decisions associated with decommissioning clean-up criteria. Hebron, Connecticut: RSA Publications.

Cember H. 1996. Introduction to health physics. New York, NY: McGraw Hill.

Early P, Razzak M, Sodee D. 1979. Nuclear medicine technology. 2nd ed. St. Louis: C.V. Mosby Company.

Eichholz G. 1982. Environmental aspects of nuclear power. Ann Arbor, MI: Ann Arbor Science.

Hendee W. 1973. Radioactive isotopes in biological research. New York, NY: John Wiley and Sons.

Hobbs C, McClellan R. 1986. Radiation and radioactive materials. In: Doull J, et al., eds. Casarett and Doull's Toxicology. 3rd ed. New York, NY: Macmillan Publishing Co., Inc., 497-530.

ICRP. 1977. International Commission on Radiological Protection. Recommendations of the International Commission on Radiological Protection. ICRP Publication 26. Vol 1. No. 3. Oxford: Pergamon Press.

ICRP. 1979. International Commission on Radiological Protection. Limits for intakes of radionuclides by workers. ICRP Publication 20. Vol. 3. No. 1-4. Oxford: Pergamon Press.

ICRP. 1979. Limits for Intakes of Radionuclides by Workers. Publication 30. International Commission on Radiological Protection. Pergamon Press.



## APPENDIX D

ICRP. 1984. International Commission on Radiological Protection. A compilation of the major concepts and quantities in use by ICRP. ICRP Publication 42. Oxford: Pergamon Press.

ICRP. 1990. International Commission on Radiological Protection 1990 Recommendations of the ICRP

ICRU. 1980. International Commission on Radiation Units and Measurements. ICRU Report No. 33. Washington, DC.

James A. 1987. A reconsideration of cells at risk and other key factors in radon daughter dosimetry. In: Hopke P, ed. Radon and its decay products: Occurrence, properties and health effects. ACS Symposium Series 331. Washington, DC: American Chemical Society, 400-418.

James A, Roy M. 1987. Dosimetric lung models. In: Gerber G, et al., ed. Age-related factors in radionuclide metabolism and dosimetry. Boston: Martinus Nijhoff Publishers, 95-108.

Kondo S. 1993. Health effects of low-level radiation. Kinki University Press, Osaka, Japan (available from Medical Physics Publishing, Madison, Wisconsin).

Kato H, Schull W. 1982. Studies of the mortality of A-bomb survivors. Report 7 Part 8, Cancer mortality among atomic bomb survivors, 1950-78. Radiat Res 90;395-432.

Mettler F, Moseley R. 1985. Medical effects of ionizing radiation. New York: Grune and Stratton.

NCRP. 1971. Basic radiation protection criteria. National Council on Radiation Protection and Measurements. Report No. 39. Washington, DC.

NCRP. 1985. A handbook of radioactivity measurements procedures. 2nd ed. National Council on Radiation Protection and Measurements. Report No. 58. Bethesda, MD:

NCRP. 1993. Risk estimates for radiation protection. National Council on Radiation Protection and Measurements. Report 115. Bethesda, Maryland

Otake M, Schull W. 1984. Mental retardation in children exposed in utero to the atomic bombs: A reassessment. Technical Report RERF TR 1-83, Radiation Effects Research Foundation, Japan.

Rubin P, Casarett G. 1968. Clinical radiation pathology. Philadelphia: W.B. Sanders Company, 33.

UNSCEAR. 1977. United Nations Scientific Committee on the Effects of Atomic Radiation. Sources and effects of ionizing radiation. New York: United Nations.

UNSCEAR. 1982. United Nations Scientific Committee on the Effects of Atomic Radiation. Ionizing radiation: Sources and biological effects. New York: United Nations.

UNSCEAR. 1986. United Nations Scientific Committee on the Effects of Atomic Radiation. Genetic and somatic effects of ionizing radiation. New York: United Nations.

UNSCEAR. 1988. United Nations Scientific Committee on the Effects of Atomic Radiation. Sources, effects and risks of ionization radiation. New York: United Nations.

## APPENDIX D

UNSCEAR. 1993. United Nations Scientific Committee on the Effects of Atomic Radiation. Sources and effects of ionizing radiation. New York: United Nations.

USNRC. 1999. Standards for the protection against radiation, table 1004(b).1. 10 CFR 20.1004. U.S. Nuclear Regulatory Commission, Washington, D.C.

## APPENDIX E. INDEX

absorbed dose.....	79
adenocarcinoma .....	30
adenocarcinomas.....	30
adipose tissue .....	44, 45, 46, 47
adsorbed .....	104, 134
adsorption.....	134, 135
ambient air .....	3, 101, 105, 107, 113, 114, 115, 128
bioaccumulation.....	128
biokinetic .....	50
biokinetics .....	44, 46, 47, 52, 71
biomarkers.....	79, 80, 90, 131, 140
breast milk.....	124
cancer .....	4, 9, 10, 11, 12, 16, 17, 18, 19, 20, 21, 22, 23, 24, 29, 30, 31, 32, 33, 38, 72, 76, 78, 81, 82, 83, 84, 85, 87, 88, 89, 90, 91, 92, 103, 141, 143, 145
carcinogen .....	29, 146
carcinogenic .....	16, 75, 146
carcinoma.....	30
cardiovascular .....	26, 27
cardiovascular effects.....	27
chromosomal aberrations .....	33, 36, 37, 38, 81
clearance .....	16, 38, 40, 41, 42, 50, 52, 54, 58, 60, 61, 63, 65, 67, 72, 82
death.....	10, 16, 18, 26, 27, 87
DNA.....	34, 36, 73, 75, 79, 84, 91
endocrine.....	76, 77
fetus.....	77
general population.....	79, 122, 128, 141
genotoxic.....	16, 33, 36, 81
genotoxicity.....	33, 37, 81, 88
groundwater .....	3, 9, 102, 103, 105, 107, 108, 110, 111, 112, 115, 118, 119, 123, 126, 129
half-life.....	2, 13, 16, 38, 60, 79, 102, 105, 107, 115, 131, 135, 136
hematological effects .....	27
immune system .....	89
immunological .....	16, 27
immunological effects.....	27
leukemia.....	18, 30, 88, 89
lung cancer.....	4, 10, 11, 12, 15, 16, 17, 18, 19, 20, 21, 22, 23, 24, 25, 26, 28, 29, 30, 31, 32, 72, 75, 80, 81, 82, 83, 84, 87, 88, 89, 90, 92, 123
lung tumors .....	11, 12, 18, 31, 32, 76, 82, 90
lymphatic .....	53
micronuclei .....	36, 37, 81
mucociliary .....	39, 41, 58, 82
neurobehavioral.....	77
nuclear.....	1, 10, 102, 109, 124, 126, 132, 135, 138
ocular effects.....	26
odds ratio.....	22, 23, 75, 83
partition coefficients .....	44, 45, 46, 52, 65, 67, 71
pharmacodynamic .....	49
pharmacokinetic.....	48, 49, 51

## APPENDIX E

pharmacokinetics .....	72, 77
pulmonary .....	11, 26, 83, 88, 89
pulmonary fibrosis .....	26, 88, 89
radon progeny .....	2, 3, 4, 5, 7, 9, 11, 13, 14, 15, 16, 19, 20, 21, 26, 27, 31, 33, 36,
.....	37, 38, 39, 40, 41, 42, 43, 45, 46, 47, 50, 52, 53, 63, 65, 67, 72, 73, 75, 79, 80, 81,
.....	82, 84, 85, 88, 89, 90, 91, 108, 114, 123, 125, 128, 131, 135, 140, 143
rate constant .....	40, 42, 44, 65
reactive oxygen species.....	75, 84, 91
renal effects .....	27
retention .....	48, 58, 60, 71, 99
sequestered.....	65
solubility .....	39, 41, 42, 44, 45, 46, 53, 56, 71, 107, 115
toxicokinetic.....	13, 89
toxicokinetics .....	38, 90, 91
tracheobronchial.....	14, 16, 41, 91
tumors .....	75, 83, 90, 103
volatility .....	116
volatilization .....	111

