

Modernized e-File (MeF) Guide for Software Developers And Transmitters

Tax Year 2007



Department of the Treasury
Internal Revenue Service

www.irs.gov

Publication 4164 (11-2007)
Catalog Number 36166N

Table of Contents

Table of Contents	i
1 Introduction.....	1
1.1 Modernized e-File (MeF).....	2
1.2 Communications	2
1.3 Highlights for Tax Year 2006, Processing Year 2007	5
1.4 Return Due Date Tables.....	8
1.5 Accepted Forms and Schedules	8
1.6 Amended Returns (and Superseding Returns)	9
1.6.1 Corporate Returns Forms 1120 and 1120S.....	9
1.6.2 Amended Partnership, Exempt Organization and Excise Tax Forms.....	10
1.7 Exclusions to Electronic Filing	11
2 XML Overview for MeF.....	15
2.1 MeF XML Structure.....	15
2.1.1 Schemas	15
2.1.2 Tag Names.....	16
2.1.3 Attributes	16
2.1.4 Repeating Group.....	18
2.1.5 Choice Construct	20
2.1.6 e-File Types	20
2.1.7 Attachments to Corporate Returns, Partnership Returns, and Extensions..	24
2.1.8 Exempt Organization Return Attachments.....	29
2.2 XML Character Representation.....	30
2.3 MeF Transmission and Submission File Structures for IFA and Application-to-Application (A2A).....	31
2.3.1 MeF Transmission and Submission File Structures for IFA	31
2.3.1.1 MeF Transmission File Structure for IFA	31
2.3.1.2 Submission File Structure for IFA Channels	32
2.3.1.3 Creating an MeF Attachment.....	34
Create Individual SubmissionZip Archive(s)	34
Generate the MeF Attachment.....	35

2.3.2	MeF Transmission and Submission File Structures for Application-to-Application (A2A)	37
2.3.2.1	MeF Transmission File Structure for Application-to- Application	37
2.3.2.2	MeF Submission File Structure for Application-to-Application	39
2.4	Version Control for MeF Schemas and Business Rules	40
2.4.1	Version Numbering Scheme	41
2.4.2	Validating Schema Versions	42
	Assurance Testing System (ATS) - Current Valid Schemas	44
	Production System - Current Valid Schemas	44
2.5	MeF XML Schema File Structures	45
2.5.1	1120/1120-F/1120S XML Schema File Structure (explanation on next page)...	46
2.5.2	7004 XML Schema File Structure (explanation on the next page)	49
2.5.3	Exempt Organization Forms XML Schema File Structures	51
2.5.4	1065/1065-B XML Schema File Structure (explanation on the next page).....	56
2.5.5	Excise Tax Forms 720/2290/8849 XML Schema File Structures	59
3	MeF Fed/State Program	63
4	Transmission Methods for MeF	65
4.1	Transmitting Through Application-to-Application (A2A)	65
4.1.1	Security Directive Rules of Behavior for Access to IRS Business Systems	65
4.1.2	Transmitting through MeF Application-to-Application (A2A)	70
4.1.3	General Information and Lessons Learned	71
4.2	Transmitting Through the Internet Filing Application (IFA)	74
4.2.1	Applying to Submit Returns Through the Internet	74
4.2.2	Transmitting through MeF Internet Filing (IFA)	76
4.2.3	Submitting a Transmission File	85
4.2.4	MeF Internet Filing Error Conditions	90
4.2.5	Browsers and Operating Systems	101
4.3	EMS No Longer Available for MeF	102
4.4	Detecting Viruses in MeF Transmissions	102
4.4.1	Through Internet Filing	102
4.4.2	Through Application-to-Application (A2A)	102
5	Validating the Transmission and Return Data	103
5.1	Business Rules (Categories/Severity)	103
5.2	Validating Transmission File	105

5.3	Validating Tax Returns	114
5.3.1	Schema Validation	114
5.3.2	Business Rule Validation	115
5.3.3	Checksum and Data Values Returned in the Acknowledgement File	118
5.4	Generating Acknowledgement Files.....	120
6	Retrieval Methods for MeF.....	124
6.1	Retrieving the Acknowledgement through Internet Filing	124
6.1.1	Accessing and Logging into MeF Internet Filing.....	125
6.1.2	Retrieving an Acknowledgement File	133
6.2	Retrieving Production Federal and/or State Submission Status Records.....	149
	View a List of Participating States.....	149
	Initiate a Request for Production Federal and/or State Submission Status Records.....	150
	Select an ETIN Associated with Production Submission Status Records	151
	Retrieve Production Submission Status Records	152
	Download New Production Submission Status Records	155
	Download Specific Production Status Records	156
6.3	Retrieving Acknowledgements through Application-to-Application (A2A).....	157
6.4	Retrieving State Submissions through Application-to-Application (A2A)	158
7	Payment Options.....	159
7.1	Electronic Funds Withdrawal.....	159
8	MeF Alternative Signatures	165
8.1	Practitioner PIN Option.....	165
8.2	Scanned Form 8453 Option.....	170
8.3	Elections That Require Separate Signatures.....	171
8.4	Forms Attached to 1120/1120-F/1120S with Separate Signatures	171
9	Electronic Signature Specifications.....	172
9.1	Jurat/Disclosure Guidelines	172
9.2	Jurat Language Text Selections.....	172
10	Form 7004, Automatic 6-Month Extension of Time to File Certain Business Income Tax, Information, and Other Returns.....	179

General Items of Interest for Form 7004.....	179
10.1 Types of Returns and Conditions for Which Form 7004 May Be Used to Request Extension of Time to File.....	179
10.2 Data Entry for Form 7004.....	179
10.3 Timely Filing of Form 7004.....	180
11 Exempt Organization Section.....	181
11.1 Form 8868, Application for Extension of Time to File an Exempt Organization Return.....	181
11.2 Reasonable Cause for Late Filing of Form 990, 990-EZ, 990-PF or 1120-POL.....	181
12 Excise Tax Section.....	182
Exhibits.....	183
Exhibit 1 - Business Name Control.....	184
Exhibit 2 - Identifiers.....	186
Exhibit 3 - Standard Postal Service State Abbreviations and ZIP Codes.....	188
Exhibit 4 - Foreign Country Codes.....	188
Exhibit 5 - Forms and Attachment Listing.....	188

1 Introduction

This publication outlines the communication procedures, transmission formats, business rules and validation procedures for returns e-filed through the Modernized e-File (MeF) system. Software Developers and Transmitters need to use the guidelines provided in this publication, along with XML Schemas published on IRS.gov, in order to develop software for use with the MeF system.

The procedures in this publication should be used in conjunction with the following publications:

- Publication 3112, *IRS e-file Application and Participation* - contains information about the roles of software developers, transmitters and electronic return originators. IRS has standardized the information for all *e-file* programs.
- Publication 4162, *Modernized e-File Test Package for Forms 1120/1120-F/1120S/7004* - contains the instructions and test case scenarios for software developers and transmitters to use for Assurance Testing System (ATS) of 1120/1120S. This publication also contains the instructions and test case scenarios for Form 7004, Application for Automatic 6-Month Extension of Time to File Certain Business Income Tax, Information, and Other Returns.
- Publication 4163, *Modernized e-File Information for Authorized IRS e-file Providers and Large Taxpayers (Corporations, Partnerships and Tax Exempt Organizations)* - contains specific information applicable to Forms 1120, 1120-F, 1120S, 1065, 1065-B, 7004, 990, 990-EZ, 990-N, 990-PF, 1120-POL, and 8868 *e-file* programs.
- Publication 4205, *Modernized e-File Test Package for Exempt Organization Filings* - contains the instructions and test case scenarios for software developers and transmitters to use for Assurance Testing System (ATS) of Forms 990, 990-EZ, 990-N, 990-PF, 1120-POL, and 8868.
- Publication 4505, *Modernized e-File Test Package for Forms 1065/1065-B* – contains the instructions and test case scenarios for software developers and transmitters to use for Assurance Testing System (ATS) of Forms 1065/1065-B.
- Publication 4557, *Safeguarding Taxpayer Data: A Guide for Your Business* provides information on federal and state information security laws and regulations, as well as industry standards and best practices.
- I.R.S. Publication 4600, *Safeguarding Taxpayer Information: Quick Reference Guide for Business* is a new tri-fold brochure that summarizes and introduces Publication 4557. Businesses can use the brochure as an information security awareness and marketing tool.
- Publication, 4594, *Modernized e-File Test Package for Forms 720, 2290 and 8849* – contains the instructions and test case scenarios for software developers and transmitters to use for Assurance Testing System (ATS) of Forms 720, 2249 and 8849.

1.1 Modernized e-File (MeF)

In tax year 2007/processing year 2008, the IRS is enhancing the MeF system by adding the capabilities to *e-file* Form 1120-F, U.S. Income Tax Return of a Foreign Corporation and Form 990-N, *Electronic Notice (e-Postcard) for Tax-Exempt Organizations not Required To File Form 990 or 990-EZ*.

In future releases, the IRS plans to transition the existing *e-file* programs for Forms 1040 and 1041 to MeF. IRS will use the procedures in this publication as a standard for all *e-file* programs in the future.

IRS has combined information for Corporate, Partnership, Excise Tax, and Exempt Organization returns in this publication. Unless otherwise indicated, all information applies to all four return types.

This publication and its updates or revisions are available at www.irs.gov. Change pages, outlining the extent of any update/revision, will be posted separately.

1.2 Communications

IRS worked in partnership with many MeF stakeholders to develop the information contained within this publication. Your continued cooperation is requested. If you have any questions, suggestions or comments regarding this publication, or are aware of any errors (typographical, technical or usage) please contact us using the information in the table below.

Form	e-mail address	Mailing Address	Web-site address for IRS XML Schemas and Business Rules
720/2290/8849	ETEC.Mailbox@irs.gov	Internal Revenue Service MeF ETEC Program, SE:W:ETARC:D:D3 NCFB C4-401 5000 Ellin Road Lanham, MD 20706	http://www.irs.gov/efile/article/0,,id=169093,00.html
990/990, 990-EZ, 990-N, 990-PF, 1120-POL, and 8868	TE/GE-EO-efile@irs.gov	Internal Revenue Service Tiwana Holland, SE:T:BSP, 6N1 1111 Constitution Avenue, NW Washington, DC 20224	http://www.irs.gov/charities/article/0,,id=105955,00.html
1065/1065-B	1065MeF@irs.gov	Internal Revenue Service 1065 Program, SE:W:ETARC:D:D2 NCFB C4-278 5000 Ellin Road Lanham, MD 20706	http://www.irs.gov/efile/article/0,,id=153999,00.html
1120/1120S and 7004	1120@irs.gov	Internal Revenue Service 1120/1120S or 7004 Program, SE:W:ETARC:D:D1:A NCFB C4-338 5000 Ellin Road Lanham, MD 20706	http://www.irs.gov/efile/article/0,,id=128360,00.html
1120-F	LargeCorporate@irs.gov	Internal Revenue Service 1120-F Program Office SE:W:ETARC:D:D1 NCFB C4-432 5000 Ellin Road Lanham, MD 20706	http://www.irs.gov/efile/article/0,,id=128360,00.html

MeF Contact Information Table

The following list of communication vehicles will be used to distribute information and updates to MeF stakeholders:

- Each MeF Team maintains an e-mail distribution list of current and prospective partners. On an as-needed basis, updates and other communications are distributed to this group. To have your e-mail address added to the group, please send an e-mail with your name, company name, and any other relevant contact information to the specific group's e-mail address listed above. When possible, ETA will also communicate unscheduled downtime to the software developers via e-mail. The subject line of emails will begin with the words "MeF Alert".
- QuickAlerts is a FREE web based mass messaging system created for Authorized IRS *e-file* Providers, which includes Software Developers, Transmitters, and EROs. The QuickAlerts messaging system uses a "push technology" program that can instantly disseminate messages to thousands of subscribers via e-mail. After subscribing, Authorized IRS *e-file* Providers can receive communications 24 hours a day - 7 days a week, regarding processing delays, IRS *e-file* program updates, early notification of upcoming seminars and conferences. New subscribers may sign up at www.Envoyprofiles.com/quickalerts or through the links provided on the "Tax Professionals" page at www.irs.gov. In 2007, the subject line of a QuickAlert will identify the targeted audience (e.g. Software Developers and Transmitters, and/or Electronic Return Originators) and the targeted group (Individual *e-file*, or Business *e-file*).
- IRS provides assistance for MeF software testing and live processing through the *e-Help* desk. Software developers, transmitters and electronic return originators may call the *e-Help* Desk at 1-866-255-0654.
- IRS Website – This publication and its updates are available on www.irs.gov at: <http://www.irs.gov/taxpros/providers/article/0,,id=97626,00.html>
 - To determine if the MeF systems are operational, refer to the Modernized *e-File* (MeF) Status Page: <http://www.irs.gov/efile/article/0,,id=168537,00.html>
 - The [MeF Program Information Page](#) provides consolidated links to MeF Publications, Schemas and Business Rules, Stylesheets, Zip Code list, Country code list and list of Accepted Forms and Schedules.

1.3 Highlights for Tax Year 2007, Processing Year 2008

General Items of Interest

- MeF will not use EMS as a transmission channel after December 27, 2007. This impacts only MeF transmissions. After December 27, 2007, all MeF transmissions will have to come through either IFA or A2A. EMS will not be available for TY2007 ATS testing.
- MeF will generate “Alerts” when there is an issue that needs to be brought to the attention of the taxpayer. Alerts will be included in the acknowledgement file of accepted returns or rejected returns.
- MeF will implement Form 1120-F (U.S. Income Tax Return of a Foreign Corporation) beginning January 7, 2008.
- Beginning in 2008, small tax-exempt organizations that previously were not required to file returns may be required to file an annual electronic notice, Form 990-N, *Electronic Notice (e-Postcard) for Tax Exempt Organizations not Required To File Form 990 or 990-EZ*. This filing requirement applies to tax periods beginning after December 31, 2006. Organizations that do not file the notice will lose their tax-exempt status.

Small tax-exempt organizations whose gross receipts are normally \$25,000 or less, are not required to file *Form 990, Return of Organization Exempt From Income Tax*, or *Form 990-EZ, Short Form Return of Organization Exempt from Income Tax*. With the enactment of the Pension Protection Act of 2006 (PPA), these small tax-exempt organizations will now be required to electronically file Form 990-N, also known as *e-Postcard*, with the IRS annually. Exceptions to this requirement include organizations that are included in a group return, private foundations required to file Form 990-PF, and section 509(a)(3) supporting organizations required to file Form 990 or Form 990-EZ. In addition, this filing requirement does not apply to churches, their integrated auxiliaries, and conventions or associations of churches.

- The IRS developed special guidance to assist corporations and exempt organizations with the transition from filing a paper return to electronic filing. This guidance applies to corporations and exempt organizations required to *e-file* under the temporary regulations. Corporations and exempt organizations required to *e-file* should review this information available at www.irs.gov. Simply click on the “*e-file*” logo, then click on “*e-file* for Large and Mid-Size Corporations” or “*e-file* for Charities and Nonprofits”.
- As a new tax form type is added to the MeF platform (e.g. Form 1120-F or 990-N), tax returns will be accepted for the current processing year only (i.e. TY 2007). As subsequent tax years are added to the system, MeF will accept the current processing year and two prior processing year tax years. The directions to *e-file* are provided by Tax Year. Use TY 2007 directions to *e-file* when filing a TY 2007 return. TY 2006 returns on TY 2006 schemas may use TY 2006 directions to *e-file*. For example, in

the current 2008 processing year, MeF will accept *e-filed* Form 1120 returns for TY 2007, TY 2006 and TY 2005.

- There is a routine maintenance window generally scheduled from 1:00 am to 7:00 am, Eastern Standard Time on Sundays that may result in intermittent down time for transmitters. Work scheduled during this window will generally not be communicated to the software developers. For more information refer to: <http://www.irs.gov/efile/article/0,,id=168537,00.html>
- IRS Counsel reviewed Regulations to identify elections that require a signature to determine if the requirements can be changed. IRS published the results to this review on the Large and Mid-Size Business web pages at <http://www.irs.gov/businesses/corporations/article/0,,id=146959,00.html>. Any elections that require a separate signature and are not specifically addressed in temporary regulations may be submitted in PDF format.
- Transmitters will be able to send state submissions through both Application-to-Application (A2A) and Internet Filing Application (IFA). States will only be able to use A2A to pick up state returns and send IRS their state acknowledgements.
- The following form is no longer accepted through the Modernized *e-File* system:
 - Form 8913, Credit for Federal Telephone Excise Tax Paid (obsolete for TY 2007, but can still be filed for TY 2006 returns).
 - Short Period Returns (Corporate and Partnership Returns)

Note: When a taxpayer needs to file a short period return before the new tax year software is available (i.e., the taxpayer wants to file a TY2007 short period return at the end of February 2008 and before their software developer has released the TY2007 software), the return may be submitted using TY2006 schemas. To prevent a short period return from rejecting, ensure that the tax year in the Return Manifest and Return Header reflect the tax year of the schemas being used (i.e. TY 2006). Then enter the actual Beginning and Ending Date of the short period return (i.e. 01/01/2007 to 02/28/2007).

New Functionality and Forms

MeF *e-filing* capabilities have been extended to the following:

- The Submission manifest now includes the EIN (Employer Identification Number) of the taxpayer as well as the tax period beginning and ending dates. See the example in Section 2.3.1.3, Creating an MeF Attachment.
- The State Manifest will now include the schema version.
- The ReturnID has been removed from the Return Header Schema.

- The acknowledgment will include the “IRS Received Date”. For accepted returns, the date will reflect the date IRS considers the return received. Rejected returns will have the entry “N/A”.
- For rejected returns, the acknowledgment will include the Document ID if the following conditions are met: the XML data is well formed; individual documents can be extracted from the XML return data; and each document has a unique Document ID. This information is provided to help further identify the reason for the reject. For returns that do not meet these criteria, the Document ID cannot be provided. If these criteria are not met, “Not Available” will show in the field.
- The Automated Enrollment (AE) application was developed to replace the manual enrollment of application systems for Application to Application (A2A) Web Services. The AE application automates the manual enrollment process and provides a user interface for enrolling and maintaining application systems. More information is found in this Publication under [Registration for A2A credentials](#) in Section 4.1.1.
- To support strong authentication for MeF A2A Web services, the IRS is installing certificate-based authentication technology. The new authentication system will affect authentication for all A2A Web services. More information is found in this Publication under [Strong Authentication](#) in Section 4.1.1 and Section 4.1.3.
- IRS has developed a VIN (Vehicle Identification Number) data store which collects VIN data from Form 2290. Where the taxpayer has indicated consent, the VIN data will be shared with state registration agencies to verify that the Heavy Vehicle Use Tax (HVUT) obligation was paid for a vehicle. The implementation for sharing the VIN data store is not scheduled until summer of 2008.
- Form 990-N, Electronic Notice (e-Postcard) for Tax-Exempt Organizations not required to File Form 990 or 990-EZ.
- Excise Tax Forms 2290, *Heavy Highway Vehicle Use Tax Return*, 720, *Quarterly Federal Excise Tax Return*, and 8849, *Claim for Refund of Excise Taxes*.
- Form 1120-F, *U.S. Income Tax Return of a Foreign Corporation*
- XML schemas were developed and issued for the following forms that can be *e-filed* through the MeF system. The Return Data for each parent form (1120, 1120S, 1065, 990, etc) will list these forms if they are applicable:
 - Form 8923, *Mine Rescue Team Training Credit*
 - Form 8925, *Report of Employer-Owned Life Insurance Contracts*
 - Form 1120X, *Amended U.S. Corporation Income Tax Return* – Beginning with TY 2007, the 1120X will no longer be accepted as a PDF.

- XML schemas were developed and issued for the following new forms that can be *e-filed* with the Form 1120-F:
 - **Schedule M-3 (Form 1120-F)**, *Net Income (Loss) Reconciliation for Foreign Corporations With Reportable Assets of \$10 Million or More*
 - **Schedule M-1/M-2 (Form 1120-F)**, *Reconciliation of Income (Loss) and Analysis of Unappropriated Retained Earnings per Books*
 - **Schedule H (Form 1120-F)**, *Deductions Allocated to Effectively Income Under Regulations Section 1.861-8*
 - **Schedule I (Form 1120-F)**, *Interest Expense Allocation Under Regulations Section 1.882-5*
 - **Schedule P (Form 1120-F)**, *List of Foreign Partner Interests in Partnerships*
 - **Form 8302**, *Direct Deposit of Tax Refund of \$1 Million or More*
- The following forms are new to the 1120-F and may be attached as Portable Document Format (PDF) files, if needed:
 - **Form 8453-I**, *Foreign Corporation Income Tax Declaration for an IRS e-file Return*
 - **Form 8288-A**, *Statement of Withholding on Dispositions by Foreign Persons of U.S. Real Property Interests*
 - **Form 8805**, *Foreign Partner's Information Statement of Section 1446 Withholding Tax*
- Tax professionals can use the Practitioner PIN method of electronically signing the Form 1120-F return by using the new Form 8879-I, *IRS e-file Signature Authorization for Form 1120-F*
- Form 4136 - Credit Reference Numbers (CRNs) have been incorporated as attributes into the schemas for tax years 2005, 2006 and 2007; any significant credit amount entered in column (d) of the form will be associated with its relevant CRN. The earliest schema versions to include this attribute are: 2005v2.9 for TY2005, 2006v3.7 for TY2006, and 2007v2.0 for TY2007. Consequently, a submission with Form 4136 will reject if a prior version is used.

1.4 Return Due Dates Tables

The return due date and extended due date tables for TY 2007 for each MeF form can be found on irs.gov at: <http://www.irs.gov/efile/article/0,,id=174983,00.html>

1.5 Accepted Forms and Schedules

The list of TY 2007 Forms and Schedules for each form can be found on irs.gov at : <http://www.irs.gov/efile/article/0,,id=176123,00.html>

1.6 Amended Returns (and Superseding Returns)

The MeF system processes both superseding and amended returns. A **superseded return** is a subsequent return **filed within the filing period (including extensions)**. An **amended return** is a subsequent return **filed after the expiration of the filing period (including extensions)**.

IRS has issued final regulations (T.D. 9363) requiring electronic filing of corporate returns (1120 and 1120S) and exempt organization returns (990 series). Beginning with TY2006 returns, **both amended and superseding returns will be required to be e-filed** if the taxpayer is required to file electronically unless a taxpayer has received an approved waiver to file that particular return in paper. Section 1224 of the Taxpayer Relief Act of 1997, provides the *e-filing* requirements for partnership returns. Note: carryback claims are exempt from the *e-file* requirement and should be filed using the existing paper process.

The superseding return designation is only available for Forms 1120 and 1120S. A subsequent return can be filed within the filing period (including extensions) for the Forms 1065, 1065-B, 1120-F, 990, 990-EZ, 990-PF, and 1120-POL, and 2290. However, in order to avoid a reject for duplicate filing, the amended return box must be checked.

1.6.1 Corporate Returns Forms 1120 and 1120S

Amended and superseding corporate returns will be accepted for the 2005 tax year and forward. The earliest schema version that supports amended and superseding corporate returns for tax year 2005 is 2.5.

The following are not accepted for amended returns Forms 1120 and 1120S beginning with tax year 2007:

- Placeholder forms (to pass applicable business rules). Amended returns for Forms 1120 and 1120S have a subset of business rules that will be enforced, eliminating the need for placeholder forms. These business rules are located on irs.gov at: <http://www.irs.gov/efile/article/0,,id=128360,00.html>.
- A PDF Form 1120X
- A PDF statement for Form 1120 and 1120S to identify the line number of each amended item, corrected amount or treatment of the item, and explanation of the reason of the change.

For more information on corporate amended returns please refer to the following web page on irs.gov: <http://www.irs.gov/businesses/corporations/article/0,,id=146959,00.html>

1.6.2 Amended Partnership, Exempt Organizations and Excise Tax Forms

MeF can accept *e-filed* amended returns for Forms 1065, 1065-B, 990, 990-EZ, 990-PF, 1120-POL for tax year 2006 and forward. MeF can accept *e-filed* amended returns for Forms 1120-F and 2290 for tax year 2007 and forward. The amended return for the Form 720 (Form 720X) must be filed using the existing paper procedures.

For additional Partnership information please refer to the following web page on irs.gov: <http://www.irs.gov/businesses/small/article/0,,id=170978,00.html>

1.7 Exclusions to Electronic Filing

Returns and extensions meeting the conditions below cannot currently be filed electronically. (Note: Paper documents can be scanned and attached to electronic returns, but no paper documents will be accepted.)

For Forms 1120/1120S:

The Tax Year 2007 Corporate *e-file* Program does not accept and process the following corporate returns. Therefore, the corporation is excluded from the electronic filing requirement under Temporary Treasury Regulation Section 301.6011-5T unless otherwise noted.

- Returns with tax periods ending prior to December 2004
- Returns covering multiple tax periods
- Bank Holding Company Tax Act. Election to make installment payments for a portion of the total tax attributable to the Bank Holding Company Tax Act.
- Prompt Assessments
- Returns with reasonable cause as related to failing to pay and/or file timely. Note: Corporations required to *e-file* under Temporary Treasury Regulation Section 301.6011-5T are still required to file electronically. In order to comply with the mandatory *e-file* regulations, corporations must send the explanation of reasonable cause as a separate letter to Internal Revenue Service, ARKA Monterrey Park, 1973 N. Rulon White Blvd., Mail Stop 6552 (ARKA) - Attn: AM Clerical, Ogden, Utah 84404. These procedures do not apply to Form 2220 which should be filed as part of the electronic return.
- Returns with pre-computed penalty and interest. Note: Corporations required to *e-file* under Temporary Treasury Regulation Section 301.6011-5T are still required to file electronically. In order to comply with the mandatory *e-file* regulations, corporations must send the explanation of pre-computed penalty and interest as a separate letter to Internal Revenue Service, ARKA Monterrey Park, 1973 N. Rulon White Blvd., Mail Stop 6552 (ARKA) - Attn: AM Clerical, Ogden, Utah 84404.
- Requests for overpayments to be applied to another account. Note: Corporations required to *e-file* under Temporary Treasury Regulation Section 301.6011-5T are still required to file electronically. In order to comply with the mandatory *e-file* regulations, corporations must send the request to apply overpayments as a separate letter to Internal Revenue Service, ARKA Monterrey Park, 1973 N. Rulon White Blvd., Mail Stop 6552 (ARKA) - Attn: AM Clerical, Ogden, Utah 84404.

- **In 2008, the following forms cannot be filed electronically as a return.**
 - 1120-C (formerly 990-C) Farmer's Cooperative Association
 - 1120H Homeowners Association
 - 1120FSC Foreign Sales Corporations
 - *1120-L Life Insurance Company
 - 1120RIC Regulated Investment Companies
 - 1120REIT Real Estate Investment Trust
 - *1120-PC Property and Casualty
 - 1120-SF Settlement Funds
 - 1120ND Nuclear Decommission Trusts
 - 1120-IC-DISC Interest Charge Domestic International Sales
 - **1120X Amended Corporate Return

*Corporations required to *e-file* who have 1120-L or 1120-PC subsidiary returns should refer to “*Tax Year 2007 Directions to e-file*” for additional information at: <http://www.irs.gov/businesses/corporations/article/0,,id=163357,00.html>.

** The Form 1120X cannot be filed as a stand alone return. It can only be submitted as an attachment to a Form 1120 return.

For Form 7004:

- Name change applications
- Reasonable cause for failing to pay timely
- Reasonable cause for failing to file application timely
- Requests for refunds
- Election to make installment payments for a portion of balance due amount
- Applications requesting extension due to change in accounting period unless prior approval has been applied for from IRS or certain conditions have been met. See Publication 538, Accounting Periods and Methods, for details.
- Applications with Net Operating Loss Carryback. Form 1138 should be sent separately, not with the application.
- Applications attaching a Power of Attorney (POA). POA should be sent separately, not with the application.
- Early filed returns (filed before end of tax period)
- Filing short period extension due to termination of 1120S status
- Extensions for the following forms:
 - Form 706-GS(D)
 - Form 8612
 - Form 8613
 - Form 8725
 - Form 8831
 - Form 8924
 - 990-C
 - 1120 (subchapter T)
 - 1120-A (2005 and prior fiscal year corporations)

For Forms 990 & 990-EZ:

- Returns from organizations not recognized as exempt (application pending, etc.)
- Name change returns
- Returns showing a change in accounting period
- Short period returns (except for short period final returns)
- Early filed returns (filed before end of tax year except for final returns)
- Returns with tax periods ending prior to December 2004

For e-Postcard Form 990-N

- Returns with tax periods prior to December 2007
- Returns from organizations not recognized as exempt (application for exemption pending, etc.)
- Returns with attachments
- Organizations required to file Form 990, Form 990-EZ, Form 990-PF or Form 1120-POL.
- Organizations who are included in a group return
- Section 509(a)(3) supporting organizations required to file form 990 or form 990-EZ
Note: This filing requirement does not apply to churches, their integrated auxiliaries, and conventions or associations of churches.

For Form 990-PF:

- Returns from organizations not recognized as exempt (application for exemption pending, etc.)
- Returns with tax periods ending prior to December 2004
- Foreign private foundations
- Name change returns
- "Limited" 990-PFs, i.e., "Limited" 990-PFs are filed by organizations that originally received advance rulings as public charities but were later determined to be private foundations
- 507(b)(1)(A) terminations
- Foundations in 60-month terminations

For Form 1120-POL:

- Short period returns (except for short period final returns)
- Name change returns
- Returns with tax periods ending prior to December 2004
- Returns with non-numbered attachments/schedules (unless allowed for an attached form shared with Forms 1120/1120S) for which an IRS format has not been developed

For Form 8868:

- Extensions from organizations not recognized as exempt (application pending, etc.)
- Extensions other than the automatic extension (Part I)
- Extensions for short period returns
- Extensions for the following forms:
 - Form 990-BL
 - Form 6069
 - Form 8870
- Extensions for group returns
- Extensions for composite Forms 990-T
- Extensions for consolidated Forms 990-T

For Forms 1065/1065-B:

- Returns with tax periods ending in December 2005 and prior
- Returns granted approved waivers from electronic filing.
- Common Trust Fund Returns
- Returns with name changes (TY 2006 only)
- Returns with address changes (TY 2006 only)

For Excise Forms 720, 2290 and 8849:

- Form 2290: no returns will be accepted for tax periods ending prior to July 1, 2007
- Form 720: no returns will be accepted prior to third quarter 2007

2 XML Overview for MeF

The IRS uses XML (Extensible Markup Language), the language that specifies the structure and content of an XML document, to implement all forms and schedules in electronic format for Modernized *e-File*. In addition, this section explains some of the elements of an XML document.

2.1 MeF XML Structure

Like a paper tax return, an MeF tax return consists of a series of tax forms, schedules, and attachments that can be included for a specific type of tax return (1120, 1120-F, 1120S, 1120-POL, 1065, 1065-B, 990, 990-EZ, 990-N, 990-PF, 720, 2290, 8849, or extension (7004, 8868). For example, an 1120 return includes the Form 1120 and any attached forms, schedules, or attachments needed to complete the return. A consolidated structure includes the consolidated return, the parent return, and one or more subsidiary returns in addition to their respective forms, attachments, and schedules. A mixed consolidated return provides the structure to file a consolidated return with 1120-L and/or 1120-PC subconsolidations

For more information regarding these topics, refer to the *MeF Submission Composition Guide* posted to irs.gov at: <http://www.irs.gov/efile/article/0,,id=171946,00.html>

2.1.1 Schemas

IRS has structured tax return data into a series of schemas. A schema is an XML document that specifies the data elements, structure, and rules for each form, schedule, document, and/or attachment (Note: There are business rules in addition to the format defined by schema - see [Section 5.1](#) for more information about business rules). Unless otherwise noted, XML schemas must be used as defined by IRS.

Within the XML schema, data elements are the basic building blocks of an XML document. The schema recognizes two categories of element types: simple and complex. A simple type element contains only one data type and may only have documentation attributes (i.e. description, line number). A complex type element is an element that has one or more attributes or is the parent to one or more child elements.

In the schemas, IRS has declared most data elements for forms, schedules, and supporting data are optional. Keeping most data elements optional in the schemas is consistent with the way paper returns are filed since the taxpayer and return preparer have the responsibility to provide information as specified by IRS forms, instructions, and regulations.

Most of the required elements are in the return header schema. For example, the 1120 return header schema (ReturnHeader1120x.xsd file) contains the identifying information for the entity filing the return, and the name of the officer signing the return. The return header also contains optional information such as the preparer information, and the preparing firm's information.

It is important to note that the instance of a federal or state submission XML file cannot exceed 1 GB (uncompressed).

2.1.2 Tag Names

Each field on a tax form, document, or attachment is identified using an XML tag name within the XML schema.

Tag names were created using the following conventions:

- a meaningful phrase with the first letter of each word capitalized and using no spaces (upper Camel case)
- a length of not more than 30 characters
- IRS used standard abbreviations to meet the tag name 30 character limit

2.1.3 Attributes

Attributes provide additional information or describe a feature of a data element.

- The first letter of the first word of an attribute name is lower case; the first letter of each subsequent word is capitalized (lower Camel case).
- Fixed attributes are for IRS internal use only; do not include these with the instance XML data for transmission.

Every return document (form, schedule or attachment), which has an XML schema, has the following three attributes in its root element.

- **DocumentName attribute:** is an attribute of type `FIXED` (a string literal type) and has a value equal to the name of the form, schedule or a supporting document it represents. This attribute (wherever it occurs in the return) is used for IRS internal use only and must not be included in the tax return. However, after the return is received IRS XML parsers will add such attributes to the appropriate elements in the return for IRS downstream processing. Here is an example:

- In the XML data to be transmitted by the preparer:

```
<IRS1120 documentId="RetDoc010">
```

- After transmission, IRS XML parser will add:

```
<IRS1120 documentId="RetDoc010" documentName="IRS1120" displayName="1120">
```

- **documentId attribute:** is an attribute that uniquely identifies the document within the context of the whole return. Tax return preparer's software is responsible for generating a unique id of `idType` defined in `efileTypes.xsd` for each of the return documents. Here are some examples:

- `<IRS1120 documentId="DOC0001">`

- `<IRS1120ScheduleD documentId="0020.2225">`

- `<DualConsolidatedLossesStatement documentId="ABC:002.XY">`

- **displayName attribute:** is an attribute of type FIXED (a string literal type) and has a value equal to the display name of the form, schedule or a supporting document it represents.

This attribute (wherever it occurs in the return) is used for IRS internal use only and must not be included in the tax return. However, after the return is received, IRS XML parsers will add such attributes to the appropriate elements in the return for downstream processing. Here is an example:

- In the XML data to be transmitted by the preparer:

```
<IRS1120 documentId="RetDoc010">
```

- After transmission, IRS XML parser will add:

```
<IRS1120 documentId="RetDoc010" documentName="IRS1120" displayName="1120">
```

2.1.4 Repeating Group

A repeating group is a data element or a group of data elements that can repeat the number of times specified in the maxOccurs attribute. Repeating data elements or groups of data elements provide a consistent structure to capture information that is requested. For example, paper forms are limited by a number of rows defined on the form – repeating groups allow the structure to be used to capture an unlimited amount of data. Schedule D (Form 1120), Line 1 Short-Term Capital Gains and Losses, allows seven entries on the paper form. The corresponding MeF schema allows an unlimited number of entries for this repeating group of elements.

MeF schemas implement repeating groups by creating a form “type” that consists of data elements that can repeat by the number specified in the “minOccurs” and “maxOccurs”.

The following example illustrates a repeating group where Form 8621 DistriAndDisposOfStockType is the complex type that defines the content model for the repeating group:

```
<!-- Distribution and Disposition of Stock Type -->
<xsd:complexType name="DistriAndDisposOfStockType">
  <xsd:sequence>
    - <!-- Enter Your Total Distributions from the PFIC During the Current Tax Year -->
    <xsd:element name="TotalPFICDistriDuringCurrentTY" type="USAmountType" minOccurs="0">
      <xsd:annotation>
      <xsd:documentation>
        <Description>Enter your total distributions from the PFIC during the current tax year</Description>
        <LineNumber>Part IV Line 10a</LineNumber>
      </xsd:documentation>
      </xsd:annotation>
    </xsd:element>
    - <!-- Enter the Total Distributions Made by the Company for Each of the 3 Years Preceding the Current Tax Year-->
    <xsd:element name="DistributionsIn3PrecedingTY" type="USAmountType" minOccurs="0">
      <xsd:annotation>
      <xsd:documentation>
        <Description>Enter the total distributions made by the company for each of the 3 years preceding the current tax
          year</Description>
        <LineNumber>Part IV Line 10b</LineNumber>
      </xsd:documentation>
      </xsd:annotation>
    </xsd:element>
    - <!-- Divide Line 10b by 3 -->
    <xsd:element name="AvgDistribution3PrecedingTY" type="USAmountType" minOccurs="0">
      <xsd:annotation>
      <xsd:documentation>
        <Description>Divide Line 10b by 3</Description>
        <LineNumber>Part IV Line 10c</LineNumber>
      </xsd:documentation>
      </xsd:annotation>
    </xsd:element>
    - <!-- Multiply Line 10c by 125% -->
    <xsd:element name="AverageDistri3PreviousTY125Pct" type="USAmountType" minOccurs="0">
      <xsd:annotation>
      <xsd:documentation>
        <Description>Multiply Line 10c by 125%</Description>
        <LineNumber>Part IV Line 10d</LineNumber>
      </xsd:documentation>
      </xsd:annotation>
    </xsd:element>
    - <!-- Subtract Line 10d from Line 10a -->
    <xsd:element name="TotalExcessDistribution" type="USAmountType" minOccurs="0">
      <xsd:annotation>
      <xsd:documentation>
        <Description>Subtract Line 10d from Line 10a</Description>
```

```

<LineNumber>Part IV Line 10e</LineNumber>
  </xsd:documentation>
  </xsd:annotation>
</xsd:element>
- <!-- Enter Gain or Loss from the Disposition of Stock of a Section 1291 Fund or Former Section 1291 Fund -->
<xsd:element name="GainLossFromDispositionOfStock" type="USAmountType" minOccurs="0">
  <xsd:documentation>
  </xsd:documentation>
<Description>Enter gain or loss from the disposition of stock of a Section 1291 fund or former Section 1291 fund</Description>
<LineNumber>Part IV Line 10f</LineNumber>
  </xsd:documentation>
  </xsd:annotation>
</xsd:element>
- <!-- Enter the Total of the Amounts Determined in Line 11a that are Allocatable to the Current Tax Year and Tax Years Before the
  Foreign Corporation Became a PFIC -->
<xsd:element name="TotAllocatableCurrAndPrePFICTY" type="USAmountType" minOccurs="0">
  <xsd:documentation>
  </xsd:documentation>
<Description>Enter the total of the amounts determined in Line 11a that are allocatable to the current tax year and tax years
  before the foreign corporation became a PFIC</Description>
<LineNumber>Part IV Line 11b</LineNumber>
  </xsd:documentation>
  </xsd:annotation>
</xsd:element>
- <!-- Enter the Aggregate Increases in Tax (Before Credits) for Each Tax Year in Your Holding Period -->
<xsd:element name="AggregateIncreaseInTaxEachTY" type="USAmountType" minOccurs="0">
  <xsd:documentation>
  </xsd:documentation>
<Description>Enter the aggregate increases in tax (before credits) for each tax year in your holding period</Description>
<LineNumber>Part IV Line 11c</LineNumber>
  </xsd:documentation>
  </xsd:annotation>
</xsd:element>
- <!-- Foreign Tax Credit -->
<xsd:element name="ForeignTaxCredit" type="USAmountType" minOccurs="0">
  <xsd:documentation>
  </xsd:documentation>
<Description>Foreign tax credit</Description>
<LineNumber>Part IV Line 11d</LineNumber>
  </xsd:documentation>
  </xsd:annotation>
</xsd:element>
- <!-- Subtract Line 11d from Line 11c -->
<xsd:element name="AggregateIncrLessForeignTaxCr" type="USAmountType" minOccurs="0">
  <xsd:documentation>
  </xsd:documentation>
<Description>Subtract Line 11d from Line 11c</Description>
<LineNumber>Part IV Line 11e</LineNumber>
  </xsd:documentation>
  </xsd:annotation>
</xsd:element>
- <!-- Determine Interest on Each Net Increase in Tax Determined on Line 11e Using the Rates and Methods of Section 6621 -->
<xsd:element name="InterestOnEachNetIncreaseInTax" type="USAmountType" minOccurs="0">
  <xsd:documentation>
  </xsd:documentation>
<Description>Determine interest on each net increase in tax determined on Line 11e using the rates and methods of Section
  6621</Description>
<LineNumber>Part IV Line 11f</LineNumber>
  </xsd:documentation>
  </xsd:annotation>
</xsd:element>
</xsd:sequence>
</xsd:complexType>

```

2.1.5 Choice Construct

The choice construct within an XML schema batches a group of data elements between choice tags and only allows one of the data elements to be provided in an instance.

```
<xsd:choice minOccurs="0">
  <xsd:element name="USAddress" type="USAddressType"/>
  <xsd:element name="ForeignAddress" type="ForeignAddressType"/>
</xsd:choice>
```

The example above is an optional choice. In this choice, the address may be present or not, but if it is present, then either USAddress or ForeignAddress must be used.

```
H-H <xsd:choice>
  - <!-- Employer Identification Number -->
  H-H <xsd:element name="EmployerIdentificationNumber" type="EINType">
  H-H <xsd:annotation>
  H-H <xsd:documentation>
    <Description>Employer identification number</Description>
    </xsd:documentation>
    </xsd:annotation>
    </xsd:element>
  - <!-- Social Security Number -->
  H-H <xsd:element name="SocialSecurityNumber" type="SSNType">
  H-H <xsd:annotation>
  H-H <xsd:documentation>
    <Description>Social security number</Description>
    </xsd:documentation>
    </xsd:annotation>
    </xsd:element>
  </xsd:choice>
```

The above example illustrates a required "choice". In this XML instance, one of the elements (either SSN or EIN) must be present.

2.1.6 e-File Types

e-File types are IRS defined data types which can be used in more than one MeF schema and are stable and universal in nature. *e-File* types define the rule(s) for each of the data elements and may include length and character restrictions and the range of acceptable data. The data types are specified in and validated against the *efileTypes.xsd* document included in the MeF XML schema package. The IRS is committed to standardizing elements whenever possible.

The following examples illustrate MeF *e-File* types defined in the *efileTypes.xsd* XML document. For a complete list of *e-File* types go to irs.gov and visit the webpage that hosts the Current Valid XML Schemas for the appropriate return type (included in the Return Schema package).

- **Address:** MeF standardized addresses with the USAddressType *e-File* type and foreign addresses with ForeignAddressType. The USAddressType includes the following data elements (Note- If any data element **within the complex element is present**, then all of the required fields must be present.):
 - AddressLine1, which is a required field if the address field is present
 - AddressLine2, which is optional
 - City, which is a required field if the address field is present
 - State, which is a required field if the address field is present
 - ZIPCode, which is a required field if the address field is present

```
<xsd:complexType name="USAddressType">
  <xsd:sequence>
    <xsd:element name="AddressLine1" type="StreetAddressType">
      <xsd:annotation>
        <xsd:documentation>Address line 1</xsd:documentation>
      </xsd:annotation>
    </xsd:element>
    <xsd:element name="AddressLine2" type="StreetAddressType" minOccurs="0">
      <xsd:annotation>
        <xsd:documentation>Address line 2</xsd:documentation>
      </xsd:annotation>
    </xsd:element>
    <xsd:element name="City" type="CityType">
      <xsd:annotation>
        <xsd:documentation>City</xsd:documentation>
      </xsd:annotation>
    </xsd:element>
    <xsd:element name="State" type="StateType">
      <xsd:annotation>
        <xsd:documentation>State</xsd:documentation>
      </xsd:annotation>
    </xsd:element>
    <xsd:element name="ZIPCode" type="ZIPCodeType">
      <xsd:annotation>
        <xsd:documentation>ZIP code</xsd:documentation>
      </xsd:annotation>
    </xsd:element>
  </xsd:sequence>
</xsd:complexType>
```

- **Business Name Control.** Special characters in the Name Control must be encoded correctly. Refer to the Text Type section on page 23 for additional information. For more information on creating a business name control, refer to [Exhibit 1](#).

```
<xsd:simpleType name="BusinessNameControlType">
  <xsd:annotation>
    <xsd:documentation>Used for a Name Control. Legal Characters: A-Z, 0-9, hyphen and
      ampersand. Illegal Character: spaces and symbols.</xsd:documentation>
  </xsd:annotation>
  <xsd:restriction base="xsd:string">
    <xsd:pattern value="([A-Z0-9\-\&]){1,4}" />
  </xsd:restriction>
</xsd:simpleType>
```

- **Business Name.** MeF standardized the business name with the BusinessNameType. It includes the following data elements:
 - BusinessNameLine1, which is a required field if the business name is present
 - BusinessNameLine2, which is optional

```
<xsd:complexType name="BusinessNameType">
  <xsd:sequence>
    <xsd:element name="BusinessNameLine1" type="BusinessNameLine1Type">
      <xsd:annotation>
        <xsd:documentation>Business name line 1</xsd:documentation>
      </xsd:annotation>
    </xsd:element>
    <xsd:element name="BusinessNameLine2" type="BusinessNameLine2Type" minOccurs="0">
      <xsd:annotation>
        <xsd:documentation>Business name line 2</xsd:documentation>
      </xsd:annotation>
    </xsd:element>
  </xsd:sequence>
</xsd:complexType>
```

▪

- **IDType.** MeF standardized identifiers using the IDType data type. Below is just one type of identifier, others include TransmissionID, MessageID, etc. For more examples of MeF identifiers, refer to Exhibit 2.

```
:simpleType name="IdType">
  <xsd:annotation>
    <xsd:documentation>Pattern used for generating TransmissionId, OriginId, ItemId, and
      AcknowledgementId. A timestamp may be used as an ID as long as it is unique within its parent
      element and within the filing season. Up to 4-decimal fractional digits may be used for the second
      in a timestamp to increase its uniqueness. Legal Characters: A-Z, a-z, 0-9, colon, period and
      hyphen.</xsd:documentation>
  </xsd:annotation>
  <xsd:restriction base="xsd:string">
    <xsd:pattern value="[A-Za-z0-9:\.\-]{1,30}" />
  </xsd:restriction>
</xsd:simpleType>
```

- **Text Type.** When a field is defined as TextType, as a general rule, the allowable characters include printable characters, symbols and Spanish characters (shown below) and the single space used within a phrase. Leading spaces, (spaces before the beginning of the phrase), extra spaces (double or more) and trailing spaces (spaces after the end of the phrase) are never allowed. They will cause the schema validation for that field to fail. Additionally, some TextType fields are defined with restrictions and will only allow a subset of these Characters to be used (e.g. All Numeric, All Positive Numbers, etc.).

!, ", #, \$, %, &, ', (,), *, +, ,, -, ., /, 0, 1, 2, 3, 4, 5, 6, 7, 8, 9, :, ;, <, =, >, ?, @, A, B, C, D, E, F, G, H, I, J, K, L, M, N, O, P, Q, R, S, T, U, V, W, X, Y, Z, [, \,], ^, _ , ` , a, b, c, d, e, f, g, h, i, j, k, l, m, n, o, p, q, r, s, t, u, v, w, x, y, z, {, |, }, ~, ¡, ¢, £, ¤, ¥, ¦, §, ¨, ©, ª, «, ¬, ®, ¯, °, ±, ², ³, ´, µ, ¶, ·, ¸, ¹, º, » , ¼, ½, ¾, ¿, Á, É, Í, Ñ, Ó, ×, Ú, Ü, á, é, í, ñ, ó, ú, ü.

Note: Special characters are allowed but they must be encoded correctly by the software used. If the following special characters are used by the transmitter, the software will need to encode the XML special characters as such:

- < is encoded as < "<" becomes "<"
- > is encoded as > ">" becomes ">"
- & is encoded as & "&" becomes "&"
- " is encoded as " "" becomes '",' (if you are using quote("") to delimit the attribute value)
- a single space is encoded as
- ‘ is encoded as ' "" becomes "'" (if you are using apostrophe(') to delimit the attribute value)

2.1.7 Attachments to Corporate Returns, Partnership Returns, and Extensions

Taxpayers are instructed to attach supporting information to the tax return. This includes tax forms, statements, elections, notices, schedules or other types of miscellaneous information that IRS identifies in the form instructions, regulations or publications. These “attachments” may be submitted electronically as XML documents or binary files.

Forms and Attachments Listing for 1120/1120-F/1120S, provides a list of all supporting information required by form or form instructions. This list includes the XML document name and location reference to assist the software developer in programming this functionality. For updates to this list check <http://www.irs.gov/taxpros/providers/article/0,,id=97626,00.html> .

General Information

When the IRS defines a schema for information that is requested, the information must be provided in XML format. The schemas include:

- Tax forms (e.g., Form 6478, Form 5884, etc). Data elements have been defined for the schemas.
- Information requested on tax forms instructions to support specific lines (e.g., ItemizedOtherIncomeSchedule, DualConsolidatedLossesStatement, etc.). In some cases, the schema provides specific data elements and in other cases the schema allows for entry of free form text.
- Information requested by regulations or publications, which is not specified in form instructions and IRS has not provided a predefined schema must be submitted in XML format using the “GeneralDependency” schema. For all other information requested that does not have a specified schema, use the “GeneralDependency” schema. If the General Dependency is an Election, the name should start with the word “Election”. Examples include: “Election to Amortize a Bond Premium” or “Election for 100% Dividends Received Deduction”. Data elements include:
 - FormLineOrInstructionReference –the form and/or line number to which the attachment belongs. The description may be used when the IRS displays the name of the attachment, so it should be meaningful. Examples include: “Taxable Income Bracket Allocation” or “Statement of Corporate Reorganization”.
 - RegulationsReference – the regulation and/or publication reference.
 - Description – provide a meaningful title or explanation for the attachment.
 - AttachmentInformation – additional information regarding the attachment.

NOTE: If the data requested for either election or other information requires “columnar format”, these documents may be submitted in PDF format until the IRS provides a structure to support columnar format.

Binary Attachments

The tax return may also include non-XML documents, known as “binary attachments”, submitted in PDF format. (Note: Currently IRS only supports PDF format.) This allows taxpayers to provide requested documentation that may include required signatures and/or₂₄

third party documents (i.e. 8453 signature document, signed copy of lease, signed appraisal statement, etc.). The Form 7004 allows binary attachments except Form 8453.

To attach a PDF file, perform the following steps:

1. **Create the PDF file** using any available tool. In creating a PDF file for the submission, it is important to adhere to the following guidance:

- Keep binary attachments as small as possible. By exporting a document to create the PDF, it makes for a much smaller file than scanning one in. The IRS needs a readable PDF using any compatible software that creates a PDF file. If using Adobe Acrobat:
 - Avoid requiring compatibility with Adobe Acrobat versions earlier than version 7. Making the PDF file compatible with earlier versions will increase the size of the file.
 - Move the compression/quality slider on the “Create PDF From Scanner” to higher compression to lower the size of the file when the source document is of decent quality and from scanner input.
- Each individual uncompressed PDF cannot exceed 60 megabytes. All uncompressed PDFs in the submission cannot exceed 1 gigabyte.
- Each PDF must start with %pdf- and end with %%EOF. The return will reject if the PDF is not properly formatted.

You can download the most recent free version of Adobe PDF using the following link: <http://www.adobe.com/products/acrobat/readstep2.html> - *Please note* that by clicking on this link, you will leave the IRS web site and enter a privately owned web site created, operated and maintained by a private business. The information that this private business collects and maintains as a result of your visit to its web site may differ from the information that the IRS collects and maintains. (please see the IRS web site privacy and security notice for privacy protections IRS provides to web site visitors). By linking to this private business, the IRS is not endorsing its products, services, or privacy or security policies. We recommend you review the business's information collection policy or terms and conditions to fully understand what information is collected by this private business.

- The title of each PDF cannot exceed 64 characters and cannot include the following special characters:
 - Single quotation mark (')
 - Double quotation mark (")
 - Left angle bracket (<)
 - Right angle bracket (>)
 - Ampersand (&)
 - Exclamation mark (!)

2. **Create a “Binary Attachment XML document”** in the Submission data that describes the PDF file. One Binary Attachment XML document must be created for each binary attachment. There is one-to-one relationship between the PDF file and the Binary Attachment XML document that describes it. To create the Binary Attachment XML document, provide the PDF file with a name, including the extension, in the “AttachmentLocation” element and provide a brief description of (the contents of) the file in the “Description” element. The name of the PDF file must EXACTLY match the name provided in the “AttachmentLocation” element (case sensitive). The schema for the Binary Attachment document is defined in the file named “BinaryAttachment.xsd”.

Note: While it is possible that one PDF may be attached in more than one location, that condition is very rare. Do not simply attach a PDF to every location that allows a PDF. Attach a PDF only where it is needed as an attachment. There have been problems with the same binary files being attached at every location where a binary file can be attached. This causes virtual documents that can delay processing.

3. **Create references**, if any, from the element(s) to which the PDF file is “attached” to the “Binary Attachment XML document”.
 - If the PDF file is to be attached to an element for a line, form, or schedule, create a reference from the element to the Binary Attachment XML document.
 - If the PDF is to be attached to a “GeneralDependency” (i.e. Plans of Merger, Plans of Reorganization) create a reference from the element to the Binary Attachment XML document.

We recommend that PDF files be attached at the top level return unless there is a reason it needs to be attached at a form level or to the GeneralDependency schema. It is important to note that the reference is created from the element to the Binary Attachment XML document, not to the PDF file. If no reference is created to the Binary Attachment XML document, then the PDF file is considered to be “attached” to the Submission. Creating reference(s) to PDF files is needed only when the IRS specifies the conditions under which the reference must be created, and the reference locations within return data where the reference must exist.

4. **Include the number of binary attachments in the submission** in the binaryAttachmentCount attribute, which is used to indicate the number of binary attachments in the return, of element ReturnHeader.
5. **Include the PDF file in the attachment folder** in the submission zip.

A Sample non-XML document attached to the Submission

Below is an example of a binary attachment, 8453 Signature Document, with a file name “8453SignatureDoc.pdf”, that is “attached” to a submission. To attach the document to a submission:

- include the PDF file in the Submission Zip Archive
- create a Binary Attachment XML Document that describes it in the Submission data,
- do not reference the Binary Attachment XML Document within the Submission data.

It is important to note that the Description element of the Binary Attachment XML document contains the title of the file while the AttachmentLocation element contains the name of the file. The file itself is packaged along with other files in the attachment folder in the submission zip.

```
<Return>
...
<ReturnData>
...
<BinaryAttachment documentId="SignatureDoc8453" softwareId="00000000" softwareVersion="String">
  <DocumentType>PDF</DocumentType>
  <Description>8453 Signature Document</Description>
  <AttachmentLocation>8453SignatureDoc.pdf</AttachmentLocation>
</BinaryAttachment>
...
</ReturnData>
</Return>
```

A Sample non-XML document attached to a form

Below is an example of a file that is attached to multiple locations in the submission. The attachment titled “Historic Structures circa 1880” is named “HistoricStruct1880.pdf” and attached to Form 1120.

When a PDF file needs to be attached to a submission, the BinaryAttachmentdocumentID created in the Binary Attachment XML Document (BinaryAttachmentdocumentId=“**PDFAttachment01**”, that describes the physical file) is also referenced within the submission using the referenceDocumentId attribute (referenceDocumentId=“**PDFAttachment01**”). Only one instance of the physical PDF file is included in the Submission zip file.

```
<Return>
...
<ReturnData>
...
<IRS1120 documentId="DOC0001" referenceDocumentId="PDFAttachment01">
  ...
  ...
</IRS1120>
...
...
<BinaryAttachment documentId="PDFAttachment01" softwareId="00000000" softwareVersion="String">
  <DocumentType>PDF</DocumentType>
  <Description> Historic Structures circa 1880 </Description>
  <AttachmentLocation> HistoricStruct1880.pdf</AttachmentLocation>
</BinaryAttachment>
...
</ReturnData>
</Return>
```

← Reference to the Binary Attachment XML Document

← The PDF file itself is included in the Submission zip file along with other files that make up the Submission

When naming certain PDF attachments, tax preparation software must use the following names because they will be validated by business rules.

CONDITION	Description
If you attach a scanned 8453, the Description must be	8453 Signature Document
If you attach a scanned 8838, the Description must be	8838 Signature Document
If you attach a scanned 2553, the Description must be	Form 2553

For all other PDF attachments, the tax preparation software must provide the taxpayer the ability to enter a meaningful name. The following table provides a few examples of meaningful names that are limited to 64 characters.

CONDITION	Description
If the <i>TY 2006 Directions for Corporations required to e-file</i> allow you to submit Form 6198 as a PDF attachment to the XML portion of the electronic return	6198 At-Risk Limitations
If the regulations require you to attach a merger agreement	1120 Merger Agrmt for XYZ Corp
If the regulations require you to attach a warehouse leasing agreement	Leasing Agrmt for Warehouse A
If you are required to attach an appraiser statement for a Francisco de Goya oil painting	Goya Painting Appraiser Stmt
If you are required to attach an appraiser statement for a Pablo Picasso painting	Picasso Pntg A Appraiser Stmt
If you are required to attach an appraiser statement for a second Pablo Picasso painting	Picasso Pntg B Appraiser Stmt

Special instructions for “schedule” attachments to Form 8865:

In many instances information from various Form 1065 schedules (Schedule B, D, K, K-1, L, M-1, M-2) will be the same required to be filed with the Form 8865 schedules. Do NOT attach the Form 1065 schedules to the return, instead the data from the Form 1065 schedules should be formatted into the corresponding Form 8865 schedules.

Special instructions for Form 4466:

If applicable, Form 4466, Corporation Application for Quick Refund of Overpayment of Estimated Tax, should be filed on paper at the appropriate IRS Center listed on the form instructions. The form 4466 attached to the *e-filed* return is only a copy and will not be processed.

Special instructions for other forms and attachments that require signatures:

IRS Counsel issued special instructions to facilitate electronic filing. Regulation T.D. 9100 contains amendments to the Income Tax Regulations (26 CFR Part 1) and Procedure and Administration Regulations (26 CFR Part 301) eliminates some of the requirements considered impediments to the electronic submission of tax returns. T.D. 9100 eliminates the impediments for taxable years beginning after December 31, 2002. The regulations generally affect taxpayers who are required to file any of the following forms: 926, 972, 973, 982, 1120, 1120S, 1122, 5471, 8832. In addition, effective May 30, 2006, T.D. 9264 also eliminated signature impediments by stating that by signing the return, a taxpayer is attesting to the validity of the Form 1120 as well as all of the attachments. Generally the signature of Forms 1120/1120-S covers all forms, schedules and accompanying statements, with the exception of Form 8838 and Form 7004. Review TD9100 and 9264 for specifics.

Form 8838 data must be sent to the IRS using the XML Schema and a signed copy submitted as a binary attachment with the Description “8838 signature document”.

There is no signature requirement on the Form 7004, unless there is a payment made with the Form 7004. The Practitioner PIN method is required if a payment is attached to the Form 7004. Practitioner PIN is the only option viable for signing extensions.

Although 7004 MeF gives the capability for binary attachments, please be aware that those attachments will not be processed (they are for information purposes only). Therefore, POA, Form 1128, Form 1138 and other documents requiring action by IRS should not be sent with the Form 7004.

2.1.8 Exempt Organization Return Attachments

For Exempt Organization returns, filers occasionally must attach an IRS form, schedule or other piece of information. For Forms 990, 990-EZ, 990-PF, 1120-POL, 8868, these “attachments” will normally be submitted electronically as XML documents. Usually, the only binary file is Form 8453-EO except for Final Returns where third party documents are allowed to be attached as binary attachments. Other binary files may be submitted as attachments if permitted as part of a form or schedule shared with Forms 1120/1120-F/1120S. A Form 8453-EO is the only attachment permitted with Form 8868.

General Explanation Attachment

Forms 990, 990-EZ, 990-PF and 1120-POL each permit attaching an XML schema that allows for optional information to be provided that is not otherwise covered in another permitted schema. The General Explanation Attachment schema has three fields, i.e., “Identifier,” “Return Reference” and “Explanation.” These fields may be repeated up to ten times. One General Explanation Attachment may be optionally attached to each return. The “Identifier” field is a single line description of the information being provided. The “Return Reference” field is a single line description of the return item, if any, to which the information relates. The “Explanation” field is a brief free-form text section where the additional information the filer wishes to convey is contained. The General Explanation Attachment is used exclusively with Exempt Organization returns. It is intended to be used to provide supplementary information, and may not be used in lieu of an existing schema. (Note: The General Dependency schema available with Forms 1120/1120-F/1120S may not be substituted for the General Explanation Attachment schema.)

Binary Attachments

When submitting a binary attachment of Form 8453-EO, the name “8453 Signature Document” must be included in the submission Zip Archive. For specific information, please refer to the *MeF Submission Composition Guide* found at <http://www.irs.gov/charities/article/0,,id=105955,00.html>. All attachments (except for the signature document, Form 8453-EO) to Forms 990, 990-EZ, 990-PF, 1120-POL, and 8868 must use the prescribed XML schema. In most cases, the only allowable binary attachment for Forms 990, 990-EZ, 990-PF and 1120-POL is the signature document, Form 8453-EO, Exempt Organization Declaration and Signature for Electronic Filing. Other binary documents will be permitted to these forms if they are necessary as part of submitting a shared Form 1120/1120-F/1120S form or schedule. Refer to Section 2.1.7 above, for specific guidance concerning the name, description, and AttachmentLocation of binary attachments. Since a signature is required for electronic payments submitted with Form 8868, Form 8453-EO is the only binary attachment permitted with the extension.

2.2 XML Character Representation

When entering character data into an XML document, it is important to ensure that the specified encoding supports the characters provided. By design, Modernized *e-File* uses Unicode Transformation Format-8 (UTF-8).

2.3 MeF Transmission and Submission File Structures for IFA and Application-to-Application (A2A)

This section describes the transmission and submission file structures for the IFA and Application-to-Application channels. Both channels use SOAP (Simple Object Access Protocol) with attachments.

For more specific information on creating a transmission file for IFA refer to the *MeF Submission Composition Guide* posted to <http://www.irs.gov/taxpros/providers/article/0,,id=97626,00.html>. For specific information on creating Application-to-Application Messages, refer to the *ISS MeF State and Trading Partners ICD* posted along with the *MeF Submission Composition Guide*.

2.3.1 MeF Transmission and Submission File Structures for IFA

This section describes the transmission and submission file structures for the IFA channel.

2.3.1.1 MeF Transmission File Structure for IFA

Note: In constructing the transmission file the number of submissions in the file is limited to 100.

The transmission file for the IFA channel is a MIME (Multipurpose Internet Mail Extensions) multipart document that contains two parts and conforms to “SOAP 1.1 with attachments” standard. The first part of the multi-part document is the SOAP envelope and the second part is a SOAP attachment. The SOAP envelope contains transmission-level information, and the SOAP attachment contains submissions. MIME boundaries separate the parts in the multi-part document.

The SOAP envelope consists of a SOAP header and a SOAP body. The SOAP header, also referred to as the *transmission header* in the MeF system, contains information about the transmitter and the transmission. The SOAP body, also referred to as the *transmission manifest*, contains a list of all submissions in the transmission file. Please refer to Figure 2-1 below.

The SOAP attachment in the transmission file is a ZIP file. This ZIP file, also referred to as Attachment ZIP file, is not compressed; it is simply ZIP archived (i.e., compression is turned off when this file is created). This Attachment ZIP file contains one or more submissions that are themselves ZIP Archive files. These ZIP files, also referred to as Submission ZIP files, are compressed.

MeF incoming submission data is encapsulated in SOAP 1.1 with a single attachment. This single attachment will be uncompressed zip container files. The single uncompressed zip container file may contain any number up to 100 compressed zip submission files, which is one level of nesting. No more than one level of nesting is allowed. Each compressed zip submission file consists of one submission (return) and may not contain another zip file. The files in the zip archive can only be compressed to a maximum of 250 times. Any zip archive file compressed more than 250 times the original file will trigger anti-virus engine and the transmission will be rejected as a potential virus.

Each submission zip file may contain ONE of the following: a federal return (with or without PDF attachments), a state return (with or without PDF attachments), or a request for extension (with or without PDF attachments). The SOAP header is never zipped.

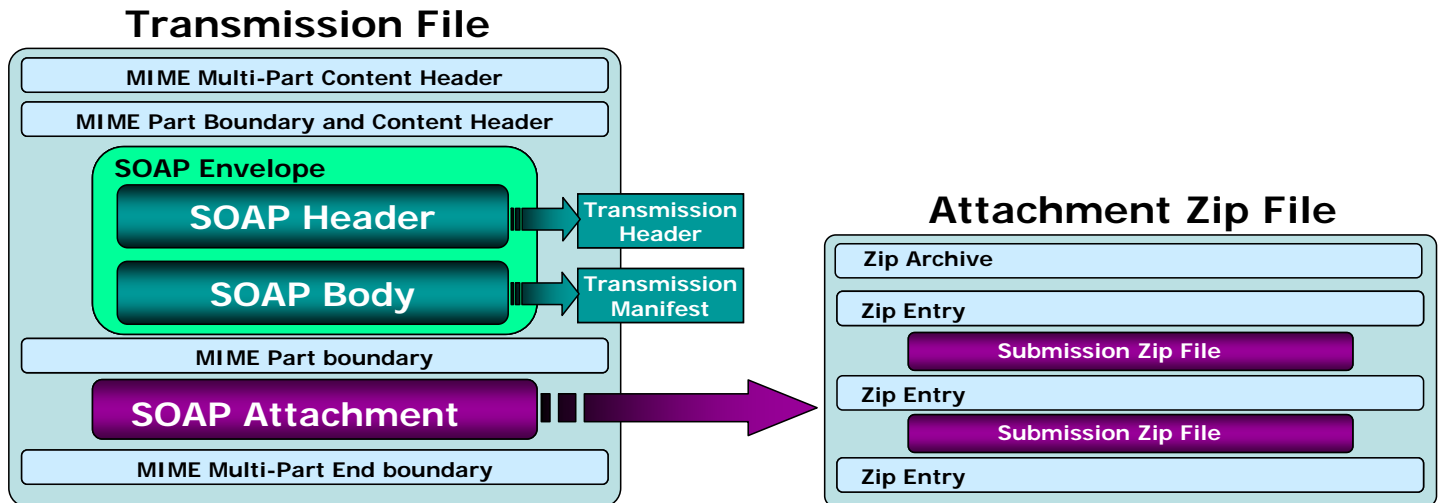

Figure 2-1: MeF Transmission File structure for the IFA Channel

2.3.1.2 Submission File Structure for the IFA Channel

The IFA and A2A channels support transmission of both federal and state returns. An IRS submission consists of XML data and optional binary attachments (PDF Files), which are packaged and compressed into a zip file. The Zip file is also referred to as the Zip Archive; each entry in the file is referred to as the Zip Entry. Each IRS Submission ZIP file contains the following folders (directories), which are then packaged and compressed into a Zip file:

- **/manifest.** The *manifest* folder (directory) contains a *manifest.xml* file, which contains information about the Submission, for example, the ERO who composed the Submission and the tax year for which the IRS Submission is being filed. The manifest directory must be present along with the files that contain data for this directory. The */manifest/manifest.xml* is required in the submission. Please refer to the *ISS MeF State and Trading Partners ICD* for the structure of a State Submission and contents of the *manifest.xml* file.
- **/xml.** The *xml* directory contains the *submission.xml* file with the submission data in XML format. The *xml* directory must be present along with the files that contain data for this directory. The */xml/submission.xml* is required in the submission.
- **/attachment.** The *attachment* directory contains binary attachment files. This directory is required only if there are binary attachments in the Submission. The attachment folder is an optional folder in a submission zip file.

It is important to note that the leading slash, “/” is optional. The submission will be accepted with or without the leading slash.

The structure of an IRS submission file for the IFA channel is depicted below.

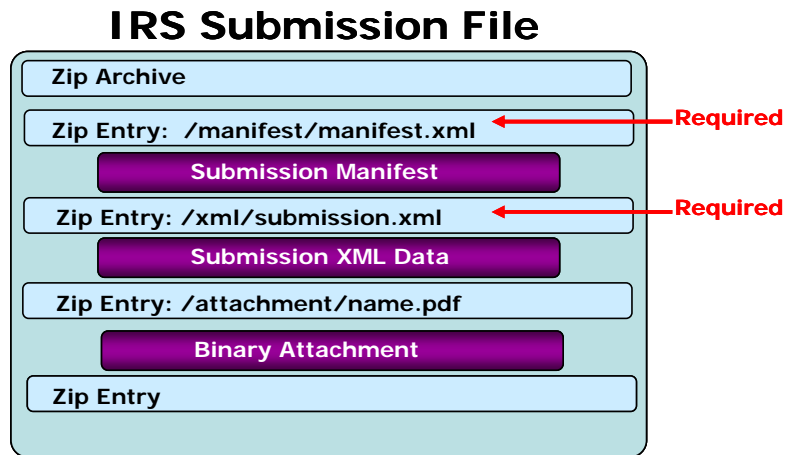

Figure 2-2: IRS Submission File structure for the IFA Channel

For detailed information regarding the IRS submission file structure, refer to the *MeF Submission Composition Guide*.

2.3.1.3 Creating an MeF Attachment

The steps below document how to create a SubmissionZip Archive. The *MeF Submission Composition Guide for the Modernized e-File System*, Section 4.1, describes the logical structure of attachments. The guide is posted to www.irs.gov/taxpros/providers/article/0,,id=97626,00.html located just below the Publication 4164 link. This example uses the WinZip tool to generate an attachment containing one or more submissions.

Create Individual SubmissionZip Archive(s)

1. Choose a local drive such as C:\ and create three folders: the first one should be named “manifest”, the second named “xml”, and the third named “attachment”.
2. Generate the submission manifest and name it “manifest.xml”. This should be copied to the C:\manifest\ directory. **There must be a single manifest for each submission.**
3. Generate the submission XML and copy it to the C:\xml\ directory. **There must be only one XML file here.**
4. Copy any PDF submission attachments into the C:\attachment\ directory
5. Open the WinZip tool, and select “New”
6. Browse to the **root of the local drive** i.e. C:\ and type in the name of the submission archive. NOTE: **The name of the submission archive must match the SubmissionID.** If the SubmissionID in the manifest generated in Step 2 is 00123420070351234567, then the file name used for the archive here should be 00123420070351234567.zip
7. Now add files to the archive using the WinZip Add dialog. First, browse to C:\manifest\ and select the manifest.xml file. NOTE: **The “Save full path info” option must be selected.**
8. Next, browse to C:\xml\ and select the submission xml file. Again ensure that the full path info is saved.
9. Lastly, browse to C:\attachment\ and select all the PDF attachments. Again ensure that the full path info is saved.
10. Close WinZip and verify that the submission archive i.e. 00123420070351234567.zip has been saved to the root of the C:\ drive and contains the files just added.
11. Delete the files in C:\manifest\, C:\xml\, and C:\attachment\
12. Repeat Steps 2 – 11 for the all the submissions to be sent to MeF.

Generate the MeF Attachment

The individual submission zip archives generated in the previous section must now be compiled into a single MeF attachment for the send submissions message. Again, the WinZip tool will be used to do this.

1. Open WinZip and select “New”
2. Browse to a location on the local drive to save the MeF attachment, then type in a file name for the MeF attachment
3. Now add files to the archive using the WinZip Add dialog. Browse to the root of the local drive i.e. C:\ and select all the individual submission archives that were generated in the previous section. Choose Compression option “None”, and then click on “Add”.
4. Close WinZip and attach the ZIP file generated here to the MeF SendSubmissions message.

NOTE: The submission IDs in the Send Submissions SOAP message must match the submission IDs in the file names for the individual submission archives. And as indicated earlier, each submission archive name must match the submission ID in its manifest file. Refer to the diagrams below for an example:

Please refer to sample MeF attachment included which contains three submissions – SendSubmissions.P20071214111809.0500.00027.zip *

SOAP Request Message contains:

```
<SendSubmissionsRequest
xmlns="http://www.irs.gov/a2a/mef/MeFTransmitterService.xsd">
<SubmissionDataList>
  <Count>3</Count>
  <SubmissionData>
    <SubmissionId>00007520083470015684</SubmissionId>
    <ElectronicPostmark>2007-12-04T09:42:09-05:00</ElectronicPostmark>
  </SubmissionData>
  <SubmissionData>
    <SubmissionId>00007520083470015685</SubmissionId>
    <ElectronicPostmark>2007-12-04T09:42:09-05:00</ElectronicPostmark>
  </SubmissionData>
  <SubmissionData>
    <SubmissionId>00007520083470015686</SubmissionId>
    <ElectronicPostmark>2007-12-04T10:11:09-05:00</ElectronicPostmark>
  </SubmissionData>
</SubmissionDataList>
</SendSubmissionsRequest>
```

MeF Attachment:

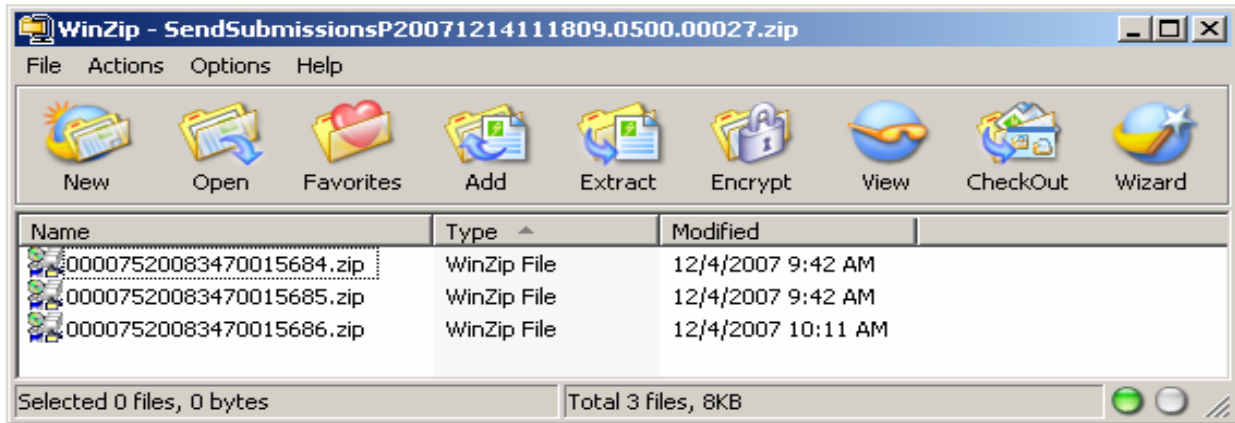

Third submission archive entry - 00007520083470015686.zip

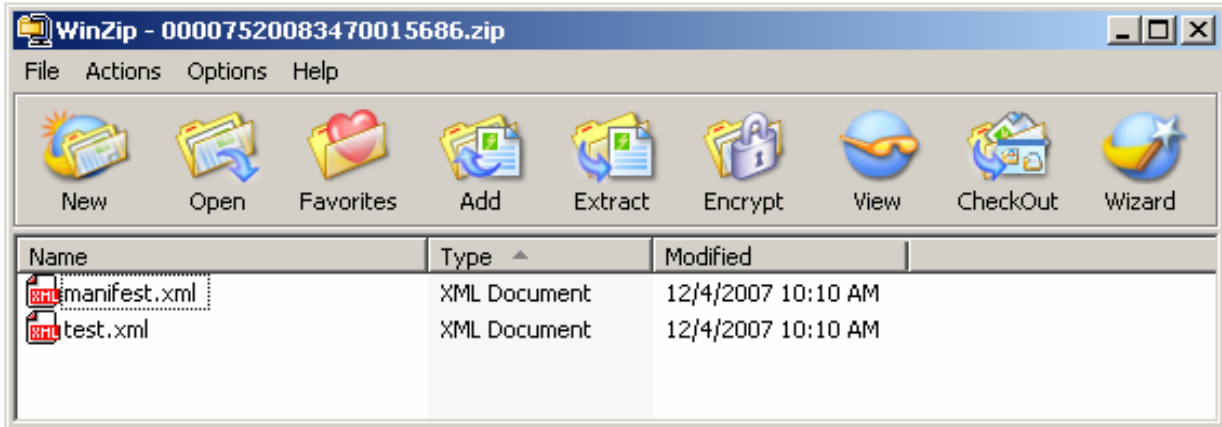

Manifest.xml for third submission archive - 00007520083470015686.zip

```
<IRSSubmissionManifest xmlns="http://www.irs.gov/efile"
  xmlns:efile="http://www.irs.gov/efile">
  <SubmissionId>00007520083470015686</SubmissionId>
  <EFIN>000075</EFIN>
  <GovernmentCode>IRS</GovernmentCode>
  <SubmissionType>1120</SubmissionType>
  <EIN>000000000</EIN>
  <TaxPeriodBeginDate>2007-01-01</TaxPeriodBeginDate>
  <TaxPeriodEndDate>2007-12-31</TaxPeriodEndDate>
  <TaxYear>2007</TaxYear>
  </IRSSubmissionManifest>
```

2.3.2 MeF Transmission and Submission File Structures for Application-to-Application (A2A)

This section describes the transmission and submission file structures for the Application-to-Application channel. A2A uses SOAP messages to communicate with external systems.

2.3.2.1 MeF Transmission File Structure for Application-to-Application

A2A uses SOAP with HTTP binding for the transmission file, which are SOAP messages that are transported using HTTPS. All service requests are Soap Messages. A service request (message) or its response may or may not have an attachment. For detailed information about SOAP messages, refer to the *ISS MeF State and Trading Partners ICD*:

- (1) **Soap Message without Attachments.** This Web Service SOAP message contains the following:
 - HTTP Headers
 - A SOAP Envelope that contains the following:
 - a SOAP header that includes the following elements:
 - An MeF header that contains message and transmitter identifying information. This header must be included in each message.
 - A WS Security Header that contains security related information. This header must be included in each message.
 - a SOAP body that includes the message elements.

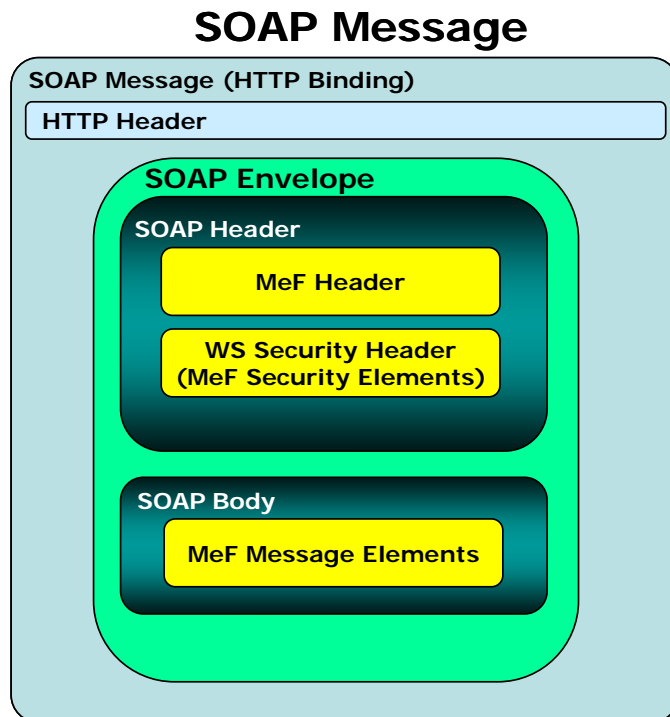

Figure 2–3: Basic SOAP Message Structure for HTTP Binding

(2) Messages with Attachments.

The SendSubmission service request is used to transmit submissions. It can have one and only one attachment. This attachment must be an uncompressed zip file called the container zip file. The container zip file can contain from 1 to 100 compressed zip files. Each compressed zip file contains one federal or state submission.

The responses to the GetNewSubmission series of service requests have the same attachment structure. Each submission is in its own compressed zip file and these zip files are attached to the response in one uncompressed container zip file.

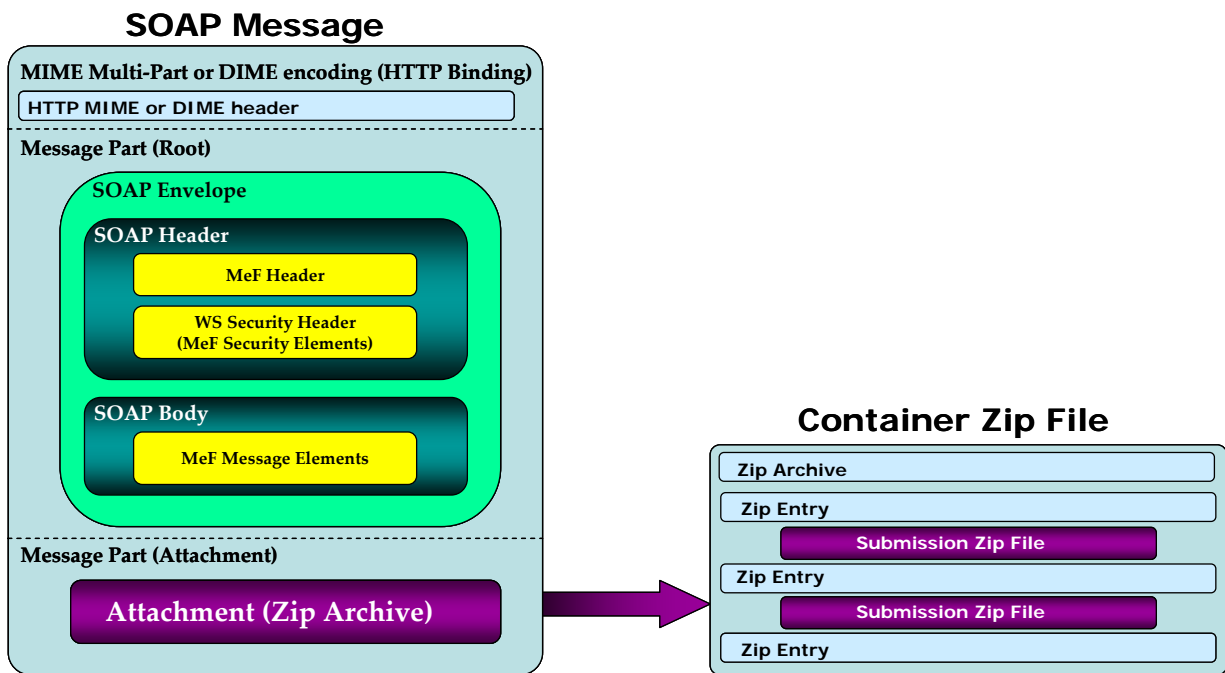

Figure 2-4: MeF Transmission File structure for the A2A Channel

2.3.2.2 MeF Submission File Structure for Application-to-Application

Transmitters can transmit federal and state submissions using Web Services. A state submission contains XML data and optional binary attachments. The state return may also contain a copy of part or all of the taxpayer's federal return. The state determines what part of the federal return the taxpayer should include in the state submission. Like a federal submission, the state submission must be zipped into its own file and then placed into the container zip file. The container zip file is then attached to the SendSubmissions service request. Federal and state submissions can be included in the same attachment (container zip file) each in their own zip file.

Each submission contains the following folders (directories), which are then packaged and compressed into a zip file:

- **/manifest.** The *manifest* folder (directory) contains a *manifest.xml* file, which contains information about the Submission, for example, the ERO who composed the Submission and the tax year for which the IRS Submission is being filed. The manifest directory must be present along with the files that contain data for this directory. The */manifest/manifest.xml* is required in the submission. Please refer to the *ISS MeF State and Trading Partners ICD* for the structure of a State Submission and contents of the *manifest.xml* file.
- **/xml.** The *xml* directory contains the *submission.xml* file with the submission data in XML format. The *xml* directory must be present along with the files that contain data for this directory. The */xml/submission.xml* is required in the submission.
- **/attachment.** The *attachment* directory contains binary attachment files. This directory is required only if there are binary attachments in the Submission. The attachment folder is an optional folder in a submission zip file

It is important to note that the leading slash, “/” is optional. The submission will be accepted with or without the leading slash.

Refer to Section 2.3.1.3 Creating an MeF Attachment, for additional guidance. For more information on the transmission and submission file structure, refer to the *MeF State and Trading Partners ICD* and the *MeF Submission Composition Guide*.

2.4 Version Control for MeF Schemas and Business Rules

IRS created a set of XML schemas for different types of tax returns (Forms 1120, 1120-F, 1120S, 1120-POL, 1065, 1065-B, 990, 990-EZ, 990-N, 990-PF, 720, 2290, 8849), extensions (Forms 7004, 8868), transmission file, and acknowledgement file. Each schema version also has a respective set of business rules that are used during MeF validation. Each year, new tax legislation and/or improvements to IRS programs impact the IRS forms and processing procedures. The IRS evaluates these changes to determine if updates to the XML schemas and business rules are necessary. Once the changes have been incorporated, the IRS uses the following timeline to publish the XML schemas and business rules changes:

- **Late July/Early August** – The IRS issues the initial version of the tax year XML schemas and business rules to enable software developers to begin development of the new tax year tax preparation software.
- **Late September/Early October** – The IRS issues updated versions of tax year XML schemas and business rules. This version is used for ATS testing.
- **Late November** – The IRS issues updated versions of tax year XML schemas and business rules. This version is used for live production.

Note: If there are critical changes required due to legislative changes, national disasters, or errors identified during testing or production, the IRS may issue updated XML schemas and business rules during the year and after December.

Each version of the XML schemas and their corresponding business rules has a unique version number. It is important to note the following principles regarding version numbers:

- The tax return's schema version number and its associated business rule number must be the same. This ensures that a set of business rules enforce the appropriate schema version.
- Each tax return's "returnVersion" attribute of the "Return" element (the root element) identifies the version of the schema (e.g. Return1120.xsd).
- Each business rule document's version number identifies the version of the business rule.
- The version number on the set of business rules dictates the schemas for which the business rules are enforced and the version number on the schemas dictates which business rules should be invoked for that schema version.
- The "Active Validating Schema Version" specifies the business rules and schema version that will be used to validate a tax return that has been received by the IRS during a timeframe. This provides a mechanism for different versions to be accepted at the same time. It also enables an older version to be validated against a newer version's set of schemas and business rules. The IRS will publish all valid schema/business rule versions and will note the versions that will be used to validate against.

2.4.1 Version Numbering Scheme

The version number includes the tax year for which the schema and business rule document applies (YYYY), the lower-case version initial (v), and the two-digit version number (N.N). When the version number reaches 10 or more in a given processing year, the number will include two-digits to the right and to the left of the decimal as needed (NN.NN). The version number of MeF business rules that are invoked for the MeF XML schemas will always have the same version number as the schema version, thereby, providing a mechanism that aligns the various versions of schemas with their applicable business rules. An example of the structure used for version numbers is provided below:

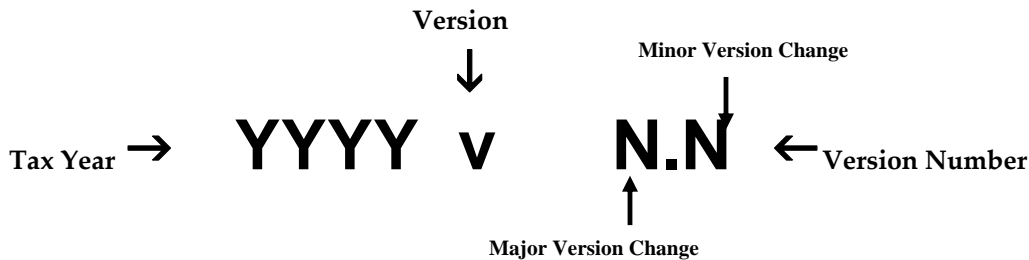

Figure 2-5: MeF Version Number Diagram

The above diagram is for yearly returns. Version numbers for quarterly returns will include “Q” and the quarter number after the tax year. For example: a 3rd quarter return for Form 720 TY 2007 will be shown as 2007**Q3**v2.0.

The examples below illustrate how the version number changes every tax year. New versions are generated when changes are necessary to the tax return’s XML schema structure, content, and business rules. Each change increases the version number when the new version is published. Major changes increase the left digit and minor changes increase the right digit.

Note: If only minor changes occur, software developers are not required to use the new version. If the major number changes, all software must reflect the new version.

Examples

- A new tax year. The tax year part of the version number will change with each subsequent tax year and the version number is usually reset to 1.0. This is a major version change.
- Additions, deletions, and/or changes to a schema’s data elements. This includes any schema modification to a form and/or attachment. Even if the tax return’s business rules were not affected by the additions, deletions, and changes to the tax return’s schemas, the business rule’s version number will be changed to maintain the alignment between the schemas and the applicable business rules.
- Form family: If the 1120 version number changes, then the 1120-F and 1120S version number will also change unless otherwise noted on irs.gov.
- Additions, deletions and/or changes to the business rules. Even if the business rule change(s) did not affect the tax return’s schema, the tax return’s schema version will be changed to maintain the alignment between the tax return’s schema and the applicable business rules.

2.4.2 Validating Schema Versions

Throughout the year, multiple versions of XML schemas and business rules are posted to irs.gov along with a Release memo that will indicate which schema version will be considered the “active validating schema version” used to validate all returns within that Tax Year. Depending on if the schema change is major or minor; MeF may not require the schema version found in the return data to match the schema version used by MeF during validation. In general, there is always one “active validating schema version” for each return type in a tax year.

- **Minor Schema Changes** - When IRS issues revised schemas for a return type and changes the increment for the minor number, MeF will continue to accept returns composed using previous schema versions. When the minor number is changed, IRS allows software developers to decide for themselves whether they need to use the new version or not based on what is included in their tax preparation software and what changes were made to the schemas. For example, if the change affects a form or field you do not support, then you may elect not to use the newest version. Returns may be composed using previous published schema versions but IRS will only validate against the “active validating schema version” when the return is processed. For example, if the current schema version is 2007v1.0 and the schema change is minor, IRS will assign the new number 2007v1.1. MeF will continue to accept returns composed using version 2007v1.0. However, all returns (whether composed with version 2007v1.0 or 2007v1.1) will be validated with the new version, 2007v1.1.
- **Major Schema Change** - When IRS issues revised schemas for a return type and changes the increment for the major number, all returns must be composed using the new version number. If returns are composed using previously published schema versions, they will not validate against the “active validating schema version” when the return is processed.

For example, if the current version is 2007v1.1 and the IRS decides it can no longer accept returns composed using schema version 2007v1.1 (or 2007v1.0), it will assign the new number 2007v2.0. The Release memo will tell software developers and transmitters they must compose all returns using schema version 2007v2.0. Returns submitted with 2007v1.1 (or 2007v1.0) will be rejected for using an unsupported schema version

Software developers and transmitters should use the following websites for information about all active and prior year schemas and business rules used by the MeF Production and Assurance Testing Systems (ATS).

- For 1120/1120-F/1120S/7004: <http://www.irs.gov/efile/article/0,,id=128360,00.html>
- For 1065/1065-B: <http://www.irs.gov/efile/article/0,,id=153999,00.html>
- For Exempt Organizations: <http://www.irs.gov/charities/article/0,,id=129364,00.html>
- For 720/2290/8849: <http://www.irs.gov/efile/article/0,,id=170570,00.html>

The examples of the Current Valid Schemas for the Assurance Testing System (ATS) environment (Figure 2-6) and the Production System environment (Figure 2-7), help illustrate how Tax Year schemas are issued:

- Initial Version – On 07/28/06 IRS issued the initial version of TY 2006 1120/1120S XML schemas and business rules using Return Schema Version 2006v1.0. The initial version of these artifacts were placed in the “Assurance Testing System (ATS) – Current Valid Schemas” table.
- Optional Updated Version – On 9/15/2006 IRS issued an updated version due to significant changes that affected both the 1120/1120S XML schemas and business rules (Return Schema Version Number 2006v1.1). Since testing had not begun, this version of the artifacts was placed under “Assurance Testing System (ATS) – Current Valid Schemas”. This version was issued to allow software developers the maximum time to develop their internal programs.
- ATS Version - On 10/17/06, IRS issued an updated version, 2006v1.2, of the 1120/1120S schemas and business rules which included the final changes for live ATS testing. This version was placed under “Assurance Testing System (ATS) – Current Valid Schemas”. The associated Release Memo instructed software developers to use this version for IRS ATS testing. When the MeF Assurance Testing System receives a tax return for TY 2006 with return version “2006v1.1” or “2006v1.0”, it will validate the return against the only ‘active validating schema version’ “2006v1.2”. If the return passes validation against the schemas and business rules for version “2006v1.2”, it will be accepted.
- Live Production Version - On 12/05/06, IRS issued the initial 2006v3.0 production version of the schemas and business rules that included changes identified by software developer testing, IRS testing, and/or legislative changes. This version was placed on the “Production System – Current Valid Schemas”. On 02/18/06, a minor version was posted (2006v3.1) that impacted the 1120/1120S. On 1/11/07, a minor version was posted (2006v3.2) that only impacted the 1120/1120S. On 2/02/07, a minor version was posted (2006v3.3) that impacted the 1120/1120S. As each minor version was posted, the validating set of schemas and business rules for all active versions was always the latest posted version.

After Live Production - IRS strives to limit the number of schema and/or business rule revisions. Any necessary changes will be coordinated closely with all software developers and transmitters.

Assurance Testing System (ATS) - Current Valid Schemas

<i>Package</i>	Release Memo Dated	Form Type	Return Schema Version	Business Rule Version (PDF & CSV)	Start Date	End Date
1120 Family Tax Year 2006	10/17/06	1120	2006v1.2	2006v1.2.PDF 2006v1.2.CSV	11/06/06	
	10/17/06	1120S	2006v1.2	2006v1.2.PDF 2006v1.2.CSV	11/06/06	
	9/15/06	1120	2006v1.1	2006v1.1.PDF 2006v1.1.CSV	11/06/06	
	9/15/06	1120S	2006v1.1	2006v1.1.PDF 2006v1.1.CSV	11/06/06	
	7/28/06	1120	2006v1.0	2006v1.0.PDF 2006v1.0.CSV	11/06/06	
	7/28/06	1120S	2006v1.0	2006v1.0.PDF 2006v1.0.CSV	11/06/06	

Figure 2-6: Example of Current Valid MeF Schemas/Business Rule Versions – ATS

Production System - Current Valid Schemas

Package	Release Memo Dated	Form Type	Return Schema Version	Business Rule Version (PDF & CSV)	Start Date	End Date
1120 Family Tax Year 2006	2/2/07	1120	2006v3.3	2006v3.3.PDF 2006v3.3.CSV	2/25/06	
	2/2/07	1120S	2006v3.3	2006v3.3.PDF 2006v3.3.CSV	2/25/07	
	1/11/07	1120	2006v3.2	2006v3.2.PDF 2006v3.2.CSV	2/14/07	
	1/11/07	1120S	2006v3.2	2006v3.2.PDF 2006v3.2.CSV	2/14/07	
	02/18/06	1120	2006v3.1	2006v3.1.PDF 2006v3.1.CSV	1/8/07	
	02/18/06	1120S	2006v3.1	2006v3.1.PDF 2006v3.1.CSV	1/8/07	
	12/05/06	1120	2006v3.0	2006v3.0.PDF 2006v3.0.CSV	1/8/07	
	12/05/06	1120S	2006v3.0	2006v3.0.PDF 2006v3.0.CSV	1/8/07	

Figure 2-7: Example of Current Valid MeF Schemas/Business Rule Versions – Production System

2.5 MeF XML Schema File Structures

This section describes the MeF XML Schema file structure and how the schemas will be packaged as of the date this publication was issued. Each program has its own file structure and will be packaged separately. You should check for periodic updates at the websites shown in the [MeF Contact Information Table \(Section 1.2\)](#).

Schemas for a given return family are packaged into one package; likewise, schemas for each extension are packaged into separate packages. Each package is identified by the package number.

This means there are ten **separate schema** packages in TY2007:

- one package for Forms 1120, 1120-F, and 1120S
- one package for Forms 990, 990-EZ, and 990-PF
- one package for Form 990-N
- one package for Form 1120-POL
- one package for Form 7004
- one package for Form 8868
- one package for Forms 1065 and 1065-B
- one package for Form 720
- one package for Form 2290
- one package for Form 8849

There is a business rules file that accompanies each schema package. So in TY 2006, there are six business rules files, one for each of the packages.

2.5.1 1120/1120-F/1120S XML Schema File Structure (explanation on the next page)

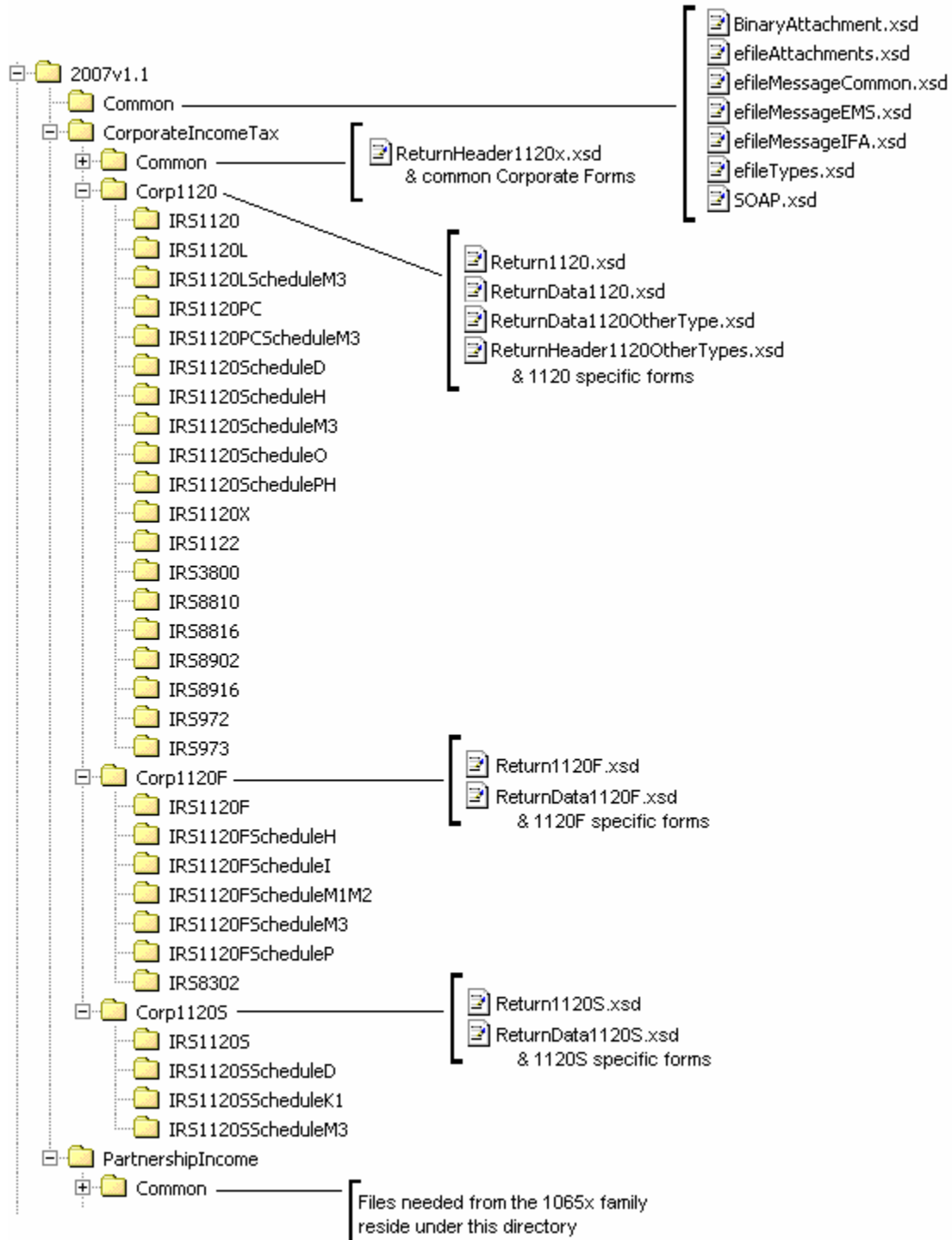

Figure 2-8: 1120/1120-F/1120S Package

The following describes the MeF Schema File Structure for Form 1120/1120-F/1120S (Figure 2-8 on the previous page):

2007v1.1 is the top-level directory of the schemas for the Tax Year 2007, version “1.1”. It contains the following folders:

- **Common**, which contains the XML schemas that are common to all MeF return and extension types. It contains the following:
 - **BinaryAttachment.xsd**, which defines the binary attachment document XML structure
 - **efileAttachments.xsd**, which defines the attachment document XML structure
 - **efileMessageCommon.xsd**, which defines the transmission header, transmission manifest, and acknowledgement XML structures for the basic message.
 - **efileMessageIFA.xsd**, which defines the transmission header, transmission manifest, and acknowledgement XML structures for the IFA channel.
 - **efileTypes.xsd**, which defines the global data types for MeF schemas.
 - **SOAP.xsd**, which defines the XML structure of the SOAP envelope, SOAP header and the SOAP.

- **CorporateIncomeTax**, which is a directory for corporate income related (1120/1120-F/1120S) schemas. It contains the following folders:
 - **Common**, which is a top-level directory for schemas for all attachments and forms shared among forms 1120, 1120-F and 1120S return types. It contains the following:
 - **ReturnHeader1120x.xsd**, which defines the structure and global data elements for the 1120, 1120-F, and 1120S tax returns.
 - **Dependencies**, which contain schemas for the supporting XML documents/attachments common to 1120, 1120-F, and 1120S return types.
 - **Various Shared Form directories**, which each contain the schemas for the shared forms and supporting XML documents/attachment between 1120, 1120-F, and 1120S return types.
 - **Corp1120**, which contains schemas specific to the 1120 return type. It contains the following:
 - **Return1120.xsd**, which defines the XML structure for the tax return and wraps around the ReturnHeader1120x, ReturnData1120, ReturnData1120OtherType, and ReturnHeader1120OtherTypes XML documents in a transmission file.
 - **ReturnData1120.xsd**, which defines the content model for an 1120 or an 1120 consolidated tax return. This includes defining all XML forms and schedules in the tax return.
 - **ReturnData1120OtherType.xsd**, which defines the content model for an 1120 parent; 1120, 1120L, and 1120PC subsidiary; 1120, 1120L, and 1120PC subconsolidated; 1120, 1120L, and 1120PC eliminations; and 1120, 1120L, and 1120PC adjustments tax returns. This includes defining all XML forms and schedules in the tax return.
 - **ReturnHeader1120OtherTypes.xsd**, which defines the content of the ReturnHeader element for the 1120 parent; 1120, 1120L, and 1120PC subsidiary; 1120, 1120L, and 1120PC subconsolidated; 1120, 1120L, and 1120PC eliminations; and 1120, 1120L, and 1120PC adjustments tax returns.

- **List of all form folders not shared with the 1120-F and 1120S**, which contain the schemas for the forms and supporting XML documents/attachment that are specific for the 1120 return type.
- **Corp1120-F**, which contains schemas specific to the 1120-F return type. It contains the following folders:
 - **Return1120F.xsd**, which defines the XML structure for the 1120-F tax return and wraps around the ReturnHeader1120x and ReturnData1120-F XML documents in a transmission file.
 - **ReturnData1120F.xsd**, which defines the content model for an 1120-F tax return. This includes defining all XML forms and schedules in the tax return.
 - **List of all form folders not shared with the 1120 and 1120-S**, which contain the schemas for the forms and supporting XML documents/attachment that are specific for the 1120-F return type.
- **Corp1120S**, which contains schemas specific to the 1120S return type. It contains the following folders:
 - **Return1120S.xsd**, which defines the XML structure for the 1120S tax return and wraps around the ReturnHeader1120x and ReturnData1120S XML documents in a transmission file.
 - **ReturnData1120S.xsd**, which defines the content model for an 1120S tax return. This includes defining all XML forms and schedules in the tax return.
 - **List of all form folders not shared with the 1120 and 1120-F**, which contain the schemas for the forms and supporting XML documents/attachment that are specific for the 1120S return type.
- **PartnershipIncome**, which is a directory for partnership income related (1065/1065-B) schemas. It contains the following folders that contain common forms shared with 1120/1120-F/1120S:
 - **Common**, which is a top-level directory for schemas for all attachments and forms that are shared among forms common to 1120/1120-F/1120S and 1065/1065-B return types. It contains the following:
 - **Various Shared Form directories**, which each contain the schemas for the shared forms and supporting XML documents/attachment between 1120/1120-F/1120S and 1065/1065-B return types.

2.5.2 7004 XML Schema File Structure (explanation on the next page)

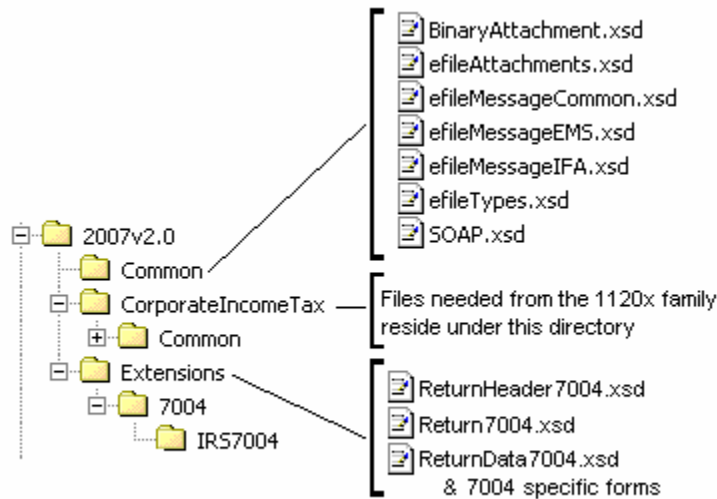

Figure 2-9: 7004 Package

The following describes the MeF Schema File Structure for Form 7004 (Figure 2-9):

2007v2.0 is the top-level directory of the schemas for the Tax Year 2007, version “2.0”. Note that reference to tax year is a means of controlling version releases each processing year. Form 7004 is not issued each tax year and, therefore, does not have a tax year.

2007v2.0 contains the following folders:

- **Common**, which contains the XML schemas that are common to all MeF return and extension types. It contains the following:
 - **BinaryAttachment.xsd**, which defines the binary attachment document XML structure
 - **efileAttachments.xsd**, which defines the attachment document XML structure
 - **efileMessageCommon.xsd**, which defines the transmission header, transmission manifest, and acknowledgement XML structures for the basic message.
 - **efileMessageIFA.xsd**, which defines the transmission header, transmission manifest, and acknowledgement XML structures for the IFA channel.
 - **efileMessage.xsd**, which defines the transmission header, transmission manifest and the acknowledgement XML structures.
 - **efileTypes.xsd**, which defines the global data types for MeF schemas.
 - **SOAP.xsd**, which defines the XML structure of the SOAP envelope, SOAP header and the SOAP.

- **CorporateIncomeTax**, which is a directory for corporate income related (1120/1120-F/1120S) schemas and shared payment schemas. It contains the following folders:
 1. **Common**, which is a top-level directory for schemas for all attachments shared among forms common to 1120, 1120-F, 1120S, and 7004 return types. It contains the following folder:
 - **Dependencies**, which contain schemas for the supporting XML documents/attachments common to 7004 and/or the 1120/1120-F/1120S return types. It includes the following:
 - **IRSPayment.xsd**, which defines the XML structure of payments.
 - **MixedStraddleAccountElectionStatement**, which defines XML schema for extension type elections.
- **Extensions**, which is a directory for extension forms (7004/8868) schemas and contains the following:
 1. **7004**, which is a top-level directory for schemas for all forms and attachments shared among forms common to 7004 return types. It contains the following:
 - **ReturnHeader7004.xsd**, which defines the structure and global data elements for the 7004 return.
 - **ReturnData7004.xsd**, which defines the common content of the ReturnHeader element for the 7004 return.
 - **Return7004.xsd**, which defines the XML structure for the 7004 return and wraps around the ReturnHeader and ReturnData7004 XML documents in a transmission file.
 2. **IRS7004**, which contains schemas specific to the 7004 return type. It contains the following:
 - **ConsolidatedGroupMemberSchedule**, which defines the XML structure of the Consolidated Group Member Schedule.
 - **IRS7004.xsd**, which defines the XML structure of the 7004 return.

2.5.3 Exempt Organization Forms XML Schema File Structures

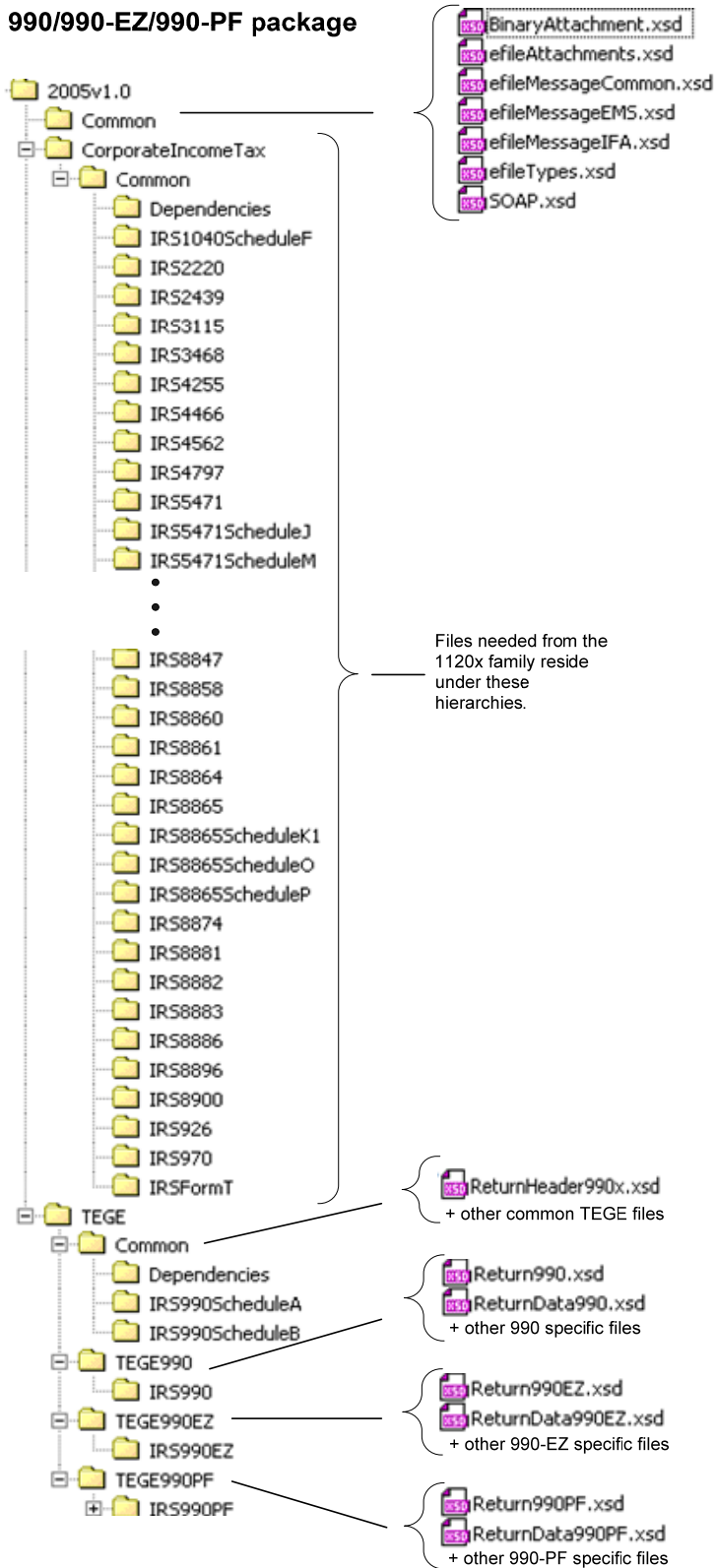

Figure 2-10: 990/990-EZ/990-PF Package

The following section describes the MeF Schema File Structures for Exempt Organization Filings for the 990, 990-EZ, and 990-PF package shown in [Figure 2-10](#) on the previous page.

2005v1.0 is the top-level directory of the schemas for the Tax Year 2005, version “1.0”. It contains the following folders:

Common contains the XML schemas that are common to all MeF return/extension types, both Exempt Organization (990/990-EZ/990-PF/1120-POL/8868) and Corporate (1120/1120-F/1120S/7004). It contains the following XML schemas:

- **SOAP.xsd** defines the XML structure of the SOAP envelope, SOAP header and the SOAP.
- **efileMessageCommon.xsd**, **efileMessageIFA.xsd**, and **efileAttachments.xsd** defines the transmission header, transmission manifest and the acknowledgement XML structures.
- **efileTypes.xsd** defines the global data types for MeF schemas.
- **BinaryAttachment.xsd** defines the content model for the binary attachment XML Document.

CorporateIncomeTax is a hierarchy of Corporate (1120x) schemas used by Exempt Organization schemas.

TEGE is the top-level directory of the 990/990-EZ/990-PF Exempt Organization schemas. It contains the following folders:

Common is a directory for schemas for all attachments and dependencies shared between Exempt Organization Forms 990 and 990-EZ. It contains the following:

- **ReturnHeader990x.xsd** defines the structure and global data elements for the Forms 990 and 990-EZ returns.
- **Dependencies** contain schemas for the supporting XML documents/attachments common to Forms 990, 990-EZ and 990-PF.

TEGE990EZ is a directory for Form 990-EZ related schemas not included in the above directories. It contains the following:

- **Return990EZ.xsd** defines the XML structure for the return and wraps around the ReturnHeader990x and ReturnData990EZ XML documents in a transmission file.
- **ReturnData990EZ** defines the content model for a Form 990-EZ return. This includes defining all XML forms and schedules in the return.

TEGE990PF is a directory for Form 990-PF related schemas not included in the above directories. It contains the following:

- **Return990PF.xsd** defines the XML structure for the return and wraps around the ReturnHeader990x and ReturnData990PF XML documents in a transmission file.
- **ReturnData990PF** defines the content model for a Form 990-PF return. This includes defining all XML forms and schedules in the return.

990-N Package

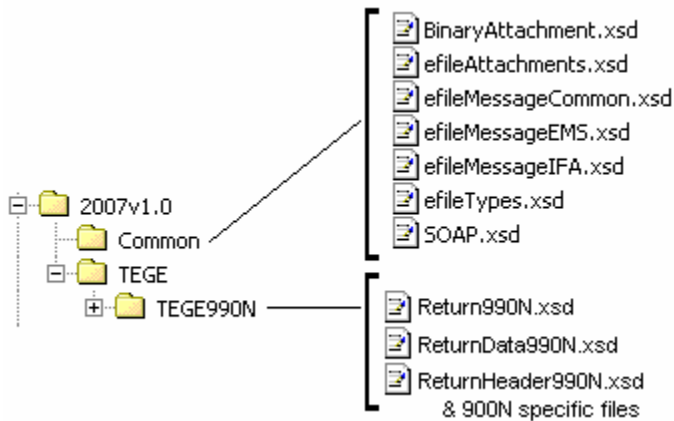

Figure 2-11: 990-N Package

2007v1.0 is the top-level directory of the schemas for the Tax Year 2007, version 1.0. It contains the following folders:

Common contains the XML schemas that are common to all MeF return/extension types. It contains the following XML schemas:

- **SOAP.xsd** defines the XML structure of the SOAP envelope, SOAP header and the SOAP.
- **efileMessageCommon.xsd**, **efileMessageEMS.xsd**, **efileMessageIFA.xsd**, and **efileAttachments.xsd** defines the transmission header, transmission manifest and the acknowledgement XML structures.
- **efileTypes.xsd** defines the global data types for MeF schemas.
- **BinaryAttachment.xsd** defines the content model for the binary attachment XML Document.

TEGE is the top-level directory of the 990/990-EZ/990-PF/990-N Exempt Organization schema. It contains the following folder:

TEGE990N is a directory for Form 990-N specific schemas not included in the above directories. It contains the following:

- **Return990N.xsd** defines the XML structure for the return and wraps around the ReturnHeader990N and ReturnData990N XML documents in a transmission file.
- **ReturnData990N.xsd** defines the content model for a Form 990-N return. This includes defining all XML forms and schedules in the return.
- **ReturnHeader990N.xsd** defines the structure and global data elements for the Form 990-N return.

8868 XML Schema File Structure

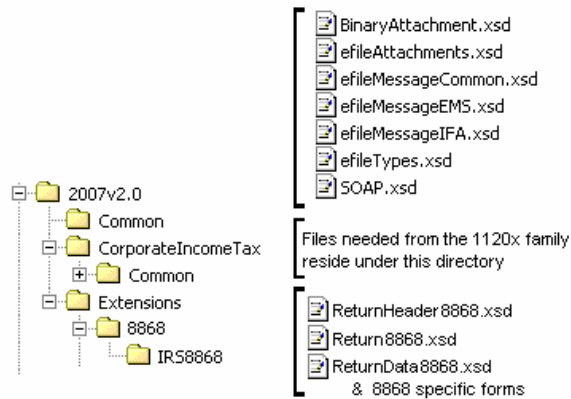

Figure 2-12: 8868 Package

The following section describes the MeF Schema File Structures for Exempt Organization Filings for the 8868 package shown in [Figure 2-12](#) above.

Extensions is the top-level directory of the 8868 extension schemas. It contains the following:

8868 is a directory for Forms 8868 related schemas. It contains the following:

- **Return8868.xsd** defines the XML structure for the extension and wraps around the ReturnHeader8868 and ReturnData8868 XML documents in a transmission file.
- **ReturnHeader8868.xsd** defines the structure and global data elements for the Form 8868 extension.
- **ReturnData8868** defines the content model for the Form 8868 extension.

1120-POL XML Schema File Structure

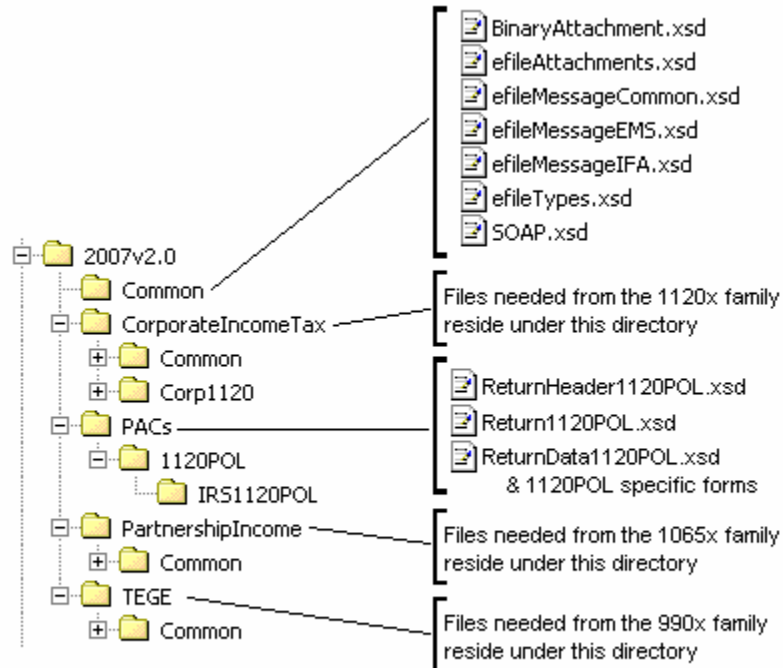

Figure 2-13: 1120-POL Package

The following section describes the MeF Schema File Structures for Exempt Organization Filings for the 1120-POL package shown in [Figure 2-13](#) above.

PACs is the top-level directory of the 1120-POL schemas. It contains the following:

1120POL is a directory for Forms 1120-POL related schemas not included in the above directories. It contains the following:

- **Return1120POL.xsd** defines the XML structure for the tax return and wraps around the ReturnHeader1120POL and ReturnData1120POL XML documents in a transmission file.
- **ReturnHeader1120POL.xsd** defines the structure and global data elements for the Form 1120-POL tax return.
- **ReturnData1120POL** defines the content model for a Form 1120-POL tax return. This includes defining all XML forms and schedules in the tax return.

The schemas for the Exempt Organization forms may be found on the irs.gov website at <http://www.irs.gov/charities/article/0,,id=105955,00.html>

2.5.4 1065/1065-B XML Schema File Structure (explanation on the next page)

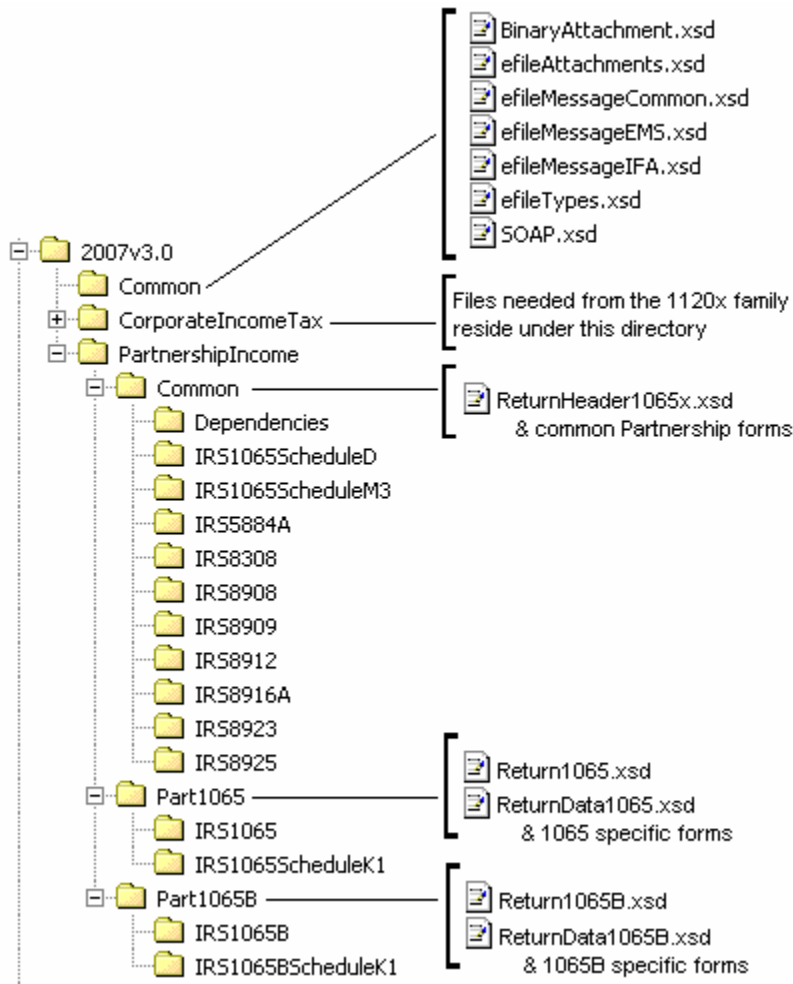

Figure 2-14: 1065/1065-B Package

The following describes the MeF Schema File Structure for Form 1065/1065-B (Figure 2-14 above):

2007v3.0 is the top-level directory of the schemas for the Tax Year 2007, version “3.0”. It contains the following folders:

- **Common**, which contains the XML schemas that are common to all MeF return and extension types. It contains the following:
 - **BinaryAttachment.xsd**, which defines the binary attachment document XML structure
 - **efileAttachments.xsd**, which defines the attachment document XML structure
 - **efileMessageCommon.xsd**, which defines the transmission header, transmission manifest, and acknowledgement XML structures for the basic message.
 - **efileMessageIFA.xsd**, which defines the transmission header, transmission manifest, and acknowledgement XML structures for the IFA channel.

- **efileTypes.xsd**, which defines the global data types for MeF schemas.
 - **SOAP.xsd**, which defines the XML structure of the SOAP envelope, SOAP header and the SOAP.
- **CorporateIncomeTax**, which is a directory for corporate income related (1120/1120-F/1120S) schemas. It contains the following folders that contain common forms shared with 1065/1065-B:
- **Common**, which is a top-level directory for schemas for all attachments and forms that are shared among forms common to 1120/1120-F/1120S and 1065/1065-B return types. It contains the following:
 - **Dependencies**, which contain schemas for the supporting XML documents/attachments common to 1120/1120-F/1120S and 1065/1065-B return types.
 - **Various Shared Form directories**, which each contain the schemas for the shared forms and supporting XML documents/attachment between 1120/1120-F/1120S and 1065/1065-B return types.
 - **Corp1120**, which contains schemas specific to the 1120 return type. It also contains the following folder which contains common forms shared with 1065/1065-B:
 - **IRS8902**, which contains the schemas for the shared form, IRS8902, and supporting XML documents/attachments common to 1120/1120-F/1120S and 1065/1065-B return types.
- **PartnershipIncome**, which is a directory for partnership income related (1065/1065-B) schemas. It contains the following folders:
- **Common**, which is a top-level directory for schemas for all attachments and forms shared among forms 1065 and 1065-B return types. It contains the following:
 - **ReturnHeader1065x.xsd**, which defines the structure and global data elements for the 1065 and 1065-B tax returns.
 - **Dependencies**, which contain schemas for the supporting XML documents/attachments common to 1065 and 1065-B return types.
 - **Various Shared Form directories**, which each contain the schemas for the shared forms and supporting XML documents/attachment between 1065 and 1065-B return types.
 - **Part1065**, which contains schemas specific to the 1065 return type. It contains the following:
 - **Return1065.xsd**, which defines the XML structure for the tax return and wraps around the ReturnHeader1065x and ReturnData1065 XML documents in a transmission file.
 - **ReturnData1065.xsd**, which defines the content model for a 1065 tax return. This includes defining all XML forms and schedules in the tax return.
 - **List of all form folders not shared with the 1065-B**, which contain the schemas for the forms and supporting XML documents/attachment that are specific for the 1065 return type.
 - **Part1065B**, which contains schemas specific to the 1065-B return type. It contains the following folders:
 - **Return1065B.xsd**, which defines the XML structure for the tax return and wraps around the ReturnHeader1065x and ReturnData1065B XML documents in a transmission file.

- **ReturnData1065B.xsd**, which defines the content model for a 1065-B tax return. This includes defining all XML forms and schedules in the tax return.
- **List of all form folders not shared with the 1065**, which contain the schemas for the forms and supporting XML documents/attachment that are specific for the 1065-B return type.

2.5.5 Excise Tax Forms 720/2290/8849 XML Schema File Structure

720 Package

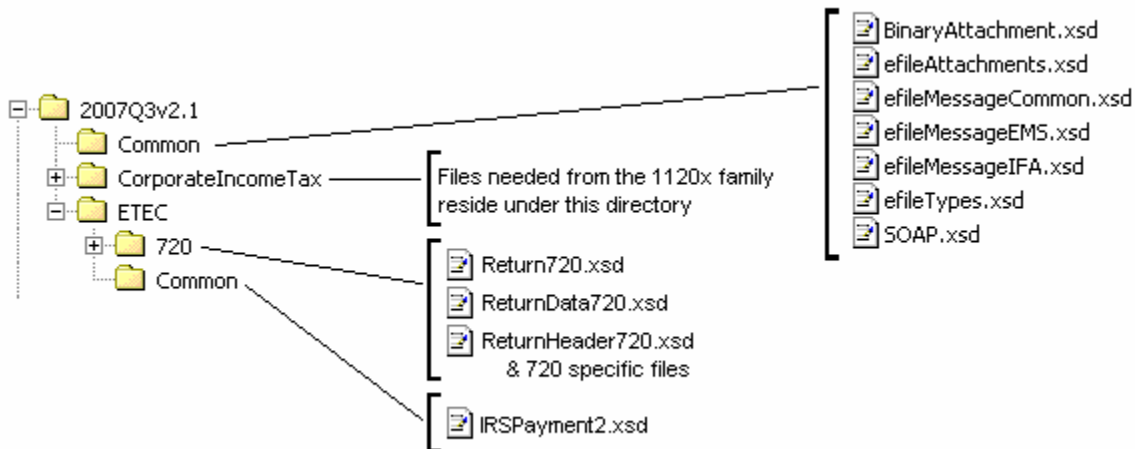

Figure 2-15: 720 Package

2007Q3v2.1 is the top-level directory of the schemas for the Tax Year 2007, 3rd Quarter, version 2.1. It contains the following folders:

Common contains the XML schemas that are common to all MeF return/extension types. It contains the following XML schemas:

- **SOAP.xsd** defines the XML structure of the SOAP envelope, SOAP header and the SOAP.
- **efileMessageCommon.xsd**, **efileMessageEMS.xsd**, **efileMessageIFA.xsd**, and **efileAttachments.xsd** defines the transmission header, transmission manifest and the acknowledgement XML structures.
- **efileTypes.xsd** defines the global data types for MeF schemas.
- **BinaryAttachment.xsd** defines the content model for the binary attachment XML Document.

CorporateIncomeTax is a hierarchy of Corporate (1120x) schemas used by Form 720.

ETEC is the top-level directory of the 2290/720/8849 **Excise Tax e-Filing and Compliance** schemas. It contains the following:

Common is a directory for schemas for all attachments and dependencies shared between Excise Tax e-Filing and Compliance Forms 2290 and 720. It contains the following:

- **IRSPayment2.xsd** defines the XML structure of payments for Forms 2290 and 720. This file is identical to the **IRSPayment.xsd** used by other tax types with the exception of including cents in the payment element.

720 is a directory for Form 720 specific schemas not included in the above directories. It contains the following:

- **Return720.xsd** defines the XML structure for the extension and wraps around the ReturnHeader720 and ReturnData720 XML documents in a transmission file.
- **ReturnHeader720.xsd** defines the structure and global data elements for the Form 720 return.
- **ReturnData720.xsd** defines the content model for the Form 720. This includes defining all XML forms and schedules in the return.

2290 Package

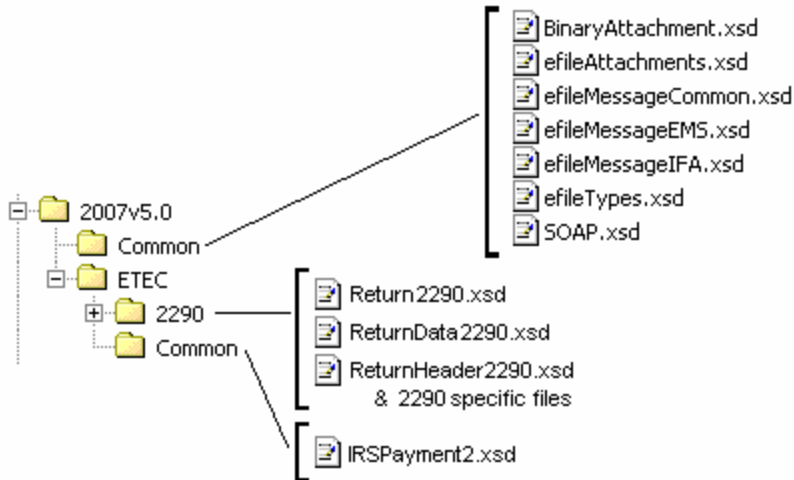

Figure 2-16: 2290 Package

2007v5.0 is the top-level directory of the schemas for the Tax Year 2007, version 5.0. It contains the following folders:

Common contains the XML schemas that are common to all MeF return/extension types. It contains the following XML schemas:

- **SOAP.xsd** defines the XML structure of the SOAP envelope, SOAP header and the SOAP.
- **efileMessageCommon.xsd**, **efileMessageEMS.xsd**, **efileMessageIFA.xsd**, and **efileAttachments.xsd** defines the transmission header, transmission manifest and the acknowledgement XML structures.
- **efileTypes.xsd** defines the global data types for MeF schemas.
- **BinaryAttachment.xsd** defines the content model for the binary attachment XML Document.

ETEC is the top-level directory of the 2290/720/8849 Excise Tax e-Filing and Compliance schemas. It contains the following:

Common is a directory for schemas for all attachments and dependencies shared between Excise Tax e-Filing and Compliance Forms 2290 and 720. It contains the following:

- **IRSPayment2.xsd** defines the XML structure of payments for Forms 2290 and 720. This file is identical to the IRSPayment.xsd used by other tax types with the exception of including cents in the payment element.

2290 is a directory for Form 2290 specific schemas not included in the above directories. It contains the following:

- **Return2290.xsd** defines the XML structure for the extension and wraps around the ReturnHeader2290 and ReturnData2290 XML documents in a transmission file.
- **ReturnHeader2290.xsd** defines the structure and global data elements for the Form 2290 return.
- **ReturnData2290.xsd** defines the content model for the Form 2290. This includes defining all XML forms and schedules in the return.

Form 8849 Package

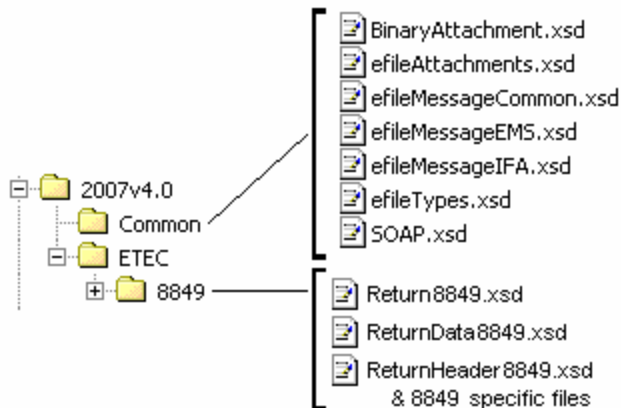

Figure 2-17: Form 8849 Package

2007v4.0 is the top-level directory of the schemas for the Tax Year 2007, version 4.0. It contains the following folders:

Common contains the XML schemas that are common to all MeF return/extension types. It contains the following XML schemas:

- **SOAP.xsd** defines the XML structure of the SOAP envelope, SOAP header and the SOAP.
- **efileMessageCommon.xsd**, **efileMessageEMS.xsd**, **efileMessageIFA.xsd**, and **efileAttachments.xsd** defines the transmission header, transmission manifest and the acknowledgement XML structures.
- **efileTypes.xsd** defines the global data types for MeF schemas.
- **BinaryAttachment.xsd** defines the content model for the binary attachment XML

Document.

ETEC is the top-level directory of the 2290/720/8849 Excise Tax e-Filing and Compliance schemas. It contains the following:

8849 is a directory for Form 8849 specific schemas not included in the above directories. It contains the following:

- **Return8849.xsd** defines the XML structure for the extension and wraps around the ReturnHeader8849 and ReturnData8849 XML documents in a transmission file.
- **ReturnHeader8849.xsd** defines the structure and global data elements for the Form 8849 return.
- **ReturnData8849.xsd** defines the content model for the Form 8849. This includes defining all XML forms and schedules in the return.

3 MeF Fed/State Program

MeF implemented the Forms 990 and 1120 Fed/State Programs in January of 2006. The 1065 Fed/State Program was added in January 2007. The central feature of MeF Fed/State program is the single point of submission and retrieval for all registered transmitters and State agencies. Federal and state submissions can be transmitted through Internet Filing Application (IFA) or Application-to-Application (A2A). States may retrieve state returns only through A2A.

MeF will accept two kinds of submissions (1) IRS (federal) submissions and (2) State submissions. Each return/extension must be enclosed in a separate submission, but multiple submissions may be contained in a single message. The IRS and State submissions do not have to be transmitted to MeF together.

Linked Returns (Fed/State returns)

A State submission can be linked to the IRS submission by including the Submission ID of the federal return in the IRS SubmissionID in State manifest. If the State submission is linked to an IRS submission (also referred to as a Fed/State return), the IRS will check to see if there is an accepted IRS submission under that Submission ID. If there is not an accepted federal return for that tax type, the IRS will deny the State submission and an acknowledgement will be sent to the transmitter. The state has no knowledge that the state return was denied (rejected) by the IRS.. (NOTE: It is best if you are going to link a State submission to an IRS submission to send in the IRS submission first and, after it has been accepted, send in the State submission.) If there is an accepted return under that Submission ID, then MeF will do minimal validation on the State submission that includes verifying that the State indicated in the State manifest is a participating state in the applicable 990, 1065 or 1120 Fed/State Program. MeF will then pass along to the State what the ERO/taxpayer sends in the State submission.

Unlinked State Returns (State Standalone returns)

If the ERO does not link the State return to a previously accepted federal return (also referred to as State Standalone return), then MeF will perform minimal validation as stated above that will include verifying that the State allows State Standalone returns and then will pass along to the State the entire State submission that was sent in by the ERO/taxpayer. Note: The state return is made up of a state and a federal portion. The taxpayer provides both components based on what is required by the state. The IRS passes to the state just the information that has been provided by the taxpayer.

Workflow for corporate and partnership state returns

- Transmitter sends state return to IRS
- IRS validates state return
 - If linked return, check IRS SubmissionId and State Participation
 - If unlinked, check State Participation
- If valid, MeF makes state return available to state
- State retrieves state returns from MeF
- State sends receipt for state return to MeF
- State processes state return and sends state acknowledgement to MeF
- Transmitter retrieves state acknowledgement from MeF
- State retrieves Acknowledgement Notification (status that transmitter retrieved the state acknowledgement)

Exempt Organization Fed/State Program

In addition, for Forms 990/990-EZ/990-N/990-PF, as part of the IRS return, a filer can request that a copy of the IRS return be provided to one or more participating States. Upon receipt of the request, IRS will validate that the State(s) is participating in the Fed/State program. If it is, then IRS will send a redacted copy of the accepted return to the State agency(s). Items that are always redacted from the state copy include, but are not limited to, the PIN or Form 8453-EO, the request for the copy and any payment information included with Form 990-PF. In addition, depending on the state, the IRS may also redact the Schedule B if the state does not require it. MeF will process the IRS submission and will generate an acknowledgement for every IRS submission and copy of IRS Forms 990/990-EZ/990-N/990-PF forwarded to a State. Each State is responsible for validating their State submissions and will be responsible for generating a State acknowledgement for each State submission which will be returned to the IRS for retrieval by the transmitter. If the Federal 990X return is rejected, no copies will be forwarded to the State.

Both Federal and State returns must be in XML format. The federal returns must conform to the IRS valid schema versions. State returns must conform to the state standards as defined at TIGERS and include those elements defined for the specific state data. You can now access the State Standard Schemas at: <http://www.statemef.com/>. For more information, you can contact the State *e-file* Coordinator. You can access a current list of State Coordinators on irs.gov at: <http://www.irs.gov/efile/article/0,,id=97558,00.html>.

4 Transmission Methods for MeF

The MeF system allows you to transmit tax returns and extensions to the IRS through two channels: MeF Internet Filing Application (IFA), and MeF Application-to-Application (A2A).

4.1 Transmitting Through Application-to-Application (A2A)

The following section describes how to transmit a file using A2A and information regarding A2A security.

4.1.1 Security Directive Rules of Behavior for Access to IRS Business Systems

The following is provided as official guidance to manage system security for systems using the Application-to-Application (A2A) interface to IRS Systems. It is provided for software developers, operational managers, Third Party Transmitters, States, system administrators, etc...

Internal Revenue Service (IRS) Third Party Transmitters and State Trading Partners shall carry out their respective responsibilities for ensuring information systems security and taxpayer privacy commensurate with the sensitivity of the information under their control. This publication provides policies and guidance to be followed by registered organizations to carry out their respective responsibilities in information systems security.

IRS e-services registered users must provide true, accurate, current and complete information. IRS sensitive information used to access the IRS Registered User Portal (RUP) including e-services passwords, System IDs, usernames and PINs must be protected and comply with the requirements set forth and agreed to by responsible parties as part of the IRS e-services registration process.

Users shall immediately notify the IRS at 1-866-255-0654 (international callers use 512-416-7750) of any unauthorized use of passwords or accounts, or any other breach of security. In the event that the user experiences a Login failure that leads them to believe that their account has been compromised, the registered user should immediately contact the IRS at the numbers provided above.

Penalty for Non-Compliance – A2A users are using an Official United States Government System which may be used only for authorized purposes. The Government will monitor and audit the usage of this system, and all persons are hereby notified that the use of this system constitutes consent to such monitoring and auditing. Unauthorized attempts to upload information and/or change information on these web sites, and any attempts to defraud the government are strictly prohibited and subject to prosecution under the Computer Fraud and Abuse Act of 1986 and Title 18 U.S.C. Sec. 1001 and 1030. Termination of your ability to conduct business with the IRS, and other penalties may apply.

Registration for A2A credentials – As of November, 2007, The A2A registration and enrollment process for both Third Party Transmitters and State Trading Partners and their respective application systems is an automated process.

The Automated Enrollment (AE) application was developed to replace the manual enrollment of application systems for Application to Application (A2A) Web Services. The AE application will automate the enrollment process and provide a user interface for enrolling and maintaining application systems. The AE application is not available to a transmitter who supports Excise Tax Forms (Forms 720, 2290 or 8849).

Transmitters must apply to become an Authorized IRS *e-file* Provider by filling out an “IRS *e-file* Application” online if they have not previously completed the *e-file* application process. States will need to complete a new IRS *e-file* Application to participate in the Modernized *e-File* Programs even if they have a previous application for their other *e-file* programs. The *e-file* application must indicate the Form Types you will submit (e.g. 990, 1120, 1120-POL, 1065, 720, 2290, 8849) and it must indicate the transmission method of “MeF Internet” for 990, 1120 and 1120-POL and “MeF Internet, XML” for 1065.

The Principal or Responsible Official who is completing or revising the *e-file* application must also delegate one or more persons who they want to access the AE application and enroll application systems for their organization. This is done by accessing the eServices efile application and updating the delegated user section with the authority for MeF System Enroller option checked. Once this role is added to their profile, the authorized delegated user can log into the existing RUP Portal and use the AE application to enroll and maintain application systems for their organization.

The authorized delegated user can:

- enroll, un-enroll, activate, inactivate, and update Application System IDs (ASIDs) for their organization
- reset the password for a previously enrolled ASID
- replace the certificate of a previously enrolled ASID
- select Password or Certificate as the Credential Type for an ASID
- change the credential type from Password to Certificate or Certificate to Password.

IRS will no longer reset passwords since this function is included in Automated Enrollment. The Automated Enrollment (AE) External User Guide describes the User Interface for the AE application and can be found on irs.gov at: <http://www.irs.gov/efile/article/0,,id=171946,00.html>.

Password Management – MeF will support passwords and certificates through December 2008. In January 2009, all A2A systems must use certificates for authentication.

If the current password is stored either in a sequential file, the Windows Registry, or a relational database, it should be stored using triple DES or AES encryption standards. The application may also prompt the user for the password at startup. Transmission will be encrypted at the transport layer using encryption software containing a NIST-certified FIPS 140-2 compliant encryption module. Use the IFA option for communications with the IRS Systems, rather than storing an unencrypted copy of the password. **Do not use a script of clear text passwords in storage for authenticated transactions with the IRS.**

Password Criteria
Length – a minimum of 8 and a maximum of 30 Alphanumeric characters
Complexity – Use a minimum of one uppercase alpha, one lowercase alpha, one numeric and one special character. Please use at least one of each class of characters. The following set of special characters have been tested for use in passwords and tokens, Please use these special characters: period, comma, colon, semicolon, question mark, exclamation point, dollar sign, plus sign, equal sign, hyphen, underscore, asterisk, left parenthesis, right parenthesis, at sign (@), tilde (~), octothorpe (#), and caret (^).
Do not use single quote ('), double quote ("), ampersand (&), left brace (<), right brace (>), and percent (%)
Age – do not reuse passwords
20% password must change, Random character changes (i.e. no incrementing)
Passwords must be changed no less than every 30 days, but cannot be changed more than once every 24 hours
Password reset may be performed by a delegated user with the authority fo MeF System Enroller
ChangePassword cannot be used after the password has expired. See password reset below for instructions on how to reset your password. When 15 days have expired since your last password change you will receive a password change reminder as part of the Login response.

Note – Check to see if you are caching. If you are, we recommend clearing the cache after changing your password. This will eliminate any possibility of accidentally submitting the old password.

Failures during a password change are possible. After such a failure, a program cannot be sure whether the system considers it has the new password or the old password. After a failure during the password change, make sure the rejection of the change was not because the new password is invalid. The next login should typically use the new password. If it fails, log in using the old password. If this also fails, do not try any further. The authorized delegated user should reset the password. States and Third Party users must immediately inform the IRS of any suspected breach of passwords by contacting the *e-Help* Desk at 1-866-255-0654 and selecting the *e-file* prompt.

Encryption and decryption of passwords will typically be performed in memory; unless you are using relational database software with built-in encryption. Standard facilities for encryption are available, and you must use a standardized encryption algorithm compliant with triple DES or AES. Pointers to sample encryption code are provided below. Remember, you will be encrypting very small amounts of data.

An example of .NET encryption of data to go into a registry can be found at <http://msdn2.microsoft.com/en-us/library/k62k71x0.aspx> -

Please note that by clicking on any of the links in this paragraph, you will leave the IRS web site and enter a privately owned web site created, operated and maintained by a private business. The information that this private business collects and maintains as a result of your visit to its web site may differ from the information that the IRS collects and maintains. (please see the IRS web site privacy and security notice for privacy protections IRS provides to web site visitors). By linking to this private business, the IRS is not endorsing its products, services, or privacy or security policies. We recommend you review the business's information collection policy or terms and conditions to fully understand what information is collected by this private business.

To store encrypted information refer to: <http://msdn2.microsoft.com/en-us/library/aa302406.aspx>. To use the built-in Triple-DES support in Java (J2SE 1.4.2 and later, existing as an extension in earlier versions), applications should normally use the Cipher class, whose API is found at <http://java.sun.com/j2se/1.4.2/docs/api/javax/crypto/Cipher.html>. To encrypt or decrypt a single password using “Cipher”, you’ll typically need to call the init method, and then the doFinal method with your data (the password for encrypt, the binary version of the stored data for decrypt). Creating your object of the Cipher class involves using the Cipher.getInstance method (Cipher.getInstance(“DESede/CBC/PKCS5Padding”) for Triple-DES in version 1.4.2). The cipher key must be the correct size (112 or 168 bits for Triple-DES, 128 bits for AES).

Password Reset – Automated Enrollment provides authorized delegated users the ability to reset the password for a previously enrolled Application System IDs (ASIDs)

Certificate Management – A2A transmitters may use digital certificates (X.509) versus passwords upon proper enrollment and registration of the certificate. Strong protection (encryption) of the signing key is important on your system. **Do not store an unencrypted copy of the signing key on your system.** The signing key should be stored in a standard encrypted key store. The IRS will provide transmitters with a pair of libraries to perform signing. One library is for .NET support and the other will be used by transmitters whose code uses the Java support for Web Services. Each of these libraries will use the standard key storage for their environment, whether Windows' certificate store or PKCS#12 (for .NET) or a standard Java key store such as JCEKS or JKS (for Java). Always protect Key store passwords used to encrypt signing keys. For problems associated with certificate management, please contact the *e-Help* Desk at 1-866-255-0654 for assistance and select the *e-file* prompt.

Strong Authentication -The IRS is offering Strong Authentication, which will affect authentication for all A2A Web services. The certificate will replace the password and will require a modification to the WSDLs. Each transmitter and state will be required to register their certificate with MeF.

In order to provide adequate time for you to test Strong Authentication, you will not be required to move to certificates until November 2008 in ATS and January 2009 in Production. **But we strongly suggest that you start testing and using certificates as soon as you can.**

It's recommended that a new ATS (Assurance Testing System) client be added for developing and testing your digital signature code for MeF processing, prior to converting existing client applications over to use strong authentication.

A guide is also available which explains the integration and uses of this IRS-provided client code sample to support certificate-based authentication for MeF A2A Web services. In addition to the code itself, it provides necessary information and guidance that developers may use when integrating the new feature into client software that communicates with the IRS A2A Web services. This guidance is relevant both to client code that will be developed in the future and to pre-existing client code not currently using digital signatures to sign SOAP messages. If interested in obtaining the Strong Authentication guide, please contact IRS at: 1120@irs.gov.

Compliance with U.S. Internet Cryptographic Standards – All transmitters are advised to use software that supports the U.S. Internet Standards for A2A or Browser-based access. The software needs to comply with U.S. Internet Standards for use of Cryptography in accordance with guidance from the Bureau of Industry and Security, U.S. Department of Commerce (www.bis.doc.gov).

Compliance Enforcement – The IRS retains the right, to conduct random, unannounced and unscheduled onsite inspections of any facility using the A2A functionality. These visits will be solely for ensuring compliance with the A2A password management policies, especially the encrypted storage of at rest passwords. Any non-compliance will result in immediate termination of the A2A connection privileges until such time the third party can demonstrate compliance. Repeated instances of non-compliance will result in permanent removal of permissions to utilize the A2A functionality of the MeF system.

Data Removal – The IRS requires removal of taxpayer data from systems that are no longer used for the purpose of processing and transmitting taxpayer data. On systems running any Windows operating system, an Administrator should reduce the size of all Windows page files (pagefile.sys) by at least one megabyte on each available hard drive containing a page file. Administrators should also clear all \temp directories and, if using a web browser for processing or transmitting, clear all temporary files and caches. If the system hard drives will not be sanitized by degaussing, then files containing taxpayer data must be wiped using a file erasure program that performs at least three file overwrites or that meets NIST standards for file data destruction. If a “slack space” data destruction utility is available, it should also be used. After making the above changes, the system should be rebooted. Systems utilizing any other operating systems should be sanitized using methods similar to those described above.

4.1.2 Transmitting through MeF Application-to–Application (A2A)

Transmitters and state agencies communicate with the MeF system using a series of service requests that are accomplished using messages. The service requests include:

MeF Application-to-Application		
SERVICE REQUEST	TRANSMITTER	STATE AGENCY
Send Submissions	X	
Get New Acknowledgements	X	
Get Acknowledgements	X	
Get Acknowledgement	X	
Get Acknowledgements by Message ID	X	
Get New Submission Status	X	
Get Submissions Status	X	
Get New 2290 Schedule 1s	X	
Get 2290 Schedule 1s by Message ID	X	
Get New Submissions		X
Get Submissions		X
Get Submission		X
Get Submissions by Message ID		X
Send Submission Receipts		X
Send Acknowledgements		X
Get New Acknowledgement Notifications		X
Get Acknowledgement Notifications		X
Get Acknowledgement Notification		X
Initial Login	X	X
Login	X	X
Logout	X	X
Change Password	X	X
Request ETIN Status	X	X
Request List of ETINs	X	X
Request List of State Participants	X	X

← Fed/State

It is important to note that all service requests are synchronous. The request is not complete until the originating system receives a response from MeF. The response either contains the information requested, a confirmation, or an error. The error indicates the problem encountered while processing the request.

Use `GetSubmissionsByMsgId` and `GetAcknowledgementsByMsgId` to retrieve submissions or acknowledgements previously retrieved with a `GetNewSubmissions` or `GetNewAcknowledgements` service request. You must pass the message ID used in the original `GetNewSubmissions` or `GetNewAcknowledgements` request as a parameter to the `GetSubmissionsByMsgId` and `GetAcknowledgementsByMsgId` request. These two services are often used to retrieve submissions or acknowledgements previously retrieved but lost due to a timeout.

For more information about A2A, refer to the *MeF State and Trading Partners ICD* and the *MeF Submission Composition Guide*.

4.1.3 General Information and Lessons Learned

- **A2A SSL Certificates**

Before any system can transact A2A business with MeF, our certificates may have to be loaded onto your system. The certificates are the same for MIME and DIME users. There are five certificates, and all five are provided to you by the IRS in a single zip file. These certificates must be used for login/password and strong authentication services. To obtain the certificates, contact Xan Ostro at 202-283-7697 or at Xan.H.Ostro@irs.gov.

- **System Registration Login and Password**

You must enroll each system with the IRS before conducting A2A business. Upon successful enrollment, you will receive a password and confirmation token for each system you registered. Login/Password users must successfully execute InitialLogin (MSI service) prior to attempting any other service. InitialLogin must contain the System ID, password and confirmation token. Make sure you are using the password and confirmation token provided to you at registration for that system. No other password or confirmation token will work. The System ID is your user name for that system. You must also change your password in the body of the InitialLogin.

- **Strong Authentication**

The IRS is offering strong authentication, which will affect authentication for all A2A Web services. The certificate will replace the password and will require a modification to the WSDLs. Each transmitter and state will be required to register their certificate with MeF. Additional information about registering and using certificates will be provided at a later date. In order to provide adequate time for you to test Strong Authentication, you will not be required to move to certificates until November 2008 in ATS and January 2009 in Production. **But we suggest that you start testing and using certificates as soon as you can.** We will notify you of any changes.

You must use a separate application system id for testing digital certificates. You must also upload your digital certificate to the IRS while enrolling your new system (id) using Automated Enrollment. Finally, you must rebuild your services using the newest WSDLs, which have been updated for digital certificates. (The WSDLs are backwardly compatible. In other words, you can continue using the previous WSDL version for transacting business while testing digital certificates.) Once you have enrolled a system, uploaded your certificate, and built services based on the new WSDLs, you can test digital certificates. There are several things to keep in mind: (1) There is no InitialLogin service associated with Strong Authentication like there is for login/password. Begin testing using the login service. Only the login service should contain the binary signature. When your binary signature (login) has been authenticated, a login response will be returned to you. This response will contain a SAML, just like the current login response does. Use the SAML (not the binary signature) in all subsequent services in that session. (2) If you are using a “Single Step” service, instead of login, then the Single Step service must contain the binary signature. (3) Once you have successfully tested all services using digital certificates, you should convert all your application system ids to Strong Authentication (Digital Certificates).

- **Password Changes**
If your client uses cache, remember to clear the cache after changing your password. Failure to do so may result in transmitting the incorrect password. Three consecutive failures will lock your system's account.
- **Service Request Encoding**
DO NOT USE base 64 encoding. All requests encoded in base 64 will be rejected.
- **.NET WSE Libraries**

.NET users should use WSE 2.0 and not 3.0. MeF supports DIME and MIME, not MTOM. WSE 2.0 contains the DIME classes. WSE 3.0 supports MTOM only. The DIME classes have been removed from 3.0. IRS is looking into the possibility of supporting MTOM sometime in 2009.
- **Attachment Encoding**
Each return is contained in its own zip file, and all return zip files must be placed into a container zip file. The container zip file is attached to the SendSubmissions service request. If a SendSubmissions service contains more than one attachment, the service will be rejected. The attachment must be MIME or DIME encoded.
- **Attachment Content Type**

Whether using IFA or A2A, "attachment content type" should be set to application/octet-stream, not application/zip.
- **2290 Schedule 1 Services**

Even though the Schedule 1 services are listed as general transmitter services, only 2290 transmitters and software developers are authorized access to them.
- **State Testing**
We provide generic state returns for states to test the GetSubmission portfolio of service requests. When ready to test these services, the state should call 202-283-7697 or e-mail Xan Ostro at Xan.H.Ostro@irs.gov to ask him to load these generic returns. The request may take a day or two to fulfill. **Note:** We usually load about 10 returns per request. Upon receiving a GetNewSubmissions request, MeF will return the number of submissions requested (up to 100), if that many submissions are available for retrieval. This means that all 10 will be returned in the first request unless you lower your MaxResults to some number under 10. We recommend you request two or three at a time. Lowering your MaxResults to 2 or 3 will permit you to test GetNewSubmissions more than once before having to request that additional state returns be loaded.

These generic returns are for testing your service requests, and not for validating the returns on your tax system. However, there will come a time, when each state will want to test using actual state returns. We recommend you contact a software developer to transmit those returns for you. The IRS does not provide individual state returns, nor does the IRS transmit

'live' state returns (production). Using a software developer or transmitter will more accurately reflect production conditions.

If you cannot locate a software developer, the IRS will transmit for you, but you must supply us with your state returns. The zip file must follow the correct file structure. If it does not, MeF will reject the return and it will not be available for retrieval by the state. Refer to the Infrastructure Shared Services (ISS) MeF State and Trading Partners Interface Control Document (ICD) for a complete description of the zip file structure. **Note:** If you send us an incorrectly structured zip file, the IRS will not correct the file structure for you.

- **Transmitting Large Attachments Using .NET**

Some customers have experienced problems transmitting large attachments (megabytes) when using .net. If this happens, contact Xan Ostro at 202-283-7697 or at Xan.H.Ostro@irs.gov.

- **Clock Synchronization**

Make sure your system clock is accurately set. Failure to do so may cause a synchronization failure between your system and MeF. A synchronization failure will result in denial of access until you synchronize your clock.

- **URLs**

Use la, not 'la1' or 'la2' unless instructed to do so by us. Use of 'la1' and 'la2' defeats load balancing and failover. Also, do not use the alt designator. URLs with the 'la.alt' designation have been discontinued. Using 'alt' may result in receiving a write error. For example, the following login URLs are incorrect.

**`https://la1.www4.irs.gov/a2a/mef/Login`
`https://la2.www4.irs.gov/a2a/mef/Login`
`https://la.alt.www4.irs.gov/a2a/mef/Login`**

The correct login URL is

`https://la.www4.irs.gov/a2a/mef/Login`

4.2 Transmitting Through the Internet Filing Application (IFA)

The following section describes how to transmit a file through the Internet using IFA.

4.2.1 Applying to Submit Returns Through the Internet

This section describes the e-services Registration and IRS *e-file* Application process for transmitters who wish to transmit MeF returns through the Internet.

Transmitters who plan to transmit the Forms 1120, 1120S, 1065, 1065-B, 7004, 990, 990-EZ, 990-N, 990-PF, 1120-POL, 8868, 720, 2290 and 8849 through the Internet must complete the IRS *e-file* Application. If your firm is not currently an Authorized IRS *e-file* Provider, a Principal or Responsible Official of your firm must register and complete the IRS *e-file* Application. If you have previously submitted an IRS *e-file* Application and are currently an authorized Transmitter, you will only need to revise your application to identify one or more of the MeF return form types and to indicate that you wish to transmit returns through the Internet. You will be required to identify an individual or individuals who are authorized to transmit returns for your firm through the Internet.

To register and complete the IRS *e-file* Application, access the IRS website (irs.gov) and complete the following processes:

Registration: You must register if you wish to gain access to any of the e-services products which include the IRS *e-file* Application. Any Principals or Responsible Officials of the firm who are listed on the application and any individuals who have been delegated to transmit MeF returns through the Internet must register. During registration, you will be required to enter your Name, Tax Identification Number (Social Security Number), Date of Birth and the Adjusted Gross Income (AGI) from either your current year or prior year tax return (verified from IRS records). You will be authenticated through these “shared secrets”. You will also be required to select a Username, Password and PIN. The IRS will then mail you a letter (to your official address of record for your 1040 tax return) that will contain a confirmation code and instructions for completing the e-services confirmation process. You will have 28 days from the date of the letter to complete the confirmation process. If you do not complete this confirmation process within 28 days of the date of the letter, your account will be deactivated and you will be required to repeat the entire registration process.

Application: After registering, you will need to apply to become an Authorized IRS *e-file* Provider or you will need to revise your existing IRS *e-file* Application. In completing the application to apply to be an Internet Transmitter, be sure to check the appropriate return form type box 1120, 990, 1065, 1120-POL, 720, 2290 or 8849 (See chart below for return form type to use), the provider option of Transmitter and the transmission method of MeF Internet for the 1120, 990, 1120-POL, and MeF Internet XML for

1065, 720, 2290, and 8849. You will also be required to delegate one or more individuals who are authorized to transmit MeF returns for your firm over the Internet.

Form you wish to transmit	Return Form Type Box to check on application
1120	1120
1120S	1120
1120-F	1120
7004	1120
990	990
990-EZ	990
990-N	990
990-PF	990
8868	990
1120-POL	1120-POL
1065	1065
1065-B	1065
7004	1065
720	720
2290	2290
8849	8849

Delegation: The person identified to transmit over the Internet must be given this authority. This is done by accessing the eServices efile application and updating the delegated user section with the MeF Internet Transmitter option checked. Once this role is added to their profile, the authorized delegated user can log into the existing RUP Portal and transmit returns through IFA for the organization.

To obtain additional information regarding the e-services Registration and IRS *e-file* Application, go to <http://www.irs.gov/taxpros/article/0,,id=109646,00.html> .

4.2.2 Transmitting through MeF Internet Filing (IFA)

You must be authorized to submit transmissions or retrieve acknowledgements through IFA. To access and log into MeF Internet Filing, complete the following steps:



Figure 4-1: IRS.gov Web Site

Step 1: Click the *e-file* logo on the irs.gov website.

Step 2: Click the *e-file* for Software Developers/Transmitters link on the *e-file* Landing Page.

e-file Topics

- Free File
- Modernized e-File (MeF)
- Info for e-file Providers
- More Topics ...

IRS Resources

- Compliance & Enforcement
- Contact My Local Office
- e-file
- Forms and Publications
- Frequently Asked Questions
- News
- Taxpayer Advocacy
- Where To File

IRS e-file Your Electronic Alternatives to Filing Paper Returns

IRS e-file Options For:

Individual Taxpayers	File your 2006 Individual Income Tax Return electronically (available through October 15, 2007). You may even qualify to file online for free through the Free File program.
Business and Self-Employed Taxpayers	Electronic filing and payment options for businesses including employment taxes, information returns, partnerships, corporations, and estates & trusts. Includes information on the new Modernized e-File (MeF) program for partnership returns, Forms 1065/1065-B.
Large and Mid-Size Corporations	Certain large and mid-size corporations are required to electronically file their Forms 1120 and 1120-S, while others may do so voluntarily. We've included information for corporations who prepare and transmit their own corporate returns and for those using the services of third-party tax professionals.
Tax Professionals	IRS <i>e-file</i> information for tax professionals. Several online e-services products are available including the electronic IRS <i>e-file</i> application. Includes information on the new Modernized e-File (MeF) program for filing partnership returns electronically.
Charities and Non-Profits	Electronic filing options for tax-exempt organizations. New requirements mean large tax-exempt organizations are now required to e-file their returns.
Excise Tax Filers	Legislation now requires filers of certain Excise Forms to file their returns electronically.
e-file Software Developers and Transmitters	For individual and business e-file programs. Includes XML schemas - downloadable zipped files and other useful information for e-file software developers and transmitters.

Figure 4-2: e-file Landing Page

Step 3: Click the *e-File* for Business – Software Developers & Transmitters Page link.

The screenshot shows a web page with a left sidebar containing a list of links: [Contact My Local Office](#), [e-file](#), [Forms and Publications](#), [Frequently Asked Questions](#), [News](#), [Taxpayer Advocacy](#), and [Where To File](#). The main content area on the right features several sections:

- [Electronic Management System \(EMS\) What's New for 2007? \(Includes 2006 Information\)](#)
All direct transmitters who login to the 2007 Electronic Management System (EMS) for Tax Year 2006 will be required to enter a new EMS Login ID that will be mailed to them.
- [2007 Individual e-file Transmission Chart](#)
Processing for 1040 e-file in 2007 (Tax Year 2006)
- [Publication 1346 \(Rev. 9-2006\)](#)
Electronic Return File Specifications, Record Layouts and Electronic Transmitted Documents for Individual Income Tax Returns (Tax Year 2006).
- [Discontinuance of Non-Encrypted Options for the 2006 filing season and discontinuance of IRS-provided dial-up and ISDN lines](#)
Internal Revenue Service has provided the ability for IRS e-file program participants, who transmit directly to the Electronic Management System (EMS), to use only IRS approved encryption methods for the 2006 and later filing seasons.
- [2008 Credit Card Bulk Provider Requirements](#)
Software providers can incorporate a credit card tax payment option in their products following the technical specifications described in this document. This integrated e-file and e-pay option provides one-stop service to e-filers with a balance due.
- [QuickAlerts](#)
Never miss another important e-file message with QuickAlerts! Calling all ERO's, Software Developers and Transmitters - Did you know that the IRS has a **free** messaging system that provides e-file information including submission processing center delays within moments of when they occur?
- [e-services](#)
Online e-services products are now available including the electronic e-file application.
- [Toll-Free Number for e-Help](#)
e-Help desk assistants are ready to respond to all questions and issues concerning e-products at 1-866-255-0654.
- [e-file for Business - Software Developers & Transmitters Page](#)
Includes XML Schemas - downloadable zipped files and other useful information for business Software Developers and Transmitters.

Figure 4-3: IRS.gov Website with *e-file* for Business - Software Developers & Transmitters Page link

Step 4: Click the Modernized *e-File* (MeF) Internet Filing and Status Page link.

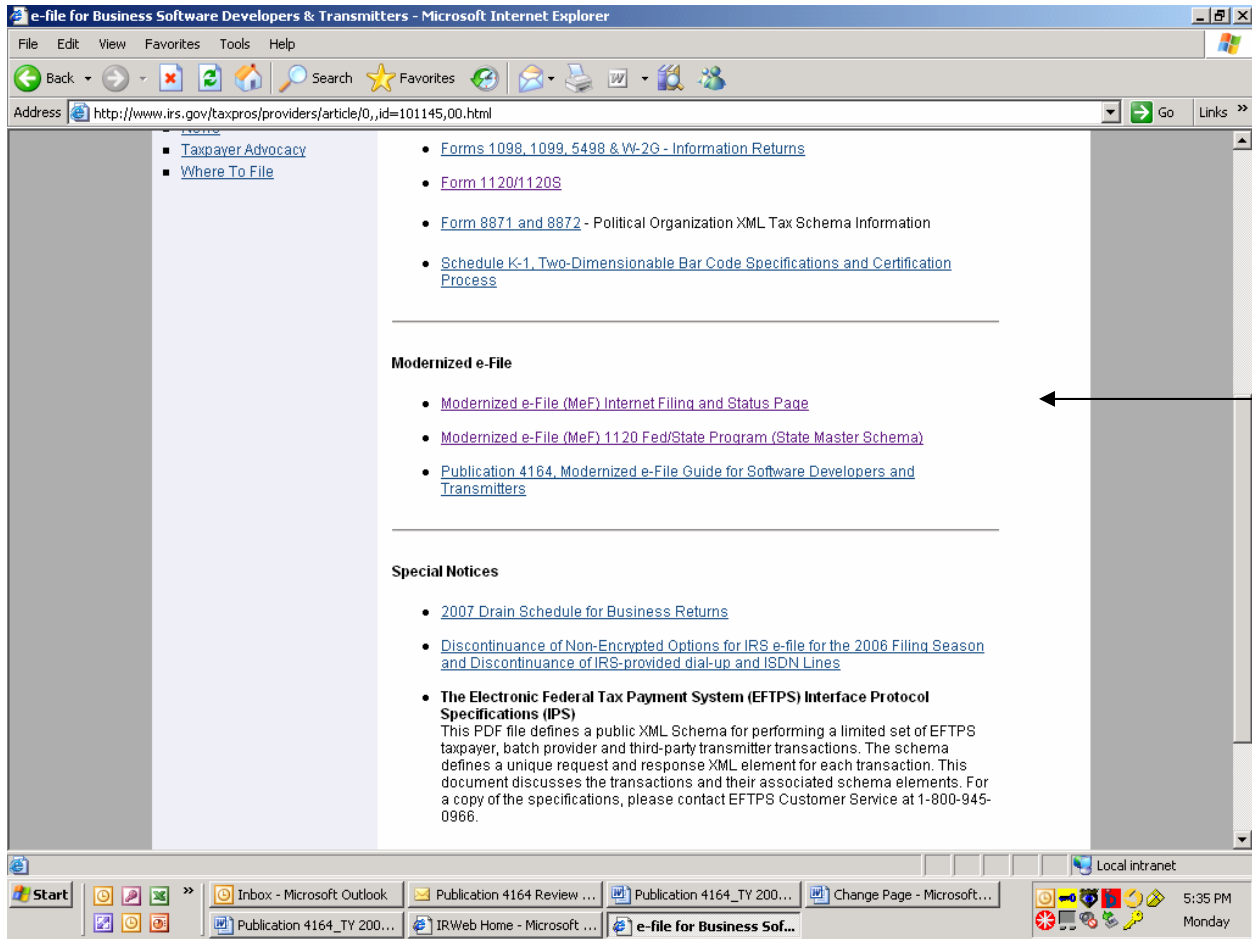

Figure 4-4: IRS.gov Modernized *e-File* (MeF) Internet Filing and Status Page link

Step 5: Click the MeF Internet Filing link to Login

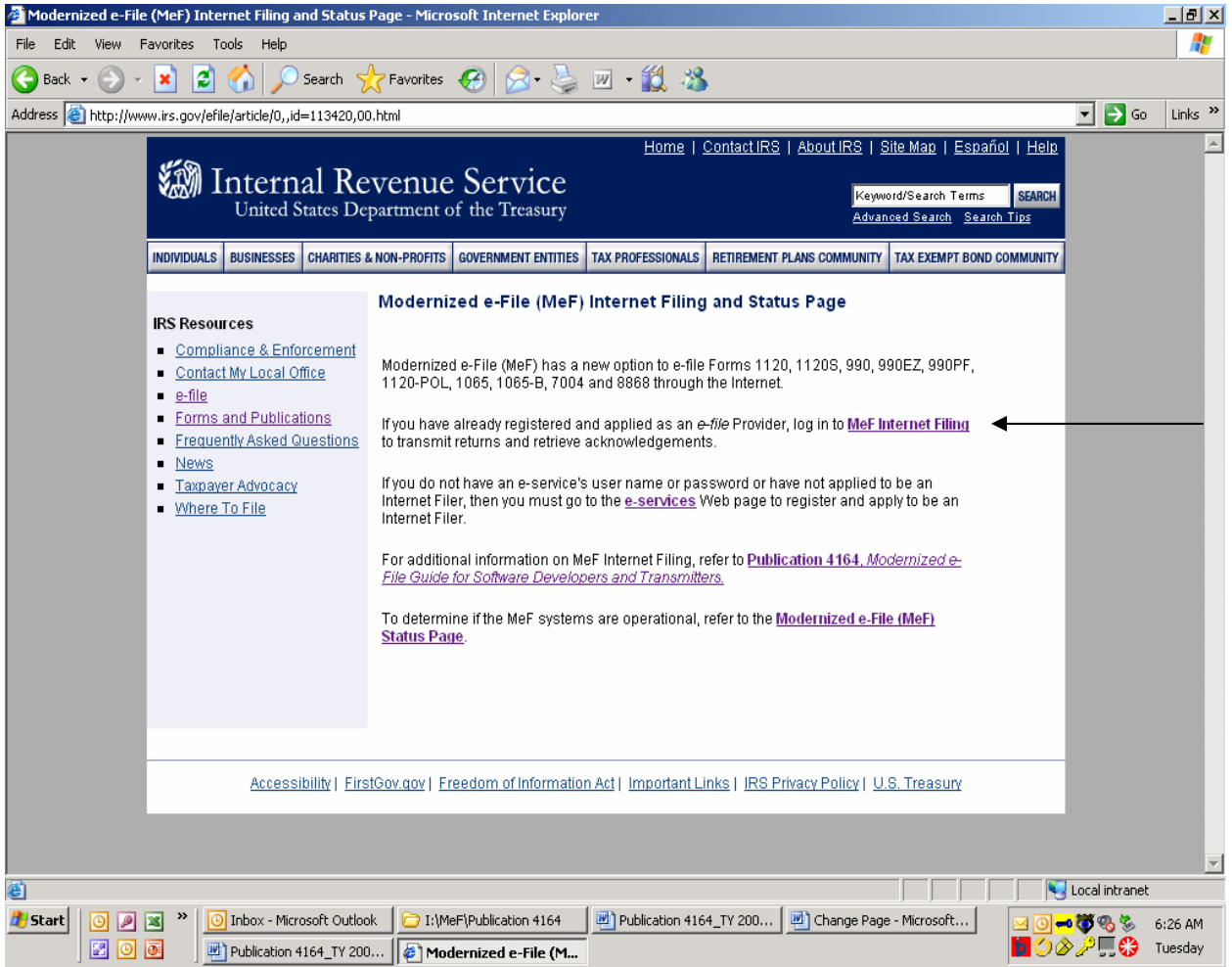

Figure 4-5: IRS.gov MeF Internet Filing Landing and Status Page

Step 6: Read the security alert. Click the OK button in the Security Alert dialogue box to access the MeF Internet Filing Login screen.

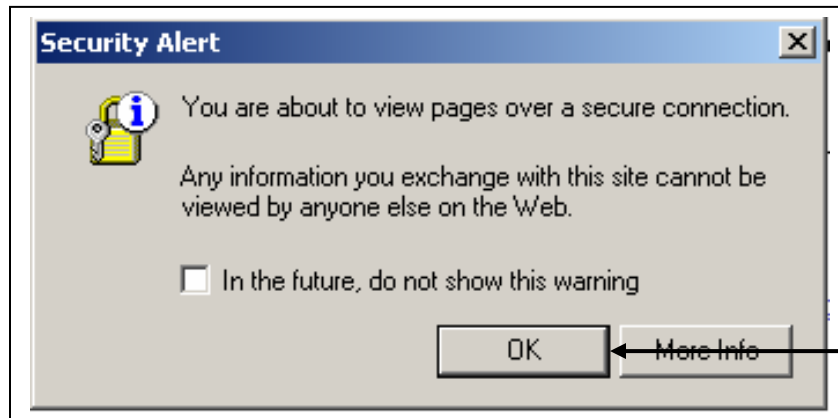

Figure 4-6: IRS.gov Security Alert

Step 7: Enter your e-services Username and Password to receive authentication as an authorized Transmitter.

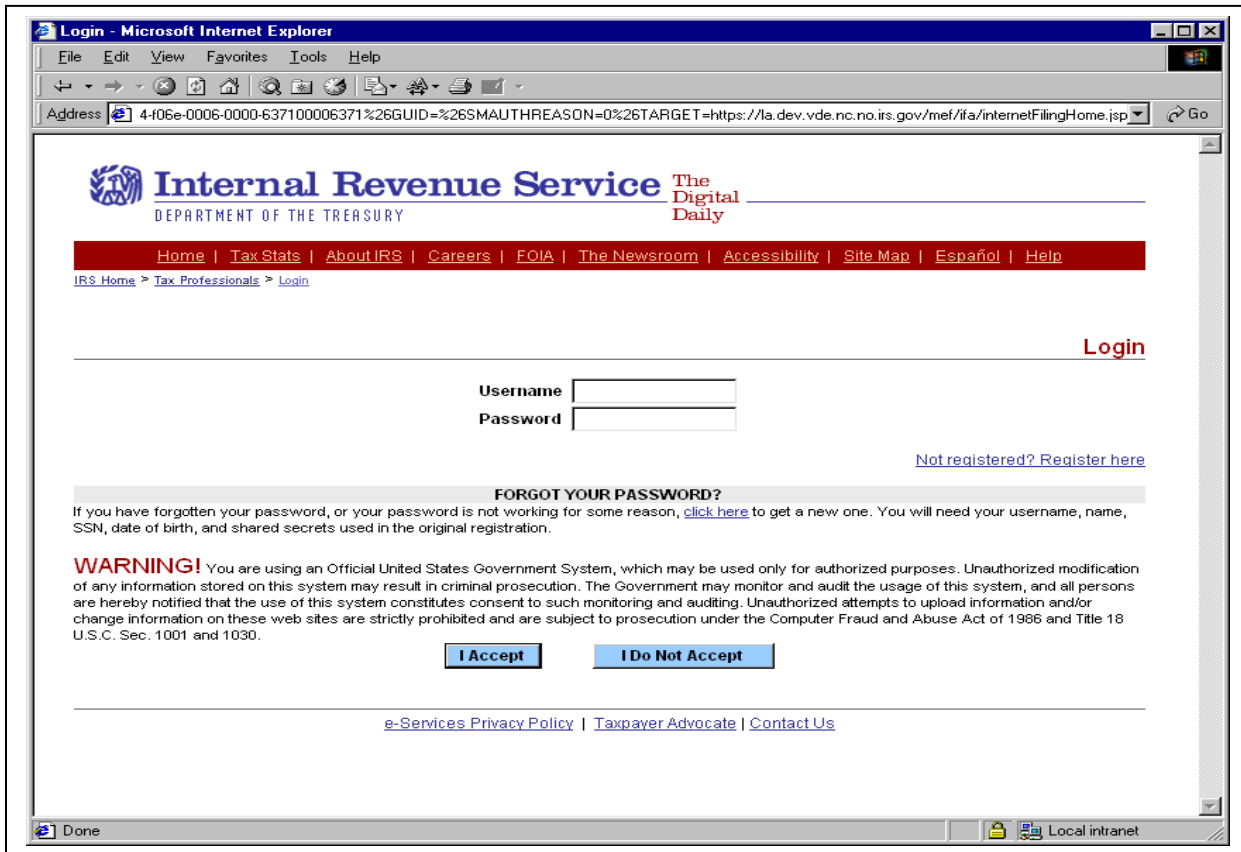

Figure 4-7: e-services Login Screen

Step 8: After being authenticated, select the organization you will represent in the session from the list of companies that have authorized you to transmit returns on their behalf.

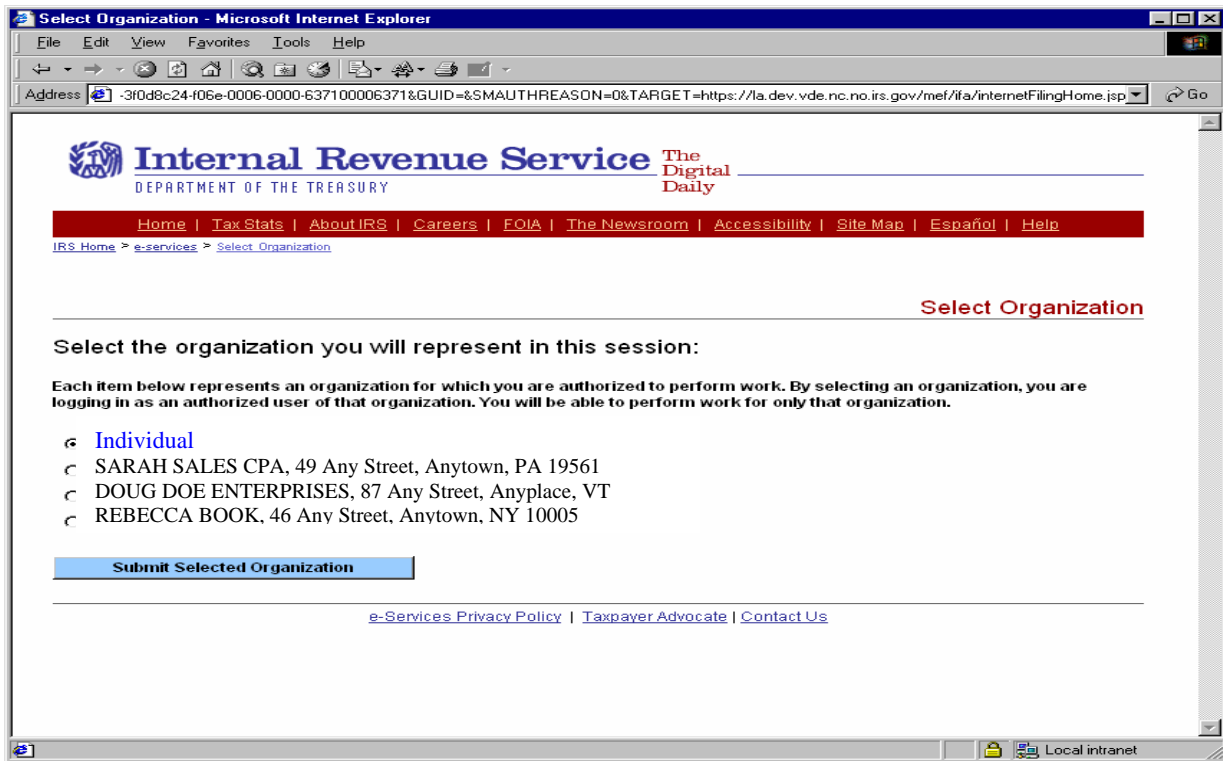

Figure 4-8: Organization Selection Screen

Step 9: Once you select the organization, the MeF Internet Filing Home Page displays. You may transmit a production or test file by selecting the corresponding link. It is important to note that all tax returns and/or extensions in a transmission file must be either production files or test files. You are now ready to transmit the file to the IRS. Select the “Transmit Production File” or the “Transmit Test File” link from the MeF Internet Filing Home Page.

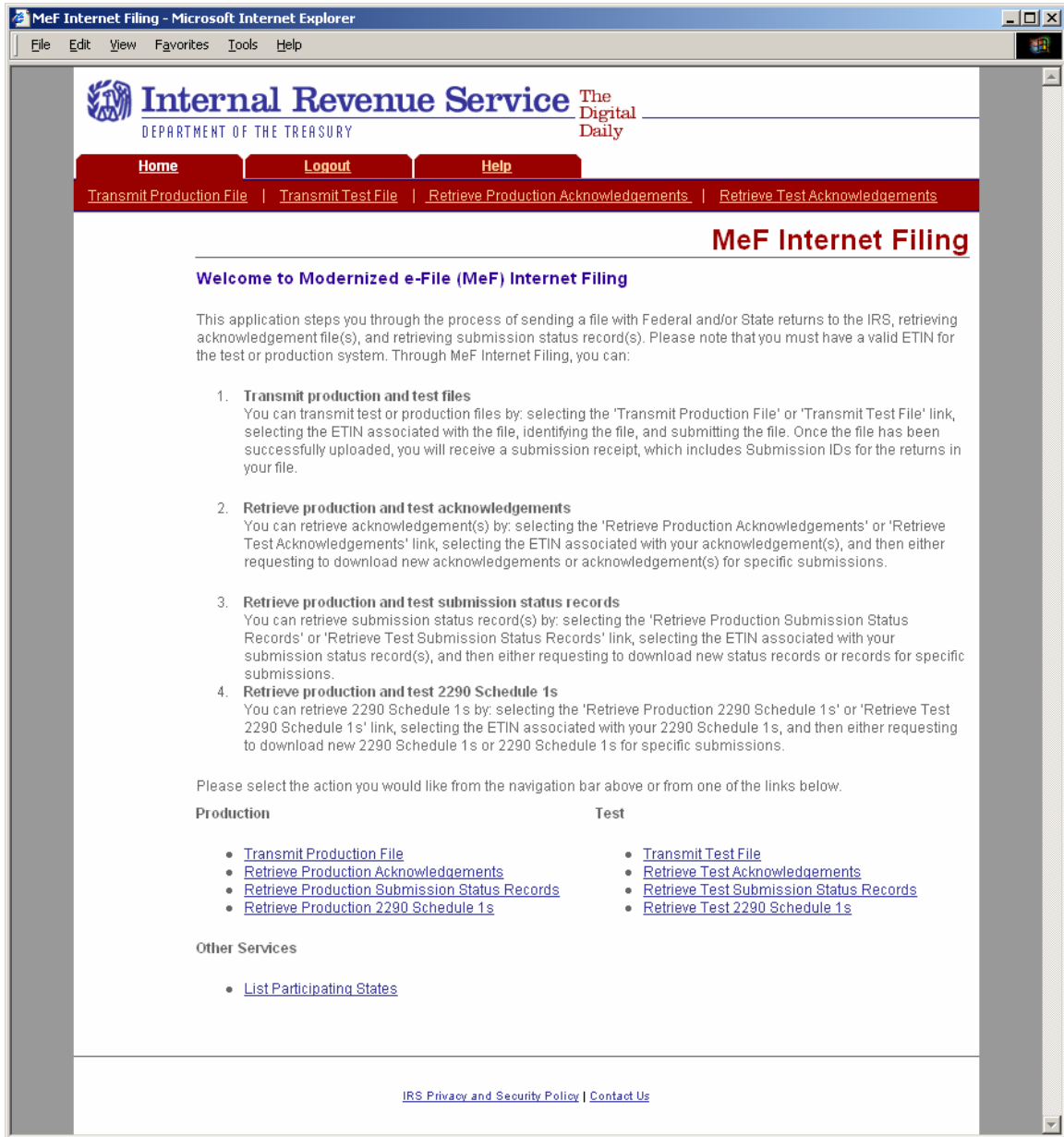

Figure 4-9: MeF Internet Filing Home Page

4.2.3 Submitting a Transmission File

Step 10: The organization for which you are transmitting may have multiple ETINs. Select the ETIN that applies to this transmission. The screen below is displayed if you selected “Transmit a Production File”.

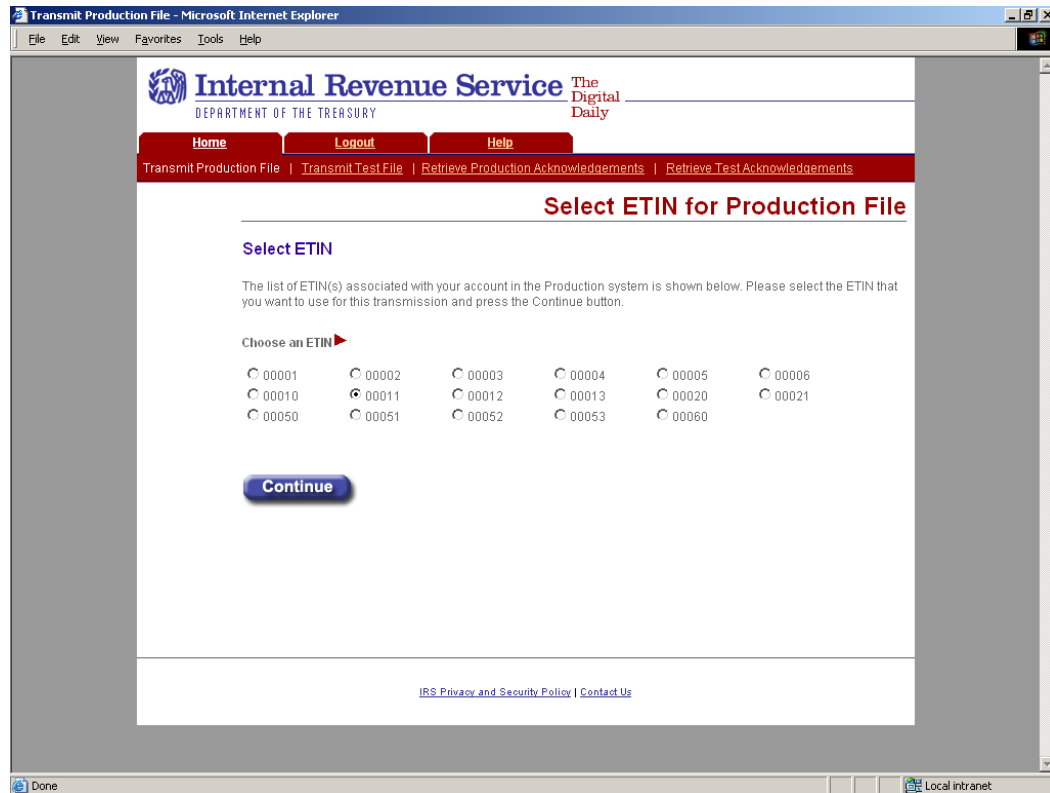

Figure 4-10: Select ETIN for Production Transmission File Page

Step 11: To submit a Production file, follow the instructions below.

- (1) Find the file that you want to upload by clicking the Browse button and selecting the appropriate file or by typing in the file name.
- (2) Click the submit button

NOTE: The transmission file is posted using HTTP SSL.

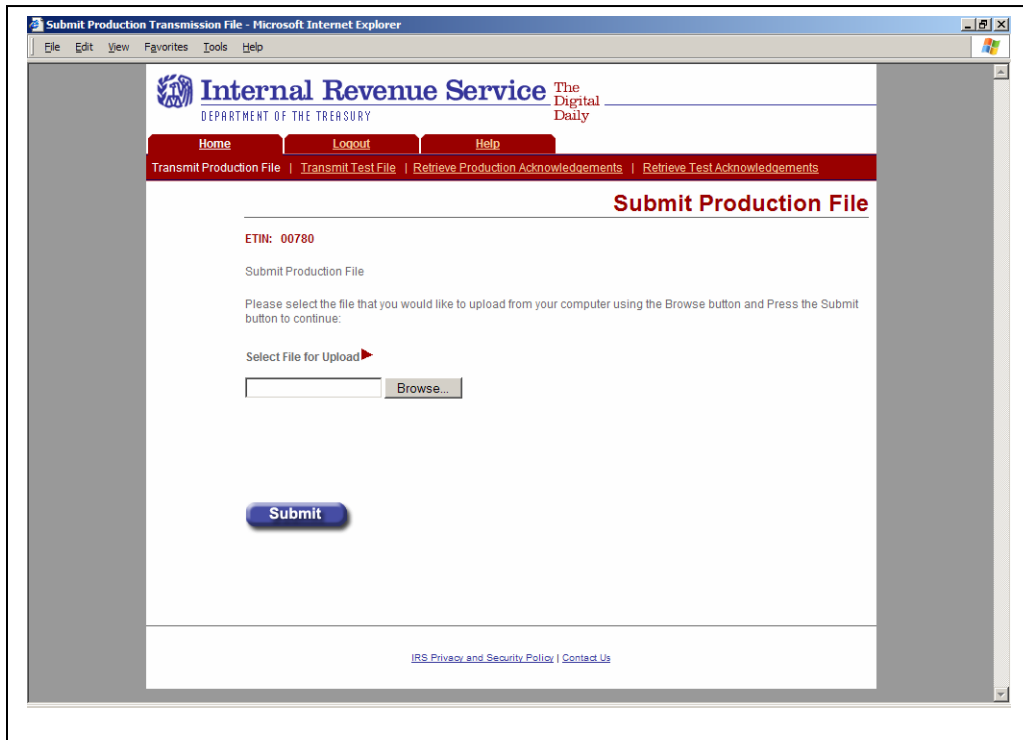

Figure 4-11: Submit Production Message File Page

The system provides you with an upload status page that monitors the progress of the transmission. The window also displays server-side processing steps, which are periodically updated and checked once the processing has been completed. File Upload, Decompression, Virus Check, and Preliminary Validation. Four checks are done during Preliminary Validation – (1) the ETIN selected matches the ETIN in the transmission header, (2) the production/test type selected matches the production/test transmission type in the file, (3) the number of submissions in the file equals the count indicated in the file, and (4) the number of submissions does not exceed the maximum allowed (which is 100). Once the transmission has finished, the system asks you to close the window. It is important to note that the browser that spawns this pop-up window is locked preventing you from navigating to other web pages until the download is complete.

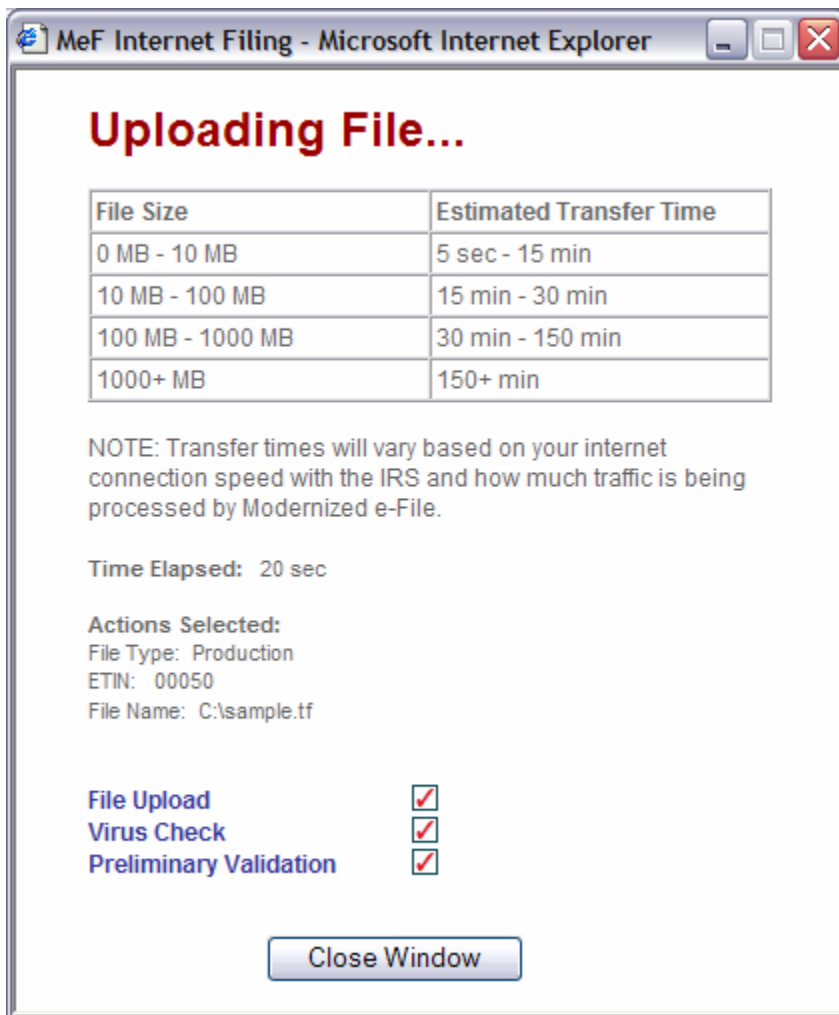

Figure 4-12: Upload Status Screen

If the file uploads successfully, IFA displays a Transmission Receipt (also known as a GTX Key) containing the Submission IDs for each return in the file. It is highly recommended that you print and retain a copy of this receipt page. This page just indicates that the IRS received the file. You must wait for the Acknowledgement to determine if the return was actually accepted or rejected.

Click the **Home** tab on the navigation bar or click **Back to MeF Internet Filing Home** to return to the MeF Internet Filing Home page.

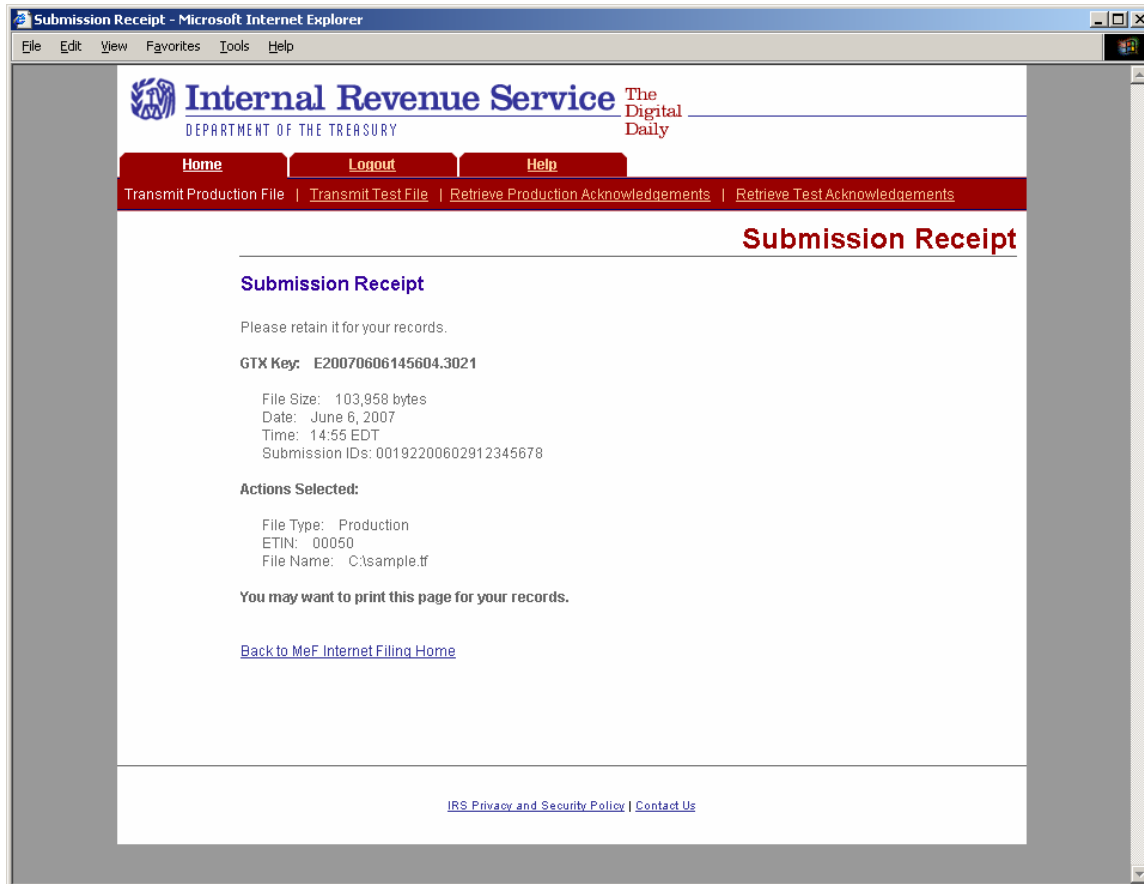

Figure 4-13: Submission Receipt Page

Logging Out of MeF IFA

To logout of MeF IFA, click the **Logout tab** followed by the Logout button.

Click **Home** on the navigation bar or click **Back to MeF Internet Filing Home** to return to the MeF Internet Filing Home page.

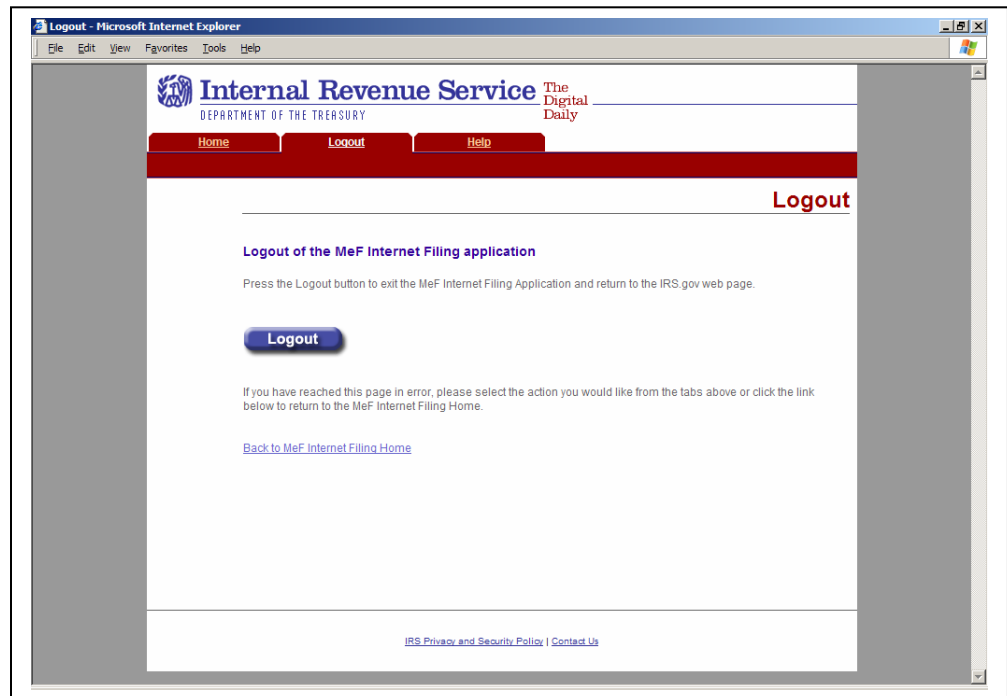

Figure 4-14: MeF Internet Filing Application Logout Page

4.2.4 MeF Internet Filing Error Conditions

During the process of uploading a file, the transmitter may encounter an error. The actions or values selected during the upload are displayed. You may want to print the error page(s) encountered.

No File Found Error

This error page displays when the user uploads a file with JavaScript disabled.

Click the **Home** tab on the navigation bar or click **Back to MeF Internet Filing Home** to return to the MeF Internet Filing Home page.

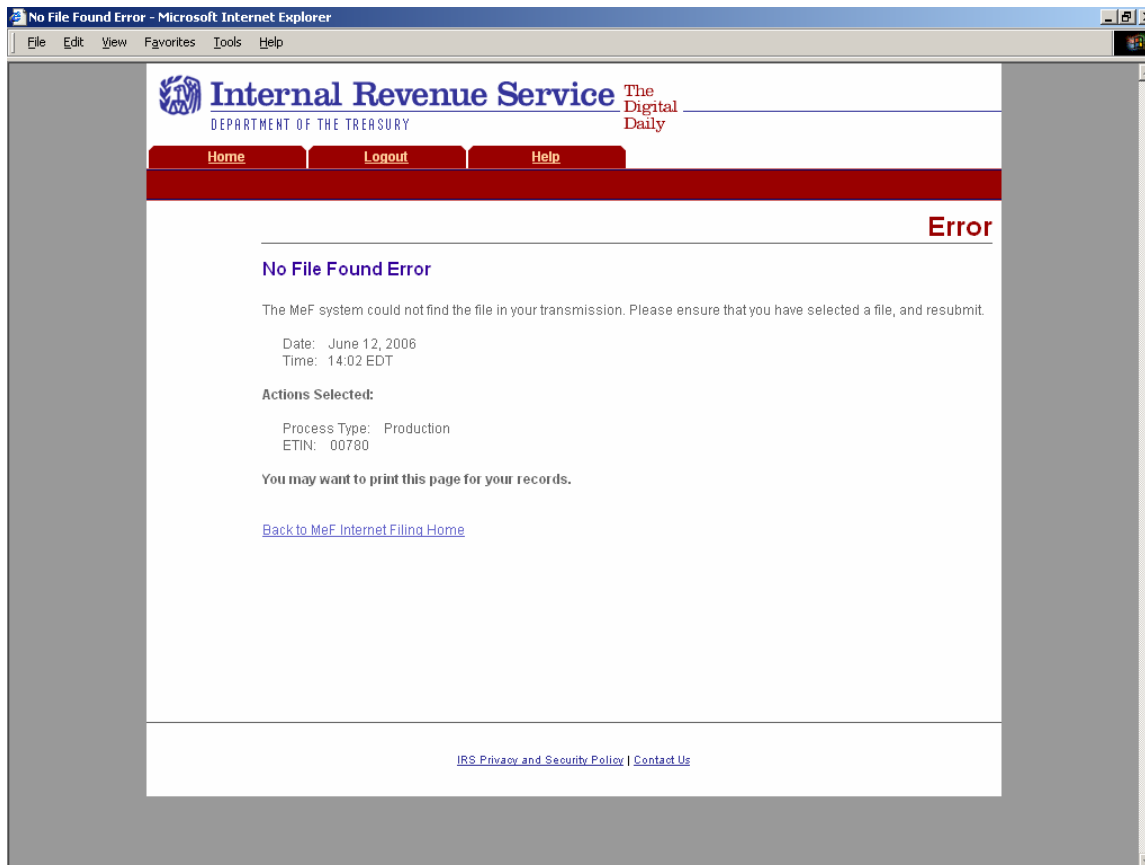

Figure 4-15: No File Found Error Page

If the system does not find an associated ETIN for the status you selected, then the following error message displays. Check that you selected the appropriate link – you may have selected “Production” and only have test ETINs. You may go back to the MeF Internet Filing Home Page or terminate the session.

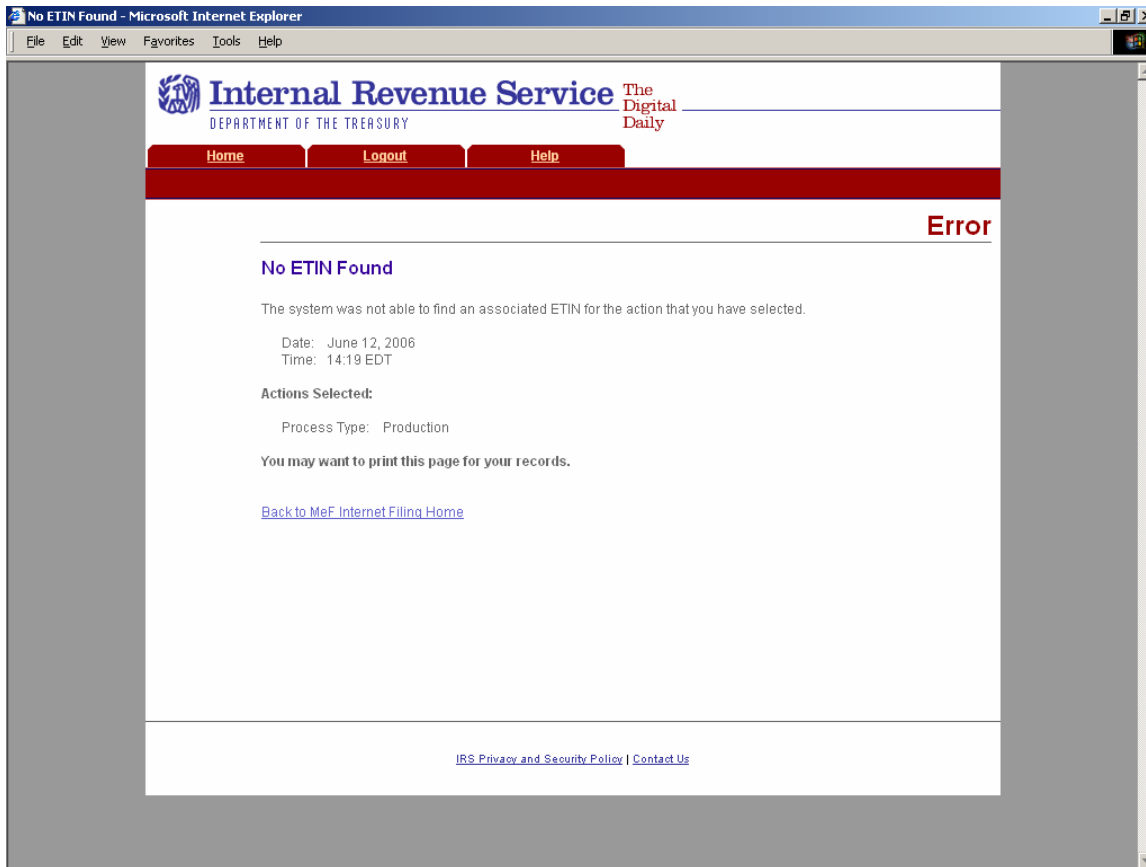

Figure 4-16: No ETIN Found Error Page

Virus Detected Error

If a virus is detected in the file, the system deletes the file and displays an error screen, which will include the name of the virus. You may go back to the MeF Internet Filing Home Page or terminate the session. (See [Section 4.4](#) for more information on virus detection).

Click the **Home** tab on the navigation bar or click **Back to MeF Internet Filing Home** to return to the MeF Internet Filing Home page.

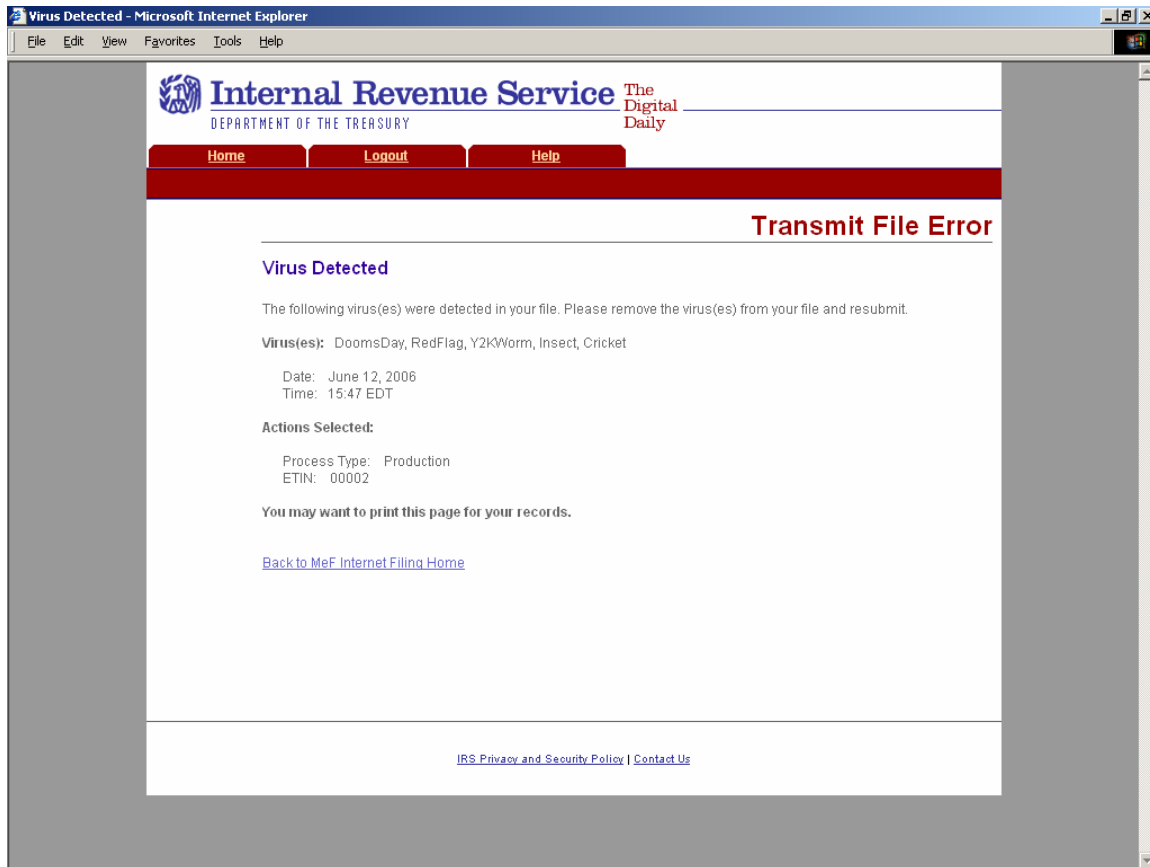

Figure 4-17: Virus Detected Page

File Upload Error Pages

If an X is displayed during the file upload process you will receive an error page..

File Upload Failed

When the file upload can't be completed, IFA rejects the file and automatically displays an error page indicating the type of problem encountered.

- Click the **Home** tab on the navigation bar or click **Back to MeF Internet Filing Home** to return to the MeF Internet Filing Home page.

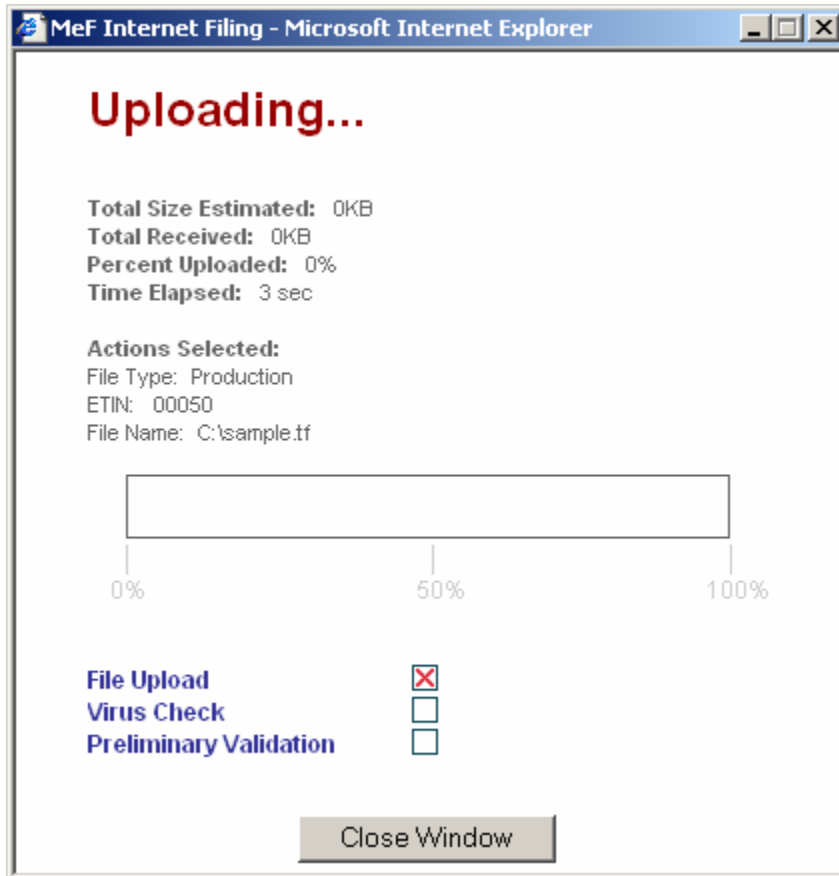

Figure 4-18: Upload Status Pop-up – Unsuccessful File Upload

File Error (Unable to Process XML)

If a successfully uploaded file contains malformed XML (e.g., a bracket may be missing, an element may be missing, etc.), the system rejects the file and displays the following error page.

Click the **Home** tab on the navigation bar or click **Back to MeF Internet Filing Home** to return to the MeF Internet Filing Home page.

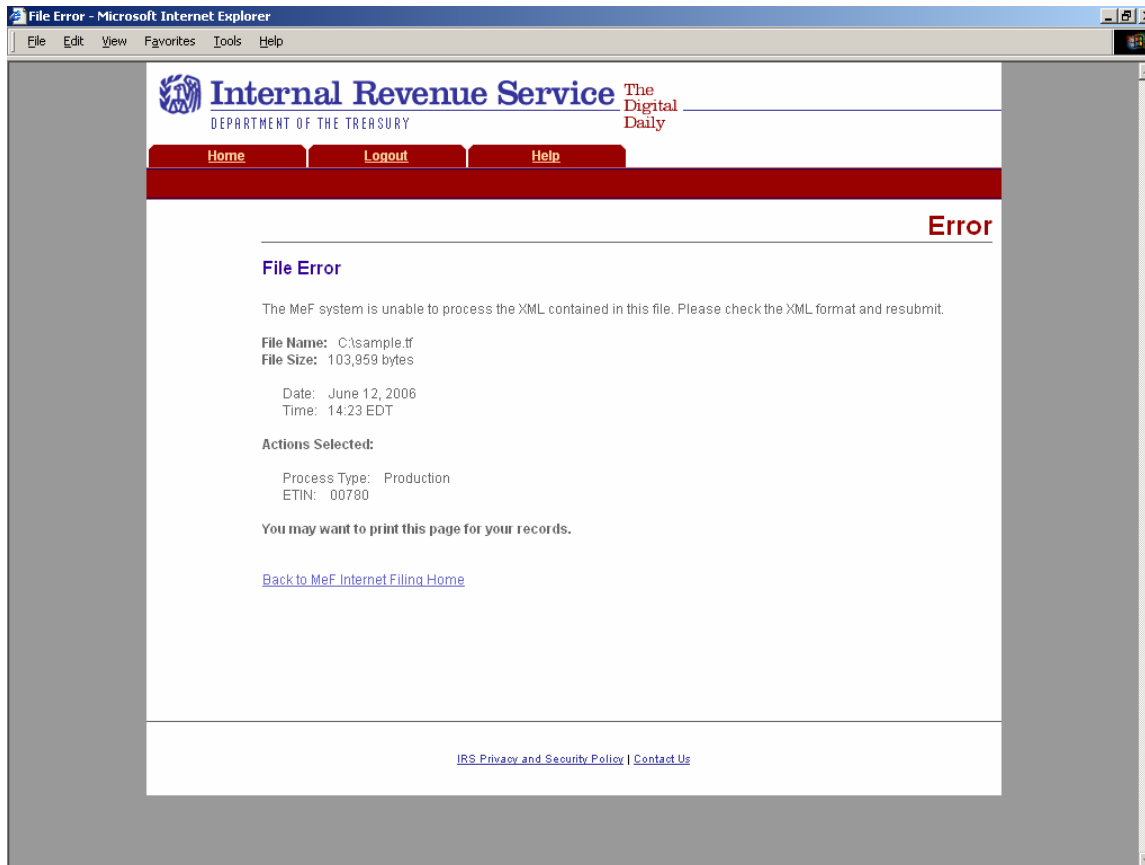

Figure 4-19: File Error Page – Unable to Process XML

ETIN Mismatch Error

If the user selected ETIN does not match the ETIN in the file , IFA rejects the file and displays the following error message. Check the value for the Selected ETIN and Transmission ETIN to see if there is a mismatch. In the example shown below, the Selected ETIN is 00078 but the Transmission ETIN is 00021 so the transmission was rejected.

- Click the **Home** tab on the navigation bar or click **Back to MeF Internet Filing Home** to return to the MeF Internet Filing Home page.

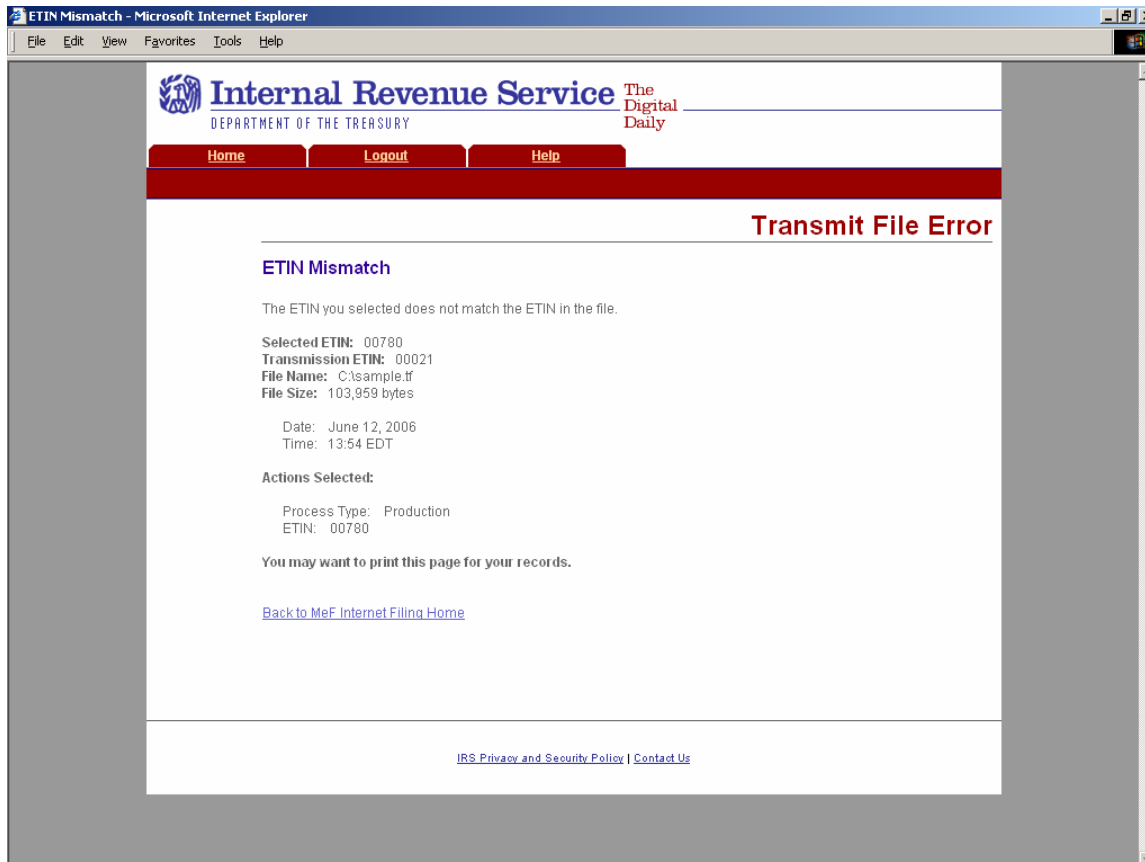

Figure 4-20: Transmit File Error Page – ETIN Mismatch

Number of Submissions Submitted Exceeds Maximum Error

If the number of submissions within the file exceeds the configurable limit which is 100, IFA rejects the file and displays the following error page.

Click the **Home** tab on the navigation bar or click **Back to MeF Internet Filing Home** to return to the MeF Internet Filing Home page.

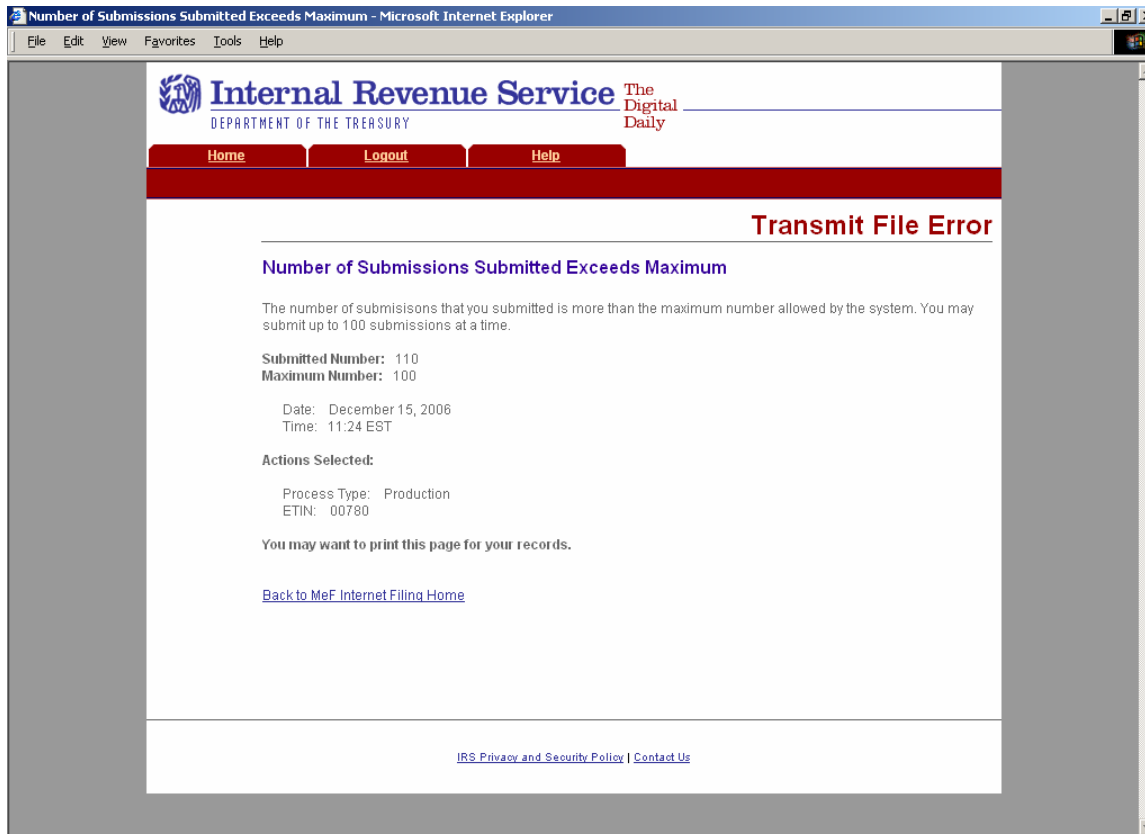

Figure 4-21: Transmit File Error Page – Number of Submissions Submitted Exceeds Maximum

Submission Number Mismatch Error

If the number of submissions in the file does not match the number of submissions specified in the file, IFA displays the following error page.

Click the **Home** tab on the navigation bar or click **Back to MeF Internet Filing Home** to return to the MeF Internet Filing Home page.

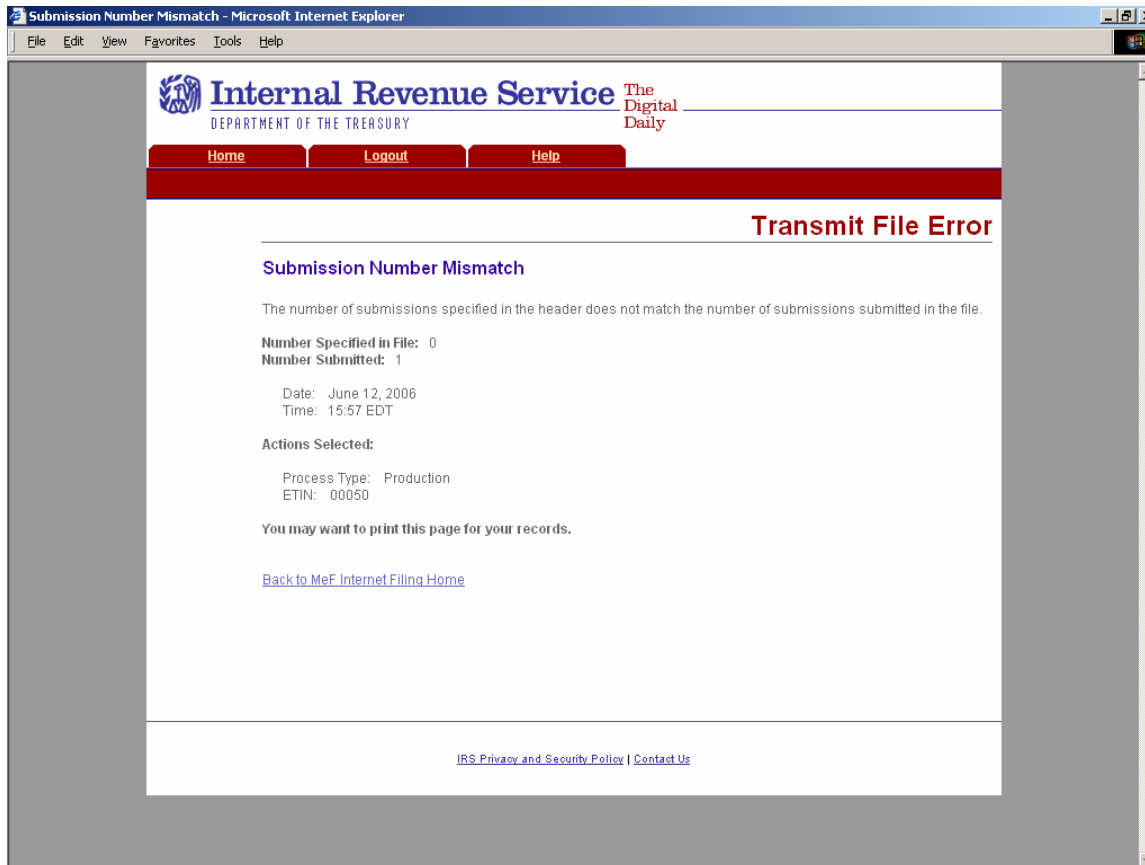

Figure 4-22: Transmit File Error Page – Submission Number Mismatch

System Error (Transmit)

If the system encounters a problem and cannot transfer and store the file, the system displays the following error message and asks the transmitter to resubmit the transmission file. Call the *e-Help* Desk (1-866-255-0654) if you continue to receive this message. You may want to print this page for reference.

Click the **Home** tab on the navigation bar or click **Back to MeF Internet Filing Home** to return to the MeF Internet Filing Home page.

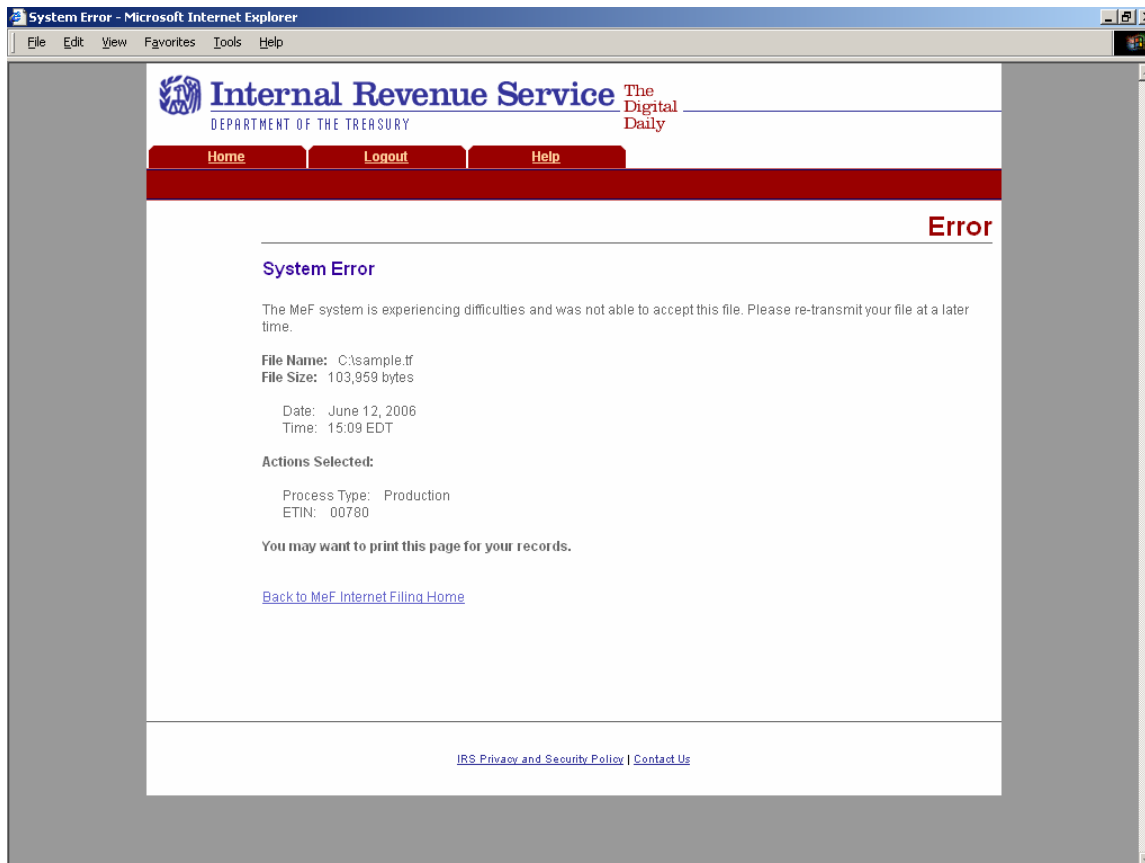

Figure 4-23: System Error Page

System Error (Transmit)

This error page displays for errors occurring when transmitting a file and the system was able to specify the error that occurred.

- Click the **Home** tab on the navigation bar or click **Back to MeF Internet Filing Home** to return to the MeF Internet Filing Home page.

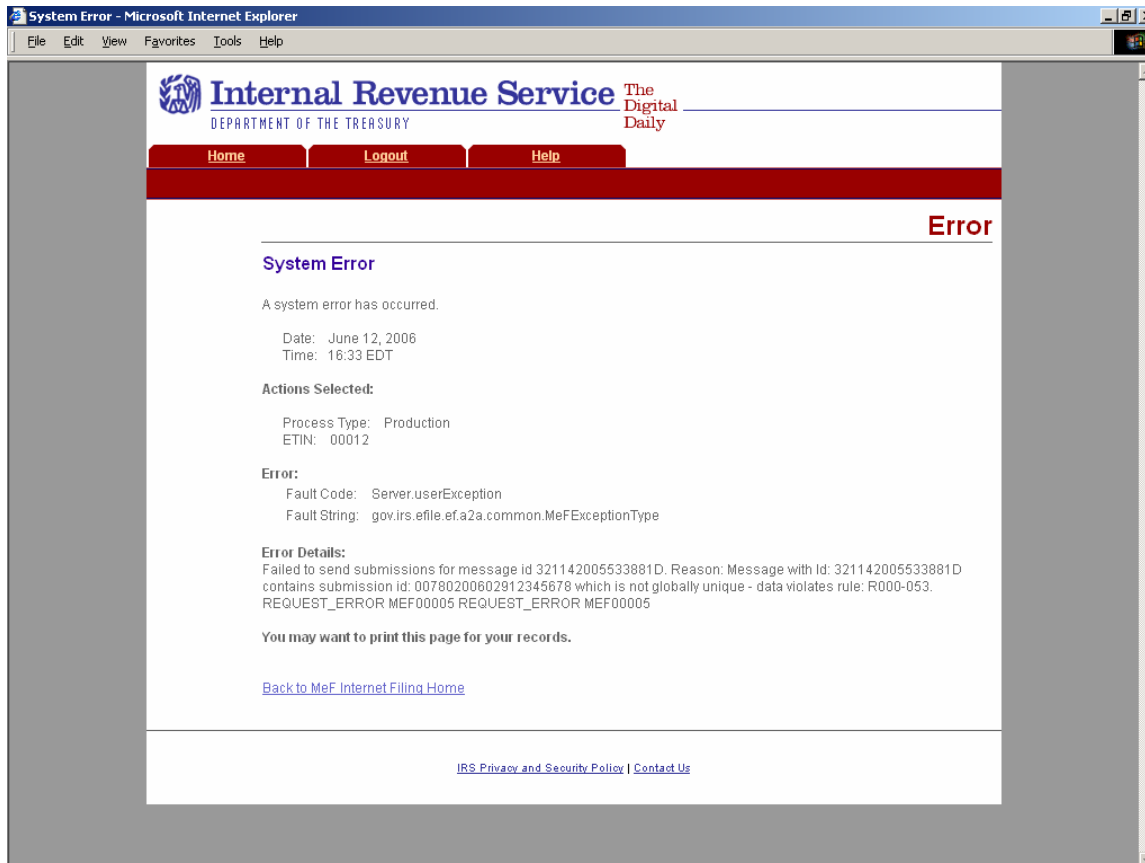

Figure 4-24: System Error Page with Error Specified

HELP TAB

Click the Help tab to access the MeF Internet Filing Help page. This page provides the phone numbers to call if you are experiencing problems. It also lists the names of all of the MeF publications.

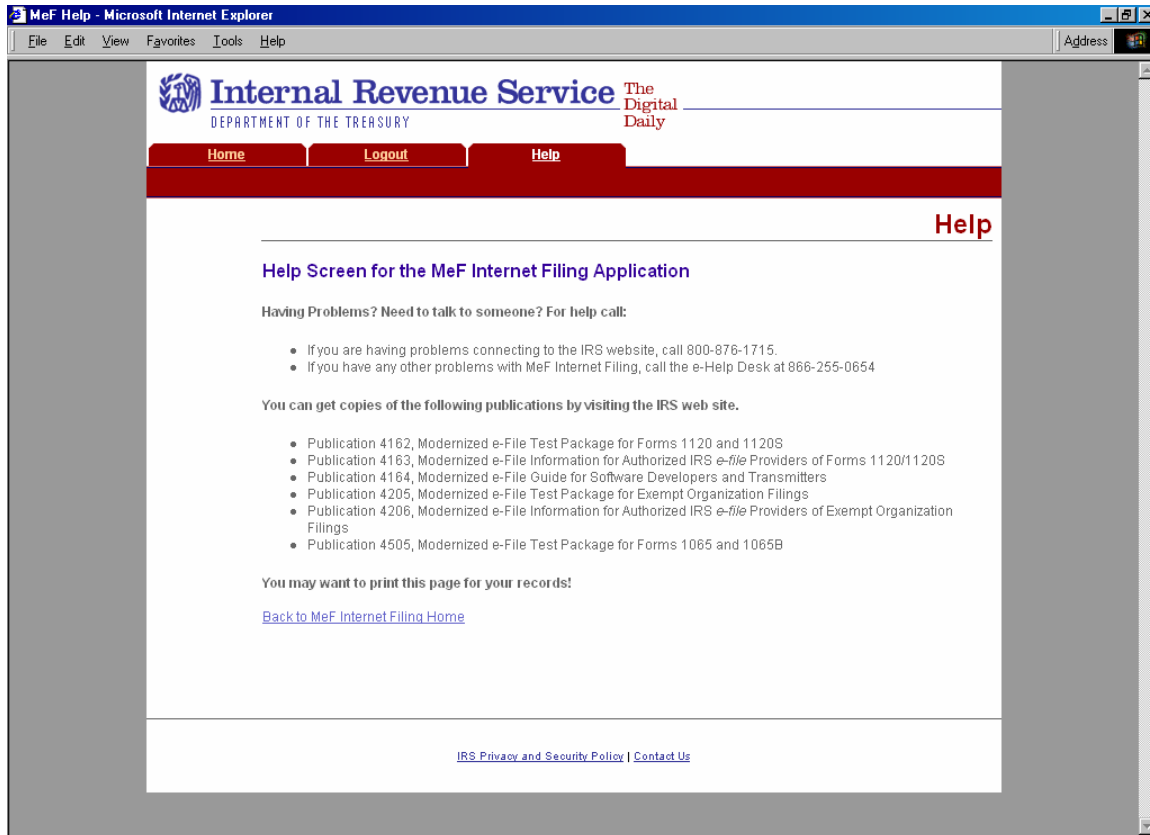

Figure 4-25: Help Screen for the MeF Internet Filing Application

4.2.5 Browsers and Operating Systems

The client-side browsers and operating systems that will be supported are listed in the following table.

BROWSER\PLATFORM	Windows XP Professional	Windows 2000 Professional
IE 6.0	Yes	Yes
Netscape 8.0	Yes	Yes
Mozilla 1.7	Yes	Yes

4.3 EMS No Longer Available for MeF

Modernized *e-File* (MeF) will not accept EMS transmissions after 12/27/2007. All transmissions must come through IFA or A2A after this date.

The Assurance Testing System (ATS) is available on November 5, 2007. All ATS testing must come through the IFA or A2A channels.

4.4 Detecting Viruses in MeF Transmissions

4.4.1 Through Internet Filing

All files being transmitted through IFA will be scanned for viruses. In the event the system detects a virus in the transmission file, the following steps will be taken:

- The transmission will be rejected and an error screen with the message “Virus Detected” will be displayed.
- The session will be terminated.
- The Transmitter must remove the infected data and then call the IRS *e-Help* Desk when they are ready to retransmit.

Please refer to Section 4.2.4, [Figure 4-17](#), which shows the error screen that will be displayed.

4.4.2 Through Application-to-Application (A2A)

All files being transmitted through A2A will be scanned for viruses. In the event the system detects a virus in the transmission file, the following steps will be taken:

- The transmission will be rejected and an error response will be returned.
- The Transmitter must remove the infected data and then retransmit the file.

.

5 Validating the Transmission and Return Data

This section explains how MeF will perform validations of the transmission and return data through business rules, schema validations, SOAP envelope validation, and Transmission Header and Manifest validation.

5.1 Business Rules (Categories/Severity)

The following section describes the business rules for MeF. The MeF business rules have been standardized to the extent possible across all tax returns participating in MeF. As additional tax returns migrate to the modernized architecture, their business rules will be rewritten so they will be standardized across all form types.

Business rules for the MeF forms will be posted to the irs.gov web pages found in the [MeF Contact Information Table 1.2](#).

The MeF business rules were written to be atomic; that is, they focus on one condition rather than more than one. They also do not reference sequence numbers, but reference form and line numbers and element names.

The following error information will be provided in your business rule acknowledgement file:

1. **Rule Number** - Each MeF business rule has a number that uniquely identifies the business rule within the MeF system. The rule number consists of a letter identifying the type of return document the rule applies (form, return, transmission, schema, schedule, payment), the form number that owns the rule, followed by the number of the rule within the form.

<i>Identifier</i>	<i>Rule Type</i>
F	Form
R	Return
T	Transmission
X	XML
S	Schedule
FPYMT	Payment

2. **Error Message** - This element provides the description of the rule.
3. **Error Category** - All MeF business rules are divided into 12 error categories. The following eight categories validate the XML data:
 - **Multiple Document** – more than the required number of documents are included in the tax return. The maxOccurs attribute in the ReturnData restricts the allowable number of the XML document within the tax return. In the cases where the number of documents is restricted by form and/or line, the number of times the XML document can occur will be restricted by a business rule and the maxOccurrence in the ReturnData will be set to ‘unbounded’.

- For example, only one Form 3468 can be attached to each 1120 and 8865. Since more than one 8865 can be attached to the tax return, more than one 3468 may exist in the tax return. Therefore, in the ReturnData1120, maxOccurs="unbounded" and a business rule for each form will exist restricting the number of 3468s that can be attached to each form.
- Missing Document – a tax return document is required but was not included in the tax return.
- Data Mismatch – the data in two fields should be the same but is not. For example, if Form 1120, Line D does not equal Form 1120, Schedule L, Line 15d, then you will receive error F1120-258:
 - If Form 1120, Schedule L is present, Form 1120, Item D “Total Assets” must equal Form 1120, Schedule L, Line 15d.
- Duplicate Condition – the tax return or the transmission file was previously received and accepted by the IRS.
- Math Error – the result of a computation is incorrect.
- Incorrect Data – data violates a business rule even though it is syntactically correct. That is, the data values for elements must conform to the format specified and the data type. Also, the data values for elements must contain only values allowed for them in the schema. For example, if Form 6478, Line 1(a) came in with a value of 20 million, you will receive the error F6478-002:
 - If Form 6478, Line 1(a) has a value, then the value must be greater than or equal to 0 (zero) and less than or equal to 15000000 (fifteen million).
- Missing Data – data is not provided for a required field.
- Database Validation Error – data provided does not match the IRS database or the data provided should be present in the IRS database but is not. (e.g. the Electronic Filing Identification Number (EFIN) in the Return Header must be listed in the MeF database and in accepted status.)

The following are the remaining three categories for all return types:

- XML Error – the data violates Schema specification. The return and transmission documents must conform to the version of the XML schema they specify.
- System Error – a return encounters a problem with the IRS systems that prevents the return from being processed electronically.
- Unsupported – a submitted item(s) is sent to a location that does not accept it or an unusual condition is encountered in the data.

The following apply to 7004 and Exempt Organization returns only:

- Not On Time – a document is received after the due date.

4. **Severity** - When a business rule is violated, one of the following severity levels will be issued:

- Reject – the tax return is rejected; however, MeF will continue processing the tax return until 100 errors have occurred. You will need to send the tax return again with the errors corrected.
- Reject and Stop – this severity type will stop processing the return when this reject is encountered.

5. Data Value - Data value causing the violation - when appropriate.

Business Rules for Consolidated Returns

Conformance with XML schemas (format checks) will be performed at all levels of a consolidated return – top level consolidation, parent return and all subsidiary returns. But business rules are enforced only at the top level consolidated return. As an example, business rule SN-F1120-001 states “If Schedule N (Form 1120), Line 4a, has a choice of ‘Yes’ indicated, then Form 5471 must be attached.” MeF will look for the Form 5471 to be attached to the top level consolidated 1120. If Form 5471 is attached to a Parent or Subsidiary return, the validation will not pass, and a reject with rule SN-F1120-001 will be returned in the acknowledgement file.

5.2 Validating Transmission File

Once the transmission file is received from IFA or A2A, the MeF system must validate the transmission header before it validates the returns inside. Transmission validation consists of two parts:

1. SOAP envelope validation. SOAP envelope validation ensures transmission file format integrity and that the SOAP header, body, and MIME segments exist and are located in the proper place. If transmission file fails SOAP envelope validation, the entire transmission, including all returns, is rejected.
2. Transmission/Message Header and Manifest validation. Next the transmission/message header and manifest are validated. The transmission/message header provides some summary information about the file, such as Transmission ID, Message ID, ETIN, and timestamp. [Note: The time zone component of the timestamp element is a required data element in the Transmission Manifest. Where there is a timestamp element there must be a time zone component included.] The manifest contains the submission count and SubmissionID of each submission in the transmission file.
 - It is important to note that the Submission ID:
 - should not be a duplicate of another SubmissionID
 - should contain the Electronic Return Originator's EFIN
 - EFIN should be the same as the EFIN in the return header.
 - YYYY in the SubmissionID must be the current processing year. Any submission sent to the IRS in 2008 must have “2008” in the “YYYY” value of the SubmissionID.

Note - When a transmission is rejected, you will not receive an acknowledgement for individual submissions within the transmission. All submissions must be resubmitted.

Transmission Header and Transmission Manifest

```
?xml version="1.0" encoding="UTF-8" ?>
<xsd:schema targetNamespace="http://www.irs.gov/efile" xmlns:xsd="http://www.w3.org/2001/XMLSchema"
  xmlns="http://www.irs.gov/efile" elementFormDefault="qualified" attributeFormDefault="unqualified"
  version="1.0">
  <xsd:annotation>
  <xsd:documentation>
  <description>IRS e-file - Content models for the common transmission/ack file definitions</Description>
  <aturityLevel>Draft Release</MaturityLevel>
  <eleaseDate>October 23, 2006</ReleaseDate>
  </xsd:documentation>
  </xsd:annotation>
  <xsd:include schemaLocation="efileTypes.xsd" />
  <!-- Submission ID Type - 20 digits (EFIN + ccyydd + 7-character lower case alphanumeric) -->
  <xsd:simpleType name="SubmissionIdType">
  <xsd:restriction base="xsd:string">
  <xsd:pattern value="[0-9]{13}[a-z0-9]{7}" />
  </xsd:restriction>
  </xsd:simpleType>
  <xsd:complexType name="SubmissionDataType">
  <xsd:sequence>
  <xsd:element name="SubmissionId" type="SubmissionIdType" />
  <xsd:element name="ElectronicPostmark" type="TimestampType" />
  </xsd:sequence>
  </xsd:complexType>
  <xsd:complexType name="SubmissionDataListType">
  <xsd:sequence>
  <xsd:element name="Count" type="xsd:positiveInteger" />
  <xsd:element name="SubmissionData" type="SubmissionDataType" minOccurs="1" maxOccurs="unbounded" />
  </xsd:sequence>
  </xsd:complexType>
  <xsd:element name="TransmissionManifest">
  <xsd:complexType>
  <xsd:sequence>
  <xsd:element name="SubmissionDataList" type="SubmissionDataListType" />
  </xsd:sequence>
  </xsd:complexType>
  </xsd:element>
  </xsd:schema>
```

Figure 5-1: efileMessageCommon.xsd Schema

```

<?xml version="1.0" encoding="UTF-8" ?>
<xsd:schema targetNamespace="http://www.irs.gov/efile" xmlns:xsd="http://www.w3.org/2001/XMLSchema"
  xmlns="http://www.irs.gov/efile" elementFormDefault="qualified" attributeFormDefault="unqualified" version="1.0">
  <xsd:annotation>
  <xsd:documentation>
  <Description>IRS e-file - Content models for the IFA transmission file definitions</Description>
  <MaturityLevel>Draft Release</MaturityLevel>
  <ReleaseDate>October 19, 2007</ReleaseDate>
  </xsd:documentation>
  </xsd:annotation>
  <xsd:include schemaLocation="efileTypes.xsd" />
  <xsd:include schemaLocation="efileMessageCommon.xsd" />
  - <!-- Transmission Header -->
  <xsd:element name="TransmissionHeader" type="TransmissionHeaderType" />
  <xsd:complexType name="TransmissionHeaderType">
  <xsd:sequence>
  - <!-- Message ID -->
  <xsd:element name="MessageId" type="MessageIdType">
  <xsd:annotation>
  <xsd:documentation>Must be unique for the transmitter for the tax year</xsd:documentation>
  </xsd:annotation>
  </xsd:element>
  - <!-- Transmission Time Stamp -->
  <xsd:element name="Timestamp" type="TimestampType" minOccurs="0">
  <xsd:annotation>
  <xsd:documentation>The time stamp at the time of transmission.</xsd:documentation>
  </xsd:annotation>
  </xsd:element>
  - <!-- Transmitter -->
  <xsd:element name="Transmitter">
  <xsd:complexType>
  <xsd:sequence>
  <xsd:element name="ETIN" type="ETINType">
  <xsd:annotation>
  <xsd:documentation>The ETIN of the transmitter</xsd:documentation>
  </xsd:annotation>
  </xsd:element>
  </xsd:sequence>
  </xsd:complexType>
  </xsd:element>
  </xsd:sequence>
  </xsd:complexType>
  - <!-- Message ID Type - 20 digits (ETIN + ccyddd + 8-character lower case alphanumeric) -->
  <xsd:simpleType name="MessageIdType">
  <xsd:restriction base="xsd:string">
  <xsd:pattern value="[0-9]{12}[a-z0-9]{8}" />
  </xsd:restriction>
  </xsd:simpleType>
  </xsd:schema>

```

Figure 5-2: efileMessageIFA Schema

```

<?xml version="1.0" encoding="UTF-8"?>
<xsd:schema targetNamespace="http://www.irs.gov/efile"
xmlns:xsd="http://www.w3.org/2001/XMLSchema" xmlns="http://www.irs.gov/efile"
elementFormDefault="qualified" attributeFormDefault="unqualified" version="1.0">
  <xsd:annotation>
    <xsd:documentation>
      <Description>IRS e-file - MeF Message Attachment
Structures</Description>
      <MaturityLevel>Final Release</MaturityLevel>
      <ReleaseDate>February 2, 2007</ReleaseDate>
    </xsd:documentation>
  </xsd:annotation>
  <xsd:include schemaLocation="efileTypes.xsd"/>
  <!-- ===== ATTACHMENTS TO MESSAGES ===== -->
  <!-- IRS Submission Manifest -->
  <xsd:element name="IRSSubmissionManifest">
    <xsd:complexType>
      <xsd:sequence>
        <!-- Common Submission/Acknowledgement Elements -->
        <xsd:group ref="CommonSubmissionAndAcknowledgementElements"/>
      </xsd:sequence>
    </xsd:complexType>
  </xsd:element>
  <!-- State Submission Manifest -->
  <xsd:element name="StateSubmissionManifest">
    <xsd:complexType>
      <xsd:sequence>
        <!-- Common Submission/Acknowledgement Elements -->
        <xsd:group ref="CommonSubmissionAndAcknowledgementElements"/>
        <!-- Submission Category - Identifies the submission category, for example EO
or Corporate submission -->
        <xsd:element name="SubmissionCategory" type="SubmissionCategoryType"/>
        <!-- Federal EIN -->
        <xsd:element name="FederalEIN" minOccurs="0">
          <xsd:simpleType>
            <xsd:restriction base="NumericType">
              <xsd:length value="9" />
            </xsd:restriction>
          </xsd:simpleType>
        </xsd:element>
        <!-- Name Control -->
        <xsd:element name="NameControl" type="BusinessNameControlType" minOccurs="0"/>
        <!-- IRS Submission ID - (Optional) The submission ID of an IRS submission
that the processing of this state submission depends on -->
        <xsd:element name="IRSSubmissionId" type="SubmissionIdType" minOccurs="0"/>
      </xsd:sequence>
    </xsd:complexType>
  </xsd:element>
  <!-- Submission Receipt List -->
  <xsd:element name="SubmissionReceiptList">
    <xsd:complexType>
      <xsd:sequence>
        <xsd:element name="Count" type="IntegerNNTType"/>
        <!-- Submission Receipt -->
        <xsd:element name="SubmissionReceipt" minOccurs="0" maxOccurs="unbounded">
          <xsd:complexType>
            <xsd:sequence>
              <!-- SubmissionID-The submission ID of the received submission -->
              <xsd:element name="SubmissionId" type="SubmissionIdType"/>
              <!-- Timestamp - The date and time the submission was received -->
              <xsd:element name="Timestamp" type="TimestampType"/>
            </xsd:sequence>
          </xsd:complexType>
        </xsd:element>
      </xsd:sequence>
    </xsd:complexType>
  </xsd:element>

```

```

        </xsd:complexType>
    </xsd:element>
</xsd:sequence>
</xsd:complexType>
</xsd:element>
<!-- Acknowledgement -->
<xsd:element name="Acknowledgement">
    <xsd:complexType>
        <xsd:sequence>
            <!-- Common Submission/Acknowledgement Elements -->
            <xsd:group ref="CommonSubmissionAndAcknowledgementElements"/>
            <!-- Submission Category - Identifies the submission category, for example EO
or Corporate substrate submission -->
            <xsd:element name="SubmissionCategory" type="SubmissionCategoryType"/>
            <!-- Electronic Postmark -->
            <xsd:element name="ElectronicPostmark" type="TimestampType" minOccurs="0"/>
            <!-- Filing Status - Filing status of the submission -->
            <xsd:element name="FilingStatus" type="StringType"/>
            <!-- Status Date - The date the filing status was acknowledged -->
            <xsd:element name="StatusDate" type="DateType"/>
            <!-- IRS Submission ID - The submission ID of an IRS submission that the
processing of this state submission depends on -->
            <xsd:element name="IRSSubmissionId" type="SubmissionIdType" minOccurs="0"/>
            <!-- State Submission Copy Count - The number of copies made of an IRS
submission (only for EO currently) -->
            <xsd:element name="StateSubmissionCopyCount" type="IntegerNNType"
minOccurs="0"/>
            <!-- EIN - The EIN of the filer -->
            <xsd:element name="EIN" type="EINType" minOccurs="0"/>
            <!-- Filing Type Description - For applications for extension, the type of
return for which the filing time is being extended -->
            <xsd:element name="FilingTypeDescription" type="StringType" minOccurs="0"/>
            <!-- Tax Period End Date -->
            <xsd:element name="TaxPeriodEndDate" type="DateType" minOccurs="0"/>
            <!-- Payment Indicator -->
            <xsd:element name="PaymentIndicator" minOccurs="0">
                <xsd:simpleType>
                    <xsd:restriction base="StringType">
                        <xsd:enumeration value="Payment Request Received"/>
                    </xsd:restriction>
                </xsd:simpleType>
            </xsd:element>
            <!-- Completed Validation - (Y/N) Indicates whether the submission went
through all possible validation processing -->
            <xsd:element name="CompletedValidation" type="BooleanType" minOccurs="0"/>
            <!-- Embedded CRC32 -->
            <xsd:element name="EmbeddedCRC32" minOccurs="0">
                <xsd:annotation>
                    <xsd:documentation>
                        <Description>Embedded CRC32</Description>
                    </xsd:documentation>
                </xsd:annotation>
                <xsd:simpleType>
                    <xsd:restriction base="xsd:string">
                        <xsd:maxLength value="10" />
                        <xsd:pattern value="0x[0-9A-Fa-f]{1,8}" />
                    </xsd:restriction>
                </xsd:simpleType>
            </xsd:element>
            <!-- Computed Checksum -->
            <xsd:element name="ComputedCRC32" minOccurs="0">
                <xsd:annotation>
                    <xsd:documentation>
                        <Description>Computed CRC32</Description>
                    </xsd:documentation>
                </xsd:annotation>
            </xsd:element>
        </xsd:sequence>
    </xsd:complexType>
</xsd:element>

```

```

        </xsd:annotation>
        <xsd:simpleType>
            <xsd:restriction base="xsd:string">
                <xsd:maxLength value="10" />
                <xsd:pattern value="0x[0-9A-Fa-f]{1,8}" />
            </xsd:restriction>
        </xsd:simpleType>
    </xsd:element>
    <!-- Taxable Income -->
    <xsd:element name="TaxableIncome" type="USAmountType" minOccurs="0" />
    <!-- Total Tax -->
    <xsd:element name="TotalTax" type="USAmountNNType" minOccurs="0" />
    <!-- Error List -->
    <xsd:element name="ErrorList" type="ValidationErrorListType" minOccurs="0"/>
</xsd:sequence>
<!-- Submission Version -->
<xsd:attribute name="submissionVersion" type="StringType" use="optional"/>
<!-- Validating Schema Version -->
<xsd:attribute name="validatingSchemaVersion" type="StringType" use="optional"/>
</xsd:complexType>
</xsd:element>
<!-- Acknowledgement List -->
<xsd:element name="AcknowledgementList">
    <xsd:complexType>
        <xsd:sequence>
            <xsd:element name="Count" type="IntegerNNType"/>
            <xsd:element ref="Acknowledgement" minOccurs="0" maxOccurs="unbounded"/>
        </xsd:sequence>
    </xsd:complexType>
</xsd:element>
<!-- Status Record List -->
<xsd:element name="StatusRecordList">
    <xsd:complexType>
        <xsd:sequence>
            <xsd:element name="Count" type="IntegerNNType"/>
            <!-- Status Record -->
            <xsd:element name="StatusRecord" minOccurs="0" maxOccurs="unbounded">
                <xsd:complexType>
                    <xsd:sequence>
                        <!-- Submission ID - The submission ID of the received submission -->
<xsd:element name="SubmissionId" type="SubmissionIdType"/>
                        <!-- Submission Status - The status of the received submission -->
<xsd:element name="SubmissionStatus" type="StringType"/>
                        <!-- Status Date - The date the submission status was acknowledged -->
                        <xsd:element name="StatusDate" type="DateType"/>
                    </xsd:sequence>
                </xsd:complexType>
            </xsd:element>
        </xsd:sequence>
    </xsd:complexType>
</xsd:element>

    </xsd:sequence>
</xsd:complexType>
</xsd:element>
<!-- Acknowledgement Notification -->
<xsd:element name="AckNotification">
    <xsd:complexType>
        <xsd:sequence>
            <!-- Submission ID - The submission ID of the acknowledgement that was
retrieved by the transmitter -->
            <xsd:element name="SubmissionId" type="SubmissionIdType"/>
            <!-- Timestamp - The date and time the acknowledgement was retrieved by the
transmitter -->
            <xsd:element name="Timestamp" type="TimestampType"/>
        </xsd:sequence>
    </xsd:complexType>
</xsd:element>

```

```

<!-- Acknowledgement Notification List -->
<xsd:element name="AckNotificationList">
  <xsd:complexType>
    <xsd:sequence>
      <xsd:element name="Count" type="IntegerNNTYPE"/>
      <xsd:element ref="AckNotification" minOccurs="0" maxOccurs="unbounded"/>
    </xsd:sequence>
  </xsd:complexType>
</xsd:element>
<!-- ===== COMMON ELEMENT GROUPS AND TYPES===== -->
<!-- Common Submission/Acknowledgement Elements -->
<xsd:group name="CommonSubmissionAndAcknowledgementElements">
  <xsd:sequence>
    <!-- Submission ID - The submission ID of the received submission -->
    <xsd:element name="SubmissionId" type="SubmissionIdType"/>
    <!-- EFIN -IRS-provided identifier for the originator of the submission-->
    <xsd:element name="EFIN" type="EFINTYPE"/>
    <!-- Government Code - Identifies the government where the submission is to be
filed -->
    <xsd:element name="GovernmentCode" type="GovernmentCodeType"/>
    <!-- Submission Type - Identifies the type of document being filed, using IRS
form numbers or State form identifiers -->
    <xsd:element name="SubmissionType">
      <xsd:simpleType>
        <xsd:restriction base="xsd:string">
          <xsd:maxLength value="15"/>
          <xsd:pattern value="[A-Za-z0-9\-\-]+"\>
        </xsd:restriction>
      </xsd:simpleType>
    </xsd:element>
    <!-- Tax Year - The tax year the submission applies to -->
    <xsd:element name="TaxYear" type="YearType"/>
  </xsd:sequence>
</xsd:group>
<!-- Type for Validation Error List -->
<xsd:complexType name="ValidationErrorListType">
  <xsd:sequence>
    <!-- Error -->
    <xsd:element name="Error" minOccurs="1" maxOccurs="unbounded">
      <xsd:complexType>
        <xsd:sequence>
          <!-- XPath - The location of the error in the XML data -->
          <xsd:element name="XPath" type="StringType" minOccurs="0"/>

          <!--Error Category-The IRS-defined category for the reported error -->
          <xsd:element name="ErrorCategory" type="StringType"/>
          <!-- Error Message - Text describing the error, usually the rule text -->
          <xsd:element name="ErrorMessage" type="StringType"/>
          <!-- Rule Number - The IRS-assigned number for the rule creating the error
-->
          <xsd:element name="RuleNumber" type="StringType"/>
          <!-- Severity - (Alert/Reject/Reject and Stop) Reject and Stop errors
cause validation of the submission to stop before any remaining validation rules are
executed -->
          <xsd:element name="Severity" type="StringType"/>
          <!-- Data Value - The value provided in the submission data for the
element used in the validation rule -->
          <xsd:element name="DataValue" type="StringType" minOccurs="0"/>
        </xsd:sequence>
        <xsd:attribute name="errorId" use="required">
          <xsd:simpleType>
            <xsd:restriction base="IntegerPosType">
              <xsd:totalDigits value="6"/>
            </xsd:restriction>
          </xsd:simpleType>
        </xsd:attribute>
      </xsd:complexType>
    </xsd:element>
  </xsd:sequence>
</xsd:complexType>

```

```

        </xsd:attribute>
    </xsd:complexType>
</xsd:element>
</xsd:sequence>
    <xsd:attribute name="errorCount" type="IntegerNNType" use="required"/>
</xsd:complexType>
<!-- Message ID Type - 20 digits (ETIN + ccyydd + 8-character lower case
alphanumeric) -->
    <xsd:simpleType name="MessageIdType">
        <xsd:restriction base="xsd:string">
            <xsd:pattern value="[0-9]{12}[a-z0-9]{8}"/>
        </xsd:restriction>
    </xsd:simpleType>
<!-- Submission ID Type - 20 digits (EFIN + ccyydd + 7-character lower case
alphanumeric) -->
    <xsd:simpleType name="SubmissionIdType">
        <xsd:restriction base="xsd:string">
            <xsd:pattern value="[0-9]{13}[a-z0-9]{7}"/>
        </xsd:restriction>
    </xsd:simpleType>
<!-- Submission Category Type -->
    <xsd:simpleType name="SubmissionCategoryType">
        <xsd:restriction base="xsd:string">
            <xsd:enumeration value="EO" />
            <xsd:enumeration value="CORP" />
            <xsd:enumeration value="PART" />
        </xsd:restriction>
    </xsd:simpleType>
<!-- Exception Category Type -->
    <xsd:simpleType name="ExceptionCategoryType">
        <xsd:restriction base="xsd:string">
            <xsd:enumeration value="SYSTEM_ERROR" />
            <xsd:enumeration value="RESOURCE_UNAVAILBLE" />
            <xsd:enumeration value="MESSAGE_FORMAT_ERROR" />
        </xsd:restriction>
    </xsd:simpleType>
</xsd:schema>

```

Figure 5-3: efileAttachment Schema

We validate the transmission header against business rules. Below are samples of transmission validation business rules. The complete list of business rules is found on each form's respective irs.gov website shown below.

Transmission Validation Business Rules

***Note:** The Tax Type includes all MeF forms (720, 2290, 8849, 1120, 1120-F, 1120S, 990, 990-EZ, 990-N, 990-PF, 1120-POL, 8868, 7004, 1065, 1065-B)

Rule Number	Rule Text	Error Category	Severity	Tax Type
T0000-001	The 'production' Modernized e-File system must not process transmission files whose 'process type' is set to 'T' (created for ATS testing)	Data Mismatch	Reject And Stop	*See Note
T0000-002	The 'test' Modernized e-File system must not process transmission files whose 'process type' is set to 'P'(created for production use)	Data Mismatch	Reject And Stop	*See Note
T0000-003	The number of returns indicated in the transmission manifest must equal the number of returns included in the transmission file.	Data Mismatch	Reject And Stop	*See Note

The complete list of validation rules for the transmission header and manifest can be found on the irs.gov website as follows:

- For 1120/1120-F/1120S/7004 - <http://www.irs.gov/taxpros/providers/article/0,,id=97626,00.html>.
- For 1065/1065-B – <http://www.irs.gov/efile/article/0,,id=153999,00.html>
- For 990/990-EZ/990-N/990-PF/1120-POL/8868 - <http://www.irs.gov/charities/article/0,,id=105955,00.html>
- For 720/2290/8849 - <http://www.irs.gov/efile/article/0,,id=169093,00.html>

For more information regarding validation of the transmission envelope, including its contents, you can refer to the, “*MeF Submission Composition Guide*”.

If the transmission validations (SOAP envelope, header and manifest) pass the validation check, the transmission is accepted and the system begins validating the returns contained in the transmission.

It is important that you run your transmission file through a validating parser to find any errors before transmitting.

5.3 Validating Tax Returns

Once the transmission file passes validation, the MeF system validates the submissions contained in the file. Submission validation consists of two parts: schema validation and business rule validation.

5.3.1 Schema Validation

IRS recommends each return be run against a validating parser prior to being submitted to IRS. This pre-validation is intended to identify the majority of potential error conditions and minimize the chance of receiving errors. A parser compares the XML document to the defined elements and attributes of the schemas to ensure a well-formed document is received. Schemas provide the basic definition for elements – what is required, field length, data type, allowable values, etc. Data integrity depends on each data element complying with the data format specifications. If the tax preparation software uses the IRS-defined XML schemas to create the XML tax return, there should be no data format errors in the return. The MeF system verifies this by validating each return in the transmission file against the schemas. If a data format error is encountered the return is rejected. (Note: When an error is found during schema validation, processing is stopped at the point of the error so there may be additional errors in the file that have not been identified.)

Below are samples of schema validation business rules. The complete list of business rules is found on each form’s respective irs.gov website shown below.

*Note: The Tax Type includes all MeF Forms (720, 2290, 8849, 1120, 1120-F, 1120S, 990, 990-EZ, 990-N, 990-PF, 1120-POL, 8868, 7004, 1065, 1065-B)

Schema Validation Business Rules

Rule Number	Rule Text	Error Category	Severity	Tax Type
X0000-005	The XML data has failed schema validation.	XML Error	Reject And Stop	*See Note above
X0000-010	For each SubmissionID provided in the transmission manifest there must be a submission zip archive entry present in the Attachment Zip file whose name (without the “.zip” extension) matches the SubmissionID.	Incorrect Data	Reject And Stop	*See Note above
X0000-029	A binary attachment submitted in the PDF format must begin with the file header “%PDF-“.	Incorrect Data	Reject and Stop	1120 1120S 7004 1065 1065-B
X0000-030	The size and CRC232 checksum value must be provided for the submission XML file (i.e. xml data file that starts with “xml/” or “/xml/”	Incorrect Data	Reject and Stop	1120 1120S 7004 1065 1065-B

The schema validation business rules can be found on the irs.gov website as follows:

- For 1120/1120S/7004 - <http://www.irs.gov/taxpros/providers/article/0,,id=97626,00.html>.
- For 1065/1065-B - <http://www.irs.gov/efile/article/0,,id=153999,00.html>
- For 990/990-EZ/990-N/990-PF/1120-POL/8868 - <http://www.irs.gov/charities/article/0,,id=105955,00.html>
- For 720/2290/8849 - <http://www.irs.gov/efile/article/0,,id=169093,00.html>

Check for the latest updates!

For more information regarding validation of the return against the XML schemas, you can refer to Appendix A, “*MeF Submission Composition Guide*”.

5.3.2 Business Rule Validation

The MeF system uses a business rule engine to validate the returns against the rules. When a rule with severity “reject and stop”, or “reject” is violated, an error is generated. (Note: When a rule with severity "reject and stop" is violated, processing is stopped so there may be additional errors in the file that have not been identified. The return acknowledgement contains an element called "CompletedValidation." If a rule with severity "reject and stop" is violated, then the value in this field of the acknowledgement file will be "No"). Errors result in a rejected return. As submissions are validated, the acknowledgements are made available to the transmitter for retrieval.

Below are samples of return validation business rules. The complete listing of business rules can be found at the irs.gov websites shown below for each form.

Note: Rules that begin with STATE are rules that support the Fed/State submission.

Return Validation Business Rules

Rule Number	Rule Text	Error Category	Severity	Tax Type
R0000-075	The Routing Transit Number (RTN) must conform to the banking industry RTN algorithm.	Incorrect Data	Reject	990-PF, 1120-POL, 8868, 7004, 1120, 1120S, 1065, 1065-B,
R0000-900	The return type indicated in the return header must match the return type established with the IRS for the EIN	Database Validation Error	Reject	720, 2290, 1120, 1120-F, 990, 990-EZ, 990-PF, 1065, 1065-B
R0000-904	Software ID in the Return Header must have passed testing for the form family and tax year.	Database Validation Error	Reject And Stop	720, 2290, 1120, 1120-F, 1120S, 990, 990-EZ, 990-N, 990-PF, 1120-POL, 8868, 7004, 1065, 1065-B
R0000-905	Electronic Filing Identification Number (EFIN) in the Return Header must be listed in the e-File database and in accepted status.	Database Validation Error	Reject And Stop	720, 2290, 8849, 1120, 1120-F, 1120S, 990, 990-EZ, 990-N, 990-PF, 1120-POL, 8868, 7004, 1065, 1065-B
R0000-906	Routing Transit Number (RTN) included in the return must be present in the e-File database.	Database Validation Error	Reject	720, 2290, 1120, 1120S, 990-PF, 1120-F, 1120-POL, 8868, 7004, 1065, 1065-B
STATE-007	The IRS Submission ID referenced in the State Submission must be that of an IRS Return.	Incorrect Data	Reject	1120, 1120-F, 1120S, 990, 990-EZ, 990-PF, 7004, 1065, 1065-B

R0000-052	The Tax Year specified in the IRS Submission Manifest must match the Tax Year in the Return Header.	Data Mismatch	Reject	720, 2290, 1120, 1120-F, 1120S, 990, 990-EZ, 990-N, 990- PF, 1120- POL, 8868, 7004, 1065, 1065-B
-----------	---	---------------	--------	--

All MeF business rules can be found on the irs.gov website as follows:

- For 1120/1120S/7004 - <http://www.irs.gov/taxpros/providers/article/0,,id=97626,00.html>.
- For 1065/1065-B - <http://www.irs.gov/efile/article/0,,id=153999,00.html>
- For 990/990-EZ/990-N/990-PF/1120-POL/8868 - <http://www.irs.gov/charities/article/0,,id=105955,00.html>
- For 720/2290/8849 - <http://www.irs.gov/efile/article/0,,id=169093,00.html>

Check for the latest updates!

5.3.3 Checksum and Data Values Returned in the Acknowledgement File

To provide taxpayers with the ability to ensure that all of the data sent to the IRS was received, the MeF system will report the taxable income, total tax, and the submission file checksum in the acknowledgement file. Note: For TY 2006, Form 1120S uses the data from Schedule K, Line 18 as the taxable income. The taxpayer will need to check the data in the acknowledgement to ensure that the file the IRS was received is correct.

When a zip archive tool compresses files and directories into a zip file, it computes a checksum for each zip entry and includes it in the zip file. It is important to note that the checksum of a file zip entry is the checksum of the file before it is compressed. The IRS will use the 32-bit Cyclic Redundancy Code (CRC32) checksum algorithm, as supported by WinZip, PKZIP, and GZIP.

This example illustrates where the CRC32 value can be found in the zip archive file. The zip archive tool compresses the following files and directories into a *sample1.zip* file using WinZip:

- */manifest/*
 - *manifest.xml*
- */xml/*
 - *1120S.xml*
- */attachment/*
 - *8453 Signature Document .pdf*
 - *CertifiedHistoricStructuresSch.pdf*

The CRC32 values for the *1120S.xml* file can be found:
WinZip Classic → File → Properties → Details

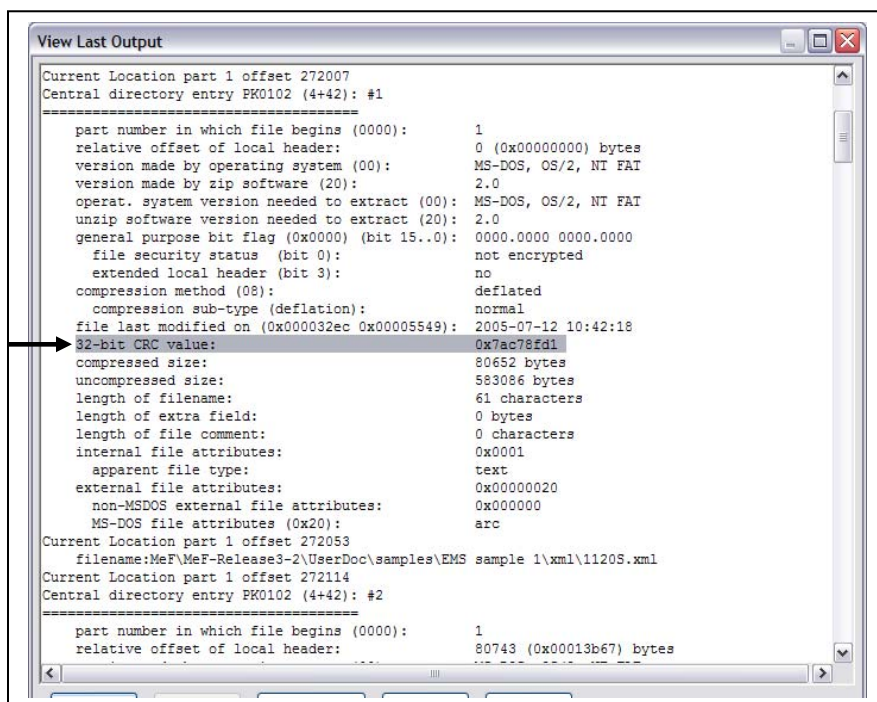

Figure 5-4: CRC Value in the Zip Archive File

The value “0x7ac78fd1” is a hexadecimal number of 32 bits long (the corresponding decimal integer is 2059898833).

The MeF system will compute and report on the submission XML file checksum in the acknowledgement file only. The checksums of the other zip entries such as the *manifest.xml* file and PDF binary attachments will not be computed and reported.

1. Based on requests from 1120/1120S taxpayers and developers, the IRS added checksum fields and data fields from the original return that was submitted.

The MeF system has 4 XML elements in the submission acknowledgement, regardless whether the submission is accepted or rejected:

- *<EmbeddedCRC32>*
- *<ComputedCRC32>*
- *<TaxableIncome>* (Populated from line 30 of F1120; other form types default to zero.)
- *<TotalTax>* (Populated from line 31 of F1120; other form types default to zero.)

2. The MeF system will retrieve the CRC32 checksum value of the submission XML file zip entry and return it in the acknowledgement file as the *<EmbeddedCRC32>*.
3. The MeF system will compute the CRC32 checksum value of the submission XML file to verify that the computed value is the same as the one embedded in the zip file.

The taxpayer compares the *<EmbeddedCRC32>* element with the *<ComputedCRC32>* element to ensure that the file the IRS received is the same size as the file the taxpayer sent. If there are

any discrepancies, the taxpayer needs to contact the transmitter to see if the file was changed before transmission.

5.4 Generating Acknowledgement Files

Once the transmission is received, the MeF system validates the file and creates an acknowledgement within 24 hours. In the previous filing seasons, many acknowledgements were returned within 2-3 minutes, depending on the size of the message, number of validations in the return, and the load on the system. If the transmission is rejected, processing stops and return validation will not begin. The transmission acknowledgement indicates the transmission errors that were found during validation. The transmission acknowledgement will include the transmission ID, timestamp, transmission status (“A” (Accepted) or “R” (Rejected), errors (if applicable) and GTX Key.

If the transmission is rejected, there will only be a transmission acknowledgement. If the transmission is accepted, the MeF system continues to validate the returns within the file. One acknowledgement is generated for each return in the file. The return acknowledgement will include the submission ID, return EIN, return type (since a transmission can include a combination of any of the MeF return types), and the return status (“A” or “R”). If the return is rejected, it will include the first 100 errors that were found. Each error generated contains the following information:

Path - (Xpath) to the data element causing the violation, when available

Error Category - Errors are grouped into a small number of categories

Error Message - Rule text or XML validator message

Rule Number - Each rule is identified by a unique rule number

Severity - 'Reject And Stop' or 'Reject'

Data value - Data value causing the violation - when appropriate

Refer to the items in the Return Acknowledgement Schema, [Figure 5-6](#), below for all of the items that will be included in the return acknowledgement.

Figure 5-6: Return Acknowledgement Schema

```
<!-- Acknowledgement -->
<xsd:element name="Acknowledgement">
  <xsd:complexType>
    <xsd:sequence>

      <!-- Common Submission/Acknowledgement Elements -->
      <xsd:group ref="CommonSubmissionAndAcknowledgementElements"/>

      <!-- Submission Category - Identifies the submission category, for example EO or Corporate submission -->
      <xsd:element name="SubmissionCategory" type="SubmissionCategoryType"/>

      <!-- Electronic Postmark -->
      <xsd:element name="ElectronicPostmark" type="TimestampType" minOccurs="0"/>

      <!-- Filing Status - Filing status of the submission -->
      <xsd:element name="FilingStatus" type="StringType"/>

      <!-- Status Date - The date the filing status was acknowledged -->
      <xsd:element name="StatusDate" type="DateType"/>

      <!-- IRS Submission ID - The submission ID of an IRS submission that the processing of this state submission depends on -->
      <xsd:element name="IRSSubmissionId" type="SubmissionIdType" minOccurs="0"/>

      <!-- State Submission Copy Count - The number of copies made of an IRS submission (only for EO currently) -->
      <xsd:element name="StateSubmissionCopyCount" type="IntegerNNType" minOccurs="0"/>

      <!-- EIN - The EIN of the filer -->
      <xsd:element name="EIN" type="EINType" minOccurs="0"/>

      <!-- Filing Type Description - For applications for extension, the type of return for which the filing time is being extended -->
      <xsd:element name="FilingTypeDescription" type="StringType" minOccurs="0"/>

      <!-- Tax Period End Date -->
      <xsd:element name="TaxPeriodEndDate" type="DateType" minOccurs="0"/>

      <!-- Payment Indicator -->
      <xsd:element name="PaymentIndicator" minOccurs="0">
        <xsd:simpleType>
          <xsd:restriction base="StringType">
            <xsd:enumeration value="Payment Request Received"/>
          </xsd:restriction>
        </xsd:simpleType>
      </xsd:element>

      <!-- Completed Validation - (Y/N) Indicates whether the submission went through all possible validation processing -->
      <xsd:element name="CompletedValidation" type="BooleanType" minOccurs="0">

        <!-- Embedded CRC32 -->
        <xsd:element name="EmbeddedCRC32" minOccurs="0">
          <xsd:annotation>
            <xsd:documentation>
              <Description>Embedded CRC32</Description>
            </xsd:documentation>
          </xsd:annotation>
          <xsd:simpleType>
            <xsd:restriction base="xsd:string">
              <xsd:maxLength value="10" />
              <xsd:pattern value="0x[0-9A-Fa-f]{1,8}" />
            </xsd:restriction>
          </xsd:simpleType>
        </xsd:element>

        <!-- Computed Checksum -->
        <xsd:element name="ComputedCRC32" minOccurs="0">
          <xsd:annotation>
            <xsd:documentation>
              <Description>Computed CRC32</Description>
            </xsd:documentation>
          </xsd:annotation>
        </xsd:element>
      </xsd:element>
    </xsd:sequence>
  </xsd:complexType>
</xsd:element>
```

```

        <xsd:simpleType>
            <xsd:restriction base="xsd:string">
                <xsd:maxLength value="10" />
                <xsd:pattern value="0x[0-9A-Fa-f]{1,8}" />
            </xsd:restriction>
        </xsd:simpleType>
    </xsd:element>

    <!-- Taxable Income -->
    <xsd:element name="TaxableIncome" type="USAmountType" minOccurs="0" />

    <!-- Total Tax -->
    <xsd:element name="TotalTax" type="USAmountNNType" minOccurs="0" />

    <!-- Error List -->
    <xsd:element name="ErrorList" type="ValidationErrorListType" minOccurs="0"/>

</xsd:sequence>

<!-- Submission Version -->
<xsd:attribute name="submissionVersion" type="StringType" use="optional"/>

<!-- Validating Schema Version -->
<xsd:attribute name="validatingSchemaVersion" type="StringType" use="optional"/>

</xsd:complexType>
</xsd:element>

<!-- Acknowledgement List -->
<xsd:element name="AcknowledgementList">
    <xsd:complexType>
        <xsd:sequence>

            <xsd:element name="Count" type="IntegerNNType"/>
            <xsd:element ref="Acknowledgement" minOccurs="0" maxOccurs="unbounded"/>

        </xsd:sequence>

    </xsd:complexType>
</xsd:element>

<!-- Status Record List -->
<xsd:element name="StatusRecordList">
    <xsd:complexType>
        <xsd:sequence>

            <xsd:element name="Count" type="IntegerNNType"/>

            <!-- Status Record -->
            <xsd:element name="StatusRecord" minOccurs="0" maxOccurs="unbounded">
                <xsd:complexType>
                    <xsd:sequence>

                        <!-- Submission ID - The submission ID of the received submission -->
                        <xsd:element name="SubmissionId" type="SubmissionIdType"/>

                        <!-- Submission Status - The status of the received submission -->
                        <xsd:element name="SubmissionStatus" type="StringType"/>

                        <!-- Status Date - The date the submission status was acknowledged -->
                        <xsd:element name="StatusDate" type="DateType"/>

                    </xsd:sequence>
                </xsd:complexType>
            </xsd:element>

        </xsd:sequence>

    </xsd:complexType>
</xsd:element>

<!-- Acknowledgement Notification -->

```

```

<xsd:element name="AckNotification">
  <xsd:complexType>
    <xsd:sequence>

      <!-- Submission ID - The submission ID of the acknowledgement that was retrieved by the transmitter -->
      <xsd:element name="SubmissionId" type="SubmissionIdType"/>

      <!-- Timestamp - The date and time the acknowledgement was retrieved by the transmitter -->
      <xsd:element name="Timestamp" type="TimestampType"/>

    </xsd:sequence>
  </xsd:complexType>
</xsd:element>

<!-- Acknowledgement Notification List -->
<xsd:element name="AckNotificationList">
  <xsd:complexType>
    <xsd:sequence>

      <xsd:element name="Count" type="IntegerNNType"/>
      <xsd:element ref="AckNotification" minOccurs="0" maxOccurs="unbounded"/>

    </xsd:sequence>

  </xsd:complexType>
</xsd:element>

```

Note: The CompletedValidation data element is “Yes” if the validation completed successfully or “No” if the validation failed with a Reject-Stop error.

6 Retrieval Methods for MeF

This section describes what transmitters and state agencies retrieve and how they retrieve messages from the IRS. This section also describes how MeF generates acknowledgements for messages (transmissions) and returns (submissions) transmitted to the IRS, and how to retrieve them through IFA, and Application-to-Application.

In January 2006, new communication artifacts were created to accommodate the new communications paradigm enabled by Application-to-Application:

- Acknowledgement
- Status Record
- Acknowledgement Notification
- Notification

In addition to acknowledgements, transmitters and state agencies are able to retrieve status records, acknowledgement notifications, and State Submissions through Application-to-Application.

If the message rejects, the system stops validating the submissions and generates a reject acknowledgement. If the message is accepted, MeF continues validating the submissions and generates an acknowledgement for each submission.

It is important to note that the portal used to retrieve an acknowledgement must be the same portal used to transmit the submission associated with the desired acknowledgement. That is, if you transmitted a submission through IFA, the subsequent acknowledgement generated will only be available through IFA.

6.1 Retrieving the Acknowledgement through Internet Filing

The following section describes the procedure for retrieving an acknowledgement through the Internet Filing Application.

As submissions are validated, the acknowledgements are made available to the transmitter for retrieval. When the transmitter requests New Acknowledgements, he/she indicates how many acknowledgements he/she wants to download (up the maximum of 100). The system will make available to the transmitter as many acknowledgements as are available, up to the count he/she requested. If there are still more acknowledgements available, the screen will provide the following statement "There are additional acknowledgements available for retrieval."

You do not have to pick up acknowledgement files before transmitting. However, you will need to pick up your acknowledgement as soon as possible to provide the taxpayer with their acknowledgement. MeF stores the acknowledgement file for one year from the date the acknowledgement was first created. You may re-retrieve an acknowledgement by following the steps in Section 6.2.2. They cannot be retrieved after one year.

6.1.1 Accessing and Logging into MeF Internet Filing

You must be authorized to submit transmissions or retrieve acknowledgements through the Internet. To access and log into MeF Internet Filing, follow the steps below:

Step 1: Click the *e-file* logo on the irs.gov website.



Figure 6-1: irs.gov Website

Step 2: Click the *e-file* for Business and Self-Employed Taxpayers link in the *e-file* Landing Page.

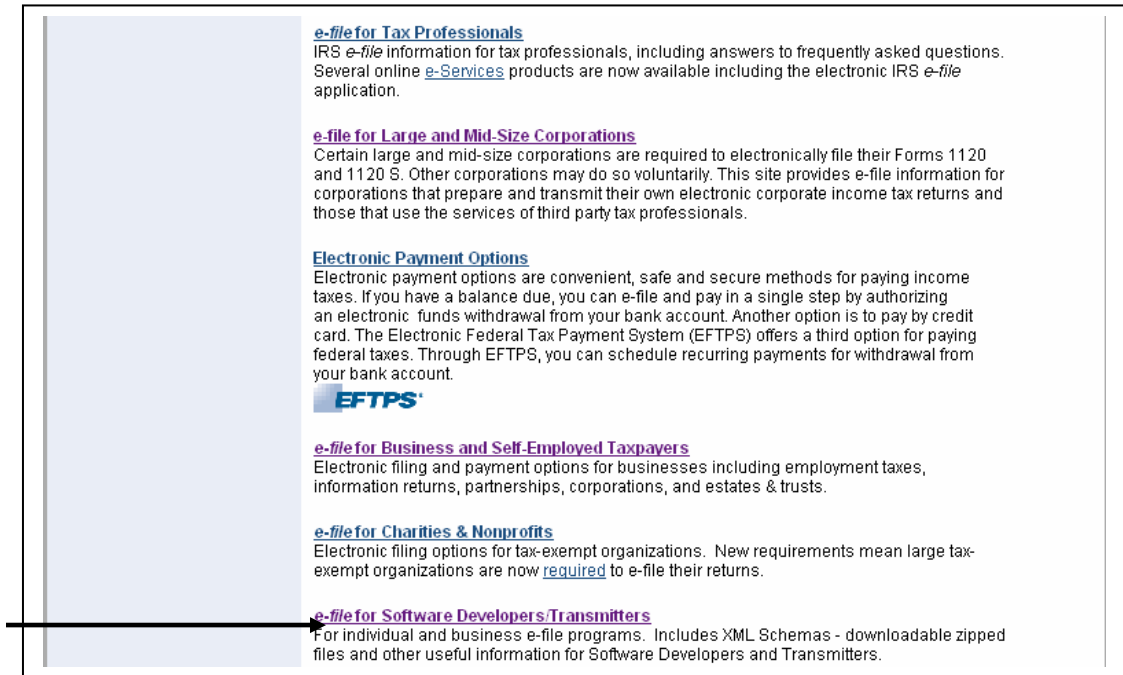

[e-file for Tax Professionals](#)
IRS *e-file* information for tax professionals, including answers to frequently asked questions. Several online [e-Services](#) products are now available including the electronic IRS *e-file* application.

[e-file for Large and Mid-Size Corporations](#)
Certain large and mid-size corporations are required to electronically file their Forms 1120 and 1120 S. Other corporations may do so voluntarily. This site provides e-file information for corporations that prepare and transmit their own electronic corporate income tax returns and those that use the services of third party tax professionals.

[Electronic Payment Options](#)
Electronic payment options are convenient, safe and secure methods for paying income taxes. If you have a balance due, you can e-file and pay in a single step by authorizing an electronic funds withdrawal from your bank account. Another option is to pay by credit card. The Electronic Federal Tax Payment System (EFTPS) offers a third option for paying federal taxes. Through EFTPS, you can schedule recurring payments for withdrawal from your bank account.



[e-file for Business and Self-Employed Taxpayers](#)
Electronic filing and payment options for businesses including employment taxes, information returns, partnerships, corporations, and estates & trusts.

[e-file for Charities & Nonprofits](#)
Electronic filing options for tax-exempt organizations. New requirements mean large tax-exempt organizations are now [required](#) to e-file their returns.

[e-file for Software Developers/Transmitters](#)
For individual and business e-file programs. Includes XML Schemas - downloadable zipped files and other useful information for Software Developers and Transmitters.

Figure 6-2: *e-file* Landing Page

Step 3: Click the *e-File* for Business – Software Developers & Transmitters Page link.

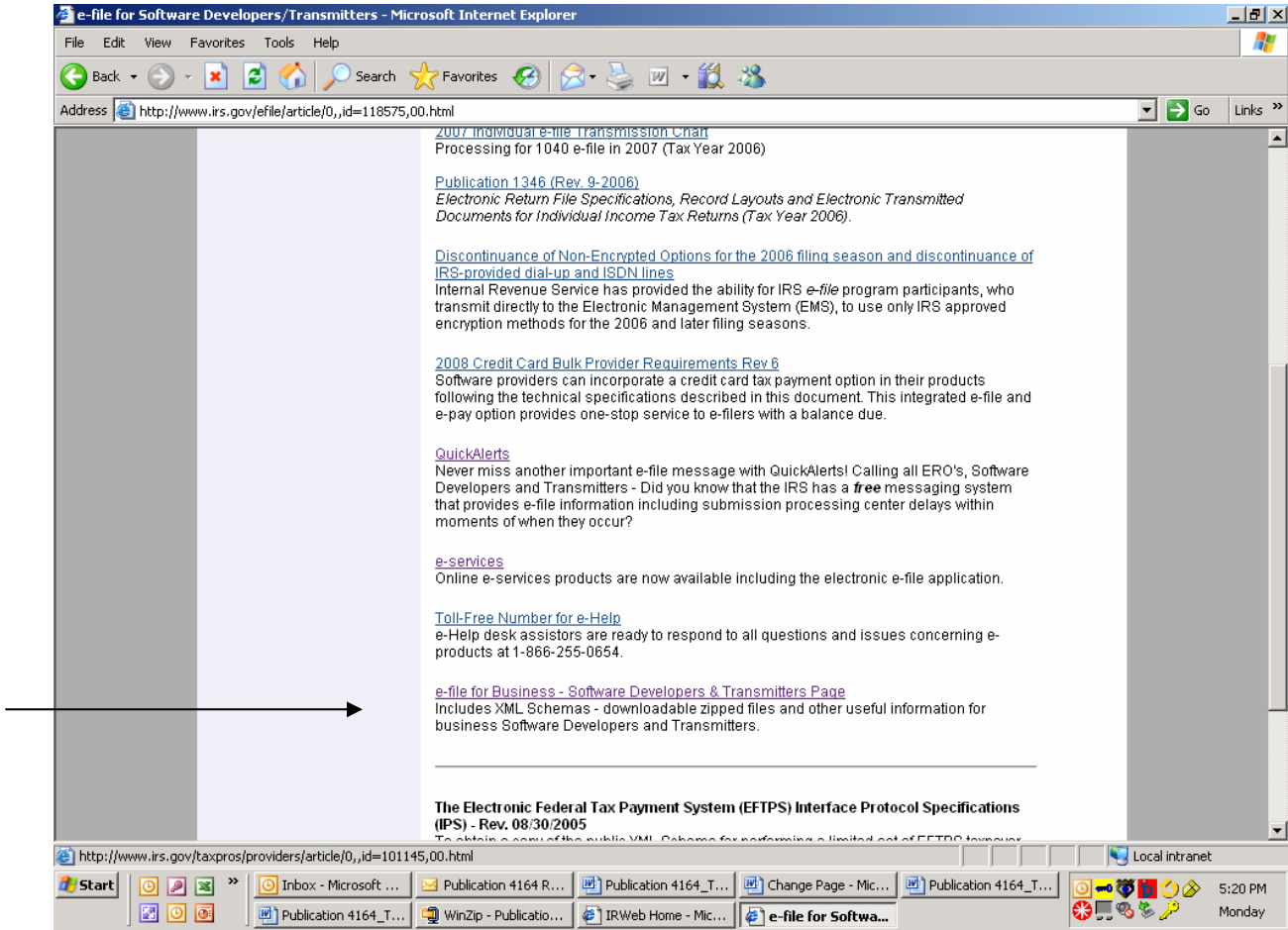

Figure 6-3: IRS.gov Website with *e-file* for Business - Software Developers & Transmitters Page link

Step 4: Click the Modernized *e-File* (MeF) Internet Filing and Status Page link.

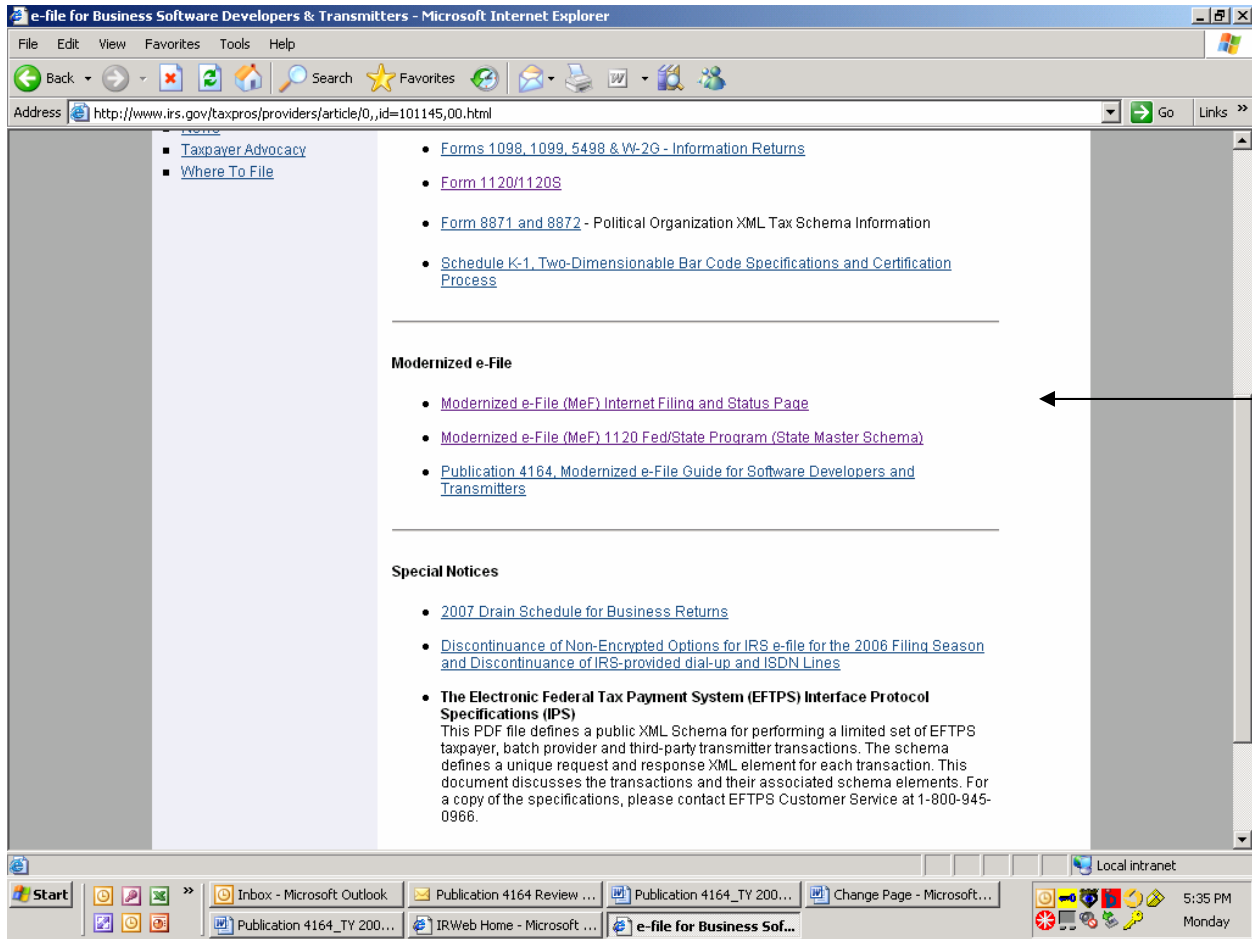

Figure 6-4: IRS.gov Modernized *e-File* (MeF) Internet Filing and Status Page link

Step 5: Click the MeF Internet Filing link to Login

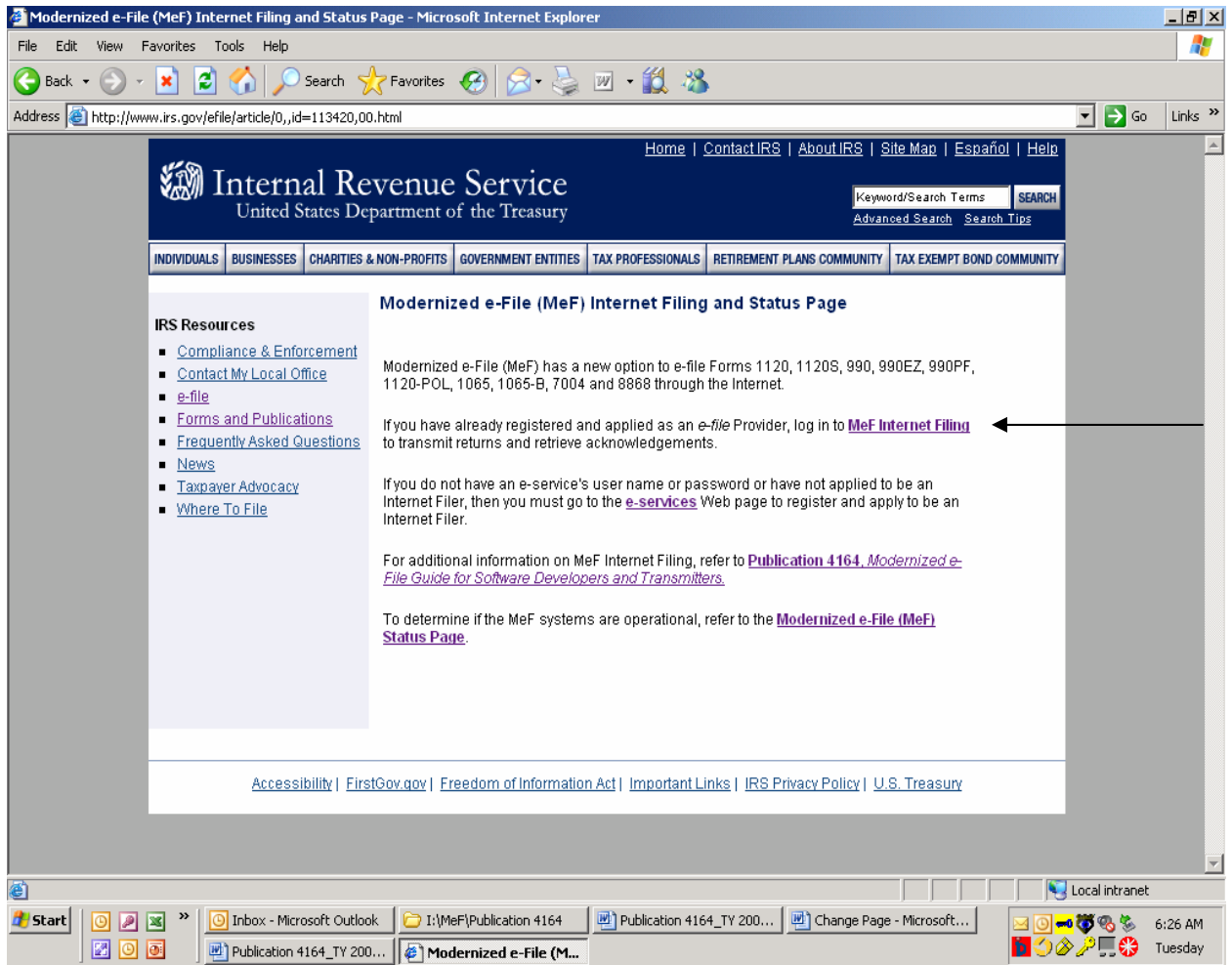

Figure 6-5: IRS.gov MeF Internet Filing Landing and Status Page

Step 6: Read the security alert. Click the OK button in the Security Alert dialogue box to access the MeF Internet Filing Login screen.

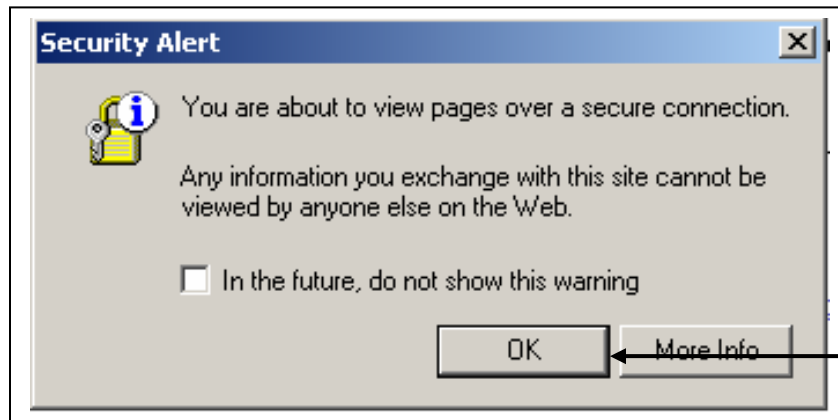

Figure 6-6: IRS.gov Security Alert

Step 7: Enter your e-services Username and Password to receive authentication as an authorized Transmitter.

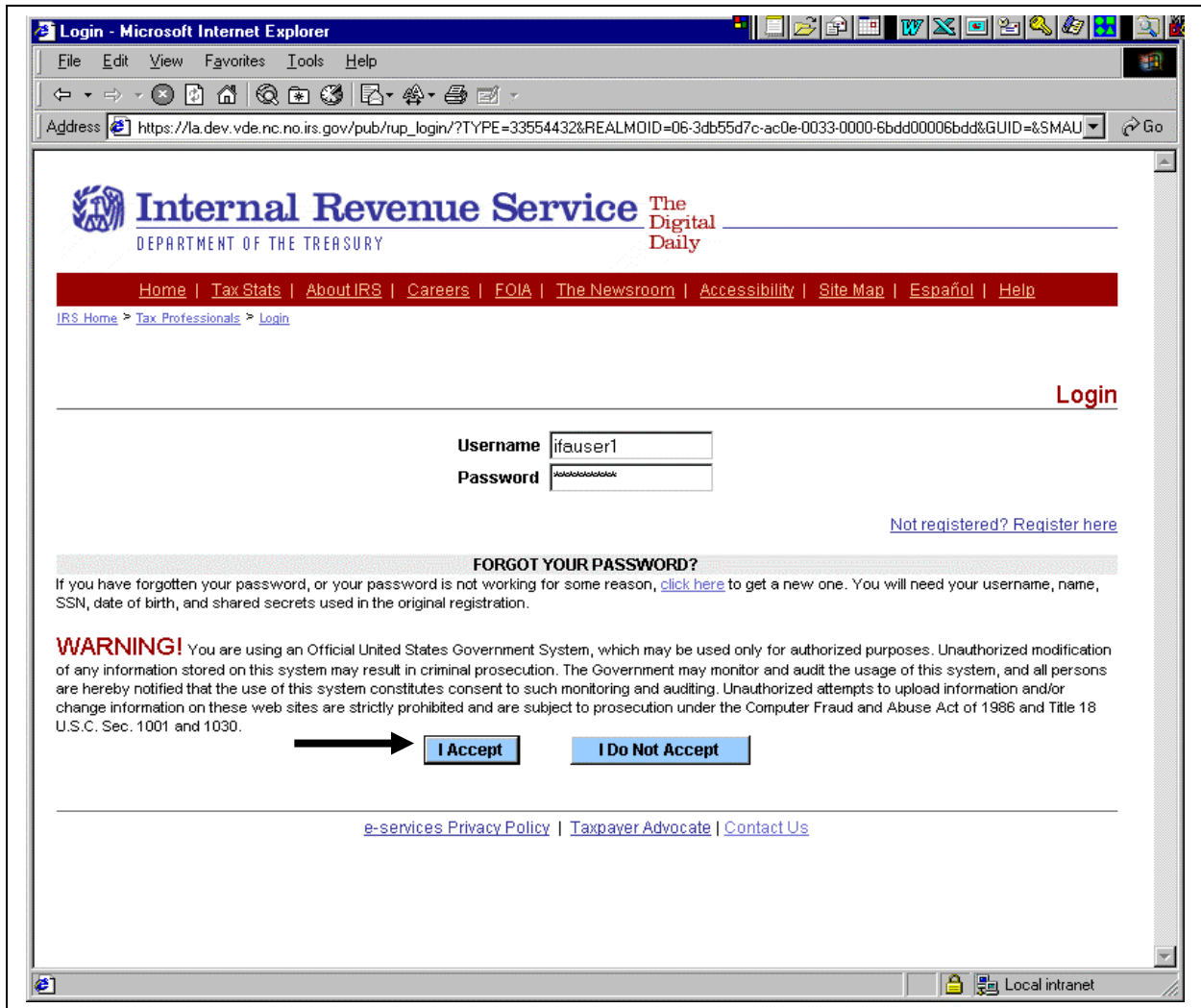

Figure 6-7: e-services Login Screen

Step 8: After authentication, a list of companies for which you are authorized to transmit returns and receive acknowledgement files is displayed. Select the organization you will represent in this session.

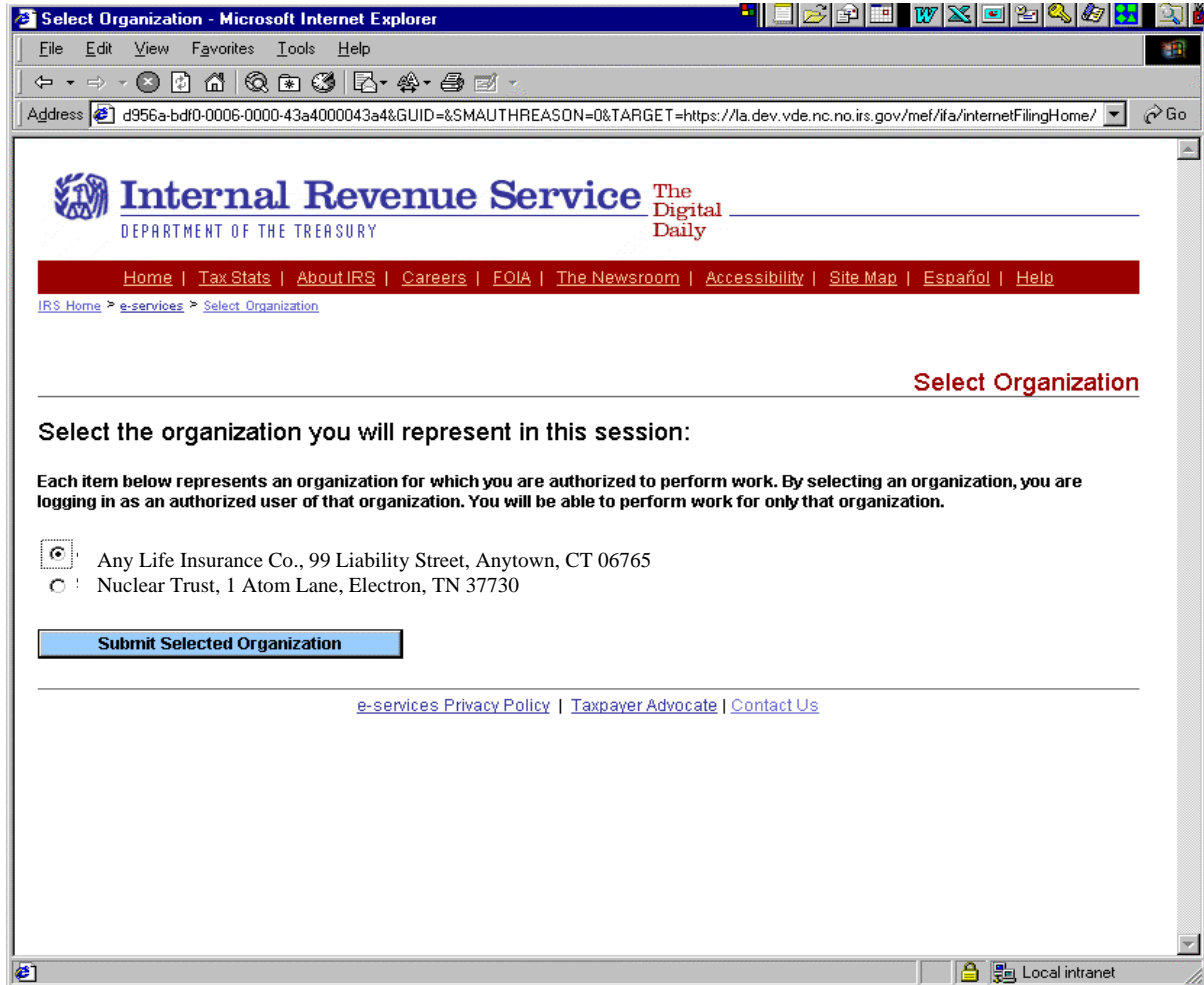

Figure 6-8: Organization Selection Screen

6.1.2 Retrieving an Acknowledgement File

Once you select the organization, the MeF Internet Filing Home Page is displayed. You may retrieve a production or test acknowledgement file by selecting the corresponding link.

Retrieving submission acknowledgements involves the following steps:

1. Requesting retrieval of the acknowledgements
2. Selecting the ETIN associated with the acknowledgements
3. Selecting the type of acknowledgements for download
4. Selecting the number of acknowledgements to download
5. Downloading the acknowledgement(s)

The MeF IFA Web pages supporting these activities are shown in the following sections.

Step 9: Select the “Retrieve Production Acknowledgement” or “Retrieve Test Acknowledgement” file link/navigation tab, as appropriate.

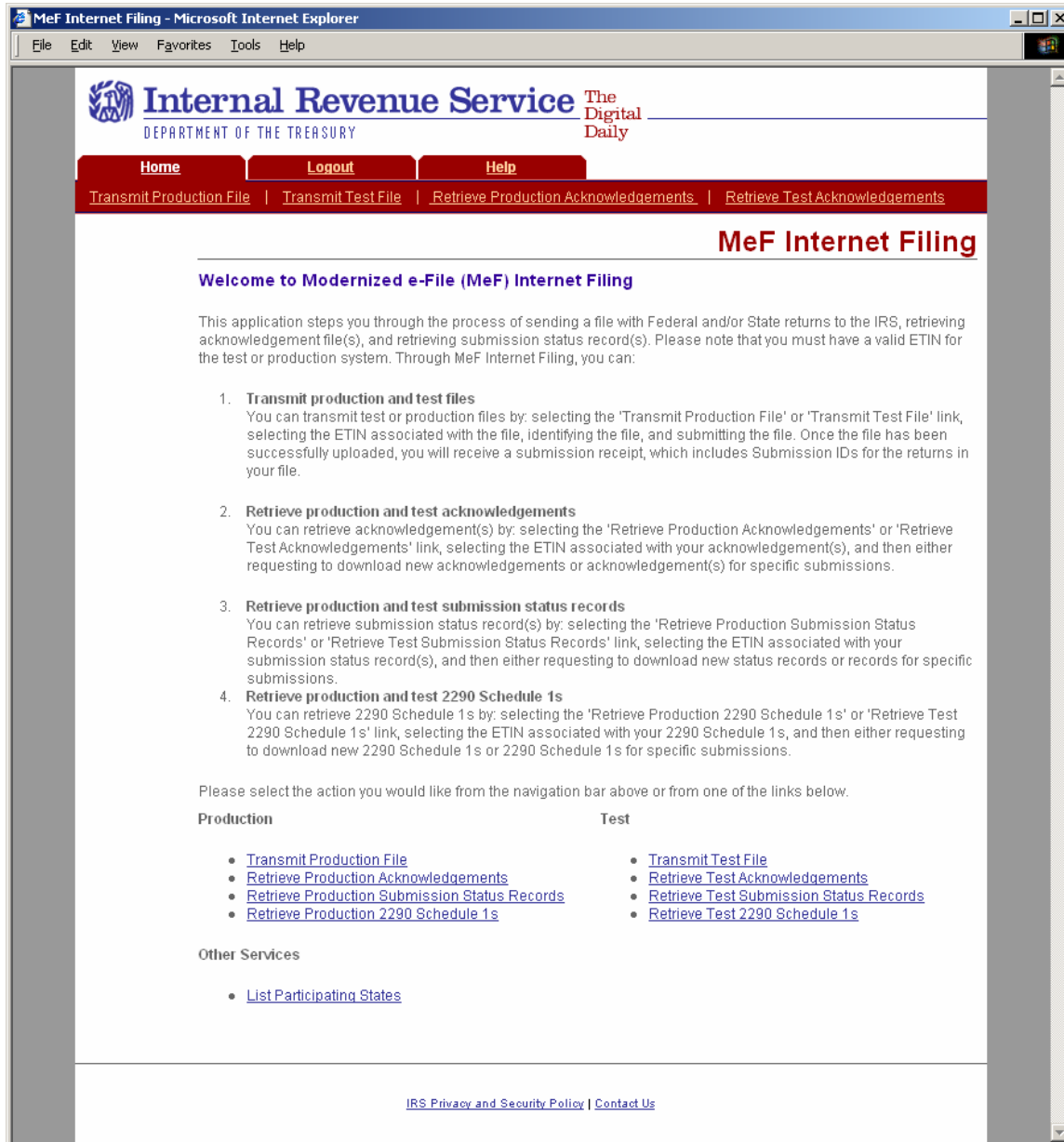

Figure 6-9: MeF Internet Filing Home Page

Once you select the “Retrieve Production Acknowledgement File” link or navigation bar, the “Select ETIN for Production Acknowledgements” screen displays. This page displays the Production ETINs authorized for the transmitter’s use, in sorted order.

Step 10: Select the ETIN associated with the acknowledgement(s) to retrieve.

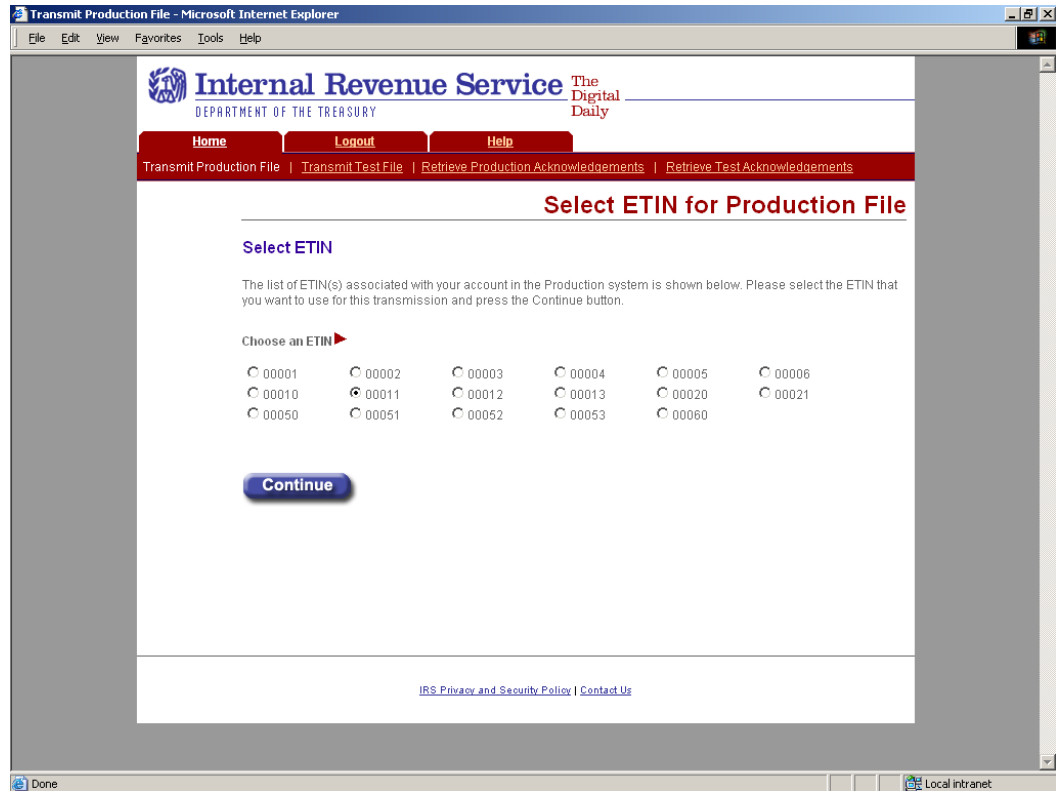

Figure 6-10: Select ETIN for Production Acknowledgement File Page

If the system does not find any associated ETINs for the user ID and customer ID, then the following error message displays. Check to ensure that you selected the appropriate link – you may have selected “Production” and only have test ETINs. You may go back to the MeF Internet Filing Home Page or terminate the session.

Click the **Home** tab on the navigation bar or click **Back to MeF Internet Filing Home** to return to the MeF Internet Filing Home page.

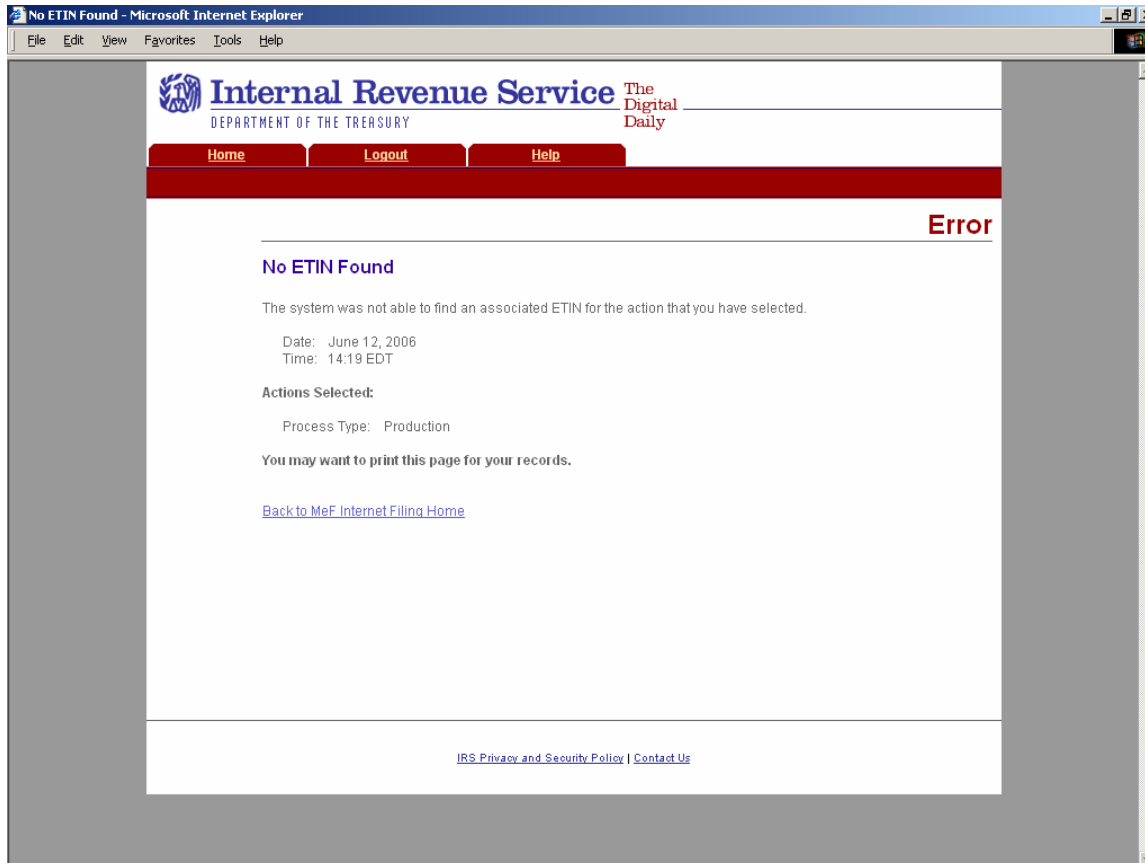

Figure 6-11: No ETIN Found Error Page

Step 11: After selecting the ETIN associated with the acknowledgement(s) you want to retrieve, the Retrieve Submission Acknowledgements screen displays. This page allows the transmitter to retrieve either specific previously downloaded acknowledgements or all new acknowledgements (i.e., not previously downloaded). (The maximum number of acknowledgements you can retrieve at one time is 100.) Select the type of acknowledgements you want to retrieve by clicking:

- **Retrieve all new acknowledgements** radio button to retrieve new acknowledgements (selected by default). The user should enter the number of new Acknowledgements to retrieve, and can select the following retrieval options: by Submission Category (CORP, EO, PART, or all), or by Agency Type (Federal, State, or all) or
- **Retrieve previously downloaded acknowledgements based on Submission ID(s)** radio button to retrieve specific acknowledgements. Enter the Submission ID(s) into the text box labeled “Enter Submission ID(s)”. Each Submission ID should be separated by a comma, followed by a space. The Submission IDs are listed in the Transmission Receipt you received after your message successfully transmitted.

Note: If you want to download based on SubmissionID(s), make sure that you click the radio button in front of the words "Retrieve previously downloaded acknowledgments. If this button is not checked, the system will try to retrieve new acknowledgments even if you enter a submissionID in the box.

- Click the **Submit** button

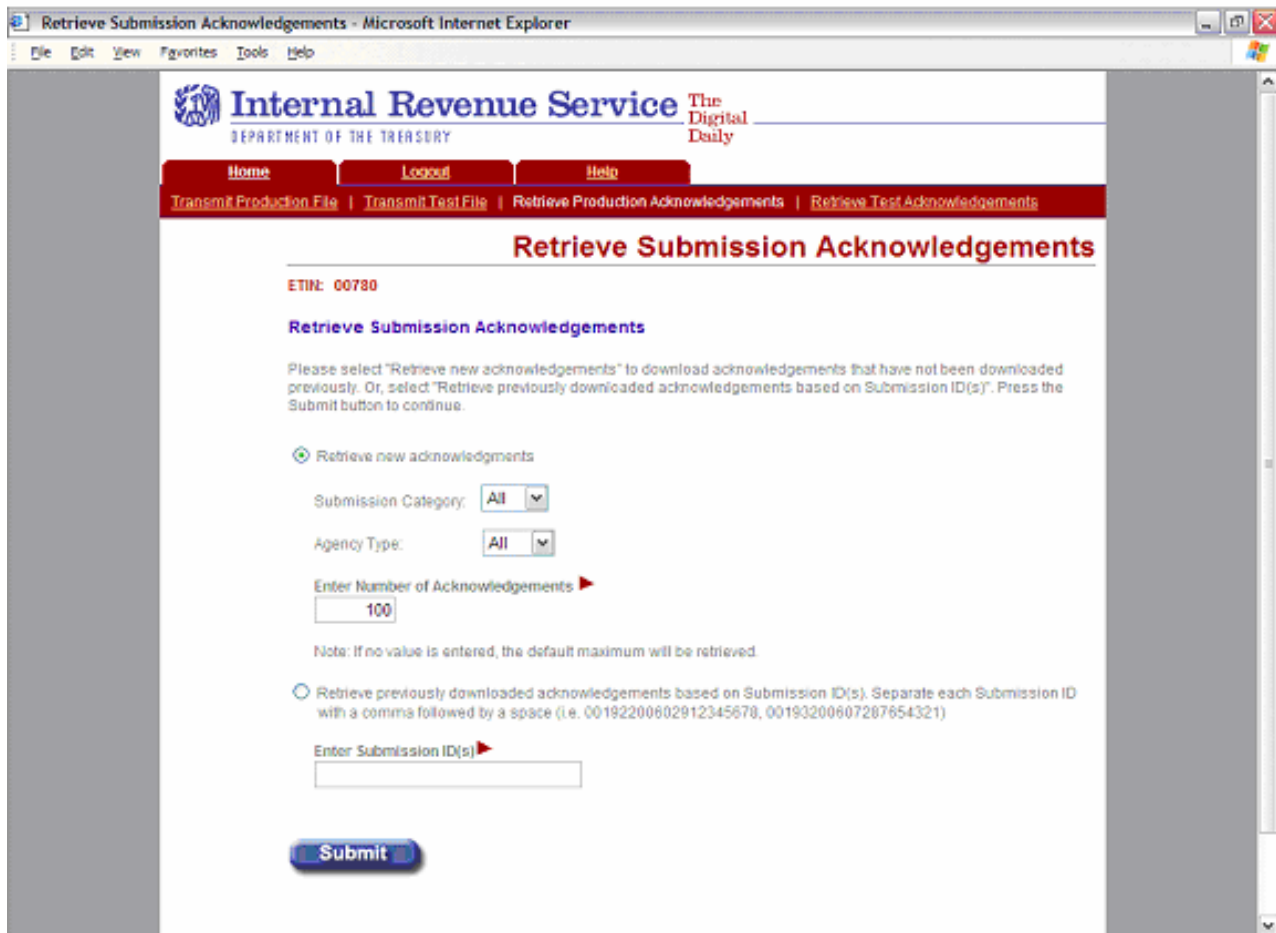

Figure 6-12: Retrieve Submission Acknowledgement

Select the Number of Acknowledgements to Retrieve

The Select Number of Acknowledgements to Retrieve page allows the transmitter to specify the number of acknowledgements to retrieve at one time. The maximum number of acknowledgments a transmitter receives is configurable, however, the maximum number that can be retrieved at one time is 100.

Enter a number between 1 and 100.

Click Continue.

Number of Acknowledgements Requested Exceeds Maximum Error

This error page displays when the transmitter attempts to retrieve more acknowledgements than allowed which is 100.

- Click the **Home** tab on the navigation bar or click **Back to MeF Internet Filing Home** to return to the MeF Internet Filing Home page.

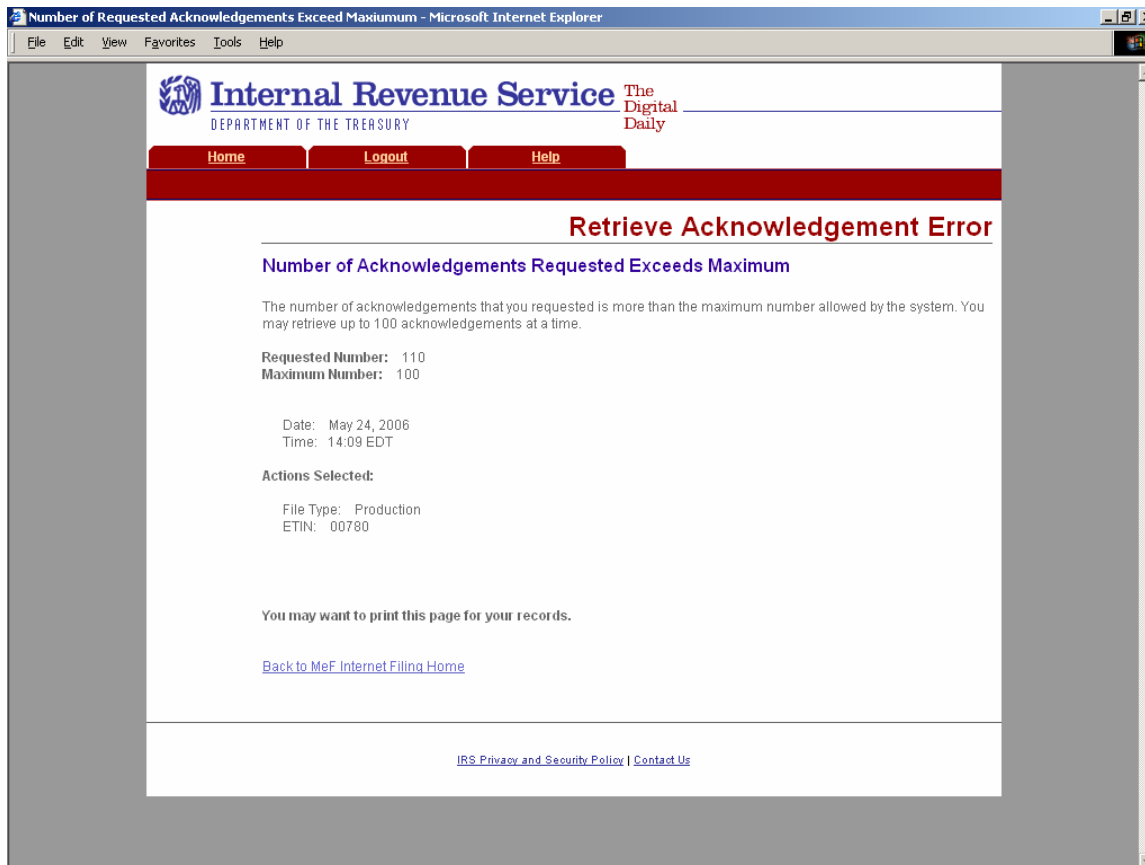

Figure 6-13: Number of Acknowledgements Exceeds Maximum Error Page

Input Error (Number of Acknowledgements)

This error page displays when the number of acknowledgements entered to retrieve new acknowledgements is not in the correct numeric format.

- Click the **Home** tab on the navigation bar or click **Back to MeF Internet Filing Home** to return to the MeF Internet Filing Home page.

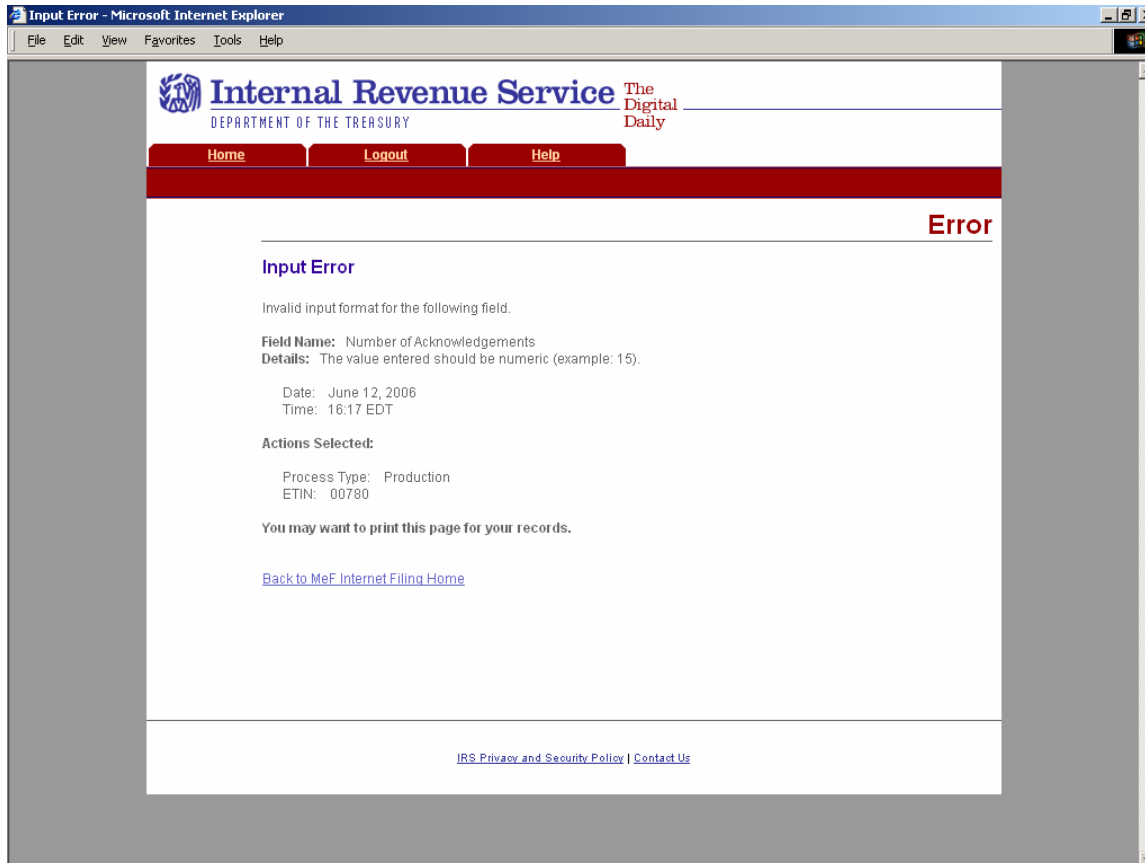

Figure 6-14: Input Error Page

Input Error (Submission ID List)

This error page displays when the Submission ID list entered to retrieve specific acknowledgements is not in the correct format.

- Click the **Home** tab on the navigation bar or click **Back to MeF Internet Filing Home** to return to the MeF Internet Filing Home page.

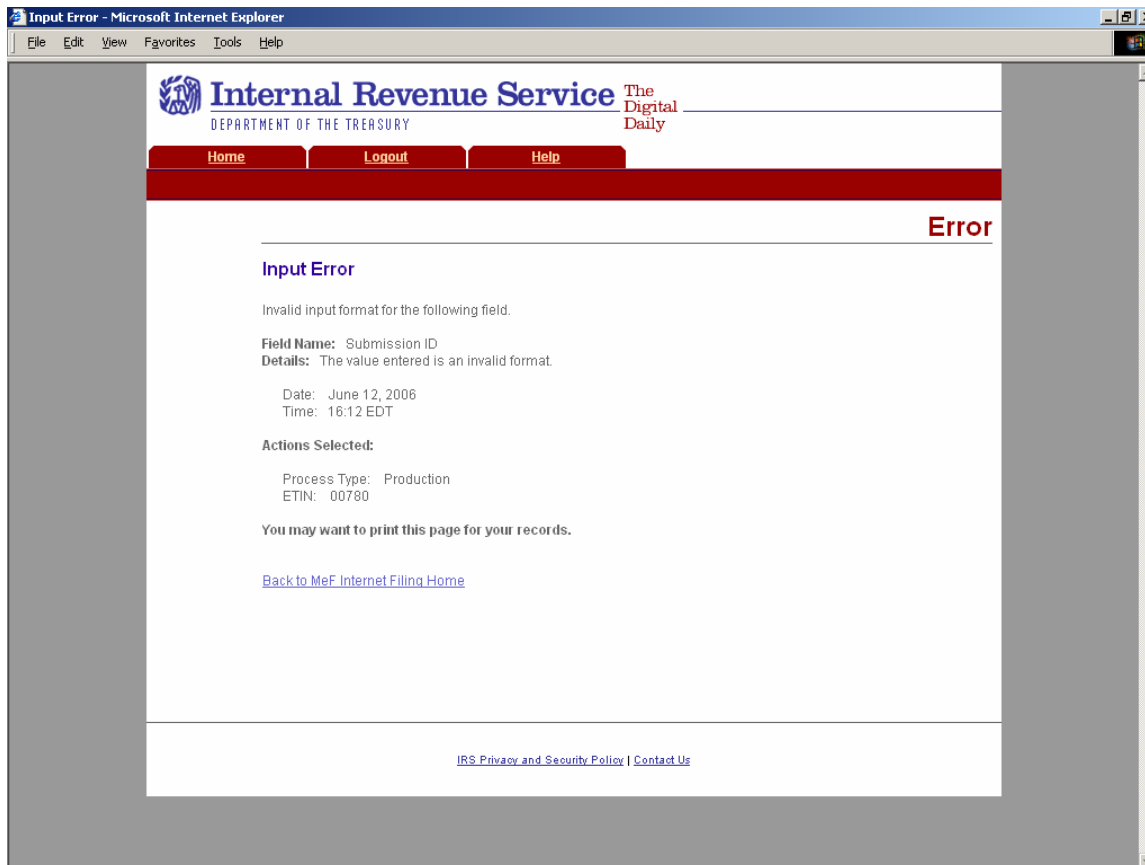

Figure 6-15: Input Error Page

Acknowledgements Not Found Error

This error page displays under any of the following circumstances:

- No acknowledgements are found, and the user has selected “New Acknowledgements” or has requested one or more acknowledgement(s) by entering a Submission ID.
 - The return did not come in through Internet Filing (IFA).
 - The system has not completed processing the submission and an acknowledgement is not available yet.
- Click the **Home** tab on the navigation bar or click **Back to MeF Internet Filing Home** to return to the MeF Internet Filing Home page.

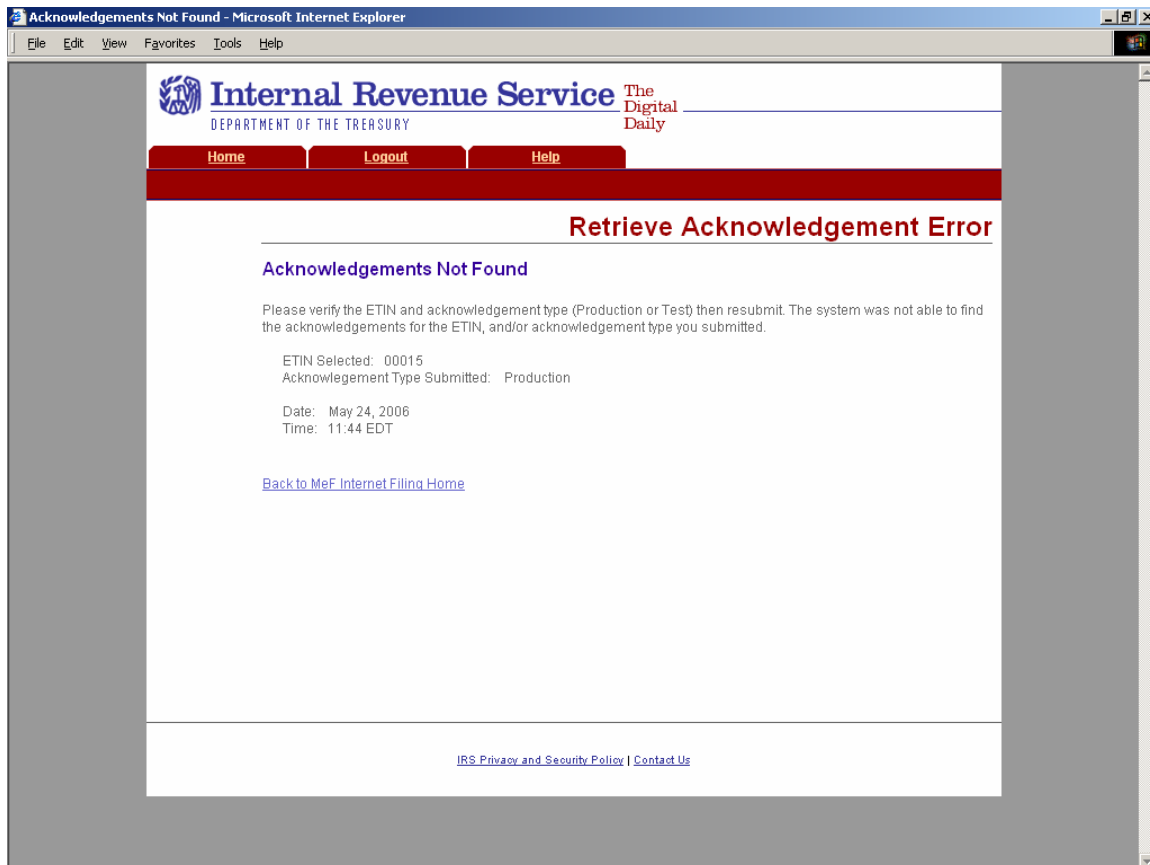

Figure 6-16: Retrieve Acknowledgement Error Page – Acknowledgements Not Found

Not IFA Error

This error page displays when the user has requested an acknowledgement that was not processed by IFA.

- Click the **Home** tab on the navigation bar or click **Back to MeF Internet Filing Home** to return to the MeF Internet Filing Home page.

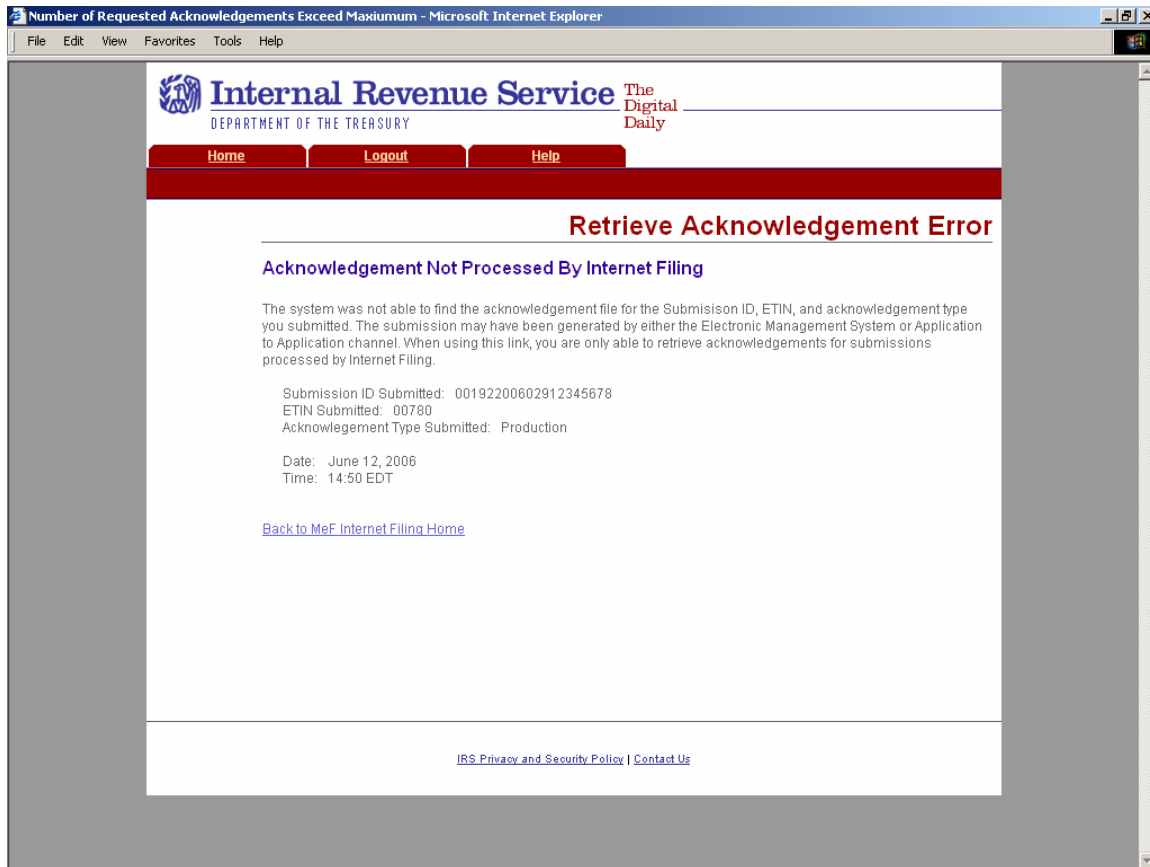

Figure 6-17: Retrieve Acknowledgement Error Page – Acknowledgements Not Processed by Internet Filing

System Error (Retrieve)

This error page displays only when a back-end error occurs when retrieving acknowledgements.

- Click the **Home** tab on the navigation bar or click **Back to MeF Internet Filing Home to return to the MeF Internet Filing Home page.**

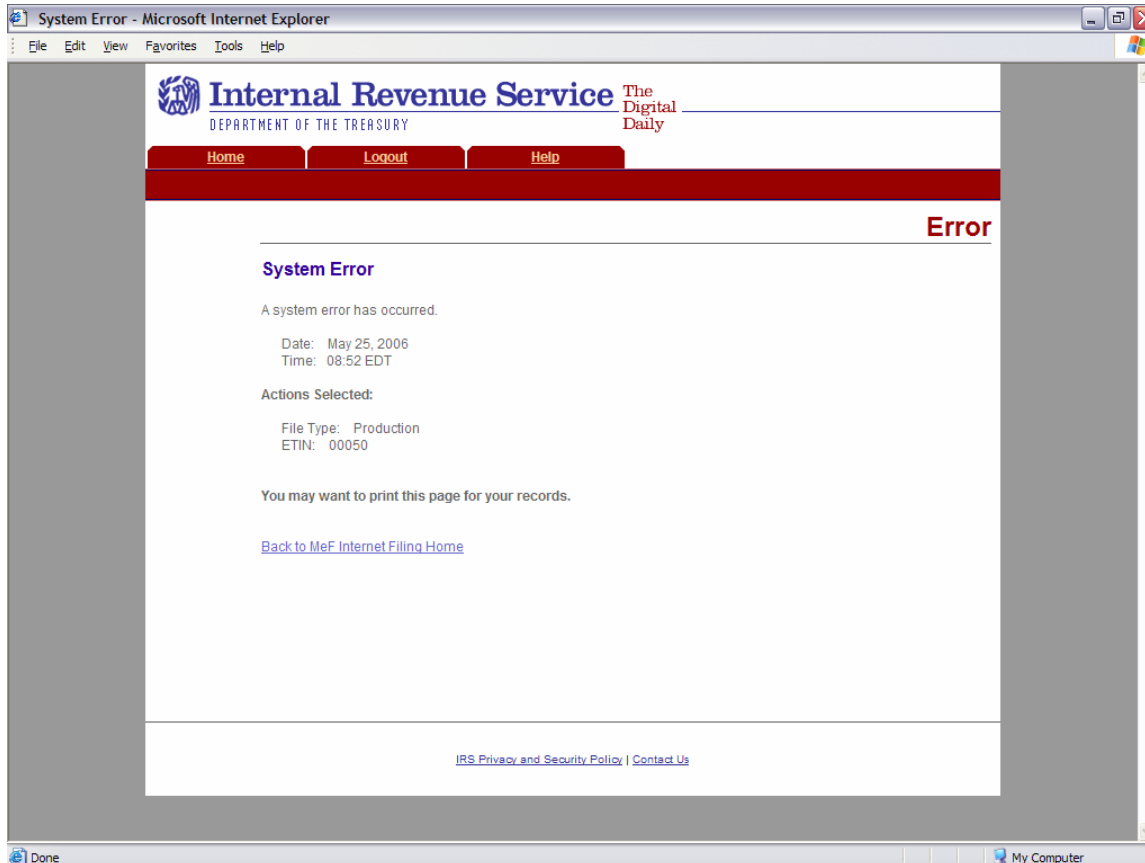

Figure 6-18: System Error Page – System Error Page – Back-end Error

System Error (Retrieve)

This error page displays for errors occurring when retrieving acknowledgements and the system was able to specify the error that occurred.

- Click the **Home** tab on the navigation bar or click **Back to MeF Internet Filing Home** to return to the MeF Internet Filing Home page.

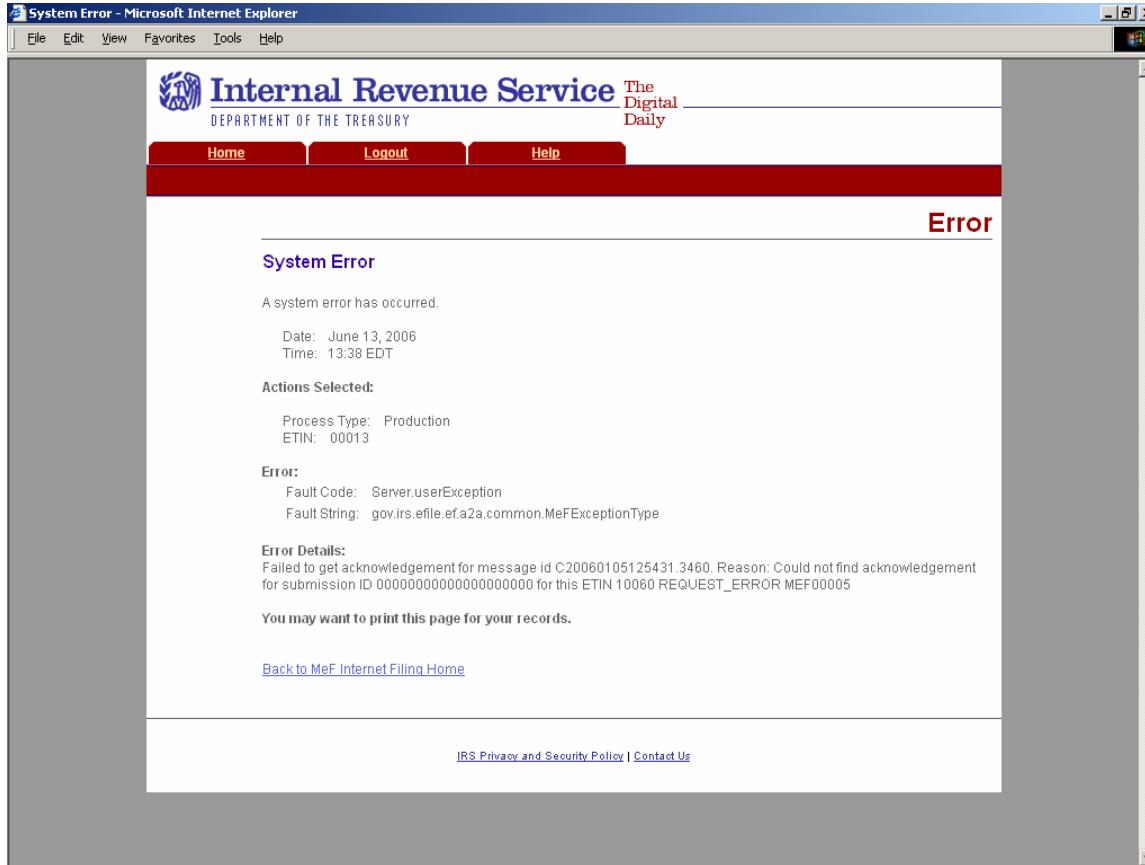

Figure 6-19: System Error Page with Error Specified

Download Acknowledgements

The Download Acknowledgements screen displays the Submission IDs for acknowledgements for the associated ETIN.

- Acknowledgements that can be included in the zip file are marked “Yes” in the **Include in File** column. Click the **Download** button to retrieve the acknowledgements.
- Acknowledgements that will not be included in the zip file are marked “No” in the **Include in File** column. The reason for not including the acknowledgement is supplied in the **Notes** column.

Note: The following page shows the results of a request to download new production acknowledgements.

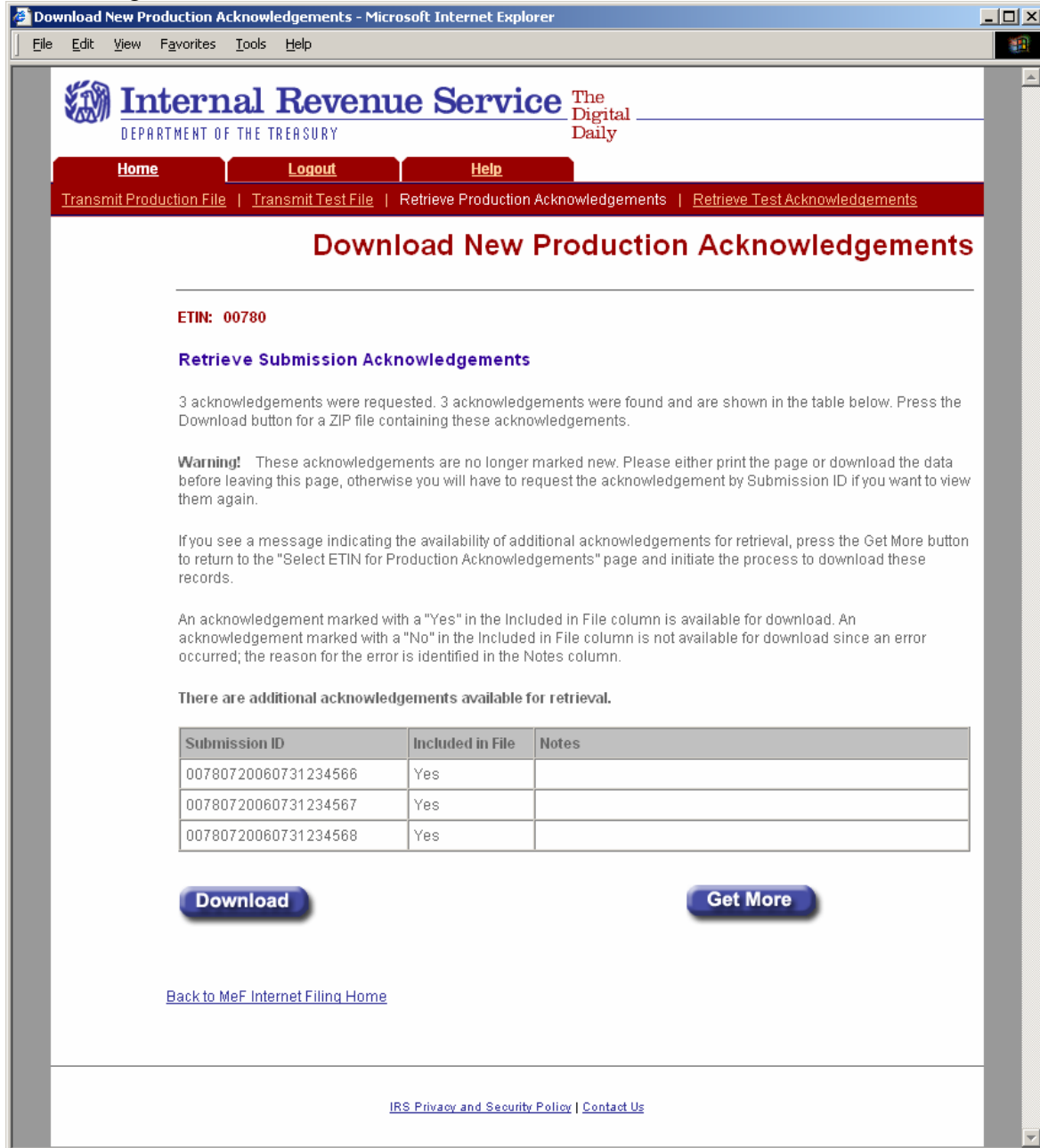

Download New Production Acknowledgements - Microsoft Internet Explorer

File Edit View Favorites Tools Help

Internal Revenue Service The Digital Daily
DEPARTMENT OF THE TREASURY

Home Logout Help

Transmit Production File | Transmit Test File | Retrieve Production Acknowledgements | Retrieve Test Acknowledgements

Download New Production Acknowledgements

ETIN: 00780

Retrieve Submission Acknowledgements

3 acknowledgements were requested. 3 acknowledgements were found and are shown in the table below. Press the Download button for a ZIP file containing these acknowledgements.

Warning! These acknowledgements are no longer marked new. Please either print the page or download the data before leaving this page, otherwise you will have to request the acknowledgement by Submission ID if you want to view them again.

If you see a message indicating the availability of additional acknowledgements for retrieval, press the Get More button to return to the "Select ETIN for Production Acknowledgements" page and initiate the process to download these records.

An acknowledgement marked with a "Yes" in the Included in File column is available for download. An acknowledgement marked with a "No" in the Included in File column is not available for download since an error occurred; the reason for the error is identified in the Notes column.

There are additional acknowledgements available for retrieval.

Submission ID	Included in File	Notes
00780720060731234566	Yes	
00780720060731234567	Yes	
00780720060731234568	Yes	

Download **Get More**

[Back to MeF Internet Filing Home](#)

[IRS Privacy and Security Policy](#) | [Contact Us](#)

Figure 6-20: Download New Production Acknowledgements Page

Note: The screen also indicates whether additional acknowledgements are available for download. The example below illustrates the result of a request to download specific production acknowledgements.

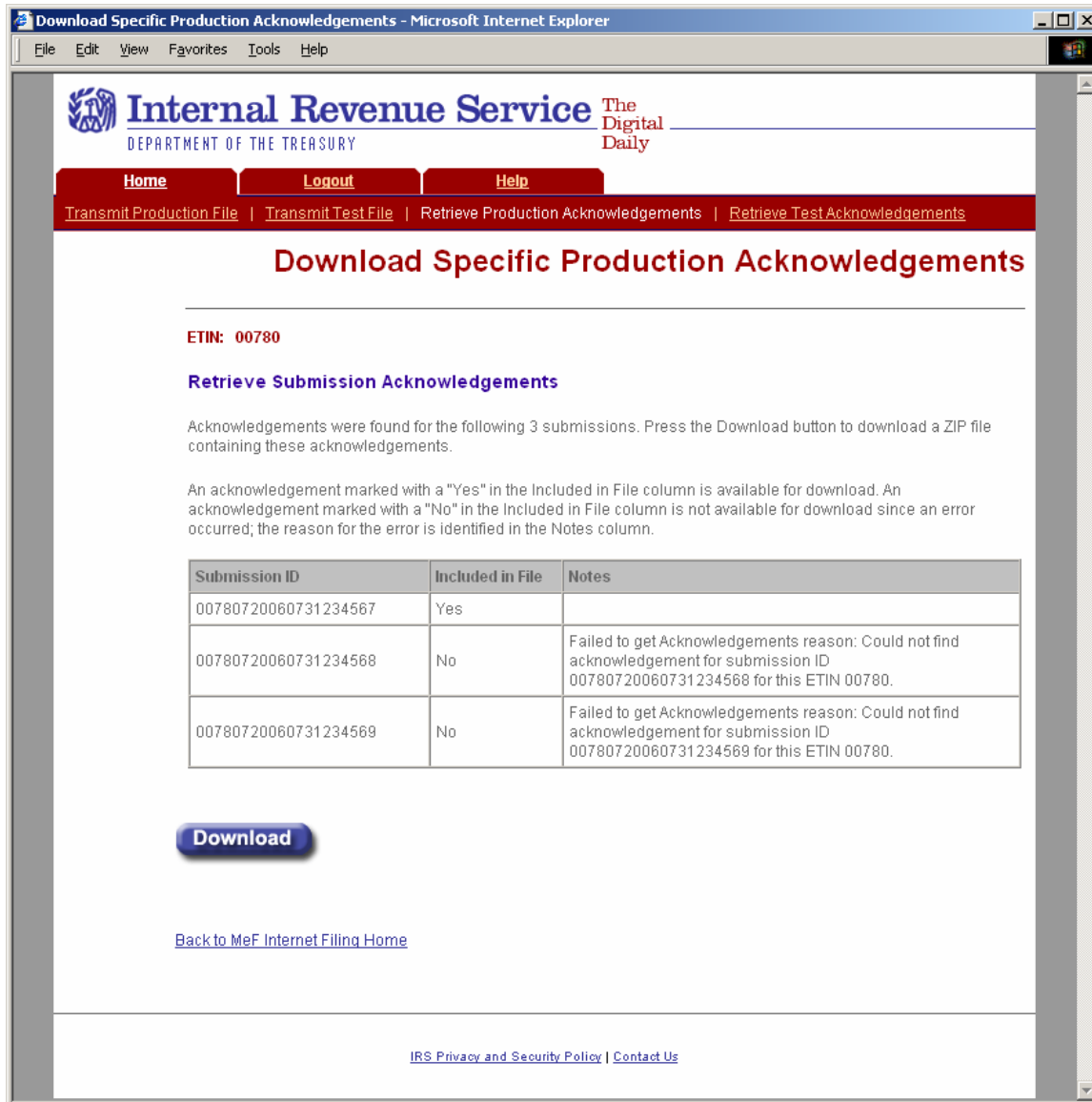

Figure 6-21: Download Specific Production Acknowledgements Page

Download Popups

During the download process, the following screens will display; screens will vary based on the configuration and version of the transmitter's operating system and browser. The following screens are from Internet Explorer 6.0 running on Windows 2000.

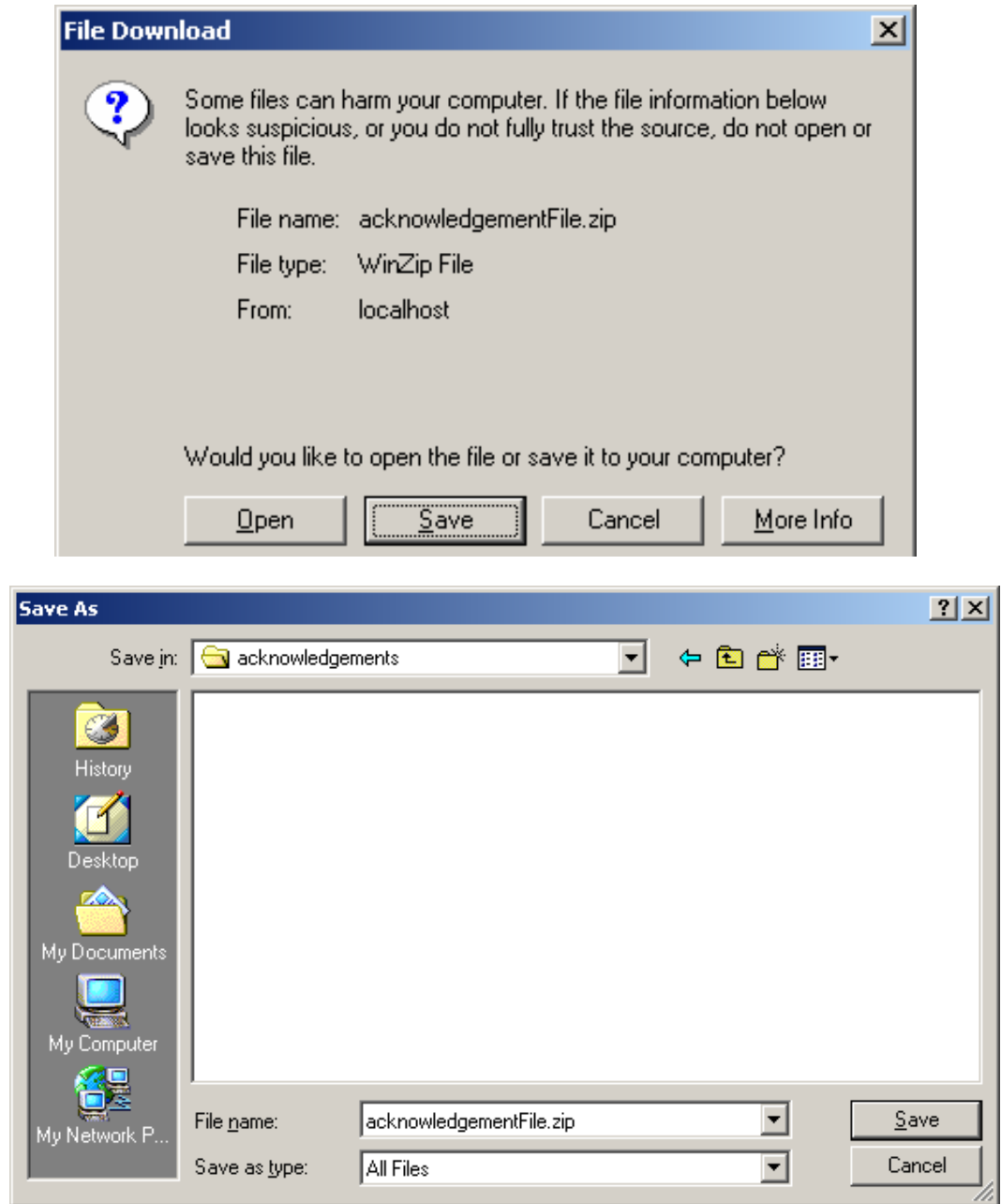

Figure 6-22: File Download and File Destination Windows

6.2 Retrieving Production Federal and/or State Submission Status Records

A transmitter performs the following steps to retrieve Production/Test submission status records:

- View a list of states participating in the Fed/State program
- Select an option to retrieve either Production or Test submission status records
- Select an ETIN to associate with the Production/Test submission status records
- Submit a request to retrieve the Production/Test submission status records
- Download new Production submission status records
- Download specific Production submission status records based on Submission ID

View a List of Participating States

The transmitter may review a list of participating states by clicking the List Participating States link at the bottom of the MeF Internet Filing Home page. (See Figure 6-9)

The Select ETIN for Production Submission Status Records page displays. This page shows all ETINs (unique) authorized for the transmitter's use, in order sorted horizontally. Click the radio button of the ETIN to be associated with the Production list of participating states. Click the **Continue** button.

The screenshot shows a web browser window titled "Select ETIN for List Participating States - Microsoft Internet Explorer". The page header includes the Internal Revenue Service logo and the text "The Digital Daily". A navigation bar contains "Home", "Logout", and "Help" buttons. Below the navigation bar are links for "Transmit Production File", "Transmit Test File", "Retrieve Production Acknowledgements", and "Retrieve Test Acknowledgements". The main heading is "Select ETIN for List Participating States". The page content includes the text "Select ETIN" and "The list of ETIN(s) associated with your account in the Production system is shown below. Please select the ETIN that you would like to use to retrieve acknowledgements and press the Continue button." Below this text is a section titled "Choose an ETIN" with a right-pointing arrow. There are two rows of radio buttons with corresponding ETIN numbers: 00032, 00033, 00034, 00035, 00036, 00050 in the first row; and 00051, 00052, 00053, 00060, 00780 in the second row. The radio button for 00780 is selected. A blue "Continue" button is located below the list of ETINs. At the bottom of the page, there are links for "IRS Privacy and Security Policy" and "Contact Us".

Figure 6-23: Select ETIN for Production List Participating States Page

Initiate a Request for Production Federal and/or State Submission Status Records

Click the Retrieve Production Submission Status Records at the bottom of the page.

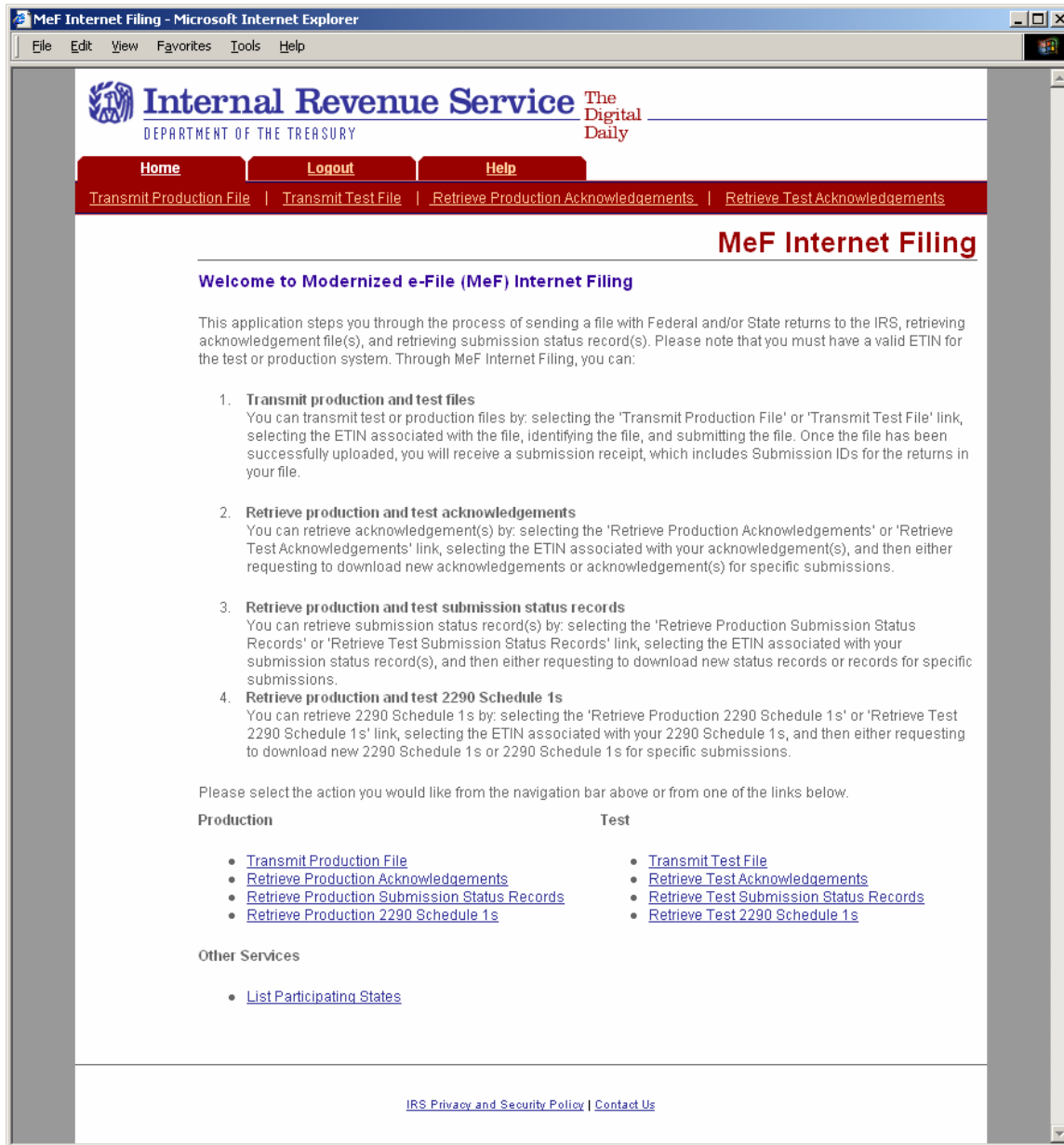

Figure 6-24: MeF Internet Filing Home Page

Select an ETIN Associated with Production Submission Status Records

When the transmitter selects the **Retrieve Production Submission Status Records** link from the MeF Internet Filing Home page, the Select ETIN for Production Submission Status Records page displays. This page shows all ETINs (unique) authorized for the transmitter's use, in order sorted horizontally.

Click the radio button of the ETIN to be associated with the Production submission status records.

Click the **Continue** button.

Select ETIN for Production Submission Status Records - Microsoft Internet Explorer

File Edit View Favorites Tools Help

Internal Revenue Service The Digital Daily
DEPARTMENT OF THE TREASURY

Home Logout Help

Transmit Production File | Transmit Test File | Retrieve Production Acknowledgements | Retrieve Test Acknowledgements

Select ETIN for Production Submission Status Records

Select ETIN

The list of ETIN(s) associated with your account in the Production system is shown below. Please select the ETIN that you would like to use to retrieve submission status records and press the Continue button.

Choose an ETIN ▶

00232 00298 00589 00632 00698 00780
 00898 00963 00985

Continue

[IRS Privacy and Security Policy](#) | [Contact Us](#)

Figure 6-25: Select ETIN for Production Submission Status Records Page

Retrieve Production Submission Status Records

The Retrieve Production Submission Status Records page allows the transmitter to retrieve either specific previously downloaded submission status records, or all new submission status records (i.e., not previously downloaded).

Click the **Retrieve new submission status records** radio button to retrieve new submission status records (selected by default).

Enter a number between 1 and the configurable maximum in the **Enter Number of Submission Status Records** text box, to specify the number of submission status records to retrieve at one time.

Note: The maximum number of submission status records a transmitter can submit for retrieval is configurable. If the transmitter doesn't specify a number, then the default maximum number will be used.

or

Click the Retrieve previously downloaded submission status records based on Submission ID(s) radio button to retrieve specific submission status records.

Enter the Submission ID(s) to be retrieved in the **Enter Submission ID(s)** text box.

Note: Each Submission ID should be separated by a comma, followed by a space. (Submission IDs are listed on Submission Receipts, reporting the successful transmission of a message.)

Click the **Submit** button.

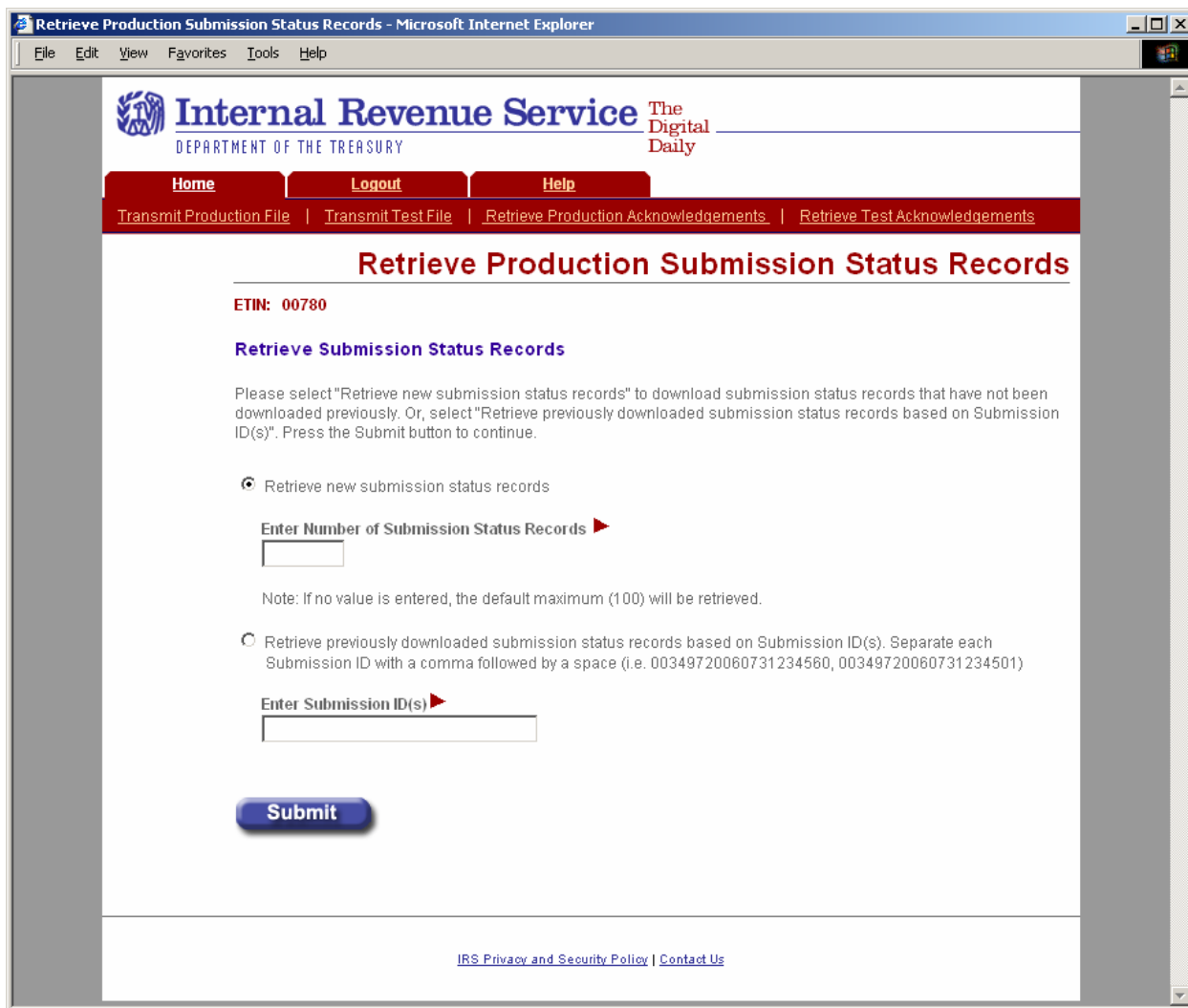

Figure 6-26: Retrieve Production Submission Status Records Page

Status Records Not Found Error

This error page displays when no submission status records were found for the ETIN and submission status record type submitted by the transmitter.

Click the **Home** tab on the navigation bar or click **Back to MeF Internet Filing Home** to return to the MeF Internet Filing Home page.

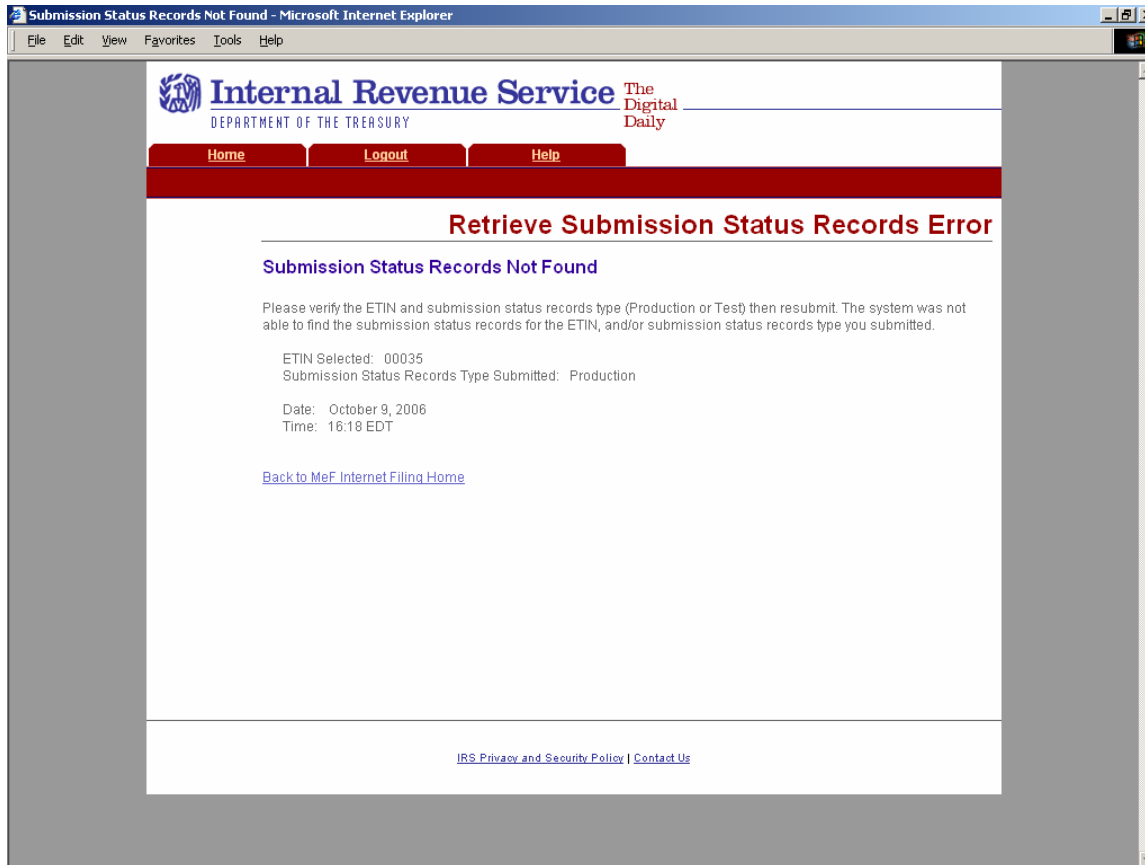

Figure 6-27: Retrieve Submission Status Records Error – Status Records Not Found

Download New Production Submission Status Records

If the transmitter elects to retrieve new submission status records on the Retrieve Production Submission Status Records page (see Figure 6-27), the Download New Production Submission Status Records page displays, showing any new status records found. Click the **Download** button for a ZIP file containing the submission status records shown in the table.

Important! Since these records will no longer be marked new, you should either download the records before leaving this page or print this page for future reference. To view any additional status records you don't download now, you will have to request the records by Submission ID.

If you see the message "There are additional new submission status records available for retrieval." click the **Get More** button to return to the Select ETIN for Production Submission Status Records page (see Figure 6-26) to begin the process for downloading these additional records.

Or, click either the **Home** tab on the navigation bar or the **Back to MeF Internet Filing Home** link to return to the MeF Internet Filing Home page.

Download New Production Submission Status Records

ETIN: 00780

Retrieve Submission Status Records

5 submission status records were requested. 5 submission status records were found and are shown in the table below. Press the Download button for a ZIP file containing these records.

If you see a message indicating the availability of additional status records for retrieval, press the Get More button to download these records.

Warning! These status records are no longer marked new. Please either print the page or download the data before leaving this page, otherwise you will have to request the status records by Submission ID if you want to view them again.

There are additional submission status records available for retrieval.

Submission ID	Status Record
00780720060731234566	Received
00780720060731234567	Received
	Denied by IRS
00780720060731234568	Received
	Ready for Pick-Up

Download **Get More**

[Back to MeF Internet Filing Home](#)

[IRS Privacy and Security Policy](#) | [Contact Us](#)

Figure 6-28 Download New Production Submission Status Records Page

Download Specific Production Status Records

If the transmitter elects to retrieve previously downloaded submission status records (based on Submission ID) on the Retrieve Production Submission Status Records page (see Figure 6-27), the Download Specific Production Submission Status Records page displays, showing the previously downloaded status records. Click the **Download** button for a ZIP file containing the submission status records shown in the table.

Or, click either the **Home** tab on the navigation bar or the **Back to MeF Internet Filing Home** link to return to the MeF Internet Filing Home page.

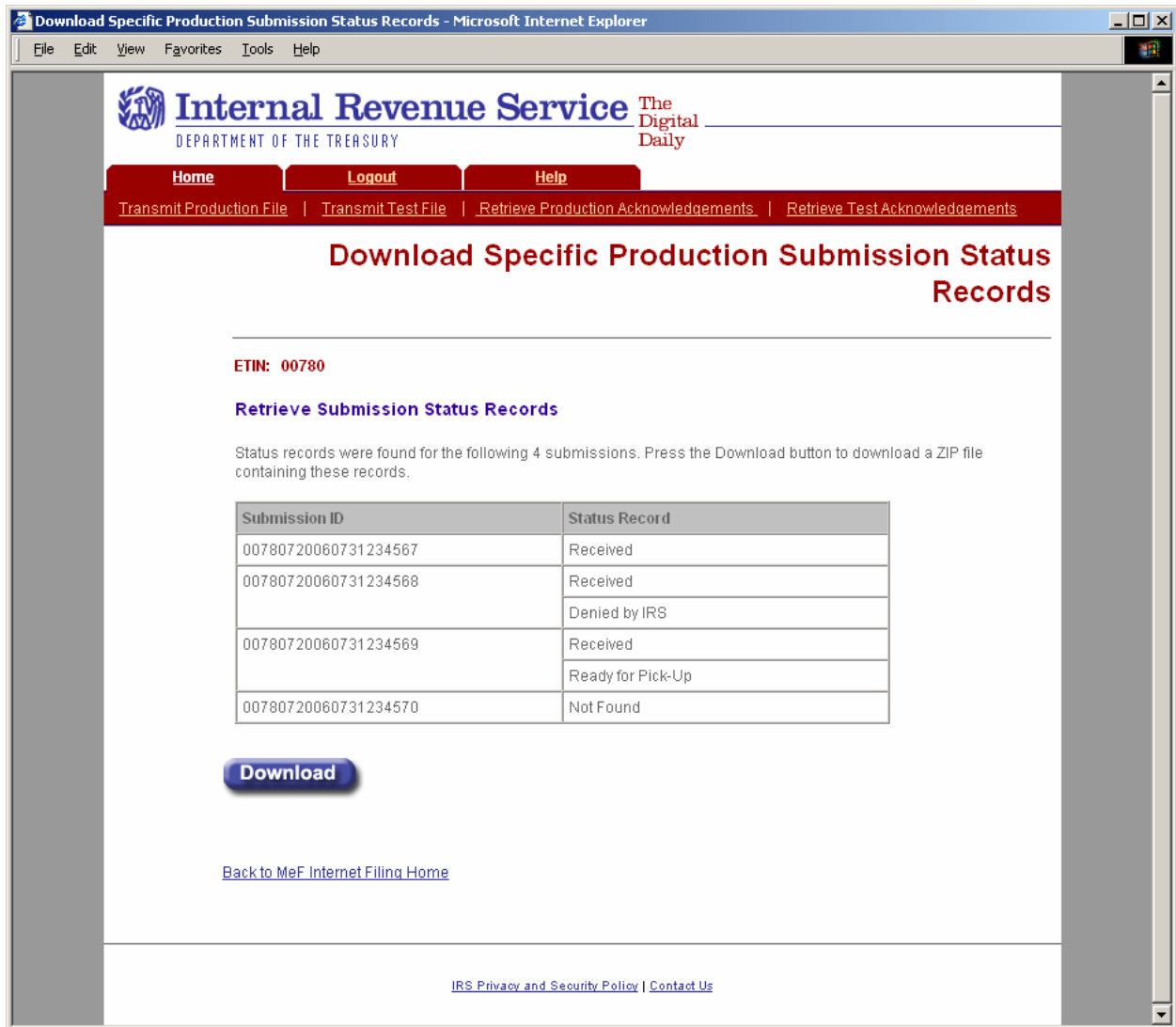

The screenshot shows a web browser window titled "Download Specific Production Submission Status Records - Microsoft Internet Explorer". The page header includes the Internal Revenue Service logo and the text "The Digital Daily". A navigation bar contains tabs for "Home", "Logout", and "Help". Below the navigation bar are links for "Transmit Production File", "Transmit Test File", "Retrieve Production Acknowledgements", and "Retrieve Test Acknowledgements". The main heading is "Download Specific Production Submission Status Records". The page displays "ETIN: 00780" and a link to "Retrieve Submission Status Records". A message states: "Status records were found for the following 4 submissions. Press the Download button to download a ZIP file containing these records." Below this is a table with the following data:

Submission ID	Status Record
00780720060731234567	Received
00780720060731234568	Received Denied by IRS
00780720060731234569	Received Ready for Pick-Up
00780720060731234570	Not Found

Below the table is a blue "Download" button. At the bottom of the page, there is a link "Back to MeF Internet Filing Home" and a footer with "IRS Privacy and Security Policy | Contact Us".

Figure 6-29: Download Specific Production Submission Status Records Page

6.3 Retrieving Acknowledgements through Application-to-Application (A2A)

Transmitters and state agencies communicate with the MeF system using a series of service requests that are accomplished using messages. The service requests include:

MeF Application-to-Application		
SERVICE REQUEST	TRANSMITTER	STATE AGENCY
Get New Acknowledgements	X	
Get Acknowledgements	X	
Get Acknowledgement	X	
Get Acknowledgements by Message ID	X	

As submissions are validated, the acknowledgements are generated and made available to the transmitter for retrieval. All the submissions in the originating SendSubmissions request do not have to process before acknowledgements become available to the transmitter. When the transmitter requests GetNewAcknowledgements, he/she indicates within the request how many acknowledgements he/she wants to download (up the maximum of 100). The system will make available to the transmitter as many acknowledgements as are available, up to the count he/she requested. The response message provides information in the MoreAvailable field. If the value in that field is "false" then there are no more acknowledgements ready to retrieve. If the value in that field is "true", then there are more acknowledgements available to download. It is important to note that these acknowledgements can be for submissions from different SendSubmissions messages sent by the transmitter.

A2A does not have a transmission acknowledgement. There is a response that contains a receipt. If errors are found in the message, the message service response indicates the error with the letter 'E' appended to the end of the message ID, and the response itself contains the specific error. These are not retrieved through the GetNewAcknowledgements service request. The service request response handles all this.

There are four Get Acknowledgement types:

1. GetNewAcknowledgements - This request retrieves acknowledgements not previously retrieved
2. GetAcknowledgement - This request requires the submission ID of the submission for the acknowledgement being requested.
3. GetAcknowledgements up to max count - This request requires the submission IDs of the submissions for which the acknowledgements being requested.
4. GetAcknowledgementsByMsgId – This request requires the Message ID for the acknowledgements being requested.

For more information about A2A, refer to the *MeF State and Trading Partners ICD* and the *MeF Submission Composition Guide*.

6.4 Retrieving State Submissions through Application-to-Application (A2A)

State agencies communicate with the MeF system using a series of service requests that are accomplished using messages. The service requests include:

MeF Application-to-Application		
SERVICE REQUEST	TRANSMITTER	STATE AGENCY
Get New Submissions		X
Get Submission		X
Get Submissions		X
Get Submissions by Message ID		X

The State applications will have authorization to programmatically request a Web Service to retrieve submissions. Each State is responsible for validating their State submissions and will be responsible for generating a State acknowledgement for each State submission which will be returned to the IRS for retrieval by the transmitter. Both Federal and State returns must be in XML format, with optional PDF, when allowed by the state.

There are four Get Submission types:

1. GetNewSubmissions - This request retrieves submissions not previously retrieved, up to max count.
2. GetSubmission - This request requires the submission ID of the submission requested.
3. GetSubmissions - This request requires the submission IDs of the submissions requested.
4. GetSubmissionsByMsgID - This request requires the message ID of the submissions requested.

For more information about A2A, refer to the *MeF State and Trading Partners ICD* and the *MeF Submission Composition Guide*.

7 Payment Options

7.1 Electronic Funds Withdrawal

The MeF Program will allow a taxpayer to pay the balance due on Form 1120/1120-F/1120S/1120-POL/990-PF/1065/1065-B/720/2290 tax returns or the 7004/8868 extension forms by authorizing an electronic funds withdrawal. If the taxpayer chooses this payment method, they may authorize the entire payment (or a partial payment) be made at the time that their tax return/extension form is electronically filed. Note: only the entire payment can be made for the balance due on Form 8868.

The payment amount cannot be greater than the tax due on the electronic tax return or form. The taxpayer must specify the bank account from which they wish to have the payment withdrawn and the date on which the withdrawal will be made. This allows the taxpayer to pay the balance due as soon as the tax return or form is processed or schedule the payment for withdrawal on a future date, not later than the return's due date. For returns transmitted after the due date, the payment date must be the same as the date the return is transmitted. Domestic corporations must deposit all income tax payments by using the Electronic Federal Tax Payment System (EFTPS) or with Form 8109, Federal Tax Deposit Coupon, by the due date of the return. If the corporation expects to have a net operating loss carryback, the corporation can reduce the amount to be deposited to the extent of the overpayment resulting from the carryback, provided all other prior year tax liabilities have been fully paid and Form 1138, Extension of Time for Payment of Taxes by a Corporation Expecting a Net Operating Loss Carryback, is filed with Form 7004.

Additional EFTPS information is posted to: <http://www.irs.gov/efile/article/0,,id=98005,00.html>

Form 7004 does not extend the time to pay tax. If the entity is a corporation or affiliated group of corporations filing a consolidated return, the corporation must remit the amount of the unpaid tax liability shown on line 8 on or before the due date of the return. If you file Form 7004 electronically, you can pay by Electronic Funds Withdrawal (EFW). Refer to Form 8878-A. A trust (Form 1041), electing large partnership (Form 1065-B), or REMIC (Form 1066) will be granted an extension even if it cannot pay the full amount shown on line 8. But it should pay as much as it can to limit the amount of penalties and interest it will owe. Foreign corporations that maintain an office or place of business in the United States should pay their tax as described above for domestic corporations. If you are requesting an extension of time to file Form 1042, see the deposit rules in the instructions for the form to determine how payment must be made.

Entities that do not bank in the United States that need to make a payment, cannot pay using EFW or EFTPS. On all checks or money orders, write the entity's taxpayer identification number (TIN), the type of tax return, and the tax year to which the payment applies. Make the check or money order payable to "United States Treasury." and at least 1/2 inch margin. Information is to be presented in a two column format, with the left column containing affiliates' name and address, and the right column containing the TIN with 1/2 inch between the columns. There should be two blank lines between listed affiliates.

If the electronic funds withdrawal (EFW) is authorized, an IRS Payment record must be attached

to the electronic return and an EFW consent statement must be signed as described in Section 7, Electronic Signature Specifications.

Note: the payment record can only be attached at the top level return and any payment attached otherwise will not be processed.

The following information is required in the payment record:

(See items in the payment schema, Figure 7-1.)

- Routing Transit Number
- Bank Account Number
- Account Type
- Payment Amount
- Requested Payment Date
- Taxpayer's Daytime Phone Number

It is important to note that the following twenty day rule does not apply to payments:

If a submission was rejected, a return can be corrected within 20 days and be given the received date of the original rejected return. In case the return is rejected on the due date, it is recommended that the EFW payment not be transmitted with the return. The balance due can be paid by EFTPS or check/money order to avoid late fees.

IRS Payment Schema

Figure 7-1

```

<?xml version="1.0" encoding="UTF-8" ?>
<xsd:schema targetNamespace="http://www.irs.gov/efile" xmlns="http://www.irs.gov/efile" xmlns:xsd="http://www.w3.org/2001/XMLSchema"
  elementFormDefault="qualified" attributeFormDefault="unqualified" version="1.0">
  <xsd:annotation>
  <xsd:documentation>
  <Description>IRS e-file Corporate Income Tax Schema - IRS Payment</Description>
  <TaxYear>2007</TaxYear>
  <MaturityLevel>Draft Release</MaturityLevel>
  <ReleaseDate>October 22, 2007</ReleaseDate>
  </xsd:documentation>
  </xsd:annotation>
  <xsd:include schemaLocation="../../../Common/efileTypes.xsd" />
  - <!-- ===== -->
  - <!-- ===== IRS Payment ===== -->
  - <!-- ===== -->
  <xsd:element name="IRSPayment">
  <xsd:annotation>
  <xsd:documentation>IRS Payment</xsd:documentation>
  </xsd:annotation>
  <xsd:complexType>
  <xsd:complexContent>
  <xsd:extension base="IRSPaymentType">
  <xsd:attributeGroup ref="DocumentAttributes">
  <xsd:annotation>
  <xsd:documentation>Common return document attributes</xsd:documentation>
  </xsd:annotation>
  </xsd:attributeGroup>
  <xsd:attribute name="documentName" type="StringType" fixed="IRSPayment">
  <xsd:annotation>
  <xsd:documentation>IRS internal use only. To avoid error in the return, do not include the attribute name or value.</xsd:documentation>
  </xsd:annotation>
  </xsd:attribute>
  </xsd:extension>
  </xsd:complexContent>
  </xsd:complexType>
  </xsd:element>
  <xsd:complexType name="IRSPaymentType">
  <xsd:annotation>
  <xsd:documentation>Content model for IRS Payment</xsd:documentation>
  </xsd:annotation>
  <xsd:sequence>
  - <!-- Routing Transit Number -->
  <xsd:element name="RoutingTransitNumber" type="RoutingTransitNumberType">
  <xsd:annotation>
  <xsd:documentation>Routing Transit Number</xsd:documentation>
  </xsd:annotation>
  </xsd:element>
  - <!-- Bank Account Number -->
  <xsd:element name="BankAccountNumber" type="BankAccountNumberType">
  <xsd:annotation>
  <xsd:documentation>Bank Account Number</xsd:documentation>
  </xsd:annotation>
  </xsd:element>
  - <!-- Type of Account -->
  <xsd:element name="AccountType" type="BankAccountType">
  <xsd:annotation>
  <xsd:documentation>Type of Account</xsd:documentation>
  </xsd:annotation>
  </xsd:element>
  - <!-- Payment Amount -->
  <xsd:element name="PaymentAmount">
  <xsd:annotation>
  <xsd:documentation>Payment Amount in Whole Dollars</xsd:documentation>
  </xsd:annotation>
  <xsd:simpleType>
  <xsd:restriction base="IntegerPosType">
  <xsd:totalDigits value="11" />
  </xsd:restriction>

```

```

</xsd:simpleType>
</xsd:element>
- <!-- Requested Payment Date -->
<!-- RequestedPaymentDate" type="DateType">
<!-- Requested Payment Date-->
</xsd:documentation>
</xsd:annotation>
</xsd:element>
- <!-- Taxpayer Daytime Phone -->
<!-- TaxpayerDaytimePhone" type="PhoneNumberType">
<!-- Taxpayer's Daytime Phone Number-->
</xsd:documentation>
</xsd:annotation>
</xsd:element>
</xsd:sequence>
</xsd:complexType>
</xsd:schema>

```

The following is a sample of business rule checks to ensure a routing number is in the payment record. The complete list of business rules is found on each form’s respective irs.gov website shown below.

R0000-049	Bank Account Number (in Direct Deposit and IRS Payment Record) must not equal all zero(s).	Incorrect Data	Reject	720, 2290, 1120, 1120-F, 1120S, 1120-POL, 990-PF, 8868, 7004
R0000-050	Bank Account Number in IRS Payment Record must not equal all zeros or all blanks.	Incorrect Data	Reject	720, 2290, 1120, 1120-F, 1120S, 1120-POL, 990-PF, 8868, 7004, 1065, 1065-B
R0000-075	The Routing Transit Number (RTN) must conform to the banking industry RTN algorithm.	Incorrect Data	Reject	720, 2290, 1120, 1120-F, 1120S, 1120-POL, 990-PF, 8868, 7004, 1065, 1065-B

R0000-906	Routing Transit Number (RTN) included in the return must be present in the e-File database.	Database Validation Error	Reject	720, 2290, 1120, 1120-F, 1120S, 1120-POL, 990-PF, 8868, 7004, 1056, 1065-B
-----------	---	---------------------------	--------	--

The following is a sample of business rules associated with the IRS Payment record. The complete list of business rules is found on each form's respective irs.gov website shown below.

Rule Number	Rule Text	Error Category	Severity	Tax Type
FPYMT-017	"Payment Amount" in the IRS Payment Record must equal the amount on Form 7004, Line 8 "Balance Due".	Incorrect Data	Reject	7004
FPYMT-018	Tax payer's Day Time Phone Number in IRS Payment Record cannot equal all zeros.	Incorrect Data	Reject	720 2290 1120 1120S 1120-F 1120-POL 990-PF 8868, 7004, 1065, 1065-B
FPYMT-024	"Payment Amount" in the IRS Payment Record must not be greater than Form 1120-POL, Line 24.	Incorrect Data	Reject	1120-POL
FPYMT—27	If the timestamp (in the GTX key or Response to Send Submissions Request) is on or before the due date of the return (three and one half months after the "TaxPeriodEndDate" in the Return Header), then the "RequestedPaymentDate" in the IRS Payment Record must be on the due date or before the due date but not more than five days prior to the received date.	Incorrect Data	Reject	1065 1065-B
FPYMT-029	If the timestamp is on or before the due date of the return (two months and 15 days after the "TaxPeriodEndDate" in the Return Header), then the "RequestedPaymentDate" in the IRS Payment Record must be on the due date or before the due date but not more than five days prior to the received date.	Incorrect Data	Reject	1120 1120-F 1120S 1120-POL
FPYMT-030	Payment Amount in the IRS Payment Record must not be greater than Form 2290, Line 6 "Balance Due"	Incorrect Data	Reject	2290

All MeF business rules can be found on the irs.gov website as follows:

- 1120/1120-F/1120S/7004 - <http://www.irs.gov/taxpros/providers/article/0,,id=97626,00.html>.
- For 1065/1065-B – <http://www.irs.gov/efile/article/0,,id=153999,00.html>
- For 990/990-EZ/990-N/990-PF/1120-POL/8868 - <http://www.irs.gov/charities/article/0,,id=105955,00.html>
- For 720/2290 - <http://www.irs.gov/efile/article/0,,id=169093,00.html>

Check for the latest updates!

Credit Card

The IRS announced a policy decision in 2002 to allow business *e-filers* to pay their balance due by credit card. Although this payment option is not currently applicable for any MeF-related software, the tax preparation software industry should contact the IRS if they want to incorporate a credit card tax payment option in their MeF software for Form 1120/1120-F, 1120S/1120-POL, 1065/1065-B, 990-PF, 7004 and 8868 filers. The credit card payment data (card number and expiration date) must be collected during the return e-filing process and before the return is transmitted. The credit card tax payment data is forwarded to the IRS separately from the return. Once the *e-filed* return is accepted, the tax payment data will be forwarded to the IRS in an Electronic Data Interchange (EDI) format as described in the Credit Card Bulk Filer Requirements.

We are including a link to the technical specifications for integrating a credit card tax payment option into a software product. Any software developer that wishes to offer an integrated *e-file* and pay credit card option to business (or individual) *e-filers* may do so non-competitively.

The URL for the integrated file and pay Credit Card Bulk Filer Requirements is shown below. Sections 1 - 4 describe the technical EDI requirements. Section 5 includes specific instructions for bulk filer registration, and terms and conditions. Annual registration is required. While we generally accept registration forms up to September of each year, to ensure that ample testing time is scheduled, early registration is strongly encouraged.

http://www.irs.gov/pub/irs-schema/2006_credit_card_bulk_provider_requirements_rev_2.0.doc

Payment Cancellation

To revoke or cancel any EFW payment, contact the U.S. Treasury Financial Agent, toll-free, at 1-888-353-4537. Cancellation requests must be received no later than 8:00 p.m., Eastern Standard Time, at least two business days prior to the scheduled payment date. If there is a change to the bank account information provided on the return or form, call this number to cancel the scheduled payment. You may also call this number to inquire about the status of an EFW payment. You can also call 1-800-829-4933 ten (10) days after the requested payment date to confirm receipt of your payment. When calling, please be ready to provide the Employer Identification Number, the payment amount, and the bank account number.

8 MeF Alternative Signatures

The MeF system requires taxpayers and Electronic Return Originators (EROs) to use one of the alternative signature options for signing electronic returns. The two available options are the Practitioner PIN method and the Scanned Form 8453. The selected signature option must be identified in the Return Header. (Please refer to the items in the Return Header, [Figure 7-1](#).) MeF validates that a signature exists for each return. If the taxpayer uses a PIN to sign the return, all the appropriate PIN information must be present in the return header. If the taxpayer elects to sign a Form 8453, the scanned 8453 must be attached to the return. (A paper copy of the Form 8453 must not be sent to the IRS.) If the electronic return does not contain the required signatures, it will be rejected.

Any taxpayer who does not use an ERO (e.g., a large taxpayer or any taxpayer who uses an On-line provider), who needs to submit a payment with their extension, can now *e-file* the extension in 2008.

Note: Form 8868 - Application for Extension of Time to File an Exempt Organization Return, no longer requires a signature, unless there is a payment attached.

8.1 Practitioner PIN Option

The Practitioner PIN option **cannot** be used by a large taxpayer or by a taxpayer who is filing through an On-Line Provider. They must use a Form 8453 signature document as the signature alternative. If the signature option of “PIN Number” is chosen, the taxpayer and ERO will be required to sign the return with a personal identification number (PIN). The Practitioner PIN option consists of two PINs – one for the taxpayer and one for the Practitioner.

- 1) **Taxpayer PIN** --The taxpayer chooses the PIN that they wish to use to sign their return. The Taxpayer’s PIN must be 5 numeric characters and cannot contain all zeros.
- 2) **Practitioner PIN** --The ERO selects an eleven position PIN to sign the return. The first 6 positions of the Practitioner PIN will be made up of the EFIN of the ERO and the next 5 positions will be made up of 5 numeric characters that the ERO will select.

The taxpayer must decide whether they want to enter their own PIN or whether they authorize the ERO to enter the PIN they choose as their signature. This authorization is made on the following forms (PDF links included below):

Form 8879-C for Form 1120	http://www.irs.gov/pub/irs-pdf/f8879c.pdf
Form 8879-I for Form 1120-F (draft)	http://www.irs.gov/pub/irs-dft/f8879i--dft.pdf
Form 8879-S for Form 1120S	http://www.irs.gov/pub/irs-pdf/f8879s.pdf
Form 8879-EO for Exempt Organization returns	http://www.irs.gov/pub/irs-pdf/f8879eo.pdf
Form 8879-PE for Form 1065	http://www.irs.gov/pub/irs-pdf/f8879pe.pdf
Form 8879-B for Form 1065-B	http://www.irs.gov/pub/irs-pdf/f8879b.pdf
Form 8879-EX for Forms 720, 2290 and 8849	http://www.irs.gov/pub/irs-pdf/f8879ex.pdf

The required PIN information is placed in the Return Header. Please refer to the items in the Return Header Schema, [Figure 8-1](#).

Return Header Schema Figure 8-1

```

<?xml version="1.0" encoding="UTF-8" ?>
- <xsd:schema targetNamespace="http://www.irs.gov/efile" xmlns="http://www.irs.gov/efile"
  xmlns:xsd="http://www.w3.org/2001/XMLSchema" elementFormDefault="qualified" attributeFormDefault="unqualified"
  version="1.0">
- <xsd:annotation>
- <xsd:documentation>
<Description>IRS e-file Corporate Return Header</Description>
<TaxYear>2007</TaxYear>
<MaturityLevel>Final Release</MaturityLevel>
<ReleaseDate>December 7, 2007</ReleaseDate>
  </xsd:documentation>
  </xsd:annotation>
  <xsd:include schemaLocation="../../../Common/efileTypes.xsd" />
- <xsd:complexType name="ReturnHeaderType">
- <xsd:annotation>
  <xsd:documentation>Content model for the corporate tax return</xsd:documentation>
  </xsd:annotation>
- <xsd:sequence>
- <!-- Date and Time Stamp -->
- <xsd:element name="Timestamp" type="TimestampType">
- <xsd:annotation>
  <xsd:documentation>The date and time when the return was created</xsd:documentation>
  </xsd:annotation>
  </xsd:element>
  - <!-- Tax Period End Date -->
  <xsd:element name="TaxPeriodEndDate" type="DateType" />
  - <!-- Disaster Relief -->
  <xsd:element name="DisasterRelief" type="LineExplanationType" minOccurs="0" />
  - <!-- Intermediate Service Provider Number -->
  <xsd:element name="ISPNumber" type="ISPType" minOccurs="0" />
  - <!-- PreparerFirm -->
  <xsd:element name="PreparerFirm" minOccurs="0">
- <xsd:complexType>
- <xsd:sequence>
- <xsd:choice minOccurs="0">
  <xsd:element name="EIN" type="EINType" />
- <xsd:element name="MissingEINReason">
- <xsd:simpleType>
- <xsd:restriction base="StringType">
  <xsd:enumeration value="APPLD FOR" />
  <xsd:enumeration value="FOREIGNUS" />
  </xsd:restriction>
  </xsd:simpleType>
  </xsd:element>
  </xsd:choice>
  <xsd:element name="PreparerFirmBusinessName" type="BusinessNameType" />
- <xsd:choice>
  <xsd:element name="PreparerFirmUSAddress" type="USAddressType" />
  <xsd:element name="PreparerFirmForeignAddress" type="ForeignAddressType" />
  </xsd:choice>
  </xsd:sequence>
  </xsd:complexType>
  </xsd:element>
  - <!-- Software Identification -->
  <xsd:element name="SoftwareId" type="SoftwareIdType" />
  - <!-- Software Version -->
  <xsd:element name="SoftwareVersion" type="SoftwareVersionType" minOccurs="0" />
  - <!-- Multiple Software Packages Used ? -->
  <xsd:element name="MultipleSoftwarePackagesUsed" type="BooleanType" />
  - <!-- Originator -->

```

```

:: <xsd:element name="Originator">
:: <xsd:complexType>
:: <xsd:sequence>
<xsd:element name="EFIN" type="EFINType" />
<xsd:element name="Type" type="OriginatorType" />
- <!-- Practitioner PIN -->
:: <xsd:element name="PractitionerPIN" minOccurs="0">
:: <xsd:complexType>
:: <xsd:sequence>
<xsd:element name="EFIN" type="EFINType" />
<xsd:element name="PIN" type="PINType" />
  <xsd:sequence>
  <xsd:complexType>
  <xsd:element>
  <xsd:sequence>
  <xsd:complexType>
  <xsd:element>
  - <!-- PIN entered by -->
:: <xsd:element name="PINEnteredBy" minOccurs="0">
:: <xsd:simpleType>
:: <xsd:restriction base="StringType">
<xsd:enumeration value="Taxpayer" />
<xsd:enumeration value="ERO" />
  </xsd:restriction>
  </xsd:simpleType>
  </xsd:element>
  - <!-- Signature Option -->
:: <xsd:element name="SignatureOption" minOccurs="0">
:: <xsd:simpleType>
:: <xsd:restriction base="StringType">
<xsd:enumeration value="PIN Number" />
<xsd:enumeration value="Binary Attachment 8453 Signature Document" />
  </xsd:restriction>
  </xsd:simpleType>
  </xsd:element>
  - <!-- Return Identifiers -->
:: <xsd:element name="ReturnType">
:: <xsd:simpleType>
:: <xsd:restriction base="StringType">
<xsd:enumeration value="1120" />
<xsd:enumeration value="1120S" />
  </xsd:restriction>
  </xsd:simpleType>
  </xsd:element>
  - <!-- Tax Period Begin Date -->
<xsd:element name="TaxPeriodBeginDate" type="DateType" />
  - <!-- Filer -->
:: <xsd:element name="Filer">
:: <xsd:complexType>
:: <xsd:sequence>
<xsd:element name="EIN" type="EINType" />
<xsd:element name="Name" type="BusinessNameType" />
<xsd:element name="InCareOfName" type="InCareOfNameType" minOccurs="0" />
<xsd:element name="NameControl" type="BusinessNameControlType" />
:: <xsd:choice>
<xsd:element name="USAddress" type="USAddressType" />
<xsd:element name="ForeignAddress" type="ForeignAddressType" />
  </xsd:choice>
  </xsd:sequence>
  </xsd:complexType>
  </xsd:element>
  - <!-- Officer -->
:: <xsd:element name="Officer">
:: <xsd:complexType>
:: <xsd:sequence>
<xsd:element name="Name" type="PersonNameType" />
<xsd:element name="Title" type="PersonTitleType" />
<xsd:element name="TaxpayerPIN" type="PINType" minOccurs="0" />
:: <xsd:choice minOccurs="0">
<xsd:element name="Phone" type="PhoneNumberType" />
<xsd:element name="ForeignPhone" type="ForeignPhoneNumberType" />

```

```

</xsd:choice>
<xsd:element name="EmailAddress" type="EmailAddressType" minOccurs="0" />
<xsd:element name="DateSigned" type="DateType" minOccurs="0" />
<xsd:element name="AuthorizeThirdParty" type="BooleanType" minOccurs="0" />
</xsd:sequence>
</xsd:complexType>
</xsd:element>
- <!-- Preparer -->
<xsd:element name="Preparer" minOccurs="0">
<xsd:complexType>
<xsd:sequence>
<xsd:element name="Name" type="PersonNameType" minOccurs="0" />
<xsd:choice>
<xsd:element name="SSN" type="SSNType" />
<xsd:element name="PTIN" type="PTINType" />
</xsd:choice>
<xsd:choice minOccurs="0">
<xsd:element name="Phone" type="PhoneNumberType" />
<xsd:element name="ForeignPhone" type="ForeignPhoneNumberType" />
</xsd:choice>
<xsd:element name="EmailAddress" type="EmailAddressType" minOccurs="0" />
<xsd:element name="DatePrepared" type="DateType" minOccurs="0" />
<xsd:element name="SelfEmployed" type="CheckboxType" minOccurs="0" />
</xsd:sequence>
</xsd:complexType>
</xsd:element>
- <!-- Tax Year -->
<xsd:element name="TaxYear" type="YearType" />
</xsd:sequence>
- <!-- Binary Attachment Count -->
<xsd:attribute name="binaryAttachmentCount" type="IntegerNNTYPE" use="required">
<xsd:annotation>
<xsd:documentation>The number of binary attachments in the return</xsd:documentation>
</xsd:annotation>
</xsd:attribute>
</xsd:complexType>
</xsd:schema>

```

The following business rules are associated with the Practitioner PIN.

Rule Number	Rule Text	Error Category	Severity	Forms
R0000-029	If the Signature Option "PIN Number" is selected (the element "SignatureOption" in the Return Header has a value of "PIN Number") then the following fields must have a value in the Return Header: "PractitionerPIN", "TaxpayerPIN", "Name" of the "Officer", "Title" of the "Officer", "DateSigned" and "PINEnteredBy" Indicator.	Missing Data	Reject	1120, 1120S, 990, 990-EZ, 990-PF, 1120-POL, 8868
R0000-030	In the Return Header, if the Practitioner PIN is provided then the EFIN in the PractitionerPIN must be the same as the EFIN of the Originator.	Data Mismatch	Reject	1120, 1120S, 990, 990-EZ, 990-PF, 1120-POL, 8868, 7004, 1065, 1065-B
R0000-031	Taxpayer PIN in the Return Header cannot equal all zeros.	Incorrect Data	Reject	1120, 1120S, 990, 990-PF, 1120-POL, 8868, 7004, 1065, 1065-B
R0000-032	Signature Option in the Return Header is a required field and must have either the value "Binary Attachment 8453 Signature Document" or "PIN Number".	Missing Data	Reject	1120, 1120S, 990, 990-EZ, 990-PF, 1120-POL

All MeF business rules can be found on the irs.gov website as follows:

- 1120/1120-F/1120S/7004 - <http://www.irs.gov/taxpros/providers/article/0,,id=97626,00.html>.
- For 1065/1065-B – <http://www.irs.gov/efile/article/0,,id=153999,00.html>
- For 990/990-EZ/990-N/990-PF/1120-POL/8868 - <http://www.irs.gov/charities/article/0,,id=105955,00.html>
- For 720/2290 - <http://www.irs.gov/efile/article/0,,id=169093,00.html>

Check for the latest updates!

8.2 Scanned Form 8453 Option

The second alternative signature option that is available for Forms 1120, 1120-F, 1120S, 1065, 1065-B, 990, 990-EZ, 990-PF, and 1120-POL is the scanned Form 8453. The scanned Form 8453 must be used if the taxpayer decides not to use or is prohibited from using the Practitioner PIN option. The appropriate signature option of “Binary Attachment 8453 Signature Document” must be identified in the Return Header. If this option is chosen, the taxpayer and ERO (if applicable) must sign the paper 8453. The signed 8453 must then be scanned into a PDF document and inserted into the electronic return as a binary attachment. The scanned Form 8453 attached must be 3.0 MB or less. The binary attachment must be named “8453 Signature Document”. For more information about binary attachments, refer to [Section 2.1.7](#).

The following business rules are associated with the Scanned Form 8453 option.

Rule Number	Rule Text	Error Category	Severity	Tax Type
R0000-032	Signature Option in the Return Header is a required field and must have either the value "Binary Attachment 8453 Signature Document" or "PIN Number".	Missing Data	Reject	1120, 1120S, 990, 990-EZ, 990-PF 1120- POL, 1065, 1065-B

All MeF business rules can be found on the irs.gov website shown in the [MeF Contact Information Table 1.2](#).

Check for the latest updates!

PDF files of the Forms 8453, which will be used for each of the Programs, can be accessed from the irs.gov website as follows:

Form 8453-C for Form 1120	http://www.irs.gov/pub/irs-pdf/f8453c.pdf
Form 8453-S for Form 1120-C	http://www.irs.gov/pub/irs-pdf/f8453s.pdf
Form 8453-EO for Exempt Organization	http://www.irs.gov/pub/irs-pdf/f8453eo.pdf
Form 8453-PE for Form 1065	http://www.irs.gov/pub/irs-pdf/f8453pe.pdf
Form 8453-B for Form 1065-B	http://www.irs.gov/pub/irs-pdf/f8453b.pdf
Form 8453-I (draft) For Form 1120-F	http://www.irs.gov/pub/irs-dft/f8453i--dft.pdf
Form 8453-EX for Forms 720/2290/8849	http://www.irs.gov/pub/irs-pdf/f8453ex.pdf

8.3 Elections That Require Separate Signatures

IRS Counsel reviewed Regulations to identify elections that require a signature to determine if the requirements can be changed. IRS published the results to this review on www.irs.gov on the *e-file* for Large and Mid-Size Businesses web page. Elections that require a separate signature may be submitted in PDF format.

8.4 Forms Attached to 1120/1120S with Separate Signatures

Many forms that may be attached to Form 1120 and 1120S have separate signature lines. During the development of MeF IRS identified all of the forms with separate signature lines and requested IRS Counsel to issue special instructions to facilitate electronic filing. Regulation T.D. 9100 contains amendments to the Income Tax Regulations (26 CFR Part 1) and Procedure and Administration Regulations (26 CFR part 301) and eliminates some of regulatory requirements considered impediments to the electronic submission of tax returns and other forms filed by corporations, partnerships and other businesses with regard to third party signature requirements. These regulations impeded electronic filing by 1) requiring taxpayers to include third party signatures on their tax returns; 2) requiring taxpayers to attach documents or statements generated by third parties; or 3) requiring a taxpayer to sign an IRS form and file it as an attachment to their income tax return. T.D. 9100 eliminates the impediments for taxable years beginning after December 31, 2002. The regulations generally affect taxpayers who are required to file any of the following forms: 926, 973, 982, 1120, 1120S, 1122, 5471, 5712-A, 8832. See T.D 9100 for a complete list. In addition, effective May 30, 2006, T.D. 9264 also eliminated signature impediments by stating that by signing the return, a taxpayer is attesting to the validity of the Form 1120 as well as all of the attachments.

9 Electronic Signature Specifications

9.1 Jurat/Disclosure Guidelines

1. This section provides guidelines for the jurat/disclosure language that is to be included in software packages for electronically filed returns and extensions.
2. In all instances, the appropriate jurat/disclosure text must be provided to the officer of the corporation or exempt organization prior to the presentation of fields used to enter signature(s) (e.g. PIN).
3. A filer requesting a copy of an Exempt Organization return to be sent to a state charity regulating agency(s) must have a separate screen or screens for the disclosure consent allowing disclosure to the state agency and a separate screen or screens for the signature jurat and disclosure consents permitting disclosure to the ERO.
4. It is imperative that all taxpayers who use the Electronic Funds Withdrawal feature are provided with the appropriate Electronic Funds Withdrawal (EFW) text for their review. Only the approved EFW text displayed in this publication is to be used.
5. Software products intended for use by tax professionals may also provide functionality to print a graphic equivalent of the jurat/disclosure statements for the officer of the corporation or exempt organization to sign as an alternative to viewing and signing the statement on the input screen. A graphic equivalent may be appropriate when the officer of the corporation will not be present to review the completed return in the presence of the ERO, and has elected to authorize the ERO to enter the officer's PIN that they selected.

9.2 Jurat Language Text Selections

This section identifies the Perjury, Consent to Disclosure and Electronic Funds Withdrawal (EFW) text selections (components) used to develop jurat language statements for electronic filing tax preparation software where the Practitioner PIN method is selected. The software must provide the capability to incorporate these into the appropriate text for presentation to a taxpayer for their review.

The Form 1120, 1120-F, or Form 1120S electronic return signed by the Practitioner PIN method must contain the following text.

Perjury Statement

Under penalties of perjury, I declare that I am an officer of the above corporation and that I have examined a copy of the corporation's 2006 electronic income tax return and accompanying schedules and statements and to the best of my knowledge and belief, it is true, correct, and complete.

Consent to Disclosure

I consent to allow my electronic return originator (ERO), transmitter, or intermediate service provider to send the corporation’s return to the IRS and to receive from the IRS (a) an acknowledgement of receipt or reason for rejection of the transmission, (b) an indication of any refund offset, (c) the reason for any delay in processing the return or refund, and (d) the date of any refund.

The following Electronic Funds Withdrawal Consent should only be presented when the taxpayer has selected the Electronic Funds Withdrawal option.

Electronic Funds Withdrawal Consent

I authorize the U.S. Treasury and its designated Financial Agent to initiate an electronic funds withdrawal (direct debit) entry to the financial institution account indicated in the tax preparation software for payment of the corporation’s Federal taxes owed on this return, and the financial institution to debit the entry to this account. To revoke a payment, I must contact the U.S. Treasury Financial Agent at 1-888-353-4537 no later than 2 business days prior to the payment (settlement) date. I also authorize the financial institution involved in the processing of the electronic payment of taxes to receive confidential information necessary to answer inquiries and resolve issues related to the payment.

Officer's Signature

I am signing this Tax Return and Electronic Funds Withdrawal Consent, if applicable, by entering my self selected PIN below.

Officer's PIN _ _ _ _ _

Date: _ _ _ _ _

ERO Declaration

I declare that the information contained in this electronic tax return is the information furnished to me by the corporation. If the corporation furnished me a completed tax return, I declare that the information contained in this electronic tax return is identical to that contained in the return provided by the corporation. If the furnished return was signed by a paid preparer, I declare I have entered the paid preparer’s identifying information in the appropriate portion of this electronic return. If I am the paid preparer, under the penalties of perjury, I declare that I have examined this electronic return, and to the best of my knowledge and belief, it is true, correct, and complete. This declaration is based on all information of which I have any knowledge.

ERO Signature

I am signing this tax return by entering my PIN below

ERO’s PIN _ _ _ _ _

(Enter EFIN plus 5 self-selected numerics)

No signature is required on the Form 7004 or Form 8868 unless the taxpayer has selected the e-Electronic Funds Withdrawal option. If selected, the following Electronic Funds Withdrawal Consent should only be presented.

Perjury Statement

Under penalties of perjury, I declare that I have been authorized by the above taxpayer to make this authorization and that I have examined a copy of the taxpayer's electronic extension (Form 7004) for the tax period indicated above and to the best of my knowledge and belief, it is true, correct, and complete.

Consent to Disclosure

I consent to allow my electronic return originator (ERO), transmitter, or intermediate service provider to send the corporation's return to the IRS and to receive from the IRS (a) an acknowledgement of receipt or reason for rejection of the transmission, (b) an indication of any refund offset, (c) the reason for any delay in processing the return or refund, and (d) the date of any refund.

Electronic Funds Withdrawal Consent

I authorize the U.S. Treasury and its designated Financial Agent to initiate an electronic funds withdrawal (direct debit) entry to the financial institution account indicated in the tax preparation software for payment of the taxpayer's balance due on Form 7004, and the financial institution to debit the entry to this account. To revoke a payment, I must contact the U.S. Treasury Financial Agent at 1-888-353-4537 no later than 2 business days prior to the payment (settlement) date. I also authorize the financial institution involved in the processing of the electronic payment of taxes to receive confidential information necessary to answer inquiries and resolve issues related to the payment.

Officer's Signature

I certify that I have the authority to execute this consent on behalf of the organization. I am signing this Disclosure Consent by entering my self-selected PIN below.

Officer's PIN _ _ _ _ _

Date: _ _ _ _ _

ERO Declaration

ERO's EFIN/PIN. Enter your six-digit EFIN followed by your five-digit self-selected PIN.

do not enter all zeros

I certify that the above numeric entry is my PIN, which is my signature to authorize submission of the electronic application for extension and electronic funds withdrawal for the corporation indicated above. I confirm that I am submitting application for extension in accordance with the requirements of the Practitioner PIN method and Publications 4163, *Modernized e-File Information for Authorized IRS e-file Providers*, and 3112, *IRS e-file Application and Participation*.

The Form 1065 electronic return signed by the Practitioner PIN method must contain the following text.

Perjury Statement

Under penalties of perjury, I declare that I am a general partner or limited liability company member manager of the above partnership and that I have examined a copy of the partnership's 2007 electronic return of partnership income and accompanying schedules and statements and to the best of my knowledge and belief, it is true, correct, and complete.

Consent to Disclosure

I consent to allow my electronic return originator (ERO), transmitter, or intermediate service provider to send the partnership's return to the IRS and to receive from the IRS (a) an acknowledgement of receipt or reason for rejection of the transmission, and (b) the reason for any delay in processing the return.

General Partner or Limited Liability Company Member Manager of the Partnership's Signature

I certify that I have the authority to execute this consent on behalf of the partnership as general partner or limited liability company member manager of the partnership. I am signing this Disclosure Consent by entering my self-selected PIN below.

General Partner or Limited Liability Company Member Manager's PIN _ _ _ _ _

Date: _ _ _ _ _

ERO Declaration

I declare that the information contained in this electronic return is the information furnished to me by the partnership. If the partnership furnished me a completed return, I declare that the information contained in this electronic return is identical to that contained in the return provided by the partnership. If the furnished return was signed by a paid preparer, I declare I have entered the paid preparer's identifying information in the appropriate portion of this electronic return. If I am the paid preparer, under the penalties of perjury, I declare that I have examined this electronic return, and to the best of my knowledge and belief, it is true, correct, and complete. This declaration is based on all information of which I have any knowledge.

ERO Signature

I am signing this tax return by entering my PIN below:

ERO's PIN _ _ _ _ _
(Enter EFIN plus 5 self-selected numerics)

The Form 1065-B electronic return signed by the Practitioner PIN method must contain the following text.

The Perjury Statement, Officer's Signature, and ERO Declaration for the Form 1065-B is the same as the Form 1065 above. The Consent to Disclosure and Electronic Funds Withdrawal Consent for the Form 1065-B are shown below.

Consent to Disclosure

I consent to allow my electronic return originator (ERO), transmitter, or intermediate service provider to send the partnership's return to the IRS and to receive from the IRS **(a)** an acknowledgement of receipt or reason for rejection of the transmission, **(b)** an indication of any refund offset, **(c)** the reason for any delay in processing the return or refund, and **(d)** the date of any refund.

The following Electronic Funds Withdrawal Consent should only be presented when the taxpayer has selected the Electronic Funds Withdrawal option.

Electronic Funds Withdrawal Consent

If applicable, I authorize the U.S. Treasury and its designated Financial Agent to initiate an electronic funds withdrawal (direct debit) entry to the financial institution account indicated in the tax preparation software for payment of the partnership's federal taxes owed on this return, and the financial institution to debit the entry to this account. To revoke a payment, I must contact the U.S. Treasury Financial Agent at **1-888-353-4537** no later than 2 business days prior to the payment (settlement) date. I also authorize the financial institutions involved in the processing of the electronic payment of taxes to receive confidential information necessary to answer inquiries and resolve issues related to the payment.

The Form 990, Form 990-EZ, 990-PF or Form 1120-POL electronic return signed by the Practitioner PIN method must contain the following text:

Perjury Statement

Under penalties of perjury, I declare that I am an officer of the above exempt organization and that I have examined a copy of the exempt organization's 2006 electronic return and accompanying schedules and statements and to the best of my knowledge and belief, it is true, correct, and complete.

Consent to Disclosure

I consent to allow my electronic return originator (ERO), transmitter, or intermediate service provider to send the exempt organization's return to the IRS and to receive from the IRS (a) an acknowledgement of receipt or reason for rejection of the transmission, (b) an indication of any refund offset, (c) the reason for any delay in processing the return or refund, and (d) the date of any refund.

The following Electronic Funds Withdrawal Consent should only be presented when the Form 1120-POL or Form 8868 filer has selected the Electronic Funds Withdrawal option:

Electronic Funds Withdrawal Consent

I authorize the U.S. Treasury and its designated Financial Agent to initiate an electronic funds withdrawal (direct debit) entry to the financial institution account indicated in the tax preparation software for payment of the exempt organization's Federal taxes owed on this return, and the financial institution to debit the entry to this account. To revoke a payment, I must contact the U.S. Treasury Financial Agent at 1-888-353-4537 no later than 2 business days prior to the payment (settlement) date. I also authorize the financial institution involved in the processing of the electronic payment of taxes to receive confidential information necessary to answer inquiries

Officer's Signature

I am signing this Tax Return and Electronic Funds Withdrawal Consent, if applicable, by entering my self selected PIN below.

Officer's PIN _ _ _ _ _

Date: _ _ _ _ _

and resolve issues related to the payment.

ERO Declaration

I declare that the information contained in this electronic return is the information furnished to me by the corporation. If the exempt organization furnished me a completed return, I declare that the information contained in this electronic return is identical to that contained in the return provided by the exempt organization. If the furnished return was signed by a paid preparer, I declare I have entered the paid preparer's identifying information in the appropriate portion of this electronic return. If I am the paid preparer, under the penalties of perjury, I declare that I have examined this electronic return, and to the best of my knowledge and belief, it is true, correct, and complete. This declaration is based on all information of which I have any knowledge.

ERO Signature

I am signing this tax return by entering my PIN below:

ERO's PIN _____
(Enter EFIN plus 5 self-selected numerics)

10 Form 7004, Automatic 6-Month Extension of Time to File Certain Business Income Tax, Information, and Other Returns

General Items of Interest for Form 7004

Extension type for Forms 990-C and 1120 (Chapter T) have been removed From Form 7004 for tax year 2007. Additionally, extension for Form 1120-A is obsolete for tax years beginning after December 31, 2006. Extension type for Form 1120-F has been added to the Form 7004 for tax year 2007. See Form 7004 Instructions for information regarding filing for an extension.

10.1 Types of Returns and Conditions for Which Form 7004 May Be Used to Request Extension of Time to File

IRS made major revisions to the Form 7004 and its Instructions. IRS now gives an automatic 6-month extension for the following returns: Form 1041, 1041-N, 1041-QFT, 1042, 1065, 1065-B, 1066, 1120, 1120-A, 1120-C, 1120-F, 1120-FSC, 1120-H, 1120-L, 1120-ND, 1120-PC, 1120-POL, 1120-REIT, 1120-RIC, 1120S, 1120-SF, 3520-A, 8804, 706-GS(T). Only one extension form will need to be filed on or before the due date of the appropriate form. A separate Form 7004 will need to be filed for each return. The revised 7004 must be used for any return with a tax year which ends on or after December 31, 2006. Form 7004 may be filed electronically except for specifically identified returns (see 7004 Instructions). The December 2006 revision of Form 7004 replaces the following extension forms:

- Form 2758, Application for Extension of Time to File Certain Excise, Income, Information, and Other Returns
- Form 7004, Application for Automatic 6-Month Extension of Time To File Certain Business Income Tax, Information, and Other Returns
- Form 8736, Application for Automatic Extension of Time to File U.S. Return for a Partnership, REMIC, or for Certain Trusts
- Form 8800, Application for Additional Extension of Time to File U.S. Return for a Partnership, REMIC, or for Certain Trusts"

Although binary files other than the 8453 will be accepted, please be aware that binary file documents will not be processed. Do not attach any document that needs IRS attention or approval. Power of Attorney (POA) documents should be submitted separately. Form 1138 for Net Operating Loss Carryback should be submitted separately to IRS. Do not attach Form 1138 to the 7004.

10.2 Data Entry for Form 7004

Enter the extension date based upon the tax period and the type of return for which an extension is being requested. The extension date is the 15th day of the 6th month following the applicable due date. See the date charts for 7004 in section 1.4. Note that the due dates vary depending not only on the type of return but also on different conditions, as listed in the charts.

For calendar year and fiscal year filers, the tax period end date month must match the month that was approved by IRS as the tax period for this EIN.

If the change in accounting period is checked, you must have applied for approval to change your tax year prior to filing the application. Short tax year applications must check at least one of four reasons for short tax year. Refer to Publication 538, Accounting Periods and Methods, for details.

For a consolidated return (consolidated group), enter the name, address and EIN of each member of the group. If the member does not have an EIN, you may enter one of the following: “PENDING”, “APPLIED FOR” or “NONE”.

All monetary amounts are positive amounts. Tentative Tax, Total Payments and Refundable Credits, and Balance Due amounts are required. If Electronic Funds Withdrawal payment is attached, the payment amount must be for the entire balance due. Partial payments are not accepted.

10.3 Timely Filing of Form 7004

An extension will be rejected if it is not received by the IRS due date of the applicable return.

Note: For purposes of determining timeliness of the extension, the received date is the electronic postmark, if present, or the IRS received date in the GTX Key. To avoid rejecting extensions from filers or transmitters in a different time zone from the IRS system, the time zone differences are taken into consideration.) 5 days are allotted to fix and resubmit rejected extensions. See the date charts for Form 7004 in section 1.4 for the applicable due dates.

An accepted acknowledgement of the electronic Form 7004 serves as IRS approval of the extension.

11 Exempt Organization Section

11.1 Form 8868, Application for Extension of Time to File an Exempt Organization Return

MeF will accept electronic filings of Form 8868 (Part I – Automatic Extension) for the following returns: Form 990, 990-EZ, 990-PF, 990-T (corporation), 990-T (sec. 401(a) or 408(a) trust), 990-T (trust other than above), 1041-A, 4720, and 5227. No signature is required as part of this filing. However, a payment record may be attached to this form, as appropriate, and if so, a signature is required for the Electronic Funds Withdrawal (EFW) authorization. A Practitioner Pin (using Form 8879-EO) or Form 8453-EO may be used for this authorization. Form 8453-EO is the only attachment/binary file that will be accepted. An extension will be rejected if it is not received by the IRS due date of the applicable return. (Note: For purposes of determining timeliness of the extension, the received date is the electronic postmark, if present, or the IRS received date in the GTX Key. To avoid rejecting extensions from filers or transmitters in a different time zone from the IRS' system, the time zone differences are taken into consideration.)

An accepted acknowledgement of the electronic Form 8868 serves as IRS approval of the extension.

11.2 Reasonable Cause for Late Filing of Form 990, 990-EZ, 990-PF or 1120-POL

At times, an organization may have a reasonable cause for late filing of and Exempt Organization return. In order to expedite the process and avoid assertion of Failure to File Delinquency penalties, a filer may attach a reasonable cause explanation using the “ReasonableCauseExplanation.xsd” schema. Acceptance of the return does NOT mean that the explanation was accepted and the penalty will not be assessed. If the explanation is not accepted, the taxpayer will be contacted as appropriate using existing IRS procedures.

12 Excise Tax Section

IRS will provide stamped copies of the Schedule 1 (Form 2290) electronically through the transmitter or software provider on electronically filed returns. The electronic Schedule 1 (Form 2290) will contain a watermark and can be printed for use as proof of payment:

SCHEDULE 1 (Form 2290) <small>(Rev. July 2007) Department of the Treasury Internal Revenue Service</small>		Schedule of Heavy Highway Vehicles For the period July 1, 2007, through June 30, 2008		OMB No. 1545-0143		
		<small>This copy will be stamped and returned to you for use as proof of payment when registering vehicle(s) with a state.</small>				
Type or Print	Name as shown on Form 2290 String String			Employer identification number 69 : 000001		
	Address (number, street, and room or suite no.) String String					
	City, state, and ZIP code (for Canadian or Mexican address, see page 4 of the instructions.) String, AL 20872					
Caution. You must list all vehicles. Attach a separate list if needed.						
Part I Vehicles on Which You Are Reporting Tax. See page 6 of the instructions.						
	Vehicle Identification Number	Category		Vehicle Identification Number	Category	
1	AAAAAAAAAAAAAAAAAAAA	S	7			
2			8			
3			9			
4			10			
5			11			
6			12			
Part II Vehicles for Which Tax Is Suspended—5,000 Miles or Less (7,500 Miles or Less for Agricultural Vehicles). See page 6 of the instructions.						
	Vehicle Identification Number	Category		Vehicle Identification Number	Category	
1	AAAAAAAAAAAAAAAAAAB	W	2		W	
Part III Summary of Reported Vehicles						
a Enter the number of taxable vehicles from Form 2290, page 2, column 3, Totals					a	1
b Enter the total number of taxable vehicles on which the tax is suspended from Form 2290, page 2, column 3 (category W)					b	2
<small>For Privacy Act and Paperwork Reduction Act Notice, see page 8 of the instructions.</small>						
<small>Schedule 1 (Form 2290) (Rev. 7-2007)</small>						

Form 2290 schemas include:

- An element for Consent to Vin Data Disclosure to indicate whether the taxpayer consents to disclosure of tax information
- EIN, Name and Date of the disclosure form when the taxpayer chooses to disclose
- A choice of PIN or binary attachment that will serve as the signature for the disclosure consent when the taxpayer chooses to disclose.

Exhibits

Exhibit 1 - Business Name Control

To aid in validating the Employer Identification Number (EIN), the “Name Control” must be provided. The Name Control consists of up to four alpha and/or numeric characters.

The Name Control should be determined from the information specified on the first name line. Generally, the Name Control is derived from the first four characters of the corporation. The ampersand (&) and hyphen (-) are the only special characters allowed in the Name Control. The Name Control can have less, but no more than four characters. Blanks may be present only at the end of the Name Control.

Note: Do not include "dba" as part of the Name Control. The initials stand for "doing business as".

Business Name Control Valid Characters:

Numeric (0- 9)

Alpha (A-Z)

Hyphen (-),

Ampersand (&)

Special Business Name Control Rule:

If an invalid character is used in the name line, drop the special character from the taxpayer's name. Example: Jon.com should be considered as “Joncom” so the Name Control should be “Jonc”. Another example is 4U.com. The Name Control should be “4UCO”.

Examples

Name Control Underlined	Name Control	Rule
<u>S</u> umac Field Plow Inc. <u>11</u> th Street Inc. <u>P & P</u> Company <u>Y-Z</u> Drive Co <u>ZZZ</u> Club <u>P</u> alm Catalpa Ltd. <u>Fir</u> Homeowners Assn.	SUMA 11TH P&PC Y-ZD ZZZC PALM FIRH	a. Derive the Name Control from the first four significant characters of the corporation name.
The <u>W</u> illow Co. The <u>H</u> awthorn	WILL THEH	When determining a corporation name control, omit “The” when it is followed by more than one word. Include the word “The” when it is followed by only one word.
<u>J</u> ohn Hackberry PA <u>S</u> am Sycamore SC <u>C</u> arl Eucalyptus M.D.P.A.	JOHN SAMS CARL	If an individual name contains any of the following abbreviations, treat as the business name of a corporation: PC – Professional Corporation SC – Small Corporation PA –Professional Association PS --Professional Service
The <u>J</u> oseph Holly Foundation	JOSE	Apply Corporate Name Control rules when the organization name contains “Fund”,
<u>K</u> athryn Fir Memorial Fdn.	KATH	“Foundation”, or “Fdn”.
<u>C</u> ity of Fort Hickory Board <u>W</u> alnut County Employees Association <u>R</u> ho Alpha Chapter Alpha <u>T</u> au Fraternity <u>H</u> ouse Assn. of Beta XI Chapter of Omicron Delta <u>K</u> appa	CITY WALN RHOA HOUS	Apply the corporate Name Control rules to chapter names of national fraternal

Exhibit 2 - Identifiers

This section describes the identifiers used within the MeF system. Identifying numbers are defined at the transmission, return, and form levels and uniquely identify these entities.

1. Transmission Level Identifying Numbers

- **GTX Key** - The format of the GTX Key is as follows:

SYYYMMDDhhmmss.nnnn

- “A” or “C”=the IFA server site.
- YYYMMDD = received date (4 digit year, 2 digit month, 2 digit day)
- hhmmss.nnnn = received time (2 digit hour, 2 digit minutes, 2 digit seconds, 4 digit nano-second)
- **Transmission ID.** This number, which exists in the transmission header, uniquely identifies a transmission for the tax year. It is created by the transmitter. The IRS will return this number in the transmission acknowledgement to uniquely identify the transmission that is being acknowledged. It can be up to 30 digits in length, is alphanumeric, and can contain characters “:”, “.”, and “-“. A timestamp may be used as an ID as long as it is unique within the filing season. Up to 4-decimal fractional digits may be used for the second in a timestamp to ensure its uniqueness.
- **MessageID.** This number, which exists in the transmission header, uniquely identifies a message. The MessageID element is mandatory. All request and response messages must have a globally unique MessageID provided by the message source and is 20 digits number with following format: (ETIN + cyyddd + 8-character alphanumeric).
 - **Request Message ID**
To ensure the global uniqueness of a message ID, the following format is adopted for the request messages sent to the MeF system:
ETIN + cyyddd + xxxxxxxx
For example:
Request message ID: 00130200707312345678
The first five digits (00130) contain the ETIN, the next four digits (2007) contain the year, the next three digits (073) contain the Julian date, and the last eight digits (12345678) contain a sequence number to uniquely identify messages sent within a day with the given ETIN. The total number of characters of the request message ID is twenty.
 - **Response Message ID**
For response messages sent from the MeF system, the following format is adopted for the message ID:
Request Message ID + “R”
For example:
Response message ID: 00130200707312345678R
The total number of characters of the response message ID is twenty-one.

- **Error Message ID**

For error messages sent from the MeF system, the following format is adopted for the message ID:

Request Message ID + "E"

For example:

Response message ID: 00130200707312345678**E**

The total number of characters of the error message ID is twenty-one.

- **Error ID** – This number, which is located in the acknowledgement file, uniquely identifies each error in the acknowledgement file. It can be up to 6 digits in length.
- **Transmitter's ETIN**. This number, which exists in the transmission header, uniquely identifies the electronic transmitter. It's a 5-digit number assigned by the IRS.

2. Return Level Identifying Numbers

- **Submission ID** - This number, which exists in the submission header, is a globally unique 20 digit number with the following format: (ETIN + ccyddd + 7-digit alphanumeric sequence number). There is a business rule validation that the Year in the Submission ID must be the current processing year.
- **Software ID** – This number, which exists in the return header or as a top level element within each schema, identifies the software used to build the return, form, or schedule XML instance. It's an 8-digit ASCII character field assigned by the IRS. The first two positions identify the tax year.

The software id in the ReturnHeader is a required field. If the return was created using just one software package, the SoftwareID in the ReturnHeader should be the only SoftwareID transmitted. If the return is created using more than one software package, the SoftwareID in the other Return Documents must indicate which software package was used for each form.

- **Originator's EFIN** – This number, which exists in the <ReturnHeader> element definition, is the originator's Electronic Filing Identification Number. It's a 6 digit numeric field, where the first 2 digits represent a pre-defined IRS district office code. This identifier is assigned by the IRS.
- **Business's EIN** – This number, which exists in the <ReturnHeader> element definition, is the Employer Identification Number of the business for which the return is being filed. It's a 9 digit numeric field, where the first 2 digits represent a pre-defined IRS district office code. This identifier is assigned by the IRS.
- **Preparer's SSN or PTIN** – This number, which exists in the <ReturnHeader> element definition, is a choice between a person's Social Security Number or Preparer's Tax Identification Number. SSN is a 9 digit numeric field, and PTIN is 9 digits, beginning with the letter 'P' followed by 8 numeric digits. The SSN is assigned by the Social Security Administration and the PTIN is assigned by the IRS.

- **Preparer Firm's EIN** – This number, which exists in the <ReturnHeader> element definition, is the Employer Identification Number of the firm which prepared the return (if applicable). It is a 9 digit numeric field, where the first 2 digits represent a pre-defined IRS district office code. The EIN is assigned by the IRS.

3. Form Level Identifying Numbers

- **Document ID** – This number uniquely identifies a single form/schedule XML instance within the return. The attribute `documentId` exists in every top level element in the form/schedule schemas. It can be up to 30 positions in length, and is alphanumeric, plus can contain characters “:”, “.”, and “-“. This pattern allows for a timestamp to be used within the field. This identifier is assigned by the ERO's software.
- **Reference Document ID** – This number refers to a unique form/schedule XML instance (identified by its `documentId` attribute) within the return attribute `referenceDocumentId`. It is found where attachments to the tax return, form, and/or lines are made. Thus, this attribute's structure is identical to the structure of the `documentId` attribute.

Exhibit 3 - Standard Postal Service State Abbreviations and ZIP Codes

The Standard Postal Service State Abbreviations and Zip code list can be found on [irs.gov](http://www.irs.gov) at:
<http://www.irs.gov/efile/article/0,,id=171946,00.html>

Exhibit 4 - Foreign Country Codes

The Foreign Country Code list can be found on [irs.gov](http://www.irs.gov) at:
<http://www.irs.gov/efile/article/0,,id=175595,00.html>

Exhibit 5 - Forms and Attachment Listing

The list of Forms and Attachments for Forms 1120/1120S is located on [irs.gov](http://www.irs.gov) at
<http://www.irs.gov/efile/article/0,,id=171946,00.html>. The Forms and Attachments for other returns will be posted at this location in the future.