

# **WORKING WITH BEAVERS**



**Nick Gerich  
Biological Sciences Technician  
USDA Forest Service  
Leadville Ranger District  
San Isabel National Forest**

## Table of Contents

Acknowledgments	3
Introduction	3
Important Considerations	4
Example of road damage resulting from beaver activity	5
Various Solutions	6
Types of Culvert Protection	8
Removable Pull Rod Grill	8
Culvert Protector-Cleaner	9
Vertical Cylindrical Wire Mesh Beaver Guard	9
Horizontal Cylindrical Wire Mesh Beaver Guard	11
Simple Beaver Pipe	12
Simple Wire Mesh Fence	13
Full Wire Mesh Fence	13
Full Wire Mesh Fence with Simple Beaver Pipe	14
Complex Wire Mesh Fences with Simple Beaver Pipe	14
Complex Fencing	15
Beaver Deceiver Design	16
Variations of the Beaver Deceiver	16
Combination of Beaver Exclusion Fencing with Beaver Pipes	17
The Array Piping System	17
Pond Drain Pipe	18
Whirlpool effect	18
Wire Mesh Culvert	19
PVWV Flexible Leveler	19
The Clemson Beaver Pond Leveler	20
Low Water Crossing	20
More Examples	21
Future Planning	23
References	23

## Acknowledgments

This is the result of my personal experience as well as collecting and editing the information contained in existing pamphlets, booklets, guides and research materials addressing various methods of remediation used to correct flooding resulting from beaver activity. I have drawn heavily from *The Use of Water Flow Devices and Flooding Problems Caused by Beaver in Massachusetts* compiled by Susan Langlois & Thomas Decker of the Massachusetts Division of Fisheries & Wildlife, *Control of Beaver Damage* by the Alberta Agricultural, Food and Rural Development agri-fax and *Beaver Management at the Penobscot Indian Nation* by Skip Lisle.

## Introduction

Since the voters of the State of Colorado passed Amendment 14 in 1996, which banned the use of leghold and kill traps, beaver and human conflicts have increased exponentially. Elimination of the wolf by hunting and the banning of lethal trapping, historical beaver population controls have been effectively eliminated in Colorado.

During the 9 years that I have attempted to prevent beaver flooding of roads and the destruction of water resources, I have often felt that I was merely training the next generation of beavers and helping them to polish up on new construction skills. The beaver have been my instructors. Every improvement I made in a flow regulation device, fencing or baffles has eventually led to improvements in their damming efforts. Any mistakes that I have made in planning, design or construction they have found and exploited fully.

When I began building flow regulation devices I raided the “bone yard” for all my building materials. I have never had an adequate level of funding to purchase new materials in order to build pretty spanking new water control devices! My budget often does not allow me to hire help. So one of the major factors has been; “Can I move the materials and build these fixtures without any assistance.” As my duties also include assisting other departments in the district, I must keep the time spent on beaver issues to a minimum.

The increasing problems of flooding and damaging of water resources are a direct result of uncontrolled beaver populations. There has been an increasing urgency to find viable solutions. In many cases, resource managers have improperly planned and executed solutions that were bound to fail or held expectations of success that were unwarranted. I hope to address several different types of solutions and state opinions based on my personal experience in dealing with beaver problems as a Biological Sciences Technician with the USDA Forest Service since 1996.

## Important Considerations

From my own personal experience and in assisting others with beaver problems, proper planning is the most neglected and critical part of finding a solution to beaver flooding and damage. Many attempts to control flooding and reduce damage have utterly failed as a direct result of bad planning.

1. What are your goals? Is it only to guarantee water flowing freely through a pipe or culvert to prevent damage to the road bed and/or submergence? Are you trying to regulate the amount and depth of water impounded by beaver activity or completely drain an area? Do these waters involve some kind of water rights?
2. Have you taken in account how much water will be running through the culvert? Is it a natural flow or are there releases upstream from a reservoir that will increase the flow? Are there seasonal variations in flow rates? Have you considered storm events?
3. How much funding do you have? You must consider not only immediate costs for materials and labor but also yearly needs for monitoring and maintenance. Beavers can also decide to build another dam upstream in response to your activity. You will need to build another device to counteract the damming of this new one. Have you planned for this?
4. What about removing naturally occurring debris from pipes, culverts and screens. In the spring, last fall's depositions of litter and debris will be washed into waterways as the snow melts and thus into beaver control devices. Storm events can cause the loss of leaves, needles, twigs and branches that enters the water and will plug up culverts, pipes and screens. Fall sees the deciduous trees and shrubs losing their leaves and at least up here, beaver activity increases dramatically around the end of August.

**YOU WILL ALWAYS HAVE TO DO REGULAR MAINTANCE!** Many of these solutions work well only if regularly cleaned. When these devices are not regularly inspected and maintained, they will fail with potentially disastrous results.

Too many people think that once the device is installed that everything is solved and they can walk away from it. Even the Clemson Beaver Pond Leveler must have the screens and intake holes cleaned occasionally of debris that is sucked down into the screens and perforations/openings in the pipe. A good rule of thumb is the smaller the wire mesh, screen, pipe and openings, the faster they plug up and the more frequently they have to be cleaned. In essence, some designs will require more maintenance than others. Money is also an issue here as maintenance involves time costs money.

Another reason for regular inspection is that vandalism can also occur in places where these devices are visible to the public. The public may not understand what you are attempting to do. Children like to play in water and also build dams just like beavers.

5. The more complex the design is; the more can go wrong with it, the harder it is to maintain and repair. After you have spent as much time as I have in chest waders working in frigid mountain waters, hauling materials across hill and vale, modifying

designs and removing debris from those devices you learn the hard way to keep it simple.

6. Installing multiple pipes or culverts of a smaller size is not a good alternative to installing one large pipe. For example, four twelve inch diameter pipes have a total area equal to that of a 24" culvert. Debris also collects and is trapped between the multiple pipes. It also makes it easier for the beavers to plug up. To my dismay, I found out that a series of smaller pipes or culverts have a greater chance of being more rapidly plugged naturally and/or being dammed by beaver.
7. Beavers need a minimum constant flow of .5 cubic feet per second and a stream gradient of less than 3 percent for a location to be attractive. In areas of low water flows, smaller diameter pipes are the only effective alternative. As stated in the previous paragraph, it would take four 6 inch diameter pipes to provide the capacity of the 1 foot diameter pipe; which is the smallest I would install. This allows for natural increases in flows resulting from storm episodes and spring snow melt while allowing for the free passage of small debris through the pipe. The success of these remedies will depend upon methods used to prevent intake plugging and regular inspections and cleaning.

### **Example of road damage resulting from beaver activity**



**Figure 1**



**Figure 2**



**Figure 3**

The Highway 82 roadbed was built up to cross this wetland area as seen in **Figures 1, 2 & 3**. Water was impounded on both sides by beaver activity. For several years this resulted in enough water being impounded as to all but submerge the road. Holes appeared in the road surface as the road bed was saturated reaching a plastic state and in some places a fluid state resulting in destabilization as seen in **Figures 4 & 5**. In 1994 the Colorado Department of Transportation poured 12 cubic feet of Portland cement into holes developing in the roadbed in order to stabilize it. It was critical to lower the water levels while maintaining water flows and the developing riparian areas.



**Figure 4**



**Figure 5**

## **Various Solutions**

1. In Colorado, lethal trapping has been banned and is illegal. This is no longer a solution. In some cases, live trapping and relocation may be acceptable alternative. Since 1996 the beavers have reclaimed much of the habitat. Relocating beavers only makes sense in areas where their population densities are low but it is only a short term solution. In areas having a high population density, new individuals will quickly enter the area to repopulate it. If the existing colony is only reduced, the yearly size of the litters could potentially increase until the carrying capacity of the land is again reached and birth rates again decrease.

2. Live trapping is expensive and labor intensive. Traps must be checked in the morning and evenings to prevent drowning of the beavers trapped and a holding area is required to hold captured beavers until a male/female pair or the whole colony is collected. At a minimum, a pair of males and females is necessary establishing themselves as a viable colony in a new location.
3. Beavers must be relocated in an area that will support them and allowing enough time to establish themselves before winter sets in. They can not merely be moved into an area already having the maximum carrying capacity or into a place that will not support them. Time will be needed to locate areas that are under populated or having no other beaver colonies. Improperly relocated beavers can travel up to 60 miles in order to return to their original home territory.

Private contractors can be hired to live trap the beaver but instead of relocation, the beaver are immediately eliminated after capture. Besides being expensive, the possibility of bad public relations makes this option undesirable for federal and state agencies.
3. Lodges, dens and dams could be dynamited as was a common practice in the past. But on national forests and in other areas this is illegal. It can also be dangerous. During the early 1990's I helped dynamite beaver dams while I was employed by a private firm. I found that this was only a temporary solution and the dams would be rebuilt within a week or two. Removing dams mechanically or by hand has never been a true solution. Not only is a lot of time and cash expended in removing these dams but beavers can rebuild a small dam in less than 24 hours.
5. Then there are engineering solutions that can allow resource managers to work with beaver to allow some ponding of water necessary for the preservation and creation of wetland and riparian areas
6. Installing pipe to carry water through the contested area is the other and a more expensive option.



**Figure 6**

**Figure 6** shows an irrigation ditch that invites beaver damming on a daily basis during the fall. Notice the availability of building materials. The only options are to put in a pipe for 2,000 feet until it gets out of the willows or cut back the willows from the ditch for 15 feet. This will end any percolation and seepage that benefits

vegetative growth. A solution may be to perforate the pipe to allow seepage and allow the maintenance of surrounding vegetation and riparian areas.

7. Consider raising the height of the road bed and the installation of larger culverts with beaver control devices. I was involved in a flooding situation where the road on Weston Pass dipped for over 100 feet. The creek was next to the road and beaver dam building resulted in repeated flooding in the low area. In this case, raising the road bed would have been the best solution.
8. For trails and unimproved 4x4 roads it may be more cost effective to move them than to deal with water control and the resulting maintenance needs.
9. In certain areas where topography will not permit raising the road bed or installing beaver control devices, a dip/spillway armored with riprap and logs with a roadbed of coarse gravel can be built in the road itself to allow the flooding caused by beavers to pass over with little to no damage.

## Types of Culvert Protection

### Removable Pull Rod Grill

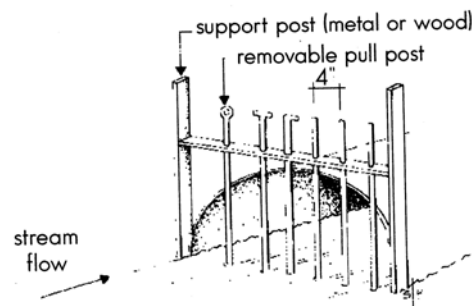

Figure 7

It has been my experience that grills or wire mesh screens across the intake of a pipe or culvert only assist beavers in damming the culvert. I think such structures actually encourage beaver by providing a convenient foundation for building a dam. I personally have seen beavers dam up two 5 foot diameter culverts with a wire mesh covering the intakes in only 18 hours. This type of fixture is only effective screening of large natural debris and keeping animals from entering the culvert from the outlet end. Cleaning will have to be done by hand until most of the debris are removed as premature removal of the pull rods will allow the accumulated debris into the pipe/culvert plugging it up.

I have used grills to prevent naturally occurring and human debris from entering a two foot diameter pipe transporting irrigation waters through a parcel of private land. Again, unless regular inspections and cleaning are conducted, the grills will quickly become obstructed. This results in the flooding and resulting damage that you were trying to prevent.



## Culvert Protector/Cleaner

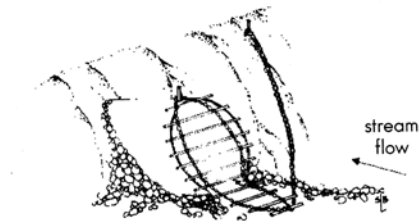

Figure 8

The thought behind the Culvert Protector/Cleaner is use the logging chain on the protector to hook onto the bumper of a truck in order to lift the whole assembly up out of the water to facilitate cleaning. Of course this dumps the materials that the beavers constructed the dam out of onto the road. Though this keeps people out of the water and is quicker than removing the dam by hand, you still have to move the debris from the road. There are several safety concerns. The chain or the protector could break during the lifting process. Then there are traffic control issues plus you could damage the vehicle or equipment used to lift the protector/cleaner.

## Vertical Cylindrical Wire Mesh Beaver Guard

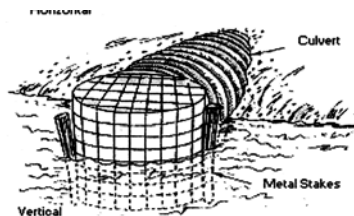

Figure 9

This is an improvement over the grill and the cleaner/protector as it has a lot more surface area to be obstructed. In this drawing the area is still too small to be truly effective. Daily cleaning of the mesh will be needed. By enlarging the diameter by at least 3 times, the culvert diameter will drastically decrease the maintenance needed to keep the mesh clear of debris. This design is extremely effective for smaller diameter pipes and culverts.

In the photos below, I used this design to protect a one foot diameter culvert that allows water to flow between ponds while defeating repeated attempts to obstruct the narrow channel between the ponds. I also placed wire mesh on the pond bed within the enclosure to stop beavers from entering into it. This design is quite effective with a minimum of materials and time needed in construction. Don't forget to put a wire mesh over the outlet to stop beavers from entering the culvert.



**Figure 10**



**Figure 11**

In **Figure 10** the Vertical Cylindrical Wire Mesh Beaver Guard protects the intake of a one foot diameter metal culvert. The diameter of the mesh is about four feet. To date, the beavers have not attempted to rebuild the dam.

**Figure 11** shows the accumulated materials on both sides of the channel from removal of beaver dams over the last 12 years. Beavers would dam this channel in less than 2 days before this structure was put in place.

## Horizontal Cylindrical Wire Mesh Beaver Guard

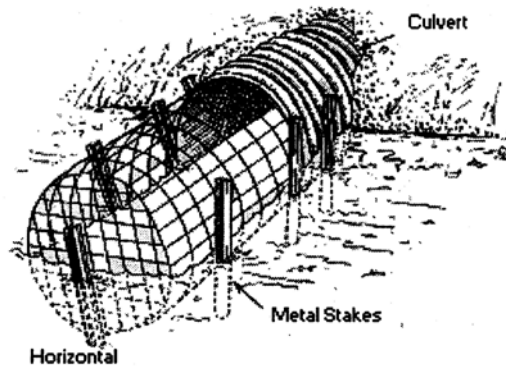

Figure 12



Figure 13



Figure 14

I have found the Horizontal Cylindrical Wire Mesh Beaver Guard to be very effective for various sized culverts and pipes, having more surface area that allows more time between cleanings verses just placing a screen across the outlet. It is the simplest design, easily constructed, low cost and using a minimal amount of materials.

**Figures 13 & 14** show photos of a problem area before and after with two five foot diameter and one three foot diameter culverts that had Horizontal Cylindrical Wire Mesh Beaver Guards at the intakes. These guards extended just short of 10 feet from the intakes. The first one was built and installed by one person in only an hour.

I use this same design to protect eighteen inch diameter head gates and smaller metal culverts moving irrigation water. I have also found that for culverts over 6" in diameter that the outlet of the pipes also should have wire mesh preventing beaver entry into the pipe from the opposite end. I often use smaller Horizontal Cylindrical Wire Mesh Beaver Guards on the outlets also. Even at the outlet these culverts can plug up from debris passing through the pipe.



Figure 15



Figure 16

**Figures 15 & 16** show other applications of the Horizontal Cylindrical Wire Mesh Beaver Guard for the protection of a head gate located on the upper Arkansas River and a small culvert used to facilitate the free flow of irrigation waters under a two track road.

### **Simple Beaver Pipe**

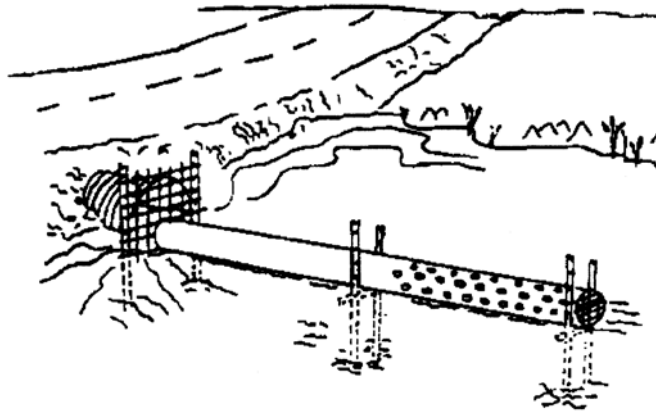

Figure 17

**I am including this design as an example of what not to do. The intake of the pipe is unprotected not only from beaver damming but from natural debris plugging up both the intake and the perforated holes in the PVC pipe. Depending on rainfall and other factors, the diameter of the PVC pipe may also be inadequate. This will eventually result in failure of this system and the washing out of the roadbed. The wire mesh at the intake of the culvert will only help the beavers to speedily plug it up.**

## Simple Wire Mesh Fence

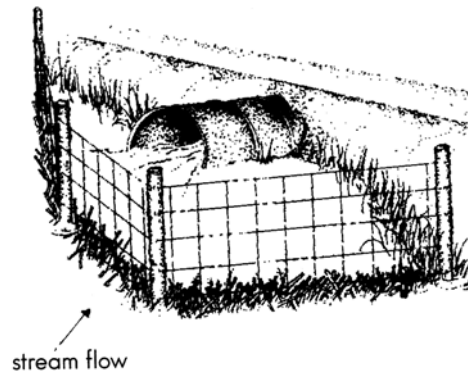

Figure 18

This is another example of an ineffective design. Though the culvert intake is protected in the water, it does not prevent the beaver from entering the enclosure from the road and plugging the intake from the inside. Secondly, the posts of the wire mesh screen are made of wood. We have found that beavers will attack the wooden posts and 6" x 6" mesh will allow beavers to chew through the wooden posts. We use steel fence posts which are more easily driven into the stream/pond bed and have a longer life span than wood.

## Full Wire Mesh Fence

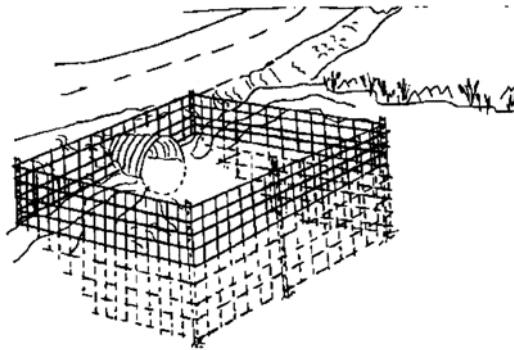

Figure 19

This design also provides maximum protection of the culvert. What the drawing does not show is the wire mesh that has to be laid inside the enclosure on the pond/creek bottom to prevent beavers from coming up underneath the screen to enter the enclosure. It does use more materials than the wire mesh beaver guards but still is a good design. Even if regularly inspections and cleanings of the fence are not possible, and the beavers were able to completely obstruct the fence, water can still flow over the top and into the culvert.

## Full Wire Mesh Fence with Simple Beaver Pipe

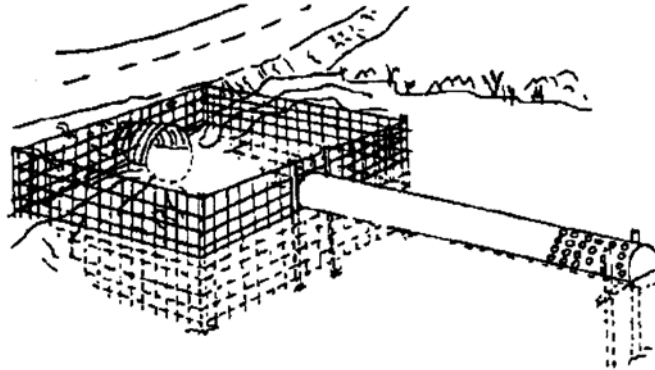

Figure 20

It would have been more efficient to have regularly cleaned the wire mesh fence of debris than to complicate matters by adding the pipe extension. Because of the pipe extension, it has just increased the need for regular inspection and cleaning instead of reducing it as the pipe intake is more readily plugged up. The PVC pipe is now the limiting factor.

## Complex Wire Mesh Fences with Simple Beaver Pipe

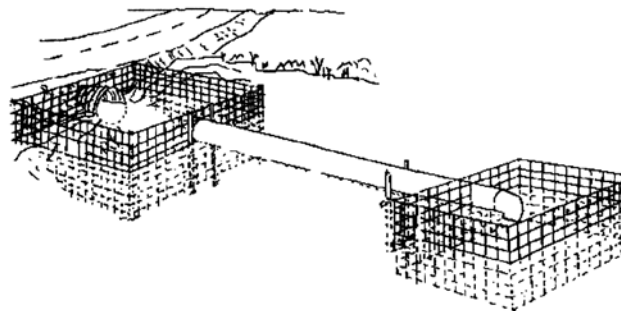

Figure 21

This modified design might make sense if the beavers constructed another dam beyond the first wire mesh fence protecting the culvert and as long as the pipe connecting the two fenced enclosures can carry the same amount of water as the culvert. In effect, the pipe is actually a Pond Leveler connecting two Wire Mesh Fence Enclosures.

## COMPLEX FENCING

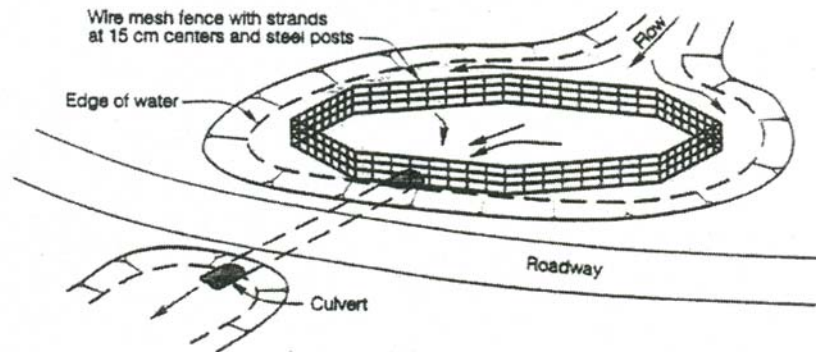

Figure 1. Example of "O" Shaped Fencing Layout  
(Drawing Courtesy of Finnigan and Marshall, 1997)

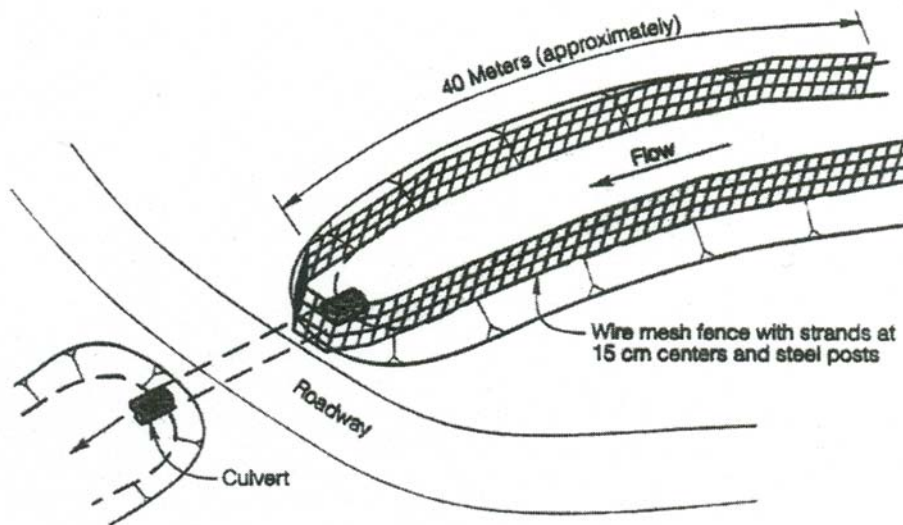

Figure 2. Example of "U" Shaped Fencing Layout  
(Drawing Courtesy of Finnigan and Marshall, 1997)

Figure 22

**These designs would apply mostly for highways and in urban areas. The "U" shaped layout should be also enclosed to prevent beavers from entering the inlet.**

## Beaver Deceiver Design

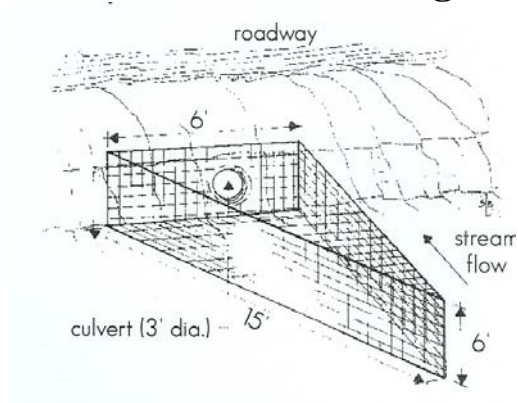

Figure 23

This is another versatile design that can employ various designs for the wire mesh screens. In tight spots, these can be built to accommodate the space available. The example below shows some of the alternatives to the triangular design above.

## Variations of the Beaver Deceiver

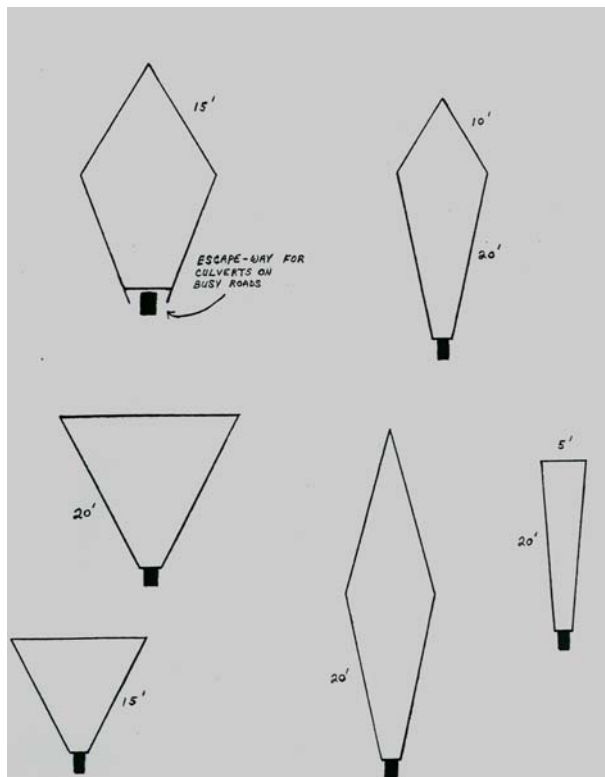

Figure 24



## Combination of Beaver Exclusion Fencing with Beaver Pipes

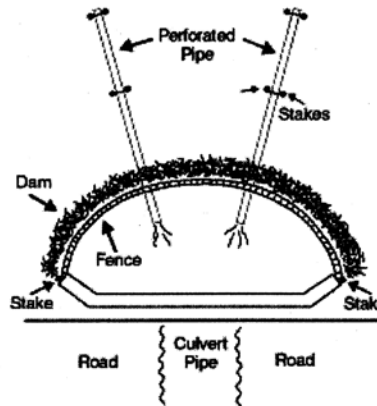

Figure 25

Again, it would have been easier to have kept the wire mesh fence clean.

## The Array Piping System

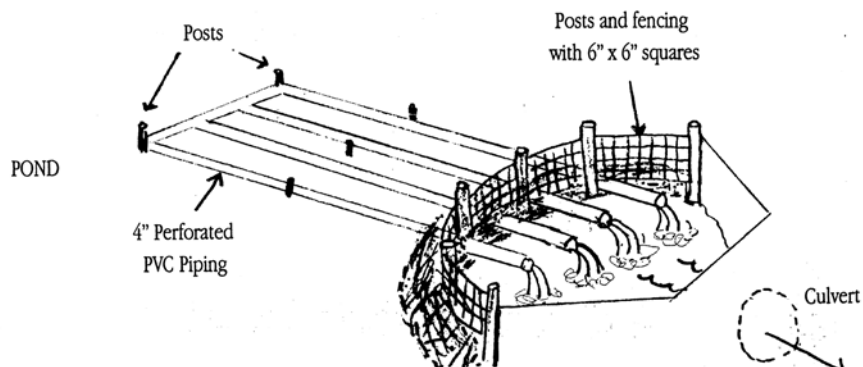

Figure 26

Although the addition of more PVC pipes will carry more water, they are still the limiting factor. Naturally occurring debris and beaver activity will quickly obstruct the perforations in the pipe rendering them useless. Inspections and cleanings will have to be increased to keep the perforations in the pipes open. Again, it is more efficient to keep the fence cleaned or enlarging the wire mesh enclosure as the large surface area of the fence will take the beavers much longer to obstruct it.

# Water Level Control Devices

## Pond Drain Pipe

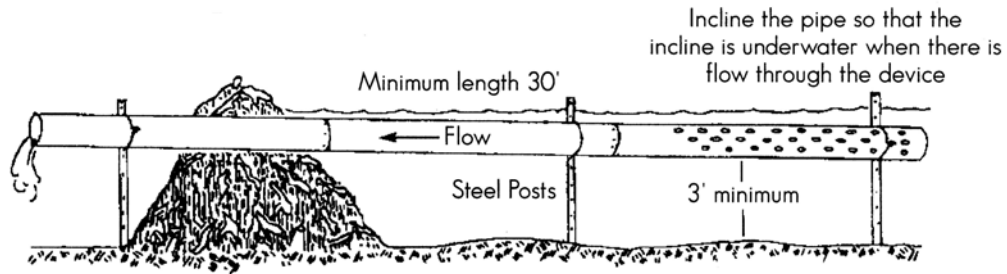

Figure 27

This is a standard design whose effectiveness is limited by the pipe diameter and the perforated hole size. Variations have the outlet even higher or the inlet higher than the outlet. In either case, periodic inspection and cleaning are required.

**Wire mesh enclosures around the intake are necessary and smaller screens will prevent the intake from being plugged though the use of screens demands increased inspections and cleanings but reduces pipe plugging problems.**

## Whirlpool effect

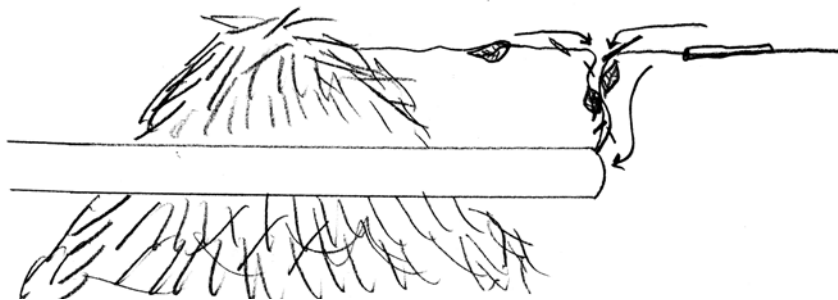

Figure 28

## Wire Mesh Culvert

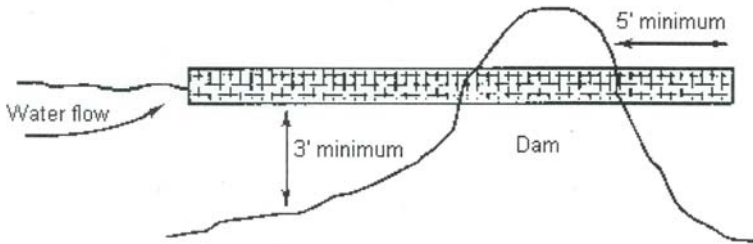

Figure 29

This design is unique but beavers will eventually figure out that they can insert twigs and small branches into the mesh and plug it up.

## PVWV Flexible Leveler

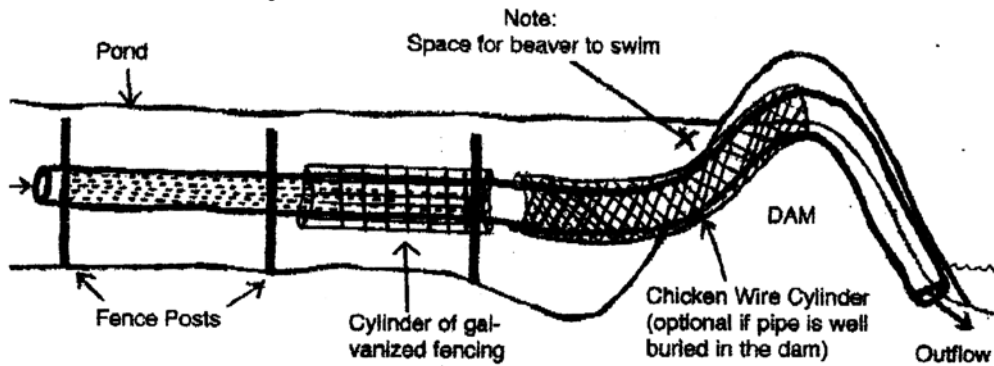

Figure 30

Debris can enter the pipe and collect at the bend to plug it up.

## The Clemson Beaver Pond Leveler

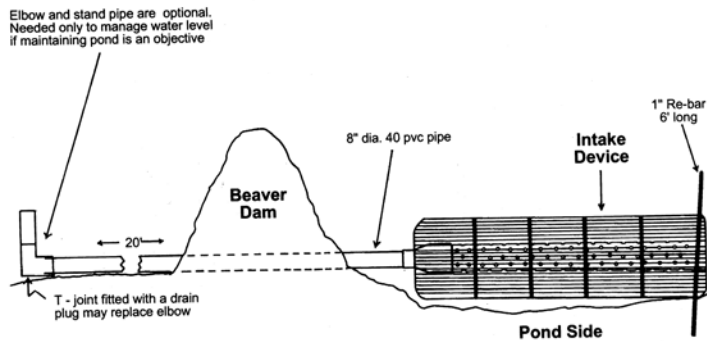

Figure 31

Though this design is ingenious, it is not maintenance free as the screens and perforated holes in the pipe do need periodic cleaning as debris will be sucked down into the screens and holes. One must be careful to be sure that the 8 inch diameter 40 PVC pipe will allow enough water to pass through to prevent it from running over the top of the dam but also to maintain a certain water level in the ponded area that will also keep it submerged. Various changes in pipe diameters can accommodate different flow rates.

## Low Water Crossing

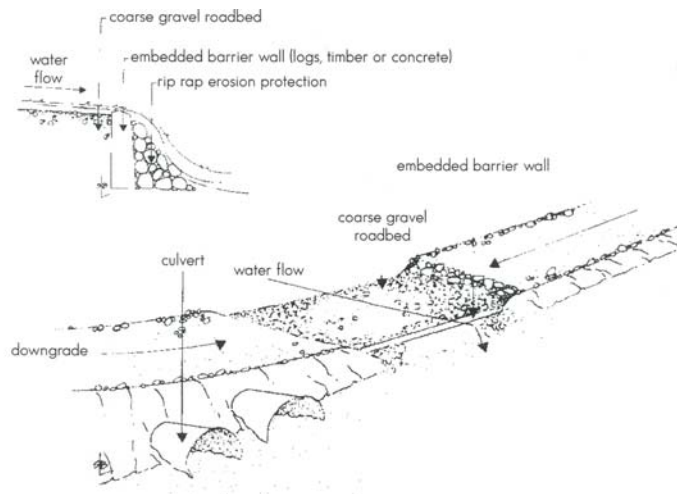

Figure 32

For remote roads and with the culverts being protected by fences or wire mesh screens this design can accommodate infrequent inspections and cleanings by allowing for water to safely cross over the road after the fences/screens were plugged up.

## More Examples:



Figure 33

This beaver reliever using 6 “wire mesh was still plugged up by beaver activity. The screen may not have enough width to be effective. Note the debris still entering the pipe. I installed a cylindrical screen made out of chicken wire out from the intake and inside the wire mesh screen. I also removed half the height of wire mesh screen and made a half-moon shaped barrier outside main screen at the intake to keep the beavers away from this area.



Figure 34

This was one of my first attempts of water regulation in 1994. The chain link fence is too narrow and the openings too small, allowing beavers to readily pack mud and sticks into the fence.. The use of 3 six inch diameter pipes plugged rapidly and hard to clean. In 2004 I removed this set up and installed a twelve inch diameter culvert, a 6” wire mesh rectangular screen and an inner cylinder chicken wire screen to keep smaller debris from plugging the intake.



**Figure 35**



**Figure 36**

During the summer of 2005 I built two temporary beaver relievers using PVC pipes that I previously removed from other beaver dams including the one pictured above. Beavers had built two new dams upstream of a beaver reliever that I reinstalled in 2004. I hope to be able to replace these with 1 foot diameter pipes as well as improving the screens



**Figure 37**

This is a photo of the intake of the beaver reliever pictured above on the right. There is an inner cylindrical screen of chicken wire that is preventing pine needles, leaves and other woody debris from entering the 3 6" PVC pipes.

## Future Planning

It is a good idea in both the planning stage and yearly reevaluating the impacts of beavers to rank current activity in the areas under your agencies jurisdiction. This would involve a priority ranking system. Other departments within your agency can help by keeping you informed of beaver activity.

1. High Priority:
  - A. Plugged culverts or pipes.
  - B. Impounded water from a beaver dam(s) damaging/flooding roads, trails, buildings, campsites and private property.
2. Moderate Priority:
  - A. Beavers or signs of beaver activity are present in the area but no current problems are yet associated with their activity.
3. Low Priority:
  - A. There are presently no beavers or activity but nearby presence of beaver colonies, stream gradient (0 to 2 % ) and vegetation type (willow and aspen) indicate that there is a very high probability that they will become a future problem as beaver population pressures increase.

## References

Olsen, Rich and Hubert, Wayne A. 1994. Beaver: water Resources and Riparian Habitat Manager. University of Wyoming.

Connecticut Department of Environmental Protection, Bureau of Natural Resources, Wildlife Division. 1997. Wildlife in Connecticut: Informational series, Beaver, *Castor Canadensis*.

Langlois, Susan and Decker, Thomas. Commonwealth of Massachusetts, Department of Fisheries, Wildlife & Environmental Law Enforcement: Division of Fisheries and Wildlife. The Use of Water Flow Devices in Addressing Flooding Problems Caused by Beaver in Massachusetts

Jensen, Paul G. and Curtis, Paul D. Department of Natural Resources, Cornell University & Hamelin, David L. division of Fish, Wildlife and Marine Resources, New York State Department of Environmental Conservation. 1999. Managing Nuisance Beavers Along Roadsides. A Guide for Highway Departments

The Colorado Division of Wildlife: Education 06/29/2000. Beaver Problems Growing.

Lisle, Skip 09/01/1999. Beaver Management at the Penoscot Indian Nation.

Newbill, C. Benjamin and Parkhurst, Jim. Virginia State University, Virginia Cooperative Extension, Publication 420-202, 2000. Managing Wildlife Damage....Beavers (Castor Canadensis)

Hadidian, John. 11/11/2003. The Humane Society of the United States, Wildlife News: U. S. Beaver Management Tool Crosses the Pond.

U. S. Roads; Road Management & Engineering Journal. TranSafety, Inc. 04/01/1998.

Guidelines for Controlling Beavers and Preventing Roadway Damage.

Wood, Dr. Gene W., Woodward, Larry A. and Yarrow, Dr. Greg. Extension, Clemson University, Department of Aquaculture, Fisheries and Wildlife 1994. The Clemson Beaver Pond Leveler.

Campbell, Dan L., USD-APHIS, Denver Wildlife Research Center, Olympia Field Station. 1994. Mountain Beavers.

Alberta Agricultural, Food and Rural Development. Agri-Fax. Agdex 681-1. Control of Beaver Damage.

University of New Hampshire Cooperative Extension. Reprinted 9/97. Beavers and Their Control.

The Humane Society of the United States, Wildlife and National Park Service; Rock Mountain National Park. 2000. Seminar 09/7-9/1999. Estes Park, Colorado. Beaver and Common-Sense Conflict Solutions.