

### 3. HEALTH EFFECTS

#### 3.1 INTRODUCTION

The primary purpose of this chapter is to provide public health officials, physicians, toxicologists, and other interested individuals and groups with an overall perspective on the toxicology of bromoform and dibromochloromethane. It contains descriptions and evaluations of toxicological studies and epidemiological investigations and provides conclusions, where possible, on the relevance of toxicity and toxicokinetic data to public health.

A glossary and list of acronyms, abbreviations, and symbols can be found at the end of this profile.

#### 3.2 DISCUSSION OF HEALTH EFFECTS BY ROUTE OF EXPOSURE

To help public health professionals and others address the needs of persons living or working near hazardous waste sites, the information in this section is organized first by route of exposure (inhalation, oral, and dermal) and then by health effect (death, systemic, immunological, neurological, reproductive, developmental, genotoxic, and carcinogenic effects). These data are discussed in terms of three exposure periods: acute (14 days or less), intermediate (15–364 days), and chronic (365 days or more).

Levels of significant exposure for each route and duration are presented in tables and illustrated in figures. The points in the figures showing no-observed-adverse-effect levels (NOAELs) or lowest-observed-adverse-effect levels (LOAELs) reflect the actual doses (levels of exposure) used in the studies. LOAELs have been classified into "less serious" or "serious" effects. "Serious" effects are those that evoke failure in a biological system and can lead to morbidity or mortality (e.g., acute respiratory distress or death). "Less serious" effects are those that are not expected to cause significant dysfunction or death, or those whose significance to the organism is not entirely clear. ATSDR acknowledges that a considerable amount of judgment may be required in establishing whether an end point should be classified as a NOAEL, "less serious" LOAEL, or "serious" LOAEL, and that in some cases, there will be insufficient data to decide whether the effect is indicative of significant dysfunction. However, the Agency has established guidelines and policies that are used to classify these end points. ATSDR believes that there is sufficient merit in this approach to warrant an attempt at distinguishing between

### 3. HEALTH EFFECTS

"less serious" and "serious" effects. The distinction between "less serious" effects and "serious" effects is considered to be important because it helps the users of the profiles to identify levels of exposure at which major health effects start to appear. LOAELs or NOAELs should also help in determining whether or not the effects vary with dose and/or duration, and place into perspective the possible significance of these effects to human health.

The significance of the exposure levels shown in the Levels of Significant Exposure (LSE) tables and figures may differ depending on the user's perspective. Public health officials and others concerned with appropriate actions to take at hazardous waste sites may want information on levels of exposure associated with more subtle effects in humans or animals (LOAELs) or exposure levels below which no adverse effects (NOAELs) have been observed. Estimates of levels posing minimal risk to humans (Minimal Risk Levels or MRLs) may be of interest to health professionals and citizens alike.

Levels of exposure associated with carcinogenic effects (Cancer Effect Levels, CELs) of bromoform or dibromochloromethane are indicated in Tables 3-1 and 3-2 and Figures 3-1 and 3-2. Because cancer effects could occur at lower exposure levels, Figures 3-1 and 3-2 also shows a range for the upper bound of estimated excess risks, ranging from a risk of 1 in 10,000 to 1 in 10,000,000 ( $10^{-4}$  to  $10^{-7}$ ), as developed by EPA.

A User's Guide has been provided at the end of this profile (see Appendix B). This guide should aid in the interpretation of the tables and figures for Levels of Significant Exposure and the MRLs.

#### **3.2.1 Inhalation Exposure**

No studies were located regarding health effects of bromoform or dibromochloromethane in humans following inhalation exposure. In animals, there are limited data from several older studies on the effects of inhalation exposure to bromoform; no studies were located regarding effects of dibromochloromethane.

##### **3.2.1.1 Death**

Inhalation of very high concentrations (56,000 or 84,000 ppm) of bromoform vapor for 1 hour has been reported to cause death in dogs (Merzbach 1928). The chief symptoms noted were initial excitation

### 3. HEALTH EFFECTS

followed by deep sedation. This indicates that central nervous system depression is probably the chief cause of death in such acute exposures. Because only two animals were used (one animal per dose) and only high doses were administered, these data do not provide a reliable estimate of the minimum lethal concentration in dogs or other animal species.

#### 3.2.1.2 Systemic Effects

No studies were located regarding respiratory, cardiovascular, gastrointestinal, hematological, musculoskeletal, endocrine, dermal, ocular, or body weight effects in animals or humans following inhalation exposure to bromoform or dibromochloromethane.

**Hepatic Effects.** Two studies (Dykan 1962, 1964; published in Russian and available only as the English abstract) indicate that inhalation exposure of animals to high concentrations of bromoform leads to hepatic injury. Exposure of rats to 240 ppm of bromoform for 10 days resulted in dystrophic and vascular changes in the liver, with altered hepatic metabolism (Dykan 1964). Longer-term exposure (2 months) to concentrations of 24 ppm also led to hepatic changes (decreased blood clotting and impaired glycogenesis) (Dykan 1962). No significant alterations were observed after exposure to 4.8 ppm (Dykan 1964). These changes appear to resemble the changes produced after oral exposure to bromoform (see Section 3.2.2.2), suggesting that the hepatotoxicity of bromoform is not route-specific.

**Renal Effects.** Similar to the hepatic effects, exposure to 240 ppm bromoform for 10 days resulted in dystrophic and vascular changes in the kidney with altered renal filtration (Dykan 1964). A 2-month exposure to 24 ppm resulted in proteinuria and decreased creatinine clearance (Dykan 1962). A concentration of 4.8 ppm was estimated to be without significant effects on the kidney (Dykan 1964). These changes appear to resemble the changes produced after oral exposure to bromoform (see Section 3.2.2.2).

#### 3.2.1.3 Immunological and Lymphoreticular Effects

No studies were located regarding immunological effects in humans or animals after inhalation exposure to bromoform or dibromochloromethane.

## 3. HEALTH EFFECTS

**3.2.1.4 Neurological Effects**

Inhalation exposure to high levels (29,000 ppm or above) of bromoform has been observed to lead to rapid and profound depression of the central nervous system in dogs (Graham 1915; Merzbach 1928). This is presumably due to a nonspecific anesthetic effect similar to that produced by various other volatile halocarbons. Obvious clinical signs included deep relaxation and sedation (Merzbach 1928). Clinical signs of nervous system depression appeared quickly (within minutes), and tended to disappear within a day after exposure ceased (Graham 1915).

No studies were located regarding the following effects in humans or animals after inhalation exposure to bromoform or dibromochloromethane:

**3.2.1.5 Reproductive Effects****3.2.1.6 Developmental Effects****3.2.1.7 Cancer****3.2.2 Oral Exposure**

Most information on the health effects of bromoform and dibromochloromethane comes from studies in animals (rats and mice) exposed by the oral route. For bromoform, there are some observations in humans stemming from the past use of bromoform as a sedative, but no studies were located on the effect of dibromochloromethane in humans. Summaries of studies that provide reliable quantitative toxicity data are presented in Table 3-1 and Figure 3-1 for bromoform and in Table 3-2 and Figure 3-2 for dibromochloromethane. The main conclusions from these studies are discussed below.

**3.2.2.1 Death**

***Bromoform.*** In the early part of this century, bromoform was often given as a sedative to children suffering from whooping cough, and several deaths due to accidental overdoses have been described (Dwelle 1903; Kobert 1906; Roth 1904 as cited in von Oettingen 1955). The principal clinical signs in fatal cases were those of severe central nervous system depression (unconsciousness, stupor, and loss of reflexes), and death was generally the result of respiratory failure (von Oettingen 1955). If death could be averted, recovery was generally complete within several days (Benson et al. 1907; Burton-Fanning 1901;

Table 3-1 Levels of Significant Exposure to Bromoform - Oral

Key to Figure <sup>a</sup>	Species (Strain)	Exposure/ Duration/ Frequency (Route)	System	NOAEL (mg/kg/day)	LOAEL		Reference Chemical Form
					Less Serious (mg/kg/day)	Serious (mg/kg/day)	
<b>ACUTE EXPOSURE</b>							
<b>Death</b>							
1	Human	1 d				445 F (single child died due to overdose)	Dwelle 1903
2	Rat (Sprague-Dawley)	1 day (GO)				1147 F (LD50)	Chu et al 1982a
3	Rat (Sprague-Dawley)	(G)				1388 M (LD50) 1147 <sup>b</sup> F (LD50)	Chu et al. 1980
4	Rat (Fischer- 344)	1 d (GO)				933 (LD50)	NTP 1989a
5	Rat (Fischer- 344)	14 d 1x/d (GO)				600 (100% mortality)	NTP 1989a
6	Mouse (ICR)	1 d (GW)				1400 <sup>b</sup> M (LD50) 1550 F (LD50)	Bowman et al 1978
7	Mouse (B6C3F1)	1 d (GO)				707 <sup>b</sup> M (LD50) 1072 F (LD50)	NTP 1989a

Table 3-1 Levels of Significant Exposure to Bromoform - Oral

(continued)

Key to Figure	Species (Strain)	Exposure/Duration/Frequency (Route)	System	NOAEL (mg/kg/day)	LOAEL		Reference Chemical Form
					Less Serious (mg/kg/day)	Serious (mg/kg/day)	
<b>8</b>	Rat (Fischer- 344)	14 d 1x/d (GO)	Endocr	600	800	(enlarged thyroid gland)	NTP 1989a
			Bd Wt	200 M	400 M	(14% decreased body weight gain)	
<b>9</b>	Rat	1 d (G)	Hepatic	1440			Plaa and Hewitt 1982a
<b>10</b>	Rat (Fischer- 344)	7 d (GW)	Endocr	190 M	380 M	(decreased serum testosterone)	Potter et al 1996
			Bd Wt	380 M			
<b>11</b>	Mouse (B6C3F1)	9 doses in 11 days (GO)	Hepatic		200 F	(hepatocellular ballooning and proliferation)	Coffin et al 2000
<b>12</b>	Mouse (B6C3F1)	11 days (W)	Hepatic		300 F	(hepatocellular ballooning)	Coffin et al 2000
<b>13</b>	Mouse (CD-1)	14 d 1x/d (GO)	Hepatic	72 M	145 M	(centrilobular pallor)	Condie et al 1983
			Renal	72 M	145 M	(mesangial nephrosis)	
			Bd Wt	289 M			

Table 3-1 Levels of Significant Exposure to Bromoform - Oral

(continued)

Key to Figure	Species (Strain)	Exposure/ Duration/ Frequency (Route)	System	NOAEL (mg/kg/day)	LOAEL		Reference Chemical Form
					Less Serious (mg/kg/day)	Serious (mg/kg/day)	
14	Mouse (CD-1)	14 d 1x/d (GW)	Hepatic	50 M	125 M (increased absolute and relative liver weights)		Munson et al 1982
15	Mouse (B6C3F1)	14 d 1x/d (GO)	Gastro	200 M	400 M (stomach nodules)		NTP 1989a
<b>Immuno/ Lymphoret</b>							
16	Mouse (CD-1)	14 d 1x/d (GW)		125 M	250 M (impaired humoral immune function)		Munson et al 1982
<b>Neurological</b>							
17	Rat (Fischer- 344)	14 d 1x/d (GO)		400	600 (lethargy, labored and swallowing breathing, ataxia)		NTP 1989a
18	Rat (Fischer- 344)	1 d (GO)		500	1000 (shallow breathing)		NTP 1989a
19	Mouse (ICR)	14 days daily (GW)		9.7 M			Balster and Borzelleca 1982 Bromoform
20	Mouse (ICR)	1 d (GW)			431 M (ED50 for impaired motor performance)		Balster and Borzelleca 1982

Table 3-1 Levels of Significant Exposure to Bromoform - Oral

(continued)

Key to Figure	Species (Strain)	Exposure/Duration/Frequency (Route)	System	NOAEL (mg/kg/day)	LOAEL		Reference Chemical Form	
					Less Serious (mg/kg/day)	Serious (mg/kg/day)		
21	Mouse (ICR)	1 d (GW)				1000	(ataxia, sedation, anesthesia)	Bowman et al 1978
22	Mouse (B6C3F1)	14 d 1x/d (GO)		400		600	(lethargy and ataxia)	NTP 1989a
<b>Developmental</b>								
23	Rat (Sprague-Dawley)	9 d Gd 6-15 (GO)		100		200	(skeletal anom.)	Ruddick et al 1983
<b>INTERMEDIATE EXPOSURE</b>								
<b>Systemic</b>								
24	Rat (Wistar)	30 d (F)	Hepatic		56.4 F		(hepatocellular vacuolization and swelling)	Aida et al 1992
			Bd Wt	187.2 M		617.9 M	(24% decreased body weight)	
25	Rat (Sprague-Dawley)	28 d (W)	Hemato	14 M				Chu et al 1982a
			Hepatic	14 M				
			Renal	14 M				
			Bd Wt	14 M				



Table 3-1 Levels of Significant Exposure to Bromoform - Oral

(continued)

Key to Figure <sup>a</sup>	Species (Strain)	Exposure/Duration/Frequency (Route)	System	LOAEL			Reference Chemical Form
				NOAEL (mg/kg/day)	Less Serious (mg/kg/day)	Serious (mg/kg/day)	
26	Rat (Fischer- 344)	13 wk 5d/wk (GO)	Resp	200			NTP 1989a
			Cardio	200			
			Gastro	200			
			Hepatic	25 <sup>d</sup> M	50 M (hepatocellular vacuolization)		
			Renal	200			
			Endocr	200			
			Dermal	200			
			Bd Wt	200			
27	Mouse (B6C3F1)	3 wk 5 d/wk (GO)	Hepatic	200 F	500 F (hepatocyte hydropic degeneration; increased SGPT and sorbitol dehydrogenase)		Melnick et al 1998
			Bd Wt	500 F			

Table 3-1 Levels of Significant Exposure to Bromoform - Oral

(continued)

Key to Figure	Species (Strain)	Exposure/Duration/Frequency (Route)	System	LOAEL			Reference Chemical Form
				NOAEL (mg/kg/day)	Less Serious (mg/kg/day)	Serious (mg/kg/day)	
28	Mouse (B6C3F1)	13 wk 5d/wk (GO)	Resp	400			NTP 1989a
			Cardio	400			
			Hepatic	100 M	200 M (minimal to moderate hepatocellular vacuoles)		
			Renal	400			
			Endocr	400			
			Dermal	400			
			Bd Wt	400			
29	Mouse (Swiss)	102 d 1x/d (GO)	Resp	200			NTP 1989b
			Hepatic		200 (hepatocellular vacuoles)		
			Renal	200			
			Endocr	200			
<b>Neurological</b>							
30	Rat (Fischer- 344)	13 wk 5d/wk (GO)		50 M	100 M (lethargy)		NTP 1989a
31	Mouse (ICR)	90 d 1x/d (GW)		0.9 M	9.2 M (decreased exploratory activity)		Balster and Borzelleca 1982 Bromoform

Table 3-1 Levels of Significant Exposure to Bromoform - Oral

(continued)

Key to Figure <sup>a</sup>	Species (Strain)	Exposure/Duration/Frequency (Route)	System	LOAEL		Reference Chemical Form
				NOAEL (mg/kg/day)	Less Serious (mg/kg/day)	
32	Mouse (ICR)	60 d 1x/d (GW)			100 M (decreased response rate in operant behavior test)	Balster and Borzelleca 1982 Bromoform
33	Mouse (ICR)	30d 1x/d (GW)		100 M		Balster and Borzelleca 1982
<b>Reproductive</b>						
34	Rat (Fischer- 344)	13 wk 5d/wk (GO)		200		NTP 1989a
35	Mouse (B6C3F1)	13 wk 5d/wk (GO)		400		NTP 1989a
36	Mouse (Swiss)	105 d 1x/d (GO)		200		NTP 1989b
<b>CHRONIC EXPOSURE</b>						
<b>Death</b>						
37	Rat (Fischer- 344)	103 wk 5d/wk (GO)			200 M (decreased survival)	NTP 1989a

Table 3-1 Levels of Significant Exposure to Bromoform - Oral

(continued)

Key to Figure <sup>a</sup>	Species (Strain)	Exposure/ Duration/ Frequency (Route)	System	NOAEL (mg/kg/day)	LOAEL		Reference Chemical Form
					Less Serious (mg/kg/day)	Serious (mg/kg/day)	
<b>Systemic</b>							
38	Rat (Fischer- 344)	103 wk 5d/wk (GO)	Cardio	200			NTP 1989a
			Gastro	100 M	200 M (forestomach ulcer)		
			Hemato	100 F	200 F (spleen pigmentation)		
			Hepatic		100 <sup>e</sup> (hepatocellular vacuolization)		
			Renal	200			
			Endocr		100 M (pituitary gland hyperplasia)		
			Dermal	200			
Bd Wt	100	200 (>10% decrease in body weight gain)					
39	Rat (Wistar)	2 year (F)	Hepatic	35 F	140 F (yellowing of liver; increased absolute and relative liver weight)		Tobe et al 1982
			Bd Wt	90 M		590 M (40% decrease in body weight gain)	

Table 3-1 Levels of Significant Exposure to Bromoform - Oral

(continued)

Key to Figure <sup>a</sup>	Species (Strain)	Exposure/Duration/Frequency (Route)	System	NOAEL (mg/kg/day)	LOAEL		Reference Chemical Form
					Less Serious (mg/kg/day)	Serious (mg/kg/day)	
40	Mouse (B6C3F1)	103 wk 5d/wk (GO)	Resp	100 M			NTP 1989a
			Cardio	100 M			
			Gastro	50 M	100 M (hyperplasia in glandular stomach)		
			Musc/skel	100 M			
			Hepatic		100 F (hepatocellular vacuolization)		
			Renal	100 M			
			Endocr	100 F	200 F (follicular cell hyperplasia in thyroid)		
			Dermal	100 M			
		Bd Wt	100 M				
<b>Neurological</b>							
41	Rat (Fischer-344)	103 wk 5d/wk (GO)			100	(lethargy)	NTP 1989a
<b>Reproductive</b>							
42	Rat (Fischer-344)	103 wk 5d/wk (GO)		100 M <sup>b</sup> 200 F	200 M	(squamous metaplasia in prostate)	NTP 1989a

Table 3-1 Levels of Significant Exposure to Bromoform - Oral

(continued)

Key to Figure <sup>a</sup>	Species (Strain)	Exposure/ Duration/ Frequency (Route)	System	LOAEL		Reference Chemical Form
				NOAEL (mg/kg/day)	Less Serious (mg/kg/day)	
43	Mouse (B6C3F1)	103 wk 5d/wk (GO)		100 M <sup>b</sup> 200 F		NTP 1989a
<b>Cancer</b>						
44	Rat (Fischer- 344)	103 wk 5d/wk (GO)			200 F (CEL: adenomatous polyps and adenocarcinoma in large intestine)	NTP 1989a

a The number corresponds to entries in Figure 3-1.

b Differences in levels of health effects and cancer effects between male and females are not indicated in Figure 3-1. Where such differences exist, only the levels of effect for the most sensitive gender are presented.

c Used to derive an acute-duration oral MRL of 0.7 mg/kg/day; dose divided by an uncertainty factory of 100 (10 for extrapolation from animals to humans and 10 for human variability).

d Used to derive an intermediate-duration oral MRL of 0.2 mg/kg/day; dose adjusted for intermittent exposure and divided by an uncertainty factor of 100 (10 for extrapolation from animals to humans, and 10 for human variability).

e Used to derive a chronic-duration oral MRL of 0.02 mg/kg/day; dose adjusted for intermittent exposure and divided by an uncertainty factory of 300 (3 for extrapolation from a minimal LOAEL, 10 for extrapolation from animals to humans, and 10 for human variability) and a modifying factor of 10 to account for the identification of a lower LOAEL in a subchronic study (NTP 1989a).

d = day(s); F = female; (F) = food; (G) = gavage; Gastro = gastrointestinal; LD50 = lethal dose, 50% kill; LOAEL = lowest-observed-adverse-effect level; M = male; NOAEL = no-observed-adverse-effect level; (W) = water; wk = week(s); x = time(s)

Figure 3-1. Levels of Significant Exposure to Bromoform - Oral  
Acute ( $\leq 14$  days)

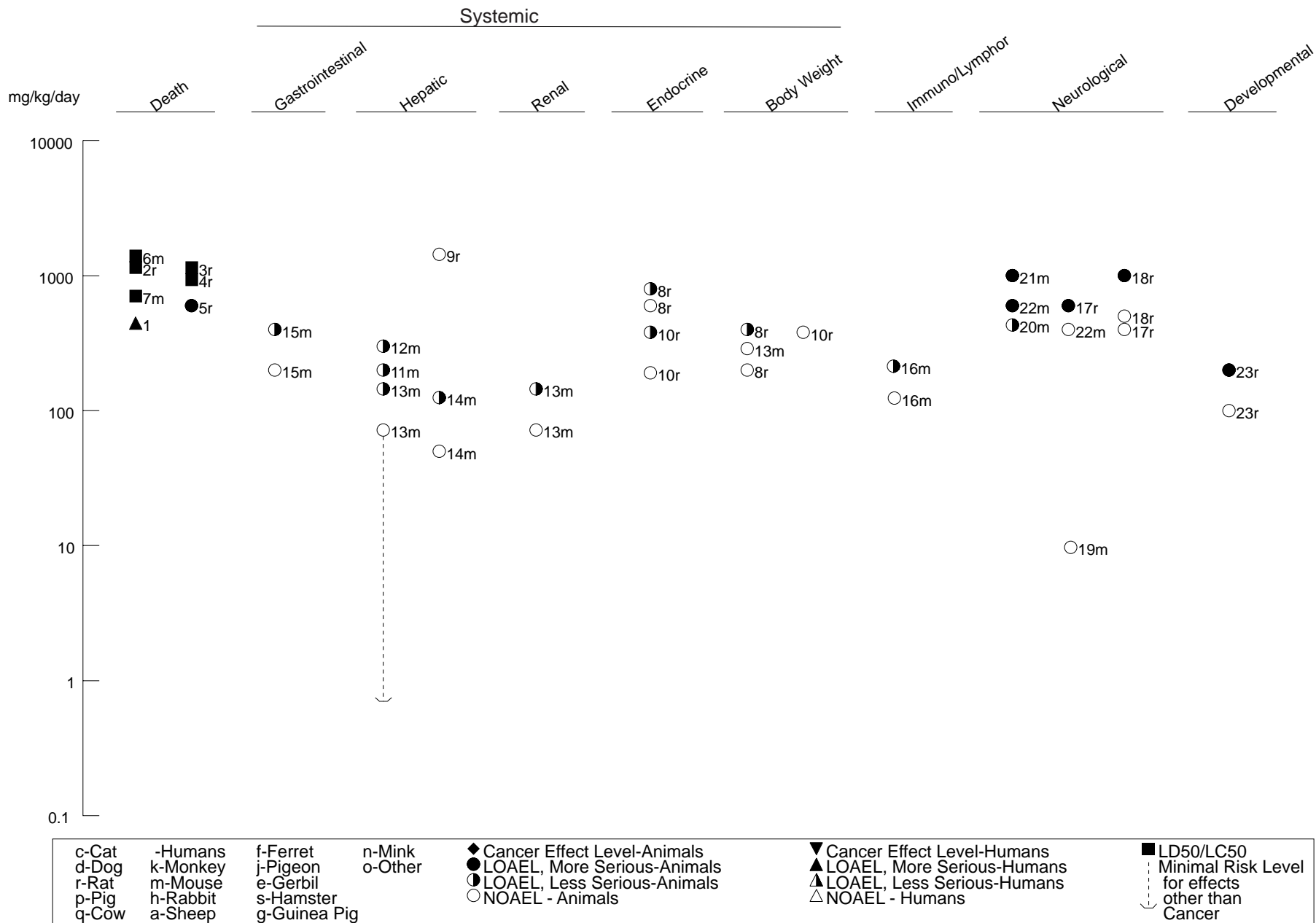
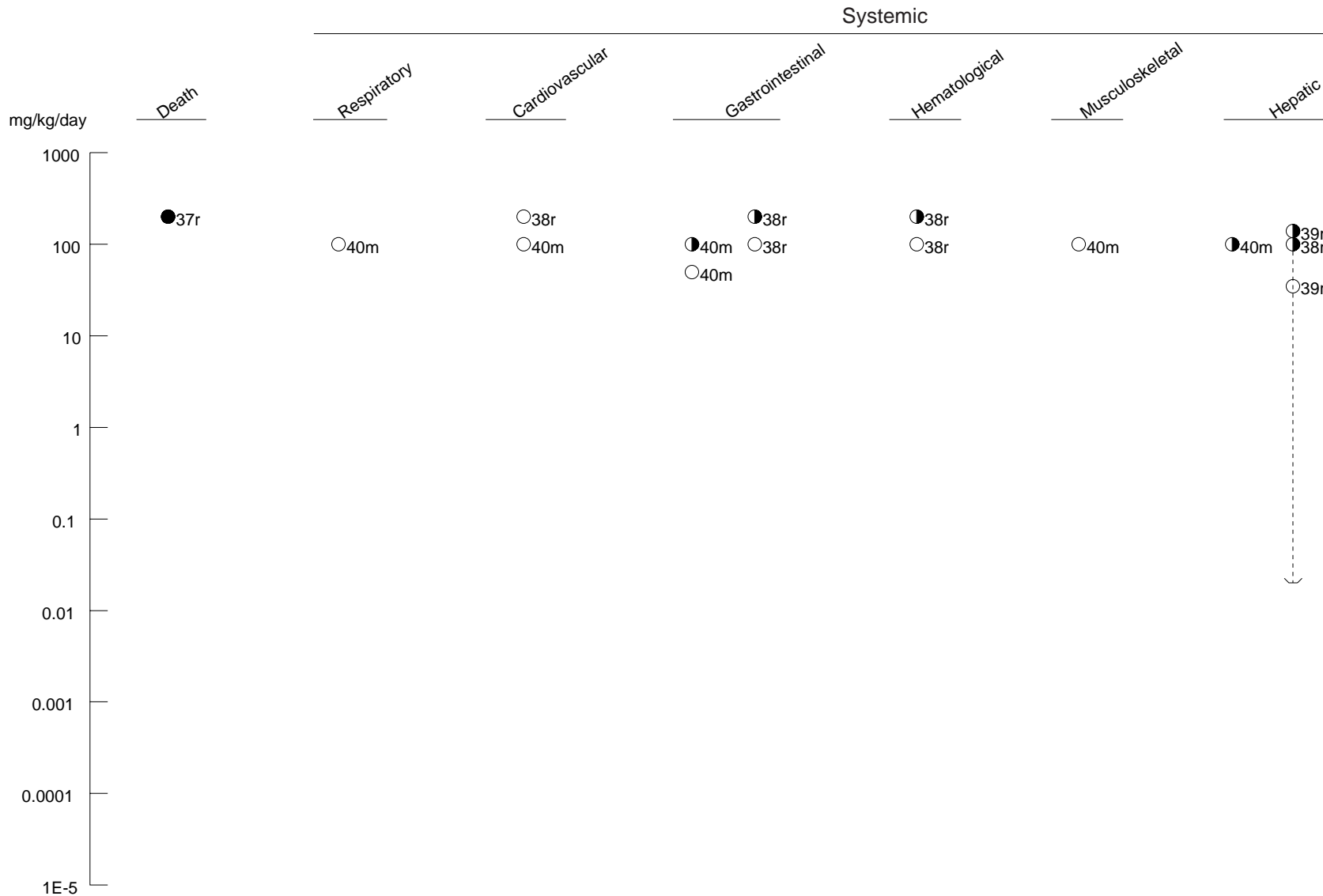





Figure 3-1 Levels of Significant Exposure to Bromoform - Oral  
Chronic ( $\geq 365$  days)



c-Cat	-Humans	f-Ferret	n-Mink	◆ Cancer Effect Level-Animals	▼ Cancer Effect Level-Humans	■ LD50/LC50
d-Dog	k-Monkey	j-Pigeon	o-Other	● LOAEL, More Serious-Animals	▲ LOAEL, More Serious-Humans	⋮ Minimal Risk Level
r-Rat	m-Mouse	e-Gerbil		◐ LOAEL, Less Serious-Animals	△ LOAEL, Less Serious-Humans	for effects
p-Pig	h-Rabbit	s-Hamster		○ NOAEL - Animals	△ NOAEL - Humans	other than
q-Cow	a-Sheep	g-Guinea Pig				Cancer

Figure 3-1 Levels of Significant Exposure to Bromoform - Oral  
Chronic (≥365 days)

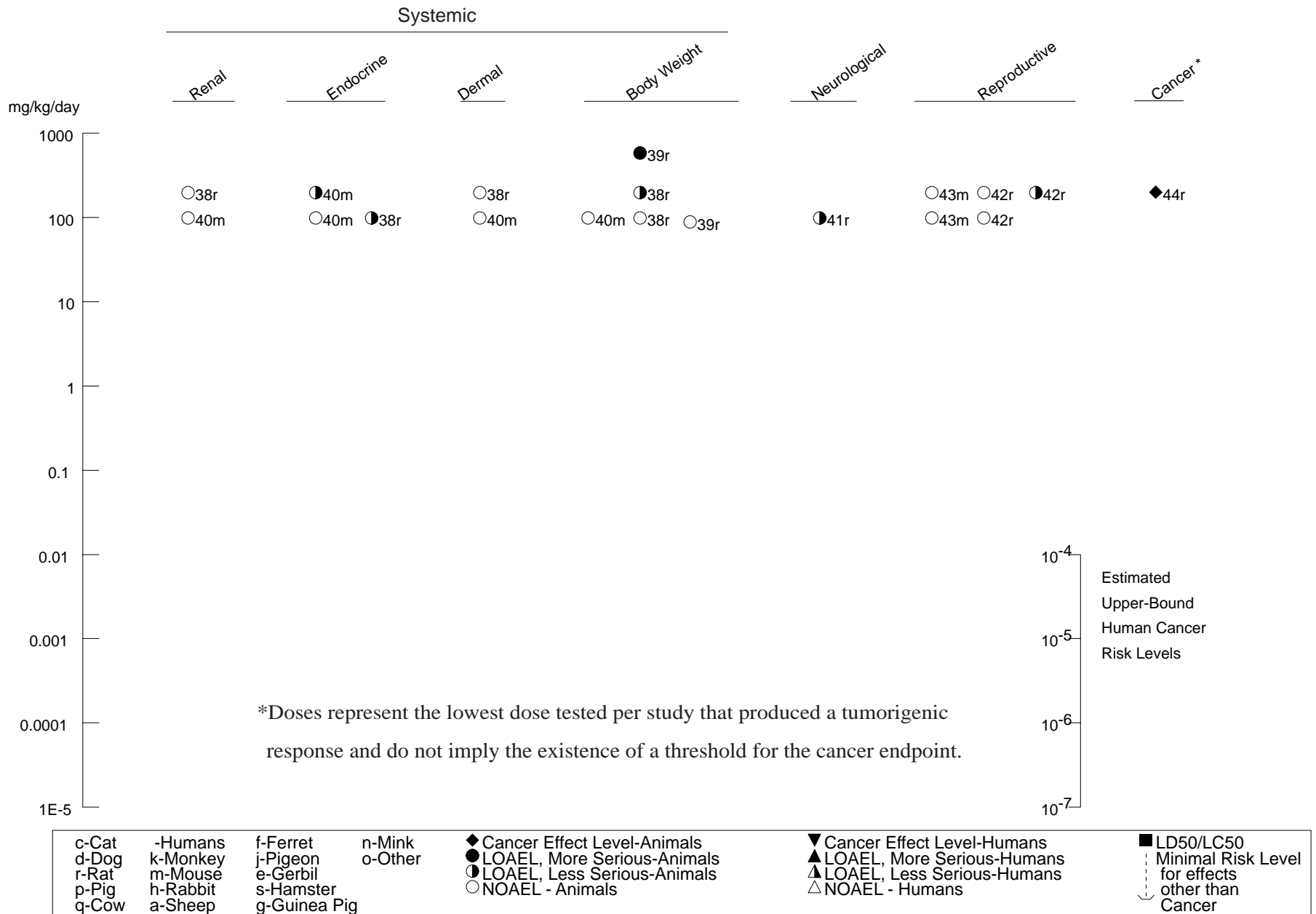

Table 3-2 Levels of Significant Exposure to Dibromochloromethane - Oral

Key to Figure <sup>a</sup>	Species (Strain)	Exposure/ Duration/ Frequency (Route)	System	NOAEL (mg/kg/day)	LOAEL		Reference Chemical Form
					Less Serious (mg/kg/day)	Serious (mg/kg/day)	
<b>ACUTE EXPOSURE</b>							
<b>Death</b>							
1	Rat (Sprague-Dawley)	1 d (GO)				848 F (LD50)	Chu et al 1982a
2	Rat (Sprague-Dawley)	(G)				1186 M (LD50) 848 F (LD50) <sup>b</sup>	Chu et al. 1980
3	Rat (Sprague-Dawley)	1 d (GO)				3700 M (100% mortality)	Hewitt et al 1983
4	Rat (Fischer- 344)	1 d (GO)				1250 M (4/5 died)	NTP 1985
5	Rat (Fischer- 344)	14 d 1x/d (GO)				500 (8 of 10 died)	NTP 1985
6	Mouse (ICR)	1 d (GW)				800 M (LD50) <sup>b</sup> 1200 F (LD50)	Bowman et al 1978
7	Mouse (B6C3F1)	1 d (GO)				630 M (3/5 died)	NTP 1985
8	Mouse (B6C3F1)	14 d 1x/d (G)				500 (7 of 10 died)	NTP 1985

Table 3-2 Levels of Significant Exposure to Dibromochloromethane - Oral

(continued)

Key to Figure <sup>a</sup>	Species (Strain)	Exposure/Duration/Frequency (Route)	System	NOAEL (mg/kg/day)	LOAEL		Reference Chemical Form
					Less Serious (mg/kg/day)	Serious (mg/kg/day)	
9	Hamster (Golden Syrian)	1 d (G)				145 M (LD50)	Korz and Gatterman 1997
<b>Systemic</b>							
10	Rat (Sprague-Dawley)	1 d (GO)	Hepatic		2500 M (increased SGPT and OCT levels)		Hewitt et al 1983
			Renal	2500 M			
11	Rat (Fischer-344)	14 d 1x/d (GO)	Hepatic	250	500 (mottled liver)		NTP 1985
			Renal	250	500 (darkened renal medullae)		
			Bd Wt	125 M	250 M (45% decrease body weight gain)		
12	Rat	1 d (G)	Hepatic	1220			Plaa and Hewitt 1982a
13	Rat (Fischer-344)	7 d (GW)	Endocr	160 M	310 M (decreased serum testosterone)		Potter et al 1996
			Bd Wt	160 M	310 M (14% decrease in body weight)		

Table 3-2 Levels of Significant Exposure to Dibromochloromethane - Oral

(continued)

Key to Figure <sup>a</sup>	Species (Strain)	Exposure/ Duration/ Frequency (Route)	System	NOAEL (mg/kg/day)	LOAEL		Reference Chemical Form
					Less Serious (mg/kg/day)	Serious (mg/kg/day)	
14	Mouse (B6C3F1)	9 doses in 11 day period (GO)	Hepatic		100 F (hepatocellular ballooning and proliferation)		Coffin et al 2000
15	Mouse (B6C3F1)	11 days (W)	Hepatic		170 F (hepatocellular ballooning)		Coffin et al 2000
16	Mouse (CD-1)	14 d 1x/d (GO)	Hepatic		37 <sup>C</sup> M (hepatocellular vacuolization)		Condie et al 1983
			Renal Bd Wt	147 M	37 M (mesangial hyperplasia)		
17	Mouse (CD-1)	14 d 1x/d (GW)	Hepatic	125 F	250 F (increased relative and absolute liver weight, decreased serum glucose, and increased SGPT and SGOT)		Munson et al 1982
18	Mouse (B6C3F1)	14 d 1x/d (GO)	Renal	250	500 (reddened renal medullae)		NTP 1985
<b>Immuno/ Lymphoret</b>							
19	Mouse (CD-1)	14 d 1x/d (GW)		50 F	125 F (impaired humoral immunity)		Munson et al 1982

Table 3-2 Levels of Significant Exposure to Dibromochloromethane - Oral

(continued)

Key to Figure <sup>a</sup>	Species (Strain)	Exposure/ Duration/ Frequency (Route)	System	NOAEL (mg/kg/day)	LOAEL		Reference Chemical Form
					Less Serious (mg/kg/day)	Serious (mg/kg/day)	
<b>Neurological</b>							
20	Rat (Fischer- 344)	14 d 1x/d (GO)		250		500 (lethargy, ataxia)	NTP 1985
21	Rat (Fischer- 344)	1 d (GO)		160	310 (lethargy)		NTP 1985
22	Mouse (ICR)	14 days daily (GW)		10 M			Balster and Borzelleca 1982
23	Mouse (ICR)	1 d (GW)			454 M (ED50 for impaired motor performance)		Balster and Borzelleca 1982 Chlorodibromomethane
24	Mouse (ICR)	1 d (GW)				500 (sedation, anesthesia)	Bowman et al 1978
25	Mouse (B6C3F1)	14 d 1x/d (GO)		250		500 (lethargy, ataxia, and labored breathing)	NTP 1985
<b>Developmental</b>							
26	Rat (Sprague-Dawley)	9 d Gd 6-15 (GO)		200			Ruddick et al 1983
<b>INTERMEDIATE EXPOSURE</b>							
<b>Death</b>							
27	Rat (Fischer- 344)	13 wk 5d/wk (G)				250 (18/ 20 died)	NTP 1985

Table 3-2 Levels of Significant Exposure to Dibromochloromethane - Oral

(continued)

Key to Figure <sup>a</sup>	Species (Strain)	Exposure/ Duration/ Frequency (Route)	System	NOAEL (mg/kg/day)	LOAEL		Reference Chemical Form
					Less Serious (mg/kg/day)	Serious (mg/kg/day)	
<b>Systemic</b>							
28	Rat (Wistar)	30 d (F)	Hepatic	18.3 M	56.2 M (heptocellular vacuolation)		Aida et al 1992
			Bd Wt	173.3 M			
29	Rat (Sprague- Dawley)	28 d (W)	Hemato	12 M			Chu et al 1982a
			Hepatic	12 M			
			Renal	12 M			
			Bd Wt	12 M			

Table 3-2 Levels of Significant Exposure to Dibromochloromethane - Oral

(continued)

Key to Figure <sup>a</sup>	Species (Strain)	Exposure/ Duration/ Frequency (Route)	System	NOAEL (mg/kg/day)	LOAEL		Reference Chemical Form
					Less Serious (mg/kg/day)	Serious (mg/kg/day)	
30	Rat (Sprague- Dawley)	90 d (GO)	Resp	200			Daniel et al. 1990
			Cardio	200			
			Gastro	200			
			Hemato	200			
			Hepatic		50 (hepatocellular vacuolization)		
			Renal	50	100 (tubular degeneration)		
			Endocr	200			
			Dermal	200			
			Ocular	200			
Bd Wt	50		200 (55% decrease in body weight gain)				



Table 3-2 Levels of Significant Exposure to Dibromochloromethane - Oral

(continued)

Key to Figure	Species (Strain)	Exposure/Duration/Frequency (Route)	System	NOAEL (mg/kg/day)	LOAEL		Reference Chemical Form
					Less Serious (mg/kg/day)	Serious (mg/kg/day)	
31	Rat (Fischer-344)	13 wk 5d/wk (GO)	Resp	250			NTP 1985
			Cardio	250			
			Gastro	250			
			Musc/skel	250			
			Hepatic	30 M	60 M (hepatocellular vacuolization)		
			Renal	125	250 (toxic nephropathy)		
			Endocr	250			
			Dermal	250			
			Bd Wt	125 M		250 M (47% decreased body weight gain)	
			Other		250 (salivary gland hyperplasia)		
32	Mouse (B6C3F1)	3 wk 5 d/wk (GO)	Hepatic	50 F	192 F (hepatocyte hydropic degeneration)		Melnick et al 1998
					<sup>b</sup> 100 F (increased relative liver weight)		
			Bd Wt	417 F			

Table 3-2 Levels of Significant Exposure to Dibromochloromethane - Oral

(continued)

Key to Figure <sup>a</sup>	Species (Strain)	Exposure/ Duration/ Frequency (Route)	System	NOAEL (mg/kg/day)	LOAEL		Reference Chemical Form
					Less Serious (mg/kg/day)	Serious (mg/kg/day)	
33	Mouse (B6C3F1)	13 wk 5d/wk (GO)	Resp	250			NTP 1985
			Gastro	250			
			Hepatic	125 M	250 M (hepatocellular vacuolization)		
			Renal	125 M	250 M (toxic nephropathy)		
			Endocr	250			
			Dermal	250			
			Bd Wt	250			
<b>Immuno/ Lymphoret</b>							
34	Rat (Sprague- Dawley)	90 d (GO)		100	200 (34-40% decr. in thymus wt.)		Daniel et al. 1990
<b>Neurological</b>							
35	Rat (Sprague- Dawley)	90 d (GO)		50 F	100 F (decreased absolute brain weight)		Daniel et al. 1990
36	Mouse (ICR)	60 d 1x/d (GW)		100 M	400 M (decreased response rate in operant behavior test)		Balster and Borzelleca 1982
37	Mouse (ICR)	30d 1x/d (GW)		100 M			Balster and Borzelleca 1982 Chlorodibromomethane

Table 3-2 Levels of Significant Exposure to Dibromochloromethane - Oral

(continued)

Key to Figure <sup>a</sup>	Species (Strain)	Exposure/ Duration/ Frequency (Route)	System	NOAEL (mg/kg/day)	LOAEL		Reference Chemical Form
					Less Serious (mg/kg/day)	Serious (mg/kg/day)	
<b>Reproductive</b>							
38	Rat (Sprague- Dawley)	90 d (GO)		100			Daniel et al. 1990
39	Rat (Fischer- 344)	13 wk 5d/wk (GO)		250			NTP 1985
40	Rat (Sprague- Dawley)	15 d (W)		47.8 F			NTP 1996
41	Rat (Sprague- Dawley)	28-34 d (W)		28.2 M 46 F			NTP 1996
42	Mouse (ICR)	2 generations (continuous) (W)		170 F		685 F (decreased fertility)	Borzelleca and Carchman 1982
43	Mouse (B6C3F1)	13 wk 5d/wk (GO)		250			NTP 1985
<b>Developmental</b>							
44	Mouse (ICR)	2 generations (continuous) (W)		685			Borzelleca and Carchman 1982

Table 3-2 Levels of Significant Exposure to Dibromochloromethane - Oral

(continued)

Key to Figure <sup>a</sup>	Species (Strain)	Exposure/ Duration/ Frequency (Route)	System	NOAEL (mg/kg/day)	LOAEL		Reference Chemical Form
					Less Serious (mg/kg/day)	Serious (mg/kg/day)	
<b>CHRONIC EXPOSURE</b>							
<b>Death</b>							
45	Mouse (B6C3F1)	105 wk 5d/wk (GO)				100 M (decreased survival)	NTP 1985
<b>Systemic</b>							
46	Rat (Fischer- 344)	2 yr 5d/wk (GO)	Resp	80			NTP 1985
			Cardio	80			
			Gastro	80			
			Musc/skel	80			
			Hepatic		40 <sup>d</sup> (fatty change)		
			Endocr	80			
			Dermal	80			
			Bd Wt	80			
47	Rat (Wistar)	2 year (F)	Hepatic	20 M	85 M (yellowing of liver; hypertrophy)		Tobe et al 1982
			Bd Wt	20 M	85 M (10% decrease in body weight gain)	540 M (marked decrease in body weight gain)	

Table 3-2 Levels of Significant Exposure to Dibromochloromethane - Oral

(continued)

Key to Figure <sup>a</sup>	Species (Strain)	Exposure/ Duration/ Frequency (Route)	System	NOAEL (mg/kg/day)	LOAEL		Reference Chemical Form
					Less Serious (mg/kg/day)	Serious (mg/kg/day)	
48	Mouse (B6C3F1)	105 wk 5d/wk (GO)	Resp	100			NTP 1985
			Cardio	100			
			Gastro	100			
			Musc/skel	100			
			Hepatic		50 F (fatty metamorphosis)		
			Renal		100 M (nephrosis)		
			Endocr		50 F (thyroid follicular cell hyperplasia)		
			Dermal	100			
			Bd Wt	50	100 (14-17% decreased terminal body weight)		
<b>Reproductive</b>							
49	Rat (Fischer- 344)	2 yr 5d/wk (GO)		80			NTP 1985
50	Mouse (B6C3F1)	105 wk 5d/wk (GO)		100			NTP 1985

Table 3-2 Levels of Significant Exposure to Dibromochloromethane - Oral

(continued)

Key to Figure	Species (Strain)	Exposure/Duration/Frequency (Route)	System	NOAEL (mg/kg/day)	LOAEL		Reference Chemical Form
					Less Serious (mg/kg/day)	Serious (mg/kg/day)	
<b>Cancer</b>							
51	Mouse (B6C3F1)	105 wk 5d/wk (GO)				100	(CEL: hepatocellular adenoma or carcinoma) NTP 1985

a The number corresponds to entries in Figure 3-2.

b Differences in levels of health effects and cancer effects between male and females are not indicated in Figure 3-2. Where such differences exist, only the levels of effect for the most sensitive gender are presented.

c Used to derive an acute-duration oral MRL of 0.1 mg/kg/day; dose divided by an uncertainty factory of 300 (3 for use of a minimal LOAEL, 10 for extrapolation from animals to humans, and 10 for human variability).

d Used to derive a chronic-duration oral MRL of 0.09 mg/kg/day; dose adjusted for intermittent exposure and divided by an uncertainty factory of 300 (3 for use of a minimal LOAEL, 10 for extrapolation from animals to humans, and 10 for human variability).

Bd Wt = body weight; CNS = central nervous system; d = day(s); F = female; (F) = food; (G) = gavage; Gd = gestation day; Gastro = gastrointestinal; LD50 = lethal dose, 50% kill; LOAEL = lowest-observed-adverse-effect level; M = male; NOAEL = no-observed-adverse-effect level; (W) = water; wk = week(s); x = time(s)

Figure 3-2. Levels of Significant Exposure to Dibromochloromethane - Oral  
Acute ( $\leq 14$  days)

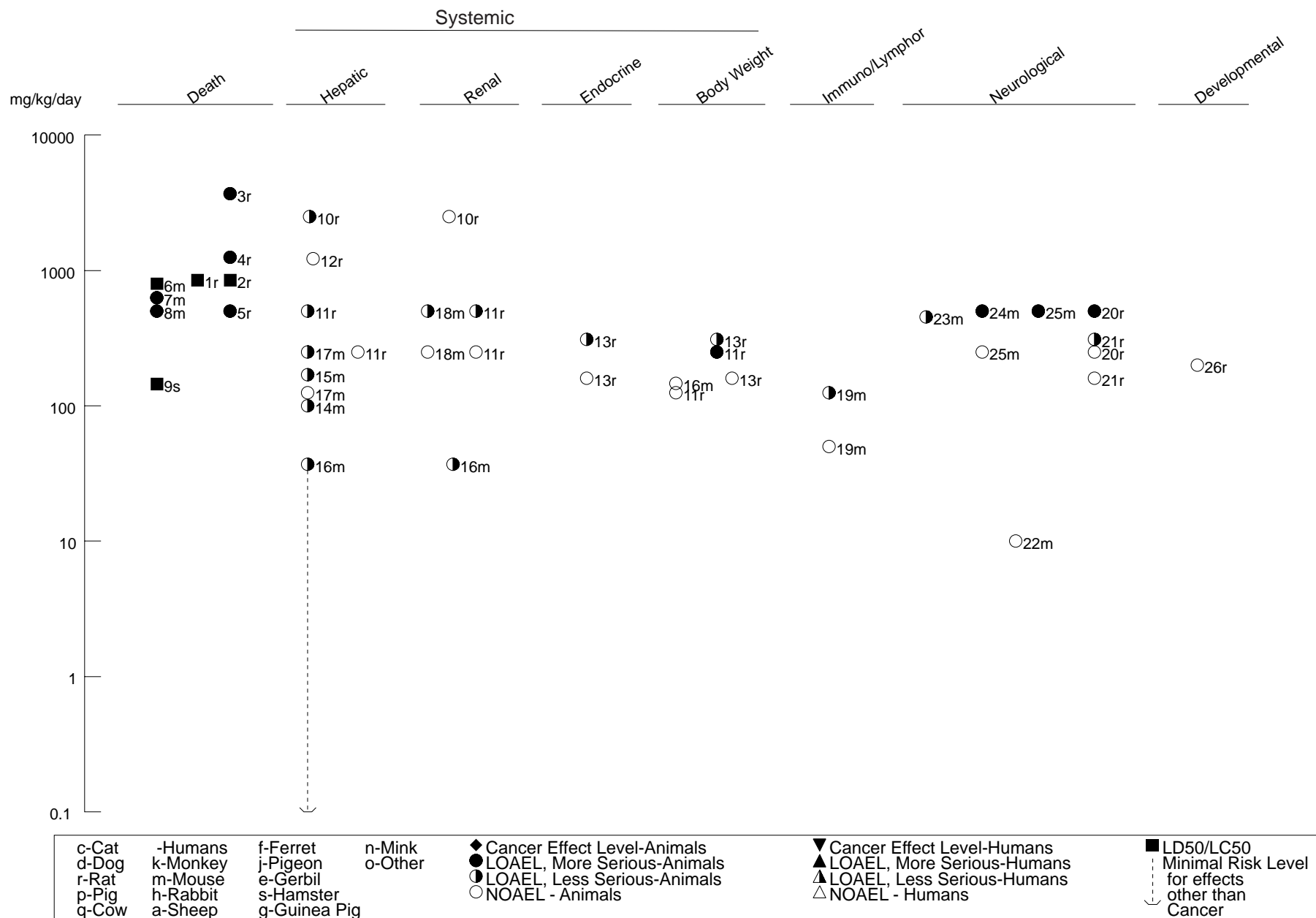

Figure 3-2. Levels of Significant Exposure to Dibromochloromethane - Oral (*Continued*)  
Intermediate (15-364 days)

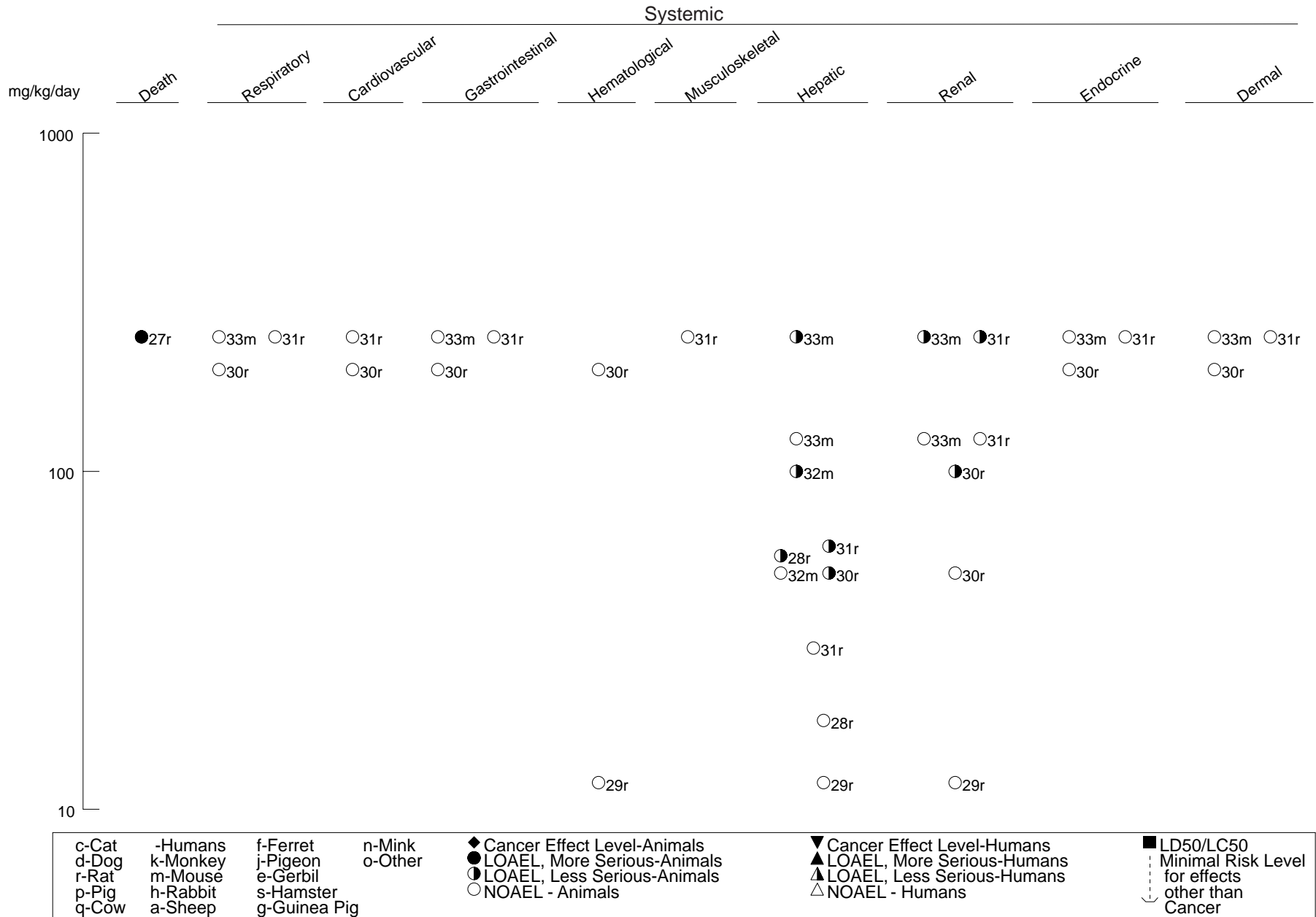



Figure 3-2. Levels of Significant Exposure to Dibromochloromethane - Oral (*Continued*)

Intermediate (15-364 days)

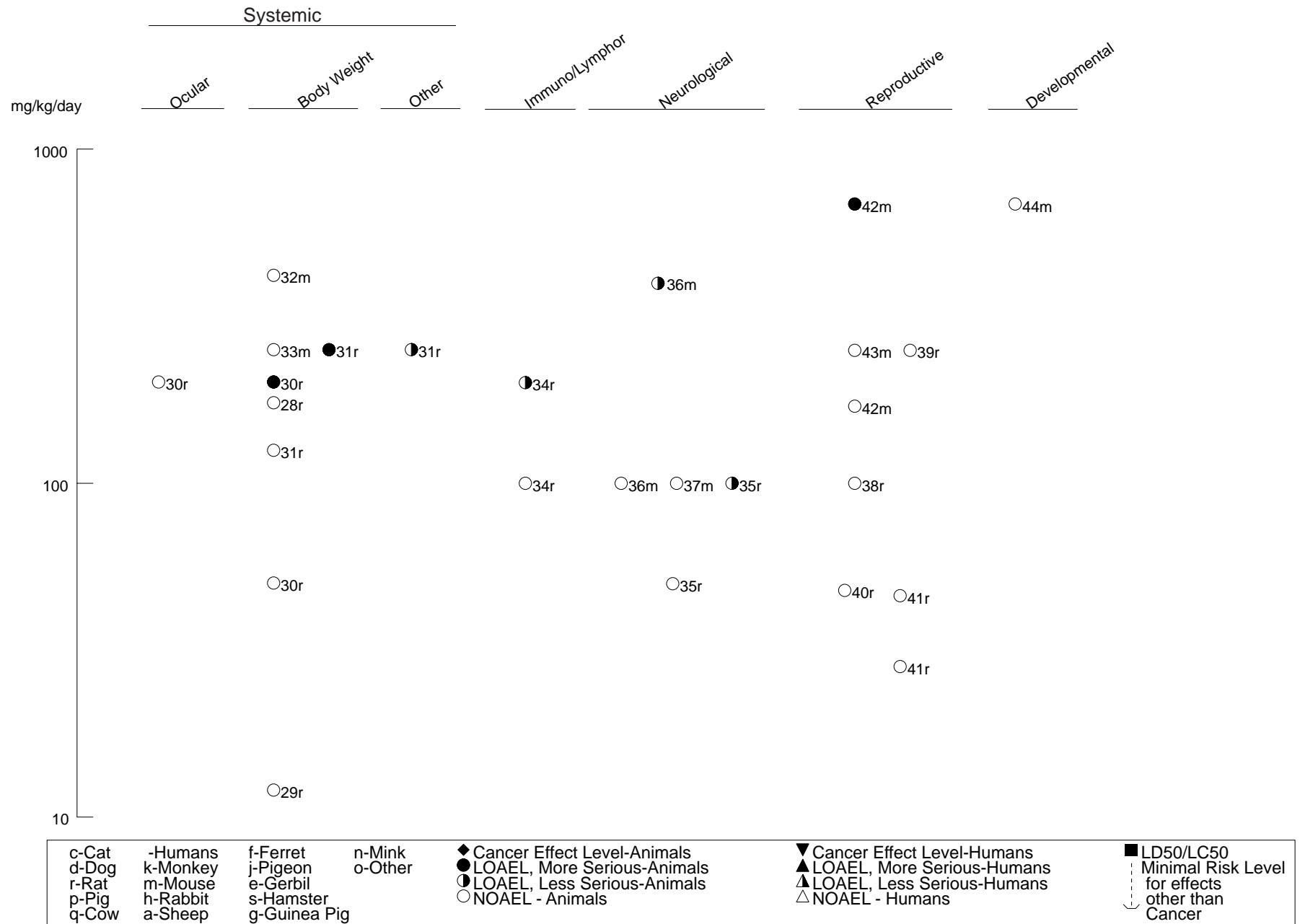
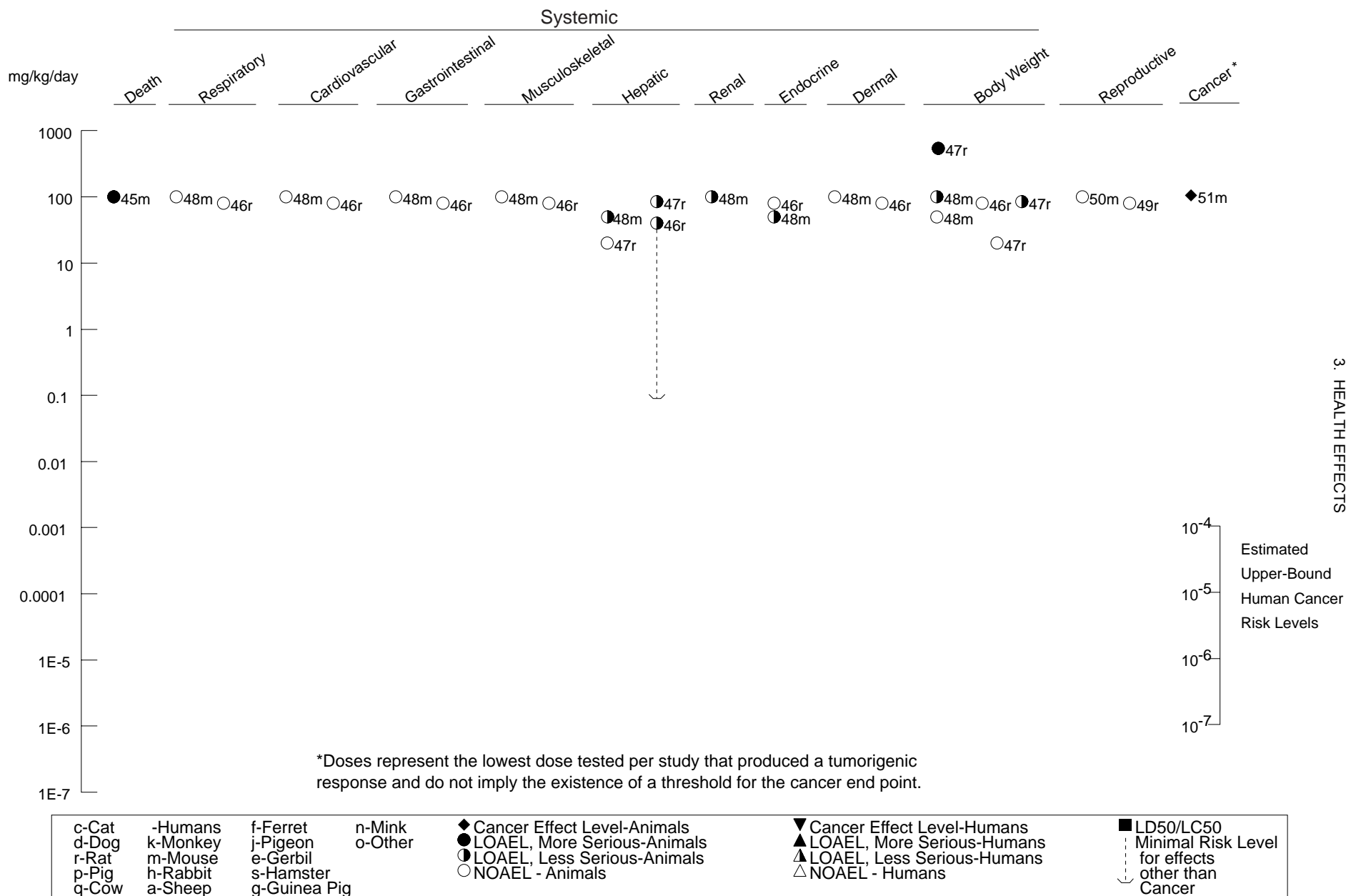

Figure 3-2. Levels of Significant Exposure to Dibromochloromethane - Oral (Continued)

Chronic (≥365 days)



## 3. HEALTH EFFECTS

Kobert 1906). The dose needed to cause death in children is not known with certainty, but both Dwelle (1903) and Roth (1904) estimated that a dose of about 5 g had been fatal. For a 10–20-kg child, this corresponds to an approximate dose of 250–300 mg/kg.

In animal studies, estimates of the acute oral LD<sub>50</sub> for bromoform typically range between 707 and 1,550 mg/kg (Bowman et al. 1978; Chu et al. 1982a; NTP 1989a). There does not appear to be much difference in the doses that cause death across species or between sexes. The LD<sub>50</sub> values for a 1-day exposure to bromoform ranged from 933 to 1,388 mg/kg in rats (Chu et al. 1980; NTP 1989a) and from 707 to 1,550 mg/kg in mice (Bowman et al. 1978; NTP 1989a). LD<sub>50</sub> values ranged from 1,072 to 1,550 for females and from 707 to 1,388 for males exposed to bromoform for 1 day (Bowman et al. 1978; Chu et al. 1980, 1982a; NTP 1989a). Acute, repeated oral exposure to 600 mg/kg/day resulted in 100% mortality in rats (NTP 1989a). However, only 2/10 mice died from exposure to 800 mg/kg/day (NTP 1989a). No deaths were observed in rats and mice administered 200 or 400 mg/kg (5 days/week) via gavage for 90 days (NTP 1989a). However, significant reductions in survival were observed in rats administered 200 mg/kg via gavage (5 days/week) for 2 years (NTP 1989a).

In animals, the cause of death following acute oral exposure to bromoform has not been thoroughly investigated. Prominent clinical signs include central nervous system depression (Bowman et al. 1978). While central nervous system depression is probably an important factor in rapid lethality, some studies report death occurring several days after an acute exposure (Bowman et al. 1978; NTP 1989a). This suggests that other effects (e.g., hepatic and/or renal injury) may also be important.

***Dibromochloromethane.*** No studies were located regarding death in humans after oral exposure to dibromochloromethane. The acute lethality of dibromochloromethane has been evaluated by several animal studies in rats and mice, with LD<sub>50</sub> estimates ranging between 800 and 2,650 mg/kg (Bowman et al. 1978; Chu et al. 1980, 1982a; Hewitt et al. 1983; NTP 1985). Korz and Gatterman (1997) reported an LD<sub>50</sub> of 145 mg/kg for a Golden Syrian hamster; however, the experimental details were not reported to validate the data. Deaths in animals have been reported from single oral doses as low 300–600 mg/kg (NTP 1985).

In intermediate and chronic oral exposure studies, significant increases in mortality have been observed in mice and rats at 250 mg/kg (5 days/week) for exposures of 14–90 days (Chu et al. 1982a; Condie et al. 1983; Daniel et al. 1990; NTP 1985) and in rats at 100 mg/kg (5 days/week) for exposures up to 2 years (NTP 1985).

### 3. HEALTH EFFECTS

Gender-related differences in mortality have been observed in rats and mice acutely exposed to dibromochloromethane. In rats, females appear to be more sensitive than males; increases in mortality were observed at 848 mg/kg in females compared to 1,186 mg/kg in males (Chu et al. 1982a). In contrast, increases in mortality were observed at lower doses in males (800 mg/kg) than females (1,200 mg/kg) (Bowman et al. 1978).

The cause of death following oral exposure of animals to dibromochloromethane has not been thoroughly investigated. Some of the chief clinical signs observed are those of central nervous system depression and other effects, such as hepatic and/or renal injury (Bowman et al. 1978; NTP 1985).

#### 3.2.2.2 Systemic Effects

**Respiratory Effects.** Labored breathing has been observed in animals exposed to lethal doses of bromoform and dibromochloromethane (NTP 1985, 1989a); this is likely due to central nervous system depression rather than impaired lung function.

**Bromoform.** No studies were located regarding respiratory effects in humans after oral exposure to bromoform. NTP (1989a) examined the respiratory tract of rats and mice receiving gavage doses of bromoform for 90 days or 2 years. No histological alterations were observed in the intermediate-duration studies or in female rats and male and female mice in the chronic-duration study. An increased incidence of chronic inflammation of the lungs was observed in male rats exposed to 100 or 200 mg/kg (5 days/week). This inflammation was similar in appearance to that caused by a sialodacryoadenitis (SDA) virus infection, and antibodies to rat SDA virus were detected in study animals. Thus, the inflammation observed was probably secondary to the infection and was not a direct result of bromoform. However, the absence of symptoms in control animals suggested that bromoform-treated rats may have been more susceptible to infection by the virus or slower to recover (NTP 1989a).

**Dibromochloromethane.** No studies were located regarding respiratory effects in humans after oral exposure to dibromochloromethane. No histological alterations in the respiratory tract were observed in rats and mice administered gavage doses of up to 250 mg/kg (days/week) for 90 days or 80–100 mg/kg (5 days/week) (NTP 1985).

## 3. HEALTH EFFECTS

**Cardiovascular Effects.**

**Bromoform.** No studies were located regarding cardiovascular effects in humans after oral exposure to bromoform. Histological examination of rats and mice exposed to up to 100–200 mg/kg (5 days/week) bromoform by gavage for up to 2 years revealed no evidence of adverse effects upon the heart (NTP 1989a). While this indicates that cardiac tissue is not directly injured by bromoform, indirect effects on cardiovascular functions might occur as a consequence of the central nervous system depressant activity of these compounds.

**Dibromochloromethane.** No studies were located regarding cardiovascular effects in humans after oral exposure to dibromochloromethane. Decreased heart rates and increased blood pressure were observed in male rats following the administration of a single gavage dose (83–667 mg/kg) of dibromochloromethane (Müller et al. 1997). However, a dose-related trend was not exhibited for these. While this suggests that cardiac function may be impaired by dibromochloromethane exposure, it is unclear if effects are caused by the direct action on cardiac function or if they are indirectly caused as a result of central nervous system depression. No histological alterations to cardiac tissue were observed in intermediate- and chronic-duration studies of dibromochloromethane administered to rats and mice via gavage (NTP 1985).

**Gastrointestinal Effects.**

**Bromoform.** No studies were located regarding gastrointestinal effects in humans after oral exposure to bromoform. NTP (1989a) examined the esophagus, stomach, and intestines of rats and mice orally exposed to bromoform. Stomach nodules were observed in male and female mice following 14 days of exposure to 400 and 600 mg/kg/day, respectively (NTP 1989a). The biological significance of these nodules is not certain, but it is likely that they are a response to a direct irritant effect of bromoform on the gastric mucosa. In chronic-duration studies, histological alterations were observed in male rats and male mice. Forestomach ulcers were observed in male rats at 200 mg/kg (5 days/week) (NTP 1989a) and hyperplasia of the glandular stomach was observed in male mice at 100 mg/kg (5 days/week) (NTP 1989a). No stomach lesions were observed in female rats or mice exposed to bromoform at doses up to 200 mg/kg. The histological observations in NTP (1989a) suggest that males may be more sensitive to gastrointestinal effects from acute and chronic bromoform exposures than females. In acute studies, the onset of stomach nodules occurred at a lower dose level in males (400 mg/kg) than in females (600 mg/kg). In chronic studies, gastrointestinal effects were only observed in males. While these

## 3. HEALTH EFFECTS

observations clearly indicate that the stomach may be affected by bromoform, it is possible that the exposure regimen (bolus administration) leads to irritant effects in the stomach that might not occur if exposure were continuous at lower concentrations in food or drinking water.

***Dibromochloromethane.*** No studies were located regarding gastrointestinal effects in humans after oral exposure to dibromochloromethane. No histological changes of the esophagus, stomach, or intestines were observed in mice or rats administered dibromochloromethane via gavage at doses up to 100 mg/kg (5 days/week) for up to 2 years (NTP 1985).

**Hematological Effects.** Several studies (Chu et al. 1982a, 1982b; Munson et al. 1982; Tobe et al. 1982) have investigated the hematological effects of oral exposure of rats and mice to bromoform and dibromochloromethane. With the exceptions of some minor fluctuations in lymphocyte count following exposure to bromoform (Chu et al. 1982a, 1982b), none of these studies detected any significant effects of bromoform or dibromochloromethane on hemoglobin, hematocrit, red blood cells, or white blood cells.

**Musculoskeletal Effects.** No studies regarding musculoskeletal effects in humans or animals after oral exposure to bromoform or dibromochloromethane.

**Hepatic Effects.** The liver is the primary target organ for bromoform and dibromochloromethane-induced toxicity. Oral exposure to these compounds results in an accumulation of fat in the liver, manifested as increased liver weight, appearance of hepatocyte vacuoles, alterations in serum cholesterol levels, and decreases in serum triglyceride levels. In addition to fatty liver changes, exposure to bromoform and dibromochloromethane results in focal hepatocellular necrosis. The necrosis is typically observed at higher doses than the fatty liver. The toxicity of both compounds is greater following gavage administration compared to exposure via the diet or drinking water. This is probably due to the large bolus dose overwhelming the liver's ability to detoxify reactive metabolites and the oil vehicle, which likely increases absorption.

***Bromoform.*** Several animal studies have examined the hepatotoxicity of bromoform in rats and mice following gavage, drinking water, or dietary exposure. The most sensitive hepatic end point appears to be fatty degeneration as indicated by centrilobular pallor observed in mice at 145 mg/kg/day for 14 days (Condie et al. 1983) and hepatocellular vacuolization and/or swelling, which has been observed following acute gavage exposure to 200 mg/kg (9 days in an 11-day period) (Coffin et al. 2000), acute drinking water exposure to 300 mg/kg/day (Coffin et al. 2000), intermediate-duration gavage exposure to 50 mg/kg

## 3. HEALTH EFFECTS

(5 days/week) (NTP 1989a), dietary exposure to 56.4 mg/kg/day (Aida et al. 1992), and chronic gavage exposure to 100 mg/kg (5 days/week) (NTP 1989a). Increases in relative and/or absolute liver weights, although not always consistently found, occur at similar doses (Munson et al. 1982; Tobe et al. 1982). Alterations in clinical chemistry parameters associated with the fatty changes (alterations in serum triglyceride and cholesterol levels) are typically observed at higher doses. Decreases in serum triglyceride levels were observed at 207.5 and 590 mg/kg/day in rats exposed via the diet for 1 or 24 months, respectively (Aida et al. 1992; Tobe et al. 1982); the no effect levels for this end point are 56.4 and 90 mg/kg/day, respectively. An increase in serum total cholesterol was observed in rats exposed to  $\geq 187.2$  mg/kg/day in the diet for 1 month (Aida et al. 1992) and a decrease was found in rats exposed to 590 mg/kg/day in the diet for 24 months (Tobe et al. 1982). The data are inadequate to assess whether the difference in the direction of change was related to exposure duration or was an inconsistent finding.

Higher doses of bromoform result in hepatocellular necrosis. Necrosis was observed in rats exposed to 200 mg/kg (5 days/week) for 2 years (NTP 1989a); focal inflammation has also been observed in mice receiving gavage doses of 280 mg/kg for 14 days (Condie et al. 1983). Significant increases in SGPT and/or SGOT, which is indicative of hepatocellular damage, were observed in mice at 250–289 mg/kg/day for 14 days (Condie et al. 1983; Munson et al. 1982), mice at 500 mg/kg (5 days/week) for 3 weeks (Melnick et al. 1998), and rats at 720 mg/kg/day for 24 months (Tobe et al. 1982). A decrease in serum glucose levels observed in rats exposed to  $\geq 61.9$  mg/kg/day for 1 month (Aida et al. 1992) or  $\geq 40$  mg/kg/day for 24 months (Tobe et al. 1982) and an increase in hexobarbital sleep time observed in mice at 125 mg/kg/day for 14 days (Munson et al. 1982) are also indicative of liver damage.

There are limited data to assess species differences. The results of the NTP intermediate-duration study (NTP 1989a) suggest that rats may be more sensitive to the hepatotoxicity of bromoform than mice. The NOAEL and LOAEL values for hepatocellular vacuolization were 25 and 50 mg/kg (5 days/week) in rats and 100 and 200 mg/kg in mice. Liver damage was the critical end point used for the derivation of acute-, intermediate-, and chronic-duration oral MRLs for bromoform, as described in the footnotes for Table 3-1 and in Appendix A.

***Dibromochloromethane.*** A variety of hepatic effects have been observed in rats and mice orally exposed to dibromochloromethane. Hepatocellular vacuolization and/or swelling were observed at the lowest adverse effect levels. The LOAEL values for this end point are  $\geq 37$  mg/kg in acutely exposed mice (Coffin et al. 2000; Condie et al. 1983),  $\geq 50$  mg/kg in rats and mice exposed for an intermediate duration (Aida et al. 1992; Daniel et al. 1990; NTP 1985), and  $\geq 40$  mg/kg in rats and mice following

## 3. HEALTH EFFECTS

chronic exposure (NTP 1985). Clinical chemistry alterations, which are associated with the fatty changes in the liver, include increases in serum cholesterol after a single gavage dose of 1,500 mg/kg (Chu et al. 1982a) or after a 1-month dietary exposure to 56.2 mg/kg/day (Aida et al. 1992), decreases in serum cholesterol at 540 mg/kg/day after a 24-month dietary exposure (Tobe et al. 1982), and decreases in serum triglycerides at 173.3 and 20 mg/kg/day following 1- or 24-month dietary exposures, respectively (Aida et al. 1992; Tobe et al. 1982). Additionally, increases in liver weight were observed in mice administered gavage doses of 250 mg/kg/day for 14 days (Munson et al. 1982) or 100 mg/kg (5 days/week) for 3 weeks (Melnick et al. 1998). The increased incidences of hepatocellular vacuoles observed at 37 mg/kg/day following acute exposure and 40 mg/kg following chronic exposure (NTP 1985) were used to derive acute- and chronic-duration oral MRLs for dibromochloromethane, as described in the footnotes to Table 3-2 and in Appendix A.

At higher doses, oral exposure to dibromochloromethane resulted in hepatocellular necrosis. Necrosis was found in rats and mice exposed to  $\geq 100$  mg/kg (Aida et al. 1992; Daniel et al. 1990; NTP 1985) for intermediate durations. Necrosis was not reported following acute-duration exposure; however, increases in SGOT and/or SGPT (indicative of hepatocellular damage) were found in rats and mice exposed to  $\geq 145$  mg/kg (Condie et al. 2000; Hewitt et al. 1983; Munson et al. 1982). Necrosis was not found following chronic exposure in rats and mice exposed to 80 or 100 mg/kg (5 days/week), respectively (NTP 1985). Other liver effects include bile duct hyperplasia in rats exposed to 250 mg/kg (5 days/week) for 13 weeks (NTP 1985), hepatocyte hydropic degeneration in mice exposed to 192 mg/kg (5 days/week) for 3 weeks (Melnick et al. 1998), and decreased serum glucose levels in rats exposed to 540 mg/kg/day for 24 months (Tobe et al. 1982).

**Renal Effects.**

***Bromoform.*** There is some evidence that oral exposure to bromoform can induce kidney damage. Condie et al. (1983) noted minimal to slight nephrosis and mesangial hypertrophy in male mice exposed to repeated oral doses of 145–289 mg/kg/day of bromoform. In contrast, no significant histopathological alterations were detected by NTP (1989a) in rats or mice receiving gavage of 200 mg/kg (5 days/week) of bromoform for 2 years.

***Dibromochloromethane.*** Histological studies performed by NTP (1985) indicate that oral exposure to dibromochloromethane can cause kidney injury in both rats and mice. The medullae appear to be reddened in both males and females after a single oral dose of 500 mg/kg, but this dose was so high that



## 3. HEALTH EFFECTS

7 of 10 animals died. Of greater toxicological concern were effects on the nephron that develop after intermediate or chronic exposure to doses of 50–250 mg/kg/day (NTP 1985). These effects were usually much more apparent in males than females, and were characterized by tubular degeneration and mineralization leading to nephrosis (NTP 1985). These histological findings of nephrotoxicity are supported by the kidney function studies of Condie et al. (1983), which found that ingestion of dibromochloromethane tended to impair uptake of para-amino hippuric acid in renal slices prepared from male mice exposed to 37–147 mg/kg/day for 2 weeks.

**Endocrine Effects.**

***Bromoform.*** Several endocrine effects have been observed in animals exposed to bromoform; however, none of the effects were consistently found. The observed endocrine effects included enlarged thyroid gland in rats administered a lethal dose of 800 mg/kg/day for 14 days (NTP 1989a), decreased thyroid follicular size and colloid density 90 days after termination of exposure to 360 mg/kg/day (Chu et al. 1982b), thyroid follicular cell hyperplasia in mice administered 200 mg/kg (5 days/week) for 2 years (NTP 1989a), pituitary gland hyperplasia in rats administered 100 mg/kg (5 days/week), but not 200 mg/kg (NTP 1989a), and decreased serum testosterone levels in rats exposed to 380 mg/kg/day for 7 days (Potter et al. 1996).

***Dibromochloromethane.*** Several studies have examined the potential of dibromochloromethane to induce histological alterations in endocrine glands following longer-term exposure. No alterations in endocrine glands were observed following intermediate-duration exposure of rats to 200 or 256 mg/kg/day (Chu et al. 1982b; Daniel et al. 1990) or rats or mice to 250 mg/kg for 5 days/week (NTP 1985). Administration of dibromochloromethane via gavage for 2 years resulted in thyroid follicular cell hyperplasia in mice exposed to 50 or 100 mg/kg (5 days/week). No effects were observed in rats administered 40 or 80 mg/kg (5 days/week) (NTP 1985). No effects on serum testosterone levels were observed in rats given gavage doses of 160 mg/kg/day for 7 days. However, a decrease in levels resulted from doses of 310 mg/kg/day (Potter et al. 1996).

**Dermal Effects.** No histological alterations were found in the skin of rats and mice exposed to bromoform or dibromochloromethane by gavage for up to 2 years (NTP 1985, 1989a).

**Ocular Effects.** No histological alterations were found in the eyes of rats and mice exposed to bromoform or dibromochloromethane by gavage for up to 2 years (NTP 1985, 1989a).

## 3. HEALTH EFFECTS

**Body Weight Effects.**

***Bromoform.*** In animals, treatment with bromoform is associated with significant decrements in body weight, without concurrent reductions in food intake. The threshold for body weight effects appears to be duration-related, as generally observed in the oral exposure studies. In acute repeated-dose oral gavage studies (Condie et al. 1983; Munson et al. 1982, NTP 1989a), 4 and 14% decreases in body weight were observed in female and male rats, respectively, given 400 mg/kg. No significant, consistently-observed effects on body weight were seen in mice administered up to 800 mg/kg. Intermediate-duration studies of bromoform appear to present a similar dose-response relationship for body weight effects as the acute studies. Body weights of rats were unaffected by bromoform doses of  $\leq 200$  mg/kg administered by gavage, in feed, or in drinking water (Aida et al. 1992; Chu et al. 1982a; NTP 1989a). Body weights of mice treated with 400 mg/kg of bromoform by gavage were slightly (8%) reduced (NTP 1989a). Lower adverse effect levels were observed in chronic studies. Body weights were decreased by 4–10% in rats and female mice treated with 100 mg/kg of bromoform by gavage, whereas 16–25% decreases in body weight gain were noted at 200 mg/kg (NTP 1989a). A chronic feeding study in rats (Tobe et al. 1982) showed a dose-response similar to the gavage studies. Body weight reductions of 15% were observed at 90–150 mg/kg, while reductions of 30–40% were observed at doses above 365 mg/kg.

***Dibromochloromethane.*** Treatment with dibromochloromethane is also associated with decreased body weight gain in animals. Rats appear to be more sensitive than mice to body weight effects. The dose-response relationship seemed to be sensitive to exposure duration, but was similar for various administration routes (gavage, feed, drinking water). The greater sensitivity of rats to dibromochloromethane compared with mice was apparent in both acute and intermediate duration exposures (Chu et al. 1980; Condie et al. 1983; Daniel et al. 1990; Munson et al. 1982; NTP 1985). Rats experienced 20% (400 mg/kg/day) and 47% (250 mg/kg/day) decreases in body weight gain from acute and intermediate gavage exposures, respectively. In contrast, no effect was seen in mice for these dose levels and durations. Duration-related changes to the dose-response were indicated in both species for body weight gain decreases of 10% or more. These effects on body weight gain occurred in the range of 250–500 mg/kg (acute), 200–250 mg/kg (intermediate), and 70–200 mg/kg (chronic) (Aida et al. 1992; Daniel et al. 1990; NTP 1985; Tobe et al. 1982). In chronic exposure studies (NTP 1985; Tobe et al. 1982), neither species nor administration route seemed to affect the dose response.

## 3. HEALTH EFFECTS

**3.2.2.3 Immunological and Lymphoreticular Effects**

There are limited data on the immune and lymphoreticular system toxicity of bromoform and dibromochloromethane. Munson et al. (1982) examined immune function following exposure to both compounds. Other studies (Daniel et al. 1990; NTP 1985, 1989a) monitored organ weights or examined tissues for histological damage.

**Bromoform.** Impaired humoral immune function, as indicated by the response to sheep red blood cells, was observed in rats and mice exposed to 125 or 250 mg/kg/day bromoform for 14 days (Munson et al. 1982), though no adverse effect on cell-mediated immunity was noted. Additionally, male rats exposed to bromoform for 2 years appeared to have decreased resistance to a common viral infection (NTP 1989a), suggesting functional impairment of the immune system. No histological alterations were observed in tissues of the immune or lymphoreticular systems in rats and mice exposed to 200 and 400 mg/kg (5 days/week), respectively, for 90 days (NTP 1985) or 100–200 or 200 mg/kg (5 days/week), respectively, for 2 years (NTP 1985).

**Dibromochloromethane.** Exposure of mice to doses of 125 or 250 mg/kg/day of dibromochloromethane for 14 days resulted in impaired humoral immunity (splenic IgM response to sheep red blood cells) (Munson et al. 1982). Impaired cellular immunity (popliteal lymph node response to sheep red blood cells) was also observed at 250 mg/kg/day. A significant decrease in thymus weight was observed in rats exposed to 300 mg/kg/day for 90 days (Daniel et al. 1990). No histological alterations were observed in immune or lymphoreticular tissues of rats and mice following intermediate or chronic duration to 250 or 80–100 mg/kg (days/week), respectively (NTP 1985).

**3.2.2.4 Neurological Effects**

**Bromoform.** Bromoform, like other volatile halogenated hydrocarbons, can lead to marked central nervous system depression. Because of this property, bromoform was used as a sedative in the early 1900s and was commonly administered to children for relief from whooping cough. Several poisonings and a few deaths resulted from accidental overdoses or separation of the emulsion (Benson 1907; Burton-Fanning 1901; Dwelle 1903; Stokes 1900; von Oettingen 1955). In mild cases of accidental overdose, clinical signs included rapid breathing, constricted pupils, and tremors; more severe cases were accompanied by a drunken-like stupor, cyanosis, shallow breathing, and erratic heart rate (Benson 1907; Kobert 1906). Actual doses associated with these neurological symptoms are not known with certainty.

## 3. HEALTH EFFECTS

Based on experiences with seven cases of accidental bromoform poisonings in children with whooping cough, Burton-Fanning (1901) advised initial treatment volumes of 0.03 mL for children under 1 year, 0.06 mL for those 1–4 years old, and 0.13 mL for children 4–8 years of age, or approximately 25–60 mg/kg. Dwelle (1903) reported the case of a 33-month-old girl who was prescribed bromoform for relief of whooping cough-induced coughing and vomiting. It is estimated that the girl ingested approximately 700 mg bromoform (60 mg/kg/day) and slept undisturbed that night, suggesting the occurrence of sedative effects.

As with humans, high doses of bromoform result in central nervous system depression in animals. Impaired performance on neurobehavioral tests is observed at lower doses,. The severity of the central nervous system depression is dose-related, with anesthesia and shallow breathing occurring at very high, often lethal, doses and ataxia, lethargy, and sedation at lower doses. In rats, lethargy, shallow breathing, and ataxia were observed at 600 and 1,000 mg/kg/day (NTP 1989a) following acute exposure. Lethargy was also observed at 100 mg/kg (5 days/week) during a 13-week or 2-year exposure (NTP 1989a). In mice, anesthesia, ataxia, and sedation were observed following a single dose of 1,000 mg/kg (Bowman et al. 1978) and lethargy and ataxia were observed following doses of 600 mg/kg/day for 14 days (NTP 1989a). No overt signs of neurotoxicity were observed at 100 or 400 mg/kg following gavage administration, 5 days/week, for 13 weeks or 2 years (NTP 1989a).

A series of experiments conducted by Balster and Borzelleca (1982) assessed neurobehavioral performance in mice following acute- or intermediate-duration exposures. The ED<sub>50</sub> for impaired motor performance was 431 mg/kg following a single dose. A decrease in exploratory behavior was observed following 9.2 mg/kg/day for 90 days and a decrease in response rate in an operant behavior test following doses of 100 mg/kg/day for 60 days. No effect on swimming endurance was observed (9.7 mg/kg/day for 14 days) or on passive-avoidance learning (100 mg/kg/day for 30 days).

***Dibromochloromethane.*** No human data on the neurotoxicity of dibromochloromethane were located. In animals, central nervous system depression occurs at relatively high doses, as evidenced by lethargy, ataxia, and sedation. An acute exposure to 500 mg/kg/day resulted in lethargy, ataxia, sedation, and shallow breathing in rats and mice (Bowman et al. 1978; NTP 1985). Lethargy was also observed in rats receiving a single gavage dose of 310 mg/kg (NTP 1985). No overt signs of neurotoxicity were observed following intermediate-duration exposure to 250 mg/kg (5 days/week) or chronic exposure to 80–100 mg/kg (5 days/week) (NTP 1985). Daniel et al. (1990) found a significant decrease in brain weights in rats exposed to 100 or 200 mg/kg/day for 90 days. However, no alterations in brain weight or

## 3. HEALTH EFFECTS

histopathology were observed at doses as high as 250 mg/kg (5 days/week) for 13 weeks (NTP 1985) or 80 mg/kg (5 days/week) for 2 years (NTP 1985).

Some alterations in neurobehavioral performance were observed in mice (Balster and Borzelleca 1982). An ED<sub>50</sub> of 454 mg/kg was calculated for impaired motor performance following a single dose exposure and a decrease in response rate in operant behavior test during a 60-day exposure to 400 mg/kg/day. No alterations were observed in swimming endurance (10 mg/kg/day for 14 days), exploratory behavior (10 mg/kg/day for 90 days), or passive avoidance learning tests (100 mg/kg/day for 30 days).

### 3.2.2.5 Reproductive Effects

The reproductive toxicity of bromoform and dibromochloromethane has been assessed in a small number of human and animal studies. A number of studies have examined the potential association between adverse reproductive outcomes (spontaneous abortions, stillbirths, and preterm delivery) and consumption of municipal drinking water containing trihalomethanes (bromoform, dibromochloromethane, dichloromethane, and chloroform) (Bove et al. 1992, 1995, 2002; Dodds et al. 1999; Kramer et al. 1992; Mills et al. 1998; Nieuwenhuijsen et al. 2000; Savitz et al. 1995; Waller et al. 1999). These studies involved mixed exposures to trihalomethane compounds and most did not provide bromoform or dibromochloromethane exposure data. Two pregnancy outcome studies (Kramer et al. 1992; Waller et al. 1999) have examined risks associated with levels of bromoform or dibromochloromethane in drinking water. A third study (Windham et al. 2003) examined the association of altered menstrual cycle function in women exposed to trihalomethanes in drinking water. Collectively, the studies provide insufficient evidence for establishing a causal relationship between exposure to trihalomethane compounds and adverse reproductive outcome.

The Kramer et al. (1992) study is a population case-control study of pregnant white, non-Hispanic women living in communities in Iowa where all drinking water was supplied from a single source. No significant associations were found between bromoform or dibromochloromethane levels in the drinking water and the risk of prematurity. The odds ratios were 1.1 (95% confidence limit of 0.8–1.4) for communities with bromoform levels of 1 µg/L and higher and 1.1 (95% confidence limit of 0.7–1.4) for communities with dibromochloromethane levels of 1–3 µg/L. No cases were found in communities with dibromochloromethane levels of 4 µg/L and higher. Similar results were found in the Waller et al. (1999) study. In this study, pregnancy health outcomes were examined in pregnant women living in communities with groundwater, surface water, or mixed sources of drinking water. The risk of spontaneous abortion was

## 3. HEALTH EFFECTS

not significantly associated with bromoform or dibromochloromethane water levels; the percentage of pregnancies ending with spontaneous abortions were 9.2, 9.8, and 10.3% in communities with bromoform drinking water levels of 0, 1–15, and  $\geq 16$   $\mu\text{g/L}$ , respectively, and 9.7, 9.6, and 10.4% for dibromochloromethane levels of 0, 1–30, and  $\geq 31$   $\mu\text{g/L}$ , respectively.

Windham et al. (2003) examined the possible association between trihalomethanes in drinking water and menstrual cycle function. Menstrual parameter values in premenopausal women were determined based on hormone levels in urine collected during an average of 5.6 menstrual cycles ( $n=403$ ). Estimates of bromoform and dibromochloromethane levels for each cycle were based on residential data (individual trihalomethane concentrations measured within a relatively narrow time period around the menstrual cycle start date) and utility measurements (quarterly measurements made by water utilities during a 90-day period beginning 60 days before the cycle start date). Significant associations were found between exposure to the top quartile of bromoform ( $\geq 12$   $\mu\text{g/L}$ ) and decreasing menstrual cycle and follicular phase length. The age, race, body mass index, income, pregnancy history, and caffeine and alcohol consumption-adjusted differences were -0.79 days (95% confidence interval [CI] of -1.4 to -0.14) for cycle length and -0.78 days (95% CI -1.4 to -0.14) for follicular phase length. For dibromochloromethane, the differences for the 2–3 quartile (level not reported) and highest quartile ( $\geq 20$   $\mu\text{g/L}$ ) were -0.69 days (95% CI of -1.4 to -0.02) and -1.21 days (95% CI of -2.0 to -0.38), respectively, for menstrual cycle length and -0.62 days (95% CI of -1.3 to 0.05) and -1.1 days (95% CI of -1.9 to -0.25), respectively, for follicular phase length. No associations between bromoform or dibromochloromethane concentration and luteal phase length, menses length, or cycle variability were found. Interpretation of the study results is limited due to coexposure to other trihalomethanes.

**Bromoform.** Data on the reproductive toxicity of bromoform in humans are limited to the trihalomethane studies described above. Animal studies have examined the potential of bromoform to induce histological alterations (NTP 1989a) and impair reproductive function (NTP 1989b). No histological alterations were observed in rats and mice exposed to 200 or 400 mg/kg, respectively, 5 days/week for 13 weeks (NTP 1989a). Dose related incidences of squamous metaplasia of the prostate gland were observed in male rats exposed to 200 mg/kg (5 days/week) for 2 years (NTP 1989a). This lesion may represent a chemical effect associated with concurrent inflammatory lesions in this gland, which occurred at similar rates in all groups of male rats tested, including vehicle controls. Chronic exposure of mice to 200 mg/kg (5 days/week) resulted in no detectable noncancerous histological effects in male reproductive tissues (testes, prostate, and seminal vesicles) (NTP 1989a). No nonneoplastic histological alterations were observed in female rats or mice receiving gavage doses of 200 mg/kg (5 days/week) for 2 years (NTP

## 3. HEALTH EFFECTS

1989a). No adverse effects on reproductive performance or fertility were observed in male and female mice receiving gavage doses of 200 mg/kg/day (NTP 1989b).

***Dibromochloromethane.*** Human data on the reproductive toxicity of dibromochloromethane are limited to the trihalomethane studies described above. No histological alterations (testes, prostate, seminal vesicles, ovaries, uterus, and mammary gland examined) were observed in rats or mice receiving gavage doses of up to 250 mg/kg 5 days/week for 13 weeks (Daniel et al. 1990; NTP 1985) or 80 or 100 mg/kg, respectively, 5 days/week for 2 years (NTP 1985). In contrast to these negative findings, female mice exposed to dibromochloromethane in drinking water at a high dose (685 mg/kg/day) experienced a marked reduction in fertility, with significant decreases in litter size, gestational survival, postnatal survival, and postnatal body weight (Borzelleca and Carchman 1982). These effects may have been due to marked maternal toxicity, as evidenced by decreased weight gain, enlarged and discolored livers, and decreased survival. Exposure to lower doses (17 or 170 mg/kg/day) resulted in occasional decreases in one or more of the reproductive parameters monitored, but the effects were not large and were not clearly dose-related. These data are not sufficient to draw firm conclusions about the effects of dibromochloromethane on reproduction, but it appears that reproductive tissues and functions are not markedly impaired at doses that do not cause frank maternal toxicity. This is supported by a reproductive toxicity study conducted by NTP (1996). No alterations in reproductive or fertility indices were observed in female rats exposed to 40.3 mg/kg/day dibromochloromethane in drinking water for 35 days (13 days prior to mating, during mating, and gestation).

### 3.2.2.6 Developmental Effects

There are limited data on the developmental toxicity of bromoform or dibromochloromethane in humans and animals. Several human studies have examined the potential association between exposure to trihalomethanes in drinking water and birth outcomes (Dodds et al. 1999; Kramer et al. 1992; Savitz et al. 1995). However, only one study (Kramer et al. 1992) examined the exposure to individual trihalomethanes. In this population-based case control of pregnant white, non-Hispanic women living in communities in Iowa where all drinking water was supplied from a single source, no significant association between exposure to  $\geq 1$   $\mu\text{g/L}$  of bromoform or  $\geq 4$   $\mu\text{g/L}$  of dibromochloromethane in tap water and increased risk of low birth weight babies and intrauterine growth retardation were found. Interpretation of this study is limited by the co-exposure to other trihalomethane compounds.

## 3. HEALTH EFFECTS

**Bromoform.** Human data on the developmental toxicity of bromoform are limited to the trihalomethane studies discussed above. One animal study (Ruddick et al. 1983) was identified. No significant alterations in the number of resorption sites, fetuses per litter, fetal body weights, fetal malformations, or visceral anomalies were observed in the offspring of rats administered up to 200 mg/kg/day bromoform in corn oil on gestational days 6–15. Increases in several skeletal anomalies were found in the offspring of rats exposed to bromoform, including the presence of a 14<sup>th</sup> rib, wavy ribs, interparietal deviations, and sternebra aberrations. The study authors did not conduct a statistical analysis of the data. However, an independent analysis of the data using Fisher Exact test revealed a significant increase in the incidence (per fetus and number of affected litters) in sternebra aberrations.

**Dibromochloromethane.** Human data on the developmental toxicity of dibromochloromethane are limited to the trihalomethane studies discussed above. Two animal studies examined the potential of dibromochloromethane to induce developmental effects. In a study by Ruddick et al. (1983) of rats receiving gavage doses of up to 200 mg/kg/day on gestational days 6–15, no alterations in the number of resorption sites, fetuses per litter, fetal body weights, fetal gross malformations, or skeletal or visceral anomalies were found. Borzelleca and Carchman (1982) exposed mice to 685 mg/kg/day of dibromochloromethane in drinking water for several generations and detected no significant effect on the incidence of gross, skeletal, or soft-tissue anomalies.

### 3.2.2.7 Cancer

No studies were located regarding carcinogenic effects in humans following oral exposure to bromoform or dibromochloromethane. There are a number of epidemiological studies that indicate that there may be an association between chronic ingestion of chlorinated drinking water (which typically contains trihalomethanes including bromoform and dibromochloromethane) and increased risk of rectal, bladder, or colon cancer in humans (Cantor et al. 1987; Crump 1983; Kanarek and Young 1982; Marienfeld et al. 1986), but these studies cannot provide information on whether any effects observed are due to bromoform, dibromochloromethane, or to one or more of the hundreds of other byproducts that are also present in chlorinated water.

**Bromoform.** A significant increase in the incidence of adenomatous polyps or adenocarcinomas was observed in female rats receiving gavage dose of 200 mg/kg, 5 days/week for 2 years (NTP 1989a); a nonstatistically significant increase was observed in male rats. The incidences of this relatively rare tumor (combined incidences of adenomatous polyps and adenocarcinoma) were 0/50, 0/50, and 3/50 for



## 3. HEALTH EFFECTS

males administered 0, 100, or 200 mg/kg and 0/50, 1/50, and 8/50 for females. No significant alterations in neoplastic lesions were observed in mice administered up to 100 (males) or 200 (females) mg/kg, 5 days/week for 2 years (NTP 1989a). The International Agency for Research on Cancer (IARC) concluded that there were inadequate human data and limited animal data and assigned bromoform to weight of evidence category 3, not classifiable as to carcinogenicity in humans (IARC 1991a, 1999a) and EPA classified bromoform as a probable human carcinogen, group B2 (IRIS 2004a). Based on the increased occurrence of neoplastic lesions in the large intestines of female rats, EPA derived an oral slope factor of  $7.9 \times 10^{-3} \text{ (mg/kg/day)}^{-1}$  (IRIS 2004a).

***Dibromochloromethane.*** In mice administered gavage doses of 100 mg/kg, 5 days/week for 2 years, increases in the incidences of hepatocellular adenomas and carcinomas were observed (NTP 1985). The incidence was significantly elevated for hepatocellular adenomas in females (2/50, 4/49, and 11/50 for 0, 50, and 100 mg/kg), hepatocellular carcinoma in males (10/50 and 19/50 for 0 and 100 mg/kg) and combined incidences for hepatocellular adenoma or carcinoma (23/50 and 27/50 for males at 0 and 100 mg/kg and 6/50, 10/49, and 19/50 for females at 0, 50, and 100 mg/kg). No significant alterations in the incidence of neoplastic lesion were observed in male or female rats administered up to 80 mg/kg 5 days/week for 2 years (NTP 1985). The IARC considered the available data on dibromochloromethane carcinogenicity to be not classifiable as to carcinogenicity in humans (group 3) (IARC 1991b, 1999b). EPA classified dibromochloromethane as a possible human carcinogen, group C (IRIS 2004b). Based on the increased combined incidence of hepatocellular adenoma or carcinoma in female mice, EPA derived an oral slope factor of  $8.4 \times 10^{-2} \text{ (mg/kg/day)}^{-1}$  (IRIS 2004b).

### 3.2.3 Dermal Exposure

No studies were located regarding the following health effects in humans or animals after dermal exposure to bromoform or dibromochloromethane:

#### 3.2.3.1 Death

#### 3.2.3.2 Systemic Effects

#### 3.2.3.3 Immunological and Lymphoreticular Effects

#### 3.2.3.4 Neurological Effects

## 3. HEALTH EFFECTS

**3.2.3.5 Reproductive Effects****3.2.3.6 Developmental Effects****3.2.3.7 Cancer****3.3 GENOTOXICITY**

**Bromoform.** The *in vivo* and *in vitro* genotoxicities of bromoform are examined in numerous studies, the results of which are summarized in Tables 3-3 and 3-4, respectively.

The potential of bromoform to induce gene mutations have reported have shown mixed results in *in vitro* assays. Increases (LeCurieux et al. 1995; Simmon and Tardiff 1978; Simmon et al. 1977) and no effect (Kubo et al. 2002; NTP 1989a; Rapson et al. 1980; Varma et al. 1988) on the occurrence of reverse mutations have been found in *Salmonella typhimurium*; an increase in forward mutations was also found in *S. typhimurium* (Roldan-Arjona and Pueyo 1993). The clastogenic activity of bromoform has been tested in one study (Galloway et al. 1985; NTP 1989a) that found no significant alterations with S9 metabolic activation and negative and weakly positive results without metabolic alteration. A significant alteration in mitotic aneuploidy was observed in *Aspergillus nidulans* (Benigni et al. 1993). Other tests of genotoxicity included an increase in sister chromatid exchange in human lymphocytes (Morimoto and Koizumi 1983) and rat erythroblastic leukemia K<sub>3</sub>D cells (Fujie et al. 1993), but not in Chinese hamster ovary cells (Galloway et al. 1985; NTP 1989a) or oyster toadfish leukocytes (Maddock and Kelly 1980); SOS induction in *Escherichia coli* (Lecurieux et al. 1995); trifluorotymidine resistance in mouse lymphoma cells (NTP 1989a). DNA strand breaks were observed in human lymphocytes (Landi et al. 1999) and lymphoblastic leukemia cells, but not in primary rat hepatocytes (Geter et al. 2003a).

The potential for bromoform to induce chromosome aberrations, micronuclei, sister chromatid exchange, and DNA damage was investigated in several *in vivo* studies, often with conflicting results. An increase in chromosome aberrations, in particular chromatid and chromosome breaks, was observed in rats receiving five daily gavage doses of 253 mg/kg/day or a single intraperitoneal dose of 25.3 or 253 mg/kg (Fujie et al. 1990), but not in mice administered up to 800 mg/kg via intraperitoneal injection (NTP 1989a). A significant increase in sister chromatid exchange was observed in the bone marrow cells of mice receiving 25 mg/kg/day gavage doses for 4 days (Morimoto and Koizumi 1983) and mice receiving

## 3. HEALTH EFFECTS

**Table 3-3. Genotoxicity of Bromoform *In Vivo***

End point	Species (test system)	Exposure route	Results	Reference
Nonmammalian systems:				
Sex-linked recessive lethal	<i>Drosophila melanogaster</i>	Feeding	+	Woodruff et al. 1985; NTP 1989a
		Injection	-	
Reciprocal translocation	<i>D. melanogaster</i>	Feeding	-	Woodruff et al. 1985; NTP 1989a
Micronuclei	<i>Pleurodeleswalti larvae</i>		+	LeCurieux et al. 1995
Mammalian systems:				
Sister chromatid exchange	Mouse (bone marrow cell)	IP	+	NTP 1989a
	Mouse (bone marrow cell)	oral	+	Morimoto and Koizumi 1983
Chromosomal aberrations	Mouse (bone marrow cell)	IP	-	NTP 1989a
	Rat (bone marrow cell)	IP	+	Fujie et al. 1990
	Rat (bone marrow cell)	Oral	+	Fujie et al. 1990
Micronuclei	Mouse (bone marrow cell)	IP	+	NTP 1989a
	Mouse (bone marrow cell)	Oral	-	Stocker et al. 1996
	Mouse (bone marrow cell)	IP	-	Hayashi et al. 1988
Repairable DNA damage	Rat (liver cells)	Oral	-	Stocker et al. 1996
DNA strand breaks	Rat (kidney cells)	Oral	-	Potter et al. 1996
	Rat (liver, kidney, duodenum)	Oral	-	Geter et al. 2003a

+ = positive result; - = negative result; IP = intraperitoneal

## 3. HEALTH EFFECTS

**Table 3-4. Genotoxicity of Bromoform *In Vitro***

End point	Species (test system)	Results <sup>a</sup>		Reference
		With activation	Without activation	
Prokaryotic organisms:				
Reverse gene mutation	<i>Salmonella typhimurium</i>			Simmon and Tardiff 1978; Simmon et al. 1977
	TA100	No data	+	
	TA1535	No data	+	
	<i>S. typhimurium</i>			LeCurieux et al. 1995
	TA100	–	+	
	<i>S. typhimurium</i>	–	–	Kubo et al. 2002
	TA100			
	TA98	–	–	
	<i>S. typhimurium</i>			Varma et al. 1988
	TA98	–	–	
	TA100	–	(+)	
	TA1535	–	–	
	TA1537	–	–	
	<i>S. typhimurium</i>			Rapson et al. 1980
	TA100	No data	–	
	<i>S. typhimurium</i> (preincubation assay)			
	TA97	(+)	–	NTP 1989a
	TA98	–, –, (+)	–, –, –	
	TA100	–, –, –	(+), –, –	
	TA1535	–, –, –	–, –, –	
	TA1537	–, –, –	–, –, –	
Forward gene mutation	<i>S. typhimurium</i>	No data	(+)	Roldan-Arjona and Pueyo 1993
SOS induction	<i>Escherichia coli</i>	+	+	LeCurieux et al. 1995
Eukaryotic organisms:				
Fungi:				
Mitotic aneuploidy	<i>Aspergillus nidulans</i>	No data	+	Benigni et al. 1993
Fish:				
Sister-chromatid exchange	Oyster toadfish leukocytes	No data	–	Maddock and Kelly 1980
Mammalian cells:				
Sister-chromatid exchange	Human lymphocytes	No data	+	Morimoto and Koizumi 1983
	Chinese hamster ovary cells	–, –	–, (+)	Galloway et al. 1985; NTP 1989a

## 3. HEALTH EFFECTS

**Table 3-4. Genotoxicity of Bromoform *In Vitro***

End point	Species (test system)	Results <sup>a</sup>		Reference
		With activation	Without activation	
	Rat erythroblastic leukemia K <sub>3</sub> D cells	+	+	Fujie et al. 1993
Chromosomal aberrations	Chinese hamster ovary cells	-, -	-, (+)	Galloway et al. 1985; NTP 1989a
Trifluorothymidine resistance	Mouse lymphoma cells	+	+	NTP 1989a
DNA strand breaks	Human lymphocytes	No data	+	Landi et al. 1999
	Human lymphoblastic leukemia cells	+	+	Geter et al. 2003a
	Primary rat hepatocyte	-	-	Geter et al. 2003a

<sup>a</sup>Results from two or more different contract laboratories are separated by commas  
 + = positive result; - = negative result; (+) = marginally positive result

## 3. HEALTH EFFECTS

intraperitoneal doses of 800 mg/kg (NTP 1989a). Increases in micronuclei induction were observed in mice exposed to 800 mg/kg via intraperitoneal injection (NTP 1989a) and newt larvae following a 6-day exposure to 2.5 mg/L (LeCurieux et al. 1995), but not in mice receiving a single intraperitoneal dose of 175–1,400 mg/kg (Hayashi et al. 1988) or 250–1,000 mg/kg via gavage (Stocker et al. 1997). No alterations in unscheduled DNA synthesis were observed in mice administered 324 or 1,080 mg/kg via gavage (Stocker et al. 1997). No alterations in DNA strand breaks were observed in the kidneys of rats administered 380 mg/kg for 1 day via gavage (Potter et al. 1996) or in the liver, kidney, or duodenum of rats administered 152 mg/kg either as a single oral bolus or on drinking water for 2 weeks (Geter et al. 2003a). An increase in sex-linked recessive mutations was observed in *Drosophila melanogaster* following feeding, but not injection exposure (NTP 1989a); no effect on reciprocal translocations was found.

***Dibromochloromethane.*** The genotoxicity of dibromochloromethane has been assessed in a number of *in vivo* and *in vitro* assays. The results of these studies are presented in Tables 3-5 and 3-6, respectively.

Mixed results were found in *in vitro* bacterial assays for reverse gene mutations, with some studies finding significant alterations (Landi et al. 1999; Simmon and Tardiff 1978; Simmon et al. 1977; Varma et al. 1988) and others not finding an effect (Kubo et al. 2002; LeCurieux et al. 1995; NTP 1985; Zeiger et al. 1987). A significant increase in forward gene mutations was found in mouse lymphoma cells (McGregor et al. 1991). An increase in gene conversion, but not gene reversion, was observed in *Saccharomyces cerevisiae* (Nestman and Lee 1985). An increase in mitotic aneuploidy was observed in *A. nidulans* and sister chromatid exchange was observed in human lymphocytes (Morimoto and Koizumi 1983; Sobti 1984), rat liver cells (Sobti 1984), and rat erythroblastic leukemia K<sub>3</sub>D cells (Fujie et al. 1993). DNA strand breaks were observed in human lymphoblastic leukemia cells, but not in primary rat hepatocytes (Geter et al. 2003a). Additionally, increases in chromosomal aberrations were observed in mouse lymphoma cells (Sofuni et al. 1996) and Chinese hamster lung cells (Matsuoka et al. 1996).

*In vivo*, oral exposure to 25–200 mg/kg/day for 4 days resulted in dose-related increases in the frequency of sister chromatid exchanges in mouse bone marrow cells (Morimoto and Koizumi 1983). An increase in the occurrence of chromosomal aberrations was also observed in bone marrow cells of rats receiving a single intraperitoneal injection of 20.8 mg/kg (Fujie et al. 1990); a weak positive response was observed following gavage administration of 10.5–1,041.5 mg/kg/day for 5 days (Fujie et al. 1990). No significant alterations in micronuclei induction (Hayashi et al. 1988), repairable DNA damage (Stocker et al. 1996),

## 3. HEALTH EFFECTS

**Table 3-5. Genotoxicity of Dibromochloromethane *In Vivo***

End point	Species (test system)	Exposure route	Results	Reference
Nonmammalian systems:				
Micronuclei	<i>Pleurodeleswalti larvae</i>		–	LeCurieux et al. 1995
Mammalian systems:				
Sister chromatid exchange	Mouse (bone marrow cell)	Oral	+	Morimoto and Koizumi 1983
Chromosomal aberrations	Rat (bone marrow cell)	IP	+	Fujie et al. 1990
	Rat (bone marrow cell)	Oral	(+)	Fujie et al. 1990
Micronuclei	Mouse (bone marrow cell)	IP	–	Hayashi et al. 1988
Repairable DNA damage	Rat (liver cells)	Oral	–	Stocker et al. 1996
DNA strand breaks	Rat (kidney cells)	Oral	–	Potter et al. 1996
	Rat (liver, kidney, duodenum)	Oral	–	Geter et al. 2003a

+ = positive result; – = negative result; (+) = weak positive; IP = intraperitoneal

## 3. HEALTH EFFECTS

**Table 3-6. Genotoxicity of Dibromochloromethane *In Vitro***

End point	Species (test system)	Results <sup>a</sup>		Reference
		With activation	Without activation	
Prokaryotic organisms:				
Reverse gene mutation	<i>Salmonella typhimurium</i> (desiccator system)			Simmon and Tardiff 1978; Simmon et al. 1977
	TA100	No data	+	
	<i>S. typhimurium</i>			LeCurieux et al. 1995
	TA100	-	-	
	<i>S. typhimurium</i>			Kubo et al. 2002
	TA100	-	-	
	TA98	-	-	
	<i>S. typhimurium</i> (plate incorporation assay)			Varma et al. 1988
	TA98	+	-	
	TA100	+	-	
	TA1535	+	+	
	TA1537	+	+	
	<i>S. typhimurium</i> (preincubation assay)			NTP 1985; Zeiger et al. 1987
	TA98	-	-	
	TA100	-	-	
	TA1535	-	-	
	TA1537	-	-	
	<i>S. typhimurium</i>			Landi et al. 1999
	TPT100	+	+	
	RSJ100	-	-	
Eukaryotic organisms:				
Fungi:				
Mitotic aneuploidy	<i>Aspergillus nidulans</i>	No data	+	Benigni et al. 1993
Gene conversion	<i>Saccharomyces cerevisiae</i>	-	+	Nestman and Lee 1985
Gene reversion	<i>S. cerevisiae</i>	-	-	Nestman and Lee 1985
Mammalian cells:				
Forward gene mutation	Mouse L5178Y lymphoma cells	No data	+	McGregor et al. 1991
Sister-chromatid exchange	Human lymphocytes	No data	+	Morimoto and Koizumi 1983
	Human lymphocytes	No data	+	Sobti 1984
	Rat liver cells	No data	(+)	Sobti 1984
	Rat erythroblastic leukemia K <sub>3</sub> D cells	+	+	Fujie et al. 1993



## 3. HEALTH EFFECTS

**Table 3-6. Genotoxicity of Dibromochloromethane *In Vitro***

End point	Species (test system)	Results <sup>a</sup>		Reference
		With activation	Without activation	
Chromosomal aberrations	Mouse L5178Y lymphoma cells	+,+	(+),-	Sofuni et al. 1996
	Chinese hamster lung cells	No data	+	Matsuoka et al. 1996
DNA single strand breaks	Human lymphoblastic leukemia cells	+	+	Geter et al. 2003a
	Primary rat hepatocyte	-	-	Geter et al. 2003a

<sup>a</sup>Results from two or more different contract laboratories are separated by commas

+ = positive result; - = negative result; (+) = marginally positive result

### 3. HEALTH EFFECTS

or DNA strand breaks (Potter et al. 1996) were observed in mouse bone marrow cells (intraperitoneal injection of 62.5–1,000 mg/kg), rat liver cells (gavage dose of 135 or 450 mg/kg), or rat kidney cells (gavage dose of 310 mg/kg), respectively. Likewise, no DNA strand breaks were observed in the liver, kidney, or duodenum of rats administered 125 mg/kg either as a single oral bolus or on drinking water for 2 weeks (Geter et al. 2003a).

## 3.4 TOXICOKINETICS

### 3.4.1 Absorption

#### 3.4.1.1 Inhalation Exposure

There are limited data on inhalation absorption of bromoform or dibromochloromethane. Based on the physical-chemical properties of these compounds, and by analogy with other related halomethanes such as chloroform (Agency for Toxic Substances and Disease Registry 1997), it is expected that bromoform and dibromochloromethane would be well-absorbed across the lung. The occurrence of systemic and neurological effects following inhalation exposure of animals to bromoform (see Section 3.2.1) supports this view. Aggazzotti et al. (1998) examined the uptake of trihalomethanes in five swimmers exposed to trihalomethanes via chlorinated pool water. Although bromoform was detected in the pool water, it was only detected in one of four indoor air samples. Dibromochloromethane was detected in the pool water (0.8 µg/L) and in air samples before swimming (5.2 µg/m<sup>3</sup>) and after swimming (11.4 µg/m<sup>3</sup>). After sitting near the pool for 1 hour, the mean alveolar air level was 0.8 µg/m<sup>3</sup>. After swimming, alveolar air levels were 1.4 µg/m<sup>3</sup>; however, oral and percutaneous exposure also influenced this level. Estimated dibromochloromethane uptake during the 1 hour of sitting near the pool ranged from 1.5 to 2.0 µg/hour; after 1 hour of swimming, the estimated uptake rate ranged from 14 to 22 µg/hour.

Several studies have examined the impact of showering with water contaminated with trihalomethanes on the absorption of individual trihalomethane compounds. Showering involves inhalation exposure to volatilized trihalomethanes, percutaneous exposure, and possibly oral exposure. Several studies have found elevated blood bromoform and/or dibromochloromethane levels following showering (Backer et al. 2000; Lynberg et al. 2001; Miles et al. 2002). A comparative study by Backer et al. (2000) found the highest blood levels of dibromochloromethane after a 10-minute shower, compared to bathing for 10 minutes or drinking 1 L of water in 10 minutes. This difference may be due to differences in total exposure levels, metabolism, or excretion rather than differences in absorption efficiencies.

## 3. HEALTH EFFECTS

Several studies have estimated the blood:air partition coefficients for bromoform and dibromochloromethane in humans and rats, these values are summarized in Table 3-7.

**3.4.1.2 Oral Exposure**

There are limited data on the absorption of bromoform and dibromochloromethane following oral exposure. Most of the available data (Backer et al. 2000; da Silva et al. 1999; Mink et al. 1986) involved exposure to a mixture of trihalomethanes. Elevated blood concentrations of dibromochloromethane were also observed in humans ingesting drinking water containing trihalomethanes (Backer et al. 2000). da Silva et al. (1999) examined bromoform and dibromochloromethane absorption in rats following a single gavage dose. Both compounds were rapidly absorbed with peak plasma levels occurring <1 hour postexposure. Oral absorption constants of 0.412 and 0.55 per hour were reported for bromoform and dibromochloromethane, respectively. A nonlinear relationship between dose (0.25 and 0.50 mmol/kg; 63 and 126 mg/kg bromoform and 52 and 104 mg/kg dibromochloromethane) and areas under the blood concentration versus time curves (AUCs) were found, suggesting metabolism saturation. The AUCs (20–360 minutes postexposure) for 63 and 126 mg/kg bromoform were 48.6 and 190.4  $\mu\text{M}/\text{hour}$ ; for 52 and 104 mg/kg dibromochloromethane, the AUCs (20–360 minutes) were 31.2 and 85.6  $\mu\text{M}/\text{hour}$ . When bromoform and dibromochloromethane were administered along with chloroform and dichlorobromomethane (0.25 mmol/kg of each trihalomethane), the AUC was significantly higher than when administered singly.

Mink et al. (1986) found that 60–90% of the bromoform and dibromochloromethane administered in a mixture of trihalomethanes in corn oil to rats (100 mg trihalomethane/kg) or mice (150 mg trihalomethane/kg) were recovered in expired air, urine, or in internal organs. This indicates that gastrointestinal absorption was at least 60–90% complete. This is consistent with the ready gastrointestinal absorption observed for other halomethanes such as chloroform (Agency for Toxic Substances and Disease Registry 1997). As noted by Withey et al. (1983), the rate of halocarbon uptake from the gastrointestinal tract may be slower when compounds are given in oil than when they are given in water.

**3.4.1.3 Dermal Exposure**

No studies were located regarding dermal absorption of bromoform. A single study was found to quantitatively demonstrate dermal absorption of dibromochloromethane in human volunteers exposed for

## 3. HEALTH EFFECTS

**Table 3-7. Partition Coefficients for Bromoform and Dibromochloromethane**

	Chemical	Partition coefficient	Species	Reference
Blood:Air	Bromoform	102.3	Human	Batterman et al. 2002
		161	Rat	Beliveau and Krishnan 2000
		187	Rat	Beliveau et al. 2000b
		198.1	Rat	da Silva et al. 1999
	Dibromochloromethane	52.7	Human	Gargas et al. 1989
		49.2	Human	Batterman et al. 2002
		116	Rat	Gargas et al. 1989
		97.5	Rat	Beliveau et al. 2000b
Fat:Air	Bromoform	4,129	Rat	da Silva et al. 1999
	Dibromochloromethane	1,919	Rat	Gargas et al. 1989
Liver:Air	Bromoform	210.3	Rat	da Silva et al. 1999
	Dibromochloromethane	126	Rat	Gargas et al. 1989
Muscle:Air	Bromoform	115.1	Rat	da Silva et al. 1999
	Dibromochloromethane	55.6	Rat	Gargas et al. 1989

### 3. HEALTH EFFECTS

60 minutes to tap water having a temperature similar to that of bathing water (Prah et al. 2002). The sealed exposure apparatus was designed to permit the exposure of a single hand and lower arm by immersion while preventing an inhalation exposure. The mean tap water concentration of dibromochloromethane was 1.4 ng/mL. Dibromochloromethane levels in the blood increased constantly from the start to 5 minutes after the end of the exposure. At 15 minutes after cessation of exposure, blood levels appeared to fall slightly slower than the rate of appearance. These data have limited use since rates of dermal absorption or appearance in the blood were not reported.

As discussed under Inhalation Exposure, showering, which involves both inhalation and dermal exposure with water contaminated with trihalomethanes, can result in significantly elevated blood bromoform and dibromochloromethane levels. Xu et al. (2002) reported dermal absorption coefficients of 0.21 and 0.20 cm/hour for aqueous solutions of bromoform and dibromochloromethane, respectively. These values were determined *in vitro* using excess breast skin tissues at two temperature settings (20 and 25 °C).

#### 3.4.2 Distribution

Several studies have estimated the tissue:air partition coefficients for bromoform and dibromochloromethane in humans and rats; these values are summarized in Table 3-7. *In vitro* data, suggest that hemoglobin is the primary ligand for bromoform, and presumably dibromochloromethane, in the blood (Béliveau and Krishnan 2000b).

##### 3.4.2.1 Inhalation Exposure

No studies were located regarding the distribution of bromoform or dibromochloromethane in humans or animals following inhalation exposure. However, adverse effects involving several organs (liver, kidney, central nervous system) indicate distribution to these sites.

##### 3.4.2.2 Oral Exposure

The distribution of bromoform and dibromochloromethane in tissues following oral exposure has not been thoroughly investigated. Analysis of bromoform levels in the organs of a child who died after an accidental overdose revealed concentrations of 10–40 mg/kg tissue in intestine, liver, kidney, and brain,

## 3. HEALTH EFFECTS

with somewhat higher levels in lung (90 mg/kg) and stomach (130 mg/kg) (Roth 1904, as cited in von Oettingen 1955). This suggests that bromoform is distributed fairly evenly from the stomach to other tissues.

In animals, Mink et al. (1986) found that only about 1–2% of a single oral dose of <sup>14</sup>C-labeled dibromochloromethane or bromoform as part of a trihalomethane mixture was retained in the soft tissues of rats 8 hours after dosing. The tissues which contained measurable amounts of the radiolabel were the brain, kidney, liver, lungs, muscle, pancreas, stomach (excluding contents), thymus, and urinary bladder. The relative amount of radiolabel in each tissue was not mentioned. Similar results were noted in mice, except that blood also contained a significant fraction of the total dose (10% in the case of bromoform). The chemical form of the material in the tissues (parent, metabolite, or adduct) was not reported. The form in blood also was not determined, but studies by Anders et al. (1978) suggest that some or all may have been carbon monoxide bound to hemoglobin (see Section 3.4.3).

#### 3.4.2.3 Dermal Exposure

No studies were located regarding the distribution of bromoform or dibromochloromethane in humans or animals following dermal exposure.

#### 3.4.3 Metabolism

The metabolism of bromoform, dibromochloromethane, and other trihalomethanes has been investigated by Anders and colleagues (Ahmed et al. 1977; Anders et al. 1978; Stevens and Anders 1979, 1981). The main reactions, which are not believed to be route-dependent, are shown in Figure 3-3. The first step in the metabolism of trihalomethanes is oxidation by the cytochrome P-450 mixed function oxidase system of liver. This has been demonstrated *in vitro* using isolated rat liver microsomes (Ahmed et al. 1977), and *in vivo*, where the rate of metabolism is increased by cytochrome P-450 inducers (phenobarbital) and decreased by cytochrome P-450 inhibitors (SKF-525A) (Anders et al. 1978). The product of this reaction is presumed to be trihalomethanol, which then decomposes by loss of hydrogen and halide ions to yield the dihalocarbonyl. Although this intermediate has not been isolated, its formation has been inferred by the detection of 2-oxothiazolidine-4-carboxylic acid (OZT) in an *in vitro* microsomal system metabolizing bromoform in the presence of cysteine (Stevens and Anders 1979). The dihalocarbonyl molecule (an

## 3. HEALTH EFFECTS

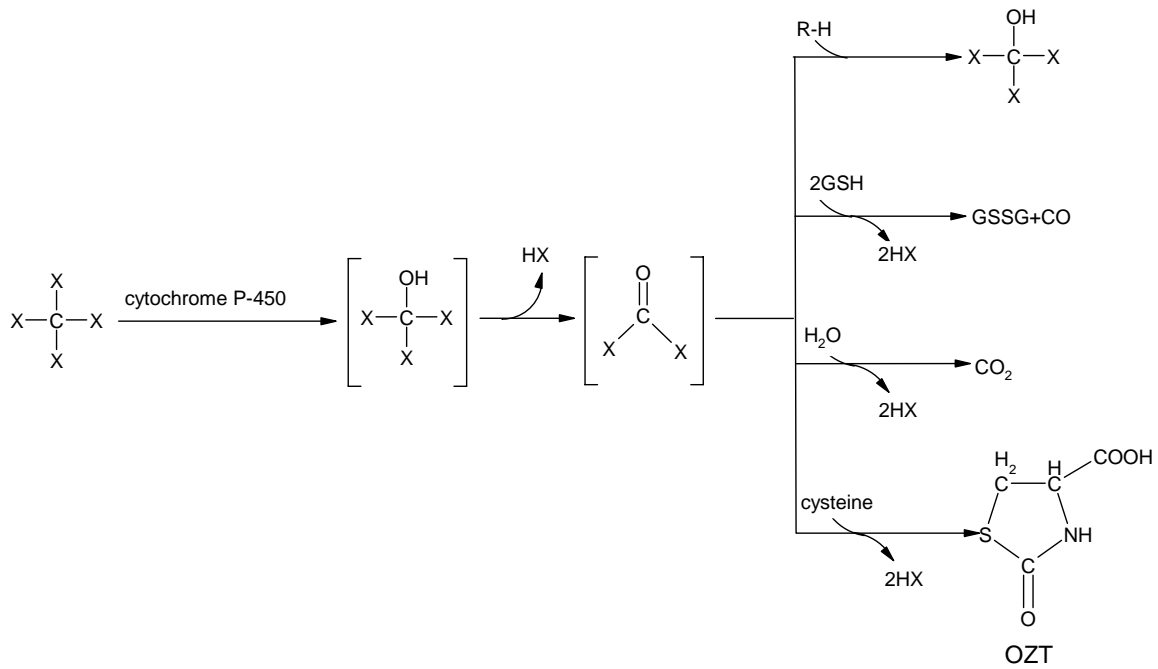
**Figure 3-3. Proposed Pathway of Trihalomethane Metabolism in Rats\***

\*Adapted from Stevens and Anders 1981

X = halogen atom (chlorine, bromine); R = cellular nucleophile (protein, nucleic acid); GSH = reduced glutathione; GSSG = oxidized glutathione; OZT = oxothiazolidine carboxylic acid

## 3. HEALTH EFFECTS

analogue of phosgene) is highly reactive, and may undergo a number of reactions, including: (a) direct reaction with cellular nucleophiles to yield covalent adducts; (b) reaction with two moles of glutathione (GSH) to yield carbon monoxide and oxidized glutathione (GSSG); and (c) hydrolysis to yield CO<sub>2</sub>. The amount of trihalomethane metabolized by each of these pathways has not been studied in detail, but it appears that conversion to CO<sub>2</sub> is the main route. However, this depends on the species, the trihalomethane being metabolized, and metabolic conditions (cellular glutathione levels). Mink et al. (1986) found that mice oxidized 72% of an oral dose of dibromochloromethane and 40% of an oral dose of bromoform to CO<sub>2</sub>. In contrast, rats oxidized only 18% of dibromochloromethane and 4% of bromoform to CO<sub>2</sub>. The fraction of the dose converted to carbon monoxide has not been quantified, but dramatically increased levels of carboxyhemoglobin have been reported following oral exposure of rats to bromoform (Anders et al. 1978; Stevens and Anders 1981). Mink et al. (1986) reported that about 10% of a dose of bromoform was present in blood in mice; the form of the label was not investigated, but it may have been carboxyhemoglobin.

Metabolism of trihalomethanes by cytochrome P-450 can also lead to the production of highly reactive trihalomethyl free radicals, especially under hypoxic conditions (O'Brien 1988). Radical formation from bromoform has been observed both in isolated hepatocytes incubated with bromoform *in vitro* and in the liver of rats exposed to bromoform *in vivo* (Tomasi et al. 1985). Although it has not been studied, it seems likely that this pathway would also generate trihalomethyl radicals from dibromochloromethane. While metabolism to free radicals is a minor pathway in the sense that only a small fraction of the total dose is converted, it might be an important component of the toxic and carcinogenic mechanism of dibromochloromethane and bromoform. Figure 3-4 shows how free radical generation can lead to an autocatalytic peroxidation of polyunsaturated fatty acids (PLJFAs) in cellular phospholipids (O'Brien 1988). Peroxidation of cellular lipids has been observed in rat kidney slices incubated with bromoform *in vitro*, although lipid peroxidation was not detectable in liver slices (Fraga et al. 1987). Lipid peroxidation is considered to be a likely cause of cell injury for other halogenated compounds such as carbon tetrachloride (Agency for Toxicological Substances and Disease Registry 1994), but the significance of this pathway in the toxicity of dibromochloromethane and bromoform remains to be determined.

Development of the general metabolic scheme for trihalomethanes shown in Figure 3-3 relied primarily on the use of chloroform and bromoform as model substrates. However, some metabolic data specific to dibromochloromethane are available from a series of experiments conducted in rats by Pankow et al. (1997). Increased levels of the metabolites bromide (in plasma) and carbon monoxide (as detected by



## 3. HEALTH EFFECTS

**Figure 3-4. Proposed Pathway of Trihalomethyl-radical-mediated Lipid Peroxidation\***

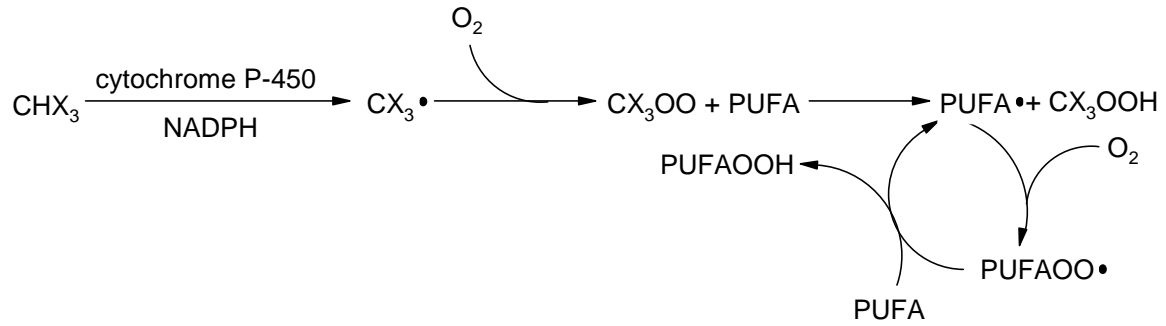

\*Adapted from O'Brien 1988

X = halogen atom (chlorine, bromine, iodine); PUFA = polyunsaturated fatty acid

## 3. HEALTH EFFECTS

formation of carboxyhemoglobin in blood) and dependence of their rate of production on hepatic GSH concentration in rats treated with dibromochloromethane are consistent with the metabolic scheme for the oxidative pathway shown in Figure 3-3. Observation of increased hepatic levels of GSSG in dosed rats by Pankow et al. (1997) is also consistent with the proposed scheme. The observation of (1) partial inhibition of bromide and carboxyhemoglobin production in dosed rats co-administered diethyldithiocarbamate (a potent inhibitor of P-450 isoform CYP2E1) and (2) stimulation of production in rats pretreated with isoniazid (a potent inducer of CYP2E1) indicates that cytochrome P-450 isoform CYP2E1 is at least partially responsible for oxidative metabolism of dibromochloromethane. Pretreatment with phenobarbital (an inducer of CYP2B1/2 in the rat) increased the concentration of bromide in plasma, suggesting that CYP2B1/2, as well as CYP2E1, catalyzes metabolism of dibromochloromethane in the rat.

Recent studies suggest that brominated trihalomethanes, including bromoform and dibromochloromethane, may be metabolized by one or more pathways dependent on glutathione conjugation catalyzed by glutathione S-transferase (De Marini et al. 1997; Pegram et al. 1977) in addition to the oxidative and reductive pathways described above. Transfection of *Salmonella typhimurium* test strain TA1535 with the gene for rat glutathione S-transferase theta 1-1 increased the mutagenicity of bromoform and dibromochloromethane (by 95- and 85-fold, respectively) in reverse mutation assays when compared to mutagenicity in TA1535 transfected with a nonfunctional form of the gene (De Marini et al. 1997). The mutational spectra and site specificity for bromoform, dibromochloromethane, and bromodichloromethane (a structurally-related brominated trihalomethane) were closely similar, suggesting bioactivation of all three compounds via common metabolic intermediates. The mutagenic metabolites were not identified in this study, but S-(1-halomethyl)glutathione, S-(1,1-dihalomethyl) glutathione, or their further metabolites were presumed on the basis of data reported for other halomethanes to be capable of reacting with DNA to produce the observed mutations (De Marini et al. 1997).

The formation of reactive metabolites by conjugation of bromoform or dibromochloromethane via glutathione S-transferase theta-mediated pathways has not been examined in mammalian test systems. However, the metabolism of bromodichloromethane via glutathione conjugation has been investigated *in vitro* using cytosols prepared from human, rat, and mouse liver (Ross and Pegram 2003). Conjugation of bromodichloromethane with glutathione in mouse liver cytosol was time- and protein-dependent, was not affected by an inhibitor of alpha-, mu-, and pi-class glutathione S-transferases, and was correlated with activity toward 1,2-epoxy-3-(4'-nitrophenoxy)propane (a substrate specific for theta-class glutathione S-transferases). Conjugation activity toward bromodichloromethane in hepatic cytosols isolated from

### 3. HEALTH EFFECTS

different species followed the rank order mouse, followed by rat, then human. The initial conjugate formed was S-chloromethyl glutathione. This compound was unstable and degraded to multiple metabolites including S-hydroxymethyl glutathione, S-formyl glutathione, and formic acid. These data demonstrate that glutathione conjugation of bromodichloromethane occurs in mammalian liver cytosols and is likely catalyzed by glutathione S-transferase theta. These findings are significant because production of reactive glutathione conjugates from bromodichloromethane may result in formation of DNA adducts and thus cause genotoxicity. Because there is structural similarity among the brominated trihalomethanes and evidence for common pathways of bioactivation (De Marini et al. 1997), the findings of Ross and Pegram (2003) support the idea that glutathione conjugation of bromoform and dibromochloromethane leading to formation of reactive metabolites also occurs in the liver of rodents and humans.

Comparison of catalytic efficiencies for recombinant rat CYP2E1 and glutathione S-transferase theta 1-1 using bromodichloromethane as a substrate (data on bromoform or dibromochloromethane are not available) suggest that glutathione conjugation is likely to be a quantitatively minor hepatic pathway *in vivo* (Ross and Pegram 2003). Although metabolism via this pathway may be minor from the standpoint that only a small fraction of the total dose is converted, it might be an important component of the mechanism for dibromochloromethane and/or bromoform toxicity in extrahepatic tissues where GSTT1-1 is expressed in conjunction with lower levels of CYP2E1.

#### **3.4.4 Elimination and Excretion**

##### **3.4.4.1 Inhalation Exposure**

No studies were located regarding excretion of bromoform or dibromochloromethane by humans or animals following inhalation exposure.

##### **3.4.4.2 Oral Exposure**

In rats and mice given a single oral dose of <sup>14</sup>C-labeled bromoform or dibromochloromethane as part of a trihalomethane mixture (100 mg/kg in rats and 150 mg/kg in mice), excretion occurred primarily by exhalation of bromoform or dibromochloromethane or of CO<sub>2</sub> (Mink et al. 1986). In mice, 39.68 and 71.58% of the administered radiolabelled bromoform and dibromochloromethane, respectively, were exhaled as CO<sub>2</sub> and 7.18 and 12.31% as unmetabolized compound, respectively. In contrast, 4.3 and

### 3. HEALTH EFFECTS

18.2% of bromoform and dibromochloromethane were exhaled as CO<sub>2</sub> in rats and 66.9 and 48.1% of parent compound. Only 1–5% of the dose was excreted in urine (the chemical form in urine was not determined). The elimination half-times of bromoform and dibromochloromethane were 0.8 and 1.2 hours, respectively, in rats at 8 or 2.5 hours, respectively, in mice.

#### 3.4.4.3 Dermal Exposure

No studies were located regarding excretion of bromoform or dibromochloromethane by humans or animals following dermal exposure.

#### 3.4.5 Physiologically Based Pharmacokinetic (PBPK)/Pharmacodynamic (PD) Models

Physiologically based pharmacokinetic (PBPK) models use mathematical descriptions of the uptake and disposition of chemical substances to quantitatively describe the relationships among critical biological processes (Krishnan et al. 1994). PBPK models are also called biologically based tissue dosimetry models. PBPK models are increasingly used in risk assessments, primarily to predict the concentration of potentially toxic moieties of a chemical that will be delivered to any given target tissue following various combinations of route, dose level, and test species (Clewell and Andersen 1985). Physiologically based pharmacodynamic (PBPD) models use mathematical descriptions of the dose-response function to quantitatively describe the relationship between target tissue dose and toxic end points.

PBPK/PD models refine our understanding of complex quantitative dose behaviors by helping to delineate and characterize the relationships between: (1) the external/exposure concentration and target tissue dose of the toxic moiety, and (2) the target tissue dose and observed responses (Andersen et al. 1987; Andersen and Krishnan 1994). These models are biologically and mechanistically based and can be used to extrapolate the pharmacokinetic behavior of chemical substances from high to low dose, from route to route, between species, and between subpopulations within a species. The biological basis of PBPK models results in more meaningful extrapolations than those generated with the more conventional use of uncertainty factors.

The PBPK model for a chemical substance is developed in four interconnected steps: (1) model representation, (2) model parametrization, (3) model simulation, and (4) model validation (Krishnan and Andersen 1994). In the early 1990s, validated PBPK models were developed for a number of

## 3. HEALTH EFFECTS

toxicologically important chemical substances, both volatile and nonvolatile (Krishnan and Andersen 1994; Leung 1993). PBPK models for a particular substance require estimates of the chemical substance-specific physicochemical parameters, and species-specific physiological and biological parameters. The numerical estimates of these model parameters are incorporated within a set of differential and algebraic equations that describe the pharmacokinetic processes. Solving these differential and algebraic equations provides the predictions of tissue dose. Computers then provide process simulations based on these solutions.

The structure and mathematical expressions used in PBPK models significantly simplify the true complexities of biological systems. If the uptake and disposition of the chemical substance(s) are adequately described, however, this simplification is desirable because data are often unavailable for many biological processes. A simplified scheme reduces the magnitude of cumulative uncertainty. The adequacy of the model is, therefore, of great importance, and model validation is essential to the use of PBPK models in risk assessment.

PBPK models improve the pharmacokinetic extrapolations used in risk assessments that identify the maximal (i.e., the safe) levels for human exposure to chemical substances (Andersen and Krishnan 1994). PBPK models provide a scientifically sound means to predict the target tissue dose of chemicals in humans who are exposed to environmental levels (for example, levels that might occur at hazardous waste sites) based on the results of studies where doses were higher or were administered in different species. Figure 3-5 shows a conceptualized representation of a PBPK model.

PBPK models have not been developed for bromoform or dibromochloromethane. da Silva et al. (1999) developed a model to simulate the venous blood concentration of each trihalomethane after simultaneous exposure to the four trihalomethanes. This model, which simulates competitive inhibition of hepatic metabolism, is discussed in Section 3.9. Although da Silva et al. (1999) also described models in rats following single administration of bromoform or dibromochloromethane, these models involved optimizing metabolic parameters across the dose range used in the study and were not developed as stand-alone models.

## 3. HEALTH EFFECTS

**Figure 3-5. Conceptual Representation of a Physiologically Based Pharmacokinetic (PBPK) Model for a Hypothetical Chemical Substance**

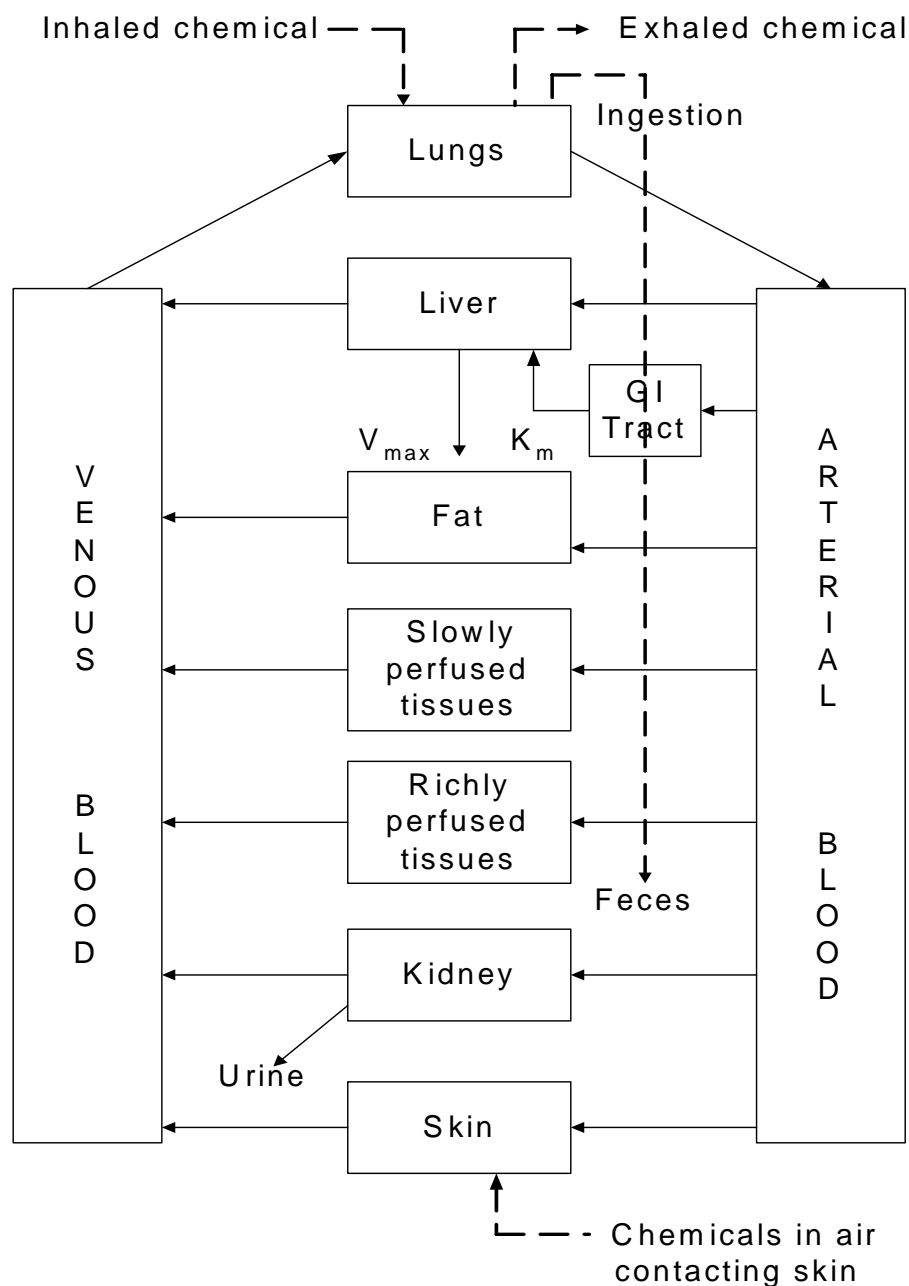

Source: adapted from Krishnan et al. 1994

Note: This is a conceptual representation of a physiologically based pharmacokinetic (PBPK) model for a hypothetical chemical substance. The chemical substance is shown to be absorbed via the skin, by inhalation, or by ingestion, metabolized in the liver, and excreted in the urine or by exhalation.

## 3. HEALTH EFFECTS

**3.5 MECHANISMS OF ACTION****3.5.1 Pharmacokinetic Mechanisms**

Bromoform and dibromochloromethane can be absorbed by inhalation (Graham 1915; Merzbach 1928), ingestion (Backer et al. 2000; Mink et al. 1986), and dermal (Backer et al. 2000; Xu et al. 2002) routes of exposure. In humans and laboratory animals, bromoform and dibromochloromethane are generally absorbed quickly (Backer et al. 2000). Although bromoform and dibromochloromethane are lipophilic, they do not appear to accumulate in adipose tissue (Stanley 1986). Bromoform and dibromochloromethane are thought to be metabolized by at least two route-independent pathways: oxidation by cytochrome P-450 mixed function oxidase system (Ahmed et al. 1977; Anders et al. 1978) and conjugation via glutathione S-transferase (DeMarini et al. 1997; Pegram et al. 1977). Bromoform and dibromochloromethane are primarily excreted via exhalation as the parent compound or carbon dioxide (Mink et al. 1986).

**3.5.2 Mechanisms of Toxicity**

The mechanisms by which bromoform and dibromochloromethane cause damage in target tissues is not fully understood, but there is strong evidence that metabolism to reactive intermediates is a prerequisite for toxicity. Subsequent interaction of the reactive intermediates with key cellular molecules leads to impaired function and/or cell death.

Several mechanisms for cell injury by trihalomethanes have been proposed based on the combined experimental database for chloroform and the brominated trihalomethanes. These include: (1) oxidative metabolism by CYP2E1 to produce dihalocarbonyls, which deplete glutathione content, and alkylate cellular macromolecules to produce necrosis; (2) reductive dehalogenation under conditions of low physiological oxygen tension to produce highly reactive dihalomethyl free radicals that covalently bind to proteins or lipids; and (3) glutathione-dependent metabolism to DNA-reactive intermediates, which results in adduct formation and mutation. Toxicity of bromoform and dibromochloromethane may result from metabolism by one or more of these pathways. Bromine is generally a better leaving group than chlorine, suggesting that the degree of bromine substitution will influence the rate of metabolism among chlorinated and brominated trihalomethanes and the flux through specific pathways.

## 3. HEALTH EFFECTS

Although mechanistic data on bromoform and dibromochloromethane are lacking, the requirement for metabolism of these compounds to toxic intermediates is supported by studies of chloroform and bromodichloromethane. In a representative study, Ilett et al. (1973) observed covalent binding of radiolabeled material to proteins in the liver and kidney following administration of [<sup>14</sup>C]chloroform to mice. The amount of binding was correlated with the extent of renal and hepatic necrosis both in normal animals and in male mice pretreated with an inhibitor or inducer of microsomal enzymes. Autoradiograms showed that the bound radioactivity was located mainly in necrotic lesions. In other studies, Brown et al. (1974) reported that pretreatment of rats with phenobarbital (a cytochrome P-450 inducer) resulted in increased formation of covalent adducts and increased hepatic toxicity following chloroform exposure. Pohl et al. (1980) reported that the level of covalent binding correlated directly with injury to the liver tissue and concluded that phosgene was the metabolite responsible for the covalent binding to liver macromolecules. Tyson et al. (1983) confirmed that covalent binding to proteins in rats was more prevalent in areas of necrosis than in less damaged areas. More recently, Constan et al. (1999) evaluated toxicity in male B6C3F<sub>1</sub>, SV/129 wild-type (CYP2E1 +/+), and SV/129 null (CYP2E1 -/-) mice exposed to chloroform by inhalation. Parallel groups of control and treated mice (B6C3F<sub>1</sub> and wild-type SV/129) were also treated with an irreversible cytochrome P-450 inhibitor. Extensive hepatic and renal necrosis occurred in B6C3F<sub>1</sub> and SV/129 mice exposed to chloroform. Chloroform-exposed animals that received the inhibitor were completely protected against hepatic and renal toxicity and pathological changes were absent in null mice, demonstrating that metabolism is necessary for toxicity.

The data linking metabolism of brominated trihalomethanes to toxicity are less extensive than those for chloroform. No data were located specifically for bromoform or dibromochloromethane. Pretreatment of female rats and mice with inhibitors of CYP2E1 metabolism reduced the acute renal and hepatic toxicity of bromodichloromethane (Thornton-Manning et al. 1994). Depletion of glutathione by pretreatment of male F344 rats with butathione sulfoximine (BSO) increased the incidence and severity of hepatic and renal lesions (Gao et al. 1996). Addition of glutathione to hepatic microsomal and S9 preparations and renal microsomes under aerobic conditions decreased covalent binding of [<sup>14</sup>C]bromodichloromethane to proteins. Addition of glutathione to hepatic or renal microsomes under anaerobic conditions decreased binding of [<sup>14</sup>C]bromodichloromethane to lipids (Gao et al. 1996). These data demonstrate a protective role of glutathione that is consistent with metabolism of bromodichloromethane to one or more reactive species.

Studies in animals indicate that bromoform and dibromochloromethane have carcinogenic potential (NTP 1985, 1989a). The mechanism of action for tumor induction by these chemicals is unknown and may



## 3. HEALTH EFFECTS

involve contributions from more than one of the proposed pathways described above. Pathway 1 (oxidative metabolism to dihalocarbonyl) may not be directly genotoxic, but may lead to increased risk of cancer as a result of cytotoxicity and subsequent regenerative hyperplasia, as observed for chloroform (ILSI 1997). Pathways 2 (reductive metabolism) and 3 (glutathione-dependent metabolism) may lead to direct DNA damage *in vivo*. The relative contribution of these pathways to the carcinogenic potential of bromoform and dibromochloromethane has not been determined.

Three studies have examined cytotoxicity and regenerative hyperplasia in the liver of female B6C3F<sub>1</sub> mice (Coffin et al. 2000; Melnick et al. 1998) or the kidney of male F344 rats (Potter et al. 1996) following exposure to bromoform or dibromochloromethane. These studies are of limited use for understanding the mechanism of bromoform carcinogenesis because they do not address cytotoxicity or regeneration in the large intestine, the target tissue for tumor induction. Dibromochloromethane induced cytotoxicity and cell proliferation in the liver of female B6C3F<sub>1</sub> mice, but the LOAEL values reported by Melnick et al. (1998) and Coffin et al. (2000) were inconsistent (400 vs. 100 mg/kg/day). Therefore, a threshold for induction of cellular proliferation cannot be clearly identified for comparison with the liver tumor incidence data in female B6C3F<sub>1</sub> mice (NTP 1985). The reason for the discrepancy between studies is unknown, but might be related to the use of different techniques or different time points for measurement of labeling index (a method for estimating cell proliferation). These data do not allow a conclusion regarding the role of cytotoxicity and regenerative cell proliferation in the development of hepatic tumors in mice exposed to dibromochloromethane. Melnick et al. (1998) modeled dose response data for cell proliferation and serum enzyme activity (as a composite) and for tumor induction in the liver of B6C3F<sub>1</sub> mice using an empirical Hill equation model. The dose-response curves for these processes had different shapes, suggesting that they were not causally associated.

Positive results for mutagenicity and cytogenetic damage have been observed in some standard assays (see Section 3.3), suggesting that some metabolites of bromoform and dibromochloromethane interact directly with DNA. Reductive metabolism (Melnick et al. 1998) and glutathione conjugation of brominated trihalomethanes have been proposed as a source of DNA reactive intermediates (De Marini et al. 1997; Ross and Pegram 2003), but the available data are too limited to fully evaluate the contribution of these pathways to the genotoxicity and carcinogenicity of bromoform and dibromochloromethane. Studies of bromodichloromethane metabolism in hepatic cytosols prepared from rat, mouse, and liver microsomes suggest that metabolism of brominated trihalomethanes via a glutathione-dependent pathway is likely to be a minor pathway in the liver (Ross and Pegram 2003). It is unknown whether the small amounts formed in the liver are toxicologically significant. It is possible that glutathione-dependent

## 3. HEALTH EFFECTS

pathways are of greater toxicological significance in extrahepatic tissues where concentrations of CYP2E1 are lower, such as the distal large intestine (Ross and Pegram 2003).

### 3.5.3 Animal-to-Human Extrapolations

Most of the available data on the toxicity and toxicokinetic properties of bromoform and dibromochloromethane come from studies in rats and mice. There are very limited human data, and the only end point that has been examined is neurotoxicity; high doses of bromoform result in central nervous system depression in humans and laboratory animals. Data from other trihalomethanes, particularly chloroform (Agency for Toxic Substances and Disease Registry 1997), suggest that the available laboratory animal toxicity and toxicokinetic data for bromoform and dibromochloromethane would also be applicable for humans. A potential difference between species is quantitative and qualitative differences in Phase I metabolism of trihalomethanes. In rats, trihalomethanes are substrates of cytochrome P-450 enzyme isoforms CYP2E1, CYP2B1, CYP2B2, and CYP1A2 (Allis et al. 2001; Pankow et al. 1997). CYP2E1 and CYP1A2 are also expressed in human tissues; however, the relevance of metabolism by CYP2B1/2 to human health is presently uncertain, since these isoforms have not been reported in human adult or fetal tissues (Juchau et al. 1998; Nelson et al. 1996). CYP2B6 is the only active member of the CYP2B subfamily in man, although the CYP2B7 gene has also been found in the genome (Czerwinski et al. 1994).

## 3.6 TOXICITIES MEDIATED THROUGH THE NEUROENDOCRINE AXIS

Recently, attention has focused on the potential hazardous effects of certain chemicals on the endocrine system because of the ability of these chemicals to mimic or block endogenous hormones. Chemicals with this type of activity are most commonly referred to as *endocrine disruptors*. However, appropriate terminology to describe such effects remains controversial. The terminology *endocrine disruptors*, initially used by Colborn and Clement (1992), was also used in 1996 when Congress mandated the EPA to develop a screening program for "...certain substances [which] may have an effect produced by a naturally occurring estrogen, or other such endocrine effect[s]...". To meet this mandate, EPA convened a panel called the Endocrine Disruptors Screening and Testing Advisory Committee (EDSTAC), and in 1998, the EDSTAC completed its deliberations and made recommendations to EPA concerning *endocrine disruptors*. In 1999, the National Academy of Sciences released a report that referred to these same types of chemicals as *hormonally active agents*. The terminology *endocrine modulators* has also been used to

### 3. HEALTH EFFECTS

convey the fact that effects caused by such chemicals may not necessarily be adverse. Many scientists agree that chemicals with the ability to disrupt or modulate the endocrine system are a potential threat to the health of humans, aquatic animals, and wildlife. However, others think that endocrine-active chemicals do not pose a significant health risk, particularly in view of the fact that hormone mimics exist in the natural environment. Examples of natural hormone mimics are the isoflavonoid phytoestrogens (Adlercreutz 1995; Livingston 1978; Mayr et al. 1992). These chemicals are derived from plants and are similar in structure and action to endogenous estrogen. Although the public health significance and descriptive terminology of substances capable of affecting the endocrine system remains controversial, scientists agree that these chemicals may affect the synthesis, secretion, transport, binding, action, or elimination of natural hormones in the body responsible for maintaining homeostasis, reproduction, development, and/or behavior (EPA 1997). Stated differently, such compounds may cause toxicities that are mediated through the neuroendocrine axis. As a result, these chemicals may play a role in altering, for example, metabolic, sexual, immune, and neurobehavioral function. Such chemicals are also thought to be involved in inducing breast, testicular, and prostate cancers, as well as endometriosis (Berger 1994; Giwercman et al. 1993; Hoel et al. 1992).

No *in vitro* studies were located regarding endocrine disruption of bromoform and dibromochloromethane.

There is little evidence to suggest that bromoform or dibromochloromethane has the potential to disrupt the normal functioning of the neuroendocrine axis. There are some suggestive data that these chemicals have the potential to alter reproductive hormone levels. An ecological study found significant correlations between bromoform and dibromochloromethane concentrations in drinking water and alterations in menstrual cycle length (Windham et al. 2003); however, the women were exposed to a number of other potentially toxic compounds in the drinking water and the data are inadequate for establishing causality. In rats administered 310–380 mg/kg/day bromoform or dibromochloromethane, significant decreases in serum testosterone levels were observed (Potter 1996).

#### 3.7 CHILDREN'S SUSCEPTIBILITY

This section discusses potential health effects from exposures during the period from conception to maturity at 18 years of age in humans, when all biological systems will have fully developed. Potential effects on offspring resulting from exposures of parental germ cells are considered, as well as any indirect

## 3. HEALTH EFFECTS

effects on the fetus and neonate resulting from maternal exposure during gestation and lactation.

Relevant animal and *in vitro* models are also discussed.

Children are not small adults. They differ from adults in their exposures and may differ in their susceptibility to hazardous chemicals. Children's unique physiology and behavior can influence the extent of their exposure. Exposures of children are discussed in Section 6.6, Exposures of Children.

Children sometimes differ from adults in their susceptibility to hazardous chemicals, but whether there is a difference depends on the chemical (Guzelian et al. 1992; NRC 1993). Children may be more or less susceptible than adults to health effects, and the relationship may change with developmental age (Guzelian et al. 1992; NRC 1993). Vulnerability often depends on developmental stage. There are critical periods of structural and functional development during both prenatal and postnatal life and a particular structure or function will be most sensitive to disruption during its critical period(s). Damage may not be evident until a later stage of development. There are often differences in pharmacokinetics and metabolism between children and adults. For example, absorption may be different in neonates because of the immaturity of their gastrointestinal tract and their larger skin surface area in proportion to body weight (Morselli et al. 1980; NRC 1993); the gastrointestinal absorption of lead is greatest in infants and young children (Ziegler et al. 1978). Distribution of xenobiotics may be different; for example, infants have a larger proportion of their bodies as extracellular water and their brains and livers are proportionately larger (Altman and Dittmer 1974; Fomon 1966; Fomon et al. 1982; Owen and Brozek 1966; Widdowson and Dickerson 1964). The infant also has an immature blood-brain barrier (Adinolfi 1985; Johanson 1980) and probably an immature blood-testis barrier (Setchell and Waites 1975). Many xenobiotic metabolizing enzymes have distinctive developmental patterns. At various stages of growth and development, levels of particular enzymes may be higher or lower than those of adults, and sometimes unique enzymes may exist at particular developmental stages (Komori et al. 1990; Leeder and Kearns 1997; NRC 1993; Vieira et al. 1996). Whether differences in xenobiotic metabolism make the child more or less susceptible also depends on whether the relevant enzymes are involved in activation of the parent compound to its toxic form or in detoxification. There may also be differences in excretion, particularly in newborns who all have a low glomerular filtration rate and have not developed efficient tubular secretion and resorption capacities (Altman and Dittmer 1974; NRC 1993; West et al. 1948). Children and adults may differ in their capacity to repair damage from chemical insults. Children also have a longer remaining lifetime in which to express damage from chemicals; this potential is particularly relevant to cancer.

## 3. HEALTH EFFECTS

Certain characteristics of the developing human may increase exposure or susceptibility, whereas others may decrease susceptibility to the same chemical. For example, although infants breathe more air per kilogram of body weight than adults breathe, this difference might be somewhat counterbalanced by their alveoli being less developed, which results in a disproportionately smaller surface area for alveolar absorption (NRC 1993).

There are limited data on the toxicity of bromoform and dibromochloromethane. In the early 1900s, bromoform was used as a sedative for the treatment of whooping cough (Benson 1907; Burton-Fanning 1901; Dwelle 1903; Stokes 1900; von Oettingen 1955). Sedation was observed at the prescribed dosage; higher doses often resulted in central nervous system depression. Central nervous system depression has also been observed in adult animals following oral exposure to bromoform (Bowman et al. 1978; NTP 1989a) or dibromochloromethane (Bowman et al. 1978; NTP 1985). There is no indication that children are more susceptible than adults to this effect.

Animal data provide strong evidence that the liver is the critical target of bromoform and dibromochloromethane toxicity (Aida et al. 1992; Coffin et al. 2000; Condie et al. 1983; NTP 1985, 1989a; Tobe et al. 1982). These animal studies were conducted in adults and no animal studies using juveniles were located. The available data suggest that the hepatotoxicity of bromoform and dibromochloromethane is due to tissue damage from reactive intermediates that are generated during metabolism. In rats, trihalomethanes are substrates for several cytochrome P-450 enzyme isoforms, including CYP2E1, CYP2B1, CYP2B2, and CYP1A2 (Allis et al. 2001; Pankow et al. 1997) in Phase I reactions and glutathione S-transferase theta (GSTT) (DeMarini et al. 1997; Pegram et al. 1987; Ross and Pegram 2003) in Phase II reactions. As discussed in EPA (2001a), CYP2E1 levels increase rapidly during the first 24 hours after birth and levels in children between 1 and 10 years of age are similar to those in adults. Similarly, GSTT levels in children older than 1 year are similar to adults. These data provide some suggestive evidence that exposure during early childhood would result in the formation of similar reactive intermediates and metabolites as in adults.

The potential of bromoform and dibromochloromethane to induce developmental effects cannot be conclusively established from the existing database. A significant alteration in the occurrence of sternebra aberrations were observed in the offspring of rats administered 200 mg/kg/day bromoform in corn oil during gestation (Ruddick et al. 1983). A similar exposure to dibromochloromethane did not result in any significant alterations. Similarly, no developmental alterations were observed in mouse

### 3. HEALTH EFFECTS

offspring exposed to 685 mg/kg/day dibromochloromethane in drinking water for several generations (Borzelleca and Carchman 1982).

There are no specific biomarkers of exposure or effect for bromoform or dibromochloromethane that have been validated in children or adults exposed as children. No studies were located regarding interactions of bromoform or dibromochloromethane with other chemicals in children. Additionally, there are no pediatric-specific methods of reducing peak absorption or reducing body burden following exposure to bromoform or dibromochloromethane. In the absence of these data, it is assumed that there are no age-related differences in biomarkers, interactions, or mitigation of effects.

#### **3.8 BIOMARKERS OF EXPOSURE AND EFFECT**

Biomarkers are broadly defined as indicators signaling events in biologic systems or samples. They have been classified as markers of exposure, markers of effect, and markers of susceptibility (NAS/NRC 1989).

Due to a nascent understanding of the use and interpretation of biomarkers, implementation of biomarkers as tools of exposure in the general population is very limited. A biomarker of exposure is a xenobiotic substance or its metabolite(s) or the product of an interaction between a xenobiotic agent and some target molecule(s) or cell(s) that is measured within a compartment of an organism (NAS/NRC 1989). The preferred biomarkers of exposure are generally the substance itself or substance-specific metabolites in readily obtainable body fluid(s) or excreta. However, several factors can confound the use and interpretation of biomarkers of exposure. The body burden of a substance may be the result of exposures from more than one source. The substance being measured may be a metabolite of another xenobiotic substance (e.g., high urinary levels of phenol can result from exposure to several different aromatic compounds). Depending on the properties of the substance (e.g., biologic half-life) and environmental conditions (e.g., duration and route of exposure), the substance and all of its metabolites may have left the body by the time samples can be taken. It may be difficult to identify individuals exposed to hazardous substances that are commonly found in body tissues and fluids (e.g., essential mineral nutrients such as copper, zinc, and selenium). Biomarkers of exposure to bromoform and dibromochloromethane are discussed in Section 3.8.1.

Biomarkers of effect are defined as any measurable biochemical, physiologic, or other alteration within an organism that, depending on magnitude, can be recognized as an established or potential health

### 3. HEALTH EFFECTS

impairment or disease (NAS/NRC 1989). This definition encompasses biochemical or cellular signals of tissue dysfunction (e.g., increased liver enzyme activity or pathologic changes in female genital epithelial cells), as well as physiologic signs of dysfunction such as increased blood pressure or decreased lung capacity. Note that these markers are not often substance specific. They also may not be directly adverse, but can indicate potential health impairment (e.g., DNA adducts). Biomarkers of effects caused by bromoform and dibromochloromethane are discussed in Section 3.8.2.

A biomarker of susceptibility is an indicator of an inherent or acquired limitation of an organism's ability to respond to the challenge of exposure to a specific xenobiotic substance. It can be an intrinsic genetic or other characteristic or a preexisting disease that results in an increase in absorbed dose, a decrease in the biologically effective dose, or a target tissue response. If biomarkers of susceptibility exist, they are discussed in Section 3.10 "Populations that are Unusually Susceptible."

#### **3.8.1 Biomarkers Used to Identify or Quantify Exposure to Bromoform and Dibromochloromethane**

The most straightforward means of identifying exposure to bromoform or dibromochloromethane in a person is measurement of parent compound in blood or expired air. Sensitive and specific gas chromatographic-mass spectrophotometric methods available for this purpose are described in Section 7.1. Quantification of exposure is complicated by the relatively rapid clearance rate of these compounds from the body, both by exhalation and metabolic breakdown. Data are not available on clearance rates in humans, but in animals, clearance of parent is nearly complete within 8 hours (see Section 3.4.4). Consequently, this approach is best suited for detecting recent exposures (within 1–2 days).

No data are available on blood or breath levels of bromoform or dibromochloromethane in acutely exposed individuals. However, studies involving exposure to trihalomethanes in water have found elevated alveolar air levels of dibromochloromethane following a 1-hour exposure to volatilized trihalomethanes from swimming pool water (Aggazzotti et al. 1998) and elevated blood bromoform and dibromochloromethane levels following a 10-minute shower or 10-minute bath (Backer et al. 2000). Background concentrations in people not exposed to bromoform or dibromochloromethane except through chlorinated drinking water are about 0.6 ppb (Antoine et al. 1986), while levels in expired breath are undetectable (Wallace et al. 1986a, 1986b). In a study of blood trihalomethane concentrations in women living in areas with trihalomethane in tap water (Miles et al. 2002), a simple linear relationship

### 3. HEALTH EFFECTS

between blood levels and tap water levels of trihalomethanes was not found. For bromoform and dibromochloromethane, no significant correlations were found between tap water levels of these compounds and blood levels before showering. After showering, a significant correlation between bromoform levels in the tap water and blood levels were found; however, the correlation coefficient (0.450) is relatively low, suggesting that a number of variables affected blood bromoform levels. Although bromoform and dibromochloromethane are lipophilic, they do not appear to accumulate in adipose tissue (Stanley 1986), so measurement of parent levels in this tissue is not likely to be valuable as a biomarker of exposure.

The principal metabolites of bromoform and dibromochloromethane are  $\text{CO}_2$ ,  $\text{CO}$ ,  $\text{Cl}^-$ , and  $\text{Br}^-$ . None of these metabolites are sufficiently specific to be useful as a biomarker of exposure. It is suspected that reactive intermediates formed during metabolism may produce covalent adducts with proteins or other cellular macromolecules (see Section 3.4.3), but these putative adducts have not been identified nor has any means for their quantification been developed.

#### **3.8.2 Biomarkers Used to Characterize Effects Caused by Bromoform and Dibromochloromethane**

There are limited data on the toxicity of bromoform and dibromochloromethane in humans. Exposure to bromoform can result in sedation; it is likely that the same is true for dibromochloromethane. However, generalized central nervous system depression is too nonspecific to be useful as a biomarker of effects from bromoform or dibromochloromethane exposure. Studies in animals indicate the liver and the kidneys are also affected, resulting in fatty liver, increased serum enzyme levels, and nephrosis. Effects on liver and kidney can be evaluated using a variety of laboratory and clinical tests (CDC/ATSDR 1990), but these are also too nonspecific to be valuable in recognizing early effects caused by low level exposure to these two chemicals.

### **3.9 INTERACTIONS WITH OTHER CHEMICALS**

It is well-known that exposure to alcohols, ketones, and a variety of other substances can dramatically increase the acute toxicity of halomethanes such as carbon tetrachloride (Agency for Toxic Substances and Disease Registry 1994) and chloroform (Agency for Toxic Substances and Disease Registry 1997).



## 3. HEALTH EFFECTS

Several studies have been performed to determine if the toxic effects of bromoform and dibromochloromethane are similarly affected by these agents.

Hewitt et al. (1983) found that pretreatment of rats with a single oral dose of acetone resulted in a 10–40-fold potentiation of the hepatotoxic effects of a single oral dose of dibromochloromethane given 18 hours later. Similarly, pretreatment of rats for one to three days with chlordecone resulted in a 7–60-fold potentiation of the hepatotoxic effects of a single oral dose of dibromochloromethane (Plaa and Hewitt 1982a, 1982b). In contrast, chlordecone pretreatment had relatively little potentiating effect on the hepatotoxicity of bromoform (Agarwal and Mehendale 1983; Plaa and Hewitt 1982a).

The mechanism by which chemicals such as acetone and chlordecone potentiate halomethane toxicity is not known, but it is generally considered that at least some of the effect is due to stimulation of metabolic pathways that yield toxic intermediates. If so, the findings above support the hypothesis that the toxicity of dibromochloromethane is mediated at least in part by metabolic generation of reactive intermediates, but that metabolism is relatively less important in bromoform toxicity.

Harris et al. (1982) found that exposure of rats to a combination of bromoform and carbon tetrachloride resulted in more liver injury (judged by release of hepatic enzymes into serum) than would be predicted by the effects of each chemical acting alone. The mechanism of this interaction is not certain, but may be related to dihalocarbonyl formation and lipid peroxidation (Harris et al. 1982).

A PBPK model has been developed by da Silva et al. (1999) that examined the influence of exposure to a mixture of trihalomethanes (bromoform, dibromochloromethane, dichlorobromomethane, and chloroform) on the kinetics of individual compounds. When all four trihalomethanes were administered together (1.0 mmol/kg), the area under the blood concentration versus time curve was significantly higher as compared to the AUC after administration of a single compound (0.25 mmol/kg). For bromoform and dibromochloromethane, the AUCs after the single 0.25 mmol/kg dose were 48.6 and 31.2  $\mu\text{M}/\text{hour}$  and after the 1.0 mmol/kg mixture of trihalomethanes, the AUCs were 127.3 and 128.6  $\mu\text{M}/\text{hour}$ . These data suggest that there is metabolic interaction between the trihalomethanes; likely competitive inhibition of hepatic metabolism.

## 3. HEALTH EFFECTS

**3.10 POPULATIONS THAT ARE UNUSUALLY SUSCEPTIBLE**

A susceptible population will exhibit a different or enhanced response to bromoform or dibromochloromethane than will most persons exposed to the same level of bromoform or dibromochloromethane in the environment. Reasons may include genetic makeup, age, health and nutritional status, and exposure to other toxic substances (e.g., cigarette smoke). These parameters result in reduced detoxification or excretion of bromoform or dibromochloromethane, or compromised function of organs affected by bromoform or dibromochloromethane. Populations who are at greater risk due to their unusually high exposure to bromoform or dibromochloromethane are discussed in Section 6.7, Populations with Potentially High Exposures.

Studies of bromoform and dibromochloromethane toxicity in animals suggest that there may be some quantitative and qualitative differences in susceptibility between sexes and between species (see Section 3.2). The mechanistic basis for these differences is not known, but one likely factor is sex and species-dependent differences in metabolism (see Section 3.4.3). Thus, it is reasonable to assume that differences in susceptibility could exist between humans as a function of sex, age, or other metabolism-influencing factors. Studies in animals (discussed in Section 3.9) also suggest that humans exposed to alcohols, ketones, or other drugs (e.g., barbiturates, anticoagulants) that influence halomethane metabolism might be more susceptible to the toxic effect of dibromochloromethane and perhaps bromoform as well. Persons with existing renal or hepatic disease might also be more susceptible, since these organs are adversely affected by exposure to bromoform and dibromochloromethane. The elderly may represent an unusually susceptible population because they may have age-related deficiencies of liver and kidney function. They may also be frequently exposed to metabolism-influencing medications.

**3.11 METHODS FOR REDUCING TOXIC EFFECTS**

This section will describe clinical practice and research concerning methods for reducing toxic effects of exposure to bromoform or dibromochloromethane. However, because some of the treatments discussed may be experimental and unproven, this section should not be used as a guide for treatment of exposures to bromoform or dibromochloromethane. When specific exposures have occurred, poison control centers and medical toxicologists should be consulted for medical advice. The following texts provide specific information about treatment following exposures to bromoform or dibromochloromethane:

## 3. HEALTH EFFECTS

Haddad LM, Shannon MW, Winchester JF, eds. 1998. *Clinical management of poisoning and drug overdose*. Philadelphia, PA: W.B. Saunders Co., 913-939, 992-1000.

Viccellio P, ed. 1998. *Emergency toxicology*. Philadelphia, PA: Lippincott-Raven Publishers, 925-932.

### 3.11.1 Reducing Peak Absorption Following Exposure

Human exposure to bromoform or dibromochloromethane may occur by inhalation, ingestion, or dermal contact. General recommendations for reducing absorption of these chemicals include removing the exposed individual from the contaminated area and removing the contaminated clothing. If the eyes and skin were exposed, they should be flushed with water. In order to reduce absorption of ingested bromoform and dibromochloromethane, emesis may be considered unless the patient is comatose, is convulsing, or has lost the gag reflex. Controversy exists concerning use of emesis because of the rapid onset of central nervous system depression, the risk of aspiration of stomach contents into the lungs, and the relative ineffectiveness of this method. In comatose patients with absent gag reflexes, an endotracheal intubation may be performed in advance to reduce the risk of aspiration pneumonia. Gastric lavage may also be used.

### 3.11.2 Reducing Body Burden

Trihalomethanes levels in human blood have a short half-life of approximately 0.5 hours (Lynberg et al. 2001). Bromoform or dibromochloromethane were not stored to any appreciable extent in the rat and were mostly metabolized to CO<sub>2</sub> (see Section 3.4). The elimination half-life of bromoform was reported to be 0.8 hours in the rat and 8 hours in the mouse (Mink et al. 1986). The half-lives of dibromochloromethane were 1.2 and 2.5 hours in rats and mice, respectively (Mink et al. 1986). Despite an expected relatively fast clearance of from the body, toxic effects may develop in exposed individuals. No method is commonly practiced to enhance the elimination of the absorbed dose of bromoform or dibromochloromethane.

### 3.11.3 Interfering with the Mechanism of Action for Toxic Effects

The primary targets of bromoform and dibromochloromethane are the liver, kidneys, and central nervous system. It is believed that the mechanism of bromoform and dibromochloromethane toxicity to the liver and kidneys involves metabolism to reactive intermediates. No methods for interfering with the

### 3. HEALTH EFFECTS

mechanism of action have been developed for these compounds. Studies using two other trihalomethanes (chloroform and dichlorobromomethane) provide suggestive evidence that administration of agents which inhibit cytochrome P-450 decreases hepatotoxicity. Co-administration of chloroform and 1-aminobenzotriazole (an irreversible cytochrome P-450 inhibitor) (Constan et al. 1999) or dibromochloromethane and a CYP2E1 inhibitor (Thornton-Manning et al. 1994) resulted a reduction of acute hepatic and renal toxicity.

#### **3.12 ADEQUACY OF THE DATABASE**

Section 104(i)(5) of CERCLA, as amended, directs the Administrator of ATSDR (in consultation with the Administrator of EPA and agencies and programs of the Public Health Service) to assess whether adequate information on the health effects of bromoform or dibromochloromethane is available. Where adequate information is not available, ATSDR, in conjunction with the National Toxicology Program (NTP), is required to assure the initiation of a program of research designed to determine the health effects (and techniques for developing methods to determine such health effects) of bromoform or dibromochloromethane.

The following categories of possible data needs have been identified by a joint team of scientists from ATSDR, NTP, and EPA. They are defined as substance-specific informational needs that if met would reduce the uncertainties of human health assessment. This definition should not be interpreted to mean that all data needs discussed in this section must be filled. In the future, the identified data needs will be evaluated and prioritized, and a substance-specific research agenda will be proposed.

##### **3.12.1 Existing Information on Health Effects of Bromoform and Dibromochloromethane**

The existing data on health effects of inhalation, oral, and dermal exposure of humans and animals to bromoform and dibromochloromethane are summarized in Figures 3-6 and 3-7, respectively. The purpose of this figure is to illustrate the existing information concerning the health effects of bromoform or dibromochloromethane. Each dot in the figure indicates that one or more studies provide information associated with that particular effect. The dot does not necessarily imply anything about the quality of the study or studies, nor should missing information in this figure be interpreted as a "data need". A data need, as defined in ATSDR's Decision Guide for Identifying Substance-Specific Data Needs Related to Toxicological Profiles (Agency for Toxic Substances and Disease Registry 1989), is substance-specific

3. HEALTH EFFECTS

**Figure 3-6. Existing Information on Health Effects of Bromoform**

	Systemic									
	Death	Acute	Intermediate	Chronic	Immunologic/Lymphoretic	Neurologic	Reproductive	Developmental	Genotoxic	Cancer
Inhalation										
Oral	●					●				
Dermal										

**Human**

	Systemic									
	Death	Acute	Intermediate	Chronic	Immunologic/Lymphoretic	Neurologic	Reproductive	Developmental	Genotoxic	Cancer
Inhalation	●	●	●			●				
Oral	●	●	●	●	●	●	●	●	●	●
Dermal										

**Animal**

● Existing Studies

3. HEALTH EFFECTS

Figure 3-7. Existing Information on Health Effects of Dibromochloromethane

	Systemic									
	Death	Acute	Intermediate	Chronic	Immunologic/Lymphoretic	Neurologic	Reproductive	Developmental	Genotoxic	Cancer
Inhalation										
Oral										
Dermal										

Human

	Systemic									
	Death	Acute	Intermediate	Chronic	Immunologic/Lymphoretic	Neurologic	Reproductive	Developmental	Genotoxic	Cancer
Inhalation										
Oral	●	●	●	●	●	●	●	●	●	●
Dermal										

Animal

● Existing Studies

### 3. HEALTH EFFECTS

information necessary to conduct comprehensive public health assessments. Generally, ATSDR defines a data gap more broadly as any substance-specific information missing from the scientific literature.

As shown in Figure 3-6, there are limited data on the toxicity of bromoform following inhalation exposure. No human data were located and laboratory animal studies are limited to lethality studies, which found central nervous system depression, and acute and intermediate duration studies, which are only available as abstracts. Human data on the oral toxicity of bromoform are limited to reports of children taking bromoform for the treatment of whooping cough; effects are limited to death and central nervous system depression and the exposure levels are poorly characterized. A number of laboratory animal studies have examined the oral toxicity of bromoform, and data are available for all end points. However, in many cases, the available data for a particular end point are limited to a single study or use a route of administration (e.g., gavage) that may not be relevant to human environmental exposure to bromoform. The dermal toxicity of bromoform has not been studied in humans or animals.

As shown in Figure 3-7, there are no human toxicity data for dibromochloromethane following inhalation, oral, or dermal exposure. Additionally, there are no laboratory animal data on dibromochloromethane following inhalation or dermal exposure. For the oral route of exposure, data are available for all end points. As noted for bromoform, information on a particular end point comes from a single study, and most studies used a gavage in oil administration route, which may not be relevant for human environmental exposure to dibromochloromethane.

#### 3.12.2 Identification of Data Needs

**Acute-Duration Exposure.** The available data on the acute toxicity of bromoform in humans are limited to reports of children prescribed bromoform for the treatment of whooping cough. Following ingestion, the children were said to sleep undisturbed through the night, suggestive of sedation (Dwelle 1903); accidental overdoses resulted in symptoms of central nervous system depression (Benson 1907; Burton-Fanning 1901; Dwelle 1903; Stokes 1900; von Oettingen 1955). No human data were located discussing human toxicity following inhalation or dermal exposure to bromoform or after inhalation, oral, or dermal exposure to dibromochloromethane. Inhalation and oral exposure animal studies confirm that high oral doses of bromoform (Balster and Borzelleca 1982; Bowman et al. 1978; Graham 1915; Mertzbach 1928; NTP 1989a) or dibromochloromethane (Balster and Borzelleca 1982; NTP 1985) can result in central nervous system depression. At lower doses, the liver and possibly the kidney appear to be the primary targets of toxicity for both compounds. Nonlethal animal inhalation data are limited to a

## 3. HEALTH EFFECTS

study published in Russian that found liver and kidney effects in rats (Dykan 1964). The inhalation data are inadequate to define the threshold for these effects or identify the critical target of toxicity; additional inhalation studies that examine a wide range of end points and exposure concentrations would be useful for establishing the critical targets of toxicity of bromoform and dibromochloromethane following inhalation exposure and establishing concentration-response relationships. There is a more extensive database following oral exposure, which allows for the derivation of acute-duration oral MRLs for bromoform and dibromochloromethane. Following oral exposure to bromoform, increases in liver weight (Munson et al. 1982), centrilobular pallor (Condie et al. 1983), and hepatocellular vacuolization and/or swelling (Coffin et al. 2000) have been observed. Other effects of bromoform observed in acute-duration animal studies include mesangial nephrosis (Condie et al. 1983), impaired humoral immune function (Munson et al. 1982), and developmental effects (Ruddick et al. 1983). As with bromoform, the most sensitive effects of dibromochloromethane following acute oral exposure are liver and kidney damage; the liver effects consisted of mottled liver, hepatocellular vacuolization and/or swelling, and increases in SGPT and SGOT levels (Coffin et al. 2000; Condie et al. 1983; Munson et al. 1982; NTP 1985) and kidney effects included mesangial hyperplasia and darkened renal medullae (Condie et al. 1983; NTP 1985). At higher doses, impaired humoral immunity (Munson et al. 1982), decreased body weight gain (NTP 1985; Potter et al. 1996), and decreased serum testosterone levels (Potter et al. 1996) were observed.

No data are available in humans or animals following dermal exposure to bromoform or dibromochloromethane. Contact with concentrated solutions of these chemicals might be expected to produce effects similar to those following ingestion or inhalation, and might also result in skin or eye irritation. Studies on this would be useful, although contact with concentrated bromoform or dibromochloromethane is considered extremely unlikely for members of the general population or residents near waste sites. Studies on the effects of dermal contact with lower levels of the compounds in water or soil would be valuable, since people might be exposed by these routes near waste sites.

**Intermediate-Duration Exposure.** No human data are available on the intermediate-duration toxicity of bromoform or dibromochloromethane following inhalation, oral, or dermal exposure. Animal data are limited to a study reporting liver and kidney effects in rats exposed to bromoform for 2 months (Dykan 1962); however, this study is currently only available as an abstract. No intermediate-duration animal inhalation exposure data are available for dibromochloromethane. Further studies on the intermediate-duration inhalation toxicity of these compounds would be valuable in assessing human health risks from airborne exposures near waste sites, although available data suggest that exposures in air



## 3. HEALTH EFFECTS

near such sites are likely to be low. The available intermediate-duration oral exposure animal studies strongly identify the liver as the most sensitive target for bromoform and dibromochloromethane. Hepatocellular vacuolization and/or swelling have been observed at the lowest adverse effect levels (Aida et al. 1992; Daniel et al. 1990; NTP 1985, 1989a). Other effects observed in animals exposed to higher doses of bromoform include lethargy (NTP 1989a), impaired performance on neurobehavioral tests (Balster and Borzelleca 1982), and decreased body weight gain (Aida et al. 1992). Exposure to higher doses of dibromochloromethane also resulted in kidney damage (tubular degeneration and nephropathy) (Daniel et al. 1990; NTP 1985), impaired performance on neurobehavioral tests (Balster and Borzelleca 1982), and impaired fertility (Borzelleca and Carchman 1982). These animal data were considered adequate for derivation of an intermediate MRL for bromoform. An MRL was not derived for dibromochloromethane because the resultant MRL would be higher than the MRL for acute duration exposure. Additional studies using a number of dose levels would provide additional information on the threshold of hepatic toxicity and possible allow for the derivation of an intermediate-duration MRL for dibromochloromethane. There are no data on dermal exposure, and studies on intermediate-duration dermal exposure to the compounds in water or soil would be useful in evaluating human health risk at waste sites

**Chronic-Duration Exposure and Cancer.** No human studies examining the chronic toxicity of bromoform or dibromochloromethane were located, although a number of studies examining health outcomes in areas with elevated trihalomethanes in tap water have been located. Chronic animal inhalation data are not available for either chemical, and would be useful, especially for dibromochloromethane, since it is significantly more volatile (vapor pressure=76 mmHg) than bromoform (vapor pressure=5 mmHg). Chronic-duration studies that identify the critical targets of toxicity and establish concentration-response relationships would be useful for deriving chronic-duration inhalation MRLs for bromoform and dibromochloromethane. In the absence of such data, extrapolation of observations from the oral route might be possible using appropriate toxicokinetic models. The chronic oral toxicity of bromoform (NTP 1989a; Tobe et al. 1982) and dibromochloromethane (NTP 1985; Tobe et al. 1982) has been investigated in several studies, and the data are sufficient to identify hepatotoxicity as the most sensitive end point and to derive MRL values for both chemicals. However, in both cases, chronic oral MRLs are based on LOAELs for hepatotoxicity, so further studies to define the NOAELs would be helpful in reducing uncertainty in the MRL calculations. No data exist for dermal exposure, and further studies (focusing on exposure in water or soil) would be valuable.

## 3. HEALTH EFFECTS

The carcinogenic effects of chronic oral exposure to bromoform (NTP 1989a) and dibromochloromethane (NTP 1985) have been investigated in well designed studies in both rats and mice, and the data suggest that both chemicals have carcinogenic potential. However, effects were limited or equivocal in some cases, so additional studies to strengthen the weight of evidence would be valuable. Of particular interest would be studies of the carcinogenic effects when exposure is via drinking water rather than by gavage, since drinking water is the most likely route of human exposure, and exposure by gavage (especially using oil as a medium) may not be a good model for this. Also of value would be studies on the mechanism of carcinogenicity and on the identity of carcinogenic metabolites. For example, studies on methylene chloride and other volatile halocarbons indicate that metabolism via a glutathione pathway may be important in carcinogenicity (e.g., Anderson et al. 1987; Reitz et al. 1989). Studies to determine if dibromochloromethane or bromoform are metabolized by a similar pathway would be helpful in evaluating carcinogenic mechanism and risk.

**Genotoxicity.** There have been a number of studies that indicate bromoform and dibromochloromethane are genotoxic, both in prokaryotic (LeCurieux et al. 1995; Roldan-Arjona and Pueyo 1993; Simmon and Tardiff 1978; Simmon et al. 1977; Varma et al. 1988) and eukaryotic (Benigni et al. 1993; Fujie et al. 1993; Landi et al. 1999; Matsuoka et al. 1996; McGregor et al. 1991; Morimoto and Koizumi 1983; Nestman and Lee 1985; Sobti 1984; Sofuni et al. 1996) organisms. However, a number of other studies have failed to detect significant genotoxic potential for these compounds (Maddock and Kelly 1980; NTP 1985, 1989a). The basis for this inconsistency is not entirely obvious, but might be related to the efficacy of the test system to activate the parent compound to genotoxic metabolites. Several *in vivo* studies have also found genotoxic effects following exposure to bromoform (Fujie et al. 1990; Morimoto and Koizumi 1983; NTP 1989a) or dibromochloromethane (Fujie et al. 1990; Morimoto and Koizumi 1983), although other studies have not found effects (Hayashi et al. 1988; Potter et al. 1996; Stocker et al. 1996). Further studies to define conditions under which these compounds are and are not genotoxic *in vitro* and *in vivo* may help clarify both the mechanism of genotoxicity and the relevance of this to human health risk. Studies on the genotoxic effects of bromoform and dibromochloromethane on germ cells (sperm or ova) would also be valuable.

**Reproductive Toxicity.** A number of ecological studies have examined the reproductive toxicity to women ingesting drinking water contaminated with trihalomethanes (Bove et al. 1992, 1995; Dodds et al. 1999; Kramer et al. 1992; Mills et al. 1998; Nieuwenhuijsen et al. 2000; Savitz et al. 1995; Waller et al. 1999). Three of these studies (Kramer et al. 1992; Waller et al. 1999; Windham et al. 2003) measured bromoform and dibromochloromethane levels; however, the contribution of the other trihalomethanes to

## 3. HEALTH EFFECTS

the observed effects cannot be determined from the existing data. Collectively, the trihalomethane studies provide insufficient evidence to establish a causal relationship between exposure to trihalomethanes and adverse reproductive outcome. Animal data are limited to several studies that examined reproductive tissues for histological alterations or examined reproductive function following oral exposure to either compound. No histological alterations were observed in reproductive tissues following chronic exposure to bromoform (NTP 1989a) or dibromochloromethane (NTP 1985). No significant alterations in reproductive performance or fertility were observed in males or females exposed to bromoform (NTP 1989b). For dibromochloromethane, one study found a marked reduction in fertility at a maternally toxic dose level (Borzelleca and Carchman 1982), but no effects on reproductive performance or fertility were observed at lower doses (NTP 1986). Multigeneration studies involving oral exposure to bromoform and dibromochloromethane would provide useful data on the reproductive potential of these chemicals. Based on the oral studies, it does not seem likely that effects would occur following inhalation or dermal exposure except at very high levels, but inhalation and dermal exposure studies to confirm this important point would be valuable.

**Developmental Toxicity.** Several ecological studies have examined the relationship between exposure to trihalomethanes in tap water and the birth outcomes (Dodds et al. 1999; Kramer et al. 1992; Savitz et al. 1995). The Kramer et al. (1992) study reported levels for individual trihalomethanes, but this study, as well as the other studies, does not provide sufficient evidence for establishing a relationship between trihalomethane exposure and adverse birth outcomes. No other human studies were located for bromoform or dibromochloromethane. No inhalation or dermal exposure animal developmental toxicity studies were located. There are limited data on the developmental toxicity of bromoform and dibromochloromethane following oral exposure in animals. A minor skeletal abnormality was observed in the offspring of rats exposed to bromoform during gestation (Ruddick et al. 1983). No developmental effects were observed in studies of rat and mouse offspring exposed to dibromochloromethane (Borzelleca and Carchman 1982; Ruddick et al. 1983). Additional oral studies on the developmental effects of both bromoform and dibromochloromethane in animals would be valuable to determine whether these skeletal abnormalities are produced consistently, and whether they lead to significant adverse effects in the neonate. If so, then similar studies by the inhalation and dermal routes would also be valuable to define safe inhalation levels for developmental effects.

**Immunotoxicity.** The immunotoxic effects of bromoform and dibromochloromethane have been investigated in one 14-day oral study (Munson et al. 1982). That study indicated that both chemicals can lead to changes in several immune cell-types in mice. Similar studies in other species would be valuable

### 3. HEALTH EFFECTS

in determining if this is a common response. In addition, longer duration studies and tests of the functional consequence of these changes (e.g., resistance to infectious disease) would be especially valuable in assessing the biological significance of these effects. If these studies indicate the immune system is a target, then similar studies by inhalation and dermal exposure routes would also be valuable.

**Neurotoxicity.** Numerous studies, both in humans and animals, reveal that central nervous system depression is a rapid effect following either oral or inhalation exposure to bromoform; more limited data indicate that dibromochloromethane also causes this effect. While central nervous system depression appears to be reversible within a short time after exposure ceases, the possibility of permanent neurological damage from high doses has not been thoroughly studied. Histological studies by NTP indicate that sub-depressant doses of bromoform (NTP 1989a) and dibromochloromethane (NTP 1985) do not lead to detectable histological changes in the brain, but similar data are not available following narcotizing doses. In addition to histological studies, functional studies capable of detecting lasting neurological changes would be valuable. One study of this sort (Balster and Borzelleca 1982) indicates that both bromoform and dibromochloromethane can cause some behavioral changes (impaired motor performance, decreased exploratory behavior [bromoform only], and decreased response rate in tests of operant behavior) at high doses. Further studies along these lines, perhaps employing more sensitive tests of electrophysiological or neurobehavioral changes, would be helpful in determining if this is an effect of concern to exposed humans.

**Epidemiological and Human Dosimetry Studies.** No epidemiological or human dosimetry studies are currently available for bromoform or dibromochloromethane. Since only very small quantities of these chemicals are produced or used in this country (see Chapter 5), it does not seem likely that a sufficiently large subpopulation of exposed workers exists to serve as the basis for a meaningful epidemiological study. Epidemiological studies of populations exposed to low levels of bromoform and dibromochloromethane in chlorinated drinking water cannot provide specific data on the human health risks of dibromochloromethane or bromoform, since chlorinated drinking water contains hundreds of different contaminants.

#### **Biomarkers of Exposure and Effect.**

**Exposure.** The only known biomarker of exposure to bromoform or dibromochloromethane is the level of parent compound in blood or in expired air. However, data on blood or breath levels in humans following acute exposure are lacking, due to the rarity of such events. Since both bromoform and

## 3. HEALTH EFFECTS

dibromochloromethane are rapidly cleared from the body by exhalation or metabolism, measurements of parent compounds in blood or breath are likely to be useful only for a short time (1–2 days) after an exposure. Monitoring of humans continuously exposed to the trace levels normally present in chlorinated water reveal very low to nondetectable levels in blood or expired air. The main metabolites of these compounds ( $\text{CO}_2$ ,  $\text{CO}$ ,  $\text{Cl}^-$ ,  $\text{Br}^-$ ) are not sufficiently specific to be useful for biomonitoring of exposure. Identification of stable and specific biomarkers of exposure (e.g., halomethyl adducts) would be valuable in evaluating the exposure history of people around waste sites and other sources where above-average levels might be encountered.

*Effect.* No specific biomarkers of bromoform- or dibromochloromethane-induced effect are known. Neurological, hepatic, and renal effects caused by these chemicals can be detected by standard clinical or biochemical tests, but abnormal function in these tissues can be produced by a number of common diseases in humans, so detection of abnormal function is not proof that the effect was caused by bromoform or dibromochloromethane. Efforts to identify more specific and sensitive biomarkers of bromoform and dibromochloromethane-induced effects would be useful, especially biomarkers (e.g., specific DNA adducts) that might be predictive of carcinogenic risk.

**Absorption, Distribution, Metabolism, Excretion.** Limited data indicate that bromoform and dibromochloromethane are rapidly and efficiently taken up from the gastrointestinal tract, but further studies to confirm and refine available estimates would be valuable. Toxicokinetic studies to date have generally employed exposure by gavage in corn oil, so studies involving exposure via an aqueous vehicle would be especially valuable. No toxicokinetic data exist for inhalation exposure, so quantitative estimates of the inhalation absorption fraction, tissue distribution, and excretion rate would be beneficial. Also, data on dermal absorption would be helpful, especially from soil or from dilute aqueous solutions, since this is how humans are most likely to experience dermal contact near waste sites.

The pathways of bromoform and dibromochloromethane metabolism have been investigated in several laboratories, but quantitative data on the amount of chemical passing through each pathway are limited, and the chemical identity of products appearing in urine has not been studied. Of particular interest would be studies that seek to clarify the role of metabolism in toxicity, the mechanism by which metabolites and adducts lead to toxic effects, and the importance of protective mechanisms such as cellular antioxidants. This would include careful dose-response studies to determine if either activating or protective pathways are saturable.

## 3. HEALTH EFFECTS

**Comparative Toxicokinetics.** Available toxicity data indicate that target tissues of bromoform and dibromochloromethane are similar in humans, rats, and mice. Limited data suggest that effect levels are generally similar across species, but some distinctions are apparent. Toxicokinetic studies have revealed differences between rats and mice regarding metabolic patterns and clearance rates and these might underlie the differences in toxicity between tissues, sexes, and species. Additional comparative studies in animals, with special emphasis on differences in metabolism, would be useful in understanding these differences, and in improving inter-species extrapolation. In addition, *in vitro* studies of metabolism by human liver cells would be valuable in determining which animal species has the most similar pattern of metabolism and is the most appropriate model for human toxicity. Data from studies of this sort could then be used to support physiologically-based toxicokinetic models.

**Methods for Reducing Toxic Effects.** Further research is needed to determine strategies designed to selectively inhibit the specific P-450 isozymes involved in the metabolism of bromoform or dibromochloromethane to reactive intermediates, and thus reduce the toxic effects. Because bromoform or dibromochloromethane are thought to be metabolized by glutathione conjugation (DeMarini et al. 1997; Pegram et al. 1977; Ross and Pegram 2003), further research is needed to determine if administration of sulfhydryl compounds, such as L-cysteine, reduced GSH or N-acetylcysteine, as glutathione surrogates might provide protection against nephrotoxicity or hepatotoxicity induced due to depleted glutathione stores. Research on using dietary supplements for mitigating adverse effects of chronic exposure to bromoform or dibromochloromethane would be helpful, especially in the case of chronic exposure from chlorinated drinking water.

**Children's Susceptibility.** Data needs relating to both prenatal and childhood exposures, and developmental effects expressed either prenatally or during childhood, are discussed in detail in the Developmental Toxicity subsection above.

The available human data for bromoform are mostly from case reports of accidental orally-administered overdose in children. No data exist on the toxicity of dibromochloromethane following oral administration in children, or of bromoform or dibromochloromethane following inhalation or dermal exposure in children. The developmental effects of oral exposure to bromoform and dibromochloromethane have not been extensively investigated, but limited data suggest that these chemicals have relatively low toxicity on the developing fetus (Borzelleca and Carchman 1982; Ruddick et al. 1983). However, these studies did not examine neurodevelopmental end points that may be a sensitive target. Additional animal studies assessing the neurodevelopmental toxicity of bromoform and dibromochloro-

### 3. HEALTH EFFECTS

methane would be useful. Toxicokinetic studies examining how aging can influence absorption rates would be useful in assessing children's susceptibility to the toxicity of bromoform or dibromochloromethane.

Child health data needs relating to exposure are discussed in Section 6.8.1, Identification of Data Needs: Exposures of Children.

#### **3.12.3 Ongoing Studies**

No ongoing studies on the health effects of bromoform or dibromochloromethane were listed in the Federal Research in Progress database (FEDRIP 2004).