

Chapter 2200 Citation of Prior Art and Reexamination of Patents

- 2201 Introduction
- 2202 Citation of Prior Art
- 2203 Persons Who May Cite Prior Art
- 2204 Time for Filing Prior Art Citations
- 2205 Content of Prior Art Citation
- 2206 Handling of Prior Art Citations
- 2207 Entry of Court Decisions in Patent Files
- 2208 Service of Citation on Patent Owner
- 2209 Reexamination
- 2210 Request for Reexamination
- 2211 Time for Requesting Reexamination
- 2212 Persons Who May File a Request
- 2213 Representative of Requester
- 2214 Content of Request
- 2215 Fee for Requesting Reexamination
- 2216 Substantial New Question of Patentability
- 2217 Statement Applying Prior Art
- 2218 Copies of Prior Art
- 2219 Copy of Printed Patent
- 2220 Certificate of Service
- 2221 Amendments Included in Request by Patent Owner
- 2222 Address of Patent Owner
- 2223 Withdrawal of Power of Attorney
- 2224 Correspondence
- 2225 Untimely Papers Filed Prior to Order
- 2226 Initial Processing of Request
- 2227 Incomplete Requests
- 2228 Informal Requests
- 2229 Notice of Request in Official Gazette
- 2230 Constructive Notice to Patent Owner
- 2231 Processing of Request Corrections
- 2232 Public Access
- 2233 Processing in Examining Group
- 2234 Entry of Amendments
- 2235 Record Systems
- 2236 Assignment of Reexamination
- 2237 Transfer Procedure
- 2238 Time Reporting
- 2239 Reexamination Ordered at Commissioner's Initiative
- 2240 Decision on Request
- 2241 Time for Deciding Request
- 2242 Criteria for Deciding Request
- 2243 Claims Considered in Deciding Request
- 2244 Prior Art on Which Determination is Based
- 2245 Processing of Decision
- 2246 Decision Ordering Reexamination
- 2247 Decision on Request for Reexamination Denied
- 2248 Petition From Denial of Request
- 2249 Patent Owner's Statement
- 2250 Amendment by Patent Owner
- 2251 Reply by Requester
- 2252 Consideration of Statement and Reply
- 2253 Consideration by examiner
- 2254 Conduct of Reexamination Proceedings
- 2255 Who Reexamines
- 2256 Prior Art Patents and Printed Publications Considered by the Examiner in Reexamination
- 2257 Listing of Prior Art
- 2258 Scope of Reexamination
- 2259 Collateral Estoppel in Reexamination Proceedings
- 2260 Office Actions
- 2261 Special Status for Action
- 2262 Form and Content of Office Action
- 2263 Time for Response
- 2264 Mailing of Office Actions
- 2265 Extension of Time
- 2266 Responses
- 2267 Handling of Inappropriate or Untimely Filed Papers
- 2268 Petitions for Entry of Late Papers
- 2269 Reconsideration
- 2270 Clerical Handling
- 2271 Final Action
- 2272 After Final Practice
- 2273 Appeal in Reexamination
- 2274 Appeal Brief
- 2275 Examiner's Answer
- 2276 Oral Hearing
- 2277 Board of Appeals Decision
- 2278 Action Following Decision
- 2279 Appeals to Courts
- 2280 Duty of Disclosure in Reexamination Proceedings
- 2281 Interviews in Reexamination Proceedings
- 2282 Notification of Existence of Prior or Concurrent Proceedings and Decisions Thereon
- 2283 Multiple Copending Reexamination Proceedings
- 2284 Copending Reexamination and Interference Proceedings
- 2285 Copending Reexamination and Reissue Proceedings

- 2286 Reexamination and Litigation Proceedings
- 2287 Conclusion of Reexamination Proceedings
- 2288 Issuance of Reexamination Certificate
- 2289 Quality Review
- 2290 Format of Certificate
- 2291 Notice of Certificate Issuance in Official Gazette
- 2292 Distribution of Certificate
- 2293 Intervening Rights

2201 Introduction [R-7]

Statutory basis for citation of prior patents or printed publications in patent files and reexamination of patents became available on July 1, 1981, as a result of new sections 301-307 of title 35 United States Code which were added by Public Law 96-517 enacted on December 12,

1980. The rules of practice in patent cases relating to reexamination were promulgated on April 30, 1981, at 46 Fed. Reg. 24179-24180 and on May 29, 1981, at 46 Fed. Reg. 29176-29187. The rules were also published in the Official Gazette at 1007 O.G. 2-3 on June 2, 1981, and at 1007 O.G. 30-41 on June 23, 1981.

This Chapter is intended to be primarily a guide for Patent and Trademark Office personnel on the processing of prior art citations and reexamination requests. Secondly, it is to also serve as a guide on the formal requirements for filing such documents in the Office.

The flow chart which follows shows the general provisions of both the citation of prior art and reexamination proceedings including reference to the pertinent rule sections.

SUMMARY OF REEXAMINATION PROVISIONS

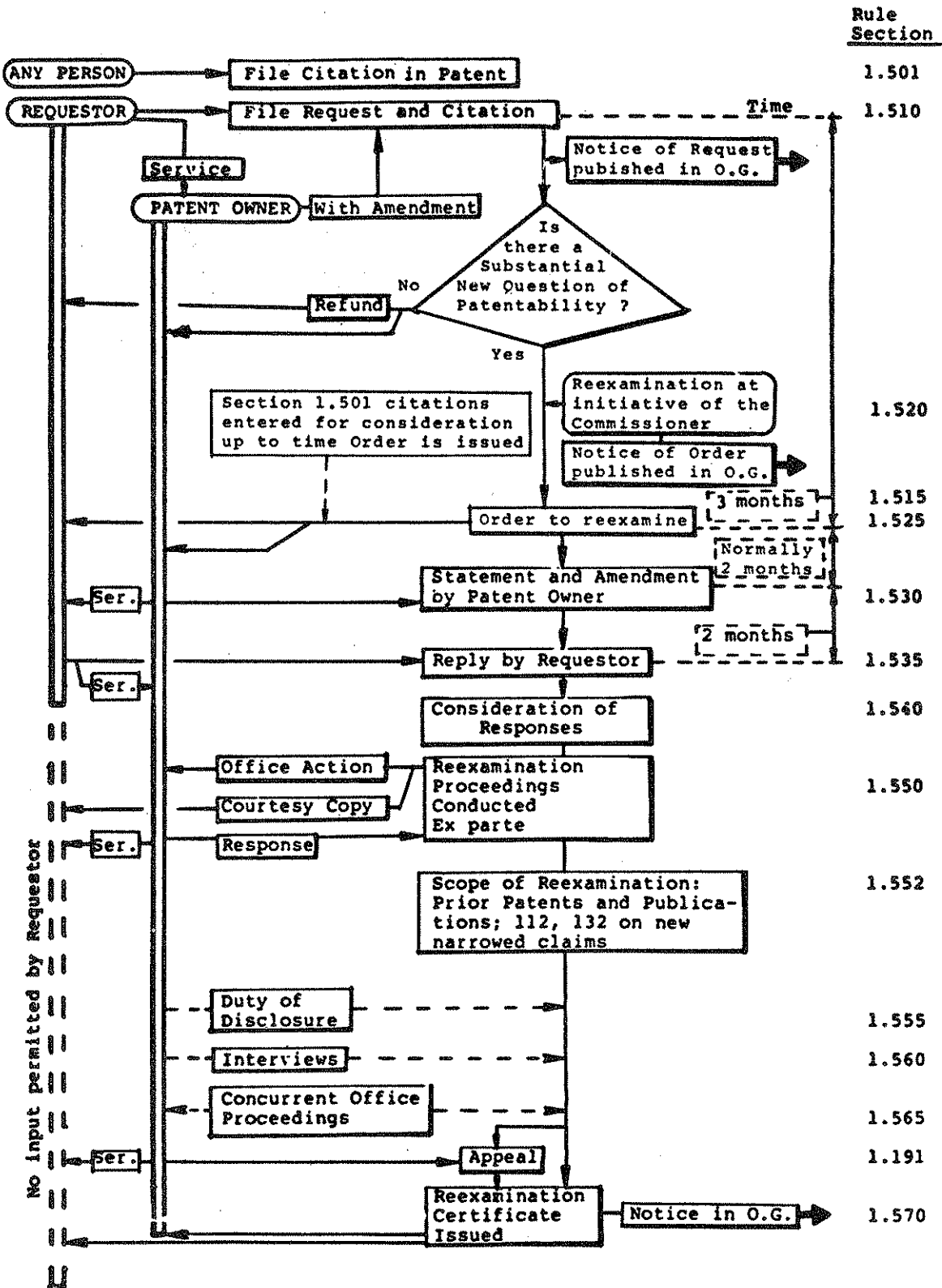

2202 Citation of Prior Art [R-7]

35 U.S.C. 301. Citation of prior art Any person at any time may cite to the Office in writing prior art consisting of patents or printed publications which that person believes to have a bearing on the patentability of any claim of a particular patent. If the person explains in writing the pertinency and manner of applying such prior art to at least one claim of the patent, the citation of such prior art and the explanation thereof will become a part of the official file of the patent. At the written request of the person citing the prior art, his or her identity will be excluded from the patent file and kept confidential.

37 CFR 1.501 Citation of prior art in patent files (a) At any time during the period of enforceability of a patent, any person may cite to the Patent and Trademark Office in writing prior art consisting of patents or printed publications which that person states to be pertinent and applicable to the patent and believes to have a bearing on the patentability of any claim of a particular patent. If the citation is made by the patent owner, the explanation of pertinency and applicability may include an explanation of how the claims differ from the prior art. Citations by the patent owner under § 1.555 and by a reexamination requester under either § 1.510 or § 1.535 will be entered in the patent file during a reexamination proceeding. The entry in the patent file of citations submitted after the date of an order to reexamine pursuant to § 1.525 by persons other than the patent owner, or a reexamination requester under either § 1.510 or § 1.535, will be delayed until the reexamination proceedings have been terminated.

(b) If the person making the citation wishes his or her identity to be excluded from the patent file and kept confidential, the citation papers must be submitted without any identification of the person making the submission.

(c) Citation of patents or printed publications by the public in patent files should either (1) reflect that a copy of the same has been mailed to the patent owner at the address as provided for in § 1.33(c); or in the event service is not possible (2) be filed with the Office in duplicate.

Prior art in the form of patents or printed publications may be cited to the Patent and Trademark Office for placement into the patent files. Such citations may be made without payment of a fee. Citations of prior art may be made separate from and without a request for reexamination.

The basic purpose for citing prior art in patent files is to inform the patent owner and the public in general that such patents or printed publications are in existence and should be considered when evaluating the validity of the patent claims. Placement of citations in the pat-

ent file along with copies of the cited prior art will also insure consideration thereof during any subsequent reissue or reexamination proceeding.

The citation of prior art provisions of 35 U.S.C. 301 and 37 CFR 1.501 do not apply to citations or protests filed in pending applications.

2203 Persons Who May Cite Prior Art [R-7]

The patent owner or any member of the public may submit prior art citations of patents or printed publications to the Patent and Trademark Office. 35 U.S.C. 301 states that "Any person at any time may cite to the Office . . ."

"Any person" may be corporate and governmental entities as well as individuals.

If a person citing prior art desires his or her identity to be kept confidential, such a person need not identify himself or herself.

"Any person" includes patentees, licensees, reexamination requesters, real parties in interest, persons without a real interest and persons acting for real parties in interest without a need to identify the real party of interest.

The statute indicates that "at the written request of the person citing the prior art, his or her identity will be excluded from the patent file and kept confidential". Although an attempt will be made to exclude any such papers from the public files, since the review will be mainly clerical in nature, complete assurance of such exclusion cannot be given. Persons citing art who desire to remain confidential are therefore advised to not identify themselves anywhere in their papers.

Confidential citations should include at least an unsigned statement indicating that the patent owner has been sent a copy of the citation papers. In the event that it is not possible to serve a copy on the patent owner, a duplicate copy should be filed with the Office.

Patent examiners should not place, or forward for placement, in the patent file any citations of prior art. Patent examiners are charged with the responsibility of making decisions as to patentability for the Commissioner. Any activity by examiners which would appear to indicate that patent claims are not patentable, outside of those cases pending before them, is considered to be inappropriate.

2204 Time for Filing Prior Art Citations [R-7]

Citations of prior art may be filed "at any time" under 35 U.S.C. 301. However, this period has been defined by rule (§ 1.501(a)) to be "any

time during the period of enforceability of a patent". The period of enforceability is the length of the term of the patent (normally 17 years for a utility patent) plus the six years under the statute of limitations for bringing an infringement action. In addition, if litigation is instituted within the period of the statute of limitations, citations may be submitted after the statute of limitations has expired, as long as the patent is still enforceable against someone. Also, while citations of prior art may be filed at any time during the period of enforceability of the patent, citations submitted after the date of any order to reexamine by persons other than the patent owner, or a reexamination requester who also submits the fee and other documents required under § 1.510, or in a response under § 1.535, will not be entered into the patent file until the pending reexamination proceedings have been terminated. (37 CFR 1.501(a)). Therefore, if prior art cited by a third party is to be considered without the payment of another reexamination fee, it must be presented before reexamination is ordered.

The purpose of this rule is to prevent harassment of the patent owner due to frequent submissions of prior art citations during reexamination proceedings.

2205 Content of Prior Art Citations [R-7]

The type of prior art which may be submitted under 35 U.S.C. 301 is limited to "written prior art consisting of patents or printed publications".

An explanation is required of how the person submitting the prior art considers it to be pertinent and applicable to the patent, as well as an explanation why it is believed that the prior art has a bearing on the patentability of any claim of the patent. Citations of prior art by patent owners may also include an explanation

of how the claims of the patent differ from the prior art cited.

It is preferred that copies of all the cited prior patents or printed publications and any necessary English translation be included so that the value of the citations may be readily determined by persons inspecting the patent files and by the examiner during any subsequent reexamination proceeding.

All prior art citations filed by persons other than the patent owner must either indicate that a copy of the citation has been mailed to, or otherwise served on, the patent owner at the correspondence address as defined under § 1.33 (c), or if for some reason service on the patent owner is not possible, a duplicate copy of the citation must be filed with the Office along with an explanation as to why the service was not possible. The most recent address of the attorney of record may be obtained from the Office's register of registered patent attorneys and agents maintained by the Office of the Solicitor pursuant to 37 CFR 1.341 and 1.347.

All citations submitted should identify the patent in which the citation is to be placed by the patent number, issue date and patentee.

A cover sheet with an identification of the patent should have firmly attached to it all other documents relating to the citation so that the documents will not become separated during processing. The documents should also contain, or have placed thereon, an identification of the patent for which they are intended.

Affidavits or declarations relating to the prior art documents submitted which explain the contents or pertinent dates in more detail may accompany the citation.

A commercial success affidavit tied in with a particular prior art document may also be acceptable.

No fee is required for the submission of citations under § 1.501.

Examples of letters submitting prior art under § 1.501 follow.

MANUAL OF PATENT EXAMINING PROCEDURE
IN THE UNITED STATES PATENT AND TRADEMARK OFFICE

In re patent of
Joseph Smith
Patent No. 4,444,444
Issued: July 7, 1977
For: Cutting Tool

Submission of Prior Art Under 37 CFR 1.501

Hon. Commissioner of Patents and Trademarks
Washington, D. C. 20231

Sir:

The undersigned herewith submits in the above identified patent the following prior art (including copies thereof) which is pertinent and applicable to the patent and is believed to have a bearing on the patentability of at least claims 1 - 3 thereof:

Weid et al	U.S. 2,585,416	April 15, 1933
McGee	U.S. 2,722,794	May 1, 1934
Paulk et al	U.S. 3,625,291	June 16, 1936

More particularly, each of the references discloses a cutting tool strikingly similar to the device of Smith in having pivotal handles with cutting blades and a pair of dies. It is felt that each of the references has a bearing on the patentability of claims 1-3 of the Smith patent.

Insofar as claims 1 and 2 are concerned, each of the references clearly anticipates the claimed subject matter under 35 USC 102.

As to claim 3, the differences between the subject matter of this claim and the cutting tool of Weid et al are shown in the device of Paulk et al. Further, Weid et al suggests that different cutting blades can be used in their device. A person of ordinary skill in the art at the time the invention was made would have been led by the suggestion of Weid et al to the cutting blades of Paulk et al as obvious substitutes for the blades of Weid et al.

Respectfully submitted,

John Jones

Pat. No 4,444,444

Certificate of Service

I hereby certify on this first day of June 1982, that a true and correct copy of the foregoing "Submission of Prior Art" was mailed by first-class mail, postage paid, to:

Joseph Smith
555 Emery Lane
Arlington, Va. 22202

John Jones



IN THE UNITED STATES PATENT AND TRADEMARK OFFICE

In re patent of
Joseph Smith
Patent No. 4,444,444
Issued: July 7, 1977
For: Cutting Tool

Submission of Prior Art Under 37 CFR 1.501

Hon. Commissioner of Patents and Trademarks
Washington, D. C. 20231

Sir:

The undersigned herewith submits in the above identified patent the following prior art (including copies thereof) which is pertinent and applicable to the patent and is believed to have a bearing on the patentability of at least claims 1 - 3 thereof:

Weid et al	U.S. 2,585,416	April 15, 1933
McGee	U.S. 2,722,794	May 1, 1934
Paulk et al	U.S. 3,625,291	June 16, 1936

More particularly, each of the references discloses a cutting tool strikingly similar to the device of Smith in having pivotal handles with cutting blades and a pair of dies. While it is felt that each of the references has a bearing on the patentability of claims 1-3 of the Smith patent, the subject matter claimed differs from the references and is believed patentable thereover.

Insofar as claims 1 and 2 are concerned, none of the references show the particular dies claimed and the structure of these claimed dies would not have been obvious to a person of ordinary skill in the art at the time the invention was made.

As to claim 3, while the cutting blades required by this claim are shown in Paulk et al, the remainder of the claimed structure is found only in Weid et al. A person of ordinary skill in the art at the time the invention was made would not have found it obvious to substitute the cutting blades of Paulk et al for those of Weid et al. In fact, the disclosure of Weid et al would lead a person of ordinary skill in the art away from the use of cutting blades such as shown in Paulk et al.

The reference to McGee, while generally similar, lacks the particular cooperation between the elements which is specifically set forth in each of claims 1-3.

Respectfully submitted,

William Green

William Green
Attorney for Patent Owner

2206 Handling of Prior Art Citations [R-7]

Prior art citations received in the Patent and Trademark Office which do not include any request for reexamination will be forwarded by the Correspondence and Mail Division to the Record Room for handling. Citations which relate to patents in which reexamination proceedings are taking place are forwarded to the examining group.

It is the responsibility of the Record Room personnel to determine whether a citation forwarded to them meets the requirements of the law and rules and to enter it into the patent file if it is proper. If the citation is not proper, (i.e., it is not limited to patents or printed publications) it will be returned, along with an explanation as to why the citation is being returned, to the address, if known, of the person making the submission. If the address of the person submitting the citation is not known because it was not supplied, the citation should be destroyed. In any case where the citation by a person other than the patent owner is not entered, the patent owner should be notified by the Record Room. Any unusual problems should be brought to the attention of the Office of the Assistant Commissioner for Patents.

Where the citation does not contain an indication of service on the patent owner and no duplicate copy is submitted to the Office, the Record Room personnel will merely notify the patent owner that a citation of prior art has been entered in the patent file. Wording similar to the following should be used:

A citation of prior art under 35 U.S.C. 301 and 37 CFR 1.501 has been filed on _____ in your patent number _____ entitled _____

This notification is being made to inform you that the citation of prior art has been placed in the file wrapper of the above identified patent.

The person submitting the prior art:

1. was not identified
2. is confidential
3. is _____

If the patent file is charged out of the Record Room by the Reexamination Preprocessing Unit or an examining group, the Record Room should promptly forward any citations to the area charged with the file. If the citation is filed after the date of an order for reexamination, the citation is retained in the examining group by the group's reexamination clerk until the examiner has finished processing the reexamination for printing of the certificate. At that time, the citations are placed in the patent file and the

file is forwarded to the Record Room. Citations filed after the date of an order for reexamination will not be considered by the examiner during the reexamination.

2207 Entry of Court Decisions in Patent Files [R-7]

The Solicitor's Office processes notices under 35 U.S.C. 290 received from the clerks of the various courts and enters them in the patent file.

It is, however, considered desirable to all parties concerned that the entire court decision be supplied to the Patent and Trademark Office for entry into the patent file. Such entry of submitted court decisions is performed by the Record Room personnel unless a reexamination proceeding is pending.

It is important for the Office to be aware of any prior court proceedings in which a patent undergoing reexamination is or was involved, and any results of such proceedings. 37 CFR 1.565(a) requires the patent owner to provide the Office with information regarding the existence of any such proceedings and the results thereof, if known. Ordinarily, no submissions of any kind by third parties filed after the date of the order are placed in the reexamination or patent file while the reexamination proceeding is pending. However, in order to ensure a complete file, with updated status information regarding prior proceedings regarding the patent under reexamination, the Office will accept at any time copies of notices of suits and other proceedings involving the patent and copies of decisions from litigations or other proceedings involving the patent from the parties involved or third parties for placement in the patent file. Persons making such submissions must limit the submission to the notification and not include further arguments or information. Any proper submission will be promptly placed of record in the patent file. See §§ 2240 and 2242 for handling of requests for reexamination of patents involved in litigation.

2208 Service of Citation on Patent Owner [R-7]

A copy of any submission of a citation of prior art patents or printed publications in a patent file should be forwarded to the patent owner so that the patent owner is fully informed as to the content of his or her patent file wrapper. See § 2206 for handling of prior art citations.

The service to the patent owner should be addressed to the correspondence address as set forth in § 1.33(c).

→ 2209 Reexamination [R-7]

Procedures for reexamination of issued patents began on July 1, 1981, the date when the reexamination provisions of Public Law 96-517 came into effect.

The reexamination statute and rules permit any person to file a request for reexamination containing certain elements and a fee of \$1500.00. The Patent and Trademark Office initially determines if "a substantial new question of patentability" (35 U.S.C. 303(a)) is presented. If such a new question has been presented, reexamination will be ordered. The reexamination proceedings are very similar to regular examination procedures in patent applications except for certain limitations as to the kind of rejections which may be made. When the reexamination proceedings are terminated, a certificate is issued which indicates the status of all claims following the reexamination.

The following sections of this Chapter explain the details of reexamination.

The intent of the reexamination procedures covered in this Chapter include the following:

1. To provide procedures for reexamination of patents.
2. To implement reexamination in an essentially ex parte manner.
3. To minimize the processing costs and complexities of reexamination.
4. To maximize respect for the reexamined patent.
5. To provide procedures for prompt and timely determinations by the Office in accordance with the "special dispatch" requirements of 35 U.S.C. 305.

The basic characteristics of reexamination are as follows:

1. Anyone can request reexamination at any time during the period of enforceability of the patent.
2. Prior art considered during reexamination is limited to prior art patents or printed publications applied under the appropriate parts of 35 U.S.C. 102 and 103.
3. A substantial new question of patentability must be presented for reexamination to be ordered.
4. If ordered, the actual reexamination proceeding is ex parte in nature.
5. Decision on the request must be made within three months from initial filing and remainder of proceedings must proceed with "special dispatch".
6. If ordered, a reexamination proceeding will be conducted to conclusion and issuance of certificate.
7. The scope of claims cannot be enlarged by amendment.

8. All reexamination and patent files are open to the public.

2210 Request for Reexamination [R-7]

35 U.S.C. 302. Request for reexamination. "Any person at any time may file a request for reexamination by the Office of any claim of a patent on the basis of any prior art cited under the provisions of section 301 of this title. The request must be in writing and must be accompanied by payment of a reexamination fee established by the Commission of Patents pursuant to the provisions of section 41 of this title. The request must set forth the pertinency and manner of applying cited prior art to every claim for which reexamination is requested. Unless the requesting person is the owner of the patent, the Commissioner promptly will send a copy of the request to the owner of record of the patent.

37 CFR 1.510 Request for reexamination. (a) Any person may, at any time during the period of enforceability of a patent, file a request for reexamination by the Patent and Trademark Office of any claim of the patent on the basis of prior art patents or printed publications cited under § 1.501. The request must be accompanied by the fee for requesting reexamination set in § 1.21(x).

(b) Any request for reexamination must include the following parts:

(1) A statement pointing out each substantial new question of patentability based on prior patents and printed publications.

(2) An identification of every claim for which reexamination is requested, and a detailed explanation of the pertinency and manner of applying the cited prior art to every claim for which reexamination is requested. If appropriate the party requesting reexamination may also point out how claims distinguish over cited prior art.

(3) A copy of every patent or printed publication relied upon or referred to in paragraph (b) (1) and (2) of this section accompanied by an English language translation of all the necessary and pertinent parts of any non-English language patent or printed publication.

(4) The entire specification (including claims) and drawings of the patent for which reexamination is requested must be furnished in the form of cut-up copies of the original patent with only a single column of the printed patent securely mounted or reproduced in permanent form on one side of a separate paper. A copy of any disclaimer, certificate of correction, or reexamination certificate issued in the patent must also be included.

(5) A certification that a copy of the request filed by a person other than the patent owner has been served in its entirety on the patent owner at the address as provided for in § 1.33(c). The name and address of the party served must be indicated. If service was not possible, a duplicate copy must be supplied to the Office.

(c) If the request does not include the fee for requesting reexamination or all of the parts required by paragraph (b) of this section, the person identified as requesting reexamination will be so notified and given an opportunity to complete the request within a specified time. If the fee for requesting reexamination has been paid but the defect in the request is not corrected within the specified time, the determination whether or not to institute reexamination will be made on the request as it then exists. If the fee for requesting reexamination has not been paid, no determination will be made and the request will be placed in the patent file as a citation if it complies with the requirements of § 1.501(a).

(d) The filing date of the request is: (1) the date on which the request including the entire fee for requesting reexamination is received in the Patent and Trademark Office; or (2) the date on which the last portion of the fee for requesting reexamination is received.

(e) A request filed by the patent owner, may include a proposed amendment in accordance with § 1.121(f).

(f) If a request is filed by an attorney or agent identifying another party on whose behalf the request is being filed, the attorney or agent must have a power of attorney from that party or be acting in a representative capacity pursuant to § 1.34(a).

Any person, at any time during the period of enforceability of a patent, may file a request for reexamination by the Patent and Trademark Office of any claim of the patent based on prior art patents or printed publications. The request must include the elements set forth in § 1.510(b) (see § 2214) and be accompanied by the fee of \$1500.00 as set forth in § 1.21(x). No attempt will be made to maintain a requester's name in confidence.

After the request for reexamination, including the entire fee for requesting reexamination, is received in the Patent and Trademark Office, no abandonment, withdrawal, or striking, of the request is possible, regardless of who requests the same.

2211 Time for Requesting Reexamination [R-7]

Under 37 CFR 1.510(a), any person may, at any time during the period of enforceability of a patent, file a request for reexamination. This period was set by rule since no useful purpose was seen for expending Office resources on deciding patent validity questions in patents which cannot be enforced. The period of enforceability is the term of the patent, normally 17 years from the issue date for utility patents, plus the 6 years after the end of the term during which infringement litigation may be instituted. In addition, if litigation is instituted within the period of the statute of limitations, requests for

reexamination may be filed after the statute of limitations has expired, as long as the patent is still enforceable against someone.

2212 Persons Who May File a Request [R-7]

35 U.S.C. 302 and 37 CFR 1.510(a) both indicate that "any person" may file a request for reexamination of a patent. Accordingly, there are no persons who are excluded from being able to seek reexamination. Corporations and/or governmental entities are included within the scope of the term "any person". The patent owner can ask for reexamination which will be limited to an ex parte consideration of prior patents or printed publications. If the patent owner wishes to have a wider consideration of issues by the Office, including matters such as prior public use or sale, the patent owner may file a reissue application. It is also possible for the Commissioner to initiate reexamination on the Commissioner's own initiative under 37 CFR 1.520. Reexamination will be initiated by the Commissioner on a very limited basis such as where a general public policy question is at issue and there is no interest by "any other person". Some of the persons likely to use reexamination are patentees, licensees, potential licensees, attorneys without identification of their real client in interest, infringers, potential exporters, patent litigants, interference applicants and International Trade Commission respondents. The persons' name who files the request will not be maintained in confidence.

2213 Representative of Requester [R-7]

Where an attorney or agent files a request for an identified client (the requester), he or she may act under either a power of attorney, or act in a representative capacity under § 1.34(a), § 1.510(f). While the filing of the power of attorney is desirable, processing of the reexamination request will not be delayed due to its absence.

If any question of authority to act is raised, proof of authority may be required by the Office.

All correspondence for a requester other than the patent owner should be addressed to the representative of the requester unless a specific indication is made to forward correspondence to another address.

If the request is filed by a person on behalf of the patent owner, correspondence will be directed to the patent owner at the address as indicated in 37 CFR 1.33(c), regardless of the address of the person filing the request. See

→ § 2222 for a discussion of who receives correspondence on behalf of a patent owner and how changes in the correspondence address are to be made.

2214 Content of Request [R-7]

§ 1.510 Request for reexamination.

"(a) Any person may, at any time during the period of enforceability of a patent, file a request for reexamination by the Patent and Trademark Office of any claim of the patent on the basis of prior art patents or printed publications cited under § 1.501. The request must be accompanied by the fee for requesting reexamination set in § 1.21(x)."

37 CFR 1.510(a) requires the payment of a \$1,500.00 fee specified in 37 CFR 1.21(x).

37 CFR 1.510(b) sets forth the required elements of a request for reexamination. The elements are as follows:

"(1) a statement pointing out each substantial new question of patentability based on prior patents and printed publications."

This statement should clearly point out what the requester considers to be the substantial new question of patentability which would warrant a reexamination. The cited prior art should be listed on a form PTO-1449 by the requester. See also § 2217.

"(2) An identification of every claim for which reexamination is requested, and a detailed explanation of the pertinency and manner of applying the cited prior art to every claim for which reexamination is requested. If appropriate the party requesting reexamination may also point out how claims distinguish over cited prior art."

The request should apply the cited prior art to every claim for which reexamination is requested. If the request is filed by the patent owner, he or she may also indicate how the claims distinguish from the cited prior art patents and printed publications.

↳ "(3) A copy of every patent or printed publication relied upon or referred to in paragraph (b)(1) and

(2) of this section accompanied by an English language translation of all the necessary and pertinent parts of any non-English language patent or printed publication." ←

A copy of each cited patent or printed publication, as well as a translation of each non-English document is required so that all materials will be available to the examiner for full consideration. See § 2218.

"(4) The entire specification (including claims) and drawings of the patent for which reexamination is requested must be furnished in the form of cut-up copies of the original patent with only a single column of the printed patent securely mounted or reproduced in permanent form on one side of a separate paper. A copy of any disclaimer, certificate of correction, or reexamination certificate issued in the patent must also be included."

A copy of the patent, for which reexamination is requested, should be provided in a single column paste-up format so that amendments can be easily entered and to ease printing. See also § 2219.

"(5) A certification that a copy of the request filed by a person other than the patent owner has been served in its entirety on the patent owner at the address as provided for in § 1.33(c). The name and address of the party served must be indicated. If service was not possible, a duplicate copy must be supplied to the Office."

If the request is filed by a person other than the patent owner, a certification that a copy of the request papers has been served on the patent owner must be included. The request should be as complete as possible since there is no guarantee that the examiner will consider other prior art when making the decision on the request. Also, if no statement is filed by the patent owner, no later reply may be filed by the requester. See also § 2220.

The form set forth below should be helpful to persons filing requests for reexamination. The use of this form is encouraged but its use is not a requirement of the law or the rules. ←

FORM PTO - 1485
(7-81)U. S. DEPARTMENT OF COMMERCE
PATENT AND TRADEMARK OFFICEREQUEST FOR REEXAMINATION TRANSMITTAL FORM
IN THE UNITED STATES PATENT AND TRADEMARK OFFICE

Address to:

Commissioner of Patents and Trademarks
Box Reexam
Washington, D. C. 20231

Attorney Docket No.

Date: July 2, 1981

1. This is a request for reexamination pursuant to 37 CFR 1.510
of 4,444,444 issued July 7, 1977
2. The name and address of the person requesting reexamination is:
XYZ Corporation
321 Maple Street
Atlanta, Georgia 77777
3. a. A check in the amount of \$1500 is enclosed to cover the reexamination fee, 37 CFR 1.21 (x); or
 b. The Commissioner is hereby authorized to charge \$1500 to the deposit account of John Doe
deposit account no. 12-3456
4. Any refund should be made by check or by credit to deposit account
no. 12-3456 37 CFR 1.26 (c)
5. A cut-up copy of the patent to be reexamined or a permanent reproduction thereof
with only a single column of the printed patent securely mounted on one side
of a separate paper is enclosed. 37 CFR 1.510 (b) (4)
6. A copy of any disclaimer, certificate of correction or reexamination certificate issued in
the patent is included.
7. Reexamination of claim(s) 1-4 is requested.
8. A copy of every patent or printed publication relied upon is submitted herewith including
a listing thereof on Form PTO - 1449.
9. An English language translation of all necessary and pertinent non-English language
patents or printed publications is included.
10. The attached detailed request includes at least the following items:
 - a. A statement identifying each substantial new question of patentability based on
prior patents and printed publications. 37 CFR 1.510 (b) (1)
 - b. An identification of every claim for which reexamination is requested, and a
detailed explanation of the pertinency and manner of applying the cited prior art to
every claim for which reexamination is requested. 37 CFR 1.510 (b) (2)
11. A proposed amendment is included (only where the patent owner is the requester).
37 CFR 1.510 (e)
12. a. It is certified that a copy of this request (if filed by other than the patent owner) has
been served in its entirety on the patent owner as provided in 37 CFR 1.33 (c).
The name and address of the party served and the date of service are:
William Dyre
2400 Jefferson Davis Highway
Arlington, Virginia 22222
Date of Service: July 17, 1981; or
 b. A duplicate copy is enclosed since service was not possible.
13. The requester's correspondence address (if different from Number 2 above):
John Doe
12 Seemore Street
New York, New York 10001

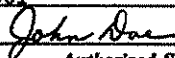

Authorized Signature

- Patent Owner
 Third Party Requester
 Attorney or Agent for Patent Owner
 Attorney or Agent for Requester

→ Sir:

Pat. No. 4,444,444

Reexamination under 35 U.S.C. 302 - 307 and 37 CFR 1.510 is requested of United States patent number 4,444,444 which issued on July 7, 1977 to Joseph Smith. This patent is still enforceable.

Claims for which reexamination is requested

Reexamination is requested of claims 1-3 of the Smith patent in view of the earlier United States patent document number 594,225 to Berridge which is listed on attached form PTO-1449 and of which a copy is enclosed.

Reexamination is also requested of claim 4 of the Smith patent in view of the earlier Swiss patent document 80,555 to Hotopp in view of the disclosure in "American Machinist" magazine, October 16, 1950 issue, on page 169. An English translation of the German language Swiss document is enclosed. Copies of the Hotopp and "American Machinist" documents are also enclosed.

Explanation of pertinency and manner of applying cited prior art to every claim for which reexamination is requested

Claims 1-3 of the Smith patent are considered to be fully anticipated under 35 U.S.C. 102 by the prior art patent document to Berridge.

Claim 3 of the Smith patent, which is more specific than claims 1 and 2 in all features, is set forth below with an explanation as to how the prior art patent document to Berridge meets all the recited features.

Smith, claim 3:

"In a cutting and crimping tool"

(Berridge page 1, lines 10-13 states his invention is "an improved tool for crimping metal, which in its preferred form of embodiment is combined with a cutting-tool or shears, forming therewith a combination-tool.)

"the combination with the cutting blades"

(elements 4 and 5 in Berridge)

→ "and their pivoted handles"

(elements 1 and 2 in Berridge)

"of bosses arranged at an angle to and offset from the plane of the shear blades"

("bosses" as used in the Smith claim is used to mean a projection. The dies 6 and 7 of the Berridge prior art patent document are arranged at the same angle to the plane of the shear blades and are arranged at an angle in the same manner as shown in the drawing figures of the Smith patent.)

"and crimping dies formed on the meeting faces of said bosses"

(The dies 6 and 7 (bosses) of Berridge have meeting die-faces 12 and 13 (page 1, line 63) for performing crimping operations (page 1, lines 70 - 74.))

Claim 4 of the Smith patent is considered to be unpatentable under 35 U.S.C. 103 in view of the prior art Swiss patent document to Hotopp in view of the prior art magazine publication on page 169 of the October 16, 1950 issue of American Machinist magazine.

Claim 4 of Smith reads as quoted below

"In a cutting and crimping tool,"

(The prior art Swiss patent document to Hotopp discloses cutting jaws (column 1, line 8) and dies "b" and "c" which may be used for crimping.)

"the combination of a pair of pivoted handles"

(elements "a" and "e" in the prior art document to Hotopp).

"with cutting jaws at one end and crimping dies on the opposite side of the pivot"

(The prior art document to Hotopp discloses cutting jaws (column 1, line 8) and crimping dies "b" and "c" on the opposite side of pivot "d" from the cutting jaws.)

"and rounded prongs projecting from said cutting jaws"

(Rounded prongs are not specifically disclosed by Hotopp but are shown to be old in the art by the illustration in "American Machinist" magazine under the title "Double-Purpose Pliers Don't Break Insulation". To provide the cutting jaws of Hotopp with rounded prongs as shown in the "American Machinist" magazine is considered to be a matter which would have been obvious to a person having ordinary skill in the art at the time the invention was made.)

Statement pointing out substantial new question of patentability

The prior art documents referred to above were not of record in the file of the Smith patent. Since the claims in the Smith patent are not allowable over these prior art documents, a substantial new question of patentability is raised. Further, these prior art documents are closer to the subject matter of Smith than any prior art which was cited during the prosecution of the Smith patent.



John Doe
Attorney for requester

Sheet 1 of 1

FORM PTO-1449 (REV. 7-80)		U.S. DEPARTMENT OF COMMERCE PATENT AND TRADEMARK OFFICE			ATTY. DOCKET NO.	Patent No. 4,444,444	
LIST OF PRIOR ART CITED <i>(Use several sheets if necessary)</i>					Patent Owner Joseph Smith		
					Issue Date July 7, 1977		GROUP
U.S. PATENT DOCUMENTS							
EXAMINER INITIAL	DOCUMENT NUMBER	DATE	NAME	CLASS	SUBCLASS	FILING DATE IF APPROPRIATE	
AA	5 94 2 2 5	11-1897	BERRIDGE	140	106		
AB							
AC							
AD							
AE							
AF							
AG							
AH							
AI							
AJ							
AK							
FOREIGN PATENT DOCUMENTS							
	DOCUMENT NUMBER	DATE	COUNTRY	CLASS	SUBCLASS	TRANSLATION	
						YES	NO
AL	8 05 5 5	10-1918	SWITZERLAND	—	—	X	
AM							
AN							
AO							
AP							
OTHER PRIOR ART (Including Author, Title, Date, Pertinent Pages, Etc.)							
AR	"American Machinist" magazine, October 16, 1950 issue, page 169 (copy located in class 72, subclass 409)						
AS							
AT							
EXAMINER				DATE CONSIDERED			
*EXAMINER: Initial if reference considered, whether or not citation is in conformance with MPEP 609; Draw line through citation if not in conformance and not considered. Include copy of this form with next communication							

→ 2215 Fee for Requesting Reexamination [R-7]

37 CFR 1.21 Patent and miscellaneous fees and charges

* * * * *

(a) To file a request for reexamination—\$1,500.00

37 CFR 1.26 Refunds. (a) Money paid by actual mistake or in excess, such as a payment not required by law, will be refunded, but a mere change of purpose after the payment of money, as when a party desires to withdraw his application or to withdraw an appeal, will not entitle a party to demand such a return. Amounts of fifty cents or less will not be returned unless specifically demanded within a reasonable time, nor will the payer be notified of such amount, amounts over fifty cents but less than one dollar may be returned in postage stamps, and other amounts by check or, if requested, by credit to a deposit account.

* * * * *

(c) If the Commissioner decides not to institute a reexamination proceeding, a refund of \$1,200.00 will be made to the requestor of the proceeding. Reexamination requestors should indicate whether any refund should be made by check or credit to a deposit account.

In order for a request to be accepted, be given a filing date and be published in the Official Gazette it is necessary that the \$1500.00 fee for filing a request for reexamination be paid. If the fee is not paid, the request will be considered to be incomplete.

If the request for reexamination is denied or vacated, a refund of \$1200.00 in accordance with 37 CFR 1.26(c) will be made to the identified requester.

As stated in 37 CFR 1.510 (c) and (d)

If the request does not include the fee for requesting reexamination or all of the parts required by paragraph (b) of this section, the person identified as requesting reexamination will be so notified and given an opportunity to complete the request within a specified time. If the fee for requesting reexamination has been paid but the defect in the request is not corrected within the specified time, the determination whether or not to institute reexamination will be made on the request as it then exists. If the fee for requesting reexamination has not been paid, no determination will be made and the request will be placed in the patent file as a citation if it complies with the requirements of § 1.501(a).

The filing date of the request is: (1) the date on which the request including the entire fee for requesting reexamination is received in the Patent and Trademark Office; or (2) the date on which the last portion of the fee for requesting reexamination is received.

Where the entire \$1500.00 fee is not paid, the request, if otherwise proper, should be treated as a citation of prior art under § 1.501.

2216 Substantial New Question of Patentability [R-7]

37 CFR 1.510(b)(1) requires that the request include "a statement pointing out each substantial new question of patentability based on prior patents and printed publications." Under 35 U.S.C. 304 the Office must determine whether "a substantial new question of patentability" affecting any claim of the patent has been raised. If such a new question is found, an order for reexamination of the patent is issued. It is therefore clear that it is extremely important that the request clearly set forth in detail exactly what the requester considers the "substantial new question of patentability" to be in view of prior patents and printed publications. The request should point out how any questions of patentability raised are substantially different from those raised in the earlier prosecution of the patent before the Office or in litigation before the federal courts. If a substantial new question of patentability is found as to one claim, all claims will be reexamined during the ex parte reexamination process. See also § 2242.

Questions relating to grounds of rejection other than those based on prior patents or printed publications, such as on public use, on sale, or fraud should not be included in the request and will not be considered by the examiner if included.

2217 Statement Applying Prior Art [R-7]

The third sentence of 35 U.S.C. 302 indicates that the "request must set forth the pertinency and manner of applying cited prior art to every claim for which reexamination is requested." 37 CFR 1.510(b)(2) requires that the request include "An identification of every claim for which reexamination is requested, and a detailed explanation of the pertinency and manner of applying the cited prior art to every claim for which reexamination is requested." If the request is filed by the patent owner, the request for reexamination may also point out how claims distinguish over cited prior art.

The prior art applied may only consist of prior patents or printed publications. Substantial new questions of patentability may be based upon the following portions of 35 U.S.C. 102:

"(a) . . . patented or described in a printed publication in this or a foreign country, before the invention thereof by the applicant for patent, or"

"(b) the invention was patented or described in a printed publication in this or a foreign country . . . more than one year prior to the date of the application for patent in the United States, or"

* * * * *

"(d) the invention was first patented or caused to be patented, or was the subject of an inventor's certificate, by the applicant or his legal representatives or assigns in a foreign country prior to the date of the application for patent in this country on an application for patent or inventor's certificate filed more than twelve months before the filing of the application in the United States, or"

"(e) the invention was described in a patent granted on an application for patent by another filed in the United States before the invention thereof by the applicant for patent, or on an international application by another who has fulfilled the requirements of paragraphs (1), (2), and (4) of section 371(c) of this title before the invention thereof by the applicant for patent."

* * * * *

Similarly, substantial new questions of patentability may also be made under 35 U.S.C. 103 which are based on the above indicated portions of section 102.

In addition to the above quoted paragraphs of § 102, where two patented inventions have common assignees and different inventive entities, the prior invention of another disclosed in one of the patents could be available under 35 U.S.C. 103 as prior art by virtue of 35 U.S.C. 102(g) against the other, see for example, *In re Bass*, 177 USPQ 178, (CCPA, 1973).

Substantial new questions of patentability based on matters other than patents or printed publications, such as public use or sale, inventorship, § 101, § 112, fraud, etc. will not be considered when making the determination on the request and should not be presented in the request. A prior patent or printed publication cannot be properly applied as a ground for reexamination if it is merely used as evidence of alleged prior public use or sale, insufficiency of disclosure, etc. The prior patent or printed publication must be applied directly to claims under § 103 and/or an appropriate portion of § 102 or relate to the application of other prior printed publication to claims on such grounds.

The statement applying the prior art may, where appropriate, point out that claims in the patent for which reexamination is requested are entitled only to the filing date of the patent and are not supported by an earlier foreign or United States patent application whose filing date is claimed. For example, under 35 U.S.C. 120, the effective date of the claims would be the filing date of the application which resulted in the patent. Therefore, intervening patents or printed publications are available as prior art under *In re Ruscetta*, 118 USPQ 101 (CCPA, 1958).

Double patenting is normally proper for consideration in reexamination.

The mere citation of new patents or printed publications without an explanation does not comply with 37 CFR 1.510(b)(2). An explanation of how the cited patents or printed publications are applied to all claims which the requester considers to merit reexamination should be presented. This not only sets forth the requester's position to the Office, but also to the patent owner.

2218 Copies of Prior Art [R-7]

It is required that a copy of each patent or printed publication relied upon or referred to in the request be filed with the request (37 CFR 1.510(b)(3)). If any of the documents are not in the English language, an English language translation of all necessary and pertinent parts is also required. An English language summary or abstract of a non-English language document is usually not sufficient.

It is also helpful to include copies of the prior art considered during earlier prosecution of the patent for which reexamination is requested. The presence of both the old and the new prior art allows a comparison to be made to determine whether a substantial new question of patentability is indeed present. Copies of parent applications should also be submitted if the parent application relates to the alleged substantial new question of patentability; for example, if the patent is a continuation-in-part and the question of patentability relates to an *In re Ruscetta*, 255 F. 2d 687, 118 USPQ 101 (CCPA 1958) type rejection where support in the parent application is relevant.

2219 Copy of Printed Patent [R-7]

The Patent and Trademark Office will prepare a separate file wrapper for each reexamination request which will later become part of the patent file. Since in some instances, it may not be possible to obtain the patent file promptly and in order to provide a format which can be amended and used for printing, requesters are required under § 1.510(b)(4) to include a copy of the entire specification (including claims) and drawings of the patent for which reexamination is requested in the form of a cut-up copy of the original printed patent with only a single column of the patent securely mounted or reproduced in permanent form on one side of a sheet of paper. A copy of any disclaimer, certificate of correction, or reexamination certificate issued in the patent must also be included so that a complete history of the patent is before the Office for consideration. A copy of any federal court decision, complaint in a pending civil action, or interference decision should also be submitted.

→ 2220 Certificate of Service [R-7]

If the requester is a person other than the patent owner, the owner of the patent must be served with a copy of the request in its entirety. The service should be made to the correspondence address as indicated in 37 CFR 1.33(c). The name and address of the person served and the certificate of service should be indicated on the request.

The most recent address of the attorney or agent of record can be determined by checking the Office's register of patent attorneys and agents maintained by the Office of the Solicitor pursuant to 37 CFR 1.341 and 1.347.

2221 Amendments Included in Request by Patent Owner [R-7]

Under 37 CFR 1.510(e) a patent owner may include a proposed amendment with his or her request, if he or she so desires. Any such amendment must be in accordance with § 1.121(f). Amendments may also be proposed by patent owners during the actual ex parte reexamination prosecution (§ 1.550(b)).

The request should be decided on the wording of the claims without the amendments. The decision on the request will be made on the basis of the patent claims as though the amendment had not been presented. However, if the request for reexamination is granted, the ex parte reexamination prosecution should be on the basis of the claims as amended.

2222 Address of Patent Owner [R-7]

37 CFR 1.33, Correspondence respecting patent applications, reexamination proceedings, and other proceedings.

* * * * *
(c) All notices, official letters, and other communications for the patent owner or owners in a reexamination proceeding will be directed to the attorney or agent of record (see § 1.34(b)) in the patent file at the address listed on the register of patent attorneys and agents maintained pursuant to §§ 1.341 or 1.347 or, if no attorney or agent is of record, to the patent owner or owners at the address or addresses of record. Amendments and other papers filed in a reexamination proceeding on behalf of the patent owner must be signed by the patent owner, or if there is more than one owner by all the owners, or by an attorney or agent of record in the patent file, or by a registered attorney or agent not of record who acts in a representative capacity under the provisions of § 1.34(a). Double correspondence with the patent owner or owners and the patent owner's attorney or agent, or with more than

one attorney or agent, will not be undertaken. If more than one attorney or agent is of record and a correspondence address has not been specified, correspondence will be held with the last attorney or agent made of record.

37 CFR 1.33(c) indicates which correspondence address is to be normally used to direct correspondence to the patent owner. In most instances this will be the address of the first named, most recent attorney or agent in the patent file at his or her current address. If such an attorney or agent does not desire to receive correspondence relating to reexaminations, a withdrawal of power of attorney should be filed in the patent. If the patent owner desires that a different attorney or agent receive correspondence, then a new power of attorney must be filed. Correspondence will continue to be sent to the attorney or agent of record in the patent file absent a revocation of the same by the patent owner. If the attorney or agent of record specifies a correspondence address to which correspondence is to be directed, such direction should be followed. However, since a change in the correspondence address does not withdraw a power of attorney, a change of the correspondence address by the patent owner does not prevent the correspondence from being directed to the attorney or agent of record in the patent file under 37 CFR 1.33(c).

A form for changing correspondence address or power of attorney is set forth below. Such forms should be addressed to the Commissioner of Patents and Trademarks, Box Patent Address Change, Washington, D.C. 20231.

CHANGE OF POWER OF ATTORNEY OR CORRESPONDENCE ADDRESS IN U.S. PATENT

Address to:
Commissioner of Patents and Trademarks
Box: Patent Address Change
Washington D.C. 20231

To the Commissioner of Patents and Trademarks:

In United States patent number _____, granted _____ to _____ (list first inventor)

please make the following change:

- 1. Change the address of the attorney(s) of record to:

- 2. Change the correspondence address of the patent owner to:

- 3. Add a power of attorney to and address any future correspondence to the first named person below

who I hereby appoint to transact all business in the Patent and Trademark Office.

- *4. Remove all previous powers of attorney which I hereby revoke and enter a power of attorney and address any future correspondence to

who I hereby appoint to transact all business in the Patent and Trademark Office.

It is certified that the person whose signature appears below has the authority to make the requested changes in the patent.

 Date Authorized Signature
 Attorney/Agent Reg. No. -----
 Patent Owner

*Requires signature of patent owner.

2223 Withdrawal of Power of Attorney [R-7]

Any request for withdrawing a power of attorney from a patent will normally only be approved if at least 30 days remain in any running period for response. See also § 402.06.

2224 Correspondence [R-7]

37 CFR 1.1 All communications to be addressed to Commissioner of Patents and Trademarks.

(a) All letters and other communications intended for the Patent and Trademark Office must be addressed to "Commissioner of Patents and Trademarks," Washington, D.C. 20231. When appropriate, a letter should also be marked for the attention of a particular officer or individual.

(b) Letters and other communications relating to international applications during the international stage and prior to the assignment of a national serial number should be additionally marked "Box PCT."

(c) Requests for reexamination should be additionally marked "Box Reexam."

All requests for reexamination mailed to the Patent and Trademark Office should be additionally marked "Box Reexam." Such mail will not be opened by the Correspondence and Mail Division but will be sorted out immediately and processed by the Reexamination Preprocessing Unit. Subsequent correspondence should however be directed to the examining group art unit indicated on the Office letters. Any correction or change of correspondence address for a United

States patent should be addressed to the Office at Box "Patent Address Change."

Letters sent to the Patent and Trademark Office relating to a reexamination proceeding should identify the proceeding by the number of the patent undergoing reexamination, the reexamination request control number assigned, examining group art unit, and the name of the examiner. The certificate of mailing practice (37 CFR 1.8) may be used to file any paper in a reexamination proceeding.

Communications from the Patent and Trademark Office to the patent owner will be directed to the first named, most recent attorney or agent of record in the patent file at the current address on the Office's register of patent attorneys and agents or to the patent owner's address if no attorney or agent is of record, 37 CFR 1.33(c).

Amendments and other papers filed on behalf of patent owners must be signed by the patent owners, or the attorney or agent of record in the patent file, or any registered attorney or agent acting in a representative capacity under § 1.34(a).

Double correspondence with the patent owners and the attorney or agent normally will not be undertaken by the Office.

Where no correspondence address is otherwise specified, correspondence will be with the most recent attorney or agent made of record.

Note § 2220 on certificate of service.

2225 Untimely Papers Filed Prior to Order [R-7]

After filing of a request, no papers other than (1) citations of patents or printed publications under § 1.501; (2) another complete request under § 1.510; or (3) notifications pursuant to § 2282, should be filed with the Office by the requester, patent owner, or third parties prior to the date of the decision on the request for reexamination. Any papers other than those under §§ 1.501 or 1.510 or § 2282 filed prior to the decision on the request will be returned to the sender by the group director without consideration. A copy of the letter accompanying the returned papers will be made of record in the patent file. However, no copy of the returned papers will be retained by the Office. If the submission of the returned papers is appropriate later in the proceedings, they will be accepted by the Office at that time.

2226 Initial Processing of Request [R-7]

The opening of all mail marked "Box Reexam" and all initial clerical processing of

requests for reexamination will be performed by the Reexamination Preprocessing Unit in the Office of Patent and Trademark Services.

2227 Incomplete Requests [R-7]

37 CFR 1.510, Request for reexamination

(c) If the request does not include the fee for requesting reexamination or all of the parts required by paragraph (b) of this section, the person identified as requesting reexamination will be so notified and given an opportunity to complete the request within a specified time. If the fee for requesting reexamination has been paid but the defect in the request is not corrected within the specified time, the determination whether or not to institute reexamination will be made on the request as it then exists. If the fee for requesting reexamination has not been paid, no determination will be made and the request will be placed in the patent file as a citation if it complies with the requirements of § 1.501(a).

(d) The filing date of the request is: (1) the date on which the request including the entire fee for requesting reexamination is received in the Patent and Trademark Office; or (2) the date on which the last portion of the fee for requesting reexamination is received.

If the \$1500.00 fee under § 1.21(x) is not paid in full, the request is considered to be incomplete, § 1.510(c), and will not be considered on its merits or have a notice of its filing announced in the Official Gazette. The request is considered to have a "filing date" under § 1.510(d) only when the entire fee is paid.

If no fee, or only a portion of the fee is received, the Reexamination Preprocessing Unit will notify the requester of the defect and give the requester a specified time, normally 1 month, to complete the request. A telephone call may also be made to the requester indicating the amount of the insufficient fee. If the request is not timely completed, any partial fee will be returned and the request will be treated as a citation under § 1.501(a) if it complies therewith.

2228 Informal Requests [R-7]

If the fee under § 1.21(x) has been paid, but the request does not contain all the elements called for by § 1.510(b), the request is considered to be informal. All requests which are accompanied with the entire fee will be assigned a filing date from which the three month period for making a decision on the request will be computed. Notice of filing of all complete requests will be published in the Official Gazette approximately 4-5 weeks after filing.

The Reexamination Preprocessing Unit will attempt to notify the requester of any informality in the request in order to give the requester time to respond before a decision is made on the request. If the requester does not respond and correct the informality, the decision on the request will be made on the information presented. If the information presented does not present "a substantial new question of patentability", the request for reexamination will be denied.

2229 Notice of Request in Official Gazette [R-7]

37 CFR 1.11, Files open to the public.

(c) All requests for reexamination for which the fee under § 1.21(x) has been paid, will be announced in the Official Gazette. Any reexaminations at the initiative of the Commissioner pursuant to § 1.520 will also be announced in the Official Gazette. The announcement shall include at least the date of the request, if any, the reexamination request control number or the Commissioner initiated order control number, patent number, title, class and subclass, name of the inventor, name of the patent owner of record, and the examining group to which the reexamination is assigned.

(d) All papers or copies thereof relating to a reexamination proceeding which have been entered of record in the patent or reexamination file are open to inspection by the general public, and copies may be furnished upon paying the fee therefor.

Under 37 CFR 1.11(c), reexamination requests with sufficient fees and any Commissioner initiated orders made without a request will be announced in the Official Gazette. The Reexamination Preprocessing Unit will complete a form with the information needed to print the notice. The forms are forwarded at the end of each week to the Office of Publications for printing in the Official Gazette.

In addition, a record of requests filed will be located in the Public Search Room and in the Reexamination Preprocessing Unit. Office personnel may use the PALM System to determine if a request for reexamination has been filed in a particular patent. The Official Gazette notice will appear in the notice section of the Official Gazette under the heading of "Reexamination Requests Filed" and will include the name of any requester along with the other items set forth in § 1.11(c).

2230 Constructive Notice to Patent Owner [R-7]

In some instances it may not be possible to deliver mail to the patent owner because no

current address is available. If all efforts to correspond with the patent owner fail, the reexamination proceeding will proceed without the patent owner. The publication in the Official Gazette of the notice of the filing of a request or the ordering of reexamination at the initiative of the Commissioner will serve as constructive notice to the patent owner in such an instance.

2231 Processing of Request Corrections [R-7]

Any payment of insufficient fees should be marked "Box Reexam" so that the fee may be promptly forwarded to the Reexamination Preprocessing Unit. If the fee payment completes the \$1500.00 fee requirement, the request will be processed, notice will be published in the Official Gazette and the request will be forwarded to the appropriate examining group for determination.

Any correction of a defect other than the fee should be directed to the examining group where the file is located. The group clerical personnel process any timely corrections and enter them in the file of the reexamination.

2232 Public Access [R-7]

The reexamination folders will be stored in a separate central location in the patent examining group unless being acted upon by the examiner or a communication is being processed by the group clerical personnel. In view of the desire to conduct the reexamination proceeding with special dispatch, the reexamination folder may *NOT* be available to the public when it is in the Reexamination Preprocessing Unit, and when the examiner has started consideration of some matter until an action is mailed. However, all areas should be as reasonable as possible in allowing access and copying of the file. At times other than those identified above, the reexamination file will be made available to members of the public upon request. Inspection will be permitted in the patent examining group. If a copy of the file is requested, it may be ordered from the Customer Services Division or the file wrapper may be hand carried by a member of the group to the Record Room and left with a member of the Record Room staff. The file will be dispatched by using PALM transaction 1034-820. A charge card will be stapled to the file identifying the Reexamination Control Number, Art Unit Number, Reexamination Clerk's name and phone number.

A member of the Record Room staff should call the reexamination clerk in the group when copying is completed, and the file can then be

retrieved by a member of the group. The group should maintain a tickler record of the location of the file wrapper by some system. For example, a copy of the charge card could be attached to the docket card for a 2 day call up to insure prompt return of the file.

Similar procedures should be utilized in the event that an associated patent file is requested for inspection and/or copying. Access to the patent file wrapper should be restricted only when the examiner is preparing an action in the reexamination folder which requires consideration of the patent file.

To: RECORD ROOM PERSONNEL
Re: Reexam. No.
Patent No.
Serial No.

This file is charged out from group -----
Please return promptly by:

- Office Mail
 Calling -----
X7----- for pickup of the file

Sale of Copies of Reexamination Requests

Copies of reexamination requests, all cited references, and the file wrapper and contents of the patent file for which reexamination is requested are available at the standard charge per page. Orders for such copies must indicate the control number assigned the reexamination request. Orders should be addressed to the Commissioner of Patents and Trademarks, Washington, D.C. 20231, Attention: Customer Service Division.

TO DETERMINE ON PALM IF A REEXAMINATION REQUEST HAS BEEN FILED FOR A GIVEN PATENT NUMBER

Assume Patent Number Is 4104156

- Clear PALM Terminal
- Key In: 3110 And Press Send
- When Screen Fills
Enter: PAT NO 4104156 (In Family Name)
Press: TAB
Enter: \$ (In Given Name)
Press: TAB
Enter: Y
Press: SEND

Any reexaminations for the patent number will be listed on the return screen.

There will be about a ten (10) day lag between filing and data entry.

→ 2233 Processing in Examining Group [R-7]

Each examining group has designated at least one docket clerk and one backup clerk to act as the reexamination clerk and has assigned to that person those clerical duties and responsibilities which are unique to reexamination. The regular docket clerks will still perform their normal duties and responsibilities in handling papers and records during the actual reexamination process. The reexamination clerk has sole responsibility for clerical processing until such time as the request is either granted or denied. If a request is granted, the responsibility for all docket activities relating to ex parte examination is assigned to the regular docket clerk.

The record card (Serial Register and Docket Record) files are maintained as follows:

Serial Register Card Files In The Groups—The Serial Register Cards for reexamination files will be maintained in a file separate from the Serial Register Cards for regular applications. These cards will be kept updated by the reexamination clerk of the group.

Docket Record Card Files In The Group—The Docket Record Cards are maintained by the reexamination clerk of the group until the reexamination proceeding has progressed to the point that it is ready for the examiner to write a first action. At that point, the Docket Record Card will be placed in the appropriate segments of the Docket Record files for regular patent applications. When examination is completed and the proceedings terminated, the Docket Record card is returned to the reexamination clerk for subsequent updating and storage. The following file segments are provided for the Docket Record cards in the reexamination clerk's file:

- Awaiting Assignment To An Examiner
- Awaiting Determination of Request
- Reexamination Refused
- Petition For Reconsideration Filed
- Awaiting Owner's Statement
- Awaiting Requester's Reply
- Proceedings Terminated—Certificate To Issue
- Proceedings Terminated—Certificate Issued

FEEs

Under reexamination, there are no fees due other than for the request and any appeal and brief fees under §§ 1.191 and 1.192. No fees are required for additional claims added or for issue of the certificate.

MAILING

A transmittal form with the requester's address will be used to forward copies of Office actions to the requester. Whenever an Office action is issued, a copy of this form will be made and attached to a copy of an Office action. The use of this form removes the need to retype the requester's address each time a mailing is required. When the patent owner is the requester, no such form is needed.

The following steps should be taken when processing reexamination requests in the examining groups.

1. Report receipt of the reexamination file in the group on the PALM terminal and forward the file to the group's reexamination clerk.

2. Date stamp the date of receipt in the group on the reexamination file and the Docket Register (DR) card.

3. File the Docket Register (DR) card in the "Awaiting Assignment to Examiner" section of the files.

4. Charge file to the supervisory primary examiner of the group art unit indicated on the reexamination file on the PALM terminal and forward the file to the supervisory primary examiner.

5. The supervisory primary examiner promptly reviews the subject matter of the patent in which reexamination was requested and either transfers the request file (which should rarely occur) or assigns it to a primary examiner. The primary examiner is informed and the request file is returned to the group's reexamination clerk for posting of Serial Register and Docket Record cards and entry of the examiner's name into PALM.

6. At about 6 weeks after the filing of the request, the request file should be given to the examiner and charged to him or her on PALM.

7. The primary examiner then drafts a decision on the request and returns it to be typed on a "special" basis, normally within 8 weeks after the filing date of the request.

8. The typed decision is forwarded to the primary examiner for signature. After signing, the file is returned to the group clerical unit for mailing and PALM update, normally within 10 weeks after the filing date of the request.

The initial reexamination files are regular patent application files which have orange tape applied to the face. In the future the reexamination file wrappers will be of an orange color for easy identification.

2234 Entry of Amendments [R-7]

Amendments which comply with 37 CFR 1.121 (f) are entered in the reexamination file wrap-

per in much the same way as amendments in re-issue applications. An amendment is given a Paper No. and is designated by consecutive letters of the alphabet (A,B,C, etc.). Inserts may be placed in the original patent text by using carets at the appropriate indicated column and line, together with the amendment alphabetic letter and number. (i.e., B3, O2, etc.) Deletions will be indicated by inserting square brackets [] around the deleted material together with an indication of the amendment letter and number.

Although amendments will be entered for purposes of examination, the amendments are not legally effective until the certificate is issued.

2235 Record Systems [R-7]

PALM—MONITORING SYSTEMS

The Patent Access and Location Monitoring (PALM) system is used to support the reexamination process. The sections below delineate PALM related activities.

1. *Reexamination File Data On PALM*—The routine PALM retrieval transactions are used to obtain data on reexamination files. The user keys in the retrieval transaction code (2952, 2962, etc.) the reexamination series code (90) and the reexamination control number. Almost all data displayed for reexamination files has the same meaning as for regular patent applications. Two changes should be noted. In the first named applicant location (normally upper left corner, abbreviation APPL) the patent number being reexamined will appear for reexamination files. For a patent undergoing reexamination the number of the proceeding can be determined on the 2953 retrieval screen. The pertinent reexamination number(s) will appear in the "Details" section of the screen as a six digit number preceded by an "R". If no "R" number is present then no reexamination has been filed.

2. *Reexamination File Location Control*—The location of a Reexamination file is monitored in the same manner as regular patent application files. All PALM transactions are equally applicable to regular patent applications and reexamination files.

3. *Patent File Location Control*—The movement of patent files related to requests for reexamination throughout the Office is monitored by the PALM system in the normal fashion. Within the groups the reexamination file and patent file will be kept together, from initial receipt until the reexamination is assigned to an examiner for determination. At this point the patent file will be charged to the examiner assigned the reexamination file (use transaction

1036) and will be kept in the examiner's room until the proceeding is terminated. After the reexamination proceeding has been terminated, the patent file should be returned to the Record Room. Patent Issue Division will forward the reexamination file after printing of the certificate.

4. *Reporting Events to PALM*—The PALM system is used to monitor major events that take place in processing reexamination proceedings. During initial processing all major pre-ex parte examination events are reported. During the ex parte phase the mailing of examiner's actions are reported as well as owner's responses thereto. The group reexamination clerk is responsible for reporting these events using the bar code reader (BCR) initiated 2920 cathode ray tube (CRT) update screen display. Thus, as a general rule, the reexamination clerk will report to PALM, if appropriate, when the reexamination serial register (SR) card is updated. The events that will be reported are as follows:

Determination Mailed—Denial of request for reexamination.

Determination Mailed—Grant of request for reexamination.

Petition for reconsideration of determination received.

Decision on petition mailed—Denied.

Decision on petition mailed—Granted.

Owner response to determination received.

Requester response to determination received.

The mailing of all examiner actions.

The receipt of owner's responses to examiner's actions and Office receipt date.

Each of these events, as well as additional events reported by the Reexamination Preprocessing Unit will be permanently recorded and displayed in the "Contents" portion of PALM. In addition, status representative of these events will also be displayed.

5. *Status Report*—Various weekly "tickler" reports can be generated for each group given the event reporting discussed above. The primary purpose of these computer outputs is to assure that reexaminations are, in fact, processed with "special dispatch."

PALM Reports—A number of automated reports generated from the PALM system will be provided to the groups at the beginning of each week. These reports will generally serve to indicate to the groups when certain deadlines are approaching. Each report will be subdivided by group and will arrange the requests listed in control number sequence. The following reports have been identified.

Requests not received within one month in group—This report will serve to indicate to a group those requests assigned to it for which preprocessing has not been completed and which

have not yet been received in the group. This report will provide an indicator of future workload as well as identify potential, problem stragglers.

Unassigned Request—This report will serve to highlight those requests which have not been assigned to an examiner by the six week anniversary of their filing. Requests appearing on this report should be located and docketed immediately.

Requests Which Should Be Taken Up For Determination—This report will list those requests which have been assigned to an examiner and in which no determination has been mailed and the six week anniversary of their filing is past. Requests on this report should be taken up for determination by the examiner.

Requests For Which Determinations Should Be Prepared—This report will list those requests which have been assigned to an examiner and in which no determination has been mailed and the two month anniversary of their filing is past. Determinations for requests on this report should be in the final stages of preparation.

**Requests For Which Determinations Should Be Mailed*—This report will list those requests which have been assigned to an examiner and in which no determination has been mailed and the ten week anniversary of their filing is past. Determinations for requests on this report should be mailed immediately.

**Overdue Determination*.—This report will list those requests in which no determination has been mailed and the three month anniversary of their filing is past. This report should always be zero.

Overdue Petition For Reconsideration of Denial.—This report will list those requests in which the determination denied reexamination and no petition has been received and six weeks have passed since the determination was mailed. Requests on this report should be terminated.

Overdue Owner Response To Determination—This report will list those requests in which the determination ordered reexamination and the owner has not filed a response and ten weeks have passed since the mailing of the determination. These requests should be taken up for immediate ex parte action by the examiner.

Overdue Requester Response To Determination—This report will list those requests in which a proper owner statement was received and no requester reply has been received and ten weeks have passed since the receipt of the owner response. These requests should be taken up for immediate action.

**Overdue First Ex Parte Action*—This report will list those requests in which reexamination has been ordered and a first action has

not been mailed and six weeks have passed since the request became available for ex parte prosecution. These requests should be taken up for immediate action by the examiner.

**Overdue Second And Subsequent Action*—This report will list those reexaminations which are up for second or subsequent action by the examiner and no such action has been mailed and six weeks have passed since the patent owner's response was received by the Office.

**Overdue Certificates*—This report will list those requests in which a Notice of Intent to Issue a Reexamination Certificate has been mailed and three months have passed since its mailing and no issue date has been assigned.

**Requests With Prolonged Prosecution*—This report will list those requests which have not matured into a certificate and fifteen months have passed since the date of filing.

* Asterisk items require immediate action and followup, if appropriate.

6. *Historical Reporting*—A variety of historical reports are possible given the event recording described above. Thus such statistics as the number of requests filed and determinations made in a specified period or number or kind of reexaminations in which an appeal was filed can be made available.

2236 Assignment of Reexamination [R-7]

Reexamination requests should normally be assigned to the art unit which examines the class and subclass in which the patent to be reexamined is classified as an original and to the primary examiner most familiar with the claimed subject matter of the patent. Where no knowledgeable primary examiner is available, the reexamination may be assigned to an assistant examiner. In such an instance the supervisory primary examiner must sign all actions and take responsibility for all actions taken.

2237 Transfer Procedure [R-7]

Although the number of reexamination requests which must be transferred should be very small, the following procedures have been established for an expeditious resolution of any such problems.

No transfer inquiry forms (PTO-447A) should be used in reexamination situations. All reexamination requests in which a transfer is desired must be hand carried with the docket record card and patent file by the supervisory primary examiner to the supervisory primary examiner of the group art unit to which a transfer is desired. Any conflict which cannot be resolved by the supervisory primary examina-

ers will be resolved by the group directors involved.

If the reexamination request is accepted in the "new" art unit, the "new" supervisory primary examiner assigns the request to an examiner and the "new" group's reexamination clerk marks the Docket Record (DR) and Serial Register (SR) cards and PALMS in the request.

2238 Time Reporting [R-7]

A. Clerical time report

Both the Program Management System (PMS) and Payroll systems now used to monitor clerical time have been modified to report reexamination activities. During the start-up phase of reexamination, Code 1190-50-00-01 should be used to report to PMS. Similarly Project Code 119050 should be used to report start-up time to the Payroll system. These codes should be used for such activities as training, setting up card files, and obtaining supplies. Time devoted to processing actual reexamination files in the groups should be reported using PMS Code 1190-50-00-01 and Project Code 119051. It should be noted that all clerical time consumed by reexamination activities must be reported in the above manner. Such activities as supervision, copying, typing and docketing should be included.

B. Professional time reporting

Reexamination fees are based on full cost recovery and it is essential that all time expended on reexamination activities be reported accurately. Thus, directors, supervisory patent examiners and board members as well as examiners should report time spent on reexamination on their individual Time and Attendance Report (PTO-1411) using the following Project Codes:

- 119050—Used to report all training and start-up activities.
- 119051—Used to report all activities related to a specific reexamination proceeding up until the time ex parte prosecution is begun.
- 119052—Used to report all activities related to a specific reexamination proceeding from the time it is taken up for first, ex parte, action until the issuance of a certificate takes place.

Examiners and SPE's will use the above codes to report their time for reexamination activities on the Examiner's Bi-Weekly Time Worksheet (PTO-690E) by making appropriate entries in the Item 16 space. Time reported

using codes 119050, 119051 and 119052 will also be reported in the Examiner Production System as "Other" time.

2239 Reexamination Ordered at the Commissioner's Initiative [R-7]

37 CFR 1.520 Reexamination at the initiative of the Commissioner. The Commissioner, at any time during the period of enforceability of a patent, may determine whether or not a substantial new question of patentability is raised by patents or printed publications which have been discovered by the Commissioner or which have been brought to the Commissioner's attention even though no request for reexamination has been filed in accordance with § 1.510. The Commissioner may initiate reexamination without a request for reexamination pursuant to § 1.510. Normally requests from outside the Patent and Trademark Office that the Commissioner undertake reexamination on his own initiative will not be considered. Any determination to initiate reexamination under this section will become a part of the official file of the patent and will be given or mailed to the patent owner at the address as provided for in § 1.33(c).

The Commissioner may initiate reexamination without a request being filed and without a fee being paid. Such reexamination may be ordered at any time during the period of enforceability of the patent.

The decision to order reexamination at the Commissioner's initiative is normally made by the Deputy Assistant Commissioner for Patents after a review of all the facts concerning the patent. It may be made by the Commissioner of Patents and Trademarks, Deputy Commissioner or Assistant Commissioner for Patents. The number of such Commissioner initiated orders is expected to be very small.

If an Office employee becomes aware of an unusual fact situation in a patent which he or she considers to clearly warrant reexamination, a memorandum setting forth these facts along with the patent file and any prior art patents or printed publications, should be forwarded to the Deputy Assistant Commissioner for Patents through the supervisory chain of command.

If an order to reexamine is to be issued, the decision is prepared and signed by the Deputy Assistant Commissioner for Patents and the patent file is forwarded to the Reexamination Preprocessing Unit for preparation of the reexamination file and Official Gazette notice.

The decision to order reexamination made in the Office of the Deputy Assistant Commissioner for Patents is *not* mailed by that Office. The Reexamination Preprocessing Unit, once the reexamination file has been prepared and the

Control Number assigned, will mail the decision letter to the patent owner. Prosecution will then proceed without further communication with anyone but the owner.

If the Deputy Assistant Commissioner for Patents refuses to issue an order for reexamination, no record of any consideration of the matter will be placed in the patent file and the patent owner will not be notified.

The Commissioner will not normally consider requests to order reexamination at the Commissioner's initiative received from members of the public. If a member of the public desires reexamination, a request and fee should be filed in accordance with § 1.510.

2240 Decision on Request [R-7]

35 U.S.C. 303. Determination of issue by Commissioner. (a) Within three months following the filing of a request for reexamination under the provisions of section 302 of this title, the Commissioner will determine whether a substantial new question of patentability affecting any claim of the patent concerned is raised by the request, with or without consideration of other patents or printed publications. On his own initiative, and any time, the Commissioner may determine whether a substantial new question of patentability is raised by patents and publications discovered by him or cited under the provisions of section 301 of this title.

(b) A record of the Commissioner's determination under subsection (a) of this section will be placed in the official file of the patent, and a copy promptly will be given or mailed to the owner of record of the patent and to the person requesting reexamination, if any.

(c) A determination by the Commissioner pursuant to subsection (a) of this section that no substantial new question of patentability has been raised will be final and nonappealable. Upon such a determination, the Commissioner may refund a portion of the reexamination fee required under section 302 of this title.

37 CFR 1.515. Determination of the request for reexamination. (a) Within three months following the filing date of a request for reexamination, an examiner will consider the request and determine whether or not a substantial new question of patentability affecting any claim of the patent is raised by the request and the prior art cited therein, with or without consideration of other patents or printed publications. The examiner's determination will be based on the claims in effect at the time of the determination and will become a part of the official file of the patent and will be given or mailed to the patent owner at the address as provided for in § 1.33(c) and to the person requesting reexamination.

(b) Where no substantial new question of patentability has been found, a refund of a portion of the fee for requesting reexamination will be made to the requester in accordance with § 1.26(c).

(c) The requester may seek review by a petition to the Commissioner under § 1.181 within one month of

ing reexamination. Any such petition must comply with § 1.181(b). If no petition is timely filed or if the decision on petition affirms that no substantial new question of patentability has been raised, the determination shall be final and nonappealable.

Prior to making a determination on the request for reexamination, the examiner must review the litigation records maintained in the Law Library to check if the patent has been, or is, involved in litigation. The "Search Notes" box on the reexamination file wrapper should be noted to indicate that the review was conducted and the results thereof. A notation such as "litigation search, no records" or "litigation search, 300 USPQ 1 noted", along with the date and examiner's name should be indicated. If the patent is or was involved in litigation, and a paper referring to the court proceeding has been filed, reference to the paper by number should be made in the "Search Notes" box as "litigation, see paper #1C". If a litigation records search is already noted on the file, the examiner need not repeat or update it.

If litigation has concluded or is taking place in the patent on which a request for reexamination has been filed, the request must be promptly brought to the attention of the group director, who must approve the decision on the request and any examiner's action.

An appropriate review of litigation records in the Law Library includes checking the following sources: (1) the card file of "pending patent suits"; (2) the card file of "decisions rendered" and (3) Shepard's United States Citations in the volumes containing "Patents". All volumes and supplements issued after the patent date should be checked. See also §§ 2207 and 2242.

35 U.S.C. 303 requires that the Commissioner determine whether or not a "substantial new question of patentability" affecting any claim of the patent of which reexamination is desired, is raised in the request within a time period of three months following the filing date of a request. See also § 2241. Such a determination may be made with or without consideration of other patents or printed publications in addition to those cited in the request. No input from the patent owner is considered prior to the determination unless the patent owner filed the request.

The claims in effect at the time of the determination will be the basis for deciding whether a substantial new question of patentability has been raised. (§ 1.515(a)). Amendments which have been presented with the request if by the patent owner or which have been filed in a pending reexamination proceeding in which the certificate has not been issued, or amend-

ments which have been submitted in a reissue application on which no reissue patent has been issued, will not be considered or commented upon when deciding requests.

The decision on the request for reexamination has as its main object either the granting or denial of an order for reexamination. This decision is based on whether or not "a substantial new question of patentability" is found. The final decision as to unpatentability will be made during any reexamination proceedings. Accordingly no prima facie case of unpatentability need be found to grant an order for reexamination. It must be noted, however, that a decision to deny an order for reexamination is equivalent to a holding that the patent claims are patentable over the cited prior art. See § 2242 where there have been prior decisions relating to the patent.

It is only necessary to establish that a substantial new question of patentability exists as to one of the patent claims to order reexamination. In a reexamination, normally all patent claims will be reexamined. However, where there has been a prior federal court decision as to some claims, see § 2242. The decision should discuss all patent claims in order to inform the patent owner of the examiner's position so that a response thereto may be made in the patent owner's statement.

The examiner should indicate insofar as possible, his or her initial position on all the issues identified in the request or by the requester so that comment thereon may be received in the patent owner's statement and in the requester's reply. However, the examiner should not reject claims in the order for reexamination.

Where doubts exist, all questions should be resolved in favor of granting the request for reexamination.

Where a reexamination is pending at the time a second request for reexamination is to be decided, see § 2283.

2241 Time for Deciding Request [R-7]

The determination whether or not to reexamine must be made within three months following the filing date of a request. See 35 U.S.C. 303(a) and 37 CFR 1.515(a). The examiner should pick up a request for decision about six weeks after the request was filed. The decision should be mailed within 2½ months of the filing date of the request. A determination to reexamine may be made at the initiative of the Commissioner at any time during the period of enforceability of a patent. See 35 U.S.C. 303(a) and 37 CFR 1.520.

2242 Criteria for Deciding Request [R-7]

SUBSTANTIAL NEW QUESTION OF PATENTABILITY

The presence or absence of "a substantial new question of patentability" determines whether or not reexamination is ordered. The meaning and scope of the term "a substantial new question of patentability" is not defined in the statute and must be developed to some extent on a case-by-case basis. In making a determination whether or not "a substantial new question of patentability" is present the examiner must consider the materiality of the prior art patents and printed publications to the claims of the patent for which reexamination is requested. If the prior art patents and printed publications are material to the examination of at least one claim of the patent, then a substantial new question of patentability is present, unless it is clear to the examiner that the same question of patentability has already been decided by a federal court or by the Office either in the original examination or an earlier concluded reexamination.

A prior art patent or printed publication is material to the examination of a claim of the patent where there is a substantial likelihood that a reasonable examiner would consider the prior art patent or printed publication important in deciding whether or not the claim is patentable. Thus, in making the determination on the request the examiner should consider the materiality of the prior art patents and/or printed publications and, if they are found to be material, should find "a substantial new question of patentability" unless the same question of patentability has already been decided as to the claim by the Office or a federal court. For example, the same question of patentability may have already been decided by the Office where the examiner finds the additional prior art patents or printed publications are merely cumulative to similar prior art already fully considered by the Office in a previous examination of the claim.

For "a substantial new question of patentability" to be present it is only necessary that (1) the prior art patents and/or printed publications be material to the examination of at least one claim and (2) the same question of patentability as to the claim has not been decided by the Office in a previous examination or by the federal courts in a decision on the merits involving the claim. It is not necessary that a "prima facie" case of unpatentability exist as to the claim in order for "a substantial new question of patentability" to be present

as to the claim. Thus, "a substantial new question of patentability" as to a patent claim could be present even if the examiner would not necessarily reject the claim as either fully anticipated by, or obvious in view of, the prior patents or printed publications. The difference between "a substantial new question of patentability" and a "prima facie" case of unpatentability is important.

In order to further clarify the meaning of "a substantial new question of patentability" certain situations are outlined below which, if present, should be considered when making a decision as to whether or not "a substantial new question of patentability" is present.

POLICY IN SPECIFIC SITUATIONS

1. Prior Favorable Decisions By The Patent and Trademark Office On The Same or Substantially Identical Prior Art In Relation To The Same Patent

If the Office has previously decided the same question of patentability as to a patent claim favorable to the patent owner based on the same or substantially identical prior art patents or printed publications it is unlikely that "a substantial new question of patentability" will be present absent a showing that material new arguments or interpretations raise "a substantial new question of patentability". Material new arguments or interpretations can raise "a substantial new question of patentability" as to prior art patents or printed publications already considered by the Office. However, the "substantial new question" requirement would generally mean that any argument presented which has been already decided by the Office as to a particular claim would not raise "a substantial new question of patentability" as to that claim.

2. Prior Adverse Decisions By The Office On The Same Or Substantially Identical Prior Art In The Same Patent

A prior decision adverse to the patentability of a claim of a patent by the Office based upon prior art patents or printed publications would usually mean that "a substantially new question of patentability" is present. Such an adverse decision by the Office could arise from a reissue application which was abandoned after rejection of the claim and without disclaiming the patent claim.

3. Prior Adverse Reissue Application Final Decisions By A Commissioner Or The Board of Appeals Based Upon Grounds Other Than Patents or Printed Publications

Any prior adverse final decision by a Commissioner, or the Board of Appeals, on an application seeking to reissue the same patent on which

reexamination is requested will be considered by the examiner when determining whether or not a "substantial new question of patentability" is present. To the extent that such prior adverse final decision was based upon grounds other than patents or printed publications the prior adverse final decision will not be considered in determining whether or not a "substantial new question of patentability" is present. If a prior final decision by the Board of Appeals in a reissue application affirmed the rejection of patent claims on grounds other than patents or printed publications, or if the Commissioner has stricken a reissue application pursuant to 37 CFR 1.56(d) because of fraud in obtaining the original patent, such information will be noted on the certificate.

4. Prior Favorable or Adverse Decisions on The Same or Substantially Identical Prior Patents or Printed Publications in Other Cases Not Involving the Patent.

While the Office would consider decisions involving substantially identical patents or printed publications in determining whether a "substantial new question of patentability" is raised, the weight to be given such decisions will depend upon the circumstances. For example, if the Office has used the same or substantially identical prior art to reject the same or similar claims in another application or patent under reexamination, this would be considered as being material in making a determination. Similarly, if a foreign patent office or a foreign court has used the same or substantially identical prior art to reject or invalidate the same or similar claims, this would be considered as being material in making the determination. Likewise, if a United States Court has invalidated similar claims in another patent based on the same or substantially identical prior patents or printed publications, this would be considered as being material in making the determination. Favorable decisions on the same or substantially identical prior patents or printed publications in other cases would be considered, but would not be controlling.

POLICY WHERE A FEDERAL COURT DECISION HAS BEEN ISSUED ON THE PATENT

If a federal court decision *on the merits* of a patent is known to the examiner at the time the determination on the request for reexamination is made, the following guidelines will be followed by the examiner, whether or not the person who filed the request was a party to the litigation:

(1) No substantial new question of patentability will be found based on (1) the same

→ prior art which was before the federal court; (2) prior art which is merely cumulative to that which was before the court; and (3) issues which were actually resolved on the merits by the court.

(2) In making the determination the examiner will compare the prior art and issues raised in the request with the prior art before the federal court and the issues resolved *on the merits* by the court, without regard to either the finality of the court decision or whether the claims were held valid or invalid.

(3) Where the claims were all held *invalid* by a federal court decision *for any reason* no substantial new question of patentability will be found.

(4) Where claims have been held valid by the federal court, reexamination will be ordered by the examiner if (1) additional prior art is relied on which is not merely cumulative to that before the court; (2) the additional prior art raises issues which were not resolved on the merits by the court; and (3) the additional prior art is material to the examination of at least one claim.

(5) Where the patent contains claims in addition to those upon which the federal court ruled, reexamination will be ordered if (1) a substantial new question of patentability as to those additional claims is present and (2) the same question was not resolved by the court in its decision.

(6) In making the determination on a request, a consent judgment that claims are valid will be treated as a decision on the merits insofar as the parties to the litigation (or their proxy) are concerned. A consent judgment of validity or invalidity has no effect as to requests filed by a person not a party to the litigation.

(7) All determinations on requests for reexamination which the examiner makes after a federal court decision must be approved by the examining group director.

Prior Decisions By A Federal Court On The Same Or Substantially Identical Prior Art In Relation To The Same Patent

→ A decision on the merits by a federal court will normally be controlling as to whether or not "a substantial new question of patentability" exists on the same, or substantially the same, prior art. Thus, the Office will not find a "substantial new question of patentability" to be present where the patent owner had obtained a decision, either favorable or adverse, in a federal court on the same or substantially identical prior art. Furthermore, the Office will not find "a substantial new question of patentability" to exist

where such a question has actually been resolved by a federal court on the merits. ←

CLAIMS HELD VALID

Where additional prior art is relied upon in the request, and claims were held valid by the court, consideration will be given as to whether or not the additional prior art is merely cumulative. If the prior art is merely cumulative, no substantial new question of patentability is present. However, if the additional prior art is not cumulative, consideration will be given as to whether or not the additional prior art presents a substantial new question of patentability.

ALL CLAIMS INVALID

Where a federal court decision has held all of the claims in the patent to be invalid for any reason, no substantial new question of patentability will be found by the Patent and Trademark Office, even if material additional prior art is presented in a request. Since a federal court has already decided that the patent claims are invalid, no reason is seen for using Office resources to consider the matter further. The Office will give full faith and credit to the court decision. Reexamination should be denied as there is no substantial new question of patentability.

ONLY SOME CLAIMS INVALID

Where a request for reexamination has been filed in a patent in which a federal court decision has been issued holding less than all of the claims invalid, only those claims not held invalid will be considered to determine if "a substantial new question of patentability" is present.

If reexamination is ordered, the reexamination will only be made as to those claims not held invalid by the court decision. The claims held invalid by the court decision will not be reexamined and the order and certificate will so indicate.

Any situations requiring clarification should be brought to the attention of the Office of the Assistant Commissioner for Patents.

CONSENT JUDGMENT

→ A consent judgment is treated differently than a court decision on the merits. If a request for reexamination is filed by a person who was not a party to the litigation, the request may present a substantial new question of patentability even though the question was agreed upon by the interested parties in the consent judgment. Since an agreement is only binding as to the parties involved, it is not a final resolution of the matter as to other parties. ←

2243 Claims Considered in Deciding Request [R-7]

The claims in effect at the time of the determination will be the basis for deciding whether "a substantial new question of patentability" is present (§ 1.515(a)). While the examiner will ordinarily concentrate on those claims for which reexamination is requested, the finding of "a substantial new question of patentability" can be based upon a claim of the patent other than the ones for which reexamination is requested. For example, the request might seek reexamination of particular claims, but the examiner is not limited to those claims and can make a determination that "a substantial new question of patentability" is present as to other claims in the patent without necessarily finding "a substantial new question" with regard to the claims requested. If a substantial new question of patentability is found as to any claim, reexamination will be ordered and will normally cover all claims except where some claims have been held invalid in a federal court decision on the merits. The decision should discuss all patent claims in order to inform the patent owner of the examiner's position. See § 2242 for patent claims which have been the subject of a prior decision. Amendments or new claims will not be considered or commented upon when deciding a request.

2244 Prior Art on Which the Determination Is Based [R-7]

The determination whether or not "a substantial new question of patentability" is present can be based upon any prior art patents or printed publications. Section 303(a) of the statute and 37 CFR 1.515(a) provide that the determination on a request will be made "with or without consideration of other patents or printed publications," i.e., other than those relied upon in the request. The examiner is not limited in making the determination to the patents and printed publications relied upon in the request. The examiner can find "a substantial new question of patentability" based upon the prior art patents or printed publications relied upon in the request, a combination of the prior art relied upon in the request and other prior art found elsewhere, or based entirely on different patents or printed publications. The primary source of patents and printed publications used in making the determination are those relied upon in the request. However, the examiner can also consider the prior art of record in the patent file from the earlier examination or a reexamination and any patents and printed publications of record in the patent file from

submissions under 37 CFR 1.501 which are in compliance with 37 CFR 1.98 in making the determination. If the examiner believes that additional prior art patents and publications can be readily obtained by searching to supply any deficiencies in the prior art cited in the request the examiner can perform such an additional search. Such a search should be limited to that area most likely to contain the deficiency of the prior art previously considered and should be made only where there is a reasonable likelihood that prior art can be found to supply any deficiency necessary to "a substantial new question of patentability".

The determination should be made on the claims in effect at the time the decision is made (37 CFR 1.515(a)).

Any question as to whether a substantial new question of patentability exists should be resolved in favor of granting the request for reexamination.

2245 Processing of Decision [R-7]

After the examiner has prepared the decision and proofread and signed the typed version, the reexamination file and decision are given to the group's reexamination clerk for processing.

The reexamination clerk then prints the heading on the decision by using the computer terminal and makes 3 copies of any prior art documents not already supplied by or to the patent owner or requester, if the request was made by a party other than the patent owner. If the patent owner filed the request, only 2 copies are required.

A copy of the decision is then mailed to the requester and the patent owner, along with any original signed copy of the decision and a copy of any prior art enclosed is made of record in the reexamination file.

The record cards are updated and the file is returned to the special storage area in the examining group.

2246 Decision Ordering Reexamination [R-7]

35 U.S.C. 304. *Reexamination order by Commissioner.* If, in a determination made under the provisions of subsection 303(a) of this title, the Commissioner finds that a substantial new question of patentability affecting any claim of a patent is raised, the determination will include an order for reexamination of the patent for resolution of the question. The patent owner will be given a reasonable period, not less than two months from the date a copy of the determination is given or mailed to him, within which he may file a statement on such question, including any amendment to his patent and new claim or claims he

may wish to propose, for consideration in the reexamination. If the patent owner files such a statement, he promptly will serve a copy of it on the person who has requested reexamination under the provisions of section 302 of this title. Within a period of two months from the date of service, that person may file and have considered in the reexamination a reply to any statement filed by the patent owner. That person promptly will serve on the patent owner a copy of any reply filed.

37 CFR 1.525. Order to reexamine. (a) If a substantial new question of patentability is found pursuant to §§ 1.515 or 1.520, the determination will include an order for reexamination of the patent for resolution of the question. If the order for reexamination resulted from a petition pursuant to § 1.515(c), the reexamination will ordinarily be conducted by an examiner other than the examiner responsible for the initial determination under § 1.515(a).

(b) If the order for reexamination of the patent mailed to the patent owner at the address as provided for in § 1.33(c) is returned to the Office undelivered, the notice published in the *Official Gazette* under § 1.11(c) will be considered to be constructive notice and reexamination will proceed.

If the request is granted, the examiner will conclude that a substantial new question of patentability has been raised by identifying all claims and issues, the patents or printed publications relied on, and a brief statement of the rationale supporting each new question. In a simple case, this may entail adoption of the reasons provided by the requester. The references relied on by the examiner should be cited on a PTO-892, and a copy of the reference supplied only where it has not been previously supplied to the owner and requester.

The decision granting the request is made on a decision form and will remind the owner and requester of the statutory time periods that they have in which to respond.

Upon determination that a substantial new question of patentability is present, either pursuant to a request under 35 U.S.C. § 302 and §§ 1.515 or a sua sponte determination under 35

U.S.C. § 303(a), second sentence, and § 1.520, the Commissioner issues an order to reexamine. The statutory wording is that:

[T]he determination [that a substantial new question of patentability is raised] will include an order for reexamination of the patent for resolution of the question. [35 U.S.C. § 304, first sentence]

If the request is granted, the examiner must identify at least one substantial new question of patentability and explain how the prior art patents or printed publications raise such a question. The examiner should indicate insofar as possible, his or her initial position on all the issues identified in the request or by the requester (without rejecting claims) so that comment thereon may be received in the patent owner's statement and in the requester's reply. The prior art relied upon should be listed by the examiner on a form PTO-892 if it is not already listed on a form PTO-1449 by the requester.

If arguments are presented as to grounds not based on prior patents or printed publications, such as those based on public use or sale, abandonment under 102(c) the examiner should note that such grounds are improper for reexamination and are not considered or commented upon. See 37 CFR 1.552(c).

Copies of any patents or printed publications relied upon, which have not been previously supplied to the owner and requester, should be included with the decision.

The decision granting a request must set forth the time periods for the patent owner and requester to file their statement and any reply thereto.

The patent owner has no right to petition or request reconsideration of a decision to grant a request for reexamination.

Any prior art citations under § 1.501 submitted after the date of the decision on the order should be retained in a separate file by the reexamination clerk and stored until the reexamination proceeding is terminated, at which time the prior art citation is then entered of record on the patent file.

**UNITED STATES DEPARTMENT OF COMMERCE
Patent and Trademark Office**

 Address: COMMISSIONER OF PATENTS AND TRADEMARKS
Washington, D.C. 20231

REEXAM CONT NO	FILING DATE	PATENT UNDER REEXAMINATION	ATTORNEY DOCKET NO
90/000016	7/02/81	4,444,444	0803071

William Dyre
2400 Jefferson Davis Highway
Arlington, Va. 22222
(patent owner's correspondence address)

EXAMINER	
V. D. Turner	
ART UNIT	PAPER NUMBER
125	5

 DATE MAILED: **SEP 14 1981**
ORDER GRANTING/DENYING REQUEST FOR REEXAMINATION
GROUP 120

The request for reexamination has been considered. Identification of the claims, the references relied on, and the rationale supporting the determination are attached.

 Attachment(s): PTO-892 PTO-1449 Other

ORDER:

1. The request for reexamination is GRANTED.

RESPONSE TIMES ARE SET TO EXPIRE AS FOLLOWS:

 For Patent Owner's Statement:
TWO MONTHS from the date hereof. 37 C.F.R. 1.530(b).

 For Requester's Reply:
TWO MONTHS from the date of service of any patent owner's statement. 37 C.F.R. 1.535.

Notes: If the patent owner does not file a timely statement under 37 C.F.R. 1.530(b), no reply from the reexamination requester will be considered. 37 C.F.R. 1.535.

The patent owner must submit, on a separate paper, the names of the attorneys or agents (maximum of three) which the owner desires to have printed on the reexamination certificate. If no names are submitted, none will appear on the certificate.

2. The request for reexamination is DENIED.

This decision is not appealable. 35 U.S.C. 303(c). Requester may seek review by a petition to the Commissioner within one month from the mailing date hereof. 37 C.F.R. 1.515(c).

In due course, a refund of \$1200.00 will be made by treasury check or by credit to deposit account number _____ to the requester listed below unless notified otherwise. 35 U.S.C. 303(c).

cc: John Doe
12 Seemore Street
New York, New York 10001

(requester's correspondence address)

DECISION

A substantial new question of patentability affecting claims 1-4 of United States patent number 4,444,444 to Smith is raised by the request.

The request indicates the requester considers that claims 1-3 of Smith are fully anticipated by the prior art patent document of Berridge under 35 U.S.C. 102.

It is agreed that the consideration of the Berridge patent document raises a substantial new question of patentability as to claims 1-3 of the Smith patent since the Berridge patent document is clearly material to the examination of the claims of the Smith patent as pointed out in the request.

The Swiss patent to Hotopp and the "American Machinist" prior art documents do not raise a substantial new question of patentability as to claim 4 of the Smith patent and are not material because these prior art documents are considered to be substantial equivalents to the German patent number 7777 of December 25, 1917 to Hotopp and the "Popular Mechanics" magazine article of April 1, 1924 considered by the examiner during the initial prosecution of the application which resulted in the Smith patent. Claim 4 will, however, be reexamined along with all the other claims in the Smith patent.

V. D. Turner
Primary Examiner
Art Unit 125

→ **2247 Decision on Request for Reexamination Denied [R-7]**

The request for reexamination will be denied if a substantial new question of patentability is not found based solely on patents or printed publications.

If the examiner concludes that no substantial new question of patentability has been raised because prior patents or printed publications are not material to the examination of at least one claim (see § 2242), the examiner should indicate why the claims are clearly patentable in a manner similar to that used to indicate reasons for allowance (§ 1302.14). The examiner should also respond to the substance of each argument

raised by the requester which is based on patents or printed publications. If arguments are presented as to grounds not based on prior patents or printed publications, such as those based on public use or sale, or abandonment under 102 (c), the examiner should note that such grounds are improper for reexamination and are not considered or commented upon. See 37 CFR 1.552 (c.)

A copy of any denied request and the decision thereon are made part of the official patent file.

If the denial of the request is not overturned by a petition decision, a refund of \$1,200.00 will be made to the requester under § 1.26(c) after the period for petition has expired.



**UNITED STATES DEPARTMENT OF COMMERCE
Patent and Trademark Office**

Address: COMMISSIONER OF PATENTS AND TRADEMARKS
Washington, D.C. 20231

REEEXAM CONT NO	FILING DATE	PATENT UNDER REEXAMINATION	ATTORNEY DOCKET NO
90/000016	7/02/81	4,444,444	0803071

William Dyre
2400 Jefferson Davis Highway
Arlington, Va. 22222

(patent owner's correspondence address)

EXAMINER	
V. D. Turner	
ART UNIT	PAPER NUMBER
125	5

DATE MAILED: SEP 14 1981

ORDER GRANTING/DENYING REQUEST FOR REEXAMINATION

GROUP 120

The request for reexamination has been considered. Identification of the claims, the references relied on and the rationale supporting the determination is attached.

Attachment(s): PTO-892 PTO-1449 Other

ORDER:

1. The request for reexamination is GRANTED.

RESPONSE TIMES ARE SET TO EXPIRE AS FOLLOWS:

For Patent Owner's Statement:
TWO MONTHS from the date hereof. 37 C.F.R. 1.530(b).

For Requester's Reply:
TWO MONTHS from the date of service of any patent owner's statement. 37 C.F.R. 1.535.

Notes: If the patent owner does not file a timely statement under 37 C.F.R. 1.530(b), no reply from the reexamination requester will be considered. 37 C.F.R. 1.535.

The patent owner must submit, on a separate paper, the names of the attorneys or agents (maximum of three) which the owner desires to have printed on the reexamination certificate. If no names are submitted, none will appear on the certificate.

2. The request for reexamination is DENIED.

This decision is not appealable. 35 U.S.C. 303(c). Requester may seek review by a petition to the Commissioner within one month from the mailing date hereof. 37 C.F.R. 1.515(c).

In due course, a refund of \$1200.00 will be made by treasury check or by credit to deposit account number _____ to the requester listed below unless notified otherwise. 35 U.S.C. 303(c).

cc: John Doe
12 Seemore Street
New York, New York 10001

(requester's correspondence address)

DECISION

No substantial new question of patentability is raised by the request and prior art cited therein for the reasons set forth below.

The claims of the Smith patent for which reexamination is requested define the blades to be no longer than 4 inches and the tips of the blades to be curved. The claims of the Smith patent also define the dies to be grooved to allow their use for crimping operations.

The prior art patent to Berridge is not material to the examination of the claims of the Smith patent since the essential features of the claims of the Smith patent referred to above are not present in Berridge.

An evaluation of the prior art patent document to Berridge as outlined in the request does not appear to meet the terms of the Smith patent. The cutting blades of Berridge are indicated as "being at least six inches long" and the dies of Berridge have smooth, flat surfaces used "to flatten bent washers". There is no suggestion in Berridge that the features claimed by Smith could be present therein and it would not be obvious to a person of ordinary skill in the art to so modify the structure of Berridge. Since the Berridge prior art patent does not disclose a number of the essential features recited in the Smith patent to which the request for reexamination is directed, the Berridge patent is not material to the patentability of the Smith patent and no substantial new question of patentability is raised in view of the Berridge prior art patent document, either taken alone or in combination with other known prior art documents.

V. D. Turner
Primary Examiner
Art Unit 125

2248 Petition From Denial of Request [R-7]

37 CFR 1.515 Determination of the request for reexamination.

(c) The requester may seek review by a petition to the Commissioner under § 1.181 within one month of the mailing date of the examiner's determination refusing reexamination. Any such petition must comply with § 1.181(b). If no petition is timely filed or if the decision on petition affirms that no substantial new question of patentability has been raised, the determination shall be final and nonappealable.

Processing of Petition under 37 CFR 1.515(c)

Once the request for reexamination has been denied, the reexamination file will be stored in the group central files to await a petition. If no petition is filed within one (1) month, the file is forwarded to the Office of Finance for a refund. If a petition is filed, it is forwarded to the office of the group director for decision.

The director's review will be de novo. Each decision by the group director will conclude with the paragraph:

"This decision is final and nonappealable. 37 CFR 1.515(c). No further communication on this matter will be acknowledged or considered."

If the petition is granted, the reexamination file will be returned to the supervisory primary examiner of the art unit that will handle reexamination for consideration of reassignment to another examiner.

Reassignment will be the general rule and only in exceptional circumstances where no other examiner is available and capable to give a proper examination will the case remain with the original examiner. If the original determination is signed by the supervisory primary examiner, the reexamination ordered by the director will be assigned to a primary examiner.

The requester may seek review of a *denial* of a request for reexamination by petitioning the Commissioner under §§ 1.515(c) and 1.181 within one month of the mailing date of the decision denying the request for reexamination. Any such petition must comply with § 1.181(b). Any request for an extension of time to file a petition under § 1.515(c) should be granted only in extraordinary situations. No petition may be filed requesting review of a decision *granting* a request for reexamination.

After the time for petition has expired without a petition having been filed, or a petition has been filed and the decision thereon affirms the denial of the request, a refund of \$1200.00

of the \$1500.00 fee for requesting reexamination will be made to the requester. (35 U.S.C. 303(c) and 37 CFR 1.26(c)). A decision on a petition is final and is not appealable.

2249 Patent Owner's Statement [R-7]

37 CFR 1.530 Statement and amendment by patent owner. (a) Except as provided in § 1.510(e), no statement or other response by the patent owner shall be filed prior to the determinations made in accordance with §§ 1.515 or 1.520. If a premature statement or other response is filed by the patent owner it will not be acknowledged or considered in making the determination.

(b) The order for reexamination will set a period of not less than two months from the date of the order within which the patent owner may file a statement on the new question of patentability including any proposed amendments the patent owner wishes to make.

(c) Any statement filed by the patent owner shall clearly point out why the subject matter as claimed is not anticipated or rendered obvious by the prior art patents or printed publications, either alone or in any reasonable combinations. Any statement filed must be served upon the reexamination requester in accordance with § 1.248.

(d) Any proposed amendments to the description and claims must be made in accordance with § 1.121(f). No amendment may enlarge the scope of the claims of the patent or introduce new matter. No amendment or new claims may be proposed for entry in an expired patent. Moreover, no amended or new claims will be incorporated into the patent by certificate issued after the expiration of the patent.

(e) Although the Office actions will treat proposed amendments as though they have been entered, the proposed amendments will not be effective until the reexamination certificate is issued.

The patent owner has no right to file a statement subsequent to the filing of the request but prior to the order for reexamination. Any such premature statement will not be acknowledged or considered by the Office when making the decision on the request. See § 2225.

If reexamination is ordered, the decision will set a period of not less than two months within which period the patent owner may file a statement and any narrowing amendments to the patent claims. If necessary, an extension of time beyond the two months may be requested by the patent owner. Such requests are decided by the group directors.

Any statement filed must clearly point out why the patent claims are believed to be patentable, considering the cited prior art patents or printed publications alone or in any reasonable combination.

➤ A copy of the statement must be served on the requester, if the request was not filed by the patent owner.

In the event the decision is made to reexamine, the patent statute (Section 304) provides that the owner will have a period, not less than two months (minimum time), to file a statement directed to the issue of patentability. Since the two month period is the minimum provided by statute, first extensions may be granted up to one (1) month based upon good and sufficient reasons. Further extensions should be granted only in the most extraordinary situations e.g. death or incapacitation of the representative or owner.

Lack of proof of service poses a problem especially where the patent owner fails to indicate that he or she has served the requester in the statement subsequent to the order for reexamination (37 CFR 1.530(c)). In this situation, the Reexamination Clerk should immediately contact the patent owner by telephone to see whether the indication of proof of service was inadvertently omitted from the patent owner's response. If it was, the patent owner should be advised to submit a supplemental paper indicating the manner and date of service on requester. If the patent owner cannot be contacted, the Reexamination Clerk will then contact the requester to verify that service has in fact been made by the patent owner and indicate that acknowledgement of proof of service should accompany requester's reply (37 CFR 1.248(b)(1)). If the two month period for response under 37 CFR 1.530 has expired and requester has not been served, the patent owner's statement is considered inappropriate (37 CFR 1.248) and may be denied consideration, see § 2267.

It should be noted that the period for response by requester for a reply under 37 CFR 1.535 is two months from the owner's service date and not two months from the date the patent owner's statement was received in the Patent and Trademark Office.

2250 Amendment by Patent Owner [R-7]

37 CFR 1.121 Manner of making amendments.

(f) Proposed amendments presented in patents involved in reexamination proceedings must be presented in the form of a full copy of the text of (1) each claim which is amended and (2) each paragraph of the description which is amended. Matter deleted from the patent shall be placed between brackets and matter added shall be underlined. Copies of the printed claims from the patent may be used with any additions being indicated by carets and deleted material being placed

between brackets. Claims must not be renumbered and the numbering of the claims added for reexamination must follow the number of the highest numbered patent claim. No amendment may enlarge the scope of the claims of the patent. No new matter may be introduced into the patent.

Amendments to the patent may be filed by the patent owner. Such amendments, however, may not enlarge the scope of the claims of the patent or introduce new matter. Additional claims may also be added by amendment without any fee. Any amendment proposed will normally be entered and be considered to be entered for purposes of prosecution before the Office, however, the amendments do not become effective in the patent until the certificate under 35 U.S.C. 307 is issued.

No amendment will be permitted where the certificate issues after expiration of the patent. See § 1.530 (d) and (e).

Amendment Entry—Amendments which comply with 37 CFR 1.121(f) will be entered in the reexamination file wrapper in much the same way as amendments are entered in reissue applications. An amendment will be given a Paper Number and be designated by consecutive letters of the alphabet (A, B, C, etc.). Inserts will be placed in original text by using carets at appropriate column and line of the patent together with the amendment letter. Deletions will be indicated by inserting brackets [] around the deleted material together with an indication of the amendment letter.

Amendments in reexamination proceedings must be presented in the form of a full copy of the text of each claim which is amended and each paragraph of the description which is amended.

No renumbering of patent claims is permitted.

Additional claims added during reexamination must follow consecutively the number of the highest numbered patent claim. If the patent expires during the ex parte reexamination procedure and the patent claims have been amended, the Office will hold the amendments as being improper and all subsequent reexamination will be on the basis of the unamended patent claims. This procedure is necessary since no amendments will be incorporated into the patent by certificate after the expiration of the patent.

2251 Reply by Requester [R-7]

37 CFR 1.535 Reply by requester. A reply to the patent owner's statement under § 1.530 may be filed by the reexamination requester within two months from the date of service of the patent owner's statement. Any reply by the requester must be served upon the patent owner in accordance with § 1.248. If the patent

owner does not file a statement under § 1.530, no reply or other submission from the reexamination requester will be considered.

If the patent owner files a statement in a timely manner, the requester is given a period of 2 months from the date of service to reply. Since the statute (Section 304) did not provide this as a minimum time period, there will be no extensions of time granted.

If no statement is filed by the patent owner, no reply is permitted from the requester.

A copy of any reply by the requester must be served on the patent owner.

The requester is not permitted to file any further papers after his or her reply to the patent owner's statement. Any further papers will not be acknowledged or considered.

2252 Consideration of Statement and Reply [R-7]

37 CFR 1.540 Consideration of responses. The failure to timely file or serve the documents set forth in § 1.530 or in § 1.535 may result in their being refused consideration. No submissions other than the statement pursuant to § 1.530 and the reply by the requester pursuant to § 1.535 will be considered prior to examination.

Although § 1.540 would appear to be discretionary in stating that late responses "may result in their being refused consideration", patent owners and requesters can expect consideration to be refused if the statement and/or reply is not timely filed. Section 1.540 restricts the number and kind of submissions to be considered prior to examination to those expressly provided for in §§ 1.530 and 1.535. Untimely submissions will ordinarily not be considered. Untimely submissions, other than untimely papers filed by the patent owner after the period set for response, will not be placed of record in the reexamination file, but will be returned to the sender.

Papers filed in which no proof of service is included and proof of service is required, may be denied consideration. Where no proof of service is included, inquiry should be made of the sender by the reexamination clerk as to whether service was in fact made. If no service was made the paper is placed in the reexamination file but is not considered, see § 2267.

2253 Consideration by Examiner [R-7]

Once reexamination is ordered, any submissions properly filed and served in accordance with §§ 1.530 and 1.535 will be considered by the primary examiner when preparing the first

Office action. The examiner will be guided in his or her consideration by the provisions of § 1.121 (f) with respect to any proposed amendments by the patent owner to the description and claims and by § 1.530(c) regarding the patent owner's statement. If the requester's reply to the patent owner's statement raises issues not previously presented, such issues will be treated by the examiner in an Office action pursuant to § 1.552(c), if not within the scope of reexamination.

2254 Conduct of Reexamination Proceedings [R-7]

35 U.S.C. 305. Conduct of reexamination proceedings. After the times for filing the statement and reply provided for by section 304 of this title have expired, reexamination will be conducted according to the procedures established for initial examination under the provisions of sections 132 and 133 of this title. In any reexamination proceeding under this chapter, the patent owner will be permitted to propose any amendment to his patent and a new claim or claims thereto, in order to distinguish the invention as claimed from the prior art cited under the provisions of section 301 of this title, or in response to a decision adverse to the patentability of a claim of a patent. No proposed amended or new claim enlarging the scope of a claim of the patent will be permitted in a reexamination proceeding under this chapter. All reexamination proceedings under this section, including any appeal to the Board of Appeals, will be conducted with special dispatch within the Office.

37 CFR 1.550 Conduct of reexamination proceedings. (a) All reexamination proceedings, including any appeals to the Board of Appeals, will be conducted with special dispatch within the Office. After issuance of the reexamination order and expiration of the time for submitting any responses thereto, the examination will be conducted in accordance with §§ 1.104-1.119 and will result in the issuance of a reexamination certificate under § 1.570.

(b) The patent owner will be given at least 30 days to respond to any Office action. Such response may include further statements in response to any rejections and/or proposed amendments or new claims to place the patent in a condition where all the claims, if amended as proposed, would be patentable.

(c) The time for reply set in paragraph (b) of this section will be extended only for sufficient cause, and for a reasonable time specified. Any request for such extension must be filed on or before the day on which action by the patent owner is due, but in no case will the mere filing of the request effect any extension.

(d) If the patent owner fails to file a timely and appropriate response to any Office action, the reexamination proceeding will be terminated and the Com-

missioner will proceed to issue a certificate under § 1.570 in accordance with the last action of the Office.

(e) The reexamination requester will be sent copies of Office actions issued during the reexamination proceeding. Any document filed by the patent owner must be served on the requester in the manner provided in § 1.248. The document must reflect service or the document may be refused consideration by the Office. The active participation of the reexamination requester ends with the reply pursuant to § 1.535, and no further submissions on behalf of the reexamination requester will be acknowledged or considered. Further, no submissions on behalf of any third parties will be acknowledged or considered unless such submissions are (1) in accordance with § 1.510 or (2) entered in the patent file prior to the date of the order to reexamine pursuant to § 1.525. Submissions by third parties, filed after the date of the order to reexamine pursuant to § 1.525, must meet the requirements of and will be treated in accordance with § 1.501(a).

Once reexamination is ordered and the times for submitting any responses thereto have expired, no further active participation by a reexamination requester is allowed and no third party submissions will be acknowledged or considered unless they are in accordance with § 1.510. The reexamination proceedings will be ex parte because this was the intention of the legislation. Ex parte proceedings also prevent extra proceedings and reduce possible harassment of the patent owner. The examination will be conducted in accordance with §§ 1.104–1.119 (35 U.S.C. 132 and 133) and will result in the issuance of a reexamination certificate under § 1.570. The proceeding shall be conducted with special dispatch within the Office pursuant to 35 U.S.C. 305, last sentence. A full search will not be made routinely by the examiner. The reexamination requester will be sent copies of Office actions and the patent owner must serve responses on the requester. Citations submitted in the patent file prior to issuance of an order for reexamination will be considered by the examiner during the reexamination. Reexamination will proceed even if the order is returned undelivered. The notice under § 1.11(c) is constructive notice and lack of response from the patent owner will not delay reexamination.

2255 Who Reexamines [R-7]

The examination will ordinarily be conducted by the same primary examiner in the examining groups who made the decision on whether the reexamination request should be granted. See § 2236.

However if a petition under 37 CFR 1.515 (c) is granted, the reexamination will normally be conducted by another examiner, see § 2248.

2256 Prior Art Patents and Printed Publications Considered by Examiner in Reexamination [R-7]

The primary source of prior art will be the patents and printed publications cited in the request.

The examiner must also consider patents and printed publications

- cited by a reexamination requester under § 1.510
- cited in patent owner's statement under § 1.530 or a requester's reply under § 1.535 if they comply with § 1.98
- cited by patent owner under a duty of disclosure (§ 1.555) in compliance with § 1.98
- discovered by the examiner in searching
- of record in the patent file from earlier examination
- of record in patent file from § 1.501 submission prior to date of an order if it complies with § 1.98

The reexamination file will indicate which prior art patents and printed publications the examiner has considered during ex parte examination.

2257 Listing of Prior Art [R-7]

The examiner must list on a form PTO-892, if not already listed on a form PTO-1449, all prior patents or printed publications which have been

1. cited by the reexamination requester in the request under § 1.510,
2. cited by the patent owner in the statement under § 1.530 if the citation complies with § 1.98,
3. cited by the reexamination requester in the reply under § 1.535 if the citation complies with § 1.98, and
4. cited by the patent owner under the duty of disclosure requirements of § 1.555 if the citation complies with § 1.98.

The examiner must also list on a form PTO-892 all prior patents or printed publications which have been cited in the decision on the request, or applied in making rejections or cited as being pertinent during the reexamination proceedings. Such prior patents or printed publications may have come to the examiner's attention because:

1. they were of record in the patent file due to a prior art submission under § 1.501 which was received prior to the date of the order,

2. they were of record in the patent file as result of earlier examination proceedings, or
3. they were discovered by the examiner during a prior art search.

In instances where the examiner considers but does not wish to cite documents of record in the patent file, notations should be made in the re-examination file in the manner set forth in § 717.05, items B5, C1 and C2.

All citations listed on form PTO-892 and all citations not lined out on any form PTO-1449 will be printed on the reexamination certificate under "References cited".

2258 Scope of Reexamination [R-7]

37 CFR 1.552 Scope of reexamination in reexamination proceedings. (a) Patent claims will be reexamined on the basis of patents or printed publications.

(b) Amended or new claims presented during a reexamination proceeding must not enlarge the scope of the claims of the patent and will be examined on the basis of patents or printed publications and also for compliance with the requirements of 35 U.S.C. 112 and the new matter prohibition of 35 U.S.C. 132.

(c) Questions other than those indicated in paragraphs (a) and (b) of this section will not be resolved in a reexamination proceeding. If such questions are discovered during a reexamination proceeding, the existence of such questions will be noted by the examiner in an Office action, in which case the patent owner may desire to consider the advisability of filing a reissue application to have such questions considered and resolved.

Rejections on prior art in reexamination proceedings may only be made on the basis of prior patents or printed publications. Prior art rejections may be based upon the following portions of 35 U.S.C. 102:

"(a) . . . patented or described in a printed publication in this or a foreign country, before the invention thereof by the applicant for patent, or"

"(b) the invention was patented or described in a printed publication in this or a foreign country . . . more than one year prior to the date of the application for patent in the United States, or"

"(d) the invention was first patented or caused to be patented, or was the subject of an inventor's certificate, by the applicant or his legal representatives or assigns in a foreign country prior to the date of the application for patent in this country on an application for patent or inventor's certificate filed more than twelve months before the filing of the application in the United States, or"

"(e) the invention was described in a patent granted on an application for patent by another filed in the

United States before the invention thereof by the applicant for patent, or on an international application by another who has fulfilled the requirements of paragraphs (1), (2), and (4) of section 371(c) of this title before the invention thereof by the applicant for patent."

Similarly, rejections in reexamination proceedings may also be made under 35 U.S.C. 103 which are based on the above indicated portions of section 102.

In addition to the above quoted paragraphs of § 102, where two patented inventions have a common assignee and different inventive entities, the prior invention of another disclosed in one of the patents could be available under 35 U.S.C. 103 as prior art by virtue of 35 U.S.C. 102(g) against the other and serve as the basis for a rejection, see for example, *In re Bass*, 177 USPQ 178, (CCPA, 1973).

Rejections will not be based on matters other than patents or printed publications, such as public use or sale, inventorship, § 101, fraud, etc. A rejection on prior public use or sale, insufficiency of disclosure, etc. cannot be made even if it relies upon a prior patent or printed publication. Prior patents or printed publications must be applied under an appropriate portion of § 102 and/or 103 when making a rejection.

Rejections may be made in reexamination proceedings based on intervening patents or printed publications where the patent claims under reexamination are entitled only to the filing date of the patent and are not supported by an earlier foreign or United States patent application whose filing date is claimed. For example, under 35 U.S.C. 120, the effective date of the claims would be the filing date of the application which resulted in the patent. Intervening patents or printed publications are available as prior art under *In re Ruscetta*, 118 USPQ 101 (CCPA, 1958).

Original patent claims which are presented for reexamination will be examined *only* on the basis of prior art patents or printed publications applied under the appropriate parts of 35 U.S.C. 102 and 103. See § 2217.

Where some of the patent claims in a patent being reexamined have been the subject of a prior Office or court decision, see § 2242. Where other proceedings involving the patent are copending with the reexamination proceeding, see §§ 2282-2286.

New claims will be examined on the basis of prior art patents or printed publications and for compliance with 35 U.S.C. 112 including the new matter prohibitions. Amended claims will be examined on the basis of prior art patents and printed publications and for compliance

with 35 U.S.C. 112, to the extent that the amendatory matter raises an issue under 35 U.S.C. 112.

The examiner should be aware that new or amended claims are to be examined for compliance with 35 U.S.C. 112 and that consideration of 35 U.S.C. 112 issues should be limited to the amendatory (i.e., new language) matter. For example, a claim which is amended or a new claim which is presented containing a limitation not found in the original patent claim should be considered for compliance under 35 U.S.C. 112 only with respect to that limitation. To go further would be inconsistent with the statute to the extent that 35 U.S.C. 112 issues would be raised as to matter in the original patent claim. Thus, a term in a patent claim which the examiner might deem to be too broad cannot be considered as too broad in a new or amended claim *unless* the amendatory matter in the new or amended claim creates the issue.

Although a request for reexamination may not specify all claims as presenting a substantial new question, each claim of the patent normally will be reexamined. The resulting reexamination certificate will indicate the status of all of the patent claims and any added patentable claims.

Restriction requirements cannot be made in a reexamination proceeding since no statutory basis exists therefor, and no new or amended claims enlarging the scope of a claim of the patent are permitted.

There are matters ancillary to reexamination which are necessary and incident to patentability which will be considered. Amendments may be made to the specification to correct, for example, an inadvertent failure to claim foreign priority or the continuing status of the patent relative to a parent application if such correction is necessary to overcome a reference applied against a claim of the patent. No renewal of previously made claims for foreign priority under 35 U.S.C. 119 or continuing status of the application under 35 U.S.C. 120, is necessary during reexamination. Correction of inventorship may also be made during reexamination.

Patent claims not subject to reexamination because of their prior adjudication by a court should be identified.

All added claims will be examined.

Where grounds set forth in a prior Office or federal court decision, which are not based on patents or printed publications clearly raise questions as to the claims, the examiner's Office action should clearly state that the claims have not been examined as to those grounds not based on patents or printed publications stated in the prior decision. See § 1.552(c). All claims under reexamination should, however, be reexamined on the basis of prior patents and printed publications.

If questions other than those indicated above (for example, questions of patentability based on public use or sale, fraud, abandonment under 102(c), etc.) are discovered during a reexamination proceeding, the existence of such questions will be noted by the examiner in an Office action, in which case the patent owner may desire to consider the advisability of filing a reissue application to have such questions considered and resolved. Such questions could arise in a reexamination requester's § 1.510 request or in a § 1.535 reply by the requester.

2259 Collateral Estoppel In Reexamination Proceedings [R-7]

Sections 2242 and 2286 relate to the Office policy controlling the determination on a request for reexamination and subsequent reexamination where there has been a federal court decision on the merits as to the patent for which reexamination is requested. Since claims held invalid by a federal court will be withdrawn from consideration and not reexamined during a reexamination proceeding, no rejection on the grounds of collateral estoppel will be appropriate in reexamination.

2260 Office Actions [R-7]

37 CFR 1.104 Nature of examination, examiner's action reads in part:

(a) On taking up . . . a patent in a reexamination proceeding, the examiner shall make a thorough study thereof and shall make a thorough investigation of the available prior art relating to the subject matter of the claimed invention. The examination shall be complete with respect both to compliance of the . . . patent under reexamination with the applicable statutes and rules and to the patentability of the invention as claimed, as well as with respect to matters of form, unless otherwise indicated.

(b) . . . in the case of a reexamination proceeding, both the patent owner and the requester, will be notified of the examiner's action. The reasons for any adverse action or any objection or requirement will be stated and such information or references will be given as may be useful in aiding the . . . patent owner, to judge the propriety of continuing prosecution.

It is intended that the examiner's first ex parte action on the merits be the primary action to establish the issues which exist between the examiner and the patent owner insofar as the patent is concerned. At the time the first action is issued the patent owner has already been permitted to file a statement and an amendment pursuant to § 1.530 and the reexamination requester, if the requester is not the patent owner, has been permitted to reply thereto pursuant to

§ 1.535. Thus, at this point, the issues should be sufficiently focused to enable the examiner to make a definitive first ex parte action on the merits which should clearly establish the issues which exist between the examiner and the patent owner insofar as the patent is concerned. In view of the fact that the examiner's first action will clearly establish the issues, the first action should include a statement cautioning the patent owner that a complete response should be made to the action since the next action is expected to be a final rejection. The first action should further caution the patent owner that the requirements of 37 CFR 1.116(b) will be strictly enforced after final rejection and that any amendments after final rejection must include "a showing of good and sufficient reasons why they are necessary and were not earlier presented" in order to be considered. The following language should be appropriate for inclusion in the first Office action:

"In order to ensure full consideration of any amendments, affidavits or declarations, or other documents as evidence of patentability, such documents *must* be submitted in response to this Office action. Submissions after the next Office action, which is intended to be a final action, will be governed by the strict requirements of 37 CFR 1.116, which will be strictly enforced."

2261 Special Status For Action [R-7]

35 U.S.C. 305. Conduct of reexamination proceedings.

* * * * *

All reexamination proceedings under this section, including any appeal to the Board of Appeals, will be conducted with special dispatch within the Office.

In view of the requirement for "special dispatch" reexamination proceedings will be "special" throughout their pendency in the Office. The examiner's first action on the merits should be completed within *one month* of the filing date of the requester's reply (§ 1.535), or within *one month* of the filing date of the

patent owner's statement (§ 1.530) if there is no requester other than the patent owner. If no submissions are made under either §§ 1.530 or 1.535 the first action on the merits should be completed within *one month* of any due date for such submission. Mailing of the first action should occur within *6 weeks* after the appropriate filing or due date of any statement and any reply thereto.

Any case involved in litigation, whether they are reexamination proceedings or reissue applications, will have priority over all other cases. Reexamination proceedings not involved in litigation will have priority over all other cases except reexaminations or reissues involved in litigation.

2262 Form and Content of Office Action [R-7]

The examiner's first Office action will be a statement of the examiner's position and should be so complete that the second can properly be made a final action. See § 2271.

All Office actions are to be written or dictated and then typed. The first Office action must be sufficiently detailed that the pertinency and manner of applying the cited prior art to the claims is clearly set forth therein. If the examiner concludes that one or more of the claims are patentable over the cited patents or printed publications, the examiner should indicate why the claim(s) is clearly patentable in a manner similar to that used to indicate reasons for allowance (§ 1302.14). The first action should also respond to the substance of each argument raised by the patent owner and requester pursuant to §§ 1.510, 1.530, and 1.535. If arguments are presented which are inappropriate in reexamination, they should be treated in accordance with § 1.552(c). It is especially important that the examiner's action in reexamination be thorough and complete in view of the finality of a reexamination proceeding and the patent owner's inability to file a continuation proceeding.

A sample of a first Office action in reexamination proceedings is set forth below:



UNITED STATES DEPARTMENT OF COMMERCE
Patent and Trademark Office

Address: COMMISSIONER OF PATENTS AND TRADEMARKS
Washington, D.C. 20231

REEXAM CONT NO	FILING DATE	PATENT UNDER REEXAMINATION	ATTORNEY DOCKET NO
90/000016	7/02/81	4,444,444	0803071

William Dyre
2400 Jefferson Davis Highway
Arlington, Virginia 22202

(patent owner's correspondence address)

EXAMINER	
V.D. Turner	
ART UNIT	PAPER NUMBER
125	9

DATE MAILED:

MAILED

SEP 25 1981

GROUP 120

This is a communication from the examiner in charge of this reexamination.
COMMISSIONER OF PATENTS AND TRADEMARKS

Responsive to the communication(s) filed on July 2, 1981. This action is made final.
A shortened statutory period for response to this action is set to expire _____ month(s), _____ days from the date of this letter. Failure to respond within the period for response will cause termination of the proceeding and issuance of a reexamination certificate in accordance with this action. 37 CFR 1.350(a).

Part 3 THE FOLLOWING ATTACHMENT(S) ARE PART OF THIS ACTION:

- 1. Notice of References Cited by Examiner, PTO-892
- 2. Notice of Informal Patent Drawing, PTO-948
- 3. Notice of References Cited, PTO-1449
- 4. _____

Part 23 SUMMARY OF ACTION:

- 1. Claims 4-6 are subject to reexamination.
- 1.a. Claims 1-3 are not subject to reexamination.
- 2. Claims _____ have been cancelled.
- 3. Claims _____ are confirmed.
- 4. Claims 5 are ~~allowed~~ **patentable**.
- 5. Claims 4 and 6 are rejected.
- 6. Claims _____ are objected to.
- 7. The formal drawings filed on _____ are acceptable.
- 8. The drawing correction request filed on _____ has been approved. disapproved.
- 9. Acknowledgment is made of the claim for priority under 35 U.S.C. 119. The certified copy has been received. not been received. been filed in parent application, Serial Number _____ filed on _____.
- 10. Since this proceeding appears to be in condition for issuance of a reexamination certificate except for formal matters, prosecution as to the merits is closed in accordance with the practice under Ex Parte Quayle, 1935 C.D. 11, 435 O.G. 213.
- 11. Other

Reexam Cont. No. 90/000016

-2- ↗

Claims 1-3 are not being reexamined in view of the decision in A.B.C. Corp. v. Smith in 1978, published at 300 USPQ 1.

Claim 4 and new claim 6 are rejected as being unpatentable over Berridge in view of McGee under 35 U.S.C. 103. Berridge discloses a cutting tool similar to that claimed by Smith, which has pivotal handles with cutting blades and a pair of cutting dies with flat faces being mounted on and projecting at right angles to the plane of the handles. McGee also discloses a cutting tool having a pair of pivotal handles at one end and with jaws at the opposite end, and a pair of dies with mating faces designed for crimping projecting from the jaws of the pliers. To provide the cutting tool of Berridge with dies for crimping as in McGee in place of the flat die surfaces would be obvious to a person having ordinary skill in the art.

Claim 5 avoids the prior patents and printed publications and is patentable thereover. Claim 5 recites crimping dies in which the grooves are aligned with the pivot axis of the handles. This structure is not shown or taught in the prior art. ↴

Reexam Cont. No. 90/000016

-3-

Newly added claim 6 also appears to involve a question of patentability based on the ground of prior public use raised in the above cited final decision. This issue is not being resolved in the Patent and Trademark Office in this reexamination proceeding but may be resolved before the Office by filing a reissue application (37 CFR 1.552(c)).

The Swiss patent to Hotopp and "American Machinest" magazine article are made of record to show cutting tool devices similar to that claimed in the patent to Smith.

In order to ensure full consideration of any amendments, affidavits, or declarations, or other documents as evidence of patentability, such documents must be submitted in response to this Office action. Submissions after the next Office action, which is intended to be a final action, will be governed by the strict requirements of 37 CFR 1.116, which will be strictly enforced.

cc: Requester

V.D. Turner
V. D. Turner
Primary Examiner
Art Unit 125

FORM PTO-892 (REV. 3-78)		U.S. DEPARTMENT OF COMMERCE PATENT AND TRADEMARK OFFICE			Reexam Cont.No. 90/000016	GROUP UNIT 125	ATTACHMENT TO PAPER NUMBER 9					
NOTICE OF REFERENCES CITED					Patent Owner Smith							
U.S. PATENT DOCUMENTS												
•	DOCUMENT NO.				DATE	NAME	CLASS	SUB-CLASS	FILING DATE IF APPROPRIATE			
A	2	7	2	2	7	9	4	5/34	McGee	140	106	
B	2	5	8	5	4	1	2	4/33	Weid et al	140	106	
C	3	6	2	5	2	9	1	6/36	Paulk et al	140	105	
D												
E												
F												
G												
H												
I												
J												
K												
FOREIGN PATENT DOCUMENTS												
•	DOCUMENT NO.				DATE	COUNTRY	NAME	CLASS	SUB-CLASS	PERTINENT SMTS. PP. DWG. SPEC.		
L												
M												
N												
O												
P												
Q												
OTHER REFERENCES (Including Author, Title, Date, Pertinent Pages, Etc.)												
R												
S												
T												
U												
EXAMINER					DATE							
V. D. Turner					06/20/81							
* A copy of this reference is not being furnished with this office action. (See Manual of Patent Examining Procedure, section 707.05 (a).)												

FORM PTO-1449 (REV. 7-80)		U.S. DEPARTMENT OF COMMERCE PATENT AND TRADEMARK OFFICE			ATTY. DOCKET NO.	Patent No. 4,444,444						
LIST OF PRIOR ART CITED <i>(Use several sheets if necessary)</i>					Patent Owner Joseph Smith							
					Issue Date July 7, 1977		GROUP					
U.S. PATENT DOCUMENTS												
EXAMINER INITIAL	AA	DOCUMENT NUMBER					DATE	NAME	CLASS	SUBCLASS	FILING DATE IF APPROPRIATE	
		5	9	4	2	2	5					11-1897
VDS							BERRIDGE	140	106			
	AB											
	AC											
	AD											
	AE											
	AF											
	AG											
	AH											
	AI											
	AJ											
	AK											
FOREIGN PATENT DOCUMENTS												
EXAMINER INITIAL	AL	DOCUMENT NUMBER					DATE	COUNTRY	CLASS	SUBCLASS	TRANSLATION	
		8	0	5	5	5	10-1918				YES	NO
VDS							SWITZERLAND	—	—	X		
	AM											
	AN											
	AO											
	AP											
OTHER PRIOR ART (Including Author, Title, Date, Pertinent Pages, Etc.)												
VDS	AR	"American Machinist" magazine, October 16, 1950 issue, page 169 (copy located in class 72, subclass 409)										
	AS											
	AT											
EXAMINER Vincent D. TURNER						DATE CONSIDERED Sept. 14, 1981						
*EXAMINER: Initial if reference considered, whether or not citation is in conformance with MPEP 609; Draw line through citation if not in conformance and not considered. Include copy of this form with next communication												

2263 Time for Response [R-7]

A shortened statutory period of TWO MONTHS will be set for response to Office actions, except where the reexamination results from a court order or litigation is stayed for purposes of reexamination, in which case the shortened statutory period will be set at one month. See § 2286.

Where a reexamination proceeding has been stayed because of a copending reissue application, and the reissue application is abandoned, all actions in the reexamination after the stay has been removed will set a one month shortened statutory period unless a longer period for response is clearly warranted by nature of the examiner's action, see § 2285.

2264 Mailing of Office Actions [R-7]

All forms will be structured so that the printer can be used to print the identifying information for the reexamination file and the owner's name and address—usually the legal representative, and only the first owner where there are multiple owners. The forms granting or denying the request for reexamination will have the requester's name and address at the bottom left hand corner so as to provide the patent owner with requester's name and address. All actions will have a courtesy copy mailed to the requester by typing "cc Requester" at the bottom of each action. A transmittal form is used for each requester and owner in addition to the one named on the top of the Office action.

The transmittal form will be used as a master to make a copy to be sent with the Office action to the requester and any additional owner. The number of transmittal form(s) provide a ready reference for the number of copies to be made with each action and allow use of the window envelopes.

When the requester is the patent owner, the reexamination clerk will indicate on the file wrapper: No copies needed—Requester is Owner. A transmittal form could also be placed inside the file with a similar notation to alert typists, the examiner, and anyone else taking part in the processing of the application that no additional copies are needed.

2265 Extension of Time [R-7]

It should be carefully noted that the Commissioner has no authority to extend any period for response unless the request for the extension is filed on or before the day on which the response is due. Requests for an extension

of time in a reexamination proceeding will be considered only after the decision to grant or deny reexamination is mailed. Any request filed before that decision will be denied. The certificate of mailing (37 CFR 1.8) may be used to file any paper in a reexamination proceeding (see § 2266).

With the exception of an automatic one month extension of time to take further action which will be granted upon filing a first timely response to a final Office action, all requests for extensions of time in a reexamination proceeding will be decided by the group director of the patent examining group conducting the reexamination proceeding. Evaluation of whether sufficient cause has been shown for an extension must be made in the context of providing the patent owner with a fair opportunity to present an argument against any attack on the patent, and the requirement of the statute (35 U.S.C. 305) that the proceedings be conducted with special dispatch. In no case, except in the after final practice noted above, will the mere filing of a request effect any extension.

Any request for an extension of time in a reexamination proceeding must fully state the reasons therefor. All requests must be submitted in a separate paper which will be forwarded to the group director for action. Since the reexamination examination process is intended to be essentially ex parte, the party requesting reexamination can anticipate that requests for an extension of time to file a petition under 37 CFR 1.515(c) will be granted only in extraordinary situations. No extensions will be permitted to the time for filing a reply under § 1.535 by the requester in view of the two month statutory period.

Ex parte prosecution will be conducted by initially setting either a one or a two month shortened period for response, see § 2263. The patent owner also will be given a two-month statutory period after the order for reexamination to file a statement. 37 CFR 1.530(b). First requests for extensions of these statutory time periods will be granted for sufficient cause, and for a reasonable time specified—usually one month. The reasons stated in the request will be evaluated by the group director, and the requests will be favorably considered where there is a factual accounting of reasonably diligent behavior by all those responsible for preparing a response within the statutory time period. Second or subsequent requests for extensions of time or requests for more than one month will be granted only in extraordinary situations. These policies will also apply to extension of time requests for filing a Notice of Appeal, Brief on Appeal, or Reply Brief.

FINAL ACTION—TIME FOR RESPONSE

The automatic one month extension of time and associated practice set forth in § 710.02(e) concerning responses after final rejection applies to reexamination proceedings. In no case may the period for response exceed six months from the date of the final action.

2266 Responses [R-7]

If the patent owner fails to file a timely and appropriate response to any Office action, the reexamination proceeding will be terminated and the Commissioner will proceed to issue a reexamination certificate. The certificate will normally issue indicating the status of the claims as indicated in the last Office action.

The patent owner may request reconsideration of the position stated in the Office action, with or without amendment to the claims. Any request for reconsideration must be in writing and must distinctly and specifically point out the supposed errors in the examiner's action. A general allegation that the claims define a patentable invention without specifically pointing out how the language of the claims patentably distinguishes them over the references is inadequate and is not in compliance with § 1.111 (b).

The certificate of mailing (37 CFR 1.8) may be used to file any paper in a reexamination proceeding.

2267 Handling of Inappropriate or Untimely Filed Papers [R-7]

The applicable regulations (37 CFR 1.501(a), 1.550(e)) provide that certain types of correspondence will not be considered or acknowledged unless timely received. In every case, a decision is required as to the type of paper and whether it is timely.

The return of inappropriate submissions complies with the regulations that certain papers will not be considered and also reduces the amount of paper which would ultimately have to be stored with the patent file.

DISPOSITION OF PAPERS

Where papers are filed during reexamination proceedings which are inappropriate because of some defect, such papers will either be returned to the sender or forwarded to one of three files, the "Reexamination File", the "Patent File" or the "Storage File". Any papers returned to the sender from an examining group must be accompanied by a letter indicating signature and approval of the group director.

TYPES OF PAPERS RETURNED WITH COMMISSIONER OR GROUP DIRECTOR'S APPROVAL REQUIRED

Filed by Owner § 1.530 § 1.540	A. Premature Response by Owner Where the patent owner is <i>not</i> the requester, any response or amendment filed by owner prior to an order to reexamine is premature and will be returned and will not be considered.
Filed by Requester § 1.535	A. No Statement Filed by Owner If a patent owner fails to file a statement within the prescribed limit, any reply by the requester is inappropriate and will be returned and will not be considered.
§ 1.535 § 1.540	B. Late Response by Requester Any response subsequent to two months from the date of service of the patent owner's statement will be returned and will not be considered.
§ 1.550(e)	C. Additional Response by Requester The active participation of the reexamination requester ends with the reply pursuant to § 1.535. Any further submission on behalf of requester will be returned and will not be considered.
Filed by Third Party § 1.501	Unless a paper submitted by a third party raises only issues appropriate under § 1.501, or consists solely of a prior decision on the patent by another forum, e.g., a court (see §§ 2207 2282 and 2286), it will be returned to an identified third party or destroyed if the submitter is unidentified.

The "Reexamination File" and the "Patent File" will remain together in central storage area prior to a determination to reexamine but once an order to reexamine is mailed, the "Patent File" will be maintained in the assigned examiner's room.

TYPES OF DEFECTIVE PAPERS TO BE LOCATED IN THE "REEXAMINATION FILE"

Filed by Owner § 1.33	A. Unsigned Papers Papers filed by owner which are unsigned or signed by less than all of the owners (no attorney of record or acting in representative capacity).
--------------------------	---

→ § 1.248 B. No Proof of Service
Papers filed by the patent owner in which no proof of service on requester is included and proof of service is required, may be denied consideration.

§ 1.530(b)
§ 1.540 C. Untimely Papers
Where owner has filed a paper which is untimely, that is, it was filed after the period set for response, the paper will not be considered.

Filed by Requester A. Unsigned Papers
Papers filed by requester which are unsigned will not be considered.

§ 1.510(b)(5)
§ 1.33(c)
§ 1.248 B. No Proof of Service
Papers filed by requester in which no proof of service on owner is included and where proof of service is required may be denied consideration.

The "Storage File" will be maintained separate and apart from the other two files and at a location selected by the group director. For example, the group director may want to locate the "Storage File" in a central area in the group as with the reexamination clerk or in his own room.

PAPERS LOCATED IN THE "STORAGE FILE"

§ 1.501 Citations by Third Parties
§ 1.550(e) Submissions by third parties based solely on prior art patents or publications filed after the date of the order to reexamine are not entered into the patent file but delayed until the reexamination proceedings have been terminated.

Proper timely filed citations by third parties are place in the "Patent File".

2268 Petitions for Entry of Late Papers [R-7]

→ Due to the "special dispatch" provision of Public Law 96-517, it is necessary and appropriate that the Office adhere strictly to the time limits set by the Rules. However, due to the fact substantial property rights are involved in patents undergoing reexamination, the Office will consider, in appropriate circumstances, petitions to waive the rules pursuant to 37 CFR 1.183 where untimely papers are filed subsequent to the order for reexamination (§ 1.525). Such petitions will be decided by the Deputy

Assistant Commissioner for Patents. Any such petition must detail the specific circumstances necessitating the request for waiver and provide evidence to support the request. Petitioners are cautioned that such petitions will only be granted in extraordinary circumstances where justice requires the granting of the relief sought. ←

Under ordinary circumstances, the failure to timely file a statement pursuant to § 1.530 or a reply pursuant to § 1.535 would not constitute adequate basis to justify a waiver of the rule regardless of the reasons for the failure since no rights are lost by the failure to file these documents. However, the failure to timely respond to an Office action rejecting claims may, in appropriate circumstances, justify waiver of the rules if the situation is "extraordinary" and if "justice requires" the waiver since rights may be lost by the failure to timely respond.

2269 Reconsideration [R-7]

After response by the patent owner (37 CFR 1.111), the patent under reexamination will be reconsidered and the patent owner notified if claims are rejected or objections or requirements made. The patent owner may respond to such Office action with or without amendment but any amendment after the second Office action (which will normally be final as provided for in § 2271) must ordinarily be restricted to the rejection or to the objection or requirement made and the patent under reexamination will be again considered, and so on repeatedly unless the examiner has indicated that the action is final. See 37 CFR 1.112.

2270 Clerical Handling [R-7]

The person designated as the reexamination clerk will handle most of the initial clerical processing of the reexamination file.

Amendments which comply with 37 CFR 1.121(f) will be entered for purposes of reexamination in the reexamination file wrapper in much the same way as amendments are now entered in reissue applications. An amendment will be given a paper number and be designated by a consecutive letter of the alphabet. Inserts will be entered in original text of the mounted patent by using carets at the appropriate column and line together with the amendment letter and insert number. Deletions will be indicated by inserting brackets around the deleted material together with an indication of the amendment letter.

← All amendments to the specification prior to final action will be entered for purposes of the reexamination proceeding even though they do ←

→ not have legal effect until the certificate is issued. Any "new matter" amendment will be required to be canceled from the description and claims containing new matter will be rejected under 35 U.S.C. 112. A "new matter" amendment to the drawing is ordinarily not entered. See §§ 608.04, 608.04(a) and (c).

2271 Final Action [R-7]

Before a final action is in order, a clear issue should be developed between the examiner and the patent owner. To bring the prosecution to a speedy conclusion and at the same time deal justly with the patent owner and the public, the examiner will twice provide the patent owner with such information and references as may be useful in defining the position of the Office as to unpatentability before the action is made Final. Initially, the decision ordering reexamination of the patent will contain an identification of the new questions of patentability that the examiner considers to be raised by the prior art considered. In addition, the first Office action will reflect the consideration of any arguments and/or amendments contained in the request, the owner's statement filed pursuant to 37 CFR 1.530, and any reply thereto by the requester, and should fully apply all relevant grounds of rejection to the claims.

The statement which the patent owner may file under 37 CFR 1.530 and the response to the first Office action should completely respond to and/or amend with a view to avoiding all outstanding grounds of rejection.

It is intended that the second Office action in the reexamination proceeding following the decision ordering reexamination will be made final in accordance with the guidelines set forth in § 706.07(a). The examiner should not prematurely cut off the prosecution with a patent owner who is seeking to define the invention in claims that will offer the patent protection to which the patent owner is entitled. However, both the patent owner and the examiner should recognize that a reexamination proceeding may result in the final cancellation of claims from the patent and that the patent owner does not have the right to renew or continue the proceedings by refiling under 37 CFR 1.60. Complete and thorough actions by the examiner coupled with complete responses by the patent owner, including early presentation of evidence under 37 CFR 1.131 or 1.132, will go far in avoiding such problems and reaching a desirable early termination of the reexamination proceeding.

→ In making a final rejection, all outstanding grounds of rejection of record should be carefully reviewed and any grounds or rejection → relied upon should be reiterated. The grounds of

rejection must (in the final rejection) be clearly developed to such an extent that the patent owner may readily judge the advisability of an appeal. However, where a single previous Office action contains a complete statement of a ground of rejection, the final rejection may refer to such a statement and also should include a rebuttal of any arguments raised in the patent owner's response. The final rejection letter should conclude with a statement that: "The above rejection is made *Final*."

As with all other Office correspondence on the merits in a reexamination proceeding, the final Office action must be signed by a primary examiner.

2272 After Final Practice [R-7]

It is intended that prosecution before the examiner in a reexamination proceeding will be concluded with the final action. Once a final rejection that is not premature has been entered in a reexamination proceeding, the patent owner no longer has any right to unrestricted further prosecution. Consideration of amendments submitted after final rejection will be governed by the strict standards of 37 CFR 1.116. Both the examiner and the patent owner should recognize that substantial patent rights will be at issue with no opportunity for the patent owner to refile under 37 CFR 1.60 in order to continue prosecution. Accordingly, both the examiner and the patent owner should identify and develop all issues prior to the final Office action, including the presentation of evidence under 37 CFR 1.131 and 1.132.

FINAL REJECTION—TIME FOR RESPONSE

The practice in a reexamination proceeding will be substantially the same as that set forth in § 714.13. However, note that since the statutory period for response in a reexamination proceeding will normally be two (2) months, the period for response typically will be extended to run 3 months from the date of the final rejection in the advisory action unless a previous extension of time has been granted or the advisory action cannot be mailed in sufficient time.

ACTION BY EXAMINER

It should be kept in mind that a patent owner cannot, as a matter of right, amend any finally rejected claims, add new claims after a final rejection, or reinstate previously canceled claims. A showing under 37 CFR 1.116(b) is required and will be evaluated by the examiner for all proposed amendments after final rejection →

tion except where an amendment merely cancels claims, adopts examiner's suggestions, removes issues for appeal, or in some other way requires only a cursory review by the examiner. An amendment filed at any time after final rejection but before an appeal brief is filed, may be entered upon or after filing of an appeal provided the total effect of the amendment is to (1) remove issues for appeal, and/or (2) adopt examiner suggestions.

The first proposed amendment after final action in a reexamination proceeding will be given sufficient consideration to determine whether it places all the claims in condition where they are patentable and/or whether the issues on appeal are reduced or simplified. Unless the proposed amendment is entered in its entirety, the examiner will briefly explain the reasons for not entering a proposed amendment. For example, if the claims as amended present a new issue requiring further consideration or search, the new issue should be identified and a brief explanation provided as to why a new search or consideration is necessary. The patent owner should be notified if certain portions of the amendment would be entered if a separate paper was filed containing only such amendment.

Any second or subsequent amendment after final will be considered only to the extent that it removes issues for appeal or puts a claim in obvious patentable condition.

Since patents undergoing reexamination cannot become abandoned and cannot be refiled, and since the holding of claims unpatentable and canceled in a certificate is absolutely final it is appropriate that the examiner consider the feasibility of entering amendments touching the merits after final rejection or after appeal has been taken, where there is a showing why the amendments are necessary and a suitable reason is given why they were not earlier presented.

2273 Appeal in Reexamination [R-7]

35 U.S.C. 306. Appeal. The patent owner involved in a reexamination proceeding under this chapter may appeal under the provisions of section 134 of this title, and may seek court review under the provisions of sections 141 to 145 of this title, with respect to any decision adverse to the patentability of any original or proposed amended or new claim of the patent.

A patent owner who is dissatisfied with the primary examiner's decision in the second or final rejection of his or her claims may appeal to the Board of Appeals for review of the rejection by filing a Notice of Appeal within the required time. A Notice of Appeal must be signed by the patent owner or his or her attor-

ney or agent, and be submitted along with the required fee of \$50. (35 U.S.C. 41(a)).

The period for filing the Notice of Appeal is the period set for response in the last Office action which is normally two (2) months. The timely filing of a first response to a final rejection having a shortened statutory period for response is construed as including a request to extend the period for response an additional month, even if an extension has been previously granted, as long as the period for response does not exceed six (6) months from the date of the final rejection. The normal *ex parte* appeal procedures set forth at 37 CFR 1.191-1.198 apply in reexamination. The requester cannot appeal or otherwise participate in the appeal.

2274 Appeal Brief [R-7]

Where the brief is not filed, but within the period allowed for filing the brief an amendment is presented which places the claims of the patent under reexamination in a patentable condition, the amendment may be entered. Amendments should not be included in the appeal brief.

The time for filing the appeal brief is two (2) months from the date of the appeal or alternatively, within the time allowed for response to the action appealed from, if such time is later.

In the event that the patent owner finds that he or she is unable to file a brief within the time allowed by the rules, he or she may file a petition without any fee, to the examining group, requesting additional time (usually one month), and give reasons for the request. The petition should be filed in duplicate and contain the address to which the response is to be sent. If sufficient cause is shown and the petition is filed prior to the expiration of the period sought to be extended (37 CFR 1.192), the group director is authorized to grant the extension for up to one month. Requests for extensions of time for more than one month will also be decided by the group director, but will not be granted, unless extraordinary circumstances are involved, e.g., death or incapacitation of the patent owner. The time extended is added to the last calendar day of the original period, as opposed to being added to the day it would have been due when said last day is a Saturday, Sunday or holiday.

Failure to file the brief within the permissible time will result in dismissal of the appeal. The reexamination proceeding is then terminated and a certificate is issued indicating the status of the claims at the time of appeal.

A \$50 fee is required when the appeal brief is filed for the first time in a particular reexamination proceeding, 35 U.S.C. 41(a). 37 CFR 1.192

→ provides that the appellant shall file a brief of the authorities and arguments on which he or she will rely to maintain his or her appeal, including a concise explanation of the invention which should include a reference to the drawing by reference characters, and a copy of the claims involved. The brief should also indicate if an oral hearing is desired. 37 CFR 1.192(a) requires the submission of three copies of the appeal brief.

For the sake of convenience, the copy of the claims involved should be double spaced.

The brief, as well as every other paper relating to an appeal, should indicate the number of the examining group to which the reexamination is assigned and the reexamination control number. When the brief is received, it is forwarded to the examining group where it is entered in the file, and referred to the examiner.

Patent owners are reminded that their briefs in appeal cases must be responsive to every ground of rejection stated by the examiner. A reply brief should be filed in response to any new grounds stated in the examiner's answer.

Where an appellant fails to respond by way of brief or reply brief to any ground of rejection, and it appears that the failure is inadvertent, appellant should be notified by the examiner that he or she is allowed one month to correct the defect by filing a supplemental brief. Where this procedure has not been followed, the Board of Appeals should remand the reexamination file to the examiner for compliance. When the record clearly indicates intentional failure to respond by brief to any ground of rejection, for example, by failure to file a supplemental brief within the one-month period allowed for that purpose, the examiner should inform the Board of Appeals of this fact in his or her answer and merely specify the claim affected.

Where the failure to respond by brief appears to be intentional, the Board of Appeals may dismiss the appeal as to the claims involved. Oral argument at a hearing will not remedy such deficiency of a brief.

The mere filing of any paper whatever entitled as a brief cannot necessarily be considered as compliance with 37 CFR 1.192. The rule requires that the brief must set forth the authorities and arguments relied upon, and to the extent that it fails to do so with respect to any ground of rejection, the appeal as to that ground may be dismissed.

It is essential that the Board of Appeals should be provided with a brief fully stating the position of the appellant with respect to each issue involved in the appeal so that no search of the record is required in order to de-

termine that position. The fact that appellant may consider a ground to be clearly improper does not justify a failure on the part of the appellant to point out to the Board the reasons for that view in the brief.

A distinction must be made between the lack of any argument and the presentation of arguments which carry no conviction. In the former case dismissal is in order, although it may well be merely an affirmance based on the grounds relied on by the examiner.

Appellant must traverse every ground of rejection set forth in the final rejection. Oral argument at the hearing will not remedy such a deficiency in the brief. Ignoring or acquiescing in any rejection, even one based upon formal matters which could be cured by subsequent amendments, will invite a dismissal of the appeal. The reexamination proceedings are considered terminated as of the date of the dismissal.

2275 Examiner's Answer [R-7]

Sections 1208-1208.02 relate to preparation of examiner's answers in appeals. The procedures covered in these sections apply to appeals in both patent applications and patents undergoing reexamination proceedings.

2276 Oral Hearing [R-7]

Section 1209 relates to oral hearings in appeals in both patent applications and patents undergoing reexamination.

2277 Board Of Appeals' Decision [R-7]

Sections 1213 through 1213.02, relate to decisions of the Board of Appeals.

2278 Action Following Decision [R-7]

Sections 1214.01-1214.07 relate to the handling of applications and patents undergoing reexamination after the appeal has been concluded.

2279 Appeals To Courts [R-7]

The normal appeal route provided to the Court of Customs and Patent Appeals is available to a patent owner not satisfied with the decision of the Board of Appeals.

The normal remedy by civil action under 35 U.S.C. 145 is provided for the owner of a patent in a reexamination proceeding.

There is normally no participation by requester during any court review.

See also §§ 1216, 1216.01, and 1216.02.

2280 Duty of Disclosure in Reexamination Proceedings [R-7]

37 CFR 1.555 Duty of disclosure in reexamination proceedings. The owner of a patent involved in a reexamination proceeding who is aware, or becomes aware, of patents or printed publications material to the reexamination which have not been previously made of record in the patent file must bring such patents or printed publications to the attention of the Office. A prior art statement, preferably in accordance with § 1.98, should be filed within two months of the date of the order for reexamination, or as soon thereafter as possible in order to bring such patents or printed publications to the attention of the Office.

The duty of disclosure in reexamination proceedings applies to the patent owner. That duty is a continuing obligation on the part of the patent owner throughout the proceeding. The continuing obligation during the reexamination proceedings is that the patent owner who is aware of or becomes aware of, patents or printed publications which are material to the reexamination which have not previously been made of record in the patent file *must* bring such patents or printed publications to the attention of the Office.

Patent owners are strongly encouraged to file prior art statements, preferably in accordance with § 1.98, within two months of the date of the order to reexamine, or as soon thereafter as possible, in order to bring the patents or printed publications to the attention of the Office.

The duty of disclosure provided for in § 1.555 is consistent with the duty placed on patent applicants by § 1.56(a), with the exception that issues of fraud are not considered in reexamination. Patent owners who fail to comply do so at the risk of diminishing the quality and reliability of the patent reexamination certificate issuing from the proceeding.

For the patent owner's duty to disclose prior or concurrent proceedings in which the patent is or was involved, see § 2282.

2281 Interviews In Reexamination Proceedings [R-7]

37 CFR 1.560 Interviews in reexamination proceedings. (a) Interviews in reexamination proceedings pending before the Office between examiners and the owners of such patents or their attorneys or agents of record must be had in the Office at such times, within Office hours, as the respective examiners may designate. Interviews will not be permitted at any other time or place without the authority of the Commissioner. Inter-

views for the discussion of the patentability of claims in patents involved in reexamination proceedings will not be had prior to the first official action thereon. Interviews should be arranged for in advance. Requests that reexamination requesters participate in interviews with examiners will not be granted.

(b) In every instance of an interview with an examiner, a complete written statement of the reasons presented at the interview as warranting favorable action must be filed by the patent owner. An interview does not remove the necessity for response to Office actions as specified in § 1.111.

Only ex parte interviews between the examiner and the patent owner's representative are permitted. Requests by reexamination requesters to participate in or to attend interviews will not be granted.

Unless the Deputy Assistant Commissioner for Patents authorizes otherwise, interviews between examiners and the owners of patents undergoing reexamination or their attorneys or agents must be had in the Office at such times, within Office hours, as the respective examiners may designate.

Interviews for the discussion of the patentability of claims in patents involved in reexamination proceedings will not be had prior to the first official action following the order for reexamination and any submissions pursuant to § 1.530 and § 1.535.

However, questions on purely procedural matters may be answered by the examiner. Except for questions on strictly procedural matters, an examiner will not conduct personal or telephone interviews with requesters or other third parties with respect to a patent in which a request for reexamination has been filed.

In every instance of an interview with the examiner, a complete written statement of the reasons presented at the interview as warranting favorable action must be filed by the patent owner. Patent owners are encouraged to submit such written statement as soon after the interview as is possible, but no later than the next communication to the Office. Service of the written statement of the interview on the requester is required.

The examiner must complete the present two-sheet carbon interleaf Interview Summary form PTOL-413 for each interview held where a matter of substance has been discussed (See § 713.04). The duplicate copy of the form should be detached and given to the patent owner at the conclusion of the interview. The original should be made of record in the reexamination file and a copy mailed to the requester.

The general procedure for conducting interviews and recording same are described at §§ 713.01-713.04.

→ **2282 Notification of Existence of Prior or Concurrent Proceedings and Decisions Thereon**
[R-7]

37 CFR 1.565 Concurrent office proceedings. (a) In any reexamination proceeding before the Office, the patent owner shall call the attention of the Office to any prior or concurrent proceedings in which the patent is or was involved such as interferences, reissue, reexaminations, or litigation and the results of such proceedings.

It is important for the Office to be aware of any prior or concurrent proceedings in which a patent undergoing reexamination is or was involved, such as interferences, reissues, reexaminations or litigations, and any results of such proceedings. Section 1.565(a) requires the patent owner to provide the Office with information regarding the existence of any such proceedings and the results thereof, if known. Ordinarily, no submissions of any kind by third parties filed after the date of the order are placed in the reexamination or patent file while the reexamination proceeding is pending. However, in order to ensure a complete file, with updated status information regarding prior or concurrent proceedings regarding the patent under reexamination, the Office will accept at any time copies of notices of suits and other proceedings involving the patent and copies of decisions from litigations or other proceedings involving the patent from the parties involved or third parties for placement in the patent file. Persons making such submissions must limit the submissions to the notification and not include further arguments or information. Any proper submissions will be promptly placed of record in the patent file. See § 2286 for Office investigation for prior or concurrent litigation.

2283 Multiple Copending Reexamination Proceedings [R-7]

37 CFR 1.565 Concurrent office proceedings.

* * * * *

(c) If reexamination is ordered while a prior reexamination proceeding is pending, the reexamination proceedings will be consolidated and result in the issuance of a single certificate under § 1.570.

↳ If reexamination is ordered on a request for reexamination while a prior reexamination proceeding is still pending, the decision on whether or not to combine the proceedings will be made by the group director of the examining group where the reexamination is pending. No decision on combining the reexaminations should be made

until such time as reexamination is actually ordered in the later filed request for reexamination. ←

Two situations are possible where a question as to merger of reexamination proceedings is raised:

PROCEEDINGS MERGED

If a second request is filed where the first certificate will issue after 3 months from the filing of the second request, the proceedings normally will be merged. In this situation the second request is decided based on the original patent claims and if reexamination is ordered, the reexamination proceedings normally would be merged. The first certificate will then be withdrawn from issue, the second reexamination proceeding will be merged with the first reexamination proceeding and prosecution will continue after the patent owner and second requester have been given an opportunity to file a statement and reply, respectively.

If the second request is based upon essentially the *same* patents or publications as in the first request or on patents or printed publications which raise essentially the same issues as those raised in the first request, the examination of the merged proceeding will continue at the point reached in the first reexamination proceeding. If, however, *new* patents or printed publications are presented in the second request which raise different questions than those raised in the first request, then prosecution in the merged reexamination proceeding will be reopened to the extent necessary to fully treat the questions raised.

The patent owner will be provided with an opportunity to respond to any new rejection in a merged reexamination proceeding prior to the action being made final. See § 2271. If the reexamination proceedings are combined, a single certificate will be issued based upon the combined proceedings, § 1.565(c).

SUSPENSIONS

↳ It may also be desirable in certain situations to suspend a proceeding for a short and specified period of time. For example, a suspension of a first reexamination proceeding may be issued to allow time for the patent owner's statement and the requester's reply in a second proceeding prior to merging. A suspension will only be granted in exceptional instances because of the statutory requirements that examination proceed with "special dispatch" and must be with the express written approval of the group director. Suspension will not be granted when there is an outstanding Office action. ←

MERGERS OF REEXAMINATION

The following guidelines should be observed when two requests for reexamination directed to a single patent have been filed.

The second request (Request 2) should be processed as quickly as possible and assigned to the same examiner to which the first request (Request 1) is assigned. Request 2 should be decided immediately without waiting the usual period. If Request 2 is denied, ex parte prosecution of Request 1 should continue. If Request 2 is granted and the proceedings are merged, combined prosecution should be carried out once the patent owner's statement and any reply by the requester have been received in Request 2.

If ex parte prosecution has not begun on Request 1, it should be processed up to that point and then normally held until Request 2 is ready for ex parte action following the statement and reply or until Request 2 is denied. Request 2 should be determined on its own merits without reference to Request 1.

When ex parte prosecution is appropriate in merged proceedings, a single combined examiner's action will be prepared. Each action will cross reference the two proceedings. A separate action cover form for each proceeding will be printed by the PALM printer for each reexamination request control number. Each requester will get a copy of the action with the appropriate cover form. The patent owner will get a copy of each cover form and the body of the action.

When a "Notice Of Intent To Issue A Reexamination Certificate" is appropriate, plural notices will be printed. Both reexamination files will then be processed and forwarded to the Office of Publications via Quality Review. The group should prepare the file of the concurrent proceedings in the manner specified in § 2287 before release to Office of Publications.

The above guidelines should be extended to those situations where more than two requests are filed for a single patent.

PROCEEDING NOT MERGED

If a second request is filed where the first reexamination certificate will issue within 3 months from the filing of the second request, the proceedings normally will not be merged. If the certificate on the first reexamination proceeding will issue before the decision on the second request must be decided, the reexamination certificate is allowed to issue. The second request is then considered based upon the claims in the patent as indicated in the issued reexamination certificate rather than the original

claims of the patent. In such situations the proceedings will not be merged. In no case should a decision on the second request be delayed beyond its three month deadline.

PETITIONS TO MERGE MULTIPLE COPENDING REEXAMINATION PROCEEDINGS

No petition to merge multiple reexamination proceedings is necessary since the Office will generally, *sua sponte*, make a decision as to whether or not it is appropriate to merge the multiple reexamination proceedings. If any petition to merge the proceedings is filed prior to the determination (§ 1.515) and order to reexamine (§ 1.525) on the second request, it will not be considered, but will be returned to the party submitting the same by the examining group director. The decision returning such a premature petition will be made of record in both reexamination files, but no copy of the petition will be retained by the Office. See § 2267.

While the patent owner can file a petition to merge the proceedings at any time after the order to reexamine (§ 1.525) on the second request, the better practice would be to include any such petition with the patent owner's statement under § 1.530, in the event the examining group director has not acted prior to that date to merge the multiple reexamination proceedings. If the requester of any of the multiple reexamination proceedings is not the patent owner that party may petition to merge the proceedings as a part of a reply pursuant to § 1.535, in the event the examining group director has not acted prior to that date to merge the multiple proceedings. A petition to merge the multiple proceedings which is filed by a party other than the patent owner or one of the requesters of the reexamination, will not be considered, but will be returned to that party by the examining group director as being improper under § 1.550(e).

All decisions on the merits of petitions to merge multiple reexamination proceedings will be made by the examining group director.

2284 Copending Reexamination and Interference Proceedings [R-7]

37 CFR 1.565 Concurrent office proceedings.

* * * * *

(b) If a patent in the process of reexamination is or becomes involved in interference proceedings or a reissue application is filed for the patent, or litigation is instituted, the Commissioner shall determine whether or not to stay the reexamination, reissue or interference proceeding. If reexamination is stayed for

the conduct of a reissue proceeding, the reissue proceeding shall take into account prior art provided by the requester for reexamination and the reexamination requester will be granted at least the same degree of participation in the reissue proceeding which the requester would have had in the reexamination proceeding. Any reexamination proceeding stayed for the conduct of a reissue proceeding shall be terminated by the grant of the reissued patent.

* * * * *

The general policy of the Office is that a reexamination proceeding will not be delayed, or stayed, because of an interference or the possibility of an interference. The reasons for this policy are (1) the relatively long period of time usually required for interferences and (2) the requirement of 35 U.S.C. 305 that all reexamination proceedings be conducted with "special dispatch" within the Office. In general, the Office will follow the practice of making the required and necessary decisions in the reexamination proceeding and, at the same time, proceed with the interference to the extent desirable. Decisions in the interference will take into consideration the status of the reexamination and what is occurring therein. The decisions as to what actions are taken in the interference will, in general, be taken in accordance with normal interference practice.

COPYING CLAIMS FROM A PATENT INVOLVED IN A REEXAMINATION PROCEEDING

An interference will not be declared with a patent which is involved in a reexamination proceeding except upon specific authorization from the Office of the Assistant Commissioner for Patents. When an amendment copying or substantially copying claims from a patent involved in a reexamination proceeding is filed in a pending application, the owner of the patent must be notified (see 37 CFR 1.205(c) and § 1101.02). The applicant must identify the patent under reexamination from which claims have been copied. The copied patent claims may be rejected on any applicable ground (see § 1101.02(f)), including, if appropriate, the prior art cited in the reexamination proceeding. Prosecution of the application should continue as far as possible, but if the application is placed in condition for allowance and still contains claims which interfere with claims of the patent under reexamination, further action on the application should be suspended until the certificate on the reexamination proceeding has been issued.

MOTION UNDER 37 CFR 1.231(a)(1) TO DISSOLVE PENDING INTERFERENCE PROCEEDING VIA REEXAMINATION PROCEEDING

Section 1.231(a)(1) reads in part:

"A motion to dissolve an interference in which a patentee is a party on the ground that the claims corresponding to the counts are unpatentable to the patentee over patents or printed publications will be considered through reexamination if it complies with the requirements of § 1.510(b) and is accompanied by the fee for requesting reexamination set in § 1.21(x)."

Any party in interest in an interference involving a patent who seeks to dissolve the interference on the ground that the claims corresponding to the counts are unpatentable to the patentee over patents or printed publications should file a complete request for reexamination meeting the requirements of § 1.510(b) which is accompanied by the fee for requesting reexamination set in § 1.21(x). Concurrently with the request for reexamination, and in a separate paper, the party should file a motion under § 1.231(a) incorporating by reference the request for reexamination. The request for reexamination should also point out that it is being filed as a part of a motion to dissolve an interference pursuant to § 1.231(a)(1). The motion must be filed within the period set in the notice of interference for filing motions. The request for reexamination will be processed in the normal manner and will be forwarded to the examiner for determination. The motion under § 1.231(a)(1) will also be transmitted to the primary examiner for decision.

A motion under § 1.231(a)(1) to dissolve the interference on grounds set forth in the reexamination will not be decided prior to the first Office action on the merits in the reexamination. The decision on the motion under § 1.231(a)(1) should be decided concurrently with the first Office action on the merits in the reexamination, but the decision may occur later if a delay occurs in the transmittal of the motion to the primary examiner.

The determination on the request for reexamination, the first Office action and the following examination will not be delayed by the examiner pending receipt of a motion under § 1.231(a)(1).

MOTION TO SUSPEND INTERFERENCE UNDER 37 CFR 1.243(a) PENDING THE OUTCOME OF A REEXAMINATION PROCEEDING

A motion under § 1.243(a) to suspend an interference pending the outcome of a reexamination proceeding may be made at any time during the interference by any party thereto. The

motion will be decided by the patent interference examiner, based on the particular fact situation. However, no consideration will be given such a motion unless and until a reexamination order is issued, nor will suspension of the interference normally be permitted until after any other motions under 37 CFR 1.231 have been disposed of.

REQUEST BY THE EXAMINER PURSUANT TO 37 CFR 1.237

Normally, examiners should not move under § 1.237 while the reexamination proceeding is pending but should rely upon the parties of the interference to file motions under § 1.231 or § 1.243(a) during the interference proceedings.

REQUEST FOR REEXAMINATION FILED BY PERSON NOT A PARTY TO THE INTERFERENCE

In view of the provision of § 1.510(a), "Any person may, at any time during the period of enforceability of a patent" file a request for reexamination. Persons not a party to the interference may file a request for reexamination during the pendency of the interference. Such requests for reexamination will be processed in the normal manner. No delay, or stay, of the reexamination will occur because the requester is not a party to the interference. If the examiner orders reexamination pursuant to § 1.525 and subsequently rejects a patent claim corresponding to a count in the interference, the attention of the Board of Interferences shall be called thereto pursuant to § 1.237.

PETITION TO STAY REEXAMINATION PROCEEDING BECAUSE OF INTERFERENCE

Any petition to stay a reexamination proceeding, because of an interference, which is filed prior to the determination (§ 1.515) and order to reexamine (§ 1.525) will not be considered, but will be returned to the party submitting the same. The decision returning such a premature petition will be made of record in the reexamination file, but no copy of the petition will be retained by the Office. A petition to stay the reexamination proceeding because of the interference may be filed by the patent owner as a part of the patent owner's statement under § 1.530 or subsequent thereto. If a party to the interference, other than the patent owner, is a requester of the reexamination, that party may petition to stay the reexamination proceeding as a part of a reply pursuant to § 1.535. If the other party to the interference is not the requester any petition by that party is improper under § 1.550(e) and will not be

considered. Any such improper petitions will be returned to the party submitting the same.

Premature petitions to stay the reexamination proceeding, i.e. those filed prior to the determination (§ 1.515) and order to reexamine (§ 1.525), will be returned by the examining group director as premature. Petitions to stay filed subsequent to the date of the order for reexamination will be referred to the Office of the Assistant Commissioner for Patents for decision. All decisions on the merits of petitions to stay a reexamination proceeding because of an interference will be made in the Office of the Assistant Commissioner for Patents.

ACTION IN INTERFERENCE FOLLOWING REEXAMINATION

If one or more claims of a patent which is involved in an interference are cancelled or amended by the issuance of a reexamination certificate, the interference will be dissolved as to any counts corresponding to those claims.

Upon issuance of the reexamination certificate, the patent owner must notify the Board of Patent Interferences thereof.

2285 Copending Reexamination and Reissue Proceedings [R-7]

The general policy of the Office is that a reissue application examination and a reexamination proceeding will not be conducted separately at the same time as to a particular patent. The reason for this policy is to permit timely resolution of both proceedings to the extent possible and to prevent inconsistent, and possibly conflicting, amendments from being introduced into the two proceedings on behalf of the patent owner. Accordingly, if both a reissue application and a reexamination proceeding are pending concurrently on a patent, a decision will normally be made to merge the two proceedings or to stay one of the two proceedings. The decision as to whether the proceedings are to be merged, or which proceeding, if any, is to be stayed is made in the Office of the Assistant Commissioner for Patents.

TIME FOR MAKING DECISION ON MERGING OR STAYING THE PROCEEDINGS

A decision on whether or not to merge the reissue application examination and the reexamination proceeding, or to stay one of the two proceedings, will not be made prior to the mailing of an order to reexamine the patent pursuant to 37 CFR 1.525. Until such time as reexamination is ordered, the examination of the reissue application will proceed. A determina-

tion on the request must not be delayed because of the existence of a copending reissue application since 35 U.S.C. 304 and § 1.515 require a determination within three months following the filing date of the request. See § 2241. If the decision on the request denies reexamination (§ 2247), the examination of the reissue application should be continued. If reexamination is ordered (§ 2246), the reexamination file, the reissue application, and the patent file should be delivered to the Office of the Assistant Commissioner for Patents promptly following the mailing of the decision ordering reexamination. The delivery of the files to the Office of the Assistant Commissioner should not be delayed awaiting the filing of any statement under § 1.530 and any reply under § 1.535.

If a reissue application is filed during the pendency of a reexamination proceeding, the reexamination file, the reissue application, and the patent file should be delivered to the Office of the Assistant Commissioner for Patents as promptly as possible after the reissue application reaches the examining group.

The decision on whether or not the proceedings are to be merged, or which proceeding, if any, is to be stayed will generally be made as promptly as possible after receipt of all of the files in the Office of the Assistant Commissioner for Patents. However, the decision on merging or staying the proceedings may in certain situations be delayed until any submissions under § 1.530 and § 1.535 have been filed. Until a decision is mailed merging the proceedings or staying one of the proceedings, the two proceedings will continue and be conducted simultaneously, but separately.

The Office may in certain situations issue a certificate at the termination of a reexamination proceeding, even if a copending reissue application or another reexamination request has already been filed.

CONSIDERATIONS IN DECIDING WHETHER TO MERGE THE PROCEEDINGS OR WHETHER TO STAY A PROCEEDING

The decision on whether to merge the proceedings or stay a proceeding will be made on a case-by-case basis based upon the status of the various proceedings with due consideration being given to the finality of the reexamination proceeding.

1. Reissue about to issue, reexamination requested.

If the reissue patent will issue before the determination on the reexamination request must be made, the determination on the request should normally be delayed until after the granting of the reissue patent and then be de-

termined on the basis of the claims in the reissue patent. The reexamination, if ordered, would then be on the reissue patent claims rather than the original patent claims. Since the reissue application would no longer be pending, the reexamination would be processed in a normal manner.

Where a reissue patent has been issued, the determination on the request for reexamination should point out to the requester and patent owner that the determination has been made on the claims of the reissue patent and not on the claims of the original patent. If a reissue patent issues on the patent under reexamination after reexamination is ordered the next action from the examiner in the reexamination should point out that further proceedings in the reexamination will be based on the claims of the reissue patent and not on the patent surrendered.

Wording similar to the following may be used in the examiner's Office action.

"In view of the surrender of original patent _____ and the granting of reissue patent number _____ which has been issued on _____, 19__-, all subsequent proceedings in this reexamination will be based on the reissue patent claims."

2. Reissue pending, reexamination request filed.

Where a reissue patent will not be granted prior to the expiration of the three month period for making the determination, a decision will be made as to whether the proceedings are to be merged or which proceeding, if any, is to be stayed after an order to reexamine has been issued. The general policy of the Office is to merge the more narrow reexamination proceeding with the broader reissue application examination whenever it is desirable to do so in the interests of expediting the conduct of both proceedings. In making a decision on whether or not to merge the two proceedings consideration will be given to the status of the reissue application examination at the time the order to reexamine the patent pursuant to 37 CFR 1.525 is mailed. For example, if examination of the reissue application has not begun, or if a rejection of the primary examiner has not been appealed to the Board of Appeals pursuant to 37 CFR 1.191, it is likely that a merger of the reissue application examination and the reexamination proceeding will be ordered by the Office of the Assistant Commissioner for Patents. If, however, the reissue application is on appeal to the Board of Appeals or the courts that fact would be considered in making a decision whether to merge the proceedings or stay one of the proceedings.

If such a merger of the proceedings is ordered, the order merging the proceedings will also require that the patent owner place the same claims in the reissue application and in the reexamination proceeding for purposes of the merged proceedings. An amendment may be required to be filed to do this within a specified time set in the order merging the proceedings.

If the reissue application examination has progressed to the point where a merger of the two proceedings is not desirable at that time, then the reexamination proceeding will generally be stayed until the reissue application examination is complete on the issues then pending. After completion of the examination on the issues then pending in the reissue application examination, the stay of the reexamination proceeding will be removed and the proceedings either merged or the reexamination proceeding will be conducted separately if the reissue application has become abandoned. The reissue application examination will be reopened, if necessary, for merger of the reexamination proceeding therewith.

If a stay of a reexamination proceeding has been removed following a reissue application examination, the first Office action will be given a shortened statutory period for response of one month unless a longer period for response is clearly warranted by the nature of the examiner's action. The second Office action will normally be final and also have a one month period for response. These shortened periods are considered necessary to prevent undue delay in terminating the proceedings and also to proceed with "special dispatch" in view of the earlier stay.

If the reissue application examination and the reexamination proceeding are merged, the issuance of the reissue patent will also serve as the certificate under § 1.570 and the reissue patent will so indicate.

3. Reexamination proceedings underway, reissue application filed.

When a reissue application is filed after a reexamination proceeding has begun following an order therefor, the reexamination, patent, and the reissue files should be forwarded to the Office of the Assistant Commissioner for Patents for consideration as to whether or not to merge the proceedings or stay one proceeding.

Where reexamination has already been ordered prior to the filing of a reissue application, the following factors may be considered in deciding whether to merge the proceedings or stay one proceeding:

a. The status of the reexamination proceeding: For example, has a statement and reply

been received, a first Office action been mailed, a final rejection been given, or printing of certificate begun?

b. The nature and scope of the reissue application: For example, are the issues presented in the proceeding the same, overlapping, or completely separate; and are the reissue claims broadening or related to issues other than rejections based on patents or printed publications?

CONDUCT OF MERGED REISSUE APPLICATION EXAMINATION AND REEXAMINATION PROCEEDINGS

If a reissue application examination and a reexamination proceeding are merged, the merged examination will be conducted on the basis of the rules relating to the broader reissue application examination. The examiner, in examining the merged proceeding, will apply the reissue statute, rules, and case law to the merged proceeding. This is appropriate in view of the fact that the statutory provisions for reissue applications and reissue application examination include, *inter alia*, provisions equivalent to 35 U.S.C. 305 relating to the conduct of reexamination proceedings.

In any merged reissue application and reexamination proceeding the examiner's actions will take the form of a single action which jointly applies to both the reissue application and the reexamination proceeding. The action will contain identifying data for both the reissue application and the reexamination proceeding and will be physically entered into both files, which will be maintained as separate files. Any responses by the applicant/patent owner in such a merged proceeding must consist of a single response, filed in duplicate, for entry in both files.

If the applicant/patent owner in such a merged proceeding fails to file a timely and appropriate response to any Office action, the merged proceeding will be terminated, the reissue application held abandoned, and the Commissioner will proceed to issue a reexamination certificate under § 1.570 in accordance with the last action of the Office unless further action is clearly needed in view of the difference in rules relating to reexamination and reissue proceedings.

If the applicant/patent owner in such a merged proceeding files an express abandonment of the reissue application pursuant to 37 CFR 1.138, the next Office action of the examiner will accept the express abandonment, dissolve the merged proceeding, and continue the reexamination proceeding. Any grounds of re-

jection which are not applicable under reexamination should be withdrawn (e.g., based on public use or sale) and any new grounds of rejection which are applicable under reexamination (e.g., improper broadened claims) should be made by the examiner upon dissolution of the merged proceeding. The existence of any questions remaining which cannot be considered under reexamination following dissolution of the merged proceeding would be noted by the examiner as not being proper under reexamination pursuant to 37 CFR 1.552(e).

PETITION TO MERGE REISSUE APPLICATION EXAMINATION AND REEXAMINATION PROCEEDINGS OR TO STAY EITHER PROCEEDING BECAUSE OF THE EXISTENCE OF THE OTHER

No petition to merge the proceedings, or stay one of them, is necessary since the Office will generally, *sua sponte*, make a decision to merge the proceedings or stay one of them. If any petition to merge the proceedings, or to stay one proceeding because of the other, is filed prior to the determination (§ 1.515) and order to reexamine (§ 1.525) it will not be considered, but will be returned to the party submitting the same by the examining group director, regardless of whether the petition is filed in the reexamination proceeding, the reissue application, or both. This is necessary to prevent premature papers relating to the reexamination proceeding from being filed. The decision returning such a premature petition will be made of record in both the reexamination file and the reissue application file, but no copy of the petition will be retained by the Office. See § 2267.

While the patent owner can file a petition to merge the proceedings, or stay one proceeding because of the other, at any time after the order to reexamine (§ 1.525), the better practice would be to include any such petition with the patent owner's statement under § 1.530, in the event the Office has not acted prior to that date to merge the proceedings or stay one of them. If the requester of the reexamination is not the patent owner, that party may petition to merge the proceedings, or stay one proceeding because of the other, as a part of a reply pursuant to § 1.535, in the event the Office has not acted prior to that date to merge the proceedings or stay one of them. A petition to merge the proceedings, or stay one of them because of the other, which is filed by a party other than the patent owner or the requester of the reexamination will not be considered, but will be returned to that party by the examining group director as being improper under § 1.550(e).

All decisions on the merits of petitions to merge the reissue application examination and the reexamination proceeding, or to stay one proceeding because of the other, will be made in the Office of the Assistant Commissioner for Patents. Such petitions to merge the proceedings, or stay one of the proceedings because of the other, which are filed by the patent owner or the requester subsequent to the date of the order for reexamination will be referred to the Office of the Assistant Commissioner for Patents for decision.

2286 Reexamination and Litigation Proceedings [R-7]

The federal courts and the Patent and Trademark Office are jointly responsible for the overall administration of the patent system. In view of that joint responsibility, and since maximum benefit to the patent system occurs when the Office and the federal courts act in harmony, it is the policy of the Office that it will not "relitigate" in a reexamination proceeding an issue of patentability which has been resolved by a federal court on the merits after a thorough consideration of the prior art called to its attention in an adversary context. See *In re Pearne et al.*, 212 USPQ 466 (Comr. Pat. 1981).

While it is the policy of the Office to act in harmony with the federal courts, 35 U.S.C. 302 permits a request for reexamination to be filed "at any time". Thus, requests for reexamination are frequently filed where the patent for which reexamination is requested is involved in concurrent litigation. The guidelines set forth below will generally govern Office handling of reexamination requests where there is concurrent litigation in the federal courts.

COURT ORDERED REEXAMINATION PROCEEDING OR LITIGATION STAYED FOR REEXAMINATION

Any request for reexamination which indicates that it is filed as a result of an order by a court or that litigation is stayed for the filing of a reexamination request will be taken up by the examiner for decision six weeks after the request was filed. See § 2241. If reexamination is ordered, the examination following the statement by the patent owner under § 1.530 and the reply by the requester under § 1.535 will be expedited to the extent possible. Office actions in these reexamination proceedings will normally set a one month shortened statutory period for response rather than the two months usually set in reexamination proceedings. See § 2263. This one month period may be extended only upon a showing of sufficient cause. See § 2265.

FEDERAL COURT DECISION KNOWN TO EXAMINER
AT THE TIME THE DETERMINATION ON THE
REQUEST FOR REEXAMINATION IS MADE

If a federal court decision *on the merits* of a patent is known to the examiner at the time the determination on the request for reexamination is made, the following guidelines will be followed by the examiner, whether or not the person who filed the request was a party to the litigation:

(1) No substantial new question of patentability will be found based on (1) the same prior art which was before the federal court; (2) prior art which is merely cumulative to that which was before the court; and (3) issues which were actually resolved on the merits by the court.

(2) In making the determination the examiner will compare the prior art and issues raised in the request with the prior art before the federal court and the issues resolved *on the merits* by the court, without regard to either the finality of the court decision or whether the claims were held valid or invalid.

(3) Where the claims were all held *invalid* by a federal court decision *for any reason* no substantial new question of patentability will be found.

(4) Where claims have been held valid by the federal court, reexamination will be ordered by the examiner if (1) additional prior art is relied on which is not merely cumulative to that before the court; (2) the additional prior art raises issues which were not resolved on the merits by the court; and (3) the additional prior art is material to the examination of at least one claim.

(5) Where the patent contains claims in addition to those upon which the federal court ruled, reexamination will be ordered if (1) a substantial new question of patentability as to those additional claims is present and (2) the same question was not resolved by the court in its decision.

(6) In making the determination on a request, a consent judgment that claims are valid will be treated as a decision on the merits insofar as the parties to the litigation (or their proxy) are concerned. A consent judgment of validity or invalidity has no effect as to requests filed by a person not a party to the litigation.

(7) All determinations on requests for reexamination which the examiner makes after a federal court decision must be approved by the examining group director.

For a discussion of the policy in specific situations where a federal court decision has been issued see § 2242.

REEXAMINATION WITH CONCURRENT LITIGATION
BUT ORDERED PRIOR TO FEDERAL COURT
DECISION

In view of the statutory mandate to make the determination on the request within three months, the Office realistically has no choice but to make the determination on the request based on the record before the examiner without awaiting a decision by the federal court. It is not realistic to attempt to determine what issues will be treated by the federal court prior to the court decision. Accordingly, the determination on the request will be made without considering the issues allegedly before the court. If reexamination is ordered the reexamination will continue until the Office becomes aware that a trial on the merits has begun at which time the reexamination proceeding normally will be stayed, *sua sponte* by the examining group director unless a proper petition to stay has been filed which is not rendered moot by the *sua sponte* stay. Such petition will be referred to the Office of the Assistant Commissioner for Patents. The patent owner is required by 37 CFR 1.565(a) to call the attention of the Office to any prior or concurrent proceeding in which the patent is or was involved and thus has an obligation to promptly notify the Office that a trial on the merits has begun in the federal court.

FEDERAL COURT DECISION ISSUES AFTER
REEXAMINATION ORDERED

Pursuant to 37 CFR 1.565(a), the patent owner in a reexamination proceeding must promptly notify the Office of any federal court decision involving the patent. Where the reexamination proceeding is currently stayed and the court decision issues, or the Office becomes aware of a court decision relating to a pending reexamination proceeding, the order to reexamine is reviewed to see if a substantial new question of patentability is still present. If no substantial new question of patentability is present the order to reexamine is vacated by the examining group director and reexamination is terminated.

In making the review after the court decision the examiner will follow the same guidelines set forth above when making a determination after a court decision. If the review reveals that only different nonoverlapping issues are present reexamination proceeding will continue on the different nonoverlapping issues and any previously ordered stay will be lifted after the lower court's decision. If the review reveals that any of the different issues are, or may be, overlapping with the issues decided by the court, the reexamination proceeding will be

→ stayed, *sua sponte*, by the examining group director and any previously ordered stay will be continued until the court decision becomes final.

Once the court decision is issued it is controlling. In circumstances where vacating the order is not appropriate, claims not under consideration because of the court decision will be indicated as having been withdrawn from consideration because of the court decision. Since claims held invalid will be withdrawn from consideration and not reexamined during a reexamination proceeding no rejection on the ground of collateral estoppel will be appropriate in reexamination.

PETITION TO STAY REEXAMINATION PROCEEDING BECAUSE OF LITIGATION

Any petition to stay a reexamination proceeding, because of litigation, which is filed prior to the determination (§ 1.515) and order to reexamine (§ 1.525) will not be considered, but will be returned to the party submitting the same by the examining group director. The decision returning such a premature petition will be made of record in the reexamination file, but no copy of the petition will be retained by the Office. See § 2267.

A petition to stay the reexamination proceeding because of litigation may be filed by the patent owner as a part of the patent owner's statement under § 1.530 or subsequent thereto. If a party to the litigation, other than the patent owner, is a requester of the reexamination, that party may petition to stay the reexamination proceeding only if a reply pursuant to § 1.535 is proper. Otherwise the requester may only notify the Office of the litigation pursuant to § 1.565(a) and § 2282. If the other party to litigation is not the requester, any petition by that party is improper under § 1.550(e) and will not be considered. Any such improper petitions will be returned to the party submitting the same by the examining group director. Petitions to stay, filed subsequent to the date of the order for reexamination, will be referred to the Office of the Assistant Commissioner for Patents for decision. All decisions on the merits of petitions to stay reexamination proceedings because of litigation will be made in the Office of the Assistant Commissioner for Patents on a case-by-case basis. If a timely petition to stay is filed, the examiner should forward the reexamination and patent files to the Office of the Assistant Commissioner for Patents for consideration.

LITIGATION REVIEW AND GROUP DIRECTOR APPROVAL

In order to ensure that the Office is aware of prior or concurrent litigation the examiner is responsible for conducting a reasonable investigation for evidence as to whether the patent for which reexamination is requested has been or is involved in litigation. The investigation will include a review of the reexamination file, the patent file, and the litigation records maintained in the law library including the litigation card files and Shepard's U.S. Citations.

If the examiner discovers, *at any time* during the reexamination proceeding, that there is litigation or that there has been a federal court decision on the patent, the fact will be brought to the attention of the group director prior to any further action by the examiner. The group director must approve any action taken by the examiner in such circumstances.

FEDERAL COURT DECISION CONTROLLING IN REEXAMINATION PROCEEDING

Once a federal court has ruled upon the merits of a patent and reexamination is still appropriate under the guidelines set forth above, the federal court decision will be considered controlling and will be followed as to issues resolved on the merits by the court. The reexamination proceeding will be stayed where appropriate until the court decision becomes final. A consent judgment is not controlling as to requests filed by a person not a party to the litigation.

2287 Conclusion of Reexamination Proceedings [R-7]

Upon conclusion of the reexamination proceedings, the examiner must prepare the reexamination file so that the Office of Publications can prepare and issue a certificate in accordance with 37 CFR 1.570 and 35 U.S.C. 307 setting forth the results of the reexamination proceeding and the content of the patent following the proceeding. See § 2288.

In preparing the reexamination file for publication of the certificate, the examiner must review the reexamination and patent files to be sure that all the appropriate parts are completed. The review should include completion of the following items:

a. the "Reexam Field of Search" and the "Search Notes"—to be sure the file wrapper is filled in with the classes and subclasses that were actually searched and other areas consulted.

b. the "Print Claim(s)" box—to be sure that a representative claim which has been reex-

→ amined is indicated for publication in the Official Gazette.

c. the "Drawing Fig. For O.G." box—to be sure that an appropriate drawing figure is indicated for printing on the certificate cover sheet and in the Official Gazette.

d. face of the file—to be sure that the necessary data is included thereon.

The examiner must also fill out a blue issue slip form PTO-270 and include the current international classification and U.S. classification for both the original classification and all cross-references.

If any new cross-references are added, the examiner must order a copy of the patent by using form PTO-14B and place the copy in the search file so that the certificate may be attached thereto when it issues.

If a paper has been submitted by the patent owner indicating the names of the attorneys to be published on the certificate, that paper should be physically placed on top of the other papers in the center of the reexamination file at the conclusion of the proceedings.

After the examiner has completed the review and the reexamination and patent files have been turned in, the reexamination clerk will revise and update the files and forward the reexamination file to the Office of Publications for printing via the Office of Quality Review.

The examiner must also complete a check list form for the reexamination file which will be forwarded to the Office of Publications identifying:

1. any amendments to the abstract and description
2. any amendments to the drawings
3. any claims amended
4. any claims cancelled
5. any claims added
6. any claims the patentability of which has been confirmed
7. any claims not reexamined
8. any decision of the Patent and Trademark Office, federal court, or other forum which may affect the validity of the patent, but which have not been considered during reexamination.

The clerk should check to see if any changes in especially:

1. the title,
2. the address of the owner's attorney, or
3. the requester's address

→ have been properly entered on the face of the reexamination and patent files and in the PALM data base.

2288 Issuance of Reexamination Certificate [R-7]

35 U.S.C. 307. *Certificate of patentability, unpatentability, and claim cancellation.* (a) In a reexamination proceeding under this chapter, when the time for appeal has expired or any appeal proceeding has terminated, the Commissioner will issue and publish a certificate canceling any claim of the patent finally determined to be unpatentable, confirming any claim of the patent determined to be patentable, and incorporating in the patent any proposed amended or new claim determined to be patentable.

* * * * *

37 CFR 1.570 *Issuance of reexamination certificate after reexamination proceedings.* (a) Upon the conclusion of reexamination proceedings, the Commissioner will issue a certificate in accordance with 35 U.S.C. 307 setting forth the results of the reexamination proceeding and the content of the patent following the reexamination proceeding.

(b) A certificate will be issued in each patent in which a reexamination proceeding has been ordered under § 1.525. Any statutory disclaimer filed by the patent owner will be made part of the certificate.

(c) The certificate will be mailed on the day of its date to the patent owner at the address as provided for in § 1.33(c). A copy of the certificate will also be mailed to the requester of the reexamination proceeding.

(d) If a certificate has been issued which cancels all of the claims of the patent, no further Office proceedings will be conducted with regard to that patent or any reissue applications or reexamination requests relating thereto.

(e) If the reexamination proceeding is terminated by the grant of a reissued patent as provided in § 1.565(b), the reissued patent will constitute the reexamination certificate required by this section and 35 U.S.C. 307.

(f) A notice of the issuance of each certificate under this section will be published in the *Official Gazette* on its date of issuance.

Since abandonment is not possible in a reexamination proceeding, a certificate will be issued at the conclusion of the proceeding in each patent in which a reexamination proceeding has been ordered under § 1.525 except where the reexamination has been terminated by the grant of a reissue patent on the same patent.

The certificate will set forth the results of the proceeding and the content of the patent following the reexamination proceeding.

The certificate will:

- a. cancel any claims determined to be unpatentable;
- b. confirm any patent claims determined to be patentable;

- c. incorporate into the patent any amended or new claims determined to be patentable;
- d. make any changes in the description approved during reexamination;
- e. include any statutory disclaimer filed by the patent owner;
- f. refer to unamended claims held invalid on final holding by another forum on grounds not based on patents or printed publications;
- g. refer to any patent claims not reexamined; and
- h. be mailed on the day of its date to the patent owner at the address provided for in § 1.33(c) and a copy to the requester.

If a certificate issues which cancels all of the claims of the patent, no further Office proceedings will be conducted with regard to that patent or any reissue application or reexamination request directed thereto.

If a reexamination proceeding is terminated by the grant of a reissued patent as provided for in § 1.565(b), the reissued patent will constitute the reexamination certificate required by 35 U.S.C. 307 and this section.

A notice of the issuance of each reexamination certificate will be published in the Official Gazette on its date of issuance in a format similar to that used for reissue patents. See § 2291.

2289 Quality Review [R-7]

Reexamination files are reviewed by Quality Review on a regular basis. All reexamination cases are screened in Quality Review for obvious errors and proper preparation in order to issue a certificate. A substantive determination will be made in a sample of reexamination cases reviewed by the Quality Review Examiners. This review is an appropriate vehicle to provide information on the uniformity of practice and to help identify problem areas.

2290 Format of Certificate [R-7]

The reexamination certificate will be formatted much the same as the title page of current U.S. patents. The certificate will be titled "Reexamination Certificate" and will carry the patent number of the original patent preceded by the letter "B" and the number of the reexamination proceeding of that patent. For example, "1" for the first reexamination certificate and "2" for the second reexamination certificate. The letter designation distinguishes the certificate as being a reexamination certificate. Thus, a second reexamination certificate for the same patent would be designated as "B2" followed by the patent number.

The certificate will denote the date the certificate was issued at INID code [45] (see § 901.04). The title, name of inventor, international and U.S. classification, the abstract, and the list of prior art documents will appear at their respective INID code designations much the same as is presently done in utility patents.

The primary differences, other than as indicated above are:

1. the filing date and number of the request is preceded by "Reexamination Request";
2. the patent for which the certification is now issued is identified under the heading "Reexamination Certificate for"; and
3. the prior art documents cited at INID code [56] will be only those which are part of the reexamination file and cited on forms PTO-1449 (and have not been crossed out because they were not considered) and PTO-892.

Finally, the certificate will specify the claims confirmed as patentable and those cancelled. Any new claims will be printed and any amended claims will be printed indicating the amendments thereto. Any prior court decisions will be identified as well as the citation of the court decision.

REEXAMINATION CERTIFICATE (1st)

United States Patent [19]

[11] B1 3,367,320

Jenn et al.

[45] Certificate Issued Dec. 29, 1981

- [54] SELF-VENTILATING COOKING RANGE
- [75] Inventors: Louis J. Jenn; Thomas R. Field,
both of Indianapolis, Ind.
- [73] Assignee: Jenn-Air Corporation, Indianapolis,
Ind.

[56] References Cited

U.S. PATENT DOCUMENTS

2,076,479	1/36	O'Connell.	
2,674,991	4/1954	Schaefer.....	126-299
3,002,513	10/61	Morasch.	
3,102,533	9/1963	Jenn et al.....	126-303

Primary Examiner—Edward G. Favors.

[57] ABSTRACT

An apparatus for capturing and exhausting grease laden or odoriferous vapors produced when cooking on surface heating elements of a cooking range, and including provision for establishing a negative pressure region immediately above the surface heating elements and substantially coextensive therewith, and for removing such vapors from the region through a suitable plenum housing and from thence to appropriate venting apparatus.

Reexamination Request

No. 90/000,027, Jul. 14, 1981

Reexamination Certificate for:

Patent No.: 3,367,320
 Issued: Feb. 6, 1968
 Appl. No.: 568,522
 Filed: Jul. 28, 1966

- [51] Int. Cl.³..... F24C 15/20
- [52] U.S. Cl. 126/300
- [58] Field of Search..... 126/299, 300, 303; 98/115R

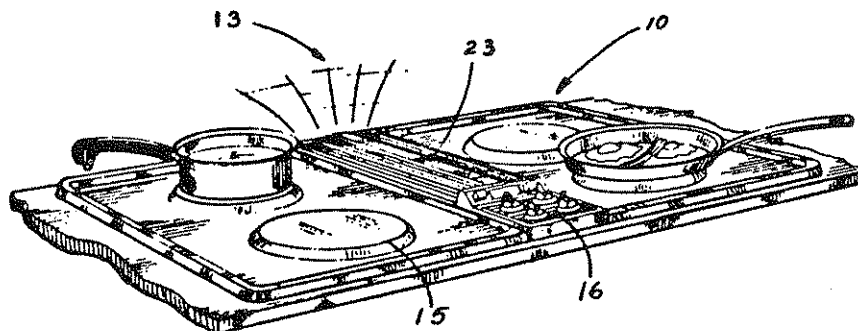

B1 3,367,320

1

2

↖
↙
**REEXAMINATION CERTIFICATE
ISSUED UNDER 35 U.S.C. 307.**
NO AMENDMENTS HAVE BEEN MADE TO
THE PATENT

**AS A RESULT OF REEXAMINATION, IT HAS
BEEN DETERMINED THAT:**

The patentability of claims 1-7 is confirmed.

* * * * *

→ **2291 Notice of Certificate Issuance in Official Gazette [R-7]**

The Official Gazette notice will include bibliographic information, and an indication of

the status of each claim following reexamination. ←

Additionally, a representative claim will be published along with an indication of any changes to the specification.

REEXAMINATIONS

DECEMBER 29, 1981

Matter enclosed in heavy brackets [] appears in the patent but forms no part of this reexamination specification; matter printed in italics indicates additions made by reexamination

B1 3,367,320 (1st)
SELF-VENTILATING COOKING RANGE
 Lewis J. Jenn and Thomas R. Field, Indianapolis, Ind.,
 assignors to Jenn-Air Corporation, Indianapolis, Ind.
 Reexamination Request No. 90/000,027, Jul. 14, 1981.
 Reexamination Certificate for Patent No. 3,367,320, issued
 Feb. 6, 1968, Ser. No. 568,522, Jul. 28, 1966.
 U.S. Cl. 126-300 Int. Cl.³ F24C 15/20

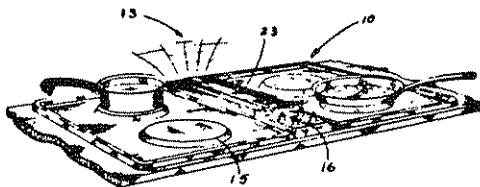

AS A RESULT OF REEXAMINATION, IT HAS BEEN DETERMINED THAT:

The patentability of claims 1-7 is confirmed.

1580

1. For use with a cooking range of the type having a horizontal surface and at least one series of substantially aligned heating elements positioned thereon for cooking purposes, the combination thereof with apparatus, for capturing and removing grease laden or odoriferous vapors produced while cooking on said range, said apparatus comprising, means defining an elongate air intake opening substantially flush with said surface, said opening being in close proximate relation to and substantially longitudinally coextensive with said series of heating elements, a plenum housing coupled to said air intake opening defining means and disposed beneath said surface, and power driven air moving means communicating with said plenum housing for continuously drawing a high volume rate of air through said air intake opening and plenum housing and thereby create a region of negative air pressure immediately above said opening, said negative air pressure region extending over said series of heating elements and being substantially coextensive therewith whereby the grease laden or odoriferous vapors present in the air above said surface and said series of heating elements is positively captured and removed through said opening and said plenum housing.

➤ **2292 Distribution of Certificate**
[R-7]

A copy of the reexamination certificate should be stapled to each copy of the patent in the search files. A copy of the certificate will also be made a part of any patent copies prepared by the Office subsequent to the issuance of the certificate.

A copy of the certificate will also be forwarded to all depository libraries and to those foreign offices which have an exchange agreement with the U.S. Patent and Trademark Office.

2293 Intervening Rights [R-7]

35 U.S.C. 307. Certificate of patentability, unpatentability, and claim cancellation.

➤ * * * * *

← (b) Any proposed amendment or new claim determined to be patentable and incorporated into a patent following a reexamination proceeding will have the same effect as that specified in section 252 of this title for reissued patents on the right of any person who made, purchased, or used anything patented by such proposed amended or new claim, or who made substantial preparation for the same, prior to issuance of a certificate under the provisions of subsection (a) of this section." ←

The situation of intervening rights resulting from reexamination proceedings parallel those resulting from reissue proceedings and the rights detailed in 35 U.S.C. 252 apply equally in reexamination and reissue situations. ←