

Thimerosal
[54-64-8]

Nomination to the National Toxicology Program

Review of the Literature
April 2001

Executive Summary

The nomination of thimerosal is based on its wide use as a preservative in vaccines and other biological products, the large number of exposures, and the lack of toxicity data.

Thimerosal (sodium ethylmercurithiosalicylate; also called thiomersal and merthiolate) was developed by Eli Lilly in the 1930s and has been used as a preservative in vaccines and other products because of its bacteriostatic and fungistatic properties. It is prepared by the interaction of ethylmercuric chloride or hydroxide with thiosalicylic acid and sodium hydroxide, in ethanol.

Human exposure to thimerosal occurs through use of biological products such as certain vaccines, antivenins and immune globulin preparations, as well as some drug products including ophthalmic, otic, nasal and topical products. A review by the FDA in 1999 estimated that thimerosal was used in over 30 licensed and marketed vaccines and biologics. In recent years the largest exposure to thimerosal in terms of numbers exposed and amount ($\mu\text{g}/\text{kg}$ body weight) may have been through vaccinations. Every year, approximately 4 million infants (the U.S. birth cohort) receive vaccines according to the U.S. routine childhood immunizations schedule. During the past decade, additional vaccinations have been added to the routine childhood immunization schedule, and until recently, some of these vaccines contained thimerosal as a preservative. Prior to the recent approval of additional thimerosal-free or thimerosal-reduced vaccines, an infant may have received a total mercury dose from vaccines as much as $187.5 \mu\text{g}$ during the first 6 months of life. In special populations, influenza vaccine may be administered at 6 months of age, which would increase the total dose to approximately $200 \mu\text{g}$.

Although thimerosal has been used in the U.S. as a preservative in vaccines and other licensed products since the 1930s, limited data are available on the toxicology of thimerosal and its metabolite ethylmercury. In humans, the only well-established hazard of thimerosal at doses found in vaccines is delayed-type hypersensitivity reactions. At very high doses, the identified hazards of thimerosal include neurotoxicity and nephrotoxicity.

Only one published study evaluated the effect of thimerosal in vaccines on blood levels of mercury. This study measured the total mercury blood levels before and after hepatitis B vaccination in a small number of term and preterm newborn infants and suggested that a birth dose of hepatitis B vaccine may produce small but measurable increases in blood levels of mercury.

In order to assess the potential health effects of exposure to thimerosal in childhood vaccines, the Centers for Disease Control and Prevention (CDC) sought epidemiological data to examine selected outcomes with varying exposure levels of thimerosal. This "screening analysis" found weak (relative risk less than 2) but statistically-significant associations between exposure to thimerosal-containing vaccines before the age of 6 months and tic disorders, attention deficit disorders (ADD), and speech and language disorders. The investigators then used another, smaller database from the East Coast for a more focused study to test the hypotheses that tic disorders, ADD, and speech and language disorders are associated with thimerosal exposure before 6 months of age. This study did not confirm an association. Taken together, the results of the two studies are inconclusive as to an effect of thimerosal on neurological outcomes.

Only limited data were available on the reproductive and teratogenic effects of thimerosal. In one study of pregnant rats and rabbits receiving intraperitoneal injections and ocular instillations, no teratological effects or evidence of maternal toxicity were observed, but dose related embryo- and fetal lethality was found. A comparison of topical and subcutaneous administration of thimerosal to rabbits showed measurable mercury present in blood and tissues of the treated animals and their offspring, although no sign of tissue damage was apparent by light microscopy. Thimerosal was found to cross the blood-brain and placenta barriers.

Limited information on the carcinogenicity and genetic toxicity of thimerosal was found. In a toxicology and carcinogenesis study, rats were subcutaneously injected twice-weekly with thimerosal at doses ranging from 30 to 1000 µg /kg for 1 year. Histological observations included findings of lung tumors at a similar incidence to negative controls or at lower incidence than positive controls. Thimerosal-injected animals demonstrated a dose-related inhibition of spontaneous interstitial cell tumors of the testicles. In a test of genetic toxicity, thimerosal was not found to be mutagenic in *Salmonella typhimurium*. In vivo, thimerosal did not induce aneuploidy.

Methylmercury, an organic mercurial similar to ethylmercury, has been associated in some studies with subtle neurodevelopmental abnormalities at low doses. There exists an extensive body of research on the toxicity of methylmercury, but the applicability of these data to the toxicity of ethylmercury are not currently known. Limited data were found on the comparative toxicology of ethylmercury vs. methylmercury. One animal study directly compared the toxicity of these compounds in rats administered 5 daily doses (8.0 or 9.6 mg/kg) of equimolar concentrations of ethyl- or methylmercury by gavage. Tissue distribution, and the extent and severity of histological changes in the brain and kidney were assessed. Neurotoxicity of ethyl- and methylmercury was similar, with higher levels of inorganic mercury observed in the brains of ethylmercury treated rats. Renal damage was greater in rats receiving ethylmercury. Although the data are limited, similar toxicological profiles between ethylmercury and methylmercury raise the possibility that neurotoxicity may also occur at low doses of thimerosal.

Under the FDA Modernization Act of 1997 requiring the study of the “adverse effects on health of children and other sensitive populations from exposure to ... mercury”, FDA conducted a review of the use of thimerosal in childhood vaccines. FDA compared exposure levels of infants to ethylmercury from vaccines to existing guidelines for exposure to methylmercury, as there are no existing guidelines for safe exposure to ethylmercury, the metabolite of thimerosal. While this review found no evidence of adverse effects caused by thimerosal in vaccines, except for minor local hypersensitivity reactions, the assessment determined that the use of thimerosal as a preservative in vaccines might result in the intake of mercury during the first six months of life that exceeded recommended guidelines from the Environmental Protection Agency (EPA), but not guidelines from the Agency for Toxic Substance and Disease Registry (ATSDR), FDA, or World Health Organization (WHO).

As a precautionary measure, in July 1999, the Public Health Service (PHS), along with the American Academy of Pediatrics and the American Academy of Family Physicians, issued a joint statement on thimerosal and vaccines asking manufacturers to reduce or eliminate

thimerosal as a preservative in childhood vaccines and substantial progress has been made to date. With the recent approval of a new formulation of one of the licensed diphtheria and tetanus toxoids and acellular pertussis (DTaP) vaccines, all routinely recommended pediatric vaccines in distribution will contain no thimerosal or markedly reduced amounts.

There is continued interest, however, on the part of the public as well as PHS agencies to better characterize the potential toxicity of thimerosal. In the U.S., thimerosal is still present as preservative in some vaccines given to young children, as well as certain biological products recommended during pregnancy. Thimerosal remains a preservative in some vaccines administered to adolescents and adults. In addition, thimerosal continues to be used internationally as a vaccine preservative. Further data are needed to determine whether harmful effects have occurred from prior exposure to thimerosal or from its continued use as a preservative in the U.S and international settings.

Thimerosal is nominated to the NTP for further study to assess gaps in knowledge regarding toxicokinetics and the potential for neurodevelopmental toxicity. These gaps include comparative toxicity of ethyl- and methylmercury, the metabolism and elimination of ethylmercury compared with methylmercury, the effect of intermittent intramuscular doses of thimerosal from vaccines compared with chronic low dose oral exposure to methylmercury, and the susceptibility of the infant compared with the fetus to adverse effects from organic mercurials. In order to provide a more complete assessment of the toxicity of thimerosal during the critical period of neurodevelopment, well-designed studies are needed to address these gaps in knowledge in appropriate animal model(s).

Table of Contents

1.0	Basis of Nomination	6
2.0	Chemical Properties	7
2.1	Chemical Identification	8
2.2	Physical-Chemical Properties	8
2.3	Purity and Commercial Availability	8
3.0	Production Processes and Analyses	8
4.0	Production and Import Volumes	8
5.0	Uses	8
6.0	Environmental Occurrence.....	9
7.0	Human Exposure.....	9
8.0	Regulatory Status.....	11
9.0	Toxicological Data.....	11
9.1	General Toxicology	11
9.1.1	Animal Studies	11
9.1.2	Humans.....	12
9.1.3	Comparison of Ethylmercury vs. Methylmercury.....	14
9.2	Reproduction and Teratology	15
9.3	Carcinogenicity	15
9.3.1	Animal	15
9.3.2	Human	15
9.4	Genotoxicity	15
9.5	Immunotoxicity.....	16
10.0	Structure-Activity Relationships	17
11.0	Selection of the Rhesus Monkey as the Animal Model	17
12.0	Online and Secondary References	18
12.1	Online Databases	18
12.2	Secondary References.....	18
13.0	References	19

1.0 Basis of Nomination

The nomination of thimerosal [54-64-8] by the Center for Biologics Evaluation and Research, U.S. Food and Drug Administration is based on its wide use as a preservative in vaccines and other biological products, the large number of exposures via vaccination, and the lack of toxicity data.

Humans may be exposed to thimerosal from biological and drug products. In recent years, however, the largest exposure to thimerosal in terms of numbers of individuals exposed and dose ($\mu\text{g}/\text{kg}$ body weight) may have been through vaccinations. Every year, approximately 4 million infants (the U.S. birth cohort) receive vaccines according to the U.S. routine childhood schedule (CDC 2001). During the past decade, additional vaccinations have been added to the routine childhood immunization schedule, and until recently some of these vaccines contained thimerosal as a preservative.

Under the FDA Modernization Act of 1997 requiring the study of the “adverse effects on health of children and other sensitive populations from exposure to ... mercury”, FDA conducted a review of the use of thimerosal in childhood vaccines. One component of this risk assessment was an exposure assessment for the U.S. recommended childhood immunization schedule based on thimerosal content in vaccines prior to licensure of thimerosal-free hepatitis B infant vaccines. (Ball 2001) FDA compared exposure levels of infants to ethylmercury from vaccines to existing guidelines for exposure to methylmercury, as there are no existing guidelines for safe exposure to ethylmercury, the metabolite of thimerosal.

While this review found no evidence of adverse effects caused by thimerosal in vaccines, except for minor local hypersensitivity reactions, the assessment determined that the use of thimerosal as a preservative in vaccines might result in the intake of mercury during the first six months of life that exceeded recommended guidelines from the Environmental Protection Agency (EPA). However, the recommended guidelines developed for methylmercury exposure from dietary exposures set by the FDA, the Agency for Toxic Substances and Disease Registry (ATSDR), and the World Health Organization (WHO) were not exceeded. Of note, such guidelines contain as much as a 10-fold safety factor, and are meant as starting points for the evaluation of mercury exposure, not absolute levels above which toxicity can be expected to occur.

As a precautionary measure, in July 1999, the Public Health Service (PHS), along with the American Academy of Pediatrics and the American Academy of Family Physicians, issued a joint statement on thimerosal and vaccines asking manufacturers to reduce or eliminate thimerosal as a preservative in childhood vaccines (CDC 1999) The FDA’s Office of Vaccines Research and Review (OVRR) has been encouraging manufacturers to develop new vaccines without thimerosal as a preservative and to remove or reduce the thimerosal content of existing, licensed vaccines for several years. Substantial progress has been made in the removal of thimerosal from vaccines. With the recent approval of a new formulation of one of the licensed diphtheria and tetanus toxoids and acellular pertussis (DTaP) vaccines, all routinely

recommended pediatric vaccines in distribution will contain no thimerosal or markedly reduced amounts.

However, there is continued interest on the part of the public as well as PHS agencies to better characterize the potential toxicity of exposure to thimerosal from vaccines. In the U.S., thimerosal is still present in some vaccines given to young children in certain circumstances, e.g., influenza vaccine and diphtheria and tetanus toxoids (DT) vaccine. Thimerosal is also present in certain biological products recommended during pregnancy, e.g., influenza vaccine. Thimerosal remains as a vaccine preservative in some vaccines administered to adolescents and adults (e.g., Td and TT vaccines, influenza vaccine, one pneumococcal polysaccharide vaccine, and adult formulations of hepatitis B vaccine). In addition, thimerosal continues to be used as a vaccine preservative internationally. Although thimerosal has been removed as a preservative in vaccines administered under the routine U.S. childhood immunization schedule, it is important to determine whether any harmful effects may have occurred from previous exposure or its continued use in the U.S. and international settings.

Thimerosal is nominated to the NTP for further study to assess gaps in knowledge regarding toxicokinetics and the potential for neurodevelopmental toxicity. These gaps include the comparative toxicity of ethyl- and methylmercury, the metabolism and elimination of ethylmercury compared with methylmercury, the effect of intermittent intramuscular doses of thimerosal from vaccines compared with chronic low dose oral exposure to methylmercury, and the susceptibility of the infant compared with the fetus to adverse effects from organic mercurials. In order to provide a more complete assessment of the toxicity of thimerosal during the critical period of neurodevelopment, well-designed studies are needed in appropriate animal model(s).

2.0 Chemical Properties

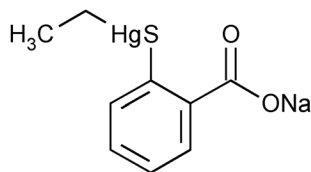

Thimerosal [54-64-8]

Thimerosal degrades in sunlight and in the presence of oxygen yielding thiosalicylate and ethylmercury. Improper storage of the final product results in measurable degradation. The extent and rate of degradation under physiological conditions was not addressed in the published literature. No references were found on the extent to which thimerosal is metabolized following administration to animals or humans.

2.1 Chemical Identification

Thimerosal ($C_9H_9NaO_2S$, mol. wt. = 404.81) is also called:

Ethyl[2-mercaptobenzoato(2-)-*O,S*]-mercurate(1-) sodium

Ethyl (sodium *o*-mercaptobenzoato)mercury

sodium ethylmercurithiosalicylate

Thiomersal (BP)

Merfamin

Merthiolate

Mertorgan

Merzonin

2.2 Physical-Chemical Properties (Ref. USP XXII)

Acidity/alkalinity: pH = 6.7 for a 1% w/v aqueous solution at 20°C.

Density (bulk), 0.33g/cm³

Dissociation constant: $PK_a = 3.05$ at 25°C

Melting point: 232-233°C with decomposition

Solubility: soluble 1 in 8 of ethanol (95%), 1 in 1 of water; practically insoluble in benzene and ether.

2.3 Purity and Commercial Availability

Thimerosal is available from American International Chemical, Inc., Natick, MA; Dysars Sal, Segovia, Spain; Dolder LTD, Basel, Switzerland; and Spectrum Quality Products Inc., Gardena, CA.

3.0 Production Processes and Analyses

Thimerosal is prepared by the interaction of ethylmercuric chloride or hydroxide with thiosalicylic acid and sodium hydroxide, in ethanol.

4.0 Production and Import Volumes

Thimerosal is produced by several manufacturers in the U.S. and internationally. This review could not determine the quantity of thimerosal produced or imported into the U.S.

5.0 Uses

Thimerosal has been used as an antimicrobial preservative in pharmaceutical products since the 1930s. It has also been used in some cosmetics and to soft contact lens solutions. It has both bacteriostatic and fungistatic activity.

Thimerosal has been used as a preservative in U.S. licensed biological products including vaccines, immune globulins, antivenins and skin test antigens, although many of these products

are no longer produced or distributed in the U.S. A review by the FDA in 1999 estimated that thimerosal is used in over 30 licensed and marketed vaccines and biologics (Federal Register 1999). As a preservative in products administered via intramuscular, intravenous and subcutaneous injection, thimerosal is used at a concentration of 0.003% to 0.01%.

FDA regulations require that preservatives be present in multidose vials of vaccines, with the exception of certain live viral vaccines, to prevent bacterial and fungal contamination (21 CFR 610.15(a)). Preservatives are not required for products formulated in single-dose vials. Multidose vials are preferred by some physicians and health clinics because they are often less expensive per vaccine dose and require less storage space. As a preservative, thimerosal may be added at the end of the production process to the bulk or final container, or it may be added to the diluent of a lyophilized vaccine. In addition to its prominent role as a preservative, thimerosal is used as an inactivating agent in the manufacture of certain vaccines (e.g., whole cell pertussis and some acellular pertussis vaccines) and as a bacteriostatic agent during the production process of other vaccines (e.g., influenza vaccines). Uses other than as a preservative, however, contribute little to the final concentration of thimerosal in vaccines (at most 2-3 µg thimerosal/mL), with limits of detection of less than 0.2 µg thimerosal/mL (May 1978).

Thimerosal is also used as a preservative in ophthalmic and otic products at concentrations of 0.001% to 0.01%. Thimerosal is used in nasal spray/drop products at 0.00025% to 0.002%, in a few topical products at 0.01% and in hyaluronidase injection products at 0.01%.

6.0 Environmental Occurrence

Mercury is a chemical element that cannot be created or destroyed, with the same amount present on the earth since its creation. Mercury cycles in the environment as a result of natural and human activities (Mahaffey 1997). The majority of mercury in the environment is in water, soil, sediments, plants and animals in the form of inorganic mercury salts and organic forms of mercury such as methylmercury. The most efficient accumulation of mercury is in the aquatic food chain, with predatory animals at the top of the chain having higher mercury concentrations. Nearly all of the mercury in seafood is in the form of methylmercury. Thimerosal is metabolized or degraded into ethylmercury and thiosalicylate. The contribution of thimerosal to the total environmental burden of mercury is not known.

7.0 Human Exposure

Humans are exposed to thimerosal from biological and other drug products. The Food and Drug Administration Modernization Act of 1997 (FDAMA) Section 413(a) required the FDA to compile a list of drugs and foods that contain intentionally introduced mercury compounds and provide a quantitative and qualitative analysis of the mercury compounds in this list (Federal Register 1999). Manufacturers submitted information on 27 human drug products (other than vaccines) that contained thimerosal as a preservative. These consisted of 13 ophthalmic and otic products at a concentration of 0.001 to 0.01%. Thimerosal was used in 10 nasal spray/drop

products at 0.00025% to 0.002%. Two topical products contained 0.01% thimerosal and 2 hyaluronidase injection products contained 0.01%. The manufacturers reported estimated amounts of thimerosal used in production of these products as 1,086 grams (g) for 10 nasal products, 1,123 g for 9 ophthalmic products, 6,015 g for 4 otic products, 40 g for 2 topical products, and 192 g for the 2 hyaluronidase injection products.

Under FDAMA 1997 Section 413(a), 10 manufacturers of biological products submitted information on a total of 38 products that contain thimerosal: 30 vaccines, 7 other biological products, and 1 diluent for a vaccine. The vaccines containing thimerosal as preservative included diphtheria and tetanus toxoids vaccines (DT, Td, TT), diphtheria and tetanus toxoids and whole cell or acellular pertussis vaccines (DTP or DTaP), DTP or DTaP combined with *Haemophilus influenzae* type b conjugate vaccines (DTP-Hib or DTaP-Hib), influenza vaccines, hepatitis B vaccines, Hib vaccine, pneumococcal polysaccharide vaccine, and Japanese encephalitis vaccine. One vaccine (meningococcal polysaccharide) used a diluent that contained thimerosal. The other 7 biological products were 3 anti-venins, 2 human immunoglobulins, 1 skin test antigen, and 1 horse serum. As a preservative in biological products administered via intramuscular, intravenous, subcutaneous, or intradermal injection, thimerosal is used at a concentration of 0.003 to 0.01%. The manufacturers estimated that the amount of thimerosal used was 27,533 g for vaccines, 60 g for the immune globulins, 7 g for the antivenins, 4 g for the skin test antigen, 1 g for the horse serum and 50 g for the diluent for meningococcal vaccine. Compliance of reporting under the Section 413(a) call-for-data was not assessed; thus thimerosal-containing products not reported here may be in distribution.

In recent years the largest exposure to thimerosal in terms of number of individuals exposed and amount ($\mu\text{g}/\text{kg}$ body weight) may have been through childhood vaccinations. Every year, approximately 4 million infants (the U.S. birth cohort) receive vaccines according to the U.S. routine childhood immunizations schedule. During the past decade, additional vaccinations have been added to the routine childhood immunization schedule, and until recently, some of these vaccines contained thimerosal as a preservative. During the 1999 review conducted under FDAMA 1997 (Ball 2001), childhood vaccines that might contain thimerosal as a preservative included single antigen hepatitis B vaccines; some diphtheria and tetanus toxoids and acellular pertussis (DTaP) vaccines; all diphtheria and tetanus toxoids and whole cell pertussis (DTP) vaccines; and some *Haemophilus influenzae* type b (Hib) vaccines. The total amount of mercury by weight was calculated for each vaccine in the infant schedule. For formulations containing thimerosal as a preservative, hepatitis B vaccine contains approximately 12.5 μg mercury per 0.5 ml dose, DTaP or DTP approximately 25 μg mercury, and Hib vaccine approximately 25 μg mercury. Depending on the particular vaccine formulation and schedule, an infant may receive a total mercury dose from vaccines as much as 187.5 μg during the first 6 months of life. In special populations, influenza vaccine may be administered at 6 months of age, which would increase the total dose to approximately 200 μg . Vaccines that use thimerosal during the production process, but not as a preservative, contain less than 3 μg thimerosal/mL and, therefore, were not considered in this exposure assessment.

Estimates of thimerosal exposure from vaccines among 85,000 children who receive health care in a large health maintenance organization in California indicate that approximately 10% of infants received more than 112 μg ethylmercury from vaccines during the first 6 months of life

(Bernier 1999). In addition, certain infants may be exposed to high levels of mercury from the diet or environment. These exposures should be added to those from vaccines in assessing the total exposure of infants to mercury.

8.0 Regulatory Status

There are currently no exposure guidelines for thimerosal or ethylmercury. The U.S. EPA (Mahaffey 1997), the ATSDR (ATSDR 1999), the FDA (Federal Register 1979), and the World Health Organization (WHO 1996) have developed recommendations for limits of exposure to methylmercury in the diet. These range from 0.1 µg/kg body weight/day (EPA) to 0.47 µg/kg body weight/day (WHO)* and include varying safety margins. The range of recommendations is due to differing emphasis placed on various primary data sources and the different purposes for these recommendations. All guidelines, however, fall within the same order of magnitude.

9.0 Toxicological Data

9.1 General Toxicology

Summary: Limited data are available on the toxicology of thimerosal and its metabolite ethylmercury. The only well-established hazard of thimerosal at doses found in vaccines is delayed-type hypersensitivity reactions. At very high doses, the identified hazards of thimerosal are neurotoxicity and nephrotoxicity. Methylmercury, a similar organic mercurial, has been associated in some studies with subtle neurodevelopmental abnormalities at low doses. Although the data are limited, similar toxicological profiles between ethylmercury and methylmercury suggest that neurotoxicity may also occur at low doses of thimerosal; however, such effects have not been reported. In addition, data were not found on the potential for additive effects of exposure to thimerosal with other organic and inorganic mercury compounds.

9.1.1 Animal Studies

Limited animal studies have examined the toxicity of thimerosal or ethylmercury. Low doses of thimerosal equivalent to ethylmercury doses of either 1 or 6 µg/kg/day in adult squirrel monkeys were converted to inorganic mercury, with high levels detected in the kidney and lower levels found in the brain (Blair 1975). Histopathological changes were not observed in either the kidney or brain.

Prior to the marketing of thimerosal as a preservative in 1931, high dose toxicity studies were conducted in rabbits, rats, mice, dogs and guinea pigs (Powell 1931). Rabbits, rats, and mice received intravenous injections of 1% solution with observation periods limited to 7 days; the use of control animals was not reported. The maximum tolerated doses were reported as 20 mg/kg (rabbits) and 45 mg/kg (rats). For rabbits, the pathology of fatal cases was described as “essentially that of mercurial poisoning, including kidney and intestinal lesions.” Four dogs received 2 mg/kg of 1% solution every third day for

*The WHO guideline is expressed as 3.3 µg/kg body weight/week and has been converted to a daily dose for purpose of comparison.

12 doses. Autopsies performed seven days after completion found “only minor microscopic tissue changes.” Immediately following intraperitoneal injections of 1/1000 (0.1%) solution, guinea pigs demonstrated evidence of severe pain. “Fairly pronounced” congestion and hemorrhage in the visceral, parietal and omental peritoneum were observed when animals were sacrificed and examined 1-2 days after injection. The authors reported that “no abnormal pain responses” were seen in guinea pigs injected with dilutions of 1/4000 and 1/8000.

Under a FDA contract (#Ph43-67-676 for the Division of Biologics Standard, NIH) carcinogenicity and toxicity studies of preservatives and other agents in vaccines were performed (Mason 1971). The studies were conducted in three stages: 1) acute toxicity to approximate the LD₅₀, 2) 4-week injection period (twice weekly) at five dose levels to determine the maximum tolerated dose and 3) a long term (1 year) inoculation series to evaluate chronic toxicity and carcinogenicity. In the last study, Fischer rats were subcutaneously injected twice-weekly with thimerosal at doses ranging from 30 to 1000 µg /kg for 1 year. Control rats were either untreated (negative control), or treated with nickel which is known to induce local inflammatory reactions (positive control). Animals were weighed weekly and autopsied at either 12 or 18 months after initial injection. All animals with spontaneous deaths, moribund, or with gross organ pathology had organs examined histologically.

In this study, the LD₅₀ of thimerosal in rats was 98 mg/kg (95% confidence interval 82-117); the maximum tolerated dose (MTD) for thimerosal after 4 weeks of injection was 5.0 mg/kg and a high dose of 1.0 mg/kg was established for the chronic study. The thimerosal-treated rats had a dose-dependent increase in the incidence of bronchopneumonia, compared with rats receiving other preservatives or controls, with 60% of the thimerosal-treated animals demonstrating unspecified histopathologic changes at the highest dose, compared with 13% of untreated controls. The death rate for the thimerosal-treated animals paralleled that of other preservatives and controls leading the authors to conclude “the damage was slight, continuous, and perhaps cumulative.” In addition, animals receiving thimerosal at the highest dose levels over the 12 month period demonstrated on average a 10% (range 5%-14%) retardation of weight gain when compared with controls. Histopathology of the brain and kidney in thimerosal-treated animals was not reported. Quantitative data were compiled only for the highest dose levels; at lower doses the retardation of weight gains was reported to be “less significant”.

9.1.2 Humans

No clinical studies were found that formally evaluated the safety of thimerosal prior to its initial marketing. The earliest report of thimerosal use in humans was found in a 1931 article (Powell and Jamieson 1931). In this report of clinical use by another investigator, 22 individuals received 1% solution of thimerosal intravenously for unspecified therapeutic reasons. Subjects received up to 10 mg thimerosal/kg with no reported toxic effects, although 2 subjects demonstrated phlebitis or sloughing of skin after local infiltration. This study was not specifically designed to examine toxicity; 7 of 22

subjects were observed for only one day, the specific clinical assessments were not described, and no laboratory studies were reported.

Clinical cases of accidental and intentional acute poisonings with very high doses of thimerosal, while rare, point to the severest forms of toxicity. Several cases of acute mercury poisoning from thimerosal-containing products were found in the medical literature. These reports included the administration of immune globulin (Matheson 1980) and hepatitis B immune globulin (Lowell 1996), chloramphenicol formulated with 1000 times the proper dose of thimerosal as a preservative (Axton 1972), thimerosal ear irrigation in a child with tympanostomy tubes (Royhans 1994), thimerosal treatment of omphaloceles in infants (Fagan 1977), and a suicide attempt with thimerosal (Pfab 1996). Total doses of thimerosal administered in these reports of acute toxicity ranged from approximately 3 mg/kg to several hundred mg/kg. These studies reported local necrosis, acute hemolysis, disseminated intravascular coagulation, acute renal tubular necrosis, and central nervous system injury including obtundation, coma, and death.

No reports of toxicity following low dose exposure to thimerosal in humans were found in the medical literature and limited data were found on the effect of vaccine with thimerosal as a preservative on blood levels of mercury. One recent study measured the change in total mercury blood levels in a small number of infants after hepatitis B vaccination (Stajich 2000). Following one dose of hepatitis B vaccine (approximately 12.5 µg of mercury) given within 3 days of birth, mean mercury blood levels increased from 0.54 to 7.36 µg/L (range 1.3-23.6) in 15 pre-term infants with a mean body weight of 748 g; and from 0.04 to 2.24 µg/L (range 1.4- 2.9) in 5 term infants with a mean body weight of 3.59 kg. This study suggested that a birth dose of hepatitis B vaccine may measurably increase infant mercury blood levels.

Reports to the Vaccine Adverse Event Reporting System (VAERS) were queried searching text fields for “thimerosal”, “thiomersal”, “merthiolate”, and “mercury” in order to identify any events reported as attributable to thimerosal in vaccines (Ball 2001). Of the approximately 90,000 VAERS reports submitted between 1990-1998, a total of 45 reports were identified using this search strategy. Twenty-eight reports involved hepatitis B vaccine, 10 concerned influenza vaccine, 3 concerned diphtheria and tetanus toxoids (Td), and 1 each involved DTaP, combination DTP and *Haemophilus influenzae* type b (DTP-Hib), and concurrent but separate administration of DTP and Hib. The types of events attributed by the reporter to thimerosal included injection site reactions in 13 reports, rash in 9, urticaria in 8, edema in 5, and flu-like syndrome and joint aches in 4. One report involved each of the following events: anaphylaxis, “severe allergic reaction” (not otherwise specified), wheezing, stridor, and malaise/agitation. Only one report required hospitalization (for angioneurotic edema); most others reported doctor or emergency room visits. Of the five reports of edema, two reports concerned facial edema, one involved angioneurotic edema, one mentioned eyelid swelling and one report involved peripheral edema. One report involved a patient with both urticaria and wheezing; the time of onset after vaccination was not specified. Of note, one report described an individual who experienced anaphylaxis following hepatitis B vaccine. When rechallenged with a similar but thimerosal-free product, anaphylaxis occurred again, implying thimerosal was not the causative agent. VAERS has several limitations, including lack of consistent diagnostic criteria, data acquired from a diverse group of voluntary reporters, underreporting, and the difficulty in determining whether a

vaccine caused the adverse event reported. A cause and effect relationship between the reported adverse events and thimerosal in vaccines cannot be established because of these limitations.

In order to assess the potential health effects in infants of exposure to thimerosal in vaccines, the Center for Disease Control and Prevention (CDC) sought epidemiological data to examine selected outcomes with varying exposure levels of thimerosal. The results of a recent “screening analysis” in the U.S. were presented to a peer review group and later to the public (Verstraeten 2000). This retrospective analysis examined whether there was a link between degree of exposure of infants to thimerosal-containing vaccines and the development of certain neurological and renal sequelae. The investigators analyzed computer records derived from two health maintenance organizations on the West Coast of the U.S. The screening analysis found weak (relative risk less than 2) but statistically-significant associations between exposure to thimerosal-containing vaccines before the age of 6 months and tic disorders, attention deficit disorders (ADD), and speech and language disorders. The analysis did not find an association with other neurological and renal disorders. The investigators then used another, smaller database from the East Coast for a more focused study to test the hypotheses that tic disorders, ADD, and speech and language disorders are associated with thimerosal exposure before 6 months of age. This study did not confirm an association. Taken together, the results of the two studies are inconclusive as to an effect of thimerosal on neurological outcomes.

9.1.3 Comparison of Ethylmercury vs. Methylmercury

Limited data were found on the toxicology of thimerosal and its metabolite ethylmercury; however, available data suggest that the toxicity of ethylmercury and methylmercury may be similar. One animal study directly compared the toxicity of ethyl- versus methylmercury. Magos et al. studied adult male and female rats administered 5 daily doses (8.0 or 9.6 mg/kg) of equimolar concentrations of ethyl- or methylmercury by gavage (Magos 1985). Tissue distribution, and the extent and severity of histological changes in the brain and kidney were assessed. Neurotoxicity of ethyl- and methylmercury was similar, with higher levels of inorganic mercury observed in the brains of ethylmercury treated rats. Renal damage was greater in rats receiving ethylmercury.

Much of what is known about methylmercury toxicity comes from poisoning episodes in Japan (Harada 1995) and Iraq (Bakir 1973), as well as studies of populations with dietary exposure, primarily in the Seychelles (Davidson 1998) and Faroe Islands (Grandjean 1997). The toxicity of methylmercury was first recognized during the late 1950s and early 1960s with the consumption of contaminated fish in Minamata, Japan (Harada 1995). Epidemics of methylmercury poisoning also occurred in Iraq during the 1970s when seed grain treated with a methylmercury fungicide entered the food chain as bread (Bakir 1973). Maternal methylmercury exposure in these epidemics was associated with neurological abnormalities, such as delays in motor function, among children exposed in utero.

Additional data from low dose exposure to methylmercury derived from studies of populations exposed in their diet are conflicting. Studies from the Faroe Islands reported that subtle cognitive deficits (e.g., performance on attention, language, and memory tests), detectable by

sophisticated neuropsychometric testing, were associated with methylmercury levels previously thought to be safe (Grandjean 1997). Studies in the Seychelles, evaluating more global developmental outcomes, did not reveal any correlation between abnormalities and mercury levels (Davidson 1998).

9.2 Reproduction and Teratology

One published teratological study of thimerosal was located in the literature. Pregnant rats received daily 1.0 ml intraperitoneal injections of 0.2 or 2% thimerosal solution on Day 6 through Day 18 of gestation. While there were no teratological effects observed, dose-related embryo and fetal lethality was observed. Maternal toxicity was not observed at either dose level. In the same report pregnant rabbits received 2% thimerosal solutions via eye instillations, with applications of thimerosal eight times to each eye on Day 6 and four instillations on each day thereafter to Day 18 of gestation. Again, no teratological effects or evidence of maternal toxicity were observed, but dose related embryo and fetal lethality was found. A comparison of topical and subcutaneous administration of thimerosal to rabbits showed measurable mercury in blood and tissues of the treated animals and their offspring, although no sign of tissue damage was apparent by light microscopy. Thimerosal was found to cross the blood-brain and placenta barriers (Gasset 1975).

9.3 Carcinogenicity

9.3.1 Animal

In the previously discussed toxicology and carcinogenesis study of chemicals found in vaccines, (Mason 1971) Fischer rats were subcutaneously injected twice-weekly with thimerosal at doses ranging from 30 to 1000 µg /kg for 1 year. Control rats were either untreated (negative control), or treated with nickel which is known to induce local inflammatory reactions (positive control). Animals were weighed weekly and autopsied at either 12 or 18 months after initial injection. All animals with spontaneous deaths, moribund, or with gross organ pathology had organs examined histologically as well as those chosen for routine examination. Histological observations included findings of lung tumors at a similar incidence to negative controls or at lower incidence than positive controls. Thimerosal-injected animals demonstrated a dose-related inhibition of spontaneous interstitial cell tumors of the testicles. At the highest dose, 4 of 27 male rats developed interstitial cell tumors; this was a decrease from 100% in control animals to 14.8% ($p < 0.01$).

9.3.2 Human

No data were found evaluating the carcinogenicity of thimerosal in humans.

9.4 Genotoxicity

Zeiger et al. reported that thimerosal did not induce gene mutations in *Salmonella typhimurium* (Zeiger 1987). Strains TA100, TA98, TA1535, and TA1537 were exposed to doses from 100 to

10,000 µg/plate using the pre-incubation method in either the presence or absence of 10% rat or hamster liver metabolic activation.

Thimerosal was evaluated in *in vivo* studies on chemically induced aneuploidy in mouse bone marrow and spermatocytes in the context of laboratory validation studies sponsored by the European Community. Thimerosal dosing resulted in a weakly positive effect in the mouse micronucleus assays conducted in one of the participating laboratories (Marrazzini 1994). However, no effect was observed in the mouse micronucleus assay conducted at the other laboratories participating in the validation testing (Leopardi 1993; Miller 1992; Adler 1993). Thimerosal produced no chromosomal aberrations in mouse somatic and germinal cells at any of the laboratories involved in these studies. Based upon these results, thimerosal was not classified as an aneugen. The literature search did not locate any publications where thimerosal was assessed in any other genetic toxicology test.

9.5 Immunotoxicity

Allergy to thimerosal is well described in the clinical literature, primarily in the form of delayed-type hypersensitivity (Cox 1988). Some authors postulate that the thiosalicylate component is the major determinant of allergic reactions (Goncalo 1996). The clinical importance of the high prevalence of thimerosal sensitivity detected by patch testing remains controversial. Some investigators feel that it is of little significance (Grabenstein 1996; Moller 1994), while others suggest it is important enough to require removal of thimerosal from pharmaceutical products (Cox 1988; Seal 1991; Schafer 1995).

Several literature citations of European studies retrospectively analyzed human patch tests for possible contact-sensitized patients and found a small percentage of cross-reactivity to thimerosal. Percent positive thimerosal response ranged from 1.3% to more than 25% (Pirker 1994; Van 1994; Wantke 1996; Brasch 1997; Steiskal 1997). In one of these studies, half of the subjects exhibiting a positive patch test to thimerosal also had positive patch test responses to ethyl mercuric chloride (Pirker, 1994).

The largest retrospective patch test study involved 2461 patients suspected of having contact allergic response (Van 1994). Only 32 subjects in this group (1.3%) exhibited a positive patch test response to thimerosal. The authors concluded thimerosal hypersensitivity occurred with low frequency, especially for vaccines administered intramuscularly or subcutaneously. Two studies in children with contact dermatitis suggested a higher incidence of hypersensitivity to thimerosal than in the adult population (Wantke 1996; Brasch 1997). As with other reports of retrospective patch tests, there was difficulty distinguishing between an allergic or irritation response. A selective human memory lymphocyte test was conducted on blood from patients with clinically verified or suspected metal intolerance (Stieskal 1997). Thimerosal was included in the test battery of chemicals and approximately 7% of the test group responded to thimerosal with a stimulation index of 5 or greater. The memory lymphocyte immunostimulation assay was well defined in the literature citation, however, there was no definition of how the stimulation index was measured.

10.0 Structure-Activity Relationships

No data were found on structure-activity relationships.

11.0 Selection of the Rhesus Monkey as the Animal Model

The rhesus monkey is the animal model of choice for this Thimerosal study based on biological and methodological criteria. Rhesus monkeys are selected routinely as animal models because of the similarity of their genetic, physiological and biochemical parameters to the human. These biological consistencies are especially strong during development where organogenesis and other maturational stages in comparison to birth are very comparable between monkey and human (Poggel and G_nzel, 1998). The use of the rodent as a human postnatal model is very limited because of its immature status at birth, especially of the central nervous system, whereas the primate species are considerably more mature at parturition.

Methodological reasons for selecting the newborn rhesus over other animal models include the need to mimic the human vaccination schedule during an extended period of time consistent with the relatively long developmental period of the human. Of equal importance is the ability to collect multiple blood samples from individual animals to define internal dose of both organic and inorganic mercury. Because multiple blood draws from rodents are technically difficult and impossible in the immature pup, extra cohorts of animals must be added. This requires additional costs. So cost wise a group of 40 monkeys (purchase price of \$1,500-2,500 each) becomes comparable to the purchase and maintenance of multiple cohorts of rats, and the problem remains that the rodents that generate the blood level data are not the same ones that generate the toxicological endpoint data.

Data has accumulated over the years indicating that the effects of methylmercury observed in humans is similar to that seen in monkeys. In a review article authored by Burbacher, Rodier and Weiss (1990), they summarized some of their findings in these quotes: "In summary, the correspondence between the human and macaque neuropathology data appears to be excellent." "Two effects that have been observed in humans (and nonhuman primates) have not been easily reproduced in animal models using smaller mammals." Disorganized lamination and ectopic white matter were not reported in any of the rodent studies described above." Although such studies have not been conducted with ethylmercury, one can assume that selecting the animal model with the greater similarity to human would be appropriate.

In addition the sophisticated operant behavioral tasks of attention, memory and learning that allow the distinction of Attention Deficit/Hyperactivity Disorder children from normal controls can be applied to the developing infant monkey (Chelonis, et al, 2000; Popke, et al, 2001). Therefore, for both biological and practical reasons the developing infant monkey is the most appropriate model for the developing human infant.

12.0 Online and Secondary References

12.1 Online Databases (National Library of Medicine Databases)

PUBMED
Internet Grateful Med
ChemIDplus
TOXLINE

12.2 Secondary References

U.S. Pharmacopeia 24-NF19 2001 The United States Pharmacopeial Convention, Inc.
Hundley S. Thimerosal Toxicity Review. FDA/Center for Drug Evaluation and Research
internal memo. October 15, 1998.

13.0 References

1. Adler I-D. Synopsis of the *in vivo* results obtained with the 10 known or suspected aneugens tested in the CEC collaborative study. *Mutation Research* 1993;287:131-137.
2. Agency for Toxic Substances and Disease Registry. Toxicological profile for mercury. Atlanta, GA: Agency for Toxic Substances and Disease Registry;1999.
3. Axton JMH. Six cases of poisoning after a parenteral organic mercurial compound (merthiolate). *Postgrad Med J.* 1972;48:417-421.
4. Bakir F, Damlugi SF, Amin-Zaki L, Murtadha M, Khalidi A, Al-Rawi NY, Tikriti S, Dhahir HI, Clarkson TW, Smith JC, Doherty RA. Methylmercury poisoning in Iraq. *Science* 1973;181:230-241.
5. Ball LK, Ball R, Pratt RD. An assessment to thimerosal use in childhood vaccines. *Pediatrics* 2001;107:1147-1154.
6. Blair AMJN, Clark B, Clarke, AJ, Wood P. Tissue Concentrations of Mercury after Chronic Dosing of Squirrel Monkeys with Thimerosal. *Toxicology* 1975;3:171-176.
7. Bernier RH, Frank JA, Nolan TF. Abscesses complicating DTP vaccination. *Am J Dis Child* 1981;135:826-828.
8. Brasch J, Geier J, Patch test results in schoolchildren. *Contact Dermatitis* 1997; 37:286-293.
9. Burbacher TM, Rodier PM, Weiss B. Methylmercury Developmental Neurotoxicity: A Comparison of Effects in Humans and Animals. *Neurotoxicology and Teratology* 1990; 12:191-202.
10. Centers for Disease Control and Prevention. Recommended Childhood Immunization Schedule – United States. *MMWR* 2001;50.
11. Centers for Disease Control and Prevention. Notice to Readers: Thimerosal in Vaccines: A Joint Statement of the American Academy of Pediatrics and the Public Health Service. *MMWR* 1999;48:563-565
12. Chelonis, J.J., Edwards, M.C., Schulz, E.G., Baldwin, R., Wenger, A. and Paule, M.G., Methylphenidate Normalizes Recognition Memory in Children Diagnosed With Attention Deficit/Hyperactivity Disorder, *Journal of Experimental and Clinical Psychopharmacology*. Accepted: 7/6/2000.
13. Cox NH, Forsyth A. Thimerosal allergy and vaccination reactions. *Contact Dermatitis* 1988;18:229-233.
14. Davidson PW, Myers GJ, Cox C, Axtell C, Shamlaye C, Sloan-Reeves J, Cernichiari E,

- Needham L, Choi A, Wang Y, Berlin M, Clarkson TW. Effects of prenatal and postnatal methylmercury exposure from fish consumption on neurodevelopment: Outcomes at 66 months of age in the Seychelles child development study. *JAMA* 1998;280:701-707.
15. Fagan DG, Pritchard JS, Clarkson TW, Greenwood MR. Organ mercury levels in infants with omphaloceles treated with organic mercurial antiseptic. *Arch Dis Child* 1977;52:962-964.
 16. Federal Register 64:63323-63324, November 19, 1999.
 17. Federal Register 443990, January 19, 1979.
 18. Gasset AR, Itoi M, Ishii Y, Ramer RM. Teratogenicities of ophthalmic drugs. II. Teratogenicities and tissue accumulation of thimerosal. *Arch Ophthalmol* 1975;93:52-55.
 19. Grabenstein JD. Immunologic necessities: diluents, adjuvants, and excipients. *Hosp Pharm* 1996; 31:1387-1401.
 20. Grandjean P, Weihe P, White RF et al. Cognitive deficit in 7 year old children with prenatal exposure to methylmercury. *Neurotoxicol Teratol* 1997;6:417-428. Goncalo M, Figueiredo A,
 21. Goncalo S. Hypersensitivity to thimerosal: the sensitivity moiety. *Contact Dermatitis* 1996;34:201-203.
 22. Harada M. Minamata disease: Methylmercury poisoning in Japan caused by environmental pollution. *Crit Rev Toxicol* 1995;25:1-24.
 23. Leopardi P, Zijno A, Bassani B, Pacchierotti F. *In vivo* studies on chemically induced aneuploidy in mouse somatic and germinal cells. *Mutation Research* 1993;287:119-130.
 24. Lowell HJ, Burgess S, Shenoy S, Peters M, Howard TK. Mercury poisoning associated with hepatitis B immunoglobulin. *Lancet* 1996;347:480.
 25. Magos L, Brown AW, Sparrow S, Bailey E, Snowden RT, Skipp WR. The comparative toxicology of ethyl- and methylmercury. *Arch Toxicol* 1985;57:260-267.
 26. Mahaffey KR, Rice G, et al. An assessment of exposure to mercury in the United States: Mercury study report to Congress. Washington, DC: US Environmental Protection Agency; 1997. Document EPA-452/R-97-006.
 27. Marrazzini A, Betti C, Bernacchi F, Barrai J, Barale R. Micronucleus test and metaphase analyses in mice exposed to known and suspect spindle poisons. *Mutagenesis* 1994;90:505-515.
 28. Mason MM, Cate CC, Baker J. Toxicology and carcinogenesis of various chemicals used in the preparation of vaccines. *Clin Toxicol* 1971;4:185-204.

29. Matheson DS, Clarkson TW, Gelfand EW. Mercury toxicity (acrodynia) induced by long-term injection of gammaglobulin. *J Pediatr* 1980;97:153-155.
30. May JC, Sih JTC, Mustafa, AJ. Assay for mercurial preservatives in biological products by cold-vapor atomic absorption spectrophotometry. *J Biologic Stand.* 1978;6:339-350.
31. Miller B, Adler I-D. Aneuploidy induction in mouse spermatocytes. *Mutagenesis* 1992;7:69-72 .
32. Moller H. All these positive tests to thimerosal. *Contact Dermatitis* 1994; 31:209-213.
33. Pfab R, Muckter H, Roeder G, Zilker T. Clinical Course of Severe Poisoning with Thiomersal. *Clin Toxicol* 1996;34:453-460.
34. Pirker, C, Möslinger T, Wantke F, Götz M, and Jarisch R. Ethylmercuric chloride: The responsible agent in thimerosal hypersensitivity. *Contact Dermatitis* 1994;31:293-298.
35. Poggel, H.A. and P. G_ nzel, Necessity of Using Nonhuman Primates in Assessing Prenatal Toxicity. View of a Scientist from the Industry. In: *Non-Human Primates – Developmental Biology and Toxicology*. Editors: Diether Neubert, Hans-Joachim Merker, Andrew G. Hendrickx, Ueberreuter Wissenschaft, Wien, Berlin, pp585-597, 1988.
36. Popke, J., Allen, R.R., Pearson, E., Hammond, T., Paule, M. G., Differential Effects of Two NMDA Receptor Antagonists on Cognitive-behavioral Development in Nonhuman Primates II, *Neurotoxicology and Teratology*. Accepted: 03/05/2001.
37. Powell HM, Jamieson WA. Merthiolate as a Germicide. *Am J Hyg.* 1931;13:296-310.
38. Rohyans J, Walson PD, Wood GA, MacDonald WA. Mercury toxicity following merthiolate ear irrigations. *J Pediatr* 1994;104:311-313.
39. Schafer T, Enders F, Przybilla B. Sensitization to thimerosal and previous vaccination. *Contact Dermatitis* 1995; 32:114-116.
40. Seal D, Ficker L, Wright P, Andrews V. The case against thiomersal. *Lancet* 1991;338:315-316.
41. Stajich G, Lopez, G, Harry S, Saxson W. Iatrogenic exposure to mercury following hepatitis B vaccination in preterm infants. *J Pediatr* 2000.136:679-681.
42. Stejskal V. Human hapten-specific lymphocytes: Biomarkers of allergy in man. *Drug Information Journal* 1997; 31:1379-1382.
43. Van T Veen, A., and Van Joost, T. A sensitization to Thimerosal (Merthiolate) is still present today. *Contact Dermatitis* 1994;31:293-298.

44. Verstraeten T. Assessment of neurologic and renal impairment associated with thimerosal-containing vaccines. Presentation at the Advisory Committee on Immunization Practices, Centers for Disease Control and Prevention. June 21, 2000; Atlanta, GA.
45. Wantke F, Hemmer W, Jarisch R, and Götz M. Patch test reactions in children, adults, and the elderly. *Contact Dermatitis* 1996;34:316-319.
46. World Health Organization. Trace elements and human nutrition and health. Geneva: World Health Organization;1996:209.
47. Zeiger E, Anderson B, Haworth S, Lawlor T, Mortelmans K, Speck W. Salmonella and mutagenicity tests: III. Results from the testing of 255 chemicals. *Environ Mol Mutagen* 1987;9(Suppl. 9):1-110.

Preliminary Proposal for Thimerosal Assessment

Phase 1 studies:

Establish dose ranges, vehicles and sampling times using adult monkeys currently in the NCTR colony

Phase 2 studies:

Species: Newborn/infant rhesus monkeys

Exposure: match human infant vaccination schedule

Dose groups: (N=10)

- Vehicle control

- Positive control (methylmercury)

- Thimerosal (two dose groups): human exposure levels and 5 or 10x

Assessments: (2-3 sacrifice times between 15-24 months)

- Growth and development

- Blood and hair samples throughout exposure and follow-up

- Operant behavior (acquisition: 6-12 months; behavioral reversals: 12-24 months)

- Morphometry, neurohistology and imaging

- Concentrations of organic and inorganic mercury in tissues

- Neurochemical/neurobiological assessments (e.g., NCAM, oxidative stress and genomics/proteomics)

William Allaben, Ph.D.
Associate Director for Research Coordination
NCTR/FDA

Bill:

We appreciate your assistance in formulating a request to the National Toxicology Program (NTP) to conduct toxicology studies on Thimerosal. As you know, Thimerosal is a mercury-containing preservative used commonly in vaccines. Under the Food and Drug Modernization Act (FDAMA) of 1997, FDA was mandated to compile a list of drugs and foods that contain intentionally introduced mercury compounds, and provide a quantitative and qualitative analysis of the mercury compounds in the list within 2 years after the date of enactment. The Act also called for FDA to conduct, or contract with the Institute of Medicine of the National Academy of Sciences to conduct, studies of the effects on humans, particularly the adverse effects on health of children and other sensitive populations, resulting from exposure to mercury. Where necessary or appropriate, FDA may contract with any other Federal or private entity to conduct such studies.

As members of the FDA working group preparing the response to Congress (due Nov. 1999), we have compiled a list of vaccines containing Thimerosal and the mercury content of each (see attachment). We have noted that the potential cumulative exposure to Thimerosal in vaccines over the first six months of life has increased in recent years with the expanding list of recommended childhood immunizations. We are also aware that some Thimerosal-containing vaccines are currently recommended or proposed for use during pregnancy.

In assessing the potential risk to small children from the cumulative exposure to mercury from vaccines, we calculated the amount of mercury a child might receive from vaccines available in the U.S. by following CDC's recommendations for childhood immunizations. An infant could receive from 0 μg to 187.5 μg of mercury by 6 months of age, depending on the choice of vaccines. Based on the lower 5th percentile body weight for children this age, we estimated that an infant could receive in excess of allowable limits of mercury as determined by WHO, EPA, and ATSDR for exposures to methyl mercury (standards for methyl mercury consumption set by FDA are not exceeded by the content of ethyl mercury from Thimerosal in vaccines alone).

Please note that we have assumed that the toxicity of Thimerosal is similar to that of methyl mercury, when adjusted for mercury content by weight. According to our reading of the literature, Thimerosal is typically metabolized into ethyl mercury and thiosalicylate. While much is known about the toxicity of methyl mercury when ingested,

little is known about the related organic mercurial compound, ethyl mercury, when either ingested or injected.

We have been unable to find sufficient information in the available literature to adequately assess the potential for neurodevelopmental, immunologic, and reproductive toxicity of Thimerosal. Data are also lacking regarding the biotransformation and pharmacokinetics of Thimerosal and its derivatives following intramuscular injection in humans and animal models. However, some data are available from reproductive toxicity testing of a few Thimerosal-containing vaccines that have been submitted to FDA. In order to provide a more complete assessment of the toxicity of Thimerosal during the critical period of neurodevelopment, we are proposing that well designed studies be conducted in an appropriate animal model(s). Among the specific questions and issues we would like to see addressed are the following:

- 1) How is Thimerosal metabolized and excreted in fetal and neonatal models following intramuscular or subcutaneous administration? What are the half-life, volume of distribution, peak concentration, and clearance of Thimerosal, ethyl mercury, and total mercury following intramuscular or subcutaneous administration of Thimerosal? Do the pharmacokinetics suggest a 2 compartment distribution and elimination? It has been suggested to us that radioactive labeling (carbon proximate to Hg) may be useful in following the distribution of ethyl mercury from Thimerosal. Studies in both rodents and a limited number of non-human primates may be informative in this regard.
- 2) How does the toxicity of ethyl mercury compare to the toxicity of methyl mercury for neonatal and fetal tissues, particularly neural tissues, at specific doses or blood levels?
- 3) Can mercury be detected in the central nervous systems of animals during the neonatal period and early infancy following episodic intramuscular or subcutaneous administration of Thimerosal? If so, in what form and at what levels?
- 4) Does administration of Thimerosal result in gross or microscopic pathology of central nervous system tissue, especially when given on an episodic basis?
- 5) Is neurodevelopment adversely affected by administration of Thimerosal in fetal and neonatal models, especially when given on an episodic basis?
- 6) Does fetal exposure to Thimerosal result in neurodevelopmental toxicity? If so, what is the critical period of exposure during gestation?
- 7) Could a physiologically based pharmacokinetic model be constructed such that observed levels of mercury in animals may be used to predict levels in human neonates and or conceptus? Dr. John Young and co-workers at the NCTR have developed a pharmacokinetic model for methylmercury and this model could serve as a starting point for a cross-species extrapolation tool for ethylmercury.
- 8) Many childhood vaccines are formulated with aluminum-containing adjuvants (AlPO₄ or Al(OH)₃),, that are used to increase immune responses to vaccine

- antigens. Is there a physical or biological interaction of the mercury from Thimerosal and aluminum? To best approximate toxicological effects of Thimerosal as used in vaccines, it may be important to conduct studies both in the presence and absence of alum. It may also be important to evaluate what happens when Thimerosal is administered with a vaccine product, such as Hepatitis B vaccine. These kinds of studies may help determine whether mercury from Thimerosal is bound in a “depot” which may slow absorption and lower peak blood levels.
- 9) Does breast milk contain mercury following parenteral administration of Thimerosal to lactating animals? If so, in what form and at what levels?
 - 10) Does neonatal or fetal exposure to Thimerosal result in immunologic toxicity?

Toxicological studies may be most meaningful with episodic dosing, e.g., weeks apart. Infant vaccines are typically administered at 2, 4, and 6 months of age. Another situation of interest is the administration of Hepatitis B vaccine, which may be given on the first day of life. Episodic dosing in reproductive toxicology testing will, by necessity, need to be somewhat more compressed. Likewise, episodic dosing will likely need to be at less than 8 weeks intervals to complete these studies in a timely manner, as is done currently for toxicology studies.

Selection of an appropriate animal model is not obvious; use of more than one species for testing could be informative. Studies using a limited number of non-human primates may serve to validate the usefulness of pharmacokinetic data obtained from rodent models.

While some progress has been made during the past year in removing Thimerosal from childhood vaccines, complete removal of Thimerosal from all vaccines in the near future is unlikely. Certain vaccines and other products containing Thimerosal such as ophthalmic drops, nasal sprays and Rho(D) immune globulins continue to be administered to infants and pregnant women. In addition, it is important to determine whether any harmful effects may have occurred from previous exposure to Thimerosal-containing products.

We anticipate that information derived from toxicological studies of Thimerosal would be of interest to groups involved in making immunization recommendations, in addition to government regulatory bodies.

Attached to this letter is a list of vaccines containing Thimerosal.

We appreciate your assistance in formulating this request to NTP. Feel free to contact Bill Slikker if you need any additional information.

R. Douglas Pratt, M.D., M.P.H.
Medical Officer, Division of Vaccines and Related Products Applications

Office of Vaccines Research and Review
Center for Biologics Evaluation and Research
Food and Drug Administration

Leslie Ball, M.D.
Medical Officer, Division of Vaccines and Related Products Applications
Office of Vaccines Research and Review
Center for Biologics Evaluation and Research
Food and Drug Administration

Robert Ball, M.D., M.P.H.
Division of Biostatistics and Epidemiology
Center for Biologics Evaluation and Research
Food and Drug Administration

William Slikker, Jr., Ph.D.
Division of neurotoxicology
National Center for Toxicological Research
Food and Drug Administration



U.S. Licensed Vaccines and Biologics Containing Thimerosal

October 4, 1999

Sources: 1) DVRPA files: Label 2) 1999 PDR 3) ImmunoFacts 1998 4) Office of Blood Research and Review 7/99 5) Federal Register call-for-data 12/14/98 and 4/29/99

Vaccines and Allergenic:

Vaccine	Trade Name	Manufacturer ¹	Thimerosal conc.	Thimerosal (µg)/ Dose Adult/Child	Hg (µg)/ Dose Adult/Child	Multidose/ Single ²	Call-for-data reply
Allergen Extracts ³	Various	Various	0.01%			NA	None
Allergen Patch Test	T.R.U.E. Test	Pharmacia Research Center	0.0065mg/patch	0.0065mg/patch		NA	None
Coccioidin	Spherulin	ALK Labs	0.01%				None
DTaP Adsorbed	Certiva	N.American Vaccine	0.01%	50µg/0.5ml	25µg	+/-	None
DTaP Adsorbed	ACEL-IMUNE	Lederle	0.01%	50µg/0.5ml	25µg	+/-	3/14/99
DTaP Adsorbed	Tripedia	CLI	0.01%	50µg/0.5ml	25µg	++	5/25/99
DTP Adsorbed ⁴	Tri-Immunol	Lederle	0.01%	50µg/0.5ml	25µg	+/-	NR ⁵
DTP Adsorbed	-	CLI	0.01%	50µg/0.5ml	25µg	+/-	5/25/99
DTP Adsorbed	-	Wyeth	0.01%	50µg/0.5ml	25µg	++	3/11/99
DTP Adsorbed	-	BioPort	0.01%	50µg/0.5ml	25µg	+/-	None
DTP Adsorbed ⁴	-	MPHL	0.01%	50µg/0.5ml	25µg	+/-	NR
DT Adsorbed	-	CLI	0.01%	50µg/0.5ml	25µg	+/-	5/25/99
DT Adsorbed	-	MPHL	0.01%	50µg/0.5ml	25µg	+/-	3/4/99
DT Adsorbed	-	BioPort	0.01%	50µg/0.5ml	25µg	+/-	None
DT Adsorbed	-	Wyeth	0.01%	50µg/0.5ml	25µg	++	3/14/99
D ⁴	-	CLI	0.01%	50µg/0.5ml	25µg	+/-	NR

Vaccine	Trade Name	Manufacturer	Thimerosal conc.	Thimerosal (µg)/Dose Adult/Child	Hg (µg)/ Dose Adult/Child	Multidose /Single	Call-for-data reply
D Adsorbed ⁴	-	BioPort	0.01%	50µg/0.5ml	25µg	+/-	None
Td Adsorbed	-	Lederle	0.01%	50µg/0.5ml	25µg	+/+	3/14/99
Td Adsorbed	-	CLI	0.01%	50µg/0.5ml	25µg	+/+	5/25/99
Td Adsorbed	-	MPHL	0.003%	16.5µg/0.5ml	8.25µg	+/-	3/4/99
Td Adsorbed	-	Wyeth	0.01%	50µg/0.5ml	25µg	+/+	3/11/99
TT Fluid	-	CLI	0.01%	50µg/0.5ml	25µg	+/-	5/25/99
TT Fluid	-	Wyeth	0.01%	50µg/0.5ml	25µg	+/+	3/11/99
TT Adsorbed	-	CLI	0.01%	50µg/0.5ml	25µg	+/-	5/25/99
TT Adsorbed	-	Lederle	0.01%	50µg/0.5ml	25µg	+/+	3/14/99
TT Adsorbed	-	BioPort	0.01%	50µg/0.5ml	25µg	+/-	None
TT Adsorbed	-	MPHL	0.01%	50µg/0.5ml	25µg	+/-	NR
TT Adsorbed	-	SSVI - Berne	0.01%	50µg/0.5ml	25µg	+/+	5/6/99
TT Adsorbed	-	Wyeth	0.01%	50µg/0.5ml	25µg	+/+	3/11/99
P Adsorbed ⁴	-	BioPort	0.01%	50µg/0.5ml	25µg	+/-	None
DTP-HIB	TETRAMUNE	Lederle	0.01%	50µg/0.5ml	25µg	+/-	3/14/99
DTP-HIB	ActHIB +DTP	PM	0.01%	50µg/0.5ml	25µg	+/-	None for comb product
HIB ⁶	HIBtiter (multidose only)	Lederle	0.01%	50µg/0.5ml	25µg	+/+	3/14/99
HIB ⁷	PedvaxHIB (lyoph. only)	Merck	0.005%	25µg/0.5ml	12.5µg	-/+	NR
HIB	ProHIBit	CLI	0.01%	50µg/0.5ml	25µg	+/+	5/25/99
Hepatitis B	Engerix B	SKB	0.005%	50µg/1.0ml 25µg/0.5ml	25µg 12.5µg	+(adult only)/+	2/26/99

Hepatitis B	Recombivax B	Merck	0.005%	50µg/1.0ml 25µg/0.5ml	25µg 12.5µg	+/+	5/25/99
--------------------	---------------------	--------------	---------------	----------------------------------	--------------------	------------	----------------

Vaccine	Trade Name	Manufacturer	Thimerosal conc.	Thimerosal (µg) /Dose Adult/Child	Hg (µg)/ Dose Adult/Child	Multidose /Single	Call-for-data reply
Influenza	Fluvirin	Medeva	0.01%	50µg/0.5ml 25µg/0.25ml	25µg 12.5µg	+/+	5/28/99
Influenza (Whole virion)	Fluzone	CLI	0.01%	50µg/0.5ml	25µg	+/-	5/25/99
Influenza (Subvirion)	Fluzone	CLI	0.01%	50µg/0.5ml 25µg /0.25ml	25µg 12.5µg	+/+	5/25/99
Influenza	FluShield	Wyeth	0.01%	50µg/0.5ml 25µg /0.25ml	25µg 12.5µg	+/+	3/11/99
Influenza	Fluogen	Parkdale	0.01%	50µg/0.5ml 25µg /0.25ml	25µg 12.5µg	+/-	3/12/99
Japanese Encephalitis	JE-VAX	CLI (BIKEN)	0.007%	70µg/1.0ml 35µg/0.5ml	35µg 17.5µg	+/+	5/25/99
Meningococcal A ⁴	Menomune-A	CLI	0.01%	50µg/0.5ml	25µg	+/-	NR
Meningococcal C ⁴	Menomune-C	CLI	0.01%	50µg/0.5ml	25µg	+/-	NR
Meningococcal A/C ⁴	Menomune-A/C	CLI	0.01%	50µg/0.5ml	25µg	+/-	NR
Mening A/C/Y/W-135 ⁸	Menomune-A/C/Y/W-135	CLI	0.01%	50µg/0.5ml	25µg	+/+	5/25/99
Mumps Skin Test Antigen	MSTA	CLI	0.01%	0.1 ml	5µg	+/-	5/25/99
Pneumococcal	Pnu-Imune 23	Lederle	0.01%	50µg/0.5ml	25µg	+/+	3/14/99
Rabies ⁴	RABIE-VAX	CLL	0.01%	50µg/0.5ml	25µg		None
Rabies Adsorbed	-	BioPort	0.01%	100µg/1.0ml	50µg	+/-	none

Other Biologics:

Product	Trade Name	Manufacturer	Thimerosal conc.	Call-for-data reply
Antivenin Crotalidae (Equine)		Wyeth	0.005%	3/11/99
Antivenin micrurus fulvius (Equine)		Wyeth	0.005%	3/11/99
Antivenin Latrodectus mactans (Equine)		Merck	0.01%	5/25/99
Normal Horse Serum		Wyeth	0.005%	3/11/99
Immune Globulin (Human)		BioPort	0.01%	7/8/99 (OBRR)
Immune Globulin (Human)⁹		Centeon	0.01%	7/7/99 (OBRR)
Immune Globulin (Human)⁹		Immuno-US	0.01%	OBRR
Hepatitis B Immune Globulin (Human)⁹		Abbott	0.01%	OBRR
Rho (D) Immune Globulin	MICRhoGAM RhoGAM	Ortho-Clinical Diagnostics	0.003%	5/25/99
Vaccinia Immune Globulin¹⁰	-	Baxter	0.01%	7/9/99 (OBRR)

¹ Manufacturer abbreviations: CLI (Connaught Laboratories, Incorporated – Pasteur Merieux Connaught USA), CLL (Connaught Laboratories, Limited), MBPI (Michigan Biologic Products Institute), MPHIL (Massachusetts Public Health Biologic Laboratories), PM (Pasteur Merieux Serums et Vaccins, SA), SKB (SmithKline Beecham Biologicals), SSVI (Swiss Serum and Vaccine Institute, Berne).

Note: BioPort purchased Michigan Biologic Products Institute in 1998.

² Indicates whether product is formulated in multidose vials and/or single dose vials. Note: Products containing thimerosal in multidose vials generally contain thimerosal in single dose formulations; however, HIBtiter in single dose vials does not contain thimerosal.

³ Allergen extracts usually contain 0.4% or 0.5% phenol. Thimerosal may be used if allergen darkens in the presence of phenol (e.g. extracts of privet pollen, mushroom, grain mill dust, white potato, avocado; food extracts of corn, barley, oat, rye and wheat.) Reference: ImmunoFacts, 1999

⁴ Not currently distributed in U.S.

⁵ Although manufacturer responded to call-to-data, this product was not listed in their reply.

⁶ HIBtiter in single dose vials does not contain thimerosal.

⁷ Lyophilized PedvaxHIB is no longer distributed in U.S. (personal communication Dr. Carlo Russo, Merck 6/25/99).

⁸ Diluent contains thimerosal, unreconstituted lyophilized product does not.

⁹ No longer in active production or distribution (Dr. Thomas Lynch, Office of Blood Research and Review, 7/21/99).

¹⁰ Produced for Department of Defense. Only one lot exists at one time, with a new lot made when the previous one becomes outdated.

Thimerosal: Assessment Approach and Methods

William Slikker

Division of Neurotoxicology

NCTR/FDA



F
D
A

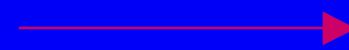

NCTR

Thimerosal in Childhood Vaccines~ Weighing the Benefits and Risks

*Leslie K. Ball, MD
Robert Ball, M.D., M.P.H.
Douglas Pratt, M.D., M.P.H.
William Egan, Ph.D.*

*Office of Vaccines Research and Review
Center for Biologics Evaluation and Research
U.S. Food and Drug Administration*

March 21, 2001



Thimerosal in Vaccines: Stakeholder Perspectives

- λ Parent There's mercury in vaccines??
- λ Safety Advocate Take mercury out!
- λ Provider Assure us that vaccines are safe.
- λ Vaccinologist Show me the science.
- λ Industry Hg preservatives used in
 vaccines >60 yrs: it must be safe.
- λ Public Health Vaccines are good, disease is
 bad; benefits outweigh risks.
- λ Regulator Licensed vaccines are
 safe and effective.
- λ Toxicologist We can study this further.

F
D
A

→ NCTR

Origins of Issue

- λ General concern over health effects of human exposure to mercury
 - EPA: Mercury Study Report to Congress 12/97
 - ATSDR: Toxicological Profile for Mercury 3/99
 - **FDA: FDAMA 1997**
- λ Increase in number of vaccines recommended for routine use in infants
 - Potential increased exposure of infants to mercury in the form of ethylmercury



F
D
A

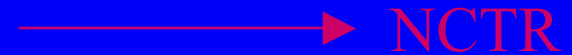

NCTR

Thimerosal has been used as a preservative in biologics and vaccines since the 1930s. The Food and Drug Administration, Public Health Service and the American Academy of Pediatrics recently recommended that Thimerosal should be removed from vaccines



F
D
A



NCTR

Thimerosal is frequently used in life saving vaccinations including diphtheria-tetanus-pertussis (DTP) and influenza. Thimerosal (sodium ethylmercurithiosalicylate) contains 49.6% mercury by weight and is metabolized to ethyl mercury and thiosalicylate.

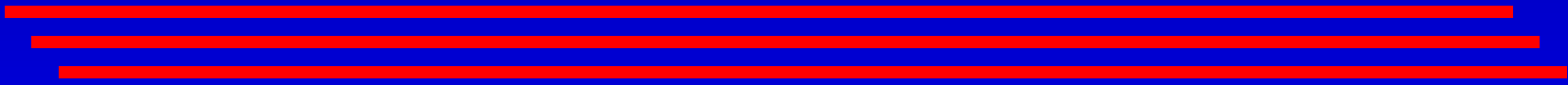

F
D
A

Thimerosal

Ethylmercurithiosalicylic acid sodium salt

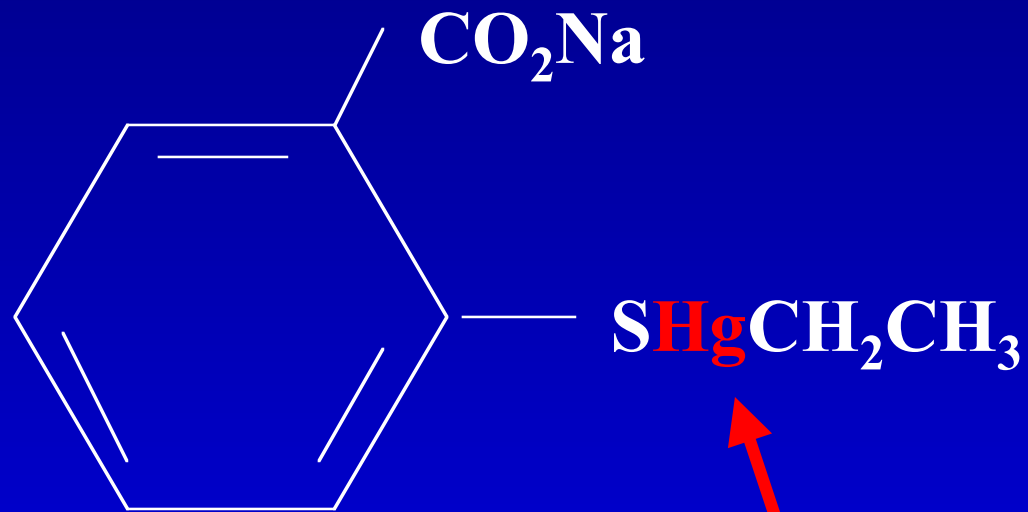

F
D
A

NCTR

Recommended Childhood Immunization Schedule United States, January - December 1999

Vaccines¹ are listed under routinely recommended ages. **Bars** indicate range of recommended ages for immunization. Any dose not given at the recommended age should be given as a "catch-up" immunization at any subsequent visit when indicated and feasible. **Ovals** indicate vaccines to be given if previously recommended doses were missed or given earlier than the recommended minimum age.

Age ► Vaccine ▼	Birth	1 mo	2 mos	4 mos	6 mos	12 mos	15 mos	18 mos	4-6 yrs	11-12 yrs	14-16 yrs
Hepatitis B ²	Hep B		Hep B			Hep B				Hep B	
Diphtheria, Tetanus, Pertussis ³			DTaP	DTaP	DTaP		DTaP	DTaP		Td	
<i>H. influenzae</i> type b ⁴			Hib	Hib	Hib	Hib					
Polio ⁵		IPV	IPV	Polio ⁵					Polio		
Rotavirus ⁶		Rv ⁶	Rv ⁶	Rv ⁶							
Measles, Mumps, Rubella ⁷						MMR			MMR ⁷	MMR ⁷	
Varicella ⁸						Var				Var ⁸	

Approved by the Advisory Committee on Immunization Practices (ACIP), the American Academy of Pediatrics (AAP), and the American Academy of Family Physicians (AAFP).

Acute Human Toxicity of Ethyl Mercury

- Symptoms: Spasticity, cerebellar ataxia, deafness, blindness, exaggerated reflexes and mental confusion.

- Mercury levels: Cerebellum (2-5 $\mu\text{g/g}$)

Kidney (8-9 $\mu\text{g/g}$)

Hilmy et al, 1976

F
D
A

→ NCTR

Acute Rodent Toxicity of Methyl vs Ethyl Mercury

- Similar effects on dorsal root ganglia
- Weight loss and renal damage greater for ethyl mercury
- Higher brain levels of ethyl than methyl mercury
- Granule cell layer damage in cerebellum greater for methyl than ethyl mercury

Magas et al., 1985

→ NCTR

F
D
A

Thimerosal: Acute Toxicity

Reference	Description	Dose Hg	Toxicity	Outcome
Kinsella 1941	Treatment of endocarditis	Max 0.15g/100lb	“Mercury poisoning”	Death
Axton 1972	Antibiotic with thimerosal at 1000x dose	0.15-5.5g 45-165 mg/kg	Local necrosis, ARF, DIC	5/6 died
Fagan 1977	Topical tx omphaloceles (neonates)	Multiple applications	3/3 with fresh tissue had toxic levels	10/13 died ?etiology
Matheson 1980	Replacement IG	50 mg/yr (1 pt)	Acrodynia BL 18 mcg/L	?
		? (5 pts)	No symptoms BL 4-19 mcg/L	?
Rohyans 1984	Irrigation of tymp. tube in 18 mo	1.2 g/ 4 weeks	Renal/hep/card. failure,coma	Death
Lowell 1996	HBIG after liver trans	7.5 mg/3d, 10.5 mg/9d	Paranoia, dysarthria BL 104mcg/L	Recovery
Pfab 1996	Suicide attempt	83 mg/kg	Gastritis, coma, resp. failure, ARF	Survived, recovery
Zhang 1984	Rice contam. with ethylHg	32-224 mg 0.5-4.0 mg/kg	Gastritis, ataxia, parath, coma	1/41 died, 19/41 recov

Comparison with Methylmercury

λ Human data

- Infants born to women who ingested high concentrations of methylmercury exhibited CNS effects
 - » Minamata Bay, Japan
 - » Iraq
- Population-based studies
 - » Seychelle Islands
 - » Faroe Islands
 - » Others

λ Animal data



F
D
A

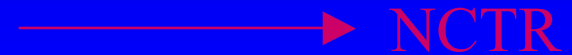

NCTR

Maximum Exposure to Thimerosal From Vaccines in U.S. Infants (1999)

- λ Infants \leq 6 months
 - DTaP x 3 (75)
 - Hib x 3 (75)
 - Hepatitis B x 3 (37.5)
 - [Selected populations:
Influenza x 1(12.5)]

λ Total: 187.5 μ g [200]*

**49.5% Hg by weight; if 0.005%; 50 mg thimerosal/1.0 ml,
25 mg thimerosal/0.5 ml, 12.5 mg Hg/0.5 ml dose*



F
D
A

Thimerosal: Continued Relevance

λ Vaccines

- Infants and children

 - » All DT, Td, Influenza (≥ 6 mo)

- Pregnant women

 - » Influenza vaccine

- Adults

 - » Influenza, hep B, Td, TT, meningococcal, JE, 1/2 pneumococcal PS

λ Skin test Ag's

λ Blood products: Ig's, antivenins, 1/3 Rh₀(D) Ig

λ Drug products: ophthalmic, otic, nasal, topical



F
D
A

Gaps in Knowledge

- λ Toxicokinetics
- λ Ethyl vs. Methylmercury
- λ Developmental neurotoxicity
- λ Neurodevelopmental outcomes in children exposed to thimerosal in vaccines

F
D
A

→ NCTR

Basic PBPK Model

- λ Independent of species
 - i.e., all have liver, brain, kidneys, etc
- λ For a given species
 - Flows
 - Organ/tissue volumes
- λ Independent of xenobiotic
- λ For a given xenobiotic
 - Partition Coefficient
 - Diffusion Coefficient

PBPK Model

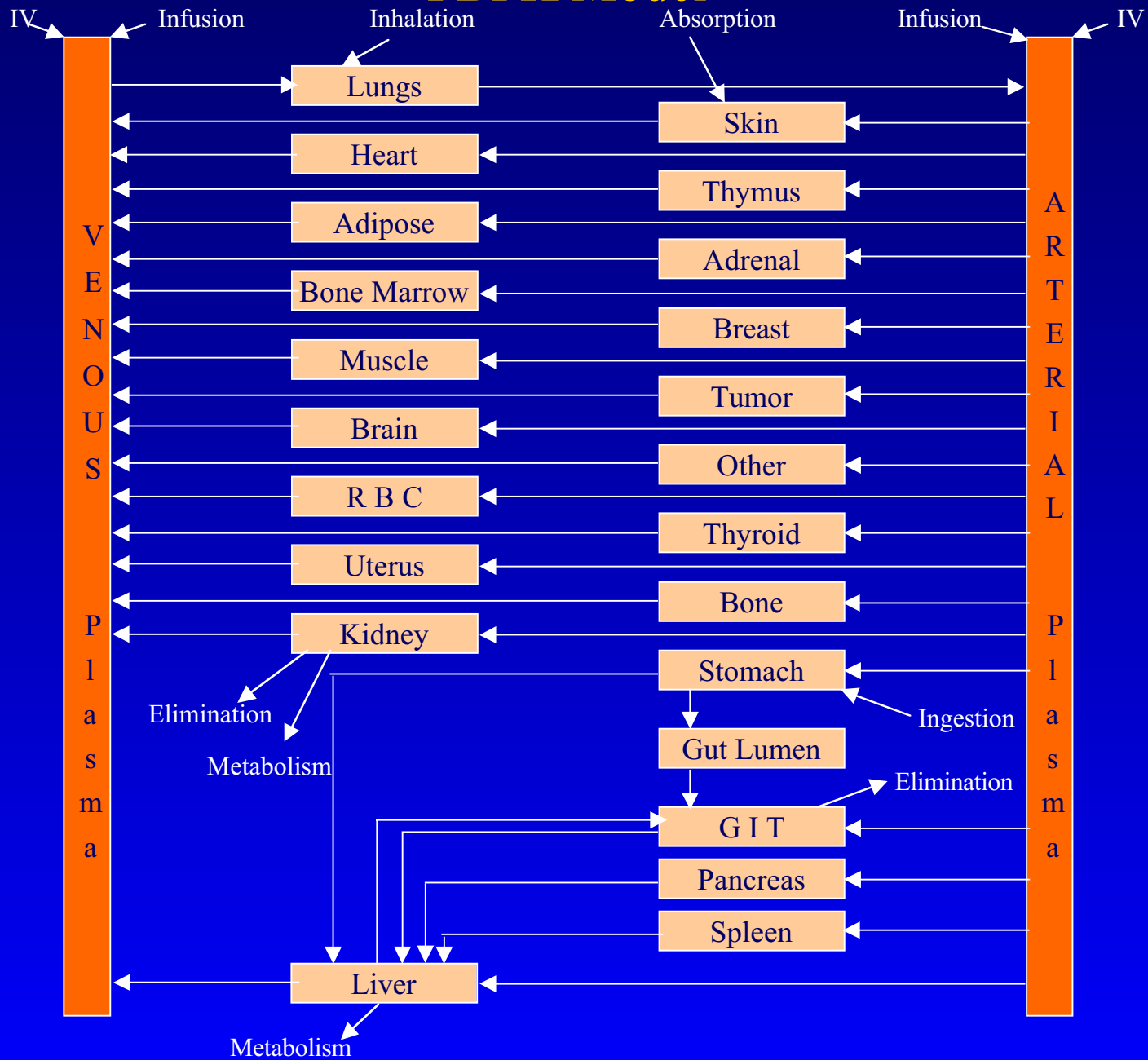

Two PBPK Models in One

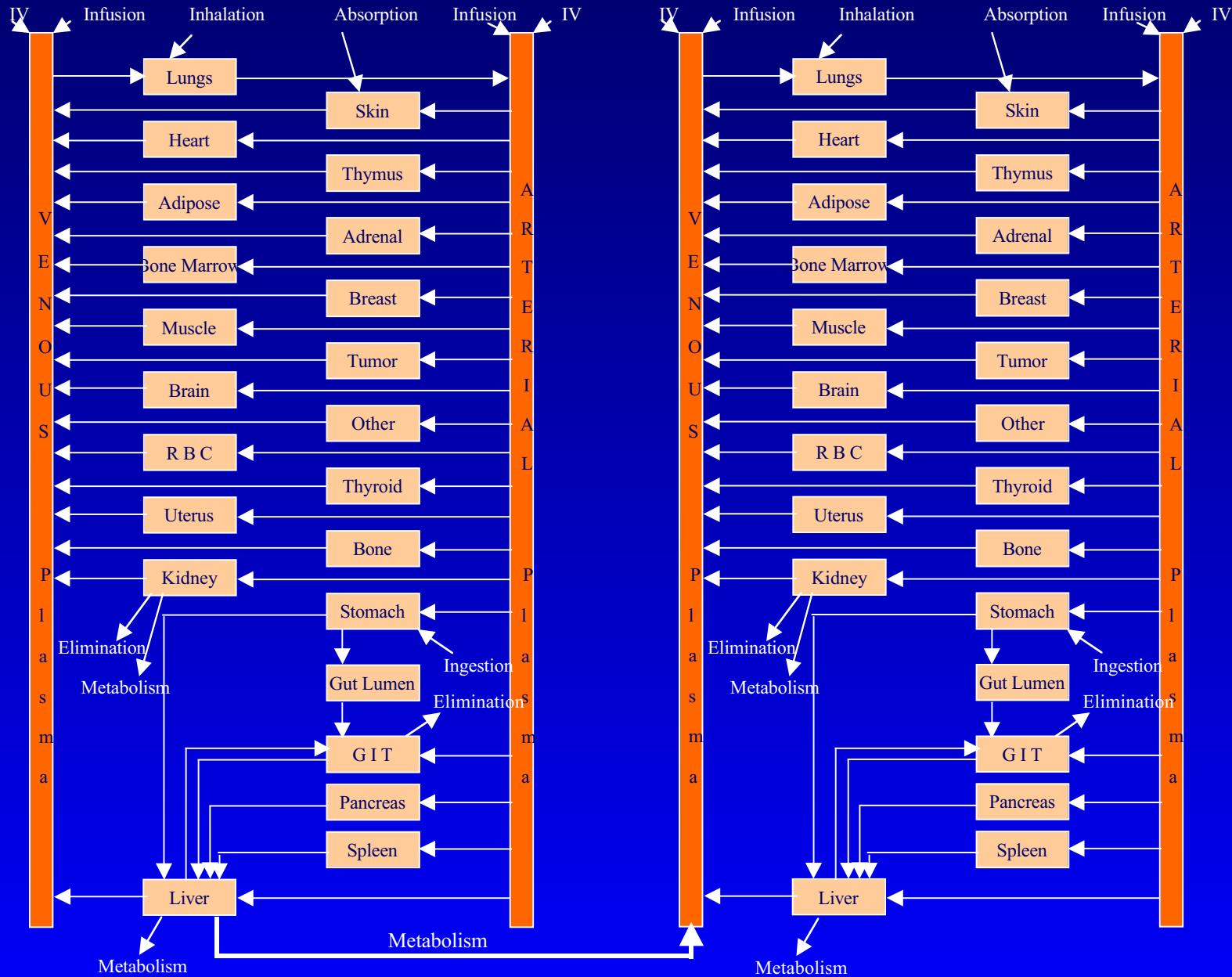

Methyl Mercury, Rat (Farris et al., 1993)

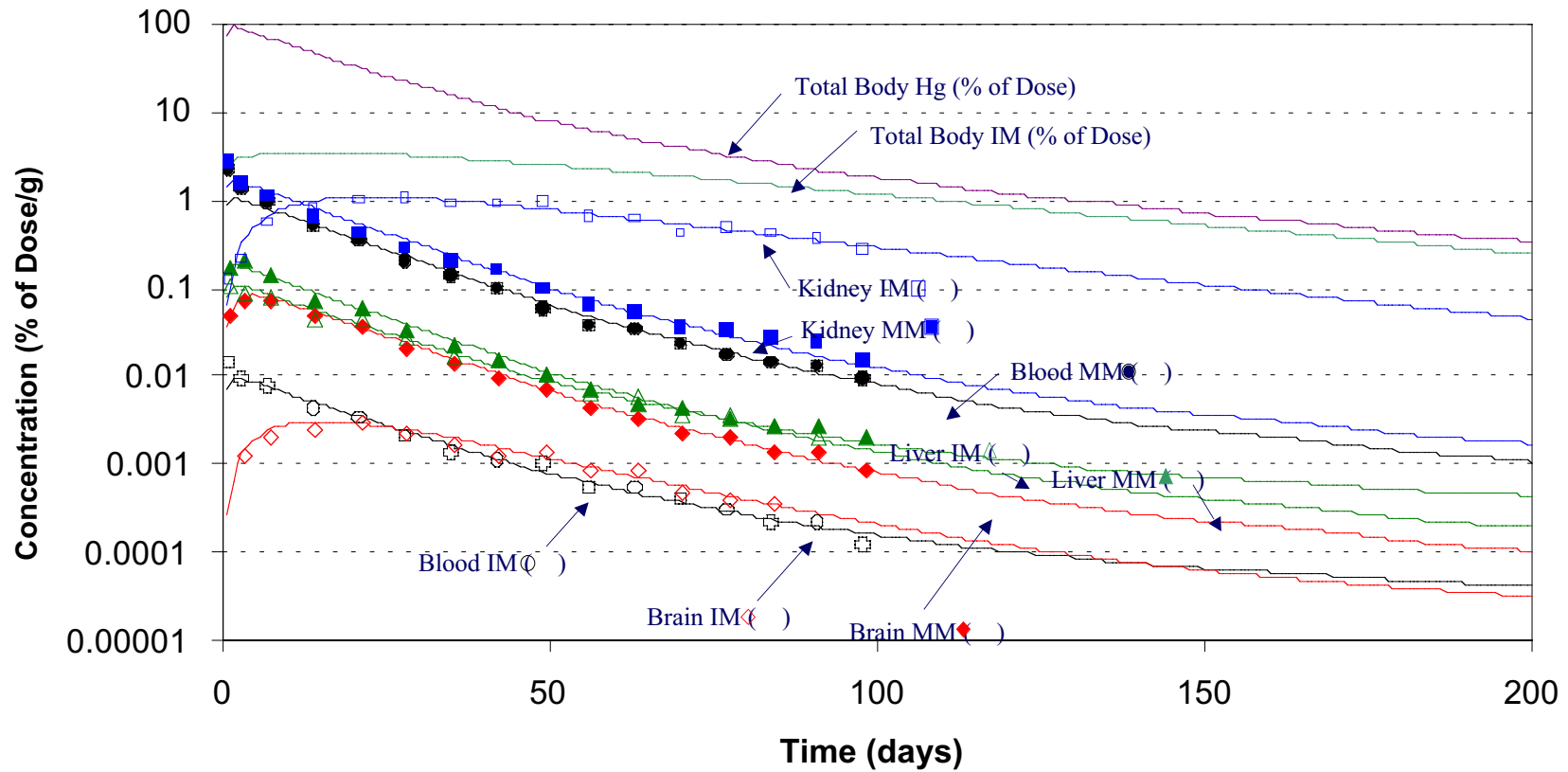

Methyl Mercury, Monkey (Vahter et al., 1994)

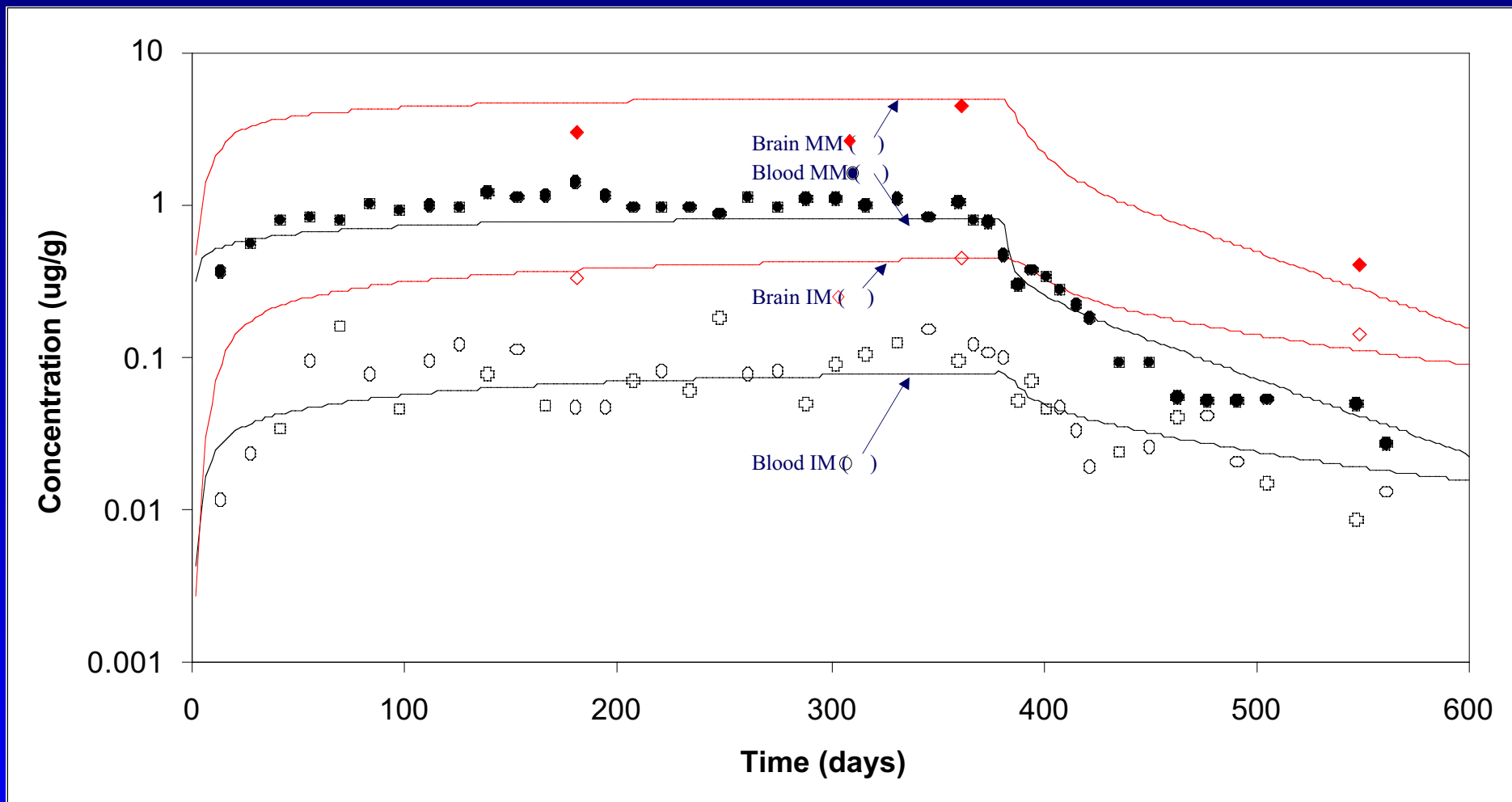

Methyl Mercury, Human (Sherlock et al., 1984)

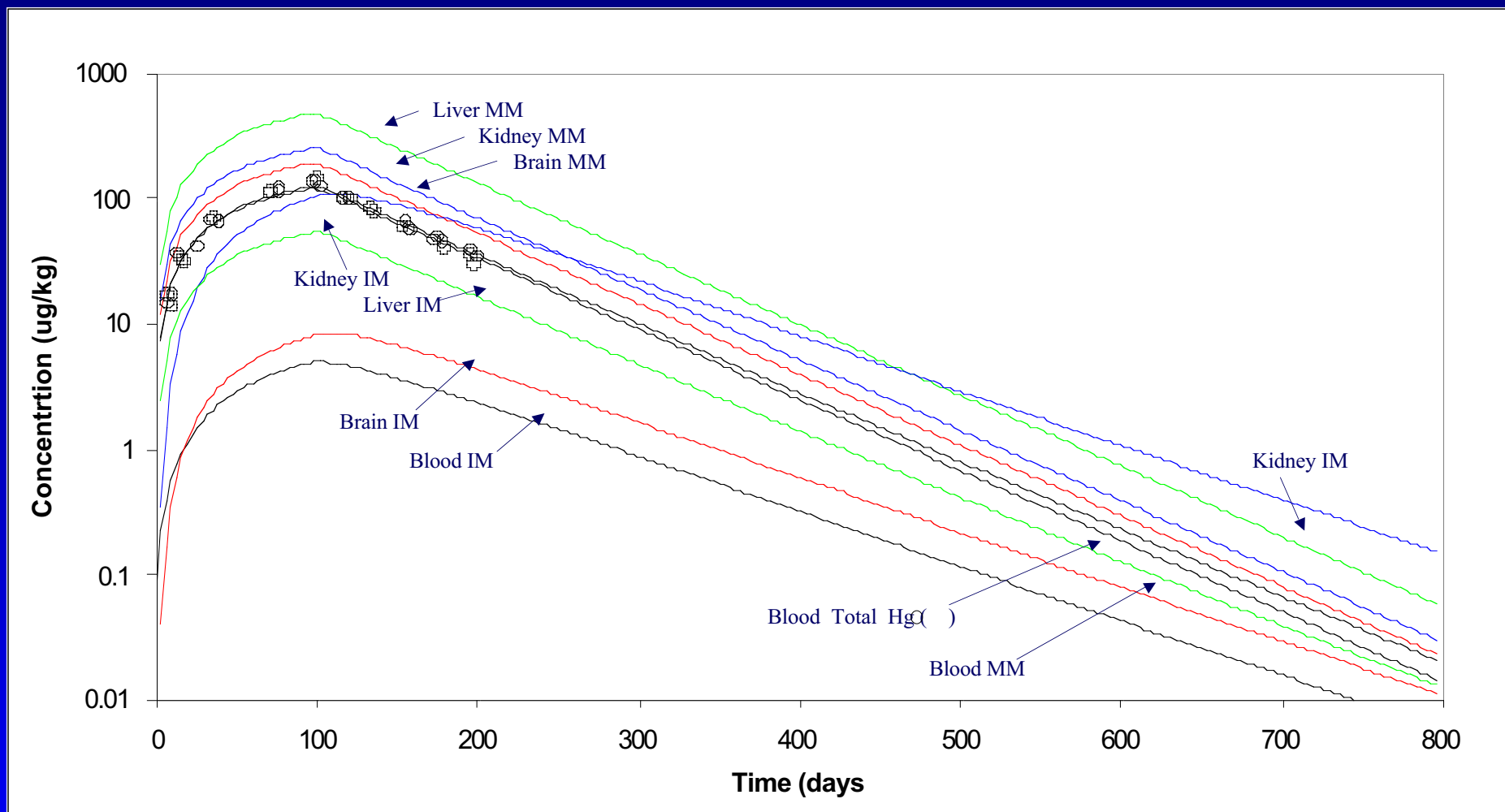

Simulation - Neonatal Monkey

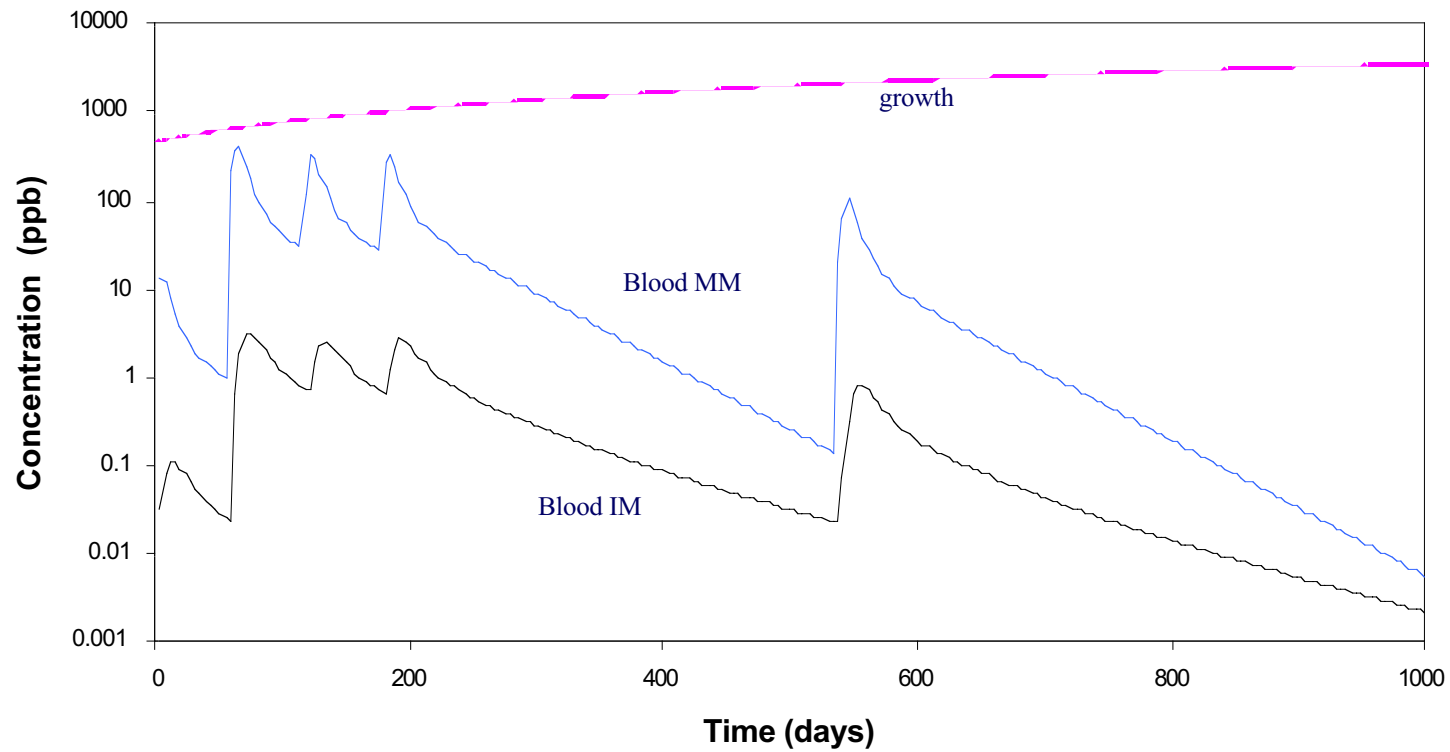

Simulation - Neonatal Monkey

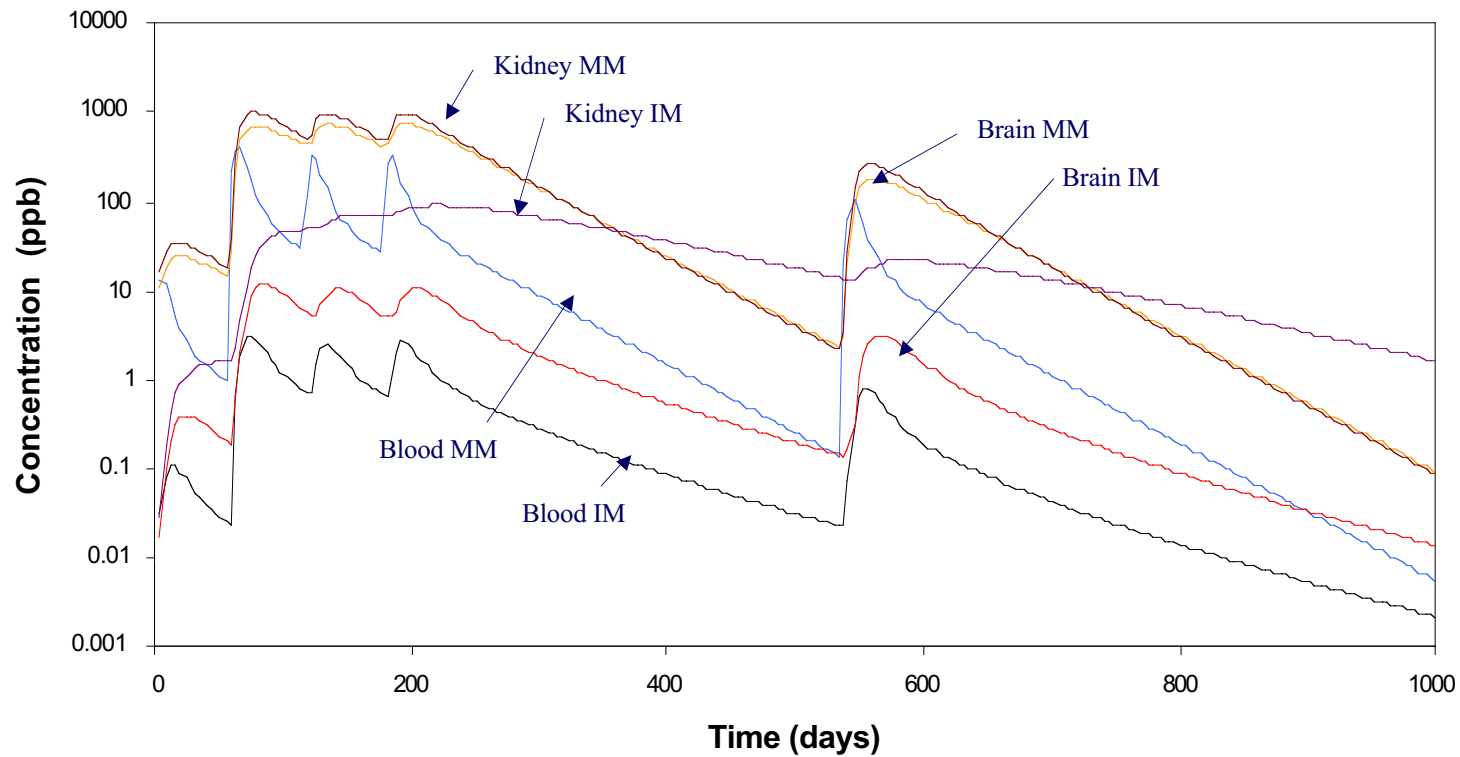

Gaps in Knowledge

- λ Toxicokinetics
- λ Ethyl vs. Methylmercury
- λ Developmental neurotoxicity
- λ Neurodevelopmental outcomes in children exposed to thimerosal in vaccines

F
D
A

→ NCTR

Our JOB:

Make **predictions** about the circumstances under which a particular compound will be **toxic to humans**

Ideally: The **data** needed to make such predictions are obtained from **laboratory animal models** in well controlled experiments under known conditions of exposure *prior* to the occurrence of human exposures.

- The use of **appropriate animal models is critical.**
- **Relevant endpoints decrease uncertainty** associated with the process.

ASPECTS OF CNS FUNCTION ASSESSED IN THE NCTR OPERANT TEST BATTERY (OTB)

- MOTIVATION**
- COLOR AND POSITION DISCRIMINATION**
- TIME PERCEPTION**
- SHORT-TERM MEMORY AND ATTENTION**
- LEARNING**

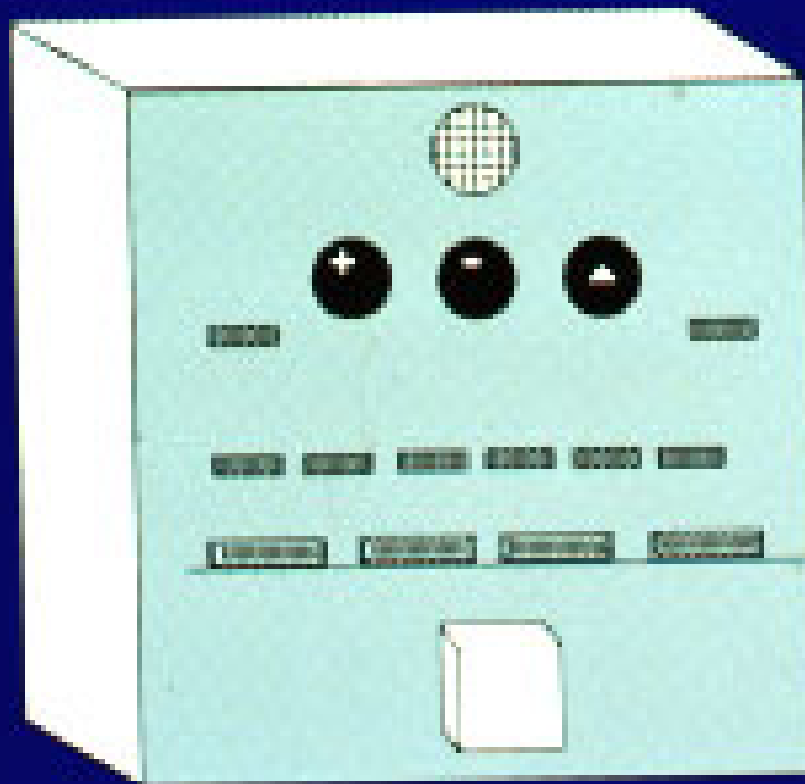

FOR THE SHORT-TERM MEMORY AND ATTENTION TASK

- All three press-plates are used
- Initially, one of several symbols is presented as a 'sample' at the center position
- Observation of the sample symbol is indicated by a subject's response to it (sample is extinguished)
- After one of several time delays (e.g., 1-32 seconds), three choice symbols are presented (one 'matching' the sample)
- Responding to the 'match' is correct

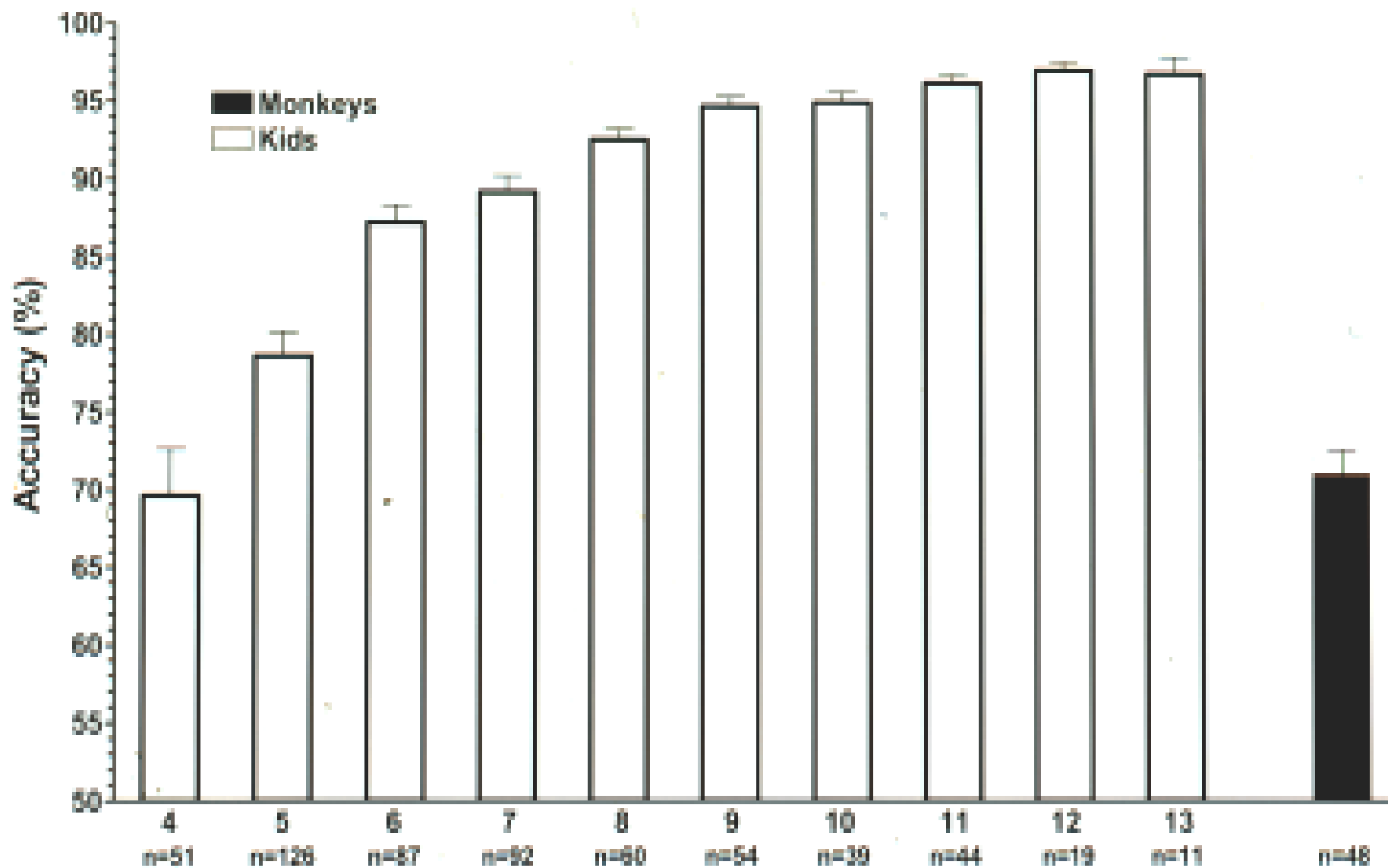

Cases of comparable behavioral effects of drugs in both humans and animals (monkeys)

Drug	Primary Acute Effect	Citations	
		Monkey	Human
THC	over-estimate time passage	Schulze et al., 1998	Hicks et al., 1984
MJ smoke	short-term memory impairment	Schulze et al., 1989	Darley et al., 1974
Chlorpromazine	decrease response initiation	Ferguson & Paule, 1992	Tecce et al., 1975
Diazepam	learning & memory impairments	Schulze et al., 1989	Ghoneim et al., 1984
Morphine	decrease response rates	Schulze & Paule, 1991	Goldberg et al., 1982
Atropine	learning disruption	Schulze et al., 1992	Higgins et al., 1989
	Primary Chronic Effect		
MJ smoke	amotivational syndrome	Paule et al., 1992	Lantner, 1982



F
D
A



NCTR



F
D
A

NCTR

Delayed Matching to Sample

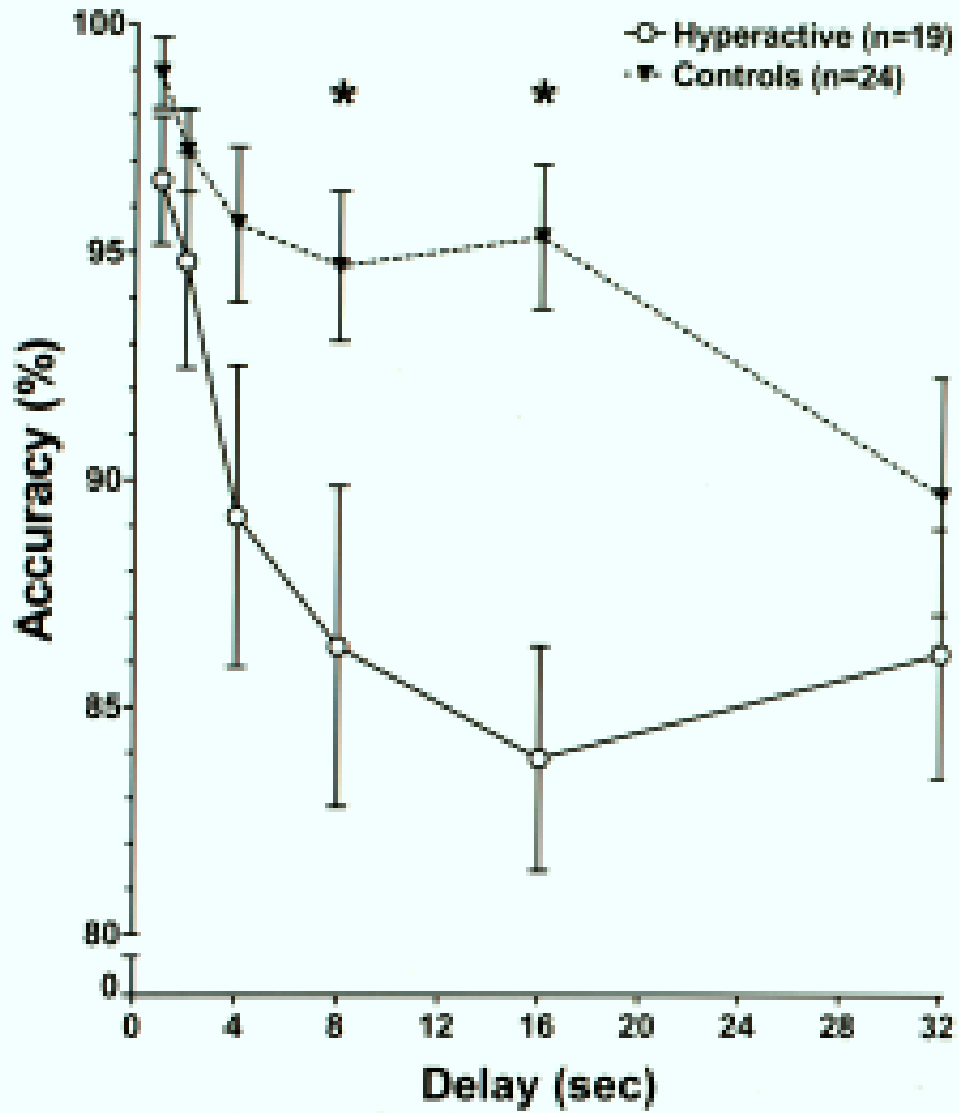

F
D
A

NCTR

Matching to Sample

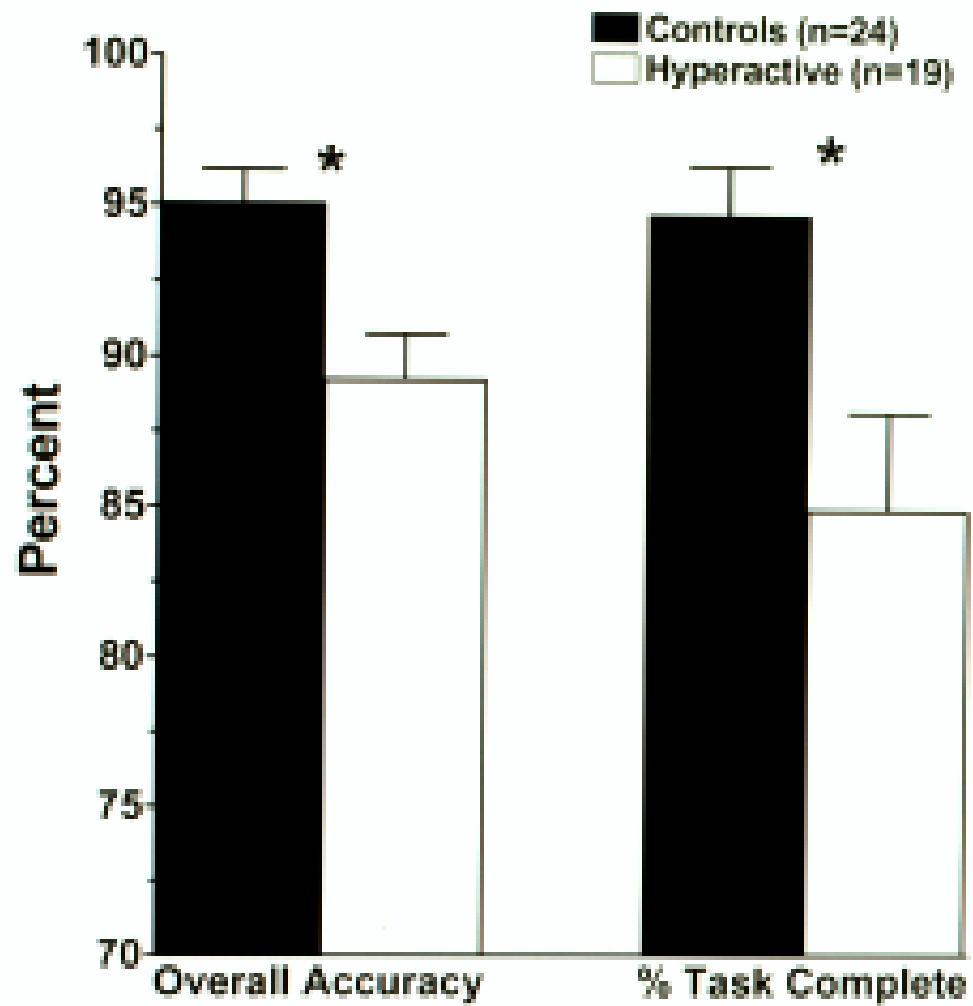

F
D
A

NCTR

Progressive Ratio

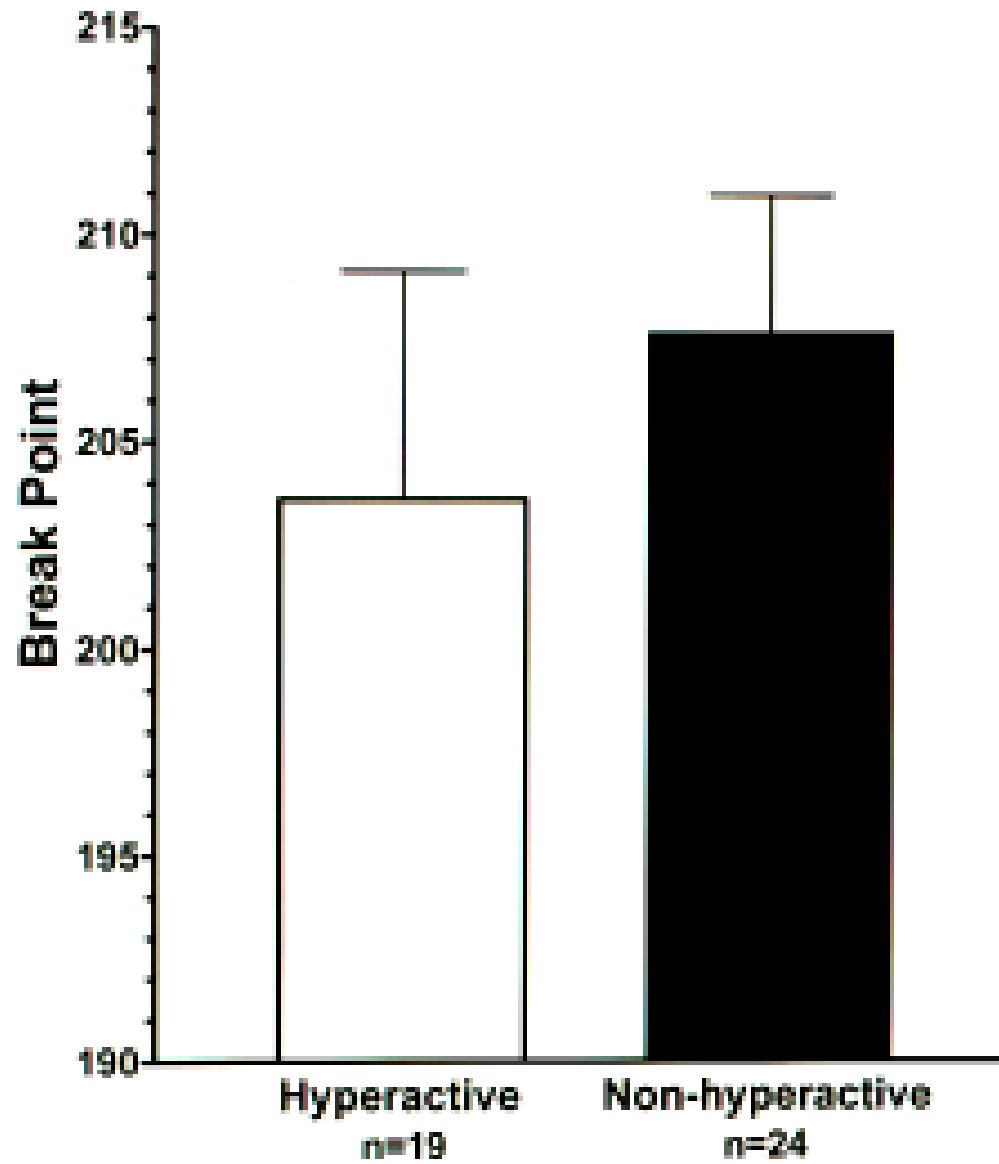

F
D
A

NCTR

Matching-to-Sample Task: Accuracy Analysis by Delay

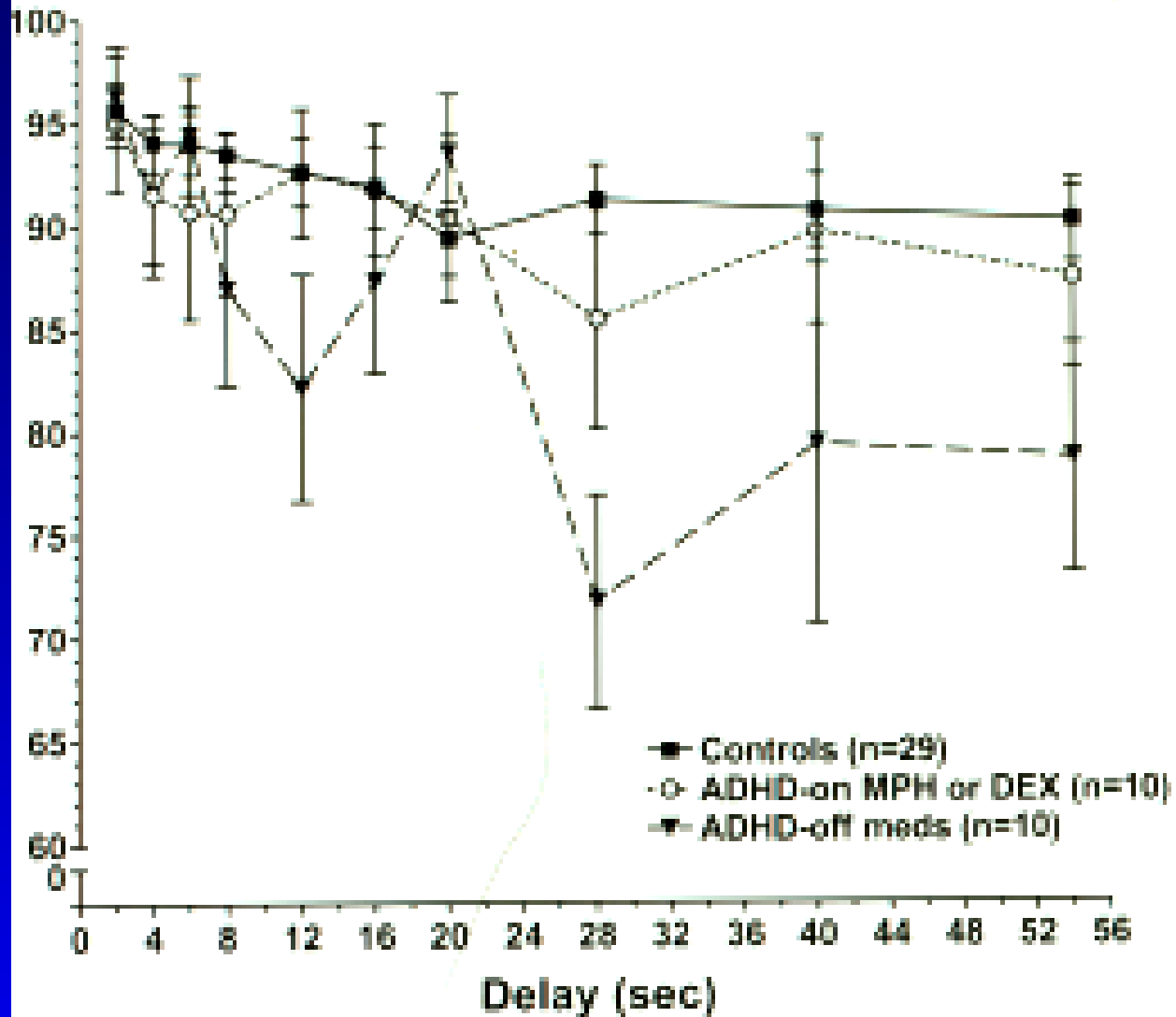

NOTE: There was a significant effect for medication for ADHD children. ADHD children off medication differed significantly from controls.

F
D
A

→ NCTR

Preliminary Proposal for Thimerosal Assessment

- λ Species: Newborn/infant rhesus monkeys
- λ Exposure: Match human infant vaccination schedule
- λ Dose groups: (N=10)
 - vehicle control
 - positive control (methylmercury)
 - thimerosal (two dose groups): human exposure levels and 10x

Preliminary Proposal for Thimerosal Assessment

- λ Species: Newborn/infant rhesus monkeys
- λ Exposure: match human infant vaccination schedule
- λ Assessments:
 - Growth and development
 - Blood and hair samples
 - Operant behavior (acquisition: 6-12 months; reversals: 12-24 months)
 - Morphometry/tissues: 3 time points

F
D
A

Gaps in Knowledge

- λ Toxicokinetics
- λ Ethyl vs. Methylmercury
- λ Developmental neurotoxicity
- λ Neurodevelopmental outcomes in children exposed to thimerosal in vaccines

F
D
A

→ NCTR

Acknowledgements

Merle Paule, Ph.D.

John Young, Ph.D.

F
D
A

→ NCTR

ACKNOWLEDGEMENTS

Eric Allen, ROW (NCTR)

Edward Ashcraft, ACH

Michael Beaudoin, ROW (NCTR)

Donna J. Blake, ACH

Roger M. Brown, NIDA

Patrick Casey, ACE

Joan M. Cranmer, ACH

Sherry A. Ferguson, NCTR

Tina M. Forrester, NCTR

Michael P. Gillam, NCTR

Edward L. Hoffman, ACH

Michelle Maher, ACH

Joe Meehan, ROW (NCTR)

E. Jon Popke, NCTR

Gene E. Schulze, NCTR

H. Patrick Stern, ACH

Richard R. Allen, CBSI (NCTR)

John R. Bailey, NCTR

Zbigniew Binlenda, NCTR

Monique C. Braude, NIDA

Elizabeth A. Buffalo, NCTR

John J. Chelonis, ACH/NCTR

Roscoe A. Dykman, ACH

C. Matthew Fogle, NCTR

David L. Frederick, NCTR

Ray Hashemi, UALR

Martin Jackson, ROW (NCTR)

A. J. Mayorga, NCTR

Paul Morris, NCTR

Richard Rasmussen, NCTR

William Slikker, Jr., NCTR

Galen R. Wenger, UAMS

J. Dale Wilkins, ACH