

LA-UR-

*Approved for public release;
distribution is unlimited.*

Title:

Author(s):

Submitted to:



Los Alamos National Laboratory, an affirmative action/equal opportunity employer, is operated by the University of California for the U.S. Department of Energy under contract W-7405-ENG-36. By acceptance of this article, the publisher recognizes that the U.S. Government retains a nonexclusive, royalty-free license to publish or reproduce the published form of this contribution, or to allow others to do so, for U.S. Government purposes. Los Alamos National Laboratory requests that the publisher identify this article as work performed under the auspices of the U.S. Department of Energy. Los Alamos National Laboratory strongly supports academic freedom and a researcher's right to publish; as an institution, however, the Laboratory does not endorse the viewpoint of a publication or guarantee its technical correctness.

Criticality Calculations with MCNP5TM: A Primer

First Edition Authors:
*Charles D. Harmon, II**
*Robert D. Busch**
Judith F. Briesmeister
R. Arthur Forster

Second Edition Editor:
Tim Goorley

ABSTRACT

The purpose of this primer is to assist the nuclear criticality safety analyst to perform computer calculations using the Monte Carlo code MCNP. Because of the closure of many experimental facilities, reliance on computer simulation is increasing. Often the analyst has little experience with specific codes available at his/her facility. This Primer helps the analyst understand and use the MCNP Monte Carlo code for nuclear criticality analyses. It assumes no knowledge of or particular experience with Monte Carlo codes in general or with MCNP in particular. The document begins with a QuickStart chapter that introduces the basic concepts of using MCNP. The following chapters expand on those ideas, presenting a range of problems from simple cylinders to 3-dimensional lattices for calculating keff confidence intervals. Input files and results for all problems are included. The primer can be used alone, but its best use is in conjunction with the MCNP5 manual. After completing the primer, a criticality analyst should be capable of performing and understanding a majority of the calculations that will arise in the field of nuclear criticality safety.

MCNP, **MCNP5**, and “**MCNP Version 5**” are trademarks of the Regents of the University of California, Los Alamos National Laboratory.

TABLE OF CONTENTS

ABSTRACT	1
TABLE OF CONTENTS	2
TABLE OF CONTENTS	2
TABLE OF GREY TEXT BOXES	7
INTRODUCTION	8
Chapter 1: MCNP Quickstart	10
1.1 WHAT YOU WILL BE ABLE TO DO:	10
1.2 MCNP INPUT FILE FORMAT	10
1.2.A Title Card	10
1.2.B General Card Format	11
1.2.C Cell Cards	11
1.2.D Surface Cards	13
1.2.E Data Cards	13
1.3 EXAMPLE 1.3: BARE PU SPHERE	16
1.3.A Problem Description	16
1.3.B Title Card	16
1.3.C Cell Cards	16
1.3.D Surface Cards	18
1.3.E Data Cards	19
1.4 RUNNING MCNP5	21
1.4.A Output	22
1.5 SUMMARY	23
Chapter 2: Reflected Systems	24
2.1 WHAT YOU WILL BE ABLE TO DO:	24
2.2 PROBLEM DESCRIPTION	24
2.3 EXAMPLE 2.3: BARE PU CYLINDER	24
2.3.A Geometry	25
2.3.B Alternate Geometry Description – Macrobody	30
2.3.C Materials	30
2.3.D MCNP Criticality Controls	31
2.3.E Example 2.3 MCNP Input File	31
2.3.F Output	32
2.4 EXAMPLE 2.4: PU CYLINDER, RADIAL U REFLECTOR	33
2.4.A Geometry	33
2.4.B Alternate Geometry Description – Macrobody	35
2.4.C Materials	35
2.4.D MCNP Criticality Controls	36
2.4.E Example 2.4 MCNP Input File	36

2.4.F Output	37
2.5 EXAMPLE 2.5: PU CYLINDER, U REFLECTOR	37
2.5.A Geometry	38
2.5.B Materials	40
2.5.C MCNP Criticality Controls	40
2.5.D Example 2.5 MCNP Input File	40
2.5.E Output	41
2.6 SUMMARY	41
<i>Chapter 3: S(a,b) Thermal Neutron Scattering Laws for Moderators</i>	<i>42</i>
3.1 WHAT YOU WILL BE ABLE TO DO:	42
3.2 S(a,b) THERMAL NEUTRON SCATTERING LAWS	42
3.3 PROBLEM DESCRIPTION	42
3.4 EXAMPLE 3.4: BARE UO₂F₂ SOLUTION CYLINDER	43
3.4.A Geometry	43
3.4.B Alternate Geometry Description - Macrobodyes	46
3.4.C Materials	47
3.4.D MCNP Criticality Controls	47
3.4.E Example 3.4 MCNP Input File	49
3.4.F Output	50
3.5 MCNP K_{eff} OUTPUT	50
3.6 SUMMARY	55
<i>Chapter 4: Simple Repeated Structures</i>	<i>56</i>
4.1 WHAT YOU WILL BE ABLE TO DO	56
4.2 PROBLEM DESCRIPTION	56
4.3 EXAMPLE 4.3: REPEATED STRUCTURES, 2 CYLINDERS	56
4.3.A Geometry	56
4.3.B Materials	62
4.3.C MCNP Criticality Controls	63
4.3.D Example 4.3 MCNP Input File	63
4.3.E Output	64
4.4 PLOTTING THE PROBLEM GEOMETRY	64
4.5 SUMMARY	70
<i>Chapter 5: Hexahedral (Square) Lattices</i>	<i>71</i>
5.1 WHAT YOU WILL BE ABLE TO DO	71
5.2 PROBLEM DESCRIPTION	71
5.3 EXAMPLE 5.3: SQUARE LATTICE OF 3x2 PU CYLINDERS	72
5.3.A Geometry	72
5.3.B Materials	78

5.3.C MCNP Criticality Controls	78
5.3.D Example 5.3 MCNP Input File	79
5.3.E Output	81
5.4 EXAMPLE 5.4: CHANGING MATERIALS IN SELECTED ELEMENTS	84
5.5 EXAMPLE 5.5: A LATTICE WITH ONE EMPTY ELEMENT	87
5.6 EXAMPLE 5.6: CHANGING SIZE OF CELLS FILLING A LATTICE	88
5.7 SUMMARY	89
<i>Chapter 6: Hexagonal (Triangular) Lattices</i>	<i>90</i>
6.1 WHAT YOU WILL BE ABLE TO DO	90
6.2 PROBLEM DESCRIPTION	90
6.3 EXAMPLE 6.3: HEXAGONAL LATTICE OF PU CYLINDERS	91
6.3.A Geometry	91
6.3.B Materials	102
6.3.C MCNP Criticality Controls	102
6.3.D Example 6.3 MCNP Input File	102
6.4 PLOT OF GEOMETRY	104
6.5 EXAMPLE 6.5: EXPANDED FILL CARD IN TRIANGULAR LATTICE	105
6.6 EXAMPLE 6.6: NONEQUILATERAL TRIANGULAR LATTICE	106
6.7 SUMMARY	107
<i>Chapter 7: 3-Dimensional Square Lattices</i>	<i>109</i>
7.1 WHAT YOU WILL BE ABLE TO DO	109
7.2 PROBLEM DESCRIPTION	109
7.3 EXAMPLE 7.3: 3D (3x2x2) LATTICE	110
7.3.A Solution Cylinder	110
7.3.B Square Lattice Cell	111
7.3.C Lattice Window	112
7.3.D "Rest of the World"	113
7.4 MATERIALS	113
7.5 MCNP CRITICALITY CONTROLS	113
7.6 EXAMPLE 7.3 MCNP INPUT FILE	114
7.7 OUTPUT	115
7.8 PLOT OF GEOMETRY	115
7.9 EXAMPLE 7.9: 3-D LATTICE WITH ONE WATER ELEMENT	116
7.10 USING SDEF INSTEAD OF KSRC	117
7.11 SUMMARY	119
<i>Chapter 8: Advanced Topics</i>	<i>120</i>

8.1 What you will be able to do	120
8.2 Convergence of Fission Source Distribution and K_{eff}	120
8.3 Total vs. prompt \bar{u} & Delayed Neutron Data	121
8.4 Unresolved Resonance Treatment	122
<i>Primer summary</i>	<i>124</i>
APPENDIX A: Monte Carlo Techniques	125
I. INTRODUCTION	125
II. MONTE CARLO APPROACH	125
III. CRITICALITY CALCULATIONS	126
IV. Monte Carlo Common Terms.	128
IV. Monte Carlo Common Terms.	129
APPENDIX B: Calculating Atom Densities	130
I. Single material, given: mass density	130
II. Two Materials	131
II.a Two materials, given: weight fractions and mixture density.	131
II.b Two materials, given: weight fractions and individual material densities.	132
III. Two materials given: atom fractions and atom mixture density	132
IV. Calculating fractions & average weight with one known set	134
V. Molecules	134
V.a. Molecules, given: chemical structure and mass density.	134
V.b. Molecules with mixtures of isotopes.	135
VI. Solution Systems.	137
VI.a. H/Xratio, fissile component density, and with chemical formula.	138
APPENDIX C: Specifications & Atom Densities Of Selected Materials	141
APPENDIX D: Listing of Available Cross-Sections	151
APPENDIX E: Geometry PLOT and Tally MCPLLOT Commands	158
APPENDIX F: MCNP Surface Cards	166
APPENDIX G: MCNP Forum FAQ	169
Question: Best Nuclear Data for Criticality Calculations	170
Question: Transformation and Source Coordinates Problem	170
Question: Bad Trouble, New Source Has Overrun the Old Source	172
Question: Photo-neutron Production in Deuterium	172
Question: Zero Lattice Element Hit – Source Difficulty	173
Question: Zero Lattice Element Hit – Fill Problem	174

Question: Zero Lattice Element Hit – Large Lattices	175
<i>APPENDIX H: Example Problem Input Decks</i>	177
Example Problem 1-2.	177
Example Problem 2-3.	177
Example Problem 2-3m.	178
Example Problem 2-4.	178
Example Problem 2-4m.	179
Example Problem 2-5.	179
Example Problem 2-5m.	180
Example Problem 3-4.	180
Example Problem 3-4m.	181
Example Problem 3-4nomt.	181
Example Problem 4-3.	182
Example Problem 5-3.	183
Example Problem 5-4.	184
Example Problem 5-5.	185
Example Problem 5-6.	186
Example Problem 6-3.	187
Example Problem 6-5.	188
Example Problem 7-3.	190
Example Problem 7-9.	191
Example Problem 7-10.	193
<i>Appendix I: Overview of the MCNP Visual Editor Computer</i>	194
Background	194
Display Capabilities	194
Creation Capabilities	195
Installation Notes	195
References	196

TABLE OF GREY TEXT BOXES

<i>Grey Box 1. – Preferred ZAIID format: Library Extension.</i>	15
<i>Grey Box 2. – Surface Sense.</i>	27
<i>Grey Box 3. – Intersections and Unions.</i>	28
<i>Grey Box 4. – Normalization of Atom Fractions.</i>	36
<i>Grey Box 5. – Complement Operator (#).</i>	39
<i>Grey Box 6. – Order of Operations.</i>	45
<i>Grey Box 7. – Alternative Cell 3 Descriptions.</i>	46
<i>Grey Box 8. – The Criticality Problem Controls.</i>	48
<i>Grey Box 9. – Final K_{eff} Estimator Confidence Interval.</i>	51
<i>Grey Box 10. – Continuing a Calculation from RUNTPE and Customizing the OUP File.</i>	54
<i>Grey Box 11. – The Universe Concept.</i>	59
<i>Grey Box 12. – Simple like m but trcl Example.</i>	61
<i>Grey Box 13. – Surfaces Generated by Repeated Structures.</i>	69
<i>Grey Box 14. – Finding Coordinates For ksxc Card.</i>	81
<i>Grey Box 15. – Filling Lattice Elements Individually.</i>	85
<i>Grey Box 16. – Planes in an Equilateral Hexagonal Lattice.</i>	98
<i>Grey Box 17. – Ordering of Hexagonal Prism Lattice Elements.</i>	100
<i>Grey Box 18. – Example Monte Carlo Process.</i>	128

INTRODUCTION

With the closure of many experimental facilities, the nuclear criticality safety analyst increasingly is required to rely on computer calculations to identify safe limits for the handling and storage of fissile materials. However, in many cases, the analyst has little experience with the specific codes available at his/her facility. This Primer will help you, the analyst, understand and use the MCNP Monte Carlo code for nuclear criticality safety analyses. It assumes that you have a college education in a technical field. There is no assumption of familiarity with Monte Carlo codes in general or with MCNP in particular. Appendix A gives an introduction to Monte Carlo techniques. The primer is designed to teach by example, with each example illustrating two or three features of MCNP that are useful in criticality analyses.

Beginning with a QuickStart chapter, the primer gives an overview of the basic requirements for MCNP input and allows you to run a simple criticality problem with MCNP. This chapter is not designed to explain either the input or the MCNP options in detail; but rather it introduces basic concepts that are further explained in following chapters. Each chapter begins with a list of basic objectives that identify the goal of the chapter, and a list of the individual MCNP features that are covered in detail in the unique chapter example problems. The example problems are named after the chapter and section they are first presented in. It is expected that on completion of the primer you will be comfortable using MCNP in criticality calculations and will be capable of handling most of the situations that normally arise in a facility. The primer provides a set of basic input files that you can selectively modify to fit the particular problem at hand.

Although much of the information to do an analysis is provided for you in the primer, there is no substitute for understanding your problem and the theory of neutron interactions. The MCNP code is capable only of analyzing the problem as it is specified; it will not necessarily identify inaccurate modeling of the geometry, nor will it know when the wrong material has been specified. Remember that a single calculation of k_{eff} and its associated confidence interval with MCNP or any other code is meaningless without an understanding of the context of the problem, the quality of the solution, and a reasonable idea of what the result should be.

The primer provides a starting point for the criticality analyst using MCNP. Complete descriptions are provided in the MCNP manual. Although the primer is self-contained, it is intended as a companion volume to the MCNP manual. The primer provides specific examples of using MCNP for criticality analyses while the manual provides information on the use of MCNP in all aspects of particle transport calculations. The primer also contains a number of appendices that give the user additional general information on Monte Carlo techniques, the default cross sections available with MCNP, surface descriptions, and other reference data. This information is provided in appendices so as not to obscure the basic information illustrated in each example.

To make the primer easy to use, there is a standard set of notation that you need to know. The text is set in Times New Roman type. Information that you type into an input file is set in Courier. Characters in the Courier font represent commands, keywords, or data that would be used as computer input. The character “?” will be used to represent a blank line in the first chapter. Because the primer often references the MCNP manual, these references will be set in braces, e.g. {see MCNP Manual Chapter xx}. Material

MCNP Criticality Primer II

presented in a gray box is provided for more in-depth discussions of general MCNP concepts.

It is hoped that you find the primer useful and easy to read. As with most manuals, you will get the most out of it if you start with Chapter One and proceed through the rest of the chapters in order. Each chapter assumes that you know and are comfortable with the concepts discussed in the previous chapters. Although it may be tempting to pick up the primer and immediately go to the example problem that is similar to your analysis requirement, this approach will not provide you with the background or the confidence in your analysis that is necessary for safe implementation of procedures and limits. There is no substitute for a thorough understanding of the techniques used in an MCNP analysis. A little extra time spent going through the primer and doing the examples will save many hours of confusion and embarrassment later. After studying the primer, you will find it a valuable tool to help make good, solid criticality analyses with MCNP.

Chapter 1: MCNP Quickstart

1.1 WHAT YOU WILL BE ABLE TO DO:

- 1) Interpret an MCNP input file.
- 2) Setup and run a simple criticality problem on MCNP.
- 3) Interpret k_{eff} information from MCNP output.

1.2 MCNP INPUT FILE FORMAT

The MCNP input file describes the problem geometry, specifies the materials and source, and defines the results you desire from the calculation. The geometry is constructed by defining cells that are bounded by one or more surfaces. Cells can be filled with a material or be void.

An MCNP input file has three major sections: cell cards, surface cards, and data cards. A one-line title card precedes the cell card section. Note the word “card” is used throughout this document and in the MCNP manual to describe a single line of input of up to 80 characters. A section consists of one or more cards. Figure 1–1 shows the input file structure.

```

Title Card
Cell Cards
.....
.....
Blank Line Delimiter
Surface Cards
.....
.....
Blank Line Delimiter
Data Cards
.....
.....
Blank Line Terminator (optional)

```

Figure 1-1 MCNP Input File Structure.

1.2.A Title Card

The title card is the first card in an MCNP input file and can be up to 80 characters long. It often contains information about the problem being modeled. This title is echoed in various places throughout the MCNP output. It also serves as a label to distinguish among input files and to help identify the content of output files.

1.2.B General Card Format

The cards in each section can be in any order and alphabetic characters can be upper, lower, or mixed case. MCNP uses a blank line delimiter to denote separation between the three different sections. In this chapter only, we will use a “?” to identify these blank lines.

The general format for the cell, surface, and data cards is the same. The cell or surface number or data card name must begin within the first five columns. Card entries must be separated by one or more blanks. Input lines cannot exceed 80 columns. The following are some special characters used for comments and card continuation.

<u>Character</u>	<u>Placement</u>	<u>Function</u>
c	Columns 1-5 Followed by at least one blank.	Denotes a comment line. Can be any line in an input file after the title card.
\$	After input data on a line	Anything that follows this character is a comment.
&	After input data	Data on the next line is a continuation and can be in columns 1-80.
blanks	Columns 1-5	Blanks in the first 5 columns indicate continuation of the previously named card.

1.2.C Cell Cards

The first section after the title card is for the cell cards and has no blank line delimiter at the front of it. Cells are used to define the shape and material content of physical space. The specific format for a cell card is:

```

j          m      d      geom      params

```

j = Cell number, starting in columns 1-5.

m = Material number (0 if cell is a void).

d = Cell material density:

No entry if the cell is a void.

Positive entry = atom density (atoms/b-cm).

Negative entry = mass density (g/cc).

geom = List of all signed surface numbers and Boolean operators that specify a cell.

params = Optional specification of cell parameters.

The cell number, *j*, is an integer from 1 to 99999. The material number, *m*, is also an integer from 1 to 99999 that determines what material is present in the cell. The composition of a specific material is defined in the data card section. A positive entry for the cell material density, *d*, indicates an atomic density in *atoms per barn-centimeter*. A negative entry indicates a mass density in *grams per abic centimeter*. The geometry specification, *geom*, consists of signed surface numbers combined with Boolean operators to describe how regions of space are bounded by those surfaces. Surfaces are the geometric shapes used to form the boundaries of the problem being modeled. The optional *params* feature allows cell parameters to be specified on the cell card line instead of in the data card section. For example, the importance card (*imp:n*) specifies the relative cell importance for neutrons, one entry for each cell of the problem. The *imp:n* card can go in the data card section or it can be placed on the cell card line at the end of the list of surfaces. The *imp:n* card will be discussed more thoroughly in the following chapters. {Chapter 3 of the MCNP manual provides a full explanation of the *params* option.}

Figure 1-2 is an example of a cell card. The optional comment card has a C in column 1, followed by a blank and the comment itself. The second line shows the cell number (4) followed by the material number (1) and the material density (1.234e-3). Because 1.234e-3 is positive, the density of material 1 is in units of *atoms per barn-cm*. The -2 indicates that cell 4 is bounded only by surface 2. Surface 2 is defined in the surface card section. The negative sign preceding the surface number means that cell 4 is the region of space that has a negative sense with respect to surface 2.

```

C Cell Card
4 1 1.234e-3 -2 imp:n=1

```

Figure 1-2. Cell card example.

1.2.D Surface Cards

The specific format for a surface card is:

```
j      a      list
```

j = Surface number, starting in columns 1-5. (1-99999)
a = Surface mnemonic. (plane, sphere, cylinder, etc.)
list = Numbers that describe the surface.
 (dimensions, radius, etc., in cm)

Figure 1-3 is an example of a surface card. The number of this surface is 1. The mnemonic *cz* defines an infinite cylinder centered on the *z*-axis, with a radius of 20.0 cm. The \$ terminates data entry and everything that follows, infinite *z* cylinder, is interpreted as a comment, providing the user with more detail.

```
1      cz 20.0  $ infinite z cylinder
```

Figure 1-3. Surface card example.

1.2.E Data Cards

The format of the data card section is the same as the cell and surface card sections. The data card name must begin in columns 1-5. At least one blank must separate the data card name and the data entries. Specifying both a criticality calculation source and material cards is most important for criticality analysis. These are only three of many available MCNP data cards. {See chapter 3 of the MCNP manual.} All criticality calculations must have a *kcode* card. The *kcode* card format is shown below.

```
kcode      nsrck  rkk  ikz  kct
```

kcode = Card name for criticality calculation.

Starts in columns 1-5.

nsrck = Number of neutrons per cycle.

rkk = Initial guess for k_{eff} .

ikz = Number of cycles skipped before accumulating data.

kct = Total number of cycles to be run.

MCNP Criticality Primer II

Figure 1-4 is an example of a `kcode` card. The problem will be run with 5000 neutrons per cycle and an initial guess for k_{eff} of 1.0. Fifty cycles will be skipped before k_{eff} data accumulation begins, and a total of 250 cycles will be run.

```
kcode 5000 1.0 50 250
```

Figure 1-4. Example of `kcode` card.

Criticality problems often use a `ksrc` card to specify the initial spatial fission distribution. Other methods to specify starting fission source locations will be discussed in a later chapter. The `ksrc` format is shown in Figure 1-5. A fission source point will be placed at each point with coordinates (X_k, Y_k, Z_k) . As many source points as needed can be placed within the problem geometry. All locations must be in locations with importance greater than 0, and at least one of the source points must be within a region of fissile material for the problem to run. The `ksrc` card format is:

```
ksrc x1 y1 z1 x2 y2 z2 ... xn yn zn
```

ksrc = Card name for initial fission source location. Starts in columns 1-5.

x_k y_k z_k = Location of the k^{th} initial fission source point.

Figure 1-5 shows an example of a `ksrc` card. Two initial fission source points are used. The first is located at the coordinates (1,0,0) and the second at (12, 3, 9).

```
ksrc 1 0 0 12 3 9
```

Figure 1-5. Example of `ksrc` card.

Next we discuss the material card. The format of the material, or `m` card, is

```
mn zaid1 fraction1 zaid2 fraction2 ...
```

mn = Material card name (*m*) followed immediately by the material number (*n*) on the card. The `mn` cards starts in columns 1-5.

zaid = Atomic number followed by the atomic mass of the isotope. Preferably (optionally) followed by the data

library extension, in the form of .##L (period, two digits, one letter).
 fraction = Nuclide fraction
 (+) Atom weight
 (-) Weight fraction

An example of a material card where two isotopes of plutonium are used is shown in Figure 1-6. The material number *n* is an integer from 1 to 99999. Each material can be composed of many isotopes. Default cross-sections are used when no extension is given. {Chapter 3 and Appendix G of the MCNP manual describe how to choose cross sections from different libraries.}

```
m1      94239.66c 2.442e-2
        94240.66c 1.673e-3
```

Figure 1-6. Data card of default ZAIDs with material format in atom fractions.

The first ZAID is 94239.66c followed by the atom fraction. The atomic number is 94, plutonium. The atomic mass is 239 corresponding to the 239 isotope of plutonium. The .66c is the extension used to specify the ENDF66 (continuous energy) library. A second isotope in the material begins immediately after the first using the same format and so on until all material components have been described. Notice that the material data is continued on a second line. If a continuation line is desired or required, make sure the data begins after the fifth column of the next line, or end the previous line with an ampersand (&). Because the fractions are entered as positive numbers, the units are *atoms/b-cm*. If the atom or weight fractions do not add to unity, MCNP will automatically renormalize them.

Grey Box 1. – Preferred ZAID format: Library Extension.

Preferred ZAID format: Library Extension.

The preferred method of specifying the ZAID is to use an extension to denote the specific library you want to use. Different data libraries contain different data sets, and may differ in evaluation temperature, incident particle energy range, photon production, presence or absence of delayed neutron data, unresolved resonance treatment data and secondary charged particle data. It is important to look in Appendix G of the MCNP manual and verify that **for each ZAID**, the data library you intend to use matches the conditions of your MCNP simulation. The common (continuous-energy) extensions for recent data libraries (based on ENDF/B-VI) are .62c, .66c, and .60c.

When no extension (or a partial extension) is given, the first matching ZAID listed in the xsdir file is used. This file is usually located in the directory where the MCNP data libraries are stored. To verify the data libraries used in the mcnp run, look in the output file.

1.3 EXAMPLE 1.3: BARE PU SPHERE

This introduction should provide enough information to run a simple example problem. It is our intent that you gain confidence in using MCNP right away, so we walk through this sample problem step by step, explaining each line of input. For the present it is important that you enter this problem exactly as we describe it. As you gain more experience with MCNP, you may find other ways to setup input files that are more logical to you. For example, you may find it easier to work out the surface cards before doing the cell cards.

1.3.A Problem Description

This problem is a bare sphere of plutonium metal with a coating of nickel (also known as Jezebel). Experimental parameters are:

delta-phase Pu metal sphere: radius	= 6.38493 cm	
N₂₃₉ = Atom density of Pu-239	= 3.7047e-2	atoms/b-cm
N₂₄₀ = Atom density of Pu-240	= 1.751e-3	atoms/b-cm
N₂₄₁ = Atom density of Pu-241	= 1.17e-4	atoms/b-cm
N_{Ga} = Atom density of Ga	= 1.375e-3	atoms/b-cm
Spherical nickel coating: Thickness	= 0.0127 cm	
N_{Ni} = Atom density of Ni	= 9.1322e-2	atoms/b-cm

Now you are ready to begin entering the example problem. First open a new file named example. All text shown in the courier font is what you need to type in. Each new card, as it is discussed, is indicated by an arrow in the left margin. The first line in the file must be the title card, which is followed by the three major sections of an MCNP input file (cells, surfaces, and data).

1.3.B Title Card

A one line title card is required and can be up to 80 characters in length. There is no blank line between the title card and the cell cards.

Example 1-2. Jezebel. Bare Pu sphere w/ Ni shell

1.3.C Cell Cards

The problem requires description of the plutonium sphere and a nickel shell, as shown in Figure 1-7. We will enter the plutonium cell information first. The comment card shows how it helps make the input file easier to follow. The cell number is 1 and the material number is 1. The material density, $4.0290e-2$, is the sum of the material

densities of the plutonium isotopes present in the sphere. Because $4.0290e-2$ is positive, the units are *atoms/b-cm*. The next entry, -1, indicates that cell 1 (inside the sphere) is all space having a negative sense with respect to surface 1. The `imp:n=1` says this cell has an importance (`imp`) for neutrons (`:n`) of 1.

Example 1-2. Jezebel. Bare Pu sphere w/ Ni shell

```

C      Cell cards
→ 1      1  4.0290e-2  -1      imp:n=1

```

Next we will enter information about the nickel shell encasing the plutonium. The cell number is 2, and the material number is 2. Again, the material atom density, $9.1322e-2$, is positive, so the units are *atom/b-cm*. The next two entries, 1 -2, define cell 2 as all space that has a positive sense with respect to surface 1 and a negative sense with respect to surface 2 (outside sphere 1 and inside sphere 2). A surface number with no sign is interpreted as positive. A +1 entry would also be acceptable. Cell 2 also has a neutron importance of 1 (`imp:n=1`).

Example 1-2. Jezebel. Bare Pu sphere w/ Ni shell

```

C      Cell cards
1      1  4.0290e-2  -1      imp:n=1
→ 2      2  9.1322e-2   1 -2  imp:n=1

```

To complete the cell card section we must define all space outside the plutonium/nickel system. The cell number is 3 and the material number is 0, indicating a void. The next entry, 2, defines cell 3 as all space that has a positive sense with respect to surface 2 (outside of sphere 2). As there is no outer boundary, this makes cell 3 an infinite cell. Cell 3 has a neutron importance of zero (`imp:n=0`). This infinite cell defines an outside world for the problem. When particles enter a cell of zero importance, they are assumed to have escaped the problem and are terminated. (A complete explanation of the importance card can be found in Chapter 3 of the MCNP manual.) A blank line delimiter concludes the cell card section.

Example 1-2. Jezebel. Bare Pu sphere w/ Ni shell

```

C      Cell cards
1      1  4.0290e-2  -1      imp:n=1
2      2  9.1322e-2   1 -2  imp:n=1
→ 3      0              2      imp:n=0
→ ?

```

1.3.D Surface Cards

Two spherical surfaces are required for the geometry of this problem. The first sphere, surface 1, encloses the plutonium material. It is a sphere centered at the origin 0,0,0; therefore the so surface mnemonic is used. A sphere radius, 6.38493 cm in this case, is needed to complete the information on surface card 1. Appendix F of this document provides a list of the surface mnemonics available. Some of these surfaces are 3D objects, such as a can or a cube. These kinds of surfaces are known as macrobodies.

```

Example 1-2. Jezebel. Bare Pu sphere w/ Ni shell
C      Cell cards
1      1  4.0290e-2  -1      imp:n=1
2      2  9.1322e-2   1 -2   imp:n=1
3      0                      2   imp:n=0
?
C      Surface cards
→ 1    so  6.38493

```

The second sphere, surface 2, also is centered at the origin, but it has radius of 6.39763 cm. The inner surface of the nickel shell corresponds exactly to the outer surface of the plutonium sphere, which is already defined as surface 1. A blank line concludes the surface card section.

Example 1-2. Jezebel. Bare Pu sphere w/ Ni shell

```

C      Cell cards
1      1  4.0290e-2  -1      imp:n=1
2      2  9.1322e-2   1 -2  imp:n=1
3      0                      2  imp:n=0
?
C      Surface cards
1      so  6.38493
→ 2      so  6.39763
→ ?

```

1.3.E Data Cards

This example illustrates a criticality calculation, so the `kcode` card is required. The number of neutrons per k_{eff} cycle is 5000. The number of source neutrons depends on the system and the number of cycles being run. An initial estimate of k_{eff} is 1.0 because this example's final result is expected to be very close to critical. We will skip 50 k_{eff} cycles to allow the spatial fission source to settle to an equilibrium before k_{eff} values are used for averaging for the final k_{eff} estimate. A total of 250 k_{eff} cycles will be run.

Example 1-2. Jezebel. Bare Pu sphere w/ Ni shell

```

C      Cell cards
1      1  4.0290e-2  -1      imp:n=1
2      2  9.1322e-2   1 -2  imp:n=1
3      0                      2  imp:n=0
?
C      Surface cards
1      so  6.38493
2      so  6.39763
?
C      Data cards
C      Criticality Control Cards
→ kcode 5000 1.0  50  250

```

The entries on the `ksrc` card place one fission source point at (0,0,0), the center of the plutonium sphere. For the first k_{eff} cycle, 5000 neutrons with a fission energy distribution will start at the origin. More source points can be used but are not necessary for this example.

After the first cycle, neutrons will start at locations where fissions occurred in the previous cycle. The fission energy distribution of each such source neutron will be based upon the nuclide in which that fission occurred.

MCNP Criticality Primer II

Example 1-2. Jezebel. Bare Pu sphere w/ Ni shell

```

C      Cell cards
1      1  4.0290e-2  -1      imp:n=1
2      2  9.1322e-2   1 -2   imp:n=1
3      0                2   imp:n=0
?
C      Surface cards
1      so  6.38493
2      so  6.39763
?
C      Data cards
C      Criticality Control Cards
kcode 5000 1.0  50  250
→ ksrc   0  0  0
    
```

The last information needed for this problem is a description of our materials. Material 1, in cell 1, is plutonium, and material 2, in cell 2, is nickel. The material number on the m card is the same as the material number used on the cell card. Material 1, m1, has three isotopes of plutonium and one of gallium. The ZAID of Pu-239 is 94239.66c, followed by the nuclide atom fraction (3.7047e-2). The .66c extension indicates that the ENDF66c data library is used, which is based on the ENDF/B-VI release 6. {Look in Appendix G of the MCNP manual to view its evaluation temperature (293.6 K), vbar (prompt or total), etc.} The combined use of the ACTI (extension .62c) and ENDF66 (.66c) data libraries in this primer correspond to the final release of ENDF/B-VI. The other nuclides are treated in the same manner. Because of the length of the m1 data card line, a continuation card is required. Blanks in columns 1-5 indicate this line is a continuation of the last card.

Example 1-2. Jezebel. Bare Pu sphere w/ Ni shell

```

C      Cell cards
1      1  4.0290e-2  -1      imp:n=1
2      2  9.1322e-2   1 -2   imp:n=1
3      0                2   imp:n=0
?
C      Surface cards
1      so  6.38493
2      so  6.39763
?
C      Data cards
C      Criticality Control Cards
kcode 5000 1.0  50  250
ksrc   0  0  0
C      Materials Cards
→ m1   94239.66c 3.7047e-2  94240.66c 1.751e-3
      94241.66c 1.17e-4    31000.66c 1.375e-3
    
```

Material 2, m2, is the nickel that coats the plutonium. The ZAIDs of the naturally occurring isotopes of nickel are 28058, 28060, 28061, 28062, 28064, all of which use the .66c extension for this problem. Each of these isotopes is followed by its normalized atomic (number) abundance: 0.6808, 0.2622, 0.0114, 0.0363, 0.0093, respectively. There is an older data set of naturally occurring nickel (ZAID 28000), and its nuclide atom fraction (1.0). The three zeros following the atomic number (28) indicate that this cross-section evaluation is for elemental nickel, where the five stable nickel isotopes are combined into one cross-section set. The newer cross section evaluation is preferred, however. The optional blank line terminator indicates the end of the data card section and the end of the input file.

```

Example 1-2. Jezebel. Bare Pu sphere w/ Ni shell
C      Cell cards
1      1  4.0290e-2  -1      imp:n=1
2      2  9.1322e-2   1 -2  imp:n=1
3      0                      2  imp:n=0
?
C      Surface cards
1      so  6.38493
2      so  6.39763
?
C      Data cards
C      Criticality Control Cards
kcode 5000 1.0 50 250
ksrc   0 0 0
C      Materials Cards
m1     94239.66c 3.7047e-2  94240.66c 1.751e-3
      94241.66c 1.17e-4   31000.66c 1.375e-3
→ m2   28058.66c 0.6808    28060.66c 0.2622
      28061.66c 0.0114    28062.66c 0.0363
      28064.66c 0.0093

```

1.4 RUNNING MCNP5

We will assume that MCNP has been installed on the machine you are using. The default names of the input and output files are INP and OUTP, respectively. To run MCNP5 with different file names, type `mcnp inp=` and then the file name of the example problem followed by `outp=` and the name of the output file. The file names must be limited to 8 characters or less.

```
Mcnp5 inp=ex12 outp=exlout
```

MCNP5 writes information to the screen about how the calculation is progressing. Once the calculation is complete, check the output file to see your results. The run time for this problem should be on the order of three minutes.

1.4.A Output

First, let's assume the run was successful. There is a significant amount of information contained in the output file, but right now we are interested in the k_{eff} results. Therefore, we will skip past most of the information.

Output skipped over...

1. Echo of input file.
2. Description of cell densities and masses.
3. Material and cross-section information.
4. k_{eff} estimator cycles.
5. Neutron creation and loss summary table.
6. Neutron activity per cell.

After the "Neutron Activity Per Cell" you will see...

```
keff results for: .. Jezebel. Bare Pu sphere w/ Ni shell
```

This is the beginning of the criticality calculation evaluation summary table. Check to see that the cycle values of the three estimators for k_{eff} – $k(\text{collision})$, $k(\text{absorption})$, and $k(\text{track length})$ – appear normally distributed at the 95 or 99 percent confidence level. See that all the cells with fissionable material have been sampled. The final estimated combined k_{eff} , in the dashed box, should be very close to 1 (0.99902 ± 0.00057 (1σ)), computed on a Windows 2000 Pentium IV computer at LANL with the ENDF66c data library.) You can confirm that you used the same nuclear data by searching for print table 100 in the output file.

The combined k_{eff} and standard deviation can be used to form a confidence interval for the problem. If your results are similar to these then you have successfully created the input file and run MCNP.

If your input did not run successfully, you can look at the FATAL ERROR messages in the example1 output file. They are also displayed at the terminal. These error messages should not be ignored because they often indicate an incorrectly specified calculation. FATAL ERRORS must be corrected before the problem will run.

MCNP5 also provides WARNING messages to inform you of possible problems. For example, this calculation has the WARNING message "neutron energy cutoff is below some cross-section tables." The lower energy limit for most neutron cross-section data is $10\text{e-}11$ MeV. The default problem energy cutoff is 0 MeV, clearly below the lowest energy data point. In all room temperature energy (2.5×10^8 MeV) problems, this message can be ignored. All WARNING messages from an MCNP calculation should be examined and understood to be certain that a problem of concern has not been detected. However, a problem will run with WARNING messages.

1.5 SUMMARY

This chapter has helped you to:

- 1) **Interpret an MCNP input file.**
- 2) **Setup and run a criticality problem with MCNP5.**
- 3) **Interpret neutron multiplication information from MCNP5 output.**

{See the MCNP manual, Chapter 5, Section IV, for an annotated partial listing emphasizing the criticality aspects of the output from a criticality calculation.}

Now that you have successfully run MCNP, you are ready to learn about the more complex options available with MCNP. The following chapters present these options in a format similar to the Quickstart chapter.

Chapter 2: Reflected Systems

In the QuickStart chapter you ran a simple problem with MCNP and gained some confidence in using the code. This chapter provides a more detailed explanation of the commands used in the QuickStart chapter. Example problems are taken from LA10860 and represent computational models of criticality benchmark experiments. Each example problem is selected to focus on two or three specific MCNP commands.

2.1 WHAT YOU WILL BE ABLE TO DO:

- 1) Interpret the sense of a surface.
- 2) Use the Boolean intersection, union, and complement geometry operators.
- 3) Define a multi-cell problem.

2.2 PROBLEM DESCRIPTION

This set of examples uses a plutonium metal cylinder and examines three different configurations (LA-10860 p. 101). The three configurations are a bare (unreflected) system, and two natural uranium reflected systems: one with a radial reflector and one with both a radial and an axial reflector. In each configuration the central cylinder of plutonium has a diameter of 9.87 cm while the height of the plutonium cylinder varies with the reflection conditions. The plutonium material is the same for each configuration; therefore, the plutonium atom density (N_{239}) is the same for all three analyses. Note that for many materials both a mass density (g/cc) and an atom density (atoms/b-cm) are provided. Either is sufficient to describe materials in MCNP. Be warned, however, that the internal conversion from mass density to number density may not be consistent with the latest isotopic data (e.g., Chart of Nuclides).

2.3 EXAMPLE 2.3: BARE PU CYLINDER

The bare plutonium cylinder is modeled first. This example discusses the sense of a surface and the Boolean intersection and union geometry operators. The data for this example follows.

Plutonium Material

Delta phase Pu metal (100 percent Pu-239)

$\rho = 15.8 \text{ g/cc}$

$N_{239} = 3.9802\text{e-}2 \text{ atoms/b-cm}$

Configuration I. *Bare Plutonium Metal System*

Plutonium cylinder:

Radius = 4.935 cm

Height = 17.273 cm

2.3.A Geometry

The setup for this problem will be done in a different order than found in an MCNP input file. Recall that the cell cards precede the surface cards, but it is often easier to begin by defining the surfaces first. We will then combine these surfaces to form the cells. Figure 2-1 shows the cylindrical geometry for example 2.3.

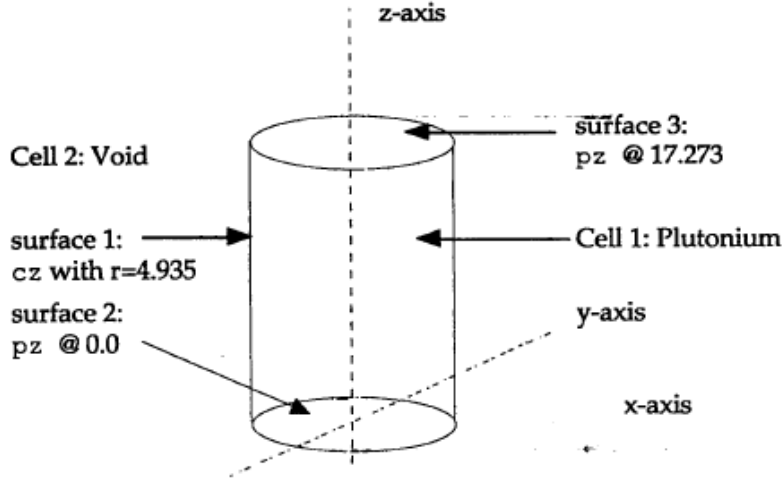

Figure 2-1. Configuration 1 geometry.

Surfaces

MCNP has many different types of surfaces (see Primer Appendix F), but the primary ones used for criticality safety are spheres, planes, and cylinders. All surfaces except the sphere, torus and macrobodies, are infinite in extent. Therefore, the surfaces must be combined to define finite shapes that enclose volumes called cells. For example, a cylinder in MCNP is infinite in height, so a top plane and a bottom plane are required to make the cylinder finite. As configuration 1 involves a finite cylinder, we will need three surfaces (an infinite cylinder and two infinite planes) to create this shape. Figure 2-2 shows the combination of surfaces for configuration 1, and Figure 2-3 shows the MCNP input for these surfaces. Defining an infinite cylinder requires choosing an axis and radius. A cylinder symmetric about the Zaxis, cz , called surface 1, will be used here. From the problem description, the radius of the infinite cylinder is 4.935 cm. Two planes perpendicular to the z-axis, pz , will be used to limit the cylinder's height. For our example, we have chosen the bottom plane, surface 2, to cross the z-axis at $z=0$. The top plane, surface 3, will cross the z-axis at $z=17.273$. When the surfaces are combined they create a finite cylinder with a height of 17.273 cm.

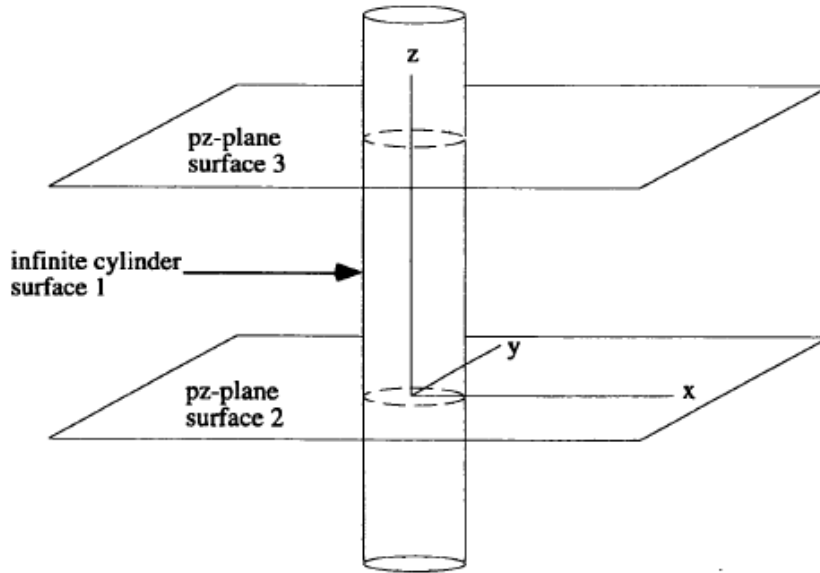

Figure 2-2. Configuration 1 surface combinations.

C	Surface Cards
1	cz 4.935
2	pz 0
3	pz 17.273

Figure 2-3. Example 2.3 surface cards.

Cells

Now that the surface cards are defined, the geometric cells can be defined. Cells are defined by identifying individual surfaces and combining these surfaces using the Boolean *intersection*, *union*, and *complement* operators. The *two* cells for configuration 1 are shown in Figure 2-1. The cell cards are shown in Figure 2-4. Remember, the first card of the input file is the problem *title* card.

Cell 1 is the plutonium cylinder and is assigned material number 1. The gram density, taken from the problem description, follows the material number. Recall from the first chapter that a gram density is entered as a negative number.

Example 2-3. Bare Pu Cylinder

C	Cell Cards
1	1 -15.8 -1 2 -3 imp:n=1
2	0 1:-2:3 imp:n=0

Figure 2-4. Example 2.3 cell cards.

Grey Box 2. – Surface Sense.**Surface Sense**

An important concept you need to understand when combining surfaces is the *sense* of all points in a cell with respect to a bounding surface. The *sense* is a sign associated with a surface that specifies which side of a surface a cell is on. Supposed that $f(x,y,z)=0$ is the equation of a surface. Choose a point (x,y,z) and put that point into the equation of the surface. If the sign of the result is *negative*, the point is said to have a *negative sense* with respect to the surface. If the result is *positive*, the point is said to have a *positive sense* with respect to the surface. If the result is zero, the point is on the surface.

For example, assume a plane intersects the x-axis at $x=2$. The MCNP equation for this plane is $x-2=0$. In this case, y and z can have any value, so the only coordinate we are concerned with is the x coordinate. Choose a point, say $x=5$, and substitute it into the equation: $5-2=3$, which is positive. Therefore, the point $x=5$ has a *positive sense* with respect to the plane at $x=2$. You do not have to evaluate an equation every time you define a cell.

For commonly used surfaces, space that is:

- Inside** a sphere, cylinder, or cone has a **negative** sense;
- Outside** a sphere, cylinder, or cone has a **positive** sense;
- Above** or to the **right** of a plane has a **positive** sense;
- Below** or to the **left** of a plane has a **negative** sense.

{For more details see Chapter 1 of the MCNP Manual}

Continuing with cell 1, the plutonium is contained inside the cylinder, therefore the sense of surface 1, the infinite cylinder, with respect to (wrt) cell 1 is negative, -1. Cell 1 now needs to be restricted to the region above surface 2 and below surface 3. Using the rules stated above, the sense of surface 2 is positive, and the sense of surface 3 is negative wrt cell 1. This combination of three surfaces is entered on the cell 1 card after the material density. The blanks between the surface numbers, - 1 2 - 3, define intersections of the space inside the cylinder and above the lower plane below the upper plane. A neutron importance of 1 completes this cell description.

MCNP requires that you define all space, so the *only* remaining geometry to be defined for this example is the outside world, cell 2. The outside world is everything outside the plutonium cylinder. The material number is zero because this cell is a void. Remember, a void has no material density entry. To define the region of space that is the outside world, we need to introduce the union operator.

Grey Box 3. – Intersections and Unions.

Intersections and Unions

The intersection operator in MCNP is simply a blank space between two surface numbers on a cell card. Assume you have two regions of space, A and B. The region of space containing points that belong to both A and B is called the **intersection** of A and B, written A B. The shaded area below represents A B. Because it is a binary Boolean operator, the intersection can be considered multiplicative.

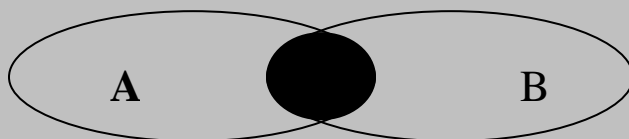

A region containing points belonging to A alone or to B alone or to both A and B is called a **union** of A and B. The union operator is indicated by a colon (:). The shaded region below represents the union of A and B (A:B). Because it is a binary Boolean operator, the union can be considered additive.

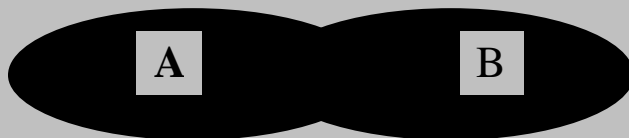

Consider two planes that meet to form two cells. Cell numbers are circled.

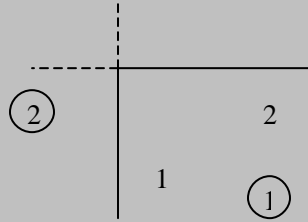

Cell 1 is the region below surface 2, that is, with a negative sense, that is also in common with (intersected with) everything to the right of surface 1, that is, with a positive sense. Therefore, the surfaces defining cell 1 are written 1-2. Cell two is everything to the left (negative sense) of surface 1 plus everything above (positive sense) surface 2. Therefore, the surfaces defining cell 2 are written -1:2. Cells 1 and 2 are illustrated below.

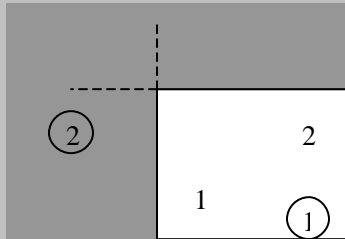

If cell 2 were specified as -1 2, that would be the space to the left of surface 1 that is in common with the space above surface 2, illustrated below.

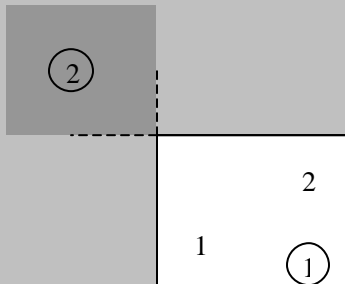

The **union** operator is what we use to define the "rest of the world" in configuration 1. Therefore, the sense of the surfaces in cell 2 is opposite to those defining cell 1 and the Boolean intersection operator is replaced by the **union**, 1: -2 : 3. Figure 2 4 illustrates the format of the cell 2 card in this example. The cell is assigned an importance

of zero. Any particles entering cell 2 need to be terminated immediately because once particles leave the cylinder they have no chance of returning.

2.3.B Alternate Geometry Description – Macrobody

Another way to describe the same geometry is to use a pre-existing 3D object known as a macrobody. MCNP contains a variety of macrobodies: boxes, parallelepipeds, right circular cylinders (also known as cans), etc. A comprehensive list is found in Appendix F of this Criticality Primer and in Chapter 3 of the MCNP Manual. Using macrobodies can often simplify the geometric description of a problem. For this example, a right circular cylinder (rcc) can be used to replace the infinite cylinder and two bounding planes. The input required for a rcc card is as follows:

```
RCC Vx Vy Vz Hx Hy Hz R
      where Vx Vy Vz = center of base
            Hx Hy Hz = cylinder axis vector
            R = radius
```

In this example, cell and surface cards should appear as:

Example 2-3. Bare Pu Cylinder - Macrobody

```
C      Cell Cards
100    1 -15.8      -10 imp:n=1
101    0              10 imp:n=0

C      Surface Cards
10     rcc 0 0 0    0 0 17.273    4.935
```

In this example, there is a numerical scheme to help the user read the input deck. Cells are numbered above 100, surfaces from 10-99, and materials between 1 and 9. This prevents confusing which numbers correspond to which surfaces, cells or materials. While the numbering scheme may change, due to the different number of cells, surfaces or materials present, it can be a useful tool when creating input decks.

Running this geometric description will result in identical results to the description using the cz, and pz cards.

2.3.C Materials

Now that the geometry of the system is defined, we need to identify the material. This example requires only plutonium-239, which has an atomic number of 94 and an atomic weight of 239. Figure 25 shows the material card required. The procedure to define a material was described in the first chapter. The only thing new is the use of an atom fraction for the plutonium. Material 1 is 100 percent plutonium-239, so the atom fraction is 1. The extension .66c will be used.

```

C      Data Cards
C      Material Data Cards
m1    94239.66c 1.0

```

Figure 2-5. Example 2.3 material specification

2.3.D MCNP Criticality Controls

A `kcode` card is required to run a criticality calculation. We will specify 5000 neutrons per cycle, an initial guess for k_{eff} of 1.0, 50 cycles will be skipped, and a total of 250 cycles will be run. For this example, a single fission source point is placed near the center of the plutonium cylinder using the `ksrc` card. Figure 2-6 shows these two cards for this problem.

```

C      Criticality Control Cards
kcode 5000 1.0 50 250
ksrc 0 0 8.6

```

Figure 2-6. Example 2.3 Criticality control cards.

A criticality source is different from a fixed source because the fission source locations change from cycle to cycle. A cycle is the completion of the number of histories requested by the first entry on the `kcode` card. The initial `ksrc` source is used only for the first k_{eff} cycle. A new spatial fission source is generated during each cycle and is used as the source for the next cycle.

2.3.E Example 2.3 MCNP Input File

The input required for this example problem is complete. Do not forget the required blank line delimiters between sections when entering this information. After entering the data, your input file should appear as follows:

Example 2-3. Bare Pu Cylinder

```

C      Cell Cards
1      1 -15.8      -1 2 -3  imp:n=1
2      0                        1:-2:3 imp:n=0

C      Surface Cards
1      cz  4.935
2      pz  0
3      pz 17.273

C      Data Cards
C      Material Data Cards
m1      94239.66c 1.0
C      Criticality Control Cards
kcode 5000 1.0 50 250
ksrc 0 0 8.6

```

The problem can be run by typing...

mcnp5 inp=file1 out=file2 runtpe=file3

where *inp*, *outp*, and *runtpe* are the default names for the input file, the output file, and the binary results file, respectively. The *runtpe* file is useful for plotting problem results and for continuing a calculation as discussed in later chapters of the Primer. The *name* option is useful for automatically naming files. It uses the *inp* name as the base and appends the appropriate letter (o for *outp* and r for *runtpe*).

```
mcnp5 name=ex23
```

produces an *outp* file named *ex23o*, a *runtpe* file *ex23r*, and a source file *ex23s*.

2.3.F Output

At this time we are only interested in looking at the k_{eff} result in the output. Recall from the first chapter that there is a good deal of information to be skipped to find

```
final estimated combined collision/absorption/track-length
keff.
```

Your result should be close to 1.01. The result on a Windows 2000 Pentium 4 computer with the ENDF66c data library at LANL was 1.01403 with an estimated standard deviation of 0.00066 (1σ). If your result is not close to ours, check your input to make

sure your surface dimensions are correct and that material densities are correctly entered on the cell cards.

2.4 EXAMPLE 2.4: PU CYLINDER, RADIAL U REFLECTOR

The second problem in this chapter takes example 2.3 and adds a radial natural uranium reflector. This example introduces how to define cells within cells.

Natural Uranium Radial Reflector

$$\rho = 18.80 \text{ g/cc}$$

Configuration II. *Plutonium Metal, Radially Reflected by Uranium*

Plutonium cylinder:	Radius = 4.935 cm
	Height = 6.909 cm

Uranium reflector thickness:	5.0 cm
Uranium reflector height:	6.909 cm

2.4.A Geometry

The setup process is the same as for example 2.3. Surface cards will be defined first and then used to create the cell cards. Figure 2-7 shows the geometry setup for example 2.4. (Note that the cylinder has been changed to be symmetric about the x-axis.)

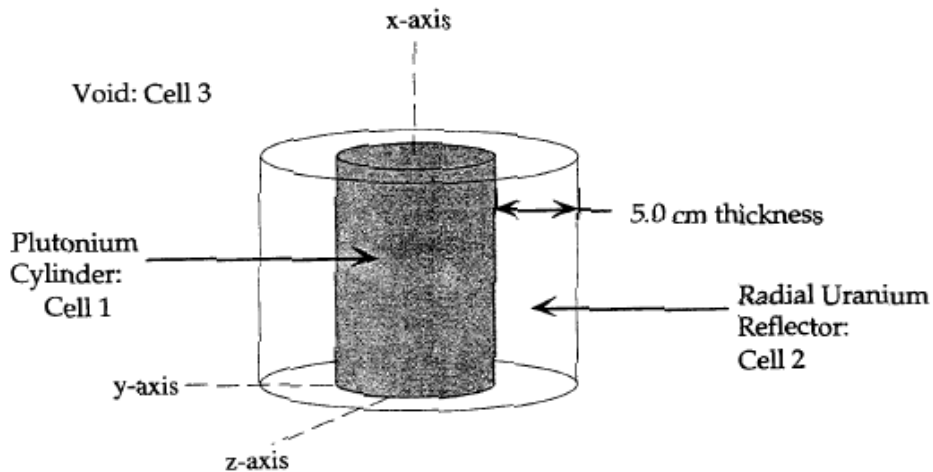

Figure 2-7. Configuration 2 geometry.

Surfaces

Before continuing, try to create the surface cards for this configuration on your own and check them with Figure 2-8. If you encounter difficulty, read the surface card description that follows.

Beginning with the plutonium cylinder, the problem description specifies a radius of 4.935 *cm* (the same as configuration 1). This time a cylinder on the *x*-axis, *cx*, will be used as surface 1. Two planes perpendicular to the *x*-axis, *px*, are needed to give the cylinder a finite height of 6.909 *cm*. Surfaces 2 and 3 are chosen so that the distance between them is 6.909 *cm*.

Another cylinder must be defined for a radial uranium reflector that has a thickness of 5 *cm*. A second cylinder on the *x*-axis, *cx*, with a radius of 4.935 *cm* + 5.0 *cm* = 9.935 *cm* is used. Because there is no reflection on the top or bottom of this system, the reflector region is the same height as the plutonium cell, so we can use the two planes already defined (surfaces 2 and 3) to make the reflector finite in height, Figure 2-8 shows the surface cards required for this example. The \$ is used to include comments on cards as appropriate.

C	Surface Cards		
1	<i>cx</i>	4.935	\$ Pu cylinder
2	<i>px</i>	0	\$ bottom
3	<i>px</i>	6.909	\$ top
4	<i>cx</i>	9.935	\$ U reflector

Figure 2-8. Configuration 2 surface cards.

Cells

The four surfaces now can be used to build the plutonium and uranium cells. Figure 2-9 shows the cell cards for this example. We call the plutonium cylinder cell 1, assign it material 1 with a material density entered with a negative sign indicating *g/cc*. The intersection operator is used to combine the surfaces. An importance of 1 is assigned to this cell.

We call the uranium reflector cell 2 and assign it material number 2. The material density, 18.80 *g/cc* is entered with a negative sign indicating *g/cc*. Next, we enter the bounding surfaces using the **intersection** operator. Recalling the rules of surface sense, the reflector is the space outside surface 1 (positive sense) **and** the space inside surface 4 (negative sense) ~ the space between surfaces 2 and 3, 1-4 2 -3. The importance of this cell is 1.

The last cell is the outside world. As in configuration 1, we use the **union** operator. Cell 3 is all space outside surface 4 **or** below surface 2 **or** above surface 3. The union of these surfaces, 4:-2:3, defines cell 3. Our outside world is now all space except the plutonium and uranium. An importance of zero is assigned to this cell, terminating any neutrons entering this region. The cell cards required for configuration 2 are complete.

```

C      Cell Cards
1      1  -15.8      -1  2  -3      imp:n=1
2      2  -18.8      1  -4  2  -3      imp:n=1
3      0              4:-2:3      imp:n=0
    
```

Figure 2-9. Example 2.4 cell cards.

2.4.B Alternate Geometry Description – Macrobody

In this example, macrobodies can be used to replace both the inner and outer cylinders, even though their bounding planes are the same. The cell and surface cards for the above example can be written with macrobodies in the following way:

Example 2.4, Pu cyl, radial U(nat) reflector -Macrobody

```

C      Cell Cards
1      1  -15.8      -1      imp:n=1
2      2  -18.8      1  -2      imp:n=1
3      0              2      imp:n=0

C      Surface Cards
1      rcc  0  0  0  6.909  0  0  4.935  $ Pu cylinder
2      rcc  0  0  0  6.909  0  0  9.935  $ U reflector
    
```

2.4.C Materials

Configuration 2 requires **two** materials, plutonium and natural uranium. Figure 2-10 shows the material cards for this example. Material 1, plutonium-239, is the same as in configuration 1. For the reflector we have natural uranium, which consists of U-235 and U-238. These isotopes will be entered as atom fractions. U238 is the first isotope entered. The atomic number of uranium is 92 and 238 represents the 238 isotope. The atom percent is taken from the Chart of the Nuclides. The U-235 isotope is entered in the same manner. For all three ZAIDs, the .66c library extension is the most current and applicable at the time of printing.

```

C      Data Cards
C      Material Data Cards
m1     94239.66c 1.0
m2     92238.66c 0.992745 92235.66c 0.007200
    
```

Figure 2-10. Example 2.4 materials cards.

Grey Box 4. – Normalization of Atom Fractions.**Normalization of Atom Fractions**

The atom fractions of the two uranium isotopes do not add exactly to 1.00. When this occurs, MCNP renormalizes the values. For example, if you have trace elements in a material that you do not include in the material card, the atom fractions will not add up to exactly 1.0. MCNP will then add up the specific fractions and renormalize them to sum to 1.0. A WARNING message informs you that the fractions did not add either to one or to the density on the cell card.

2.4.D MCNP Criticality Controls

The entries on the required `kcode` card do not change from example 2-3. Because we made the cylinder shorter, we will move the initial source point closer to the center of the cylinder at 3.5 cm on the x-axis. Figure 2-11 shows the criticality controls for this example.

```

C      Criticality Control Cards
kcode 5000 1.0 50 250
ksrc  3.5  0  0

```

Figure 2-11. Example 2.4 criticality control cards.

2.4.E Example 2.4 MCNP Input File

The input for this problem is complete. Double check your input for entry errors and do not forget the blank-line delimiters between sections. After you have entered this information, the input file should appear as follows

Example 2-4, Pu cylinder, radial U(nat) reflector

```

C      Cell Cards
1      1  -15.8      -1  2  -3      imp:n=1
2      2  -18.8      1  -4  2  -3  imp:n=1
3      0              4:-2:3      imp:n=0

```

```

C      Surface Cards
1      cx   4.935    $ Pu Cylinder
2      px   0.0     $ bottom
3      px   6.909    $ top
4      cx   9.935    $ U reflector

```

```

C      Data Cards

```

```

C      Material Data Cards

```

```

m1     94239.66c 1.0

```

```

m2     92238.66c 0.992745 92235.66c 0.007200

```

```

C      Criticality Control Cards

```

```

kcode  5000 1.0 50 250

```

```

ksrc   3.5  0  0

```

2.4.F Output

Scan through the output and find the...

```

final estimated combined collision/absorption/track-length keff.

```

Your result should be subcritical. The radial reflector is not sufficient to give you a critical mass for this configuration. The result on a Windows 2000 Pentium 4 computer with the ENDF66c data library at LANL was 0.88367 with an estimated standard deviation of 0.00052 (1σ). If your result is not close to ours, check your input to make sure your surface dimensions are correct, and check the material densities in the cell cards. If the run was successful, continue on to configuration 3.

2.5 EXAMPLE 2.5: PU CYLINDER, U REFLECTOR

In this third example we show how to use the Boolean complement operator, #. Example 2.5 is the same as example 2.4 with an axial reflector added.

MCNP Criticality Primer II

```
C      Surface Cards
1      cx      4.935
2      px      0
3      px      6.909
4      cx      9.935
5      px      -5.0
6      px      11.909
```

Figure 2-13. Example 2.5 surface cards.

Cells

Because the plutonium cylinder is the same size as in the other two configurations, cell 1 does not change. Cell 2 will be defined differently in configuration 3 than it as in example 2.4: we will use the Boolean complement operator, #.

Grey Box 5. – Complement Operator (#).

Complement Operator (#)

The complement operator, #, is a short-hand cell-specifying method that implicitly uses the intersection and union operators. It can be thought of as saying “not in.” For example, let’s look at the cell cards for configuration 1 again.

```
C      Cell Cards
1      1  -15.8          -1 2  -3  imp:n=1
2      0                  1:-2:3  imp:n=0
```

Cell 2 defines the outside world using the union of three surfaces (1:-2:3). Cell 2 also could be specified using the complement operator. The outside world is everything except cell 1, so we can define cell 2 as all space that is “not in” cell 1, or #1.

```
C      Cell Cards
1      1  -15.8          -1 2  -3  imp:n=1
2      0                  #1      imp:n=0
```

In this simple example the complement operator changes intersections to unions and reverses the sense of the surfaces of cell 1. Note that the # operates on cell numbers, not surface numbers. Also note that while the complement operator is a shortened notation in the input deck, each operator is fully expanded at run-time in the code, thus the shorthand cannot be used to circumvent memory shortage problems. The fully-expanded version is inefficient and will slow down the code.

Returning to example 2.5, we can define cell 2 as the region of space inside surface 4 **and** below surface 6 **and** above surface 5, that is “not in” cell 1, -4 -6 5 #1. This

method may be easier than defining cell 2 explicitly, -4 -6 5 (1: -2 :3). However, in more complicated problems, using the complement operator can cause the run time to increase significantly. Figure 2-14 shows the cell cards for example 2.5.

```

C      Cell Cards
1      1      -15.8  -1  2  -3      imp:n=1
2      2      -18.8  -4  -6  5  #1  imp:n=1
3      0              4:-5:6      imp:n=0
    
```

Figure 2-14. Example 2.5 cell cards.

2.5.B Materials

There is no change in the material cards from example 2.4. Figure 2-15 shows the m cards used in example 2.5.

```

C      Data Cards
C      Material Data Cards
m1     94239.66c 1.0
m2     92238.66c 0.992745 92235.66c 0.007200
    
```

Figure 2-15. Example 2.5 material cards.

2.5.C MCNP Criticality Controls

The kcode and ksrc cards are not changed from example 2.4. Figure 2-16 shows the controls used in example 2.5.

```

C      Criticality Control Cards
kcode  5000 1.0 50 250
ksrc   3.5 0 0
    
```

Figure 2-16. Example 2.5 criticality control cards.

2.5.D Example 2.5 MCNP Input File

The input for example 2.5 is complete and should appear as follows. Do not forget the blank line delimiters at the end of sections.

Example 2-5. Pu cylinder, radial U(nat) reflector

```

C      Cell Cards
1      1  -15.8      -1  2  -3      imp:n=1
2      2  -18.8      -4  -6  5 #1  imp:n=1
3      0              4:-5:6      imp:n=0

C      Surface Cards
1      cx  4.935
2      px  0.0
3      px  6.909
4      cx  9.935
5      px -5.0
6      px 11.909

C      Data Cards
C      Material Data Cards
m1     94239.66c 1.0
m2     92238.66c 0.992745 92235.66c 0.007200
C      Criticality Control Cards
kcode  5000 1.0 50 250
ksrc   3.5 0 0

```

2.5.E Output

Scan through the output file and find the text:

```
final estimated combined collision/absorption/track-length keff.
```

Your result should be close to 1.02. The result on a Windows 2000 Pentium 4 computer with the ENDF66c data library at LANL was 1.02486 with an estimated standard deviation of 0.00066 (1σ). These results are the same no matter which geometry description you use.

2.6 SUMMARY

This chapter presented you with three examples designed to teach the basic geometry concepts and Boolean geometry operations used to define cells. We discussed the sense of surfaces and the union, intersection, and complement operators. You have also learned how to model multicell problems. The information presented in this chapter will help you to model the more complex problems presented in the following chapters

Chapter 3: S(a,b) Thermal Neutron Scattering Laws for Moderators

This chapter presents the use of $S(\alpha,\beta)$ thermal neutron scattering laws for use with problems containing hydrogenous and other moderating material. It also demonstrates how to handle a void region that is not defined as the “rest of the world.” An explanation of the basic features of the MCNP & output is provided.

3.1 WHAT YOU WILL BE ABLE TO DO:

- 1) Use and understand $S(\alpha,\beta)$ thermal neutron scattering laws.
- 2) Understand the order of geometry operations on cell cards.
- 3) See effects of $S(\alpha,\beta)$ treatment.
- 4) Interpret k_{eff} output.

3.2 S(a,b) THERMAL NEUTRON SCATTERING LAWS

Let's begin with a description of why we use $S(\alpha,\beta)$ scattering laws. When the neutron energy drops below a few eV, the thermal motion of scattering nuclei strongly affects collisions. The simplest model to account for this effect is the free gas model that assumes the nuclei are present in the form of a monatomic gas. This is the MCNP default for thermal neutron interactions. In reality, most nuclei will be present as components of molecules in liquids or solids. For bound nuclei, energy can be stored in vibrations and rotations. The binding of individual nuclei will affect the interaction between thermal neutrons and that material. The $S(\alpha,\beta)$ scattering laws are used to account for the bound effects of the nuclei. It is important to recognize that the binding effects for hydrogen in water are different than for hydrogen in polyethylene. MCNP has different $S(\alpha,\beta)$ data for hydrogen, as well as other elements. See Appendix D of this Primer to see what materials have available neutron scattering law data.

3.3 PROBLEM DESCRIPTION

This example is a bare (unreflected) UO_2F_2 solution cylinder (LA-10860 p.32). The weight percent of ^{235}U in the uranium is 4.89 %. The solution has a radius of 20.12 cm and a height of 100.0 cm. An aluminum tank with a thickness of 0.1587 cm on the sides and bottom, and a height of 110.0 cm contains the solution. There is no lid on the tank. The region from the top of the solution to the top of the aluminum tank is void. The data for this problem follows:

3.4 EXAMPLE 3.4: BARE UO_2F_2 SOLUTION CYLINDER

3.4.A Geometry

Figure 3-1 shows the geometry for this example.

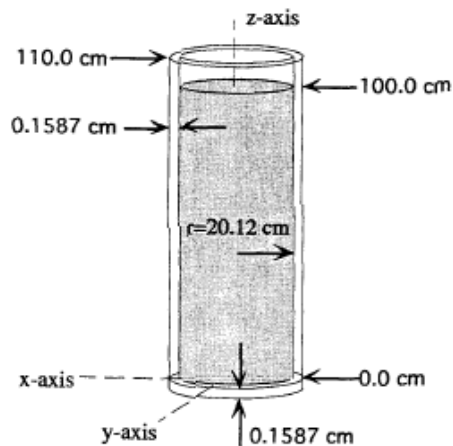

Figure 3-1. Example 3.4 geometry.

Surfaces

This example again uses cylinders and planes to construct the model. We want to look at how these surfaces are arranged. On your own, try to define the surfaces using what you have learned. Refer to the problem description for the dimensions of the problem. So your problem matches ours, set up your cylinders and planes on the z-axis with the bottom plane (surface 6) of the aluminum container at $z = -0.1587$. Once you are finished, the surface cards should be similar to those in Figure 3-2. Figure 3-3 shows a diagram of the tank with the surfaces and cells labeled.

C	Surface Cards
1	cz 20.12
2	cz 20.2787
3	pz 0.0
4	pz 100.0
5	pz 110.0
6	pz -0.1587

Figure 3-2. Example 3.4 surface cards.

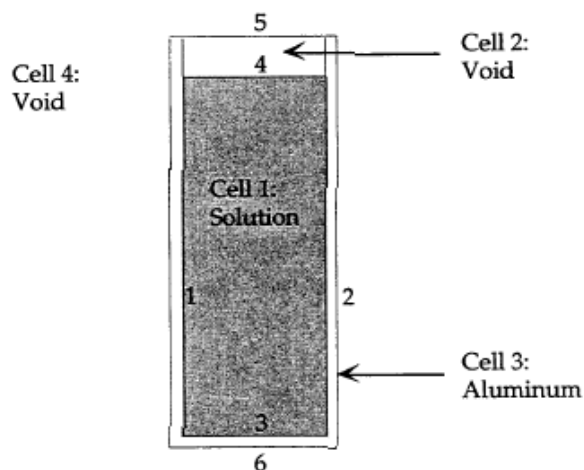

Figure 3-3. Example 3.4 cells and surfaces.

Cells

The cell card section begins with the problem title card,

Example 3-4. S (alpha, beta) Treatment.

Cell 1 contains material 1 (the uranium solution) and is assigned a neutron importance of 1. It is everything inside the cylinder (surface 1), **and** above the plane at 0.0 (surface 3), **and** below the plane at 100.0 (surface 4); i.e., -1 3 -4.

Cell 2 is the region above the top of the uranium solution and below the top of the aluminum container, described as inside surface 1, and above surface 4, and below surface 5, written as -1 4 -5. This is a void, so the material number is zero. This cell should not be assigned an importance of zero because there is a slight chance of neutrons entering this cell and then returning to the solution by scattering off of the aluminum container. Therefore, it is assigned an importance of 1.

Grey Box 6. – Order of Operations.

Order of Operations

In some problems it may be necessary to use parentheses to group the ordering of geometric operations. The order of operation is the same as the order of operation followed in mathematics, where the union operator is the same as addition and the intersection operator is multiplication. MCNP first clears parentheses, doing intersections before unions, from left to right. For example, if you had three spheres, 1, 2, and 3, and you want the intersection of space inside of surfaces 2 and 3 to be unioned with the space inside of surface 1. For the geometry shown in case 1 below, here are two ways it could be written.

$$-1:-3 -2 \text{ is equivalent to } -1: (-3 -2)$$

These expressions are equivalent because, with or without the parentheses, MCNP will perform the intersection of surfaces 2 and 3 before the union with surface 1.

An example of when parentheses change the evaluation of the expression ...

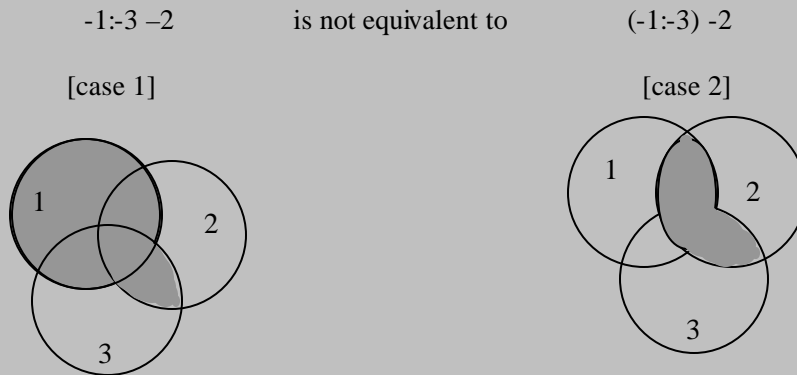

In case 2, the parentheses are cleared first. The space inside surface 1 is added to the space inside surface 3, and that region is intersected with the space inside surface 2. In case 1, the space inside surface 2 is intersected with the space inside surface 3, and that region is added to the space inside surface 1. As illustrated, the parentheses around the union operator create a much different geometry.

Remember, the order of operations is the same as doing simple algebra. Perform operations in parentheses first, doing intersections before unions, from left to right.

Continuing with our example, cell 3 is the aluminum container. You can describe the aluminum container in at least three ways. We show one way here by treating the container as a combination of an aluminum shell plus a bottom disk. The axial region (1 -2 -5 3) is unioned with (or added to) the bottom region of aluminum (-2 - 3 6), written (1

-2 -5 3) : (-2 -3 6). Cell 4 is the “rest of the world” void cell. The union operator is used again to describe everything outside of the solution and aluminum container. The cell cards for this geometry are shown in Figure 3-4.

Example 3-4. S(alpha, beta) Treatment

C	Cell Cards					
1	1	9.6586E-2	-1	3	-4	imp:n=1
2	0		-1	4	-5	imp:n=1
3	2	-2.7	(1	-2	-5 3) : (-2 -3 6)	imp:n=1
4	0		2:5:-6			imp:n=0

Figure 3-4. Example 3.4 Cell Cards.

Grey Box 7. – Alternative Cell 3 Descriptions.

Alternative Cell 3 Descriptions

Convince yourself that the two alternative descriptions of cell 3 that follow are correct.

3	2	-2.7	1	-2	-5	3
5	2	-2.7	-2	-3	6	
or						
3	2	-2.7	(1:-3)	-5	-2	6

3.4.B Alternate Geometry Description- Macrobodyes

As the problem geometry increases in complexity, there become many different ways to specify that geometry in MCNP. One possible combination of macrobodyes is given below.

Example 3-4, UO2F2 Cylinder, S(alpha,beta) Treatment

C	Cell Cards					
1	100	9.6586E-2	-10			imp:n=1
2	0		-20			imp:n=1
3	101	-2.7	10	20	-30	imp:n=1
4	0		30			imp:n=0

C	Surface Cards								
10	rcc	0	0	0	0	0	100.0	20.12	\$ Can of UO2F2
20	rcc	0	0	100	0	0	10.0	20.12	\$ Void gap above UO2F2
30	rcc	0	0	-0.1587	0	0	110.1587	20.2787	\$Exterior of Al can

3.4.C Materials

Material 1 is the uranium solution. The uranium is in the form of UO_2F_2 in water (H_2O), so we have two oxygen concentrations. The two have been combined in this case but can be left separate. The library extensions for these two ZAIDs, .62c, use data from the ENDF/B-VI.8 evaluation, which is the final release of ENDF/B-VI. However, U and Pu isotopes (except for a few minor ones) are unchanged from ENDF/B-VI.6. The MCNP ZAID extension corresponding to these unchanged isotopes is .66c. Following the m1 card is the S(α,β) card (mt1) that specifies that the S(α,β) thermal scattering law for hydrogen are to be applied to material 1. The light water identifier, lwtr, tells the code to apply the S(α,β) treatment to the hydrogen present in material 1 and treat it as if bound in light water instead of as a free gas. {Appendix G of the MCNP manual gives a complete listing of available S(α,β) materials.} The .60t extension indicates that the scattering laws are based on ENDF/B-VI.3.

Aluminum, which has an atomic number of 13 and an atomic weight of 27, is material 2. The partial ZAID is 13027. The atomic weight is always input as three integers so a zero must precede any atomic weight between 10 and 99 while two zeros must precede atomic weights less than 10. Aluminum is the only isotope being used in material 2 so we can enter an atom fraction of 1; 100 percent of the material is aluminum. Figure 3-5 shows the material cards for this problem.

```

C      Data Cards
C      Materials Library Cards
m1    1001.62c 5.7058e-2 8016.62c 3.2929e-2
      9019.62c 4.3996e-3 92238.66c 2.0909e-3
      92235.66c 1.0889e-4
mt1   lwtr.60t
m2    13027.62c 1

```

Figure 3-5. Example 3.4 material cards.

3.4.D MCNP Criticality Controls

The kcode card is identical to the previous examples. On the ksrc card, we will put the source at approximately the center of the solution, or at the coordinates (0, 0, 50.0). Figure 3-4 shows the controls for this example.

```

C      Criticality Control Cards
kcode 5000 1.0 50 250
ksrc  0 0 50.0

```

Figure 3-6. Example 3.4 control cards.

Grey Box 8. – The Criticality Problem Controls.**The Criticality Problem Controls**

The following discussion presents guidelines for performing criticality calculations. Each problem should be examined to assess if these guidelines are appropriate. The Monte Carlo method can exhibit a small bias in the calculated k_{eff} . If at least 5000 (preferably 10,000) neutrons per k_{eff} are used, this bias should not be a factor in MCNP results. The larger the number of neutrons per keff cycle requested in the first entry on the `kcode` card, the smaller the bias. Therefore, it is wise to run as many neutron histories as you can afford, combined with using at least 200 active k_{eff} cycles. Two hundred is a large enough number of active cycles to determine that the problem appears to behave normally and the fission source is converged. At least 30 active cycles are required by MCNP to produce the final table of k_{eff} results. Fewer active cycles do not provide enough information to assess the quality of the calculation. In addition, the creation of confidence intervals not provided by MCNP is more difficult with a smaller number of cycles.

There is no maximum number of cycles that can be calculated. The number of active cycles should not become so large that the estimated standard deviation in the final k_{eff} result becomes much smaller than the very small bias in k_{eff} .

Typically, 200 to 500 active k_{eff} cycles should be acceptable for criticality safety applications.

The initial guess of k_{eff} (the second entry on the `kcode` card) only affects the creation of fission source points for the second k_{eff} cycle. A severe underestimation of the initial guess will result in the creation of too many source points and vice versa. Source points in future cycles are unaffected by the initial guess of k_{eff} .

Enough k_{eff} cycles must be declared to be inactive (the third entry on the `kcode` card) so that the calculated spatial fission source has converged to the fundamental mode. The closer the initial source approximates the shape of the fundamental mode, the fewer cycles you need to skip. Point sources can be specified easily using the `ksrc` card. It is wise to put at least one point into each fissionable region, especially for largely-spaced array elements. Reactor core criticality calculations that have thousands of fuel rods do not require as many initial points because the rods are in close proximity to one another. It is usually best to skip at least 50 k_{eff} cycles for a `ksrc` initial source. The real test to see if enough cycles were skipped is printed in the output file and will be discussed in chapter 8.

A uniform source can be created using the source definition `sdef` card and `may` allow a fewer k_{eff} cycles to be skipped. The best initial source distribution is from an `SRCTP` file from a previous calculation of a similar system. This file is automatically created by MCNP for every criticality calculation. Even fewer k_{eff} cycles usually can be skipped in this case. {See Chapter 2, Section VIII, in the MCNP5 manual for more discussion of these topics.}

3.4.E Example 3.4 MCNP Input File

This completes the input requirements for example 3.4. Your completed input file should resemble the following. Do not forget the blank line delimiters.

```

Example 3-4. UO2F2 Cylinder, S(alpha,beta) Treatment
C      Cell Cards
1      1      9.6586E-2  -1 3 -4      imp:n=1
2      0      -1 4 -5      imp:n=1
3      2      -2.7      (1 -2 -5 3):(-2 -3 6)  imp:n=1
4      0      2:5:-6      imp:n=0

C      Surface Cards
1      cz  20.12
2      cz  20.2787
3      pz  0.0
4      pz  100.0
5      pz  110.0
6      pz  -0.1587

C      Data Cards
C      Materials Library Cards
m1     1001.62c 5.7058e-2  8016.62c 3.2929e-2
      9019.62c 4.3996e-3  92238.66c 2.0909e-3
      92235.66c 1.0889e-4
mt1    lwtr.60t
m2     13027.62c 1

C      Criticality Control Cards
kcode 5000 1.0 50 250

```

ksrc 0 0 50.0

3.4.F Output

After successfully running the problem, you should get a k_{eff} of approximately 1.0. The result on a Windows 2000 Pentium 4 computer with the .62c & .66c data libraries at LANL was 0.99842 with an estimated standard deviation of 0.00077 (1σ). If you run the same problem without the $S(\alpha,\beta)$ treatment you will see a noticeable difference in k_{eff} . The result without the $S(\alpha,\beta)$ treatment on a Windows 2000 Pentium 4 computer with the ENDF66c data library at LANL was 0.97912 with an estimated standard deviation of 0.00083 (1σ). Much larger differences are possible, depending on the problem. For the majority of criticality calculations, it is strongly recommended that the appropriate $S(\alpha,\beta)$ cross sections be used. We want to stress the fact that you must analyze the system you are modeling and decide which method is appropriate for what you are analyzing.

A situation may arise where you would want to use the $S(\alpha,\beta)$ thermal neutron scattering law but the data for that material does not exist. Lucite ($\text{C}_4\text{H}_6\text{O}_2$) is an example. The thermal treatment should be used for this material, but $S(\alpha,\beta)$ thermal neutron scattering law for Lucite does not exist. You can run the problem with the free gas treatment or make an $S(\alpha,\beta)$ substitution on the mt card. Polyethylene or water $S(\alpha,\beta)$ data for hydrogen could be used. $S(\alpha,\beta)$ thermal neutron scattering laws are available for both of these. Polyethylene would probably be the best substitution because both polyethylene and Lucite are linked hydrocarbons and solids. You should run all reasonable options available and choose the most conservative result.

We refer to the use of the $S(\alpha,\beta)$ thermal neutron scattering law for problems at room temperature. While most criticality applications will make use of the room temperature evaluations, there may be a need for cross sections at different temperatures. The MCNP data libraries contain many thermal neutron cross sections at room temperature and higher temperatures, and scattering laws for materials in the temperature range from 20 to 2000 K. {See Appendix G of the MCNP Manual for more information}.

3.5 MCNP K_{eff} OUTPUT

Examine the dashed box on the “*keff results for:*” page. This box will be produced for at least 30 active cycles as long as at least one estimator set of values appears normally distributed at the 68% 95% or 99% confidence level. The final result in the box is the estimated value of k_{eff} using a combination of the three individual estimators along with its estimated standard deviation. Estimated 68%, 95% and 99% confidence intervals are given in the box.

The result of a Monte Carlo criticality calculation (or any other type of Monte Carlo calculation) is a confidence interval. For criticality, this means that the result is not just k_{eff} , but k_{eff} plus and minus some number of estimated standard deviations to form a confidence interval (based on the Central Limit Theorem) in which the true answer is expected to lie a certain fraction of the time. The number of standard deviations used (for example, from a Student's t Table) determines the fraction of the time that the confidence

interval will include the true answer, for a selected confidence level. For example, a valid 99% confidence interval should include the true result 99% of the time. There is always some probability (in this example, 1%) that the true result will lie outside of the confidence interval. To reduce this probability to an acceptable level, either the confidence interval must be increased according to the desired Student's t percentile, or more histories need to be run to get a smaller estimated standard deviation. Running more histories is generally preferable.

The 68%, 95%, and 99% confidence intervals correspond ± 1 , ± 2 and $\pm 2.6 \sigma$ respectively.

Grey Box 9. – Final K_{eff} Estimator Confidence Interval.

Final k_{eff} Estimator Confidence Interval

Calculating k_{eff} consists of estimating the average number of fission neutrons produced in one fission generation per fission neutron born. A fission generation is the life of fission neutrons from birth to death by escape, parasitic capture, or absorption leading to fission. The computational equivalent of a fission generation in MCNP is the k_{eff} cycle. The number of neutrons calculated in each k_{eff} cycle is specified by the first entry on the `kcode` card. As these fission neutrons are born, transported, and terminated in a k_{eff} cycle, the fission source points are created for the next k_{eff} cycle. It is essential that enough k_{eff} values are accumulated so that the fission source distribution has converged to the fundamental mode. A poorer initial spatial distribution requires that more k_{eff} cycles be skipped before convergence is achieved.

MCNP uses three different methods for calculating k_{eff} from each neutron random walk in a cycle: absorption, collision, and track length. {See Chapter 2, Section VIII, of the MCNP manual for more details.} Because no one k_{eff} estimator is optimal for all problems, MCNP uses a statistical combination of all three to provide a combined k_{eff} estimate. In general, the combined k_{eff} estimate is the best one to use and is the result enclosed in the dashed box in the output. Always examine all the k_{eff} results on the k_{eff} results page.

The combined k_{eff} estimate is usually between the extreme k_{eff} values. Occasionally when the three k_{eff} estimators are highly positively correlated, the combined k_{eff} estimate will lie outside the extreme values. This behavior is expected because if one k_{eff} estimator is above the precise k_{eff} result, the others are likely also to be above that result because of the positive correlation. The reverse is also true. It is extremely important to emphasize that the k_{eff} result from a Monte Carlo criticality calculation is a confidence interval for k_{eff} that is formed by adding and subtracting a multiple of the final *estimated* standard deviation from the final *estimated* k_{eff} . A properly formed confidence interval from a valid calculation should include the precise k_{eff} result the fraction of the time used to create the confidence interval. There will always be some probability that the precise result lies outside of the confidence interval. MCNP provides the *estimated* final k_{eff} confidence intervals at the 68%, 95% and 99% levels when at least 30 active k_{eff} cycles have been calculated. {Further discussion on many aspects of k_{eff} confidence intervals are described in the MCNP manual, Chapter 2 Section VIII.}

Returning to our problem, examine the first three lines after the title card on the "keff results for :" page. The first line describes the initial source used. The second line provides information about the criticality problem defined on the `kcode` card. The third line shows what was actually run for this problem.

the initial fission neutron source distribution used the 1 source points that were input on the `ksrc` card.

MCNP Criticality Primer II

the criticality problem was scheduled to skip 50 cycles and run a total of 250 cycles with nominally 5000 neutrons per cycle.

this problem has run 50 inactive cycles with 250291 neutron histories and 200 active cycles with 999870 neutron histories.

Continuing on, the fourth line tells you if the problem finished. The fifth line is extremely important because it states whether or not all cells containing fissionable material were sampled. If all the cells containing fissionable material were not sampled, a warning message will be printed with a list of the cells that were not sampled. Such a calculation should probably be rerun with more settling cycles, and/or a different initial spatial source distribution to ensure sampling of all cells with fissionable material.

this calculation has completed the requested number of keff cycles using a total of 1250161 fission neutron source histories.

all cells with fissionable material were sampled and had fission neutron source points.

The next part of the output describes the results of the normality checks for each of the three k_{eff} estimators. The number of neutrons per cycle is usually large enough so that the individual k_{eff} estimators will appear to be distributed as though they were sampled from a normal distribution. MCNP checks to see if the k_{eff} values appear to be normally distributed, fit at the 68%, then 95% confidence level, and, if not, then at the 99% confidence interval. A WARNING is printed if an estimator appears not to be normally distributed at the 99% level. This situation is equivalent to a 99% confidence interval not including the precise answer, which will occur 1% of the time.

It is unlikely that all three of the k_{eff} estimators will not appear normally distributed at the same time. MCNP will not print the dashed box results in this case, although the results are available elsewhere in the output. Additional information is supplied in the output to assist the user in determining the cause of this behavior. One situation that can cause this behavior to occur is when the fission neutron source has not converged. Even when all three sets of k_{eff} data appear not to be normally distributed, it is still possible that each of the three *average* k_{eff} results would be normally distributed if many independent calculations were made. The user is cautioned to examine the problem output carefully to assess the possible cause(s) for the nonnormal behavior. Additional independent calculations can be made, if necessary, using the dbcn card. {See Chapter 3 and Chapter 5 of the MCNP manual for more information.}

Grey Box 10. – Continuing a Calculation from RUNTPE and Customizing the OUTP File.**Continuing a Calculation from RUNTPE and Customizing the OUTP File**

An MCNP calculation can be continued for more k_{eff} cycles by using the RUNTPE file that is generated automatically for all problems. RUNTPE contains all of the problem information and the calculated results, including the fission source point information for the next cycle. The input file for a continued run requires only the following two cards:

```
continue
kcode      5000 1.0 50 400
```

The first three entries on the kcode card are ignored. The fourth entry sets a new upper limit to the total number of active cycles to be run in the calculation. Runs can be continued to any number of active cycles for the calculation. Runs can be continued any number of times. The MCNP execution line for a continue run is:

```
mcnp c inp=filename1 runtpe=filename2
```

Where filename1 is the input file shown above and filename2 is the name of the RUNTPE file. If you lose the output file from a calculation, it can be regenerated from the RUNTPE with the following continuation input file:

```
continue
nps -1
```

The length of the OUTP file can be controlled by the print card. A print card followed by no entries provides all of the MCNP output possible. Numerical entries can include or exclude selected print table numbers from the output. {See Chapter 3 of the MCNP manual.}

3.6 SUMMARY

After completing the first three chapters of this Primer you should be able to model successfully any simple system that does not involve repeated structures or arrays. After running a problem you should be able to determine from the output whether or not the run was successful.

The main objective of this chapter was to demonstrate and show the effects of $S(\alpha,\beta)$ thermal neutron scattering laws. In the field of criticality safety, in thermal neutron cases the appropriate $S(\alpha,\beta)$ scattering laws should be used, but it is up to the user to determine which set of scattering laws will give the best analysis of the problem. When possible, multiple runs should be made to understand the system and to know what is driving the system. Remember, the $S(\alpha,\beta)$ thermal neutron scattering laws used in this chapter are at room temperature. If needed, other temperatures neutron cross sections are provided in the MCNP cross section library.

This chapter gave a description of some of the statistical output features of MCNP for criticality purposes that helps the user to determine if a run is statistically a success or if it should be rerun.

Chapter 4: Simple Repeated Structures

This chapter is designed to introduce the repeated structure capability of MCNP. A cell can be defined in one location and easily be repeated at different locations with different properties, if desired. Square and triangular lattice arrays are described in later chapters.

4.1 WHAT YOU WILL BE ABLE TO DO

- 1) Use the universe (u) and fill cards.
- 2) Use the like m but card.
- 3) Use the trcl card.
- 4) Use the 2-D color geometry plotting capability.

4.2 PROBLEM DESCRIPTION

This example consists of two identical U(93.4)O₂F₂ solution cylinders inside a water tank (LA-10860 p. 123). Assume the water reflector density is 1 g/cc and has a minimum thickness of 20 cm except on one side of the first cylinder where the thickness is only 10 cm. The height of the water is at the top of the open aluminum containers. The data for this problem is:

Uranium Solution

$$N_{235} = 1.1760e-3 \text{ (0.48 g/cc)}$$

$$N_{238} = 8.2051e-5$$

$$N_{\text{Oxygen}} = 3.3621e-2$$

$$N_{\text{Hydrogen}} = 6.2210e-2$$

$$N_{\text{Fluorine}} = 2.5161e-3$$

$$N_{\text{Total}} = 9.9605e-2$$

$$\text{Solution height} = 70.2 \text{ cm}$$

$$\text{Diameter} = 12.7 \text{ cm}$$

Aluminum Container

$$\rho = 2.7 \text{ g/cc}$$

$$\text{Height} = 80.0 \text{ cm}$$

$$\text{Surface separation} = 4.0 \text{ cm}$$

$$\text{Inner diameter} = 12.7 \text{ cm}$$

$$\text{Thickness} = 0.15 \text{ cm}$$

4.3 EXAMPLE 4.3: REPEATED STRUCTURES, 2 CYLINDERS

4.3.A Geometry

Figure 4-1 shows the geometry setup for this example.

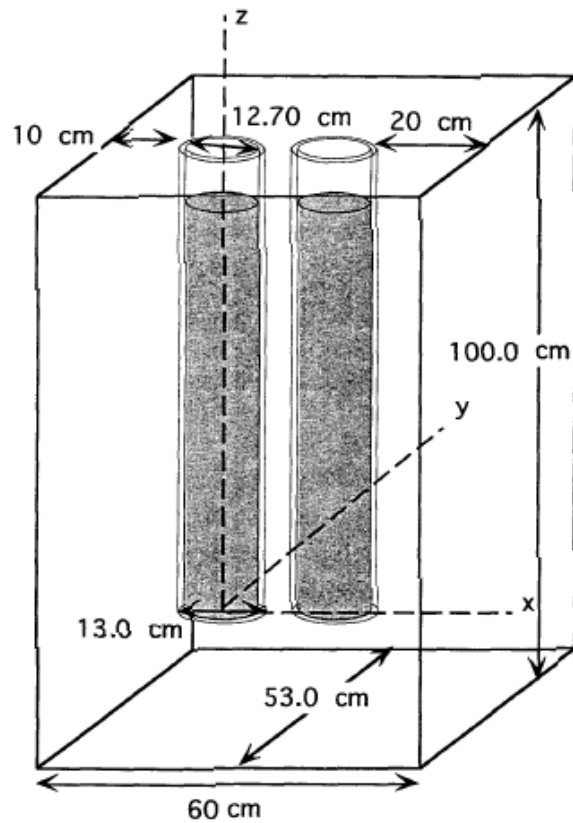

Figure 4-1. Example 4 geometry.

Surfaces

The focus of this chapter is repeated structures so we will define and use surfaces to create one solution cylinder. This solution cylinder, shown in Figure 4-2, requires six surfaces (four planes and two cylinders). We will repeat the first cylinder to form the second cylinder using the `like m but` command. Figure 4-3 shows all the surfaces used in example 4. The first six surfaces are used for the cylinder and the last five are used for the water reflector description.

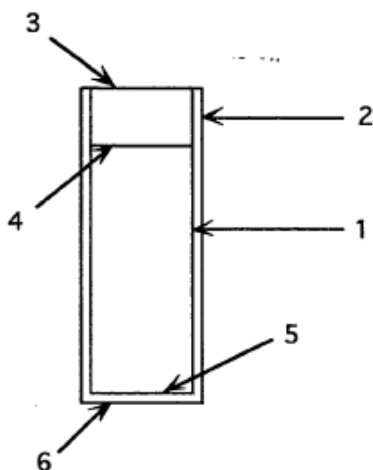

Figure 4-2. Solution cylinder surfaces.

```

C Surface Cards
1  cz 6.35 $ Solution radius
2  cz 6.50
3  pz 80.0 $ Top of container
4  pz 70.2 $ Top of solution
5  pz 0.0
6  pz -0.15
7  pz -20.15 $ Bottom of tank
C Sides of tank
8  px -16.5
9  px 43.5
10 py -26.5
11 py 26.5
    
```

Figure 4-3. Example 4.3 surface cards.

Cells

We begin the input file in Figure 4-4 with the title card for the problem: Example 4, Repeated structures, Two Cylinders. The problem description tells us we have two identical solution cylinders. Both solution cylinders will be defined with the use of like `m` but card and universe (`u`) and `fill` cards. Cells 1, 2, and 3, the uranium solution, void region above the uranium solution, and aluminum container, respectively, will be defined as part of the same universe.

Grey Box 11. – The Universe Concept.**The Universe Concept**

A universe is either a lattice or an arbitrary collection of cells that, once defined, can be used to fill other cells within a geometry. Another way to think of it is to look out a window at the sky. You can see part of the sky but not all of it because the window edges limit your view. There is essentially an infinite amount of sky but you are limited to what the window allows you to see. The window is the filled cell and the sky is the universe that fills the cell.

In this chapter the universe will be a collection of cells. In other words, several cells will be defined to be in a universe and another cell will be filled with that universe. (Lattices will be explained in later chapters of the primer.)

Recalling the card format from Chapter 1, the universe card is entered in the `params` section of the cell card. Universe numbers are arbitrary integers chosen by the user. There is one rule when using universes.

1. The cell of a universe can be finite or infinite but must completely fill all of the space within the cell that the universe is specified to fill.

If you want to model several open canisters that are half-filled with a solution, such as example 4, the `u` and `fill` cards make this easy. With the two rules stated above in mind, let's create an open cylinder partially filled with solution as a universe. We will use the surfaces already defined in Figure 4-3. The solution, aluminum canister, and void region above the solution will be defined as universe 3. These three cells are analogous to the sky that we use to fill the window. The first cell of universe 3 is the uranium solution. The solution includes all points that have a negative sense with respect to surface 1 intersected with the negative sense of surface 4, and intersected with the positive sense of surface 5.

```
1 1 9.9605e-2 -1 -4 5 u=3 imp:n=1
```

Cell 1 contains material 1, has an atom density of 9.960e-2, is part of universe 3, and has a neutron importance of 1.

Cell 2 is the void region above the solution. The void includes all points that have a negative sense with respect to surface 1 intersected with the positive sense of surface 4, making it infinite in height. The neutron importance is set to 1 because there is a chance that neutrons could be scattered through this void and into the solution.

```
2 0 -1 4 u=3 imp:n=1
```

MCNP Criticality Primer II

Cell 3, the aluminum container, is a union of all points that have a positive sense with respect to surface 1 and a negative sense to surface 5, thus making it infinite outside of surface 1 or below surface 5.

```
3 2 -2.7 1:-5 u=3 imp:n=1
```

The specification of the cells in universe 3 is complete. All of the outer cells are infinite (analogous to the sky), so we will not violate rule 1 stated earlier. After defining these three cells, the geometry in universe 3 is as follows, with the void and aluminum extending to infinity.

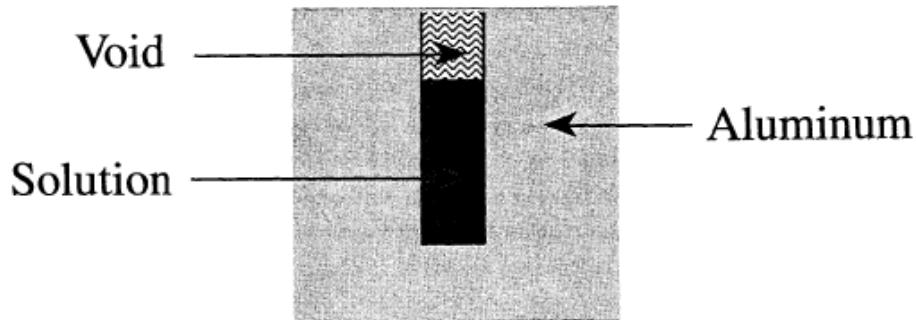

We now create cell 4, the window that is filled with universe 3. Cell 4 is defined a finite cylinder with the desired radius and height (window size).

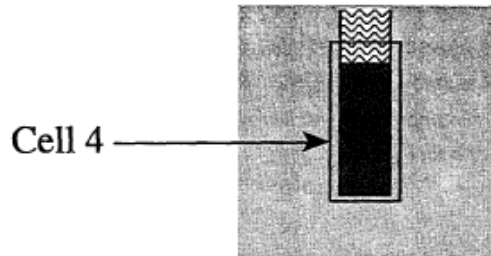

The cell 4 material number is zero because the materials have been specified in the cells in universe 3. When cell 4 is filled by universe 3, one solution cylinder has been defined as the problem description required.

```
4 0 -2 -3 6 fill=3 imp:n=1
```

Now that we have one of the solution cylinders defined, the second one can be defined using the repeated structures capability of MCNP. A cell can be defined once and

repeated many times using the `like m but` construct. This feature reduces the amount of input required from the user. In this example we will use the `like m but` feature to make the second cylinder. The format of the `like m but` card follows.

```
J like m but list

j = cell number.
like = keyword for cell to be repeated.
m = a previously defined cell number that is to be
repeated.
but = keyword for differences between cells m and j .
list = specifications that define the differences
between cells m and j .
```

Most of the data cards can be included in the `list` specification {see Chapter 3 of the MCNP manual for a complete listing of cards available}. For this example we will use the `trcl` specification that describes the relation of the origin of one cell to the origin of another.

```
trcl = 01 02 03
```

The first three entries are the x, y, z values of the origin of translated cell. {See Chapter 3 of the MCNP manual.}

Grey Box 12. – Simple `like m but trcl` Example.

Simple `like m but trcl` Example

Assume we have defined cell 1 as a sphere with its origin at (0, 0, 0). Cell 2 is identical to cell 1 but it is located 10 cm to the left and 20 cm above cell 1 making the cell 2 origin (-10 0 20). Cell 2, using the `like m but` card, is defined as follows. The parentheses are required.

```
2 like 1 but trcl (-10 0 20)
```

Now let's continue with example 4.3. After defining the first solution cylinder, cell 4, using the `u` and `fill` cards, we want to create a second, identical solution cylinder with the `like m but` card, cell 5, and translate it along the x-axis with the `trcl` mnemonic so that the surface separation between the aluminum tanks is 4.0 cm. A cell is translated relative to the coordinates of its origin. The origin of the cell being repeated is (0, 0, 0). The center-to-center spacing of the two solution cylinders is 17 cm. By simply translating the origin of cell 4, filled with universe 3, a second, identical solution cylinder is defined. The cell 5 description follows.

```
5 like 4 but trcl (17 0 0)
```

The cell cards are completed by defining the water reflector around the two solution cylinders, cell 6, and the "rest of the world" region outside the water reflector, cell 7. Your knowledge of MCNP at this point should allow you to define these two cells using surfaces 7-11 in Figure 4.3. The complete cell card section is shown in Figure 4-4, and identification of the cells is shown in Figure 4-5.

Example 4-3, Repeated Structures: Two Cylinders

C Cell Cards

```

1 1 9.9605e-2 -1 -4 5 u=3 imp:n=1 $ Solution
2 0 -1 4 u=3 imp:n=1 $ Void region above soln
3 2 -2.7 1:-5 u=3 imp:n=1 $ Al container
4 0 -2 -3 6 fill=3 imp:n=1
5 like 4 but trcl (17 0 0) imp:n=1
6 3 -1.0 10 -11 8 -9 7 -3 #4 #5 imp:n=1
7 0 -10:11:-8:9:-7:3 imp:n=0
    
```

Figure 4-4. Example 4-3 Cell cards.

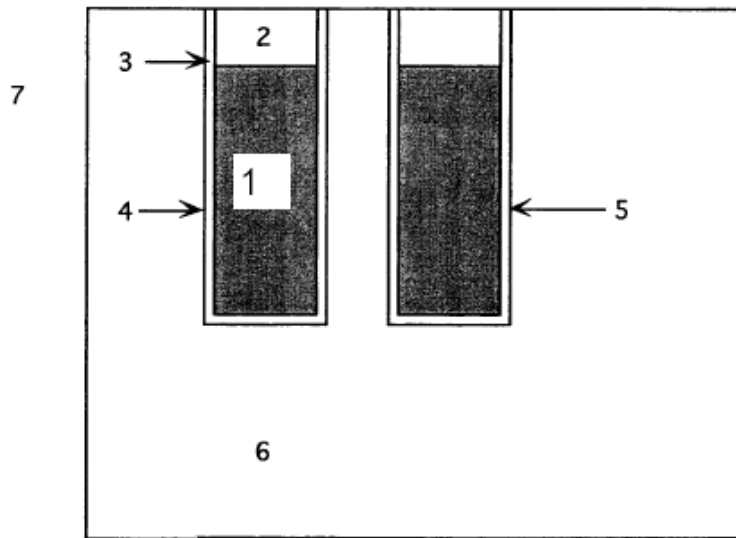

Figure 4-5. Example 4.3 cell diagram. (Not to scale)

4.3.B Materials

Use the information given in the problem description to define the material cards. Material 1 is the uranium solution. Material 2 is the aluminum container. Material 3 is the water for the reflector. Figure 4.6 shows the material cards for this example. The m1 card uses atom densities for the solution. The m2 and m3 cards use the number of atoms per

molecule for aluminum and water, respectively. Both methods of material input are appropriate and selection of either method is generally based on the data available for the problem. A WARNING message will be printed in the output because the atom fractions on the m3 card do not add up to either the density on the cell 6 card or to 1.0. MCNP will renormalize the values given and continue executing the problem. Light water $S(\alpha,\beta)$ cross sections are used for both the uranium solution and water reflector because both contain hydrogen bound in the water molecule.

```

C Data Cards
C Materials Cards
m1      1001.62c 6.2210e-2 8016.62c 3.3621e-2
        9019.62c 2.5161e-3
        92235.66c 1.1760e-3 92238.66c 8.2051e-5
mt1     lwtr.60t
m2      13027.62c 1.0
m3      1001.62c 2 8016.62c 1
mt3     lwtr.60t

```

Figure 4-6. Example 4.3 material cards.

4.3.C MCNP Criticality Controls

The `kcode` specification remains the same as previous examples, but there is one change in the `ksrc` card. We have added a second initial source point for the additional solution cylinder. One of the reasons for this change is to ensure efficient sampling of the fissile material in the second solution cylinder. Without the added source point, the number of settling cycles chosen for the `kcode` card would need to be larger to ensure a converged spatial distribution of fission source points in the second cylinder. Figure 47 shows the control cards for this example.

```

C Control Cards
kcode 5000 1.0 50 250
ksrc   0 0 35 17 0 35

```

Figure 4-7. Example 4.3 control cards.

4.3.D Example 4.3 MCNP Input File

This completes the input requirements for this example. The completed input file should resemble the following. Do not forget the blank line delimiters.

Example 4-3, Repeated Structures, Two Cylinders**C Cell Cards**

```

1 1 9.9605e-2 -1 -4 5 u=3 imp:n=1 $ Solution
2 0 -1 4 u=3 imp:n=1 $ Void region
3 2 -2.7 1:-5 u=3 imp:n=1 $ Al container
4 0 -2 -3 6 fill=3 imp:n=1
5 like 4 but trcl (17 0 0) imp:n=1
6 3 -1.0 10 -11 8 -9 7 -3 #4 #5 imp:n=1
7 0 -10:11:-8:9:-7:3 imp:n=0

```

C Surface Cards

```

1 cz 6.35 $ Solution radius
2 cz 6.50 $
3 pz 80.0 $ Top of container
4 pz 70.2 $ Top of solution
5 pz 0.0
6 pz -0.15
7 pz -20.15 $ Bottom of tank

```

C Sides of Tank

```

8 px -16.5
9 px 43.5
10 py -26.5
11 py 26.5

```

C Data Cards**C Materials Cards**

```

m1 1001.62c 6.2210e-2 8016.62c 3.3621e-2
    9019.62c 2.5161e-3 92235.66c 1.1760e-3
    92238.66c 8.2051e-5
mt1 lwtr.60t
m2 13027.62c 1.0
m3 1001.62c 2 8016.62c 1
mt3 lwtr.60t

```

C Control Cards

```

kcode 5000 1.0 50 250
ksrc 0 0 35 17 0 35

```

4.3.E Output

The final combined k_{eff} estimator for this problem on a Windows 2000 Pentium 4 computer with the ENDF66c data library at LANL was 1.00803 with an estimated standard deviation of 0.00091 (1σ).

4.4 PLOTTING THE PROBLEM GEOMETRY

After creating the input file, you can generate arbitrary 2-dimensional plots of the geometry. Although the installation of this plotter may vary from machine to machine,

MCNP Criticality Primer II

the plot commands are the same. It is very important to use the plotter to debug geometry problems before trying to run particles. You will save a great deal of time by doing so. Appendix E of this document shows a listing of the plotter commands. {see Appendix B of the MCNP manual for a detailed description of the plotter and plot commands.} The format for plotting follows.

```
mcnp inp=filename ip
```

where ip = initiate and plot

After receiving the plot prompt, pressing the carriage return or enter key will display a default plot. The default plot is a PX slice centered at (0, 0, 0) with an extent of -100 cm to 100 cm on the Y-axis and -100 cm to 100 cm on the Z-axis. Geometry errors are shown as red dotted lines. Keywords and entries can be entered after the prompt to get any 2 dimensional view desired. Only enough of the keyword has to be typed to make it unique. For example, "or" will specify the origin keyword.

We will discuss seven plot keywords. Although shown here in upper case to set them off from the rest of the text, either upper or lower case is acceptable.

ORIGIN vx vy vz – The coordinate about which the plot is centered.

Default = 0 0 0.

EXTENT eh ev - Sets the scale of the plot in cm so that eh is the horizontal distance from the origin to either side of the plot and ev is the vertical distance from the origin to the top and bottom of the plot. If one value is entered, it is duplicated for the second entry.
Default 100 100

PX vx – Draws y-z plot plane at X=VX. Default px 0

PY vy – Draws x-z plot plane at y=vy.

PZ vz – Draws x-y plot plane at Z=VZ.

LABEL s c – Put labels of size s on the surfaces and labels of size c on the cells. Default: 1 0 (no cell labels)

SHADE n color –Make material n the color chosen.

{See Appendix B of the MCNP Manual for more plot commands}.

After clicking in the upper left hand corner of the plot window, you will see a default plot showing a slice through the origin on the y-axis and z-axis with the surfaces labeled.

MCNP Criticality Primer II

09/17/03 11:57:38
 Example 4, Repeated Structures

```

probid = 09/17/03 11:56:30
basis: YZ
( 0.000000, 1.000000, 0.000000)
( 0.000000, 0.000000, 1.000000)
origin:
( 0.00, 0.00, 0.00)
extent = ( 100.00, 100.00)
    
```

```

Value for cel      1
in Cell  1
xyz = 0.00, 0.00, 0.00
    
```

CURSOR	Restore	CellLine
PostScript	ROTATE	
COLOR	SCALES 0	LEVEL
XY	YZ	ZX
LABELS	L1 sur	L2 off
MBODY		

[Click here or picture or menu](#)

UP	RT	IN	LF	Origin	.1	.2	Zoom	5.	10.
----	----	----	----	--------	----	----	------	----	-----

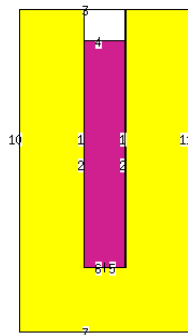

cel
imp
rho
den
vol
fcl
mas
put
mat
twp
win

PAR
N

		Redraw	Plot>		End
--	--	--------	-------	--	-----

To see a top view of the cylinders, click on the box in the lower left hand corner (labeled “Click here or picture or menu” and type “pz 80”

MCNP Criticality Primer II

09/17/03 12:00:15
 Example 4, Repeated Structures

```

probid = 09/17/03 11:56:30
basis: XY
( 1.000000, 0.000000, 0.000000)
( 0.000000, 1.000000, 0.000000)
origin:
( 0.00, 0.00, 80.00)
extent = ( 100.00, 100.00)
  
```

UP	RT	IN	LF	Origin	.1	.2	Zoom	5.	10.
----	----	----	----	--------	----	----	------	----	-----

cel
imp
rho
den
vol
fcl
mas
put
mat
twp
wun

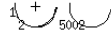

```

Value for cel      2
in Cell 2
xyz = 0.00, 0.00, 80.00
  
```

CURSOR	Restore	CellLine
PostScript	ROTATE	
COLOR	SCALES 0	LEVEL
XY	YZ	ZX
LABELS	L1 sur	L2 off
MBODY		

PAR
N

[Click here or picture or menu](#)

		Redraw	Plot>		End
--	--	--------	-------	--	-----

This plot only draws about half of each cylinder. Plot planes should not coincide with a problem surface. Move the plot plane a small distance away from the plane pz 80 by typing: pz 79

MCNP Criticality Primer II

09/17/03 12:02:12
 Example 4, Repeated Structures

```

probid = 09/17/03 11:56:30
basis: XY
( 1.000000, 0.000000, 0.000000)
( 0.000000, 1.000000, 0.000000)
origin:
( 0.00, 0.00, 79.00)
extent = ( 100.00, 100.00)
  
```

UP	RT	IN	LF	Origin	.1	.2	Zoom	5.	10.
----	----	----	----	--------	----	----	------	----	-----

cel
imp
rho
den
vol
fc1
mas
put
mat
tmp
win

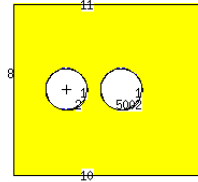

Value for cel 2
 in Cell 2
 xyz = 0.00, 0.00, 79.00

CURSOR	Restore	CellLine
PostScript	ROTATE	
COLOR	SCALES 0	LEVEL
XY	YZ	ZX
LABELS	L1 sur	L2 off
MBODY		

PAR
N

[Click here or picture or menu](#)

		Redraw	Plot>		End
--	--	--------	-------	--	-----

In addition to typing commands in the box in the lower left hand corner, many of the commands are now mouse driven. Clicking on the .1 – .2 Zoom will cause the view to zoom out, while clicking between 5 and 10 will cause the view to zoom in. Clicking on the L2 button will cause the cell labels to be printed, but only when the plot is refreshed. Clicking on the text in the upper left corner will immediately refresh the plot. Clicking on an item on the vertical bar on the right hand side and then on the L2 button will change the meaning of the L2 label. Clicking on the cursor button will allow the user to select two points in the geometry which become the new upper left and lower right corners of the plotted geometry. Clicking on the XY, YZ or ZX buttons will cause the plotter to display the geometry in the given plane and with the fixed coordinate given by the origin (of the plot, not the geometry) variable. A more completed description of the mouse driven commands are given in Appendix B of the MCNP Manual.

Grey Box 13. – Surfaces Generated by Repeated Structures.**Surfaces Generated by Repeated Structures**

This view shows both solution cylinders and the water reflector. Notice that the surfaces of the left cylinder (cell 4) are numbered as defined in the input file. The cylinder on the right is the repeated structure. The outer cylinder surface number is different for cell 5. The inner cylinder is still surface 1, but the outer cylinder is 5002. When using repeated structures, MCNP will renumber the translated surfaces if needed as follows: $1000 * \text{cell number} + \text{surface number}$. The planes for cell 5 were renumbered also, but because planes are infinite, surfaces 5003 and 5006 are identical to surfaces 3 and 6, and the code prints the WARNING message:

```
2 surfaces were deleted for being the same as others.
```

The surface numbers of the cells in a universe do not get incremented. Surfaces 1, 4 and 5 are in both cells 4 and 5.

To plot cell numbers instead of surface numbers, type:

```
label 0 1
```

To make the size of the cell numbers larger, type

```
la 1 2
```

This puts both cell and surface numbers in the plot and increases the size of the cell numbers. Materials in cells are plotted in color. To see the material numbers of cells type:

```
la 0 1 mat
```

Some other cell quantities that can be plotted are:

```
den: mass density
rho: atom density
mas: mass
imp: n: importances
vol: volume
cel: cell number (default)
```

To change the color of material 1 from its default color, purple, type

```
shade 1 yellow
```

To see what colors are available, type

options

We suggest that you experiment with the commands to get a feel for how the plotter works.

4.5 SUMMARY

This chapter introduced repeated structures, which is a very powerful capability available in MCNP. With this command you can create geometries that involve many identical structures and still vary their characteristics. By defining one structure, you are easily able to reproduce that structure in as many places as needed.

Geometry plotting is a powerful tool. By plotting your geometry before transporting particles, geometry errors can be corrected. You can also make sure that the geometry setup is what you actually want it to be by displaying cell quantities.

Chapter 5: Hexahedral (Square) Lattices

This chapter introduces the lattice keyword (`lat`) that allows you to model virtually any square pitch or triangular pitch array. The focus in this chapter is hexahedral lattices while hexagonal (triangular) lattices are covered in Chapter 6. In this document, a hexahedral lattice will be referred to as a square lattice.

5.1 WHAT YOU WILL BE ABLE TO DO

- 1) Use the `lat` keyword to create a square lattice.
- 2) Understand lattice indexing.
- 3) Create a lattice whose elements contain different materials, are filled with different sized items, or are sometimes empty.

5.2 PROBLEM DESCRIPTION

This example is a 3x2 array of plutonium nitrate solution cylinders (PNL-TR-452). Plutonium nitrate solution is contained in six stainless steel cylinders with a 10 cm surface separation between tanks. We will assume there is no other geometry present for this example such as suspension wires for the tanks and room walls. The data for this problem are:

Plutonium Nitrate Solution

$$N_{239} = 2.7682e-4$$

$$N_{240} = 1.2214e-5$$

$$N_{241} = 8.3390e-7$$

$$N_{242} = 4.5800e-8$$

$$N_{\text{Hydrogen}} = 6.0070e-2$$

$$N_{\text{Oxygen}} = 3.6540e-2$$

$$N_{\text{Nitrogen}} = 2.3699e-3$$

$$N_{\text{Total}} = 9.9270e-2$$

$$\text{Solution height} = 39.24 \text{ cm}$$

Stainless Steel Containers

$N_{\text{Iron}} = 6.3310\text{e-}2$	3x2 square lattice
$N_{\text{Chromium}} = 1.6540\text{e-}2$	Surface separation = 10.0 cm
$N_{\text{Nickel}} = 6.5100\text{e-}3$	Tank i.d. = 24.98 cm
$N_{\text{Total}} = 8.6360\text{e-}2$	Tank wall thickness = 0.30 cm
	Tank top and bottom thickness = 1.0 cm
	Tank inside height = 101.7 cm
	Tank pitch = 35.58 cm

5.3 EXAMPLE 5.3: SQUARE LATTICE OF 3x2 PU CYLINDERS

5.3.A Geometry

Figure 5-1 shows the geometry setup for this example.

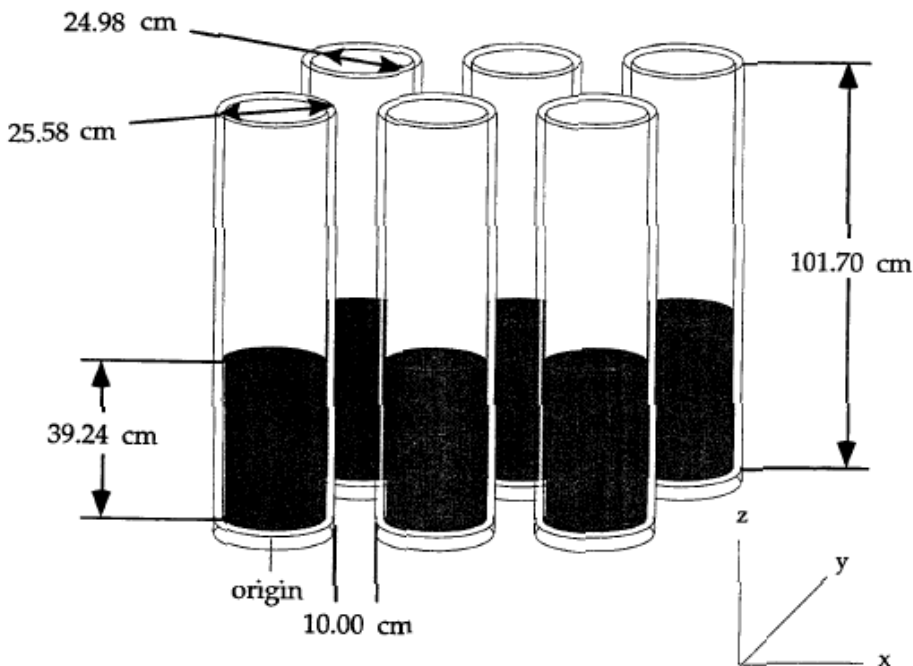

Figure 5-1. Example 5 geometry.

To model the square array we will use three steps. We start with modeling the cylindrical container. Next, a lattice cell is created and filled with the cylindrical

container. Finally, we create a cell (or window) that limits the array size to 3x2 as specified in the problem description.

Cylindrical Container Surfaces

This chapter uses the lattice keyword to create a square configuration of plutonium nitrate solution cylinders. To create the cylinders we use the universe card described in the previous chapter; therefore, we need only enough surfaces to define one solution cylinder. First we define the five surfaces needed for the solution, the void above the solution, the stainless steel cylinder, and the void outside the container. Compare your surfaces with those in Figure 5-2.

```
C Solution Cylinder Surface Cards
1 cz 12.49
2 cz 12.79
5 pz 0.0
6 pz 39.24
7 pz 101.7
```

Figure 5-2. Example 5.3 solution cylinder surface cards.

Cylindrical Container Cells

Remember, we always begin the input file with a title card,

Example 5-3, Square Lattice of 3x2 Pu Cylinders

The solution, the void region above the solution, the stainless steel container, and the void outside the container are defined as part of the same universe. That universe will then be used to fill the square lattice. The first cell, cell 1, is the plutonium nitrate solution and is assigned material 1. The material density is input in *atoms/b-cm* as given in the problem description. Surfaces 1, 5, and 6 with the appropriate sense create a cylinder of solution. Cell 1 is designated as part of universe 1 and the neutron importance is set to 1.

```
1 1 9.9270e-2 -1 5 -6 u=1 imp:n=1
```

A void region exists above the solution to the lid of the stainless steel container, defined as cell 2. Because it is void, it is assigned a material number of 0. Surfaces 1, 7, and 6 create the void cylinder. This cell also belongs to universe 1. Even though this region is a void, there is a chance that neutrons could be scattered through it by the stainless steel and into the solution; therefore, it is given a neutron importance of 1.

```
2 0 -1 6 -7 U=1 imp: n=1
```

Next we define the stainless steel container for the solution, cell 3. We designate the stainless steel as material 2. Once again the material density is entered in *atoms/b-cm* as given in the problem description. The stainless steel is defined as being inside surface

2, not in cell 1, and not in cell 2, creating an infinitely tall cylinder of stainless steel except for the solution and void region as shown in Figure 5-3. Cell 3 is also part of universe 1 and is assigned a neutron importance of 1. (A cell 3 alternative equivalent definition is shown and allows faster particle tracking.)

```
3 2 8.6360e-2 -2 #1 #2 u=1 imp: n=1
```

or

```
3 2 8.6360e-2 -2 (1:-5:7) u=1 imp: n=1
```

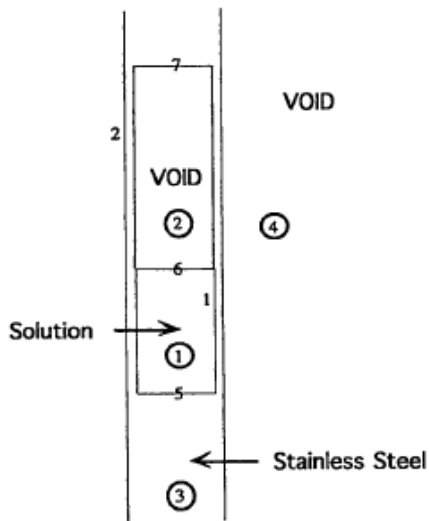

Figure 5-3. Solution container with cell numbers circled and surface numbers.

Cell 4 is the final cell belonging to universe 1. It is the void region outside the solution cylinder, defined as all space with a positive sense with respect to surface 2, in universe 1, with a neutron importance of 1.

```
4 0 2 u=1 imp: n=1
```

Cells 1-4, all belonging to universe 1, are now complete and will be used to fill lattice elements.

Lattice Cell Surfaces

In this section we define a unit cell in the x-y plane for the lattice. Looking back at the problem description we see that the surface separation between cylinders is 10 cm. The four planes listed in Figure 5-4 are defined so that there is 5 cm between the edge of the stainless steel container and each plane. Add these lines to the surface card section.

```

C Beginning of Lattice Surfaces
8 px 17.79
9 px -17.79
10 py 17.79
11 py -17.79
    
```

Figure 5-4. Example 5 lattice cell surface cards.

Lattice Cell Card

When defining a square lattice, MCNP requires that at least 4 sides be specified. Opposite sides must be identical and parallel. Two sides can be omitted, resulting in an infinite lattice in that dimension. A cell is defined to be a lattice with the `lat` keyword that is entered in the `params` section of the cell card.

```
lat = 1      square lattice
```

Cell 5 is the lattice cell and will be filled with the cells belonging to universe 1. Cell 5 is given a material number of 0 because the materials have been defined in cells 1-4. Cell 5 is all space with a negative sense with respect to (wrt) surface 8, a positive sense wrt surface 9, a negative sense wrt surface 10, and a positive sense wrt surface 11. We have defined a unit slab, infinite in z, that is duplicated in the x and y directions by the `lat` card. The order of these surfaces on the cell card is important. It determines in which spatial directions the lattice indices increase and decrease. Each lattice element has a unique location identifier. The first index increases beyond the first surface listed and decreases beyond the second surface listed, etc., as shown in Figure 55. Therefore, surfaces parallel to each other must be listed as pairs. Surface 8 is parallel to surface 9. Surface 10 is parallel to surface 11. The element $[0, 0, 0]$ is the one defined on the cell card.

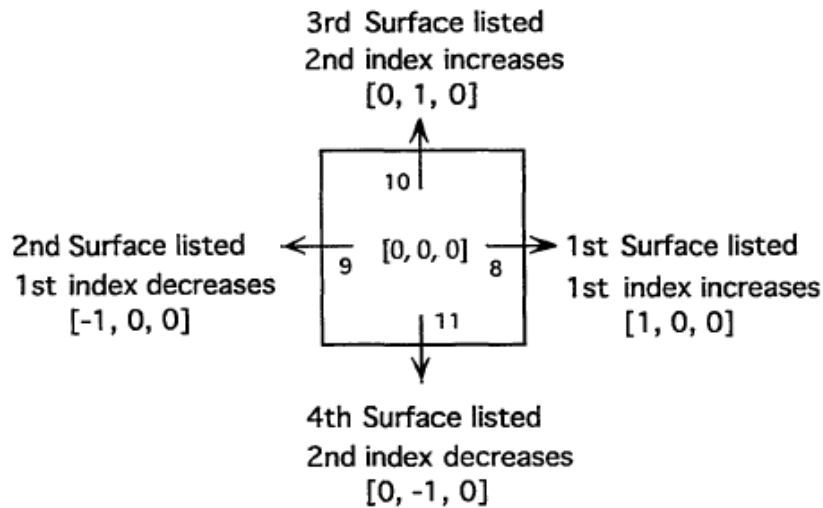

Figure 5-5. How lattice indices are determined.

Surface 8 is opposite surface 9, and surface 10 is opposite surface 11. We define the cell as a square lattice, `lat=1`, and fill the cell with universe 1, `fill=1`. This specification creates an infinite lattice in only the x and y direction. The lattice cell itself is infinite in the $\pm z$ direction. This infinite lattice is designated as universe 2. A neutron importance of 1 completes the cell.

```
5 0 -8 9 -10 11 lat=1 fill=1 u=2 imp:n=1
```

The last step for this problem is to take universe 2, cell 5, and put it in a window to limit it to a 3x2 finite array. We need to define six more surfaces for the problem. Recall an important fact about filled cells and filling universes discussed in Chapter 4.

Because cell 5 defines an infinite array we can choose a window cell that will enclose any six of the lattice cells. Figure 5-6 shows the surfaces chosen for the window cell. A `px` plane at 88.95 an is at the right edge of the third lattice cell from the origin (17.79 cm + 2*35.58 cm). The other bounding plane is defined in the same manner.

C Window Surfaces

```
3 pz -1.0
4 pz 102.7
12 px 88.95
14 py 53.37
```

Figure 5-6. Example 5 window surface cards.

Surfaces 3 and 4, the top and bottom of the problem, limit the z-extent so the array height is 103.7 cm.

We can now define cell 6. The material number is zero because the materials have already been defined in cells 1-4. The cell is then bound in the positive sense of surface 9, the negative sense of surface 12, the positive sense of surface 11, the negative sense of surface 14, the positive sense of surface 3, and the negative sense of surface 4. The cell, or window, is filled with universe 2. Remember, universe 2 is the infinite array defined by cell 5. Cell 6 data is completed by entering a neutron importance of 1.

```
6 0 9 -12 11 -14 3 -4 fill=2 imp:n=1
```

Cell 7 defines the “rest of the world”, a union of space outside cell 6. It has a material number of 0 and a neutron importance of 0, so that escaping particles are terminated.

```
7 0 -9:12:-11:14:-3:4 imp:n=0
```

or

```
7 0 #6 imp:n=0
```

5.3.B Materials

Material cards should be entered as described in previous chapters using the information provided in the problem description. Because the plutonium is in a solution, light water $S(\alpha,\beta)$ cross-sections should be used for material 1. Your material cards should be similar to those in Figure 5-7.

C Material cards

```
m1 1001.62c 6.0070-2 8016.62c 3.6540-2 7014.62c 2.3699-
3
94239.66c 2.7682-4 9424.66c 1.2214-5 94241.66c 8.3390-
7
94242.66c 4.5800-8
mt1 lwtr.60t
m2 24050.62c 7.195-4 24052.62c 1.38589-2
24053.62c 1.5713-3 24054.62c 3.903-4
26056.62c 3.704-3 26056.62c 5.80869-2 26057.62c 1.342-
3
26058.62c 1.773-4
28058.62c 4.432-3 28060.62c 1.7069-3 28061.62c 7.42-
5
28062.62c 2.363-4 28064.62c 6.05-5
```

Figure 5-7. Example 5 material cards.

The “e” notation (e-2) used in previous examples is optional and has been omitted here.

5.3.C MCNP Criticality Controls

The `kcode` specification remains the same from the previous example, but there are changes in the `ksrc` card. For this example we have placed an initial source point in each solution cylinder to ensure sampling during the settling cycles. Figure 5-8 shows the control cards for this example.

C Control Cards

```
kcode 5000 1.0 50 250
c one source point in each volume of Pu Solution
ksrc 0 0 19.62 35.58 0 19.62 71.16 0 19.62
0 35.58 19.62 35.58 35.58 19.62 71.16 35.58 19.62
```

Figure 5-8. Example 5.3 control cards.

5.3.D Example 5.3 MCNP Input File

The input for this example is complete. The input file should resemble the following. Do not forget the blank line delimiters. Comments following a \$ have been used on the cell cards.

MCNP Criticality Primer II

Example 5-3, Hexahedral Lattices. Updated Lattice

C Cell Cards

```

1 1 9.9270e-2 -1 5 -6          u=1 imp:n=1 $Pu Soln.
2 0          -1 6 -7          u=1 imp:n=1 $ void
above
3 2 8.6360e-2 -2 #1 #2       u=1 imp:n=1 $ SS
4 0          2                u=1 imp:n=1 $ void
5 0   -8   9 -10 11 lat=1 fill=1 u=2 imp:n=1 $ lattice
6 0   9 -12 11 -14 3 -4 fill=2   imp:n=1 $ window
7 0  -9:12:-11:14:-3:4        imp:n=0 $ outside

```

C Solution Cylinder Surface Cards

```

1 cz 12.49
2 cz 12.79
5 pz 0.0
6 pz 39.24
7 pz 101.7
C Beginning of lattice surfaces
8 px 17.79
9 px -17.79
10 py 17.79
11 py -17.79
C Beginning of Window Surfaces
3 pz -1.0
4 pz 102.7
12 px 88.95
14 py 53.37

```

C Control Cards

```

kcode 5000 1.0 50 250
c one source point in each volume of Pu Solution
ksrc 0 0 19.62 35.58 0 19.62 71.16 0 19.62
      0 35.58 19.62 35.58 35.58 19.62 71.16 35.58 19.62
C Material cards
m1 1001.62c 6.0070-2 8016.62c 3.6540-2 7014.62c 2.3699-
3
      94239.66c 2.7682-4 94240.66c 1.2214-5 94241.66c 8.339-
7
      94242.66c 4.5800-8
mt1 lwtr.60t
m2 24050.62c 7.195-4 24052.62c 1.38589-2 24053.62c 1.5713-
3
      24054.62c 3.903-4
      26056.62c 3.704-3 26056.62c 5.80869-2 26057.62c 1.342-
3
      26058.62c 1.773-4
      28058.62c 4.432-3 28060.62c 1.7069-3 28061.62c 7.42-5

```

28062.62c 2.363-4 28064.62c 6.05-5

Grey Box 14. – Finding Coordinates For `ksrc` Card.**Finding Coordinates For `ksrc` Card**

When specifying the coordinates on the `ksrc` card, always specify the locations in the global coordinate system. The global coordinates can be determined at any point by using the `locate` command in the geometry plotter. After entering this command, click on any location in the geometry, and the global coordinates will be displayed in the upper left corner.

Note that the 'xyz=' coordinates displayed in the lower left hand corner are the local coordinates where the mouse was clicked. These coordinates may not be the same as the global coordinates.

5.3.E Output

Before transporting particles, be sure to run the plotter to check for geometry errors. The plotter indicates geometry errors by dotted lines. It will only show errors for the plane you are looking at so be sure to look at the problem in the x, y, and z planes. The default plotter view may not show the entire plot. Change the origin of the plot to:

```
or 0 0 20
```

This will give the following plot:

MCNP Criticality Primer II

09/17/03 14:56:31
 Example 5, Hexahedral Lattices.

```

probid = 09/17/03 14:56:11
basis: YZ
( 0.000000, 1.000000, 0.000000)
( 0.000000, 0.000000, 1.000000)
origin:
( 0.00, 0.00, 20.00)
extent = ( 100.00, 100.00)
  
```

```

Value for cel      1
in Cell  1
xyz = 0.00, 0.00, 20.00
  
```

CURSOR	Restore	CellLine
PostScript	ROTATE	
COLOR	SCALES 0	LEVEL
XY	YZ	ZX
LABELS	L1 sur	L2 off
MBODY		

[Click here or picture or menu](#)

UP	RT	IN	LF	Origin	.1	.2	Zoom	5.	10.
----	----	----	----	--------	----	----	------	----	-----

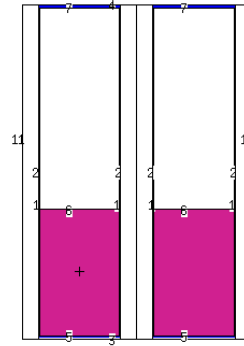

cel
imp
rho
den
vol
fcl
mas
put
mat
tmp
win

PAR
N

		Redraw	Plot>		End
--	--	--------	-------	--	-----

MCNP Criticality Primer II

After changing the view to $py=0.0$ the plot will look as follows:

09/17/03 14:57:05
Example 5, Hexahedral Lattices.

```

probid = 09/17/03 14:56:11
basis: XZ
( 1.000000, 0.000000, 0.000000)
( 0.000000, 0.000000, 1.000000)
origin:
( 0.00, 0.00, 20.00)
extent = ( 100.00, 100.00)
    
```

```

Value for cel      1
in Cell  1
xyz = 0.00, 0.00, 20.00
    
```

CURSORS	Restore	CellLine
PostScript	ROTATE	
COLOR	SCALES 0	LEVEL
XY	YZ	ZX
LABELS	L1 sur	L2 off
HBODY		

[Click here or picture or menu](#)

UP	RT	IN	LF	Origin	.1	.2	Zoom	5.	10
----	----	----	----	--------	----	----	------	----	----

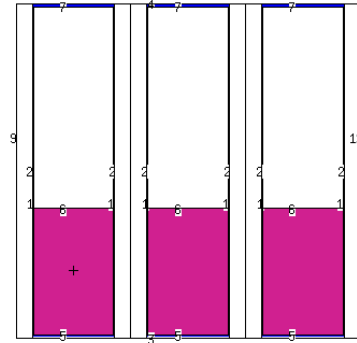

cel
imp
rho
den
vol
fc1
mas
put
mat
tsp
win

PAR
N

		Redraw	Plot>		End
--	--	--------	-------	--	-----

MCNP Criticality Primer II

A view of the pz plane at 10 cm will look as follows:

```

09/17/03 14:57:36
Example 5, Hexahedral Lattices.

probid = 09/17/03 14:56:11
basis: XY
( 1.000000, 0.000000, 0.000000)
( 0.000000, 1.000000, 0.000000)
origin:
( 0.00, 0.00, 10.00)
extent = ( 100.00, 100.00)
    
```

UP	RT	IN	LF	Origin	.1	.2	Zoom	5.	10
----	----	----	----	--------	----	----	------	----	----

```

Value for cel      1
      in Cell      1
xyz = 0.00, 0.00, 10.00
    
```

CURSOR	Restore	CellLine
PostScript	ROTATE	
COLOR	SCALES 0	LEVEL
XY	YZ	ZX
LABELS	L1 sur	L2 off
MBODY		

[Click here or picture or menu](#)

cel
imp
rho
den
vol
fcl
mas
put
mat
tap
win

PAR
N

		Redraw	Plot>		End
--	--	--------	-------	--	-----

The final combined k_{eff} estimator for this problem on a Windows 2000 Pentium 4 computer with the ENDF66c data library at LANL was 0.98536 with an estimated standard deviation of 0.00102 (1σ).

5.4 EXAMPLE 5.4: CHANGING MATERIALS IN SELECTED ELEMENTS

Example 5.3 was filled with six identical items. The fill specification was a single number that specified the universe that filled every element of the lattice. This example illustrates the expanded form of the fill card. Example 5.3 is modified by filling two of the containers with graphite.

Grey Box 15. – Filling Lattice Elements Individually.**Filling Lattice Elements Individually**

The fill specification can be followed by entries that define the lattice range and fill the lattice elements individually. Each lattice element has a unique location identifier. The indices of each element are determined relative to the [0, 0, 0] element defined by the surfaces on the lattice cell card. These indices can be positive or negative integers or zero.

Three pairs of values that define the range of the three lattice indices for the x, y, and z directions are followed by the universe numbers themselves. The range upper and lower bounds must be explicitly stated, separated by a colon. The range must include all elements that appear in the cell that the lattice fills. For one range pair, -5:5 or 0:10 defines a range of 11 elements, and 0:0 defines 1 element.

Recall that the order of surfaces on the cell card identifies the ordering of the lattice elements. In this document, the first surface listed is the px plane with the largest x value the second is the px plane with the smallest x value, the third is the py plane with the largest y value, and the fourth is the py plane with the smallest py value. The elements are incremented as follows: do all x for the first y, first z, do all x for the second y, first z, do all x for all y, first z, do all x for the first y, second z, do all x for the second y, second z, etc. A void lattice cell 1 card with the fill card completely specified might look like

```
1 0 surface numbers u=1 lat=1 fill= -1:0 0:1 0:0 3 4 5 6
```

Four elements are defined – [-1,0,0], [0,0,0], [-1,1,0], [0,1,0] – and they are filled with different universes – 3, 4, 5, and 6, respectively.

Figure 59 shows the indices of the lattice elements of our problem. In this example, we want the solution cylinders in lattice elements [2,0,0] and [1,1,0] to be filled with material 3. The other four lattice elements will contain material 1, as before. Cell 5 is the lattice cell and therefore locates the [0,0,0] element of the lattice. Only the elements that appear in cell 6 filled by the lattice should be included in the range.

Because 8 is the first surface number on the cell 5 card, the x range index increases beyond (to the right of) surface 8. Because 9 is the second surface number on the cell 5 card, the x index decreases beyond (to the left of) surface 9. Cell 6 encloses three elements in the plus x direction and zero elements in the minus x direction, so the first range is 0:2.

Because 10 is the third surface number on the cell 5 card, the range index increases beyond (above) surface 10. Because surface 11 is the fourth surface listed on the cell 5 card, the range index decreases beyond (below) surface 11. Cell 6 encloses two elements in the plus y direction and zero elements in the minus y direction, so the second range is 0:1. The lattice is infinite in the z direction, so there is only one element in the z direction, indicated by a range of 0:0. Recall that this infinite lattice is truncated by cell 6.

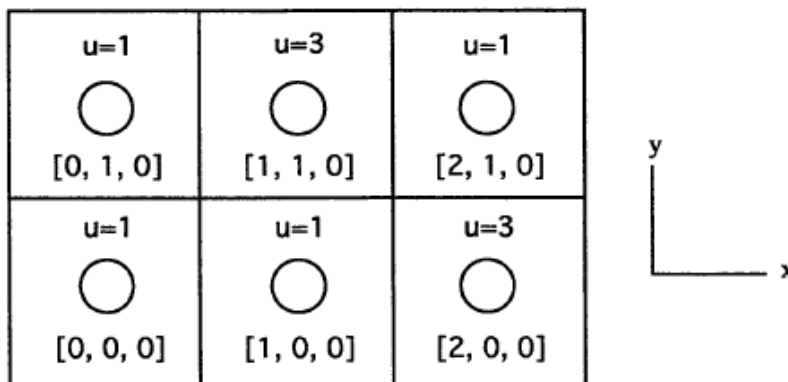

Figure 5-9. Lattice indicies and universes for Example 5.4

Following the ranges are the universe values themselves that fill each element of the declared lattice. Cell 6 encloses six elements, so we enter six universe numbers. Elements [0,0,0] and [1,0,0] are filled by universe 1, element [2,0,0] is filled by universe 3, element [0,1,0] is filled by universe 1, element [1,1,0] is filled by universe 3, and element [2,1,0] is filled by universe 1.

The complete lattice cell 5 card for Example 5.4 is

```
5 0 -8 9 -10 11 lat=1 u=2 fill=0:2 0:1 0:0 1 1 3 1 3 1
  imp:n=1
```

Now we must define the cells belonging to universe 3. Cells 14 belong to universe 1. The geometry for universe 3 is identical to that of universe 1. Only the material in cell 1 is different. The four cells belonging to universe 3, shown below, can be added to the cell card section after cells 1-4.

```
11 like 1 but mat=3 rho=-1.60 u=3 imp:n=1
12 like 2 but U=3 imp:n=1
13 like 3 but U=3 imp:n=1
14 like 4 but U=3 imp:n=1
```

We have said that cell 11 has material 3, graphie. This material is new, so an m3 card must be added to the data card section. The $S(\alpha,\beta)$ thermal neutron scattering law for graphite has been included.

```
m3 6000.66c 1
mt3 grph.60t
```

The final combined k_{eff} estimator for this problem on a Windows 2000 Pentium 4 computer with the .60t, .62c, and .66c data library extensions at LANL was 0.94631 with an estimated standard deviation of 0.00092 (1σ).

5.5 EXAMPLE 5.5: A LATTICE WITH ONE EMPTY ELEMENT

A modification to Example 5.4 is to make element [0,0,0] contain no cylinder at all. If a universe number on the fill card is the same as the universe of the lattice cell itself, that element is filled with the material specified on the lattice cell card. The material in cell 5 is zero - avoid. Cell 5 belongs to universe 2. The following cell card causes element [0,0,0] to be void as shown in Figure 5-10.

```
5 0 -8 9 -10 11 lat=1 u=2 fill=0:2 0:1 0:0 2 1 3 1 3 1 imp:n=1
```

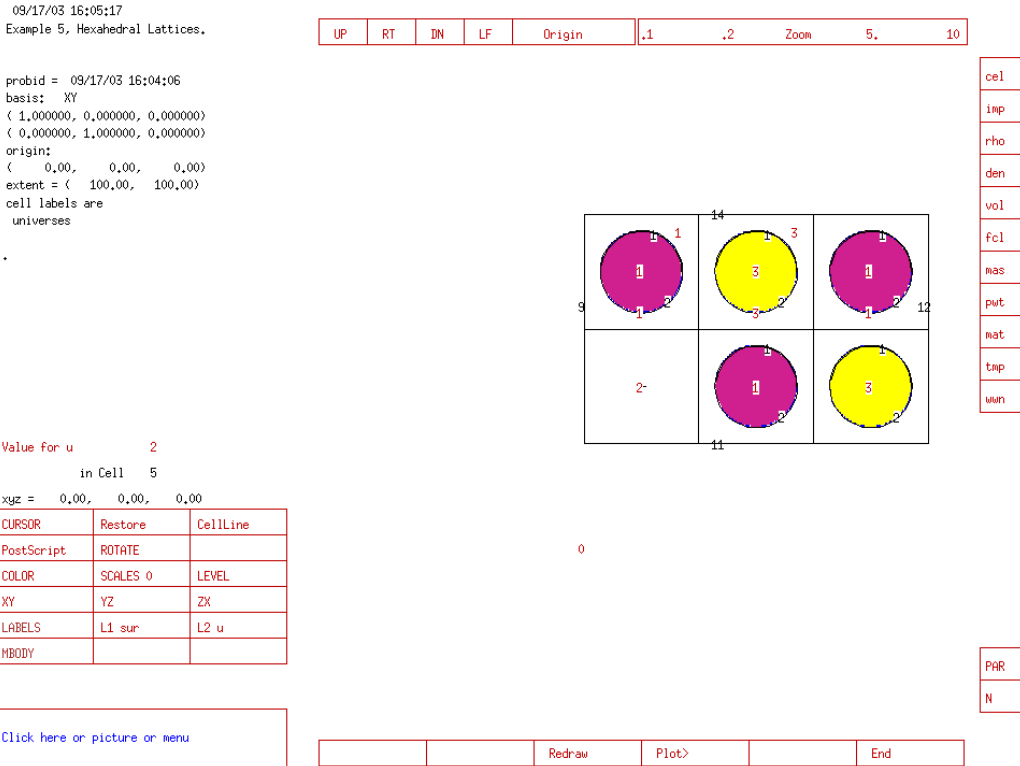

Figure 5-10. Plot of 3x2 array with empty element.

Note that in the plot above, the cell labels are universes, as specified in the upper left corner. This was generated with the “label 1 1 u” command.

The final combined k_{eff} estimator for this problem on a Windows 2000 Pentium 4 computer with the .60c, .62c, and .66c data library extensions at LANL was 0.91204 with an estimated standard deviation of 0.00104 (1σ).

5.6 EXAMPLE 5.6: CHANGING SIZE OF CELLS FILLING A LATTICE

In Example 5.6 we want to change the radius of the solution cylinder in elements [1,0,0] and [2,1,0]. In Example 5.3, the inner radius of the cylinder is 12.49 cm (surface 1), and the outer radius is 12.79 cm (surface 2). In Example 5.6 the inner cylinder radius is 5 cm, and the outer radius is 5.5 cm. The cell 5 card is similar to Example 5.4.

```
5 0 -8 9 -10 11 lat=1 u=2 fill=0:2 0:1 0:0 1 3 1 1 1 3
    imp:n=1
```

The four cells belonging to universe 3 are defined differently. Two new surfaces will be used and need to be added to the surface card section.

```
21 cz 5
22 cz 5.5
```

Because the geometrical dimensions have changed, we cannot take advantage of the like `m but` construct. The description of cells 21-24 is very similar to cells 1-4, however. Add these cell cards to the example 5.3 input file after cells 1-4.

```
21 3 -1.60      -21 5 -6 u=3 imp:n=1
22 0           -21 6 -7 u=3 imp:n=1
23 2 8.6360e-2 -22 #21 #22 u=3 imp:n=1
24 0           22 U=3 imp:n=1
```

The material in cell 21 is graphite as in example 5.4, with a density of 1.60 g/cc. An `m3` and an `mt3` card need to be added to the data card section.

```
m3 6000.66c 1
mt3 grph.60t
```

If you plot this input file with the following command

```
pz 0 or 35 20 1 ex 55
```

you see that the radial size of two cylinders is smaller.

MCNP Criticality Primer II

09/17/03 16:28:48
Example 5, Hexahedral Lattices.

```

probid = 09/17/03 16:28:15
basis: XY
( 1.000000, 0.000000, 0.000000)
( 0.000000, 1.000000, 0.000000)
origin:
( 35.00, 20.00, 1.00)
extent = ( 55.00, 55.00)
cell labels are
cell names
    
```

Value for cell 4
in Cell 4
xyz = -0.58, -15.58, 1.00

CURSOR	Restore	CellLine
PostScript	ROTATE	
COLOR	SCALES 0	LEVEL
XY	YZ	ZX
LABELS	L1 sur	L2 cel
MBODY		

[Click here or picture or menu](#)

UP	RT	IN	LF	Origin	.1	.2	Zoom	5.	10.
----	----	----	----	--------	----	----	------	----	-----

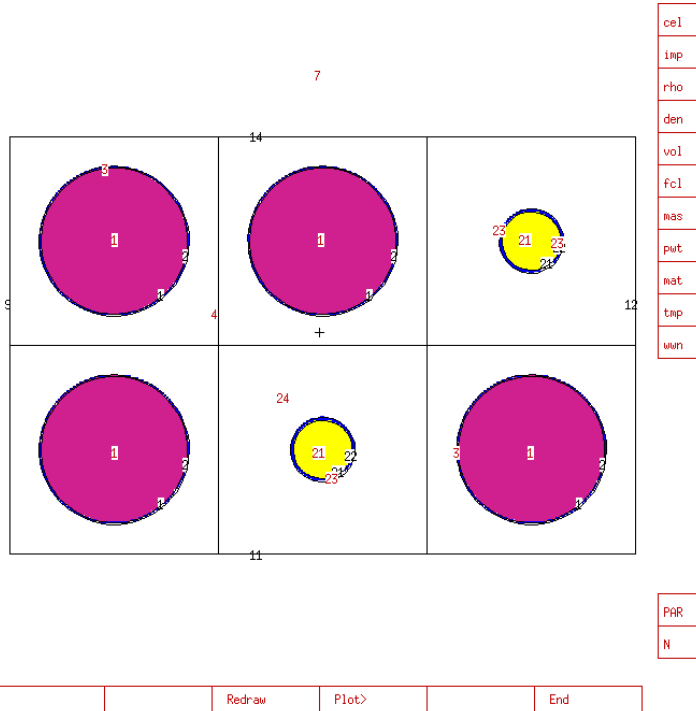

The final combined k_{eff} estimator for this problem on a Windows 2000 Pentium 4 computer with the ENDF66c data library at LANL was 0.93707 with an estimated standard deviation of 0.00105 (1σ).

5.7 SUMMARY

This chapter introduced the use of lattices with MCNP by modeling a 3x2 square array of solution cylinders. We modeled this system by first defining a single solution cylinder. Next, a cell was created and defined to be a lattice with the lat keyword. Finally, a 3x2 array was created by filling an appropriately sized box with the infinite lattice. Three other cases were presented to show how lattices can be set up to provide for elements that do not contain the same materials, or are not the same size, or lattice elements that are empty. After completing this chapter you should be able to model most 2-dimensional square lattice problems.

Three-dimensional lattices are discussed in Chapter 7.

Chapter 6: Hexagonal (Triangular) Lattices

This chapter continues discussion of the lattice keyword (lat) by modeling a triangular pitch array.

6.1 WHAT YOU WILL BE ABLE TO DO

- 1) Create general planes to define a hexagonal lattice element.
- 2) Use the `lat` keyword to create a hexagonal (triangular pitch) lattice.
- 3) Understand hexagonal lattice indexing.

6.2 PROBLEM DESCRIPTION

Example 6.3 is a hexagonal array of seven open U(93.2% enrichment) O_2F_2 solution cylinders (LA-10860 page 125). The uranium-fluoride solution is contained in seven aluminum cylinders with a 7.60 cm surface separation between cylinders. There is 20 cm of water reflection below and radially about the cylinders. There is no water above the aluminum containers. The data for this problem are:

Uranium-Fluoride Solution

$$N_{235} = 1.3784e-3$$

$$\text{Solution height} = 23.40 \text{ cm}$$

$$N_{238} = 9.9300e-5$$

$$N_{\text{Hydrogen}} = 6.1063e-2$$

$$N_{\text{Oxygen}} = 3.3487e-2$$

$$N_{\text{Fluorine}} = 2.9554e-3$$

$$N_{\text{Total}} = 9.8983e-2$$

Aluminum Containers

$$\rho = 2.70 \text{ g/cc}$$

7 cylinders in equilateral hexagonal
(triangular) lattice

$$\text{Surface separation} = 7.60 \text{ cm}$$

$$\text{Tank i.d.} = 15.20 \text{ cm}$$

$$\text{Tank wall thickness} = 0.15 \text{ cm}$$

$$\text{Tank bottom thickness} = 1.0 \text{ cm}$$

$$\text{Inside height} = 40.0 \text{ cm}$$

$$\text{Pitch} = 23.1 \text{ cm}$$

6.3 EXAMPLE 6.3: HEXAGONAL LATTICE OF PU CYLINDERS

6.3.A Geometry

Figure 6-1 shows the geometry setup for this example.

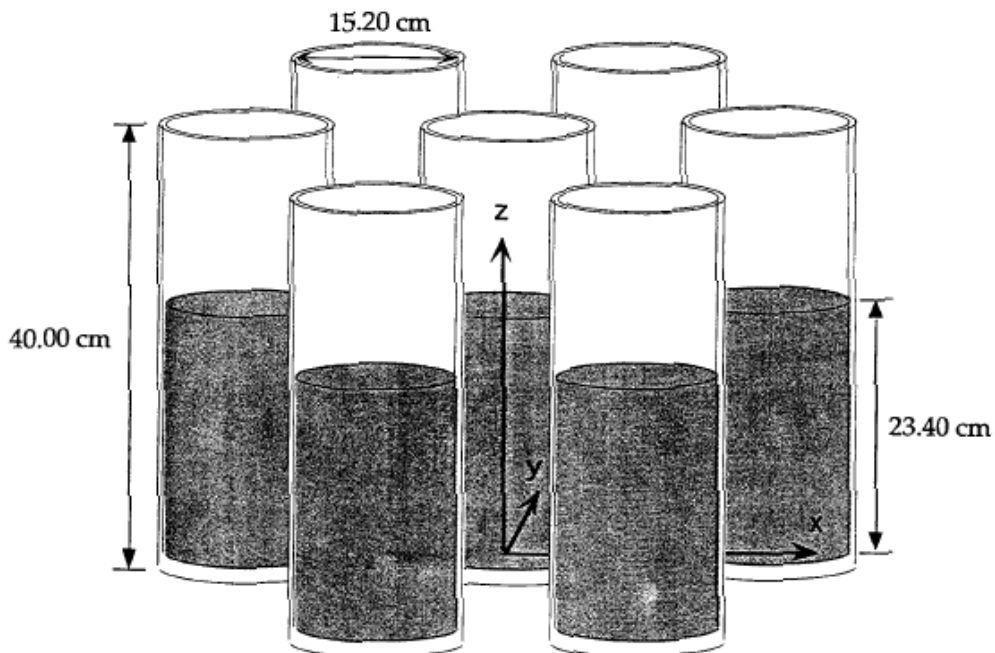

Figure 6-1. Example 6.3 geometry.

The method of modeling a hexagonal array is similar to the modeling of a hexahedral array. Three steps are involved in modeling the cylindrical container. Then a hexagonal shaped lattice cell is created for the infinite array and filled by the cylindrical container. Finally, we create a cell (window) that limits the array size to 7 elements as specified in the problem description.

Cylindrical Container Surfaces

As in chapter 5, we begin this problem by defining the surfaces for the solution, void region above the solution, the aluminum container, and the water outside the container. We want to model an open aluminum container that holds the uranium fluoride solution. Define the surfaces for the solution and compare yours with those of Figure 6-2.

```

C Solution Cylinder Surface Cards
1 cz 7.60 $ outer radius of the solution
2 cz 7.75 $ outer radius of container
4 pz 23.4 $ top of solution
5 pz 0.0 $ bottom of solution

```

Figure 6-2. Example 6.3 solution cylinder surface cards.

Cylindrical Container Cells

The title card for this problem is:

Example 6-3, Hexagonal Lattice of Pu Cylinders.

The solution, the void region above the solution, the aluminum container, and the water outside the container are defined as part of the same universe. That universe will then be used to fill every lattice cell for the hexagonal array. This geometry is shown in Figure 6-3. Cell 1 is the uranium fluoride solution and is assigned material 1. Material density is input in atoms/b-cm as given in the problem description. Surfaces 1, 4, and 5 with the appropriate sense create a cylindrically shaped solution. Cell 1 is then designated as part of universe 1. The neutron importance is set to 1.

```
1 1 9.8983e-2 -1 5 -4 u=1 imp:n=1
```

The void region above the solution is defined as cell 2 and is assigned a material number of 0. Surfaces 1 and 4 are used to create the void cylinder. We define this cell so that the void extends to infinity above the solution. Cell 2 also belongs to universe 1 and is given a neutron importance of 1.

```
2 0 -1 4 u=1 imp:n=1
```

Next we define the aluminum container for the solution, cell 3. We designate the aluminum as material 2. Once again the material density is entered in *atoms/b-cm* as given in the problem description. The aluminum is defined as being inside surface 2, not in cell 1, and not in cell 2. Cell 3 is also part of universe 1 and is assigned a neutron importance of 1, creating an infinitely tall cylinder of aluminum except for the solution and void region. An alternative cell 3 description that allows faster tracking is also shown.

```
3 2 -2.7 -2 #1 #2 u=1 imp:n=1
```

or

```
3 2 -2.7 -2 (1:-5) u=1 imp:n=1
```

Cell 4, the region of water outside the solution cylinder, is the final cell belonging to universe 1. This cell is defined as all space with a positive sense wrt surface 2, in universe 1, with a neutron importance of 1.

```
4 3 -1.0 2 U=1 imp: n=1
```

Cells 1-4, all belonging to universe 1, are complete and are shown in Figure 6-3. This universe will be used to fill a hexagonal lattice cell.

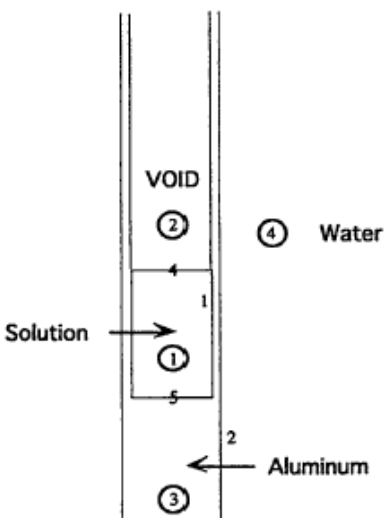

Figure 6-3. Universe 1 geometry (Cells numbers are circled).

Lattice Cell Surfaces

In this section we define the unit cell in the x - y plane for the hexagonal lattice. Opposite sides of the six-sided lattice cell must be equal in length and parallel. The dimension of concern that determines the six surfaces of the lattice cell is the pitch of the solution containers. The following “prescription” can be used to calculate the general planes for any hexagonal lattice formed from equilateral triangles. The pitch for this example is calculated by adding the outer diameter of the aluminum container and the surface separation.

The pitch for this example is calculated by adding the outer diameter of the aluminum container and the surface separation.

$$\begin{aligned} \text{pitch} &= \text{outer diameter} + \text{surface separation} \\ &= 15.50 \text{ cm} + 7.60 \text{ cm} \\ &= 23.10 \text{ cm} \end{aligned}$$

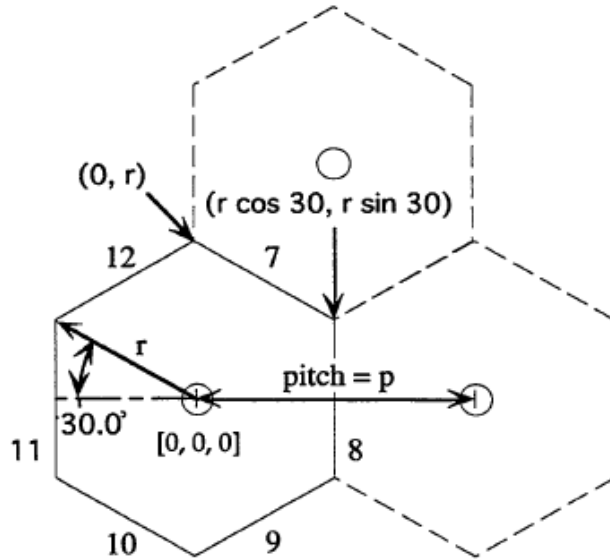

$$r \cos 30^\circ = p/2 \quad r = (p/2)/(\sqrt{3}/2) = p/\sqrt{3}$$

Figure 6-4. Diagram of [0, 0, 0] element.

Using Figure 6-4 we can define the six surfaces for the lattice element [0,0,0]. Surface numbers for these planes have been selected and need to be added to the surface card section. Surfaces 7, 9, 10, and 12 are general planes. Surfaces 8 and 11 are simple planes normal to the x-axis. {Refer to Chapter 3, Table 3.1, of the MCNP manual if you do not recall the equation of a general plane.}

Surface 7 passes through the points (0,r) and (r cos 30°, r sin 30°). The z point can have any value, so we need an equation of the form: y=m x + b. The slope m is given by:

$$m = \frac{(r - r \sin 30^\circ)}{(0 - r \cos 30^\circ)} = \frac{(r - 0.5r)}{(0 - 0.5r \sqrt{3})} = \frac{0.5r}{-0.5r \sqrt{3}} = -\frac{1}{\sqrt{3}}$$

The y-axis intercept, b, is found by choosing a point, in this case (0,r).

$$r = \frac{-1}{\sqrt{3}} * 0 + b \quad \text{or} \quad b = r$$

Therefore the equation for surface 7 is:

$$y = -\frac{1}{\sqrt{3}}x + r$$

MCNP wants this equation entered as $Ax + By + Cz = D$, where $A = -m$ and $D = r$,

$$\text{so } \frac{1}{\sqrt{3}}x + 1y + 0z = r \quad \text{where } r \text{ has already been defined as } \frac{p}{\sqrt{3}}.$$

Therefore the coefficients of the equation for surface 7 are:

$$A = 1/\sqrt{3} \quad B = 1 \quad C = 0 \quad D = p/\sqrt{3}$$

or

$$A = 1 \quad B = \sqrt{3} \quad C = 0 \quad D = p$$

The pitch, p , has already been defined as 23.10, so the surface 7 general plane is entered as:

$$7 \quad p \quad 1 \quad 1.73205 \quad 0 \quad 23.1$$

Surface 8 passes through the x-axis at $p/2$. Therefore surface 8 is defined as:

$$8 \quad px \quad 11.55$$

Surface 9 is defined similarly to surface 7. This plane passes through the points $(0, r)$ and $(r \cos 30^\circ, -r \sin 30^\circ)$. As with surface 7, the z-point can have any value, so we need an equation of the form $y = mx + b$.

$$m = \frac{(-r - (-r \sin 30^\circ))}{(0 - r \cos 30^\circ)} = \frac{(-r + 0.5r)}{(0 - 0.5r \sqrt{3})} = \frac{-0.5r}{-0.5r \sqrt{3}} = -\frac{1}{\sqrt{3}}$$

$$-r = \frac{1}{\sqrt{3}} * 0 + b \quad \text{or} \quad b = -r$$

$$y = \frac{1}{\sqrt{3}}x - r$$

The resulting MCNP format of the equation is:

$$-\frac{1}{\sqrt{3}}x + 1y + 0z = -r$$

or

$$-x + \sqrt{3}y = -p$$

The surface 9 general plane is entered as:

9 p -1 1.73205 0 -23.1

Follow the same logic for surface 10 to get the following equation of the plane.

$$\frac{1}{\sqrt{3}}x + 1y + 0z = -r$$

or

$$x + \sqrt{3}y = -p$$

The MCNP input would then appear as:

10 p 1 1.73205 0 -23.1

Surface 11 is a plane that passes through the x-axis at $-p/2$.

11 PX -11.55

MCNP Criticality Primer II

The final surface for lattice cell is a plane that passes through the point $(0, r)$ and $(-r \cos 30^\circ, r \sin 30^\circ)$. Follow the *same* procedure as with surfaces 7, 9, and 10 to get the needed equation.

```
12 P -1 1.73205 0 23.1
```

Grey Box 16. – Planes in an Equilateral Hexagonal Lattice.

Planes in an Equilateral Hexagonal Lattice

The equation for planar surfaces of an equilateral hexagonal lattice in the $x-y$ plane was derived to be

$$x + \sqrt{3}y = -p$$

Recalling that the slope is the coefficient of the x term, the sign of x and p will alternate, depending on the quadrant, as shown in Figure 6-5.

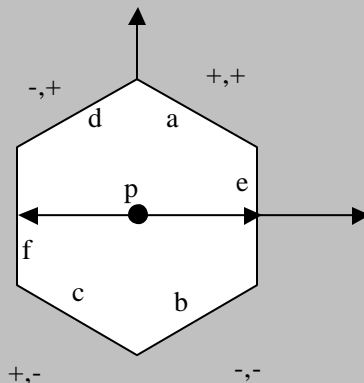

Thus the equations and card specifications for surfaces a, b, c, and d are:

A: $x + \sqrt{3} y = p$ 1 $\sqrt{3}$ 0 p

B: $-x + \sqrt{3} y = -p$ -1 $\sqrt{3}$ 0 -p

C: $x + \sqrt{3} y = -p$ 1 $\sqrt{3}$ 0 -p

D: $-x + \sqrt{3} y = p$ -1 $\sqrt{3}$ 0 p

The p_x surfaces, e and f are given by:

E: $x = \frac{p}{2}$ $\frac{p}{2}$

F: $x = -\frac{p}{2}$ $-\frac{p}{2}$

Returning to our problem, Figure 6-6 shows the coefficients of the equations for the hexagonal lattice cell for this problem. Once the pitch has been determined, the calculated values are used to describe the six surfaces.

```

C Surfaces 7-12 are the array lattice cell
7  p  1  1.73205  0  23.1
8  px  11.55
9  p -1  1.73205  0 -23.1
10 p  1  1.73205  0 -23.1
11 px -11.55
12 p -1  1.73205  0  23.1
    
```

Figure 6-6. Example 6-3 lattice cell surface cards.

Defining the Lattice Cell

The six planes previously created will define the six-sided lattice cell, called cell 5. The material number for cell 5 is 0 because the cell is filled by universe 1. The surfaces can be listed on the card in the following manner:

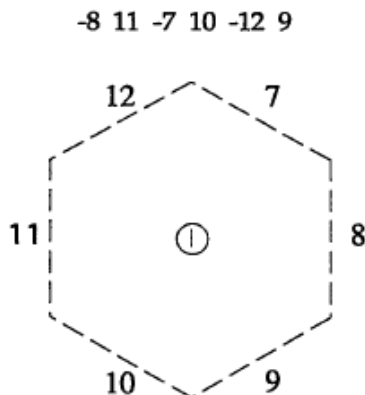

The first two surfaces listed must be opposite each other. That is, surface 8 is opposite surface 11.

Grey Box 17. – Ordering of Hexagonal Prism Lattice Elements.

Ordering of Hexagonal Prism Lattice Elements

Recall from Chapter 5 that the order of the surfaces on the cell card with a `lat` keyword identifies the ordering of the lattice elements. For the hexagonal prism lattice cell, the indexing is shown below for element $[0, 0, 0]$.

$[0,0,0]$

5th surface listed
1st decreases 2nd increases
 $[-1,1,0]$

3rd surface listed
2nd index increases
 $[0,1,0]$

2nd surface listed
1st index decreases
 $[-1,0,0]$

1st surface listed
1st index increases
 $[1,0,0]$

4th surface listed
2nd index decreases
 $[0,-1,0]$

6th surface listed
1st increases 2nd decreases
 $[1, -1, 0]$

On the opposite side of the first surface listed is element $[1,0,0]$, opposite the second surface listed is $[-1,0,0]$, opposite the third is $[0,1,0]$, then $[0,-1,0]$, $[-1,1,0]$ and $[1,-1,0]$ opposite the fourth fifth and sixth surfaces, respectively. If the lattice were finite in the z direction, opposite the seventh surface is element $[0,0,1]$, and opposite the eighth is $[0,0,-1]$.

Knowing how the elements are indexed is essential when a fully specified `fill` card is used to fill lattice elements. In all cases, it determines how the lattice is designed.

After the cell 5 surfaces are listed, we define the cell as a hexagonal lattice (`lat=2`). Cell 5 is filled with universe 1 and belongs to universe 2. A neutron importance of 1 completes the infinite hexagonal lattice cell 5 description.

```
5 0 -8 11 -7 10 -12 9 lat=2 fill=1 u=2 imp:n=1
```

The third step is to place a cell (or window) around the cell 5 infinite hexagonal lattice to limit it to a seven-element array. We define two planes for the top and bottom of the solution cylinders and define a cylinder that has a radius such that only 7 lattice elements can be contained within. Figure 6-7 shows the surfaces chosen for this example.

```
C Window Surfaces
3 pz 40.0 $ Top of aluminum cylinder
6 pz -1.0 $ bottom of aluminum container
13 cz 32.0 $ cylinder for array window
```

Figure 6-7. Example 6.3 window surface cards.

We will call the window cell 6. The material number is zero because the cell is filled by the lattice, universe 2. The cell is bound in the negative sense of surface 13, the positive sense of surface 6, and the negative sense of surface 3. Cell 6 is filled with universe 2 and has a neutron importance of 1. The infinite lattice is now limited to a system of seven solution cylinders in a hexagonal configuration.

```
6 0 -13 6 -3 fill=2 imp:n=1
```

In the problem description there is infinite water reflection except above the solution cylinders. A thickness of 20 cm of water adequately models infinite reflectors for neutrons. Two surfaces need to be added to the surface card section as shown in Figure 6-8. The cylinder is 20 cm beyond surface 13, and the plane is 20 cm below surface 6.

```
C Reflector Surfaces
14 cz 52.0 $ outer radius of reflector
15 pz -21.0 $ botmmon edge of reflector
```

Figure 6-8. Example 6.3 water reflector surfaces.

The water reflector is defined as cell 7. It is assigned material number 3, water with a density of 1 g/cc. Cell 7 is all space that is a union of the positive sense wrt surface 13 and the negative sense wrt surface 6, intersected with all space that is negative wrt surface 3, positive wrt surface 15, and negative wrt surface 14. A neutron importance of 1 completes the cell.

```
7 3 -1.0 (13:-6) -3 15 -14 imp:n=1
```

The final cell is the “rest of the world”. Cell 8 is given a material number of 0. The neutron importance for this cell is 0.

```
8 0 14:3:-15 imp:n=0
```

6.3.B Materials

Material cards are constructed and entered as described previously, using the information provided in the problem description. Your material cards should resemble those in Figure 6-9. Materials 1 and 3 should use the $S(\alpha,\beta)$ thermal neutron scattering law for hydrogen in light water.

```

C Data Cards
C Material Cards
m1      1001.62c 6.1063-2 8016.62c 3.3487-2
        9019.62c 2.9554-3
        92235.66c 1.3784-3 92238.66c 9.9300-5
mt1 lwtr.60t
m2      13027.62c 1.0
m3      1001.62c 2          8016.62c 1
mt3 lwtr.60t

```

Figure 6-9. Example 6.3 material cards.

6.3.C MCNP Criticality Controls

The kcode specification is the same as in example 5. On the ksrc card, again we will put a criticality source point in each solution cylinder. Figure 6-10 shows the control cards for this example.

```

C Criticality Control Cards
kcode 5000 1.0 50 250
ksrc   0      0 11.7 -23.1  0  11.7  23.1 0 11.7
       -11.55 20.0 11.7 -11.5 -20.0 11.7
       11.55 20.0 11.7  11.5 -20.0 11.7

```

Figure 6-10. Example 6.3 criticality control cards.

For large problems with fissile material at many locations, MCNP has other methods of defining the initial starting source points. Whether the problem is tightly or loosely coupled may also affect your choice of method of initial source description. It is much more important to put at least one ksrc fission source point in each fissile region for a loosely coupled problem. {Further discussion can be found in the MCNP manual.}

6.3.D Example 6.3 MCNP Input File

The input for example 6.3 is complete. The input file should resemble the following. Do not forget the blank line delimiters.

Example 6-3, Hexagonal Lattice of Pu Cylinders

C Cell Cards

```

1 1 9.8983e-2 -1 5 -4 u=1 imp:n=1
2 0 -1 4 u=1 imp:n=1
3 2 -2.7 -2 (1:-5) u=1 imp:n=1
4 3 -1.0 2 u=1 imp:n=1
5 0 -8 11 -7 10 -12 9 lat=2 fill=1 u=2 imp:n=1
6 0 -13 6 -3 fill=2 imp:n=1
7 3 -1.0 (13:-6) -3 15 -14 imp:n=1
8 0 14:3:-15 imp:n=0

```

C Solution Cylinder Surface Cards

```

1 cz 7.60 $ outer radius of the solution
2 cz 7.75 $ outer radius of container
4 pz 23.4 $ top of solution
5 pz 0.0 $ bottom of solution
C Surfaces 7-12 are the array lattice cell
7 p 1 1.73205 0 23.1
8 px 11.55
9 p -1 1.73205 0 -23.1
10 p 1 1.73205 0 -23.1
11 px -11.55
12 p -1 1.73205 0 23.1

```

C Window Surfaces

```

3 pz 40.0 $ Top of aluminum cylinder
6 pz -1.0 $ bottom of aluminum container
13 cz 32.0 $ cylinder for array window

```

C Reflector Surfaces

```

14 cz 52.0 $ outer radius of reflector
15 pz -21.0 $ bottom edge of reflector

```

C Data Cards

C Material Cards

```

m1 1001.62c 6.1063-2 8016.62c 3.3487-2
    9019.62c 2.9554-3
    92235.66c 1.3784-3 92238.66c 9.9300-5
mt1 lwtr.60t
m2 13027.62c 1.0
m3 1001.62c 2 8016.62c 1
mt3 lwtr.60t

```

C Criticality Control Cards

```

kcode 5000 1.0 50 250
ksrc 0 0 11.7 -23.1 0 11.7 23.1 0 11.7
    -11.55 20.0 11.7 -11.5 -20.0 11.7
    11.55 20.0 11.7 11.5 -20.0 11.7

```

6.4 PLOT OF GEOMETRY

Before transporting particles be sure to run the plotter to check for errors in the geometry. The default px=0 view will give you a message stating:

"can't yet plot parallel to axis of hexagonal prism lattice."

"no plot because it would have been empty."

The only view you can currently get is the cross-sectional view in the z-plane so enter:

```
pz 10 ex 60
```

You will get the following plot displayed.

09/17/03 16:49:33
Example 6-2, Hexagonal Lattices

```

probid = 09/17/03 16:47:44
basis: XY
( 1.000000, 0.000000, 0.000000)
( 0.000000, 1.000000, 0.000000)
origin:
( 0.00, 0.00, 10.00)
extent = ( 60.00, 60.00)
        
```

Value for cel 1
in Cell 1
xyz = 0.00, 0.00, 10.00

CURSOR	Restore	CellLine
PostScript	ROTATE	
COLOR	SCALES 0	LEVEL
XY	YZ	ZX
LABELS	L1 sur	L2 off
MBODY		

[Click here or picture or menu](#)

UP	RT	IN	LF	Origin	.1	.2	Zoom	5.	10
----	----	----	----	--------	----	----	------	----	----

cel
imp
rho
den
vol
fcl
mas
put
mat
tap
win

PAR
N

		Redraw	Plot>		End
--	--	--------	-------	--	-----

The final combined k_{eff} estimator for this problem on a Windows 2000 Pentium 4 computer with the ENDF66c data library at LANL was 1.01637 with an estimated standard deviation of 0.00267 (1σ).

6.5 EXAMPLE 6.5: EXPANDED FILL CARD IN TRIANGULAR LATTICE

Example 6.3 was filled with seven identical items. As in Chapter 5, the `fill` specification was a single number. In Example 6.5, element $[0, -1, 0]$ has a material different than the other six elements. The expanded form of the fill card is used.

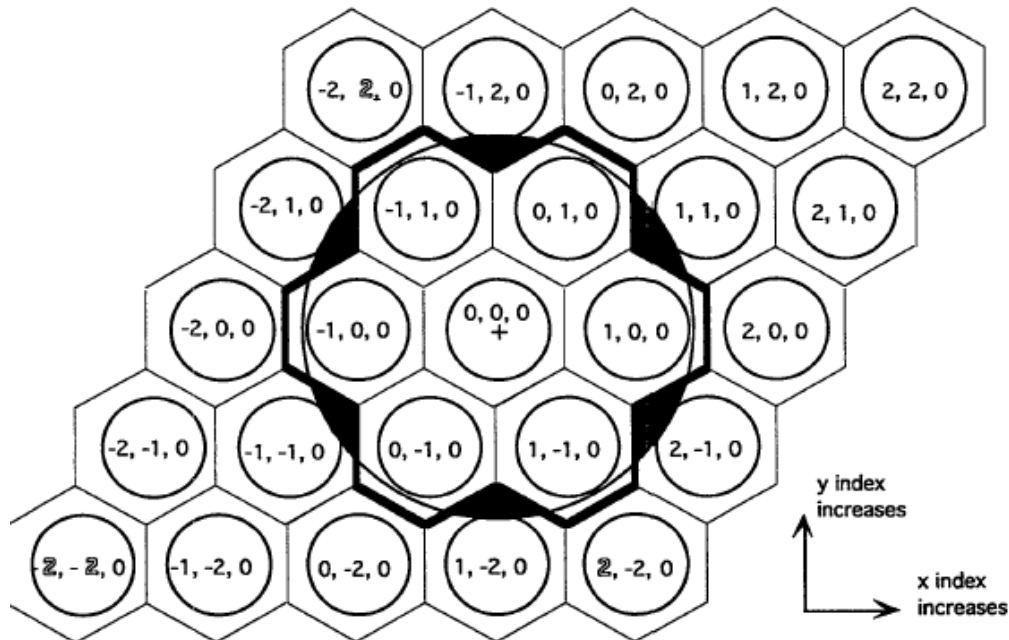

Figure 6-11. The 25 elements specified on the expanded `fill` card.

Figure 6-11 shows the range of the lattice and the individual element indices. The range of each index is the minimum and maximum of the lattice elements that are wholly or partially included in the “window” cell. The solid line outlines the seven elements of interest. The shaded regions inside the circle show the portions of the other six elements enclosed by the “window” cell. When using the explicit form of the `fill` card, at minimum, every element enclosed by the filled cell must be included in the range specification. The index numbers in an outlined font in Figure 6-11 show the lower and upper range values.

The cell card for lattice cell 5 follows.

```

5      0      -8 11 -7 10 -12 9  lat=2 u=2 fill=-2:2 -2:2 0:0
      2 2 2 1 2                      $ x=-2 to x=2; y=-2
      2 1 3 1 1                      $ "      "; y=-1
      2 1 1 1 2                      $ "      "; y=0
      1 1 1 1 2                      $ "      "; y=1
      2 1 2 2 2  imp:n=1 $ "      "; y=2

```

In this problem the x range is -2 to 2 (5 elements in x), the y range is -2 to 2 (5 elements in y), and the z range is 0 to 0 (1 element in z). Twenty-five universe numbers, one for each element, must be entered. Recall the order of index incrementing: first z, first y, all x; first z, second y, all x, etc. Some of the elements are clearly not involved in the area of interest, [-2, -2, 0] for example. Those elements can be filled with the universe number of the lattice cell itself, in this case universe 2, making those elements void. A small part of element [1, -2, 0] is included in the “window”, so it should be filled by universe 1.

The material in element [0, -1, 0] is changed from the uranium-fluoride solution to graphite. The universe number for the [0, -1, 0] element is 3. The following cells need to be added to the cell card section after surface 4 for universe 3.

```

9 like 1 but mat=4 rho=-1.60 u=3 imp:n=1
10 like 2 but u=3 imp:n=1
11 like 3 but u=3 imp:n=1
12 like 4 but u=3 imp:n=1

```

Also, add graphite to the materials using the following:

```

m4 6000.66c 1
mt4 grph.60t

```

Using Figure 6-11 and the 25 entries on the `fill` card, identify which element is filled by what universe on your own. Notice that the `fill` array has 5 rows and 5 columns. Each line corresponds to a horizontal row in Figure 6-11. In a large problem, this practice helps keep track of the entries in the large array.

The importance of all lattice elements is set to 1. Recall that no particles ever will be tracked in some of the elements. When a particle in element [1, 0, 0] crosses the cylindrical surface, it will enter cell 6 and be tracked at that level.

6.6 EXAMPLE 6.6: NONEQUILATERAL TRIANGULAR LATTICE

It is possible to describe a lattice that is not equilateral. Using the example 6.3 input, change the following surface cards:

MCNP Criticality Primer II

OLD			NEW		
1	cz	7.6	1	cz	4.6
2	cz	7.75	2	cz	4.75
8	px	11.55	8	px	5.55
11	px	-11.55	11	px	-5.55

The following plot will be displayed using the plot command: pz 10 ex 60

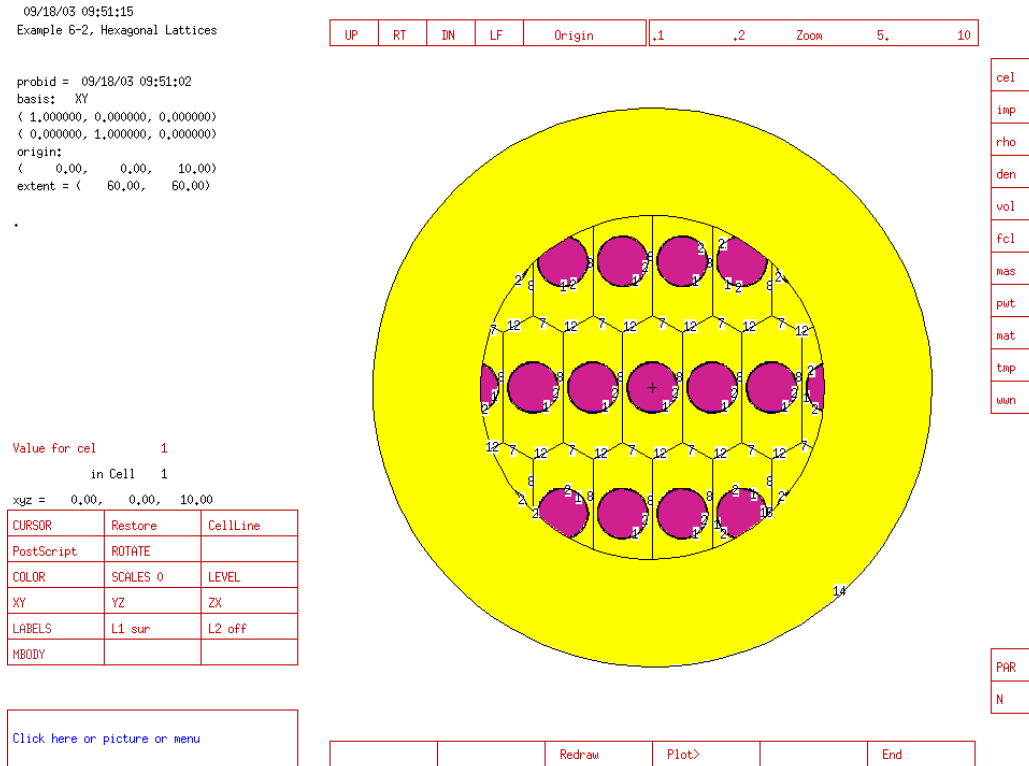

This section is not intended to make you an expert on describing nonequilateral hexagonal lattices. We just want to illustrate that MCNP can model many lattice shapes. The only requirements are that opposite sides must be identical and parallel and that the lattice must fill all space exactly.

6.7 SUMMARY

This chapter continued discussion of the lattice option in MCNP from the previous chapter by introducing a hexagonal array problem. The method used was very similar to that of the hexahedral array. We have shown the basics of using the lat keyword. {Please refer to the MCNP manual for a more detailed description of the use of

lattices with MCNP.) How to model a three-dimensional hexahedral lattice is discussed in Chapter 7.

Chapter 7: 3-Dimensional Square Lattices

This chapter builds on the example from Chapter 5 to create a three-dimensional square lattice of solution cylinders. Much of the example remains unchanged. If you do not understand the input in this example, refer to Chapter 5 for a more detailed description of this problem. The 3dimensional hexagonal lattice is constructed in a similar manner, so no examples are presented in this document.

7.1 WHAT YOU WILL BE ABLE TO DO

- 1) Create a 3-D hexahedral (square) lattice.
- 2) Fill the lattice elements with various materials.
- 3) Create a universe 0 lattice.

7.2 PROBLEM DESCRIPTION

This example is the hexahedral array of six plutonium nitrate solution cylinders (LA-1086O, page 125) from Chapter 5. It is modified to create a second layer of six elements for a total of 12 solution cylinders. Recall that the data for this problem is:

Plutonium Nitrate Solution

$N_{239} = 2.7682e-4$	Solution height = 39.24 cm
$N_{240} = 1.2214e-5$	
$N_{241} = 8.3390e-7$	
$N_{242} = 4.5800e-8$	
$N_{\text{Hydrogen}} = 6.0070e-2$	
$N_{\text{Oxygen}} = 3.6540e-2$	
$N_{\text{Nitrogen}} = 2.3699e-3$	
$N_{\text{Total}} = 9.9270e-2$	

Stainless Steel Containers

$N_{\text{Iron}} = 6.3310e-2$	3x2x2 Hexahedral (square) lattice
$N_{\text{Chromium}} = 1.6540e-2$	All surface separations = 10.0 cm
$N_{\text{Nickel}} = 6.5100e-3$	Tank i.d. = 24.98 cm
$N_{\text{Total}} = 8.6360e-2$	Tank wall thickness = 0.30 cm
	Tank top and bottom thickness = 1.0 cm
	Inside height = 101.7 cm
	Tank Pitch = 35.58 cm

7.3 EXAMPLE 7.3: 3D (3x2x2) LATTICE

7.3.A Solution Cylinder

In Chapter 5 cells 1-4 define the solution cylinder (see Figure 53). For this example cells 1 and 2 are not changed. Cells 3 and 4 will be modified. Cell 3 is the stainless steel container. In Chapter 5, the stainless steel was infinite in the z direction. Because we now want a 10 cm vertical spacing between the cylinders, a plane must be added to limit the cylinder top thickness. We will still use the lattice window cell to define the bottom thickness so cell 3 can remain infinite in -z. Cell 3 is now all space with a negative sense wrt surface 2, with a negative sense wrt surface 4, not in cell 1, and not in cell 2.

Because of the change to cell 3, the description of cell 4 has to be changed also. Cell 4, the void region between the cylinders, is now defined as all space with a positive sense wrt surface 2 unioned with all space having a positive sense wrt surface 4. Cells 1-4 belong to universe 1. Figure 7-1 shows the descriptions of cells 1-4, while Figure 7-2 shows the surface cards used in cells 1-4. Figure 7-3 shows the geometry created by cell cards 1-4.

Example 7-3, 3-D (3x2x2) Lattice.

C Cell Cards

1	1	9.9270e-2	-1	5	-6	u=1	imp:n=1
2	0		-1	6	-7	u=1	imp:n=1
3	2	8.6360e-2	-2	-4	#1 #2	u=1	imp:n=1
4	0		2:4			u=1	imp:n=1

Figure 7-1. Cell cards 1-4 with title card.

```

C Solution Cylinder Surface Cards
1 cz 12.49 $ Inner cylinder
2 cz 12.79 $ Outer SS cylinder
4 pz 102.7 $ Top of SS tank
5 pz 0.0 $ Bottom of solution
6 pz 39.24 $ Top of solution
7 pz 101.7 $ Top of void above soln.
    
```

Figure 7-2. Surface cards for cells 1-4.

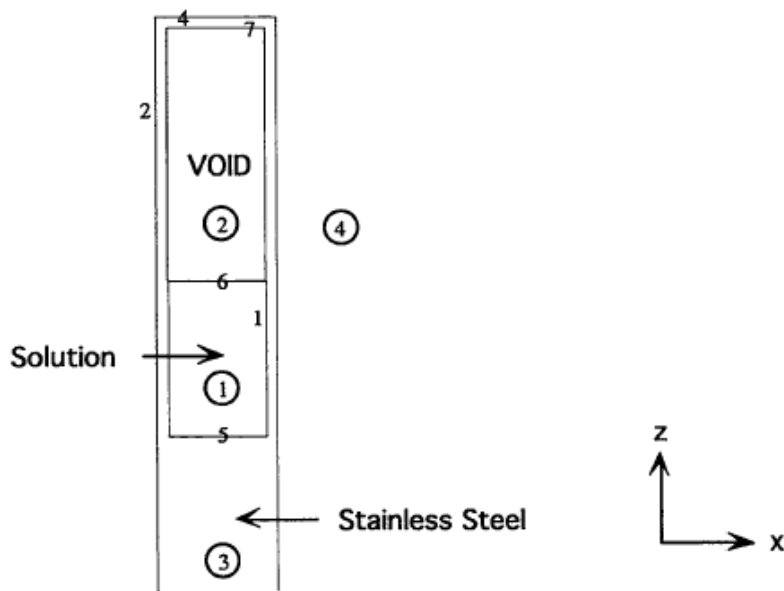

Figure 7-3. Geometry created by cell cards 1-4.

7.3.B Square Lattice Cell

In Chapter 5, the lattice cell was finite in only the x and y directions. We will now change the lattice cell 5 description so it is finite in the x, y, and z directions by adding pz surfaces 16 and 3 to the cell description. The geometry defined by cell 5 is shown in Figure 7-4.

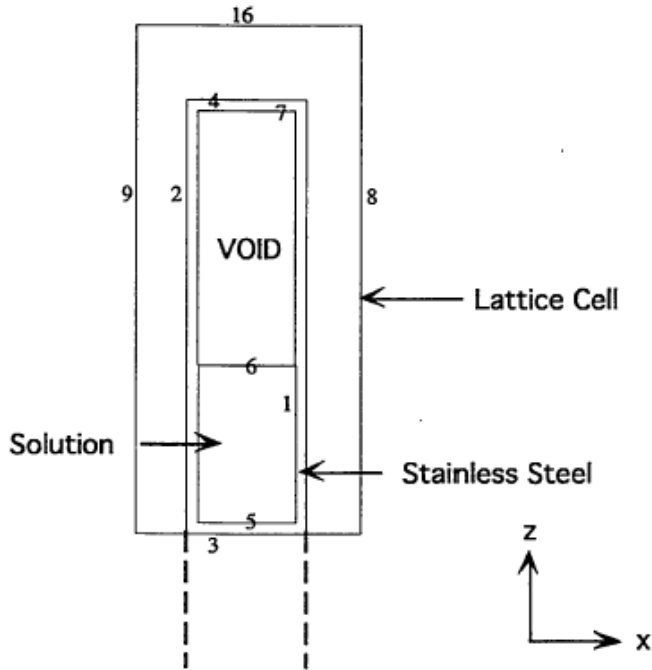

Figure 7-4. Geometry defined by lattice cell.

Because the lattice is filled with a universe, placing surface 3 at $pz = -1.0$ effectively makes the stainless steel container bottom 1 cm thick. Surface 16 at $pz = 112.7$ cm provides 10 cm of vertical spacing between the two layers of cylinders. When cell 5 is defined to be a square lattice ($lat=1$), an infinite number of square lattice cells is created in all three dimensions. Cell 5 still belongs to universe 2. The lattice cell 5 description is shown below.

```
5 0 -8 9 -10 11 -16 3 lat=1 fill=1 u=2 imp:n=1
```

Add the following two lines to the surface card section:

```
3 pz -1.0
16 pz 112.7 $ Top of lattice cell.
```

7.3.C Lattice Window

Next, a window cell needs to be defined, cell 6, that will limit the infinite lattice to 12 solution cylinders in a $3 \times 2 \times 2$ configuration. On the cell 6 card, surfaces 3 and 4 are deleted and surfaces 17 and 18 are added, making two layers of solution cylinders. Surface 18 is just inside (above) the cylinder bottom, and surface 17 is just below surface

16. These surfaces limit the infinite lattice in the z direction. Cell 6 still is filled by universe 2. The description of cell 6 follows.

```
6 0 13 -12 15 -14 18 -16 fill=2 imp:n=1
```

Add the following line to the surface card section:

```
18 pz -114.7 $ Bottom of lattice cell.
```

7.3.D “Rest of the World”

The final cell for this problem, cell 7, defines the “rest of the world”. Cell 7 is given a material number of 0 and a neutron importance of 0.

```
7 0 -13:12:-15:14:-18:16 imp:n=0
```

7.4 MATERIALS

The material cards for this problem do not require any change from example 5 and can be copied directly as shown in Figure 7-5.

C Data Cards

C Material Cards

```
m1 1001.62c 6.0070-2 8016.62c 3.6540-2
    7014.62c 2.3699-3
    94239.66c 2.7682-4 94240.66c 1.2214-5
    94241.66c 8.3390-7
    94242.666c 4.5800-8
mt1 lwtr.60t
m2 24050.62c 7.195-4 24052.62c 1.38589-2
    24053.62c 1.5713-3 24054.62c 3.903-4
    26056.62c 3.704-3 26056.62c 5.80869-2
    26057.62c 1.342-3 26058.62c 1.773-4
    28058.62c 4.432-3 28060.62c 1.7069-3
    28061.62c 7.42-5 28062.62c 2.363-4
    28064.62c 6.05-5
```

Figure 7-5. Example 7.3 material cards.

7.5 MCNP CRITICALITY CONTROLS

The kcode specification remains the same from the previous example. Six source points are added on the `ksrc` card to those defined in example 5, so each solution cylinder has a source point. Figure 7-6 shows the control cards for this example.

C Criticality Control Cards

```

kcode 5000 1.0 50 250
ksrc 0 0 19.62 35.58 0 19.62 71.16 0 19.62
      0 35.58 19.92 35.58 35.58 19.62 71.16 35.58 19.62
C These source points are place in the added cylinders
      0 0 -94.08 35.58 0 -94.08 71.16 0 -
94.08
      0 35.58 -94.08 35.58 35.58 -94.08 71.16 35.58 -
94.08

```

Figure 7-6. Example 7.3 control cards.

7.6 EXAMPLE 7.3 MCNP INPUT FILE

The input requirements for this example are complete. The input file should resemble the following.

Example 7-3, 3-D (3x2x2) Lattice

C Cell Cards

```

1 1 9.9270e-2 -1 5 -6 u=1 imp:n=1
2 0 -1 6 -7 u=1 imp:n=1
3 2 8.6360e-2 -2 -4 #1 #2 u=1 imp:n=1
4 0 2:4 u=1 imp:n=1
5 0 -8 9 -10 11 -16 3 lat=1 u=2 fill=1 imp:n=1
6 0 9 -12 11 -14 18 -16 fill=2 imp:n=1
7 0 -9:12:-11:14:-18:16 imp:n=0

```

C Solution Cylinder Surface Cards

```

1 cz 12.49 $ Inner cylinder
2 cz 12.79 $ Outer SS cylinder
4 pz 102.7 $ Top of SS tank
5 pz 0.0 $ Bottmon of Solution
6 pz 39.24 $ Top of Solution
7 pz 101.7 $ Top of void above soln.

```

C Beginning of Lattice Surfaces

```

8 px 17.79
9 px -17.79
10 py 17.79
11 py -17.79

```

C Window Surfaces

```

3 pz -1.0
12 px 88.95
14 py 53.37

```

C Surfaces 16 and 18 bound the lattice in the z direction

```

16 pz 112.7 $ Top of lattice cell
18 pz -114.7 $ Bottom of lattice cell

```

C Data Cards**C Material Cards**

```
m1 1001.62c 6.0070-2 8016.62c 3.6540-2
    7014.62c 2.3699-3
    94239.66c 2.7682-4 94240.66c 1.2214-5
    94241.66c 8.3390-7 94242.666c 4.5800-8
```

```
mt1 lwtr.60t
```

```
m2 24050.62c 7.195-4 24052.62c 1.38589-2
    24053.62c 1.5713-3 24054.62c 3.903-4
    26056.62c 3.704-3 26056.62c 5.80869-2
    26057.62c 1.342-3 26058.62c 1.773-4
    28058.62c 4.432-3 28060.62c 1.7069-3
    28061.62c 7.42-5 28062.62c 2.363-4
    28064.62c 6.05-5
```

C Criticality Control Cards

```
kcode 5000 1.0 50 250
```

```
ksrc 0 0 19.62 35.58 0 19.62 71.16 0 19.62
      0 35.58 19.92 35.58 35.58 19.62 71.16 35.58 19.62
```

C These source points are place in the added cylinders

```
0 0 -94.08 35.58 0 -94.08 71.16 0 -
94.08
0 35.58 -94.08 35.58 35.58 -94.08 71.16 35.58 -
94.08
```

7.7 OUTPUT

The final combined k_{eff} estimator for this problem on a Windows 2000 Pentium 4 computer with the ENDF66c data library at LANL was 0.99588 with an estimated standard deviation of 0.00102 (1σ).

7.8 PLOT OF GEOMETRY

Before transporting particles, run the plotter to check for geometry errors in the cell descriptions. The default plot extent will show only part of the geometry. Change the extent to bring the entire geometry into view:

```
ex 150
```

The plot should appear as follows

MCNP Criticality Primer II

```
09/19/03 09:18:39
Example 7-3, 3-D Hexagonal
Lattices
```

```
probid = 09/19/03 09:07:16
basis: YZ
( 0.000000, 1.000000, 0.000000)
( 0.000000, 0.000000, 1.000000)
origin:
( 0.00, 0.00, 0.00)
extent = ( 150.00, 150.00)
```

UP	RT	IN	LF	Origin	.1	.2	Zoom	5.	10.
----	----	----	----	--------	----	----	------	----	-----

cel
imp
rho
den
vol
fcl
mas
put
mat
tmp
win

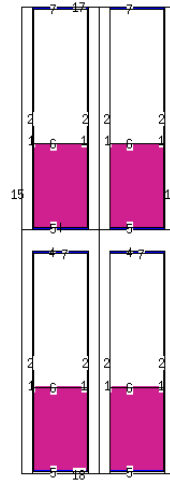

```
Value for cel      1
in Cell 1
xyz = 0.00, 0.00, 0.00
```

CURSOR	Restore	CellLine
PostScript	ROTATE	
COLOR	SCALES 0	LEVEL
XY	YZ	ZX
LABELS	L1 sur	L2 off
MBODY		

PAR
N

[Click here or picture or menu](#)

	Redraw	Plot>	End
--	--------	-------	-----

7.9 EXAMPLE 7.9: 3-D LATTICE WITH ONE WATER ELEMENT

Now we want to change the material in one of the cylinders in this system. Recalling what we learned in Chapter 5, each lattice element has a unique lattice location identifier. The $[0, 0, 0]$ element is the one described on the lattice cell card. The indices increase and decrease according to the order of the surfaces entered on the lattice cell card. The first index increases in the $+x$ direction, and the second index increases in the $+y$ direction as in Chapter 5. The fifth surface listed is the pz plane with the largest z value, and the sixth is the pz plane with the smallest z value, so the third index increases in $+z$ direction. The range of the indices for cell 6 are $0:2, 0:1, \text{ and } -1:0$. The elements are incremented as follows: do all x for the first y , first z ; do all x for the second y , first z ; do all x for all y , first z ; do all x for the first y , second z ; do all x for the first y , second z , etc. With this in mind, we replace the fissile solution in element $(1, 1, -1)$ with water.

A water-filled cylinder will be defined and belong to universe 3. The geometry for universe 3 is identical to universe 1. Only the material in cell 1 is different. The four cells belonging to universe 3, shown below, can be added to the cell cards section of example 7 after cells 1-4.

MCNP Criticality Primer II

```
11 like 1 but mat=3 rho=-1.0 u=3 imp:n=1
12 like 2 but                u=3 imp:n=1
13 like 3 but                u=3 imp:n=1
14 like 4 but                u=3 imp:n=1
```

The complete lattice cell 5 card is now:

```
5 0 -8 9 -10 11 -16 3 lat=1 u=2 fill=0:2 0:1 -1:0 1 1 1 1 3 1
                                     1 1 1 1 1 1
                                     imp:n=1
```

Cell 11 is defined with material 3, so an m3 card, water, must be added to the data card section. Because we are using water, $S(\alpha,\beta)$ cross-section data for hydrogen in water are used. The new material cards are:

```
m3 1001.62c 2 8016.62c 1
mt3 lwtr.60t
```

All elements except one are filled with universe 1, while the [1,1, -1] element is filled with universe 3. An alternative way of writing cell 5 is:

```
5 0 -8 9 -10 11 -16 3 lat=1 u=2 imp:n=1 fill=0:2 0:1 -1:0
                                     1 1 1 1 3 1 1 5r
```

where 5r repeats the previous universe value 5 more times.

The final combined k_{eff} estimator for this problem on a Windows 2000 Pentium 4 computer with the .66c, .62c and .60t data libraries at LANL was 0.99243 with an estimated standard deviation of 0.00095 (1σ).

7.10 USING SDEF INSTEAD OF KSRC

Although the `ksrc` can be used to specify explicit source points, the `sdef` card can alternatively be used to specify complex source distributions in a criticality simulation. Using either method only affects the source distribution in the first cycle of a criticality simulation, and subsequent cycles use the locations of fission events.

The `sdef` card can be used in a criticality calculation to specify a source points in a volume or distribution of points in the same manner as it can be used in a fixed-source simulation. Sampled source points which are not in fissile material are accepted.

When repeated structures are used, the “path” to the lowest level cell can be specified, using the same syntax as for a tally. If this path is given, coordinates given on the `pos`, `x`, `y` or `z` keywords apply to the “local” coordinate system. The syntax is a

parenthesize-contained sequence of cells in consecutive universe levels, separated by “<” and ending with the appropriate universe 0 cell. These cells occupy the same volume but in different universes. A path used for specifying source locations cannot contain more than one cell on the same universe level. Additionally, the path cannot be an entry on the `sdef` card, but must be entered on a `si` distribution used by the `cel` keyword on the `sdef` card. If a cell in the path is a lattice, the lattice indices should also be specified.

For example, the following cards illustrate the use of the `sdef`, `si` and `sp` cards to be used in place of the `ksrc` card in example 7-9.

```

sdef cel=d1 pos=0 0 20.62
si1 L (1<5[0 0 -1]<6) (1<5[1 0 -1]<6) (1<5[2 0 -1]<6)
      (1<5[0 1 -1]<6) (1<5[0 1 -1]<6) (1<5[2 1 -1]<6)
      (1<5[0 0 0]<6) (1<5[1 0 0]<6) (1<5[2 0 0]<6)
      (1<5[0 1 0]<6) (1<5[1 1 0]<6) (1<5[2 1 0]<6)
sp1      1 1 1 1 1 1 1 1 1 1 1

```

The `sdef` keyword `cel=d1` says that the source cells are given by a distribution, where `d1` points to the `si1` card. The keyword `pos` defines the xyz location of the source point. The `si1` card describes the path to the level 0 universe cell, starting with the cell which contains the source point (cell 1) which fills the lattice cell (5) and each individual lattice element [0 0 -1]. Finally, the universe 0 cell is listed. The L on the `si1` card indicates that discrete values will follow. Because element 5 [1 1 -1] contains only water, it is not included in the list on the `si1` card. The `sp1` card provides the probabilities of choosing a particular cell. In this case, the probabilities are equal. Lattice element entries cannot be specified on the `sdef` card, a `si`, `sp` distribution must be used, even if only one lattice element is specified. {To understand the cards above, see the MCNP manual, Chapter 3, Section D.}

If a universe level path is not given, coordinates given apply to the global coordinate system. For example, the alternative form of the `sdef` card can be used, with the same coordinates as would be given on the `ksrc` card.

```

sdef pos=d1
si1 L 0 0 19.62 35.58 0 19.62 71.16 0
19.62
      0 35.58 19.92 35.58 35.58 19.62 71.16 35.58
19.62
      0 0 -94.08 35.58 0 -94.08 71.16 0 -
94.08
      0 35.58 -94.08 35.58 35.58 -94.08 71.16 35.58 -
94.08
sp1      1 1 1 1 1 1 1 1 1 1 1

```

7.11 SUMMARY

This chapter modified the example from Chapter 5 and made the lattice 3-dimensional by defining a lattice cell that was finite in the x, y, and z directions. We showed how to specify each element of a 3-dimensional hexahedral lattice and discussed a universe 0 lattice. {Please refer to the MCNP manual for a more detailed description of the use of lattices with MCNP.}

Chapter 8: Advanced Topics

8.1 What you will be able to do

In this chapter, you will learn:

- 1) How to verify that the fission source distribution and k_{eff} have converged.
- 2) The importance of the total vs. prompt \bar{u} .
- 3) The importance of delayed neutron data and how to use it.
- 4) The importance of the unresolved resonance treatment and how to use it.

8.2 Convergence of Fission Source Distribution and K_{eff}

When a `ksrc` card is used to specify the initial spatial distribution of fission events in fissile material, this distribution is a rough approximation to the actual distribution. While subsequent cycles track neutrons and record new fission distributions, it may take many cycles, ten or hundreds depending on the problem, before this distribution reaches the fundamental mode. Until the fundamental mode is reached, cycles should not be used in the final calculation of k_{eff} . This is why the 3rd entry on the `kcode` card, i.e. the number of “skipped” cycles, should be greater than 50, as a general rule, not always necessary. Check to see if σ_{min} occurs in a skipped cycle, as described in the following paragraph.

For complex geometries or weakly coupled systems, skipping 50 cycles may not be enough. To verify that the fission source distribution has reached fundamental mode within these skipped cycles, open the output file and search for the line:

```
lindividual and collision/absorption/track-length keffs for
different numbers of inactive cycles skipped for fission
source settling
```

The subsequent table will list the active neutrons and estimated k_{eff} assuming the problem had been run with the number of skipped cycles given. Read down the column for the combined k_{eff} estimate (`normality average k(c/a/t)`), the estimated standard deviation will very likely, but not always, be at a minimum when the fundamental mode is reached. The cycle when this minimum occurs should be an inactive cycle. The cycle marked with the asterisk indicated the number of actual skipped cycles, i.e. the number of skipped cycles specified on the `kcode` card. If the asterisk appears in a cycle before this minimum is reached, the number of skipped cycles needs to be increased and the problem should be re-run.

The statistical behavior of k_{eff} should be analyzed. By looking at the table of the estimated k_{eff} and one standard deviation interval vs cycle number (`plot of the estimated col/abs/track-length keff one standard deviation`

interval versus cycle number). As the cycle numbers approach the final cycle, the value of k_{eff} should oscillate around the final value of k_{eff} . The final standard deviation should also be less than 0.001. For values higher than this, the estimation of the standard deviation is suspect and may not be correct.

8.3 Total vs. prompt \bar{u} & Delayed Neutron Data

A small but important fraction (~1%) of the neutrons emitted in fission events are delayed neutrons emitted as a result of fission-product decay at times later than prompt fission neutrons. MCNP users have always been able to specify whether or not to include delayed fission neutrons by using either \bar{u}_{tot} (prompt plus delayed) or \bar{u} (prompt only).

However, in versions of MCNP up through and including 4B, all fission neutrons (whether prompt or delayed) were produced instantaneously and with an energy sampled from the spectra specified for prompt fission neutrons.

For many applications this approach is adequate. However, it is another example of a data approximation that is unnecessary. Therefore, Versions 4C and later of MCNP allow delayed fission neutrons to be sampled from time and energy spectra as specified in nuclear data evaluations. The libraries with detailed delayed fission neutron data are listed in Table G-2 with a “yes” in the “DN” column.

If (1) MCNP is using \bar{u}_{tot} , (2) the data for the collision isotope includes delayed-neutron spectra, and (3) the use of detailed delayed-neutron data has not been preempted (see the PHYS:N card in the MCNP5 Manual), then each fission neutron is first determined by MCNP to be either a prompt fission neutron or a delayed fission neutron. Assuming analog sampling, the type of emitted neutron is determined from the ratio of delayed $\bar{u}(E_{\text{in}})$ to total $\bar{u}(E_{\text{in}})$.

The explicit sampling of a delayed-neutron spectrum implemented in MCNP 4C and more recent versions has two effects. One is that the delayed neutron spectra have the correct energy distribution; they tend to be softer than the prompt spectra. The second is that experiments measuring neutron decay after a pulsed source can now be modeled with MCNP because the delay in neutron emission following fission is properly accounted for. In this treatment, a natural sampling of prompt and delayed neutrons is implemented as the default and an additional delayed neutron biasing control is available to the user via the PHYS:N card. The biasing allows the number of delayed neutrons produced to be increased artificially because of the low probability of a delayed neutron occurrence. The delayed neutron treatment is intended to be used with the TOTNU option in MCNP, giving the user the flexibility to use the time-dependent treatment of delayed neutrons whenever the delayed data are available. For more information on the TOTNU option and the PHYS:N card see Chapter 2, Section IV (Physics), Subsection C (Neutron Interactions) in the MCNP Manual.

The impact of sampling delayed-neutron energy spectra on reactivity calculations has been studied. As expected, most of the reactivity impacts are very small, although changes of 0.1-0.2% in k_{eff} were observed for certain cases. Overall, inclusion of delayed-neutron spectra can be expected to produce small positive reactivity changes for systems with significant fast neutron leakage and small negative changes for some systems in which a significant fraction of the fissions occurs in isotopes with an effective fission threshold (e.g., ^{238}U and ^{240}Pu).

8.4 Unresolved Resonance Treatment

Within the unresolved resonance range (e.g., in ENDF/B-VI, 2.25 - 25 keV for ^{235}U , 10 - 149.03 keV for ^{238}U , and 2.5 - 30 keV for ^{239}Pu), continuous-energy neutron cross sections appear to be smooth functions of energy. This behavior occurs not because of the absence of resonances, but rather because the resonances are so close together that they are unresolved. Furthermore, the smoothly-varying cross sections do not account for resonance self-shielding effects, which may be significant for systems whose spectra peak in or near the unresolved resonance range.

Fortunately, the resonance self-shielding effects can be represented accurately in terms of probabilities based on a stratified sampling technique. This technique produces tables of probabilities for the cross sections in the unresolved resonance range. Sampling the cross section in a random walk from these probability tables is a valid physics approximation so long as the average energy loss in a single collision is much greater than the average width of a resonance; that is, if the narrow resonance approximation is valid. Then the detail in the resonance structure following a collision is statistically independent of the magnitude of the cross sections prior to the collision.

The utilization of probability tables is not a new idea in Monte Carlo applications. Versions of MCNP up through and including 4B did not take full advantage of the unresolved resonance data provided by evaluators. Instead, smoothly varying average cross sections were used in the unresolved range. As a result, any neutron self-shielding effects in this energy range were unaccounted for. Better utilizations of unresolved data have been known and demonstrated for some time, and the probability table treatment has been incorporated into MCNP Version 4C and its successors. The column "UR" in Table G.2 of Appendix G lists whether unresolved resonance probability table data is available for each nuclide library.

Sampling cross sections from probability tables is straightforward. At each of a number of incident energies there is a table of cumulative probabilities (typically 20) and the value of the near-total, elastic, fission, and radiative capture cross sections and heat deposition numbers corresponding to those probabilities. These data supplement the usual continuous data; if probability tables are turned off (see PHYS:N card in the MCNP5 Manual), then the usual smooth cross section is used. But if the probability tables are turned on (default), if they exist for the nuclide of a collision, and if the energy of the collision is in the unresolved resonance energy range of the probability tables, then the cross sections are sampled from the tables.

MCNP Criticality Primer II

The impact of the probability-table approach has been studied and found to have negligible impact for most fast and thermal systems. Small but significant changes in reactivity may be observed for plutonium and ^{233}U systems, depending upon the detailed shape of the spectrum. However, the probability-table method can produce substantial increases in reactivity for systems that include large amounts of ^{238}U (or other actinides with effective thresholds for fission) and have high fluxes within the unresolved resonance region. Calculations for such systems will produce significantly *nonconservative* results unless the probability-table method is employed.

For more information on unresolved resonance probability tables, see Chapter 2, Section IV (Physics), Subsection C (Neutron Interactions) of the MCNP5 Manual.

Primer summary

This document was designed to help a nuclear criticality safety analyst understand and use the MCNP Monte Carlo code. It began with a simple criticality problem, the Quickstart chapter, that introduced the basic concepts of using MCNP. The chapters that followed expanded on the ideas presented in the Quickstart chapter by presenting a varying range of problems from simple cylinders to 3-dimensional lattices. Although this primer was written to stand alone, it is recommended that it be used in conjunction with the MCNP5 manual. Many of the concepts discussed in the primer are described in greater detail in the MCNP manual.

After completing this primer, a criticality analyst should be capable of handling a majority of the situations that will arise in the field of nuclear criticality safety. The input files provided in the document can be modified by the analyst to fit a particular problem as required.

The primer provides the necessary information to create and run criticality problems; it does not attempt to teach the theory of neutron interaction. MCNP is only capable of analyzing the problem specified and will not know whether or not the problem was described correctly or if the proper materials were input. We remind you that a single calculation of k_{eff} and its associated confidence interval with MCNP in any other code is meaningless without an understanding of the context of the problem, the quality of the solution, and a reasonable idea of what the result should be.

APPENDIX A: Monte Carlo Techniques

I. INTRODUCTION

Monte Carlo methods are used in nuclear applications such as shielding, radiation transport, and neutron physics analysis. Monte Carlo refers to a statistical method wherein the expected characteristics of particles (e.g. particle flux) are estimated by sampling a large number of individual particle histories whose trajectories are simulated by a digital computer. In some cases, there are equations that adequately describe the behavior of such systems and that can be solved either analytically or numerically. Why then, if this is the case, would anyone want to use Monte Carlo techniques? The basic advantage of Monte Carlo techniques over the deterministic techniques (e.g., numerical solution of the Boltzmann transport equation) is that Monte Carlo more accurately represents the geometry and nuclear data than do deterministic techniques. Deterministic methods require reasonably simple geometries for the numerical techniques to work and use multigroup group approximations to continuous energy neutron cross section data. Monte Carlo techniques can handle complex geometries and continuous cross section data, as well as the simple geometries and multigroup data.

In many cases, the geometry of a system is more complex than a cylinder or a stack of cubes; it often includes both cylindrical and planar surfaces. For these situations, Monte Carlo is a better technique as it statistically evaluates the system with few approximations rather than trying for a numerical approximation to the analytic description. The disadvantages of Monte Carlo are that it is statistical in nature and does not provide an exact solution to the problem. All results represent estimates with associated uncertainties. Also, Monte Carlo techniques can be quite time consuming on a computer if very small uncertainties are required. The relationship between Monte Carlo and deterministic techniques can best be summarized as: deterministic techniques provide an exact solution to an approximation of the problem while Monte Carlo techniques provide an approximate solution to an exact representation of the problem.

II. MONTE CARLO APPROACH

When a neutron traverses a material, it interacts with the constituent atoms of that material. It gets scattered or absorbed depending on the process cross sections of the material. These processes occur statistically in nature with the probability of occurrence determined by a cross section. No one can predict exactly how far one particle will travel in a material before interacting; however, one can predict the distribution of flight distances that a large number of those particles will have prior to the first interaction. Using “random” numbers, the computer can generate a statistical history for the life of each particle (a random walk analysis). That is, an individual particle may experience many scattering interactions before finally being absorbed or leaking from the system. Random numbers (a set of numbers which have no pattern and are sampled uniformly between zero and one) are used at each interaction to determine which process (absorption, fission, elastic scattering, etc.) occurs, how much energy is lost, what is the new direction of the particle (for scattering), or how many neutrons are created in a

fission event. The life of a particle begins at birth, either from an external neutron source or from a fission event, and ends with absorption or with a scattering event that moves the neutron outside the assembly. The events that occurs during a particle's life are tabulated and become the history of that particle. Because a single particle is usually not representative of the total system, a number of histories must be evaluated to accurately describe what occurs.

III. CRITICALITY CALCULATIONS

In criticality applications, the effective multiplication factor of an assembly is of primary interest. In these calculations, a group of neutron histories is often referred to as a k_{eff} cycle (or neutron generation as defined in reactor theory) with the multiplication factor of the assembly given by the ratio of the number of neutrons generated at the end of the k_{eff} cycle (i.e., those created in fission events in this cycle) to the number of neutrons whose histories are evaluated in this cycle (i.e., the number at the start of the generation). The expected value of the multiplication factor is then estimated by averaging over the events in the k_{eff} cycle. In the same way, the expected value of the leakage probability or the fraction of events leading to capture can also be obtained.

The relative error in the estimate of the effective multiplication factor will usually decrease as the number of k_{eff} cycles increases. Thus, numerous cycles are necessary to arrive at a good estimate of k . In addition, the first few cycles are inaccurate because the spatial neutron source has not converged. Because the distribution of source (fission) neutrons in a system is dependent on the eigenvalue of the system and on its geometry, it takes a number of inactive cycles for the Monte Carlo spatial neutron distribution to approach the converged distribution. For this reason, the first few cycles (the third number on the `kcode` card) are ignored in the final estimate of k_{eff} . The estimates of k_{eff} from the remaining cycles are averaged to obtain a mean value for the effective multiplication factor.

For example, let's say we evaluated G generations and discarded the first D of them. (It is recommended that $G - D > 100$ to observe any trends in the calculations.) Then the estimated effective multiplication factor of the system is given by

$$\bar{k} = \frac{1}{(G - D)} \sum_{i=D+1}^G k_i$$

where \bar{k} is the estimated system multiplication factor and k_i is the multiplication factor determined from the i^{th} cycle. The repeatability of the estimate (i.e., if the same calculation is performed with different random numbers, how much different will the estimate of k be?) is determined from the estimated standard deviation of the mean. The standard deviation of the mean is calculated using the standard deviation, σ , of the distribution of k -values.

$$s = \sqrt{\frac{1}{(G - D - 1)} \sum_{i=D+1}^G (k_i - \bar{k})^2}$$

For a valid Monte Carlo calculation, the range $\bar{k} - \sigma$ to $\bar{k} + \sigma$ should include the precise k_{eff} result about 68% of the time. The final result of the Monte Carlo calculation would be reported as: $\bar{k} \pm \sigma$ for a nominal 68% confidence interval, $\bar{k} \pm 2 \sigma$ for 95% and $\bar{k} \pm 2.6 \sigma$ for a 99% confidence interval for large N. These percentages refer to the fraction of the time the precise value of \bar{k} is included in a confidence interval. MCNP has three different estimators for k_{eff} : collision, absorption, and track length between collisions. A statistically combined average is used as the final k_{eff} . {See Chapter 2 of the MCNP manual for a detailed discussion of the different estimators.}

Grey Box 18. – Example Monte Carlo Process.**Example Monte Carlo Process**

The basic analog Monte Carlo approach can be summarized as follows: a sequence of random numbers $0 < R_i < 1$ is used to produce a random distribution of quantities that simulate the problem at hand. For example, with a one-dimensional slab of fissile material, it is desired to calculate the effective multiplication factor of the finite slab. The process could be done as follows:

- 1) For the initial k_{eff} cycle, determine the initial position of the neutron
- 2) Use a random number to select the energy for the neutron (based on χ , the energy distribution of the fission neutrons).
- 3) Use the next random number to determine the direction cosine for the neutron.
- 4) Determine the location of the next collision with the next random number (the distance traveled depends on the total cross section of the material).
- 5) Check the new location to see if the particle has escaped (leaked) from the system. If it has, add one to the total leaked and then go back to step 1 and start another history with another neutron. Otherwise, go to step 6.
- 6) Determine which type of interaction occurred at the new position based on the next random number. Each type of interaction has an associated cross section that determines its probability of occurrence.
 - a. If the interaction is scattering, then determine the new energy of the neutron after scattering using the next random number. Then go to step 3 and continue following the neutron (ie. determine the direction of the scattered neutron).
 - b. If the interaction is absorption, go to step 1 and start a new neutron in the system.
 - c. If the interaction is fission, use $\bar{\nu}$, to determine how many neutrons are created in this fission event and tabulate the total number of new neutrons created in this k_{eff} cycle. Also store the location of the fission event with each of the new neutrons so that they can be started at this location in the next cycle (this replaces step 1 in all future k_{eff} cycles)
- 7) When a given set of histories has been completed (enough to provide reasonable statistics), evaluate k_{eff} by dividing the number of new neutrons created in this cycle by the number of histories evaluated in the cycle.

Repeat the process for as many cycles as required to obtain appropriate statistics.

IV. Monte Carlo Common Terms.

The following is a listing of common terms used in Monte Carlo techniques:

1. Monte Carlo – A numerical analysis technique that uses random sampling to estimate the solution of a physical or mathematical problem.
2. Random Numbers – An infinite set of numbers that are uniformly distributed from 0 to 1 and are independent. We actually use pseudorandom numbers, a deterministic reproducible sequence of random numbers generated by a computer that satisfies statistical tests for randomness.
3. Monte Carlo Weight - The number of physical particles W that a Monte Carlo particle represents. The weight can be a fraction.
4. Random Walk – The random selection of events for a particle history.
5. History – The complete random walk of a Monte Carlo particle from its birth in the source to its death, including all progeny.
6. Monte Carlo Track-A branch, or subset, of a history that can be obtained by physical events (for example, fissions) or by variance reduction techniques (for example, geometry splitting)
7. Score-Contribution from a track to a tally.
8. History Score – Sum of all scores from one source particle's tracks.
9. Tally – Used interchangeably with score. Also, the quantity we want to estimate (average score), obtained by summing all scores from all histories. Sometimes called an
10. Relative Error – The standard deviation of the mean of a tally or k_{eff} , divided by the mean. The error refers to the precision of the tally, not to its accuracy.
11. Importance – the expected score per unit weight of a track at phase-space point.
12. Flux – The product of particle density and particle speed. The flux is mathematically and physically equivalent to the sum of the lengths of all Monte Carlo tracks per unit volume per unit time. Flux is in units of particles/cm²/shake.
13. Fluence – Integral of flux over time. If the MCNP source is in units of particles, the flux tallies are really fluence tallies. If the MCNP source is in units of particles per unit time, the flux tallies are truly fluxes. Fluence has units of particles/cm².
14. Current – The number of particles crossing a surface at a given time interval and in a given direction.

APPENDIX B: Calculating Atom Densities

Most Monte Carlo codes (and indeed, most neutronics codes) require that the user enter values to describe the atom densities of the materials involved in the analysis. The problem facing the user is that many times the data supplied are in the form of weight percent, volume percent, solution density, density of individual constituents, etc. These data are not always directly compatible with the input requirements of the code. This appendix is designed to cover the majority of cases for atom density calculations with a multitude of different input specifications.

I. Single material, given: mass density

For example, calculate the atom density of uranium-238 (U-238) for a nominal mass density of 19.1 g/cc.

The basic equation for atom density is: $n = \frac{\rho N_a}{A}$ (B-1)

where: n = atom density (atoms/cc)
 ρ = density of material (g/cc)
 N_a = Avogadro's number = $0.6022 \cdot 10^{24}$
 A = atomic weight of isotope (g/mole)

For this example,

$$\rho = 19.1 \frac{\text{g}}{\text{cm}^3} \quad N_a = 0.6022 \cdot 10^{24} \frac{\text{atoms}}{\text{mole}} \quad A = 238.05 \frac{\text{grams}}{\text{mole}}$$

$$n = 4.832 \cdot 10^{22} \frac{\text{atoms}}{\text{cm}^3}$$

The atom density of U-238 in the example is $4.832 \cdot 10^{22}$ atoms per cc. These units are sufficient for some codes, but others may require the entry to be in atoms per barn-cm because the cross sections are generally given in barns. Remembering that a barn is 10^{-24} cm^2 , then you can multiply the result by this value to arrive at an atom density of U-238 of $4.832 \cdot 10^{-2}$ atoms per barn-cm. However, rather than going through this step for each calculation, Avogadro's number is often expressed as 0.6022 atoms-cm² per mole-barn. This representation of Avogadro's number incorporates the proper units and directly gives values of atom density in atoms per barn-cm.

II. Two Materials

II.a Two materials, given: weight fractions and mixture density.

When there is a mixture of materials with a known density and individual weight fractions, the atom density equation becomes:

$$N_i = \frac{\rho_{\text{mix}} * wf_i * N_a}{A_i} \quad (\text{B-2})$$

where: N_i = atom density of i^{th} material.
 ρ_{mix} = mass density of mixture.
 wf_i = weight fraction of i^{th} material.
 A_i = atomic weight of i^{th} material.

For example, calculate the atom densities of ^{235}U and ^{238}U in 3 weight percent enriched uranium¹, U(3). The density of the uranium is 18.9 g/cc.

$$N_{\text{u235}} := \frac{\left(18.9 \frac{\text{g}}{\text{cm}^3}\right) \cdot (0.03) \cdot 0.6022 \cdot \text{atoms} \cdot \frac{\text{cm}^2}{\text{mol} \cdot \text{b}}}{235.04 \cdot \frac{\text{g}}{\text{mol}}}$$

$$N_{\text{u238}} := \frac{\left(18.9 \frac{\text{g}}{\text{cm}^3}\right) \cdot (0.97) \cdot 0.6022 \cdot \text{atoms} \cdot \frac{\text{cm}^2}{\text{mol} \cdot \text{b}}}{238.05 \cdot \frac{\text{g}}{\text{mol}}}$$

$$N_{\text{u235}} = 0.0014527 \cdot \frac{\text{atoms}}{\text{b} \cdot \text{cm}}$$

$$N_{\text{u238}} = 0.0463774 \cdot \frac{\text{atoms}}{\text{b} \cdot \text{cm}}$$

1. Note the weight percent of U-235 in uranium compounds is sometimes put in parentheses after the symbol for uranium, e.g. U(5) would indicate 5 weight percent U-235.

The atom fractions are then.

$$\text{Atom fraction U-235} = \frac{(1.45E-3)}{(1.45E-3) + (4.64E-2)} = 0.0303$$

$$\text{Atom fraction U-238} = \frac{(4.64E-2)}{(1.45E-3) + (4.64E-2)} = 0.9697$$

As the atomic weights of the two isotopes are within a percent of each other, there is little difference between the weight fractions and the atom fractions. However, as will be demonstrated with boron, this small difference is not always true. Note that although

the example was done with only two materials, as long as the mixture density and individual weight fractions are given, the technique applies to as many materials as required.

II.b Two materials, given: weight fractions and individual material densities.

If the individual densities and weight fractions are known, then the mixture density is determined from.

$$\frac{1}{\rho_{mix}} = \frac{wf_1}{\rho_1} + \frac{wf_2}{\rho_2} + \dots + \frac{wf_i}{\rho_i} \quad (\text{B-3})$$

In the previous example, assume the density of ^{235}U is 18.6 g/cc and ^{238}U is 18.9 g/cc, then

$$\frac{1}{\rho_{mix}} = \frac{0.03}{18.6} + \frac{0.97}{18.9} \quad \rho_{mix} = 18.89 \frac{\text{g}}{\text{cm}^3}$$

After obtaining the mixture density, the atom densities are calculated using equation B-2 as above.

III. Two materials given: atom fractions and atom mixture density

Although weight fractions are generally used for enrichments, atom fractions are given in publications such as the Chart of the Nuclides or the CRC Handbook of Chemistry and Physics. To use atom fractions, an average atomic weight must be determined.

$$\bar{A} = af_1 * A_1 + af_2 * A_2 + \dots + af_i * A_i \quad (\text{B-4})$$

The average atomic weight is used in the calculation of the mixture atom density.

$$N_{mix} = \frac{\rho_{mix} * N_a}{\bar{A}} \quad (\text{B-5})$$

Then the individual constituent atom densities are calculated:

MCNP Criticality Primer II

$$N_i = af_i * N_{mix} \quad (B-6)$$

For example, assume natural boron has a density of 2.34 g/cc with an atom fraction of 0.199 B-10 and 0.801 B-11.

$$\begin{aligned} \bar{A} &= 0.199 * 10.01 + 0.801 * 11.01 = 10.81g \frac{B_{nat}}{mole} \\ N_{mix} = N_{B_{nat}} &= \frac{(2.34g \frac{B_{nat}}{cm^3}) * (0.6022 \frac{atom-cm^2}{mole-b})}{10.81g \frac{B_{nat}}{mole}} \\ &= 1.304 * 10^{-1} \frac{atoms_{B_{nat}}}{b-cm} \end{aligned}$$

Now because we know what fraction of the B_{nat} atoms are B10 atom, we can calculate the atom density of B10 in natural Boron.

$$N_{B-10} = 0.199 \frac{atom_{B-10}}{atom_{B_{nat}}} * 1.304 * 10^{-1} \frac{atom_{B_{nat}}}{b-cm} = 2.59 * 10^{-2} \frac{atom_{B-10}}{b-cm}$$

Similarly for B11;

$$N_{B-11} = 0.801 \frac{atom_{B-11}}{atom_{B_{nat}}} * 1.304 * 10^{-1} \frac{atom_{B_{nat}}}{b-cm} = 1.045 * 10^{-1} \frac{atom_{B-11}}{b-cm}$$

Note that $N_{B10} + N_{B11} = N_{Bnat}$, which it should.

IV. Calculating fractions & average weight with one known set

Full title: Calculating weight fractions, atom fractions, and average atomic weight when one set of fractions is known.

In the previous section, equation B4 showed how to calculate average atomic weight when atom fractions are known. If, however, weight fractions are given, then a different equation is used to calculate average atomic weight.

$$\bar{A} = \left[\frac{wf_1}{A_1} + \frac{wf_2}{A_2} + \dots + \frac{wf_i}{A_i} \right]^{-1} \quad (\text{B-7})$$

Further, you can calculate the atom fractions from the weight fractions and the average atomic weight as

$$af_i = wf_i * \frac{\bar{A}}{A_i} \quad (\text{B-8})$$

Or, if you have the atom fractions, calculate the weight fraction as:

$$wf_i = af_i * \frac{A_i}{\bar{A}} \quad (\text{B-9})$$

For example, continue with natural boron and calculate the weight fractions.

$$wf_{B10} = 0.199 * \frac{10.01}{10.81} = 0.184$$

$$wf_{B11} = 0.801 * \frac{11.01}{10.81} = 0.816$$

As indicated earlier there is a significant difference between weight and atom fractions for B-10 and B-11 in natural boron.

V. Molecules

V.a. Molecules, given: chemical structure and mass density.

Determination of atom densities for constituents of a molecule is similar to the calculation when the atom fractions are known. In this case, the atom fractions are usually greater than 1 and represent the number of atoms of a particular type in the molecule.

For example, determine the atom densities of hydrogen and oxygen in water with a density of 1.0 g/cc.

$$N_{H_2O} = \frac{(1.0 \text{ g / cm}^3)(0.6022 \text{ atom - cm}^2 / \text{mole - b})}{18 \text{ g / mole}} = 3.34 * 10^{-2} \frac{\text{molecules}_{H_2O}}{\text{b - cm}}$$

In water, there are 2 atoms of H and 1 atom of O for every molecule of water.

$$N_H = 2 * N_{H_2O} = 6.68 * 10^{-2} \frac{\text{atoms}_H}{\text{b - cm}} \qquad N_O = 1 * N_{H_2O} = 3.34 * 10^{-2} \frac{\text{atoms}_O}{\text{b - cm}}$$

V.b. Molecules with mixtures of isotopes.

In the example above, it was assumed that all hydrogen was H1 and all oxygen was O-16. However, for many materials encountered in criticality safety, the isotopic content is very important (e.g. boron and uranium).

For example, determine the atom densities of B-10, B-11, and C in Boron Carbide (B₄C) assuming the boron is natural boron and the mixture density is 2.54 g/cc.

The molecular weight of B₄C can be found in a reference or can be calculated using equation B4.

$$A_{B_4C} = \frac{4 \text{ moles}_{B_{nat}} * 10.81 \text{ g}}{\text{mole}_{B_4C} \text{ mole}_{B_{nat}}} + \frac{1 \text{ mole}_C * 12.00 \text{ g}}{\text{mole}_{B_4C} \text{ mole}_C} \qquad A_{B_4C} = 55.24 \text{ g / mole}$$

$$N_{B_4C} = \frac{(2.54 \text{ g / cc})(0.6022 \text{ molecules - cm}^2 / \text{mole - b})}{55.24 \text{ g / mole}}$$

$$N_{B_4C} = 2.77 * 10^{-2} \frac{\text{molecules}_{B_4C}}{\text{b - cm}}$$

MCNP Criticality Primer II

There are 4 atoms of B_{nat} per molecule of B_4C .

$$N_{B_{nat}} = 4 * N_{B_4C} = 1.108 * 10^{-1} \frac{atoms_{B_{nat}}}{b - cm}$$

From the earlier example, (or from the Chart of the Nuclides) the atom fractions of B-10 and B-11 in natural boron are 0.199 and 0.801, respectively.

$$N_{B_{10}} = af_{B_{10}} * N_{B_{nat}} = 0.199 * 1.108 * 10^{-1} = 2.205 * 10^{-2} \frac{atoms_{B_{10}}}{b - cm}$$

$$N_{B_{11}} = af_{B_{11}} * N_{B_{nat}} = 0.801 * 1.108 * 10^{-1} = 8.875 * 10^{-2} \frac{atoms_{B_{11}}}{b - cm}$$

These are the atom densities of B-10 and B-11 in B_4C . Now, we need to calculate the atom density of carbon in B_4C .

$$N_C = 1 * N_{B_4C} = 2.77 * 10^{-2} \frac{atoms_C}{b - cm}$$

For materials where the atom fractions are known, determination of the individual atom densities is straight forward. However, for those cases where the weight fractions are known, then the atom fractions are first calculated from equation B8 and then used to determine atom densities, as above.

Note: in mixtures, it is important to know whether the weight or atom fractions are relative to the entire mixture or just to some constituent part of the mixture. In the example above, atom fractions for B-10 and B-11 were relative to the natural boron and not to the B_4C . As another example, in $U(20)O_2$, the 0.20 weight fraction of U-235 is relative to the uranium, not to the UO_2 , so it can only be applied to the uranium.

Example $U(20)O_2$ with a density of 10.5 g- UO_2 per cc.

First determine the average atomic weight of UO_2 with 20 weight percent U-235. Start by calculating the average atomic weight of U.

$$\bar{A}_U = \left[\frac{0.20}{235.04} + \frac{0.80}{238.05} \right]^{-1} = 237.44 \frac{gU(20)}{cm^3}$$

$$\bar{A}_{UO_2} = 237.44 + 2 * 16 = 269.44 \frac{gUO_2}{cm^3}$$

Now determine the atom density of UO_2 .

$$N_{UO_2} = \frac{(10.5 g_{UO_2} / cc)(.6022 \text{ molecules} - \text{cm}^2 / \text{mole} - b)}{269.44 g / \text{mole}}$$

$$= 2.35 * 10^{-2} \frac{\text{molecules}_{UO_2}}{b - cm}$$

There is 1 atom of U and 2 atoms of O for each molecule of UO₂.

$$N_O = 2 * N_{UO_2} = 4.70 * 10^{-2} \frac{\text{atoms}_O}{b - cm}$$

$$N_U = 1 * N_{UO_2} = 2.35 * 10^{-2} \frac{\text{atoms}_U}{b - cm}$$

But twenty weight percent of the uranium is U235 while eighty weight percent is U-238. Use the weight fractions to calculate uranium atom fractions from equation B8.

$$af_{U235} = wf_{U235} * \frac{\bar{A}}{A_{235}} = 0.20 * \frac{237.44}{235.04} = 0.202$$

$$af_{U238} = wf_{U238} * \frac{\bar{A}}{A_{238}} = 0.80 * \frac{237.44}{238.05} = 0.798$$

Then calculate the atom densities.

$$N_{U235} = f_{U235} * N_U = 0.202 * 2.35 * 10^{-2} = 4.75 * 10^{-3} \frac{\text{atoms}_{U235}}{b - cm}$$

$$N_{U238} = f_{U238} * N_U = 0.798 * 2.35 * 10^{-2} = 1.875 * 10^{-2} \frac{\text{atoms}_{U238}}{b - cm}$$

VI. Solution Systems.

Because solution systems have a number of parameters (solution density, molality, normality, single constituent density, H/U ratio, H/Pu ratio, H/X ratio) that can be used to characterize them, calculation of atom densities in solution is usually more complex than for solids. If the solution density is given, then the atom densities are

calculated using the technique given in Section V.a. (where water is used as the example).

VI.a. H/Xratio, fissile component density, and with chemical formula.

The H/X ratio (ratio of hydrogen atoms to fissile atoms) is often used in criticality studies to indicate amount of moderation in the system. When the fissile mass density is provided along with H/X, all of the atom densities can be determined. Using the example from Chapter 3 of the Primer, we have $U(4.89)O_2F_2$ in solution with water; $H/X = 524$ and the U-235 density is 0.0425 gU235/cc .

First calculate the fissile atom density.

$$N_{U235} = \frac{\rho_{U235} * N_{AV}}{A_{235}} = \frac{(0.0425 \text{ gU235 / cc})(0.6022 \text{ atoms} - \text{cm}^2 \text{ / mole} - b)}{235.04 \frac{\text{g}}{\text{mole}}}$$

$$N_{U235} = 1.0889 * 10^{-4} \frac{\text{atoms}_{U235}}{b - \text{cm}}$$

We know the weight fractions of U-235 and U-238, but we want the atom fractions. To get these values we need to use equation B7 to calculate the average atomic weight of the (U-235, U-238) mixture.

$$wf_{U235} = 0.0489 \quad wf_{U238} = (1 - 0.0489) = 0.9511$$

$$\bar{A} = \left[\frac{0.0489}{235.04} + \frac{0.9511}{238.05} \right]^{-1} = 237.90 \frac{\text{gU}(4.89)}{\text{cm}^3}$$

Use equation B-8 to calculate the atom fractions.

$$af_{235} = wf_{235} * \frac{\bar{A}}{A_{235}} = 0.0489 * \frac{237.90}{235.04} = 0.0495 \frac{\text{atoms}_{U235}}{\text{atoms}_U}$$

$$af_{238} = wf_{238} * \frac{\bar{A}}{A_{238}} = 0.9511 * \frac{237.90}{238.05} = 0.9505 \frac{\text{atoms}_{U238}}{\text{atoms}_U}$$

The uranium atom density is determined by dividing the U235 atom density by the U-235 atom fraction.

$$N_U = \frac{N_{235}}{af_{235}} = \frac{1.0889 * 10^{-4} \text{ atoms}_{U235} / b - cm}{0.0495 \frac{\text{atoms}_{U235}}{\text{atoms}_U}} = 2.1998 * 10^{-3} \frac{\text{atoms}_U}{b - cm}$$

$$N_{U238} = af_{238} * N_U = 0.9505 \frac{\text{atoms}_{U238}}{\text{atoms}_U} * 2.1998 * 10^{-3} \frac{\text{atoms}_U}{b - cm} = 2.0909 * 10^{-3} \frac{\text{atoms}_{U238}}{b - cm}$$

Now calculate the O₂ and F₂ densities from the uranium atom density.

$$N_O = 2 * N_U = 4.3996 * 10^{-3} \frac{\text{atoms}_O}{b - cm} \quad (\text{in } \text{UO}_2\text{F}_2)$$

$$N_F = 2 * N_U = 4.3996 * 10^{-3} \frac{\text{atoms}_F}{b - cm}$$

With UO₂F₂ solutions, there is a substantial amount of water for which the atom densities of H and O can be determined from the H/X ratio.

$$N_H = H / X * N_{U235} = 524 * 1.0889 * 10^{-4} = 5.7058 * 10^{-2} \frac{\text{atoms}_H}{b - cm}$$

$$N_O = N_H * \frac{1 \text{ atom}_O}{2 \text{ atoms}_H} = 2.8529 * 10^{-2} \frac{\text{atoms}_O}{b - cm} \quad (\text{in } \text{H}_2\text{O})$$

The total atom density for oxygen is the sum of its atom density in UO₂F₂ and its atom density in H₂O.

$$N_O = 2.8529 * 10^{-2} \frac{\text{atoms}_O}{b - cm} + 4.3996 * 10^{-3} \frac{\text{atoms}_O}{b - cm} = 3.2929 * 10^{-2} \frac{\text{atoms}_O}{b - cm}$$

MCNP Criticality Primer II

The final values, in atoms/b-cm, that were used in Chapter 3 are:

$$N_{235} = 1.0889 \cdot 10^{-4}$$

$$N_{238} = 2.0909 \cdot 10^{-3}$$

$$N_H = 5.7058 \cdot 10^{-2}$$

$$N_O = 3.2929 \cdot 10^{-2}$$

$$N_F = 4.3996 \cdot 10^{-3}$$

$$N_{total} = 9.6586 \cdot 10^{-2}$$

APPENDIX C: Specifications & Atom Densities Of Selected Materials

RD. ODell
Criticality Safety Group
Los Alamos National Laboratory
April 1994

The following material compositions, specifications, and atom densities have been compiled by the above author from various sources. They are provided for the convenience of users of computer codes for nuclear analysis. No warranty is made nor is any legal liability or responsibility assumed for the accuracy, completeness, or usefulness of the following information. Reference to any specific commercial product by trade name or registered trademark does not necessarily constitute or imply its endorsement.

Atomic weights used in the following were taken from "Nuclides and Isotopes, Fourteenth Edition, General Electric Company, San Jose, California.

Atom densities are given in units of atoms/barn-cm.

MCNP Criticality Primer II

BISCO® modified NS-4 with 4.5% Boron
Los Alamos National Laboratory Analysis

Density = 1.119 g/cc

Nuclide	WL Frac.	Atom Dens.
C	0.4771	0.02677
N	0.0356	0.00171
H	0.0787	0.05262
Si	0.0018	0.00004
Na	0.0494	0.00145
B(nat)	0.0455	0.00284
O	0.3119	0.01314

BORON CARBIDE (Natural Boron): B₄C

Density = 2.51 g/cc

A = 55.2570

Nuclide	Wt. Frac.	Atom Dens.
B(nat)	0.7826	0.10941
C	0.2174	0.027359

CELOTEX® (Lignocellulosic Fiberboard)*

Normal density = 16.2 lb/ft³
 Celotex ~ C₆H₁₀O₅ (cellulose)
 A = 162.143

Atom Densities as Function of Celotex Density

Density (g/cm ³)	Density (lb/ft ³)	C	H	O
0.31	19.34	6.908-3	1.1514-2	5.757-3
0.30	18.71	6.685-3	1.1142-2	5.571-3
0.29	18.09	6.463-3	1.0771-2	5.385-3
0.2886	18.00	6.431-3	1.0719-2	5.359-3
0.28	17.46	6.240-3	1.0400-2	5.200-3
0.27	16.84	6.017-3	1.0028-2	5.014-3
0.26	16.22	5.794-3	9.657-3	4.828-3
0.2565	16.00	5.716-3	9.527-3	4.763-3
0.25	15.59	5.571-3	9.285-3	4.643-3
0.24	14.97	5.348-3	8.9143	4.457-3
0.23	14.35	5.125-3	8.542-3	4.271-3
0.2245	14.00	5.003-3	8.338-3	4.169-3
0.22	13.72	4.903-3	8.171-3	4.086-3
0.21	13.10	4.680-3	7.800-3	3.900-3
0.20	12.47	4.457-3	7.428-3	3.7143
0.19	11.85	4.2343	7.057-3	3.528-3
0.18	11.23	4.011-3	6.685-3	3.343-3

*Ref ASTM C-208, "Standard Specification for Insulating Board (Cellulosic Fiber), Structural and Decorative"

MCNP Criticality Primer II

CONCRETE (KENO Regular Concrete Standard Mix)

Density = 2.3 g/cc

Nuclide	Wt. Frac.	Atom Dens.
H	0.01	0.01374
O	0.532	0.04606
Si	0.337	0.01662
Al	0.034	0.00175
Na	0.029	0.00175
Ca	0.044	0.00152
Fe	0.014	0.00035

CONCRETE [LOS ALAMOS (MCNP) Mix]

Density = 2.25 g/cc

Nuclide	Wt. Frac.	Atom Dens.
H	0.00453	0.006094
O	0.5126	0.043421
Si	0.36036	0.01739
Al	0.03555	0.001786
Na	0.01527	0.0009
Ca	0.05791	0.001958
Fe	0.01378	0.000334

MCNP Criticality Primer II

CONCRETE (NBS Ordinary)

Density = 2.35 g/cc

Nuclide	NBS Wt. Frac.	Adj.* Wt. Frac.	Adj. Atom Dens.
H	0.0056	0.006	0.00842
O	0.4956	0.5	0.04423
Si	0.3135	0.315	0.01587
Al	0.0456	0.048	0.00252
Na	0.0171	0.017	0.00105
Ca	0.0826	0.083	0.00293
Fe	0.0122	0.012	0.0003
K	0.0192	0.019	0.00069
Mg	0.0024	-	
S	0.0012	-	

** adjusted to sum to unity without minor trace elements*

GYPSUM (Calcium Sulfate)

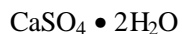

Density = 2.32 g/cc

A = 172.17

Nuclide	Atom Density
Ca	0.008115
S	0.008115
O	0.048689
H	0.03246

INCONEL (KENO Standard Mix)

Density = 8.3 g/cc

Nuclide	Wt. Frac.	Atom Dens.
Si	0.025	0.00445
Ti	0.025	0.00261
Cr	0.15	0.01442
Fe	0.07	0.00626
Ni	0.73	0.06217

MCNP Criticality Primer II

INCONEL X (Simplified)

Density = 8.5 g/cc

Nuclide	Wt. Frac.	Atom Dens.
Ni	0.78	0.068
Cr	0.15	0.0148
Fe	0.07	0.0064

KYNAR®: C₂H₂F₂

Density = 1.76 g/cc

A = 64.0347

Nuclide	Wt. Frac.	Atom Dens.
C	0.3751	0.0331
H	0.0315	0.0331
F	0.5934	0.0331

LEXAN®: C₁₆H₁₄O₃

Los Alamos National Laboratory Analysis

Density = 1.20 g/cc

A = 254.2855

Nuclide	Wt Frac.	Atom Dens.
C	0.755749	0.045471
H	0.055494	0.039787
O	0.188757	0.008527

MAGNESIUM OXIDE: MgO

Density = 3.22 g/cc

A = 40.3044

Nuclide	Wt Frac.	Atom Dens.
Mg	0.6030	0.04811
O	0.3970	0.04811

MCNP Criticality Primer II

NYLON®: $C_{12}H_{22}N_2O_2$,

Density = 1.14 g/cc

A = 226.319

Nuclide	Wt. Frac.	Atom Dens.
C	0.63685	0.036401
H	0.09798	0.066737
N	0.12378	0.006067
O	0.14139	0.006067

PARAFFIN: $C_{25}H_{52}$

Density = 0.93 g/cc

A = 352.688

Nuclide	Wt. Frac.	Atom Dens.
C	0.8514	0.03970
H	0.1486	0.08257

PLEXIGLAS® & LUCITE®: $C_5H_8O_2$,

Density = 1.18 g/cc

A = 100.117

Nuclide	Wt. Frac.	Atom Dens.
C	0.59985	0.03549
H	0.08054	0.05678
O	0.31961	0.01420

POLYETHYLENE: CH_2

Density = 0.92 g/cc

A = 14.0269

Nuclide	Wt. Frac.	Atom Dens.
C	0.85628	0.03950
H	0.14372	0.07899

POLYURETHANE FOAM

Los Alamos National Laboratory Analysis

Density = 0.021 g/cc

Nuclide	Wt. Frac.	Atom Dens.
H	0.041	5.1440E-04
C	0.544	5.7280E-04
N	0.121	1.0925E-03
O	0.294	2.3240E-04

POLYVINYL CHLORIDE (PVC): C₂H₃Cl

Density = 1.65 g/cc

Nuclide	Wt. Frac.	Atom Dens.
C	0.3844	0.0318
H	0.0484	0.04771
Cl	0.5672	0.0159

PYREX® [Borated Glass], (KENO Standard Mix)

Density = 2.23 g/cc

Nuclide	Wt. Frac.	Atom Dens.
^{nat} B	0.037	0.0046
Al	0.010	0.0005
Na	0.041	0.0024
O	0.535	0.04491
Si	0.377	0.01803

MCNP Criticality Primer II

SILICON RUBBER (G.E. RTV12A)

(Weight fractions below provided by G.E. Silicone Products Div.)

Density = 1.0185 g/cc

Nuclide	Wt. Frac.	Atom Dens.
C	0.3211	0.0164
Si	0.3745	0.00818
O	0.2235	0.00857
H	0.0807	0.04911

STEEL, CARBON

Density = 7.82 g/cc

Nuclide	Wt. Frac.	Atom Dens.
C	0.005	0.00196
Fe	0.995	0.08390

STAINLESS STEEL 304

Density = 7.92 g/cc

Nuclide	Wt. Frac.	Atom Dens.
Fe	0.695	0.05936
Cr	0.190	0.01743
Ni	0.095	0.00772
Mn	0.020	0.00174

STAINLESS STEEL 316

Density = 7.92 g/cc

Nuclide	Wt. Frac.	Atom Dens.
Fe	0.655	0.05594
Cr	0.170	0.01559
Ni	0.120	0.00975
Mo	0.025	0.00124
Mn	0.020	0.00174
Si	0.010	0.00170

MCNP Criticality Primer II

STAINLESS STEEL 347

Density = 7.92 g/cc

Nuclide	Wt. Frac.	Atom Dens.
Fe	0.685	0.0585
Cr	0.180	0.01651
Ni	0.105	0.00853
Mn	0.020	0.00174
Si	0.010	0.0017

TEFLON®: CF₂

Las Alamos National Laboratory Analysis

Density = 2.15-2.20 g/cc

A = 50.0078

Nuclide	Wt. Frac.	Atom Dens.
C	0.2402	0.02650
F	0.7598	0.05298

APPENDIX D: Listing of Available Cross-Sections

The following is a list of cross sections available for various isotopes and elements. If the RSICC distributed xsdir file is used, and if no ZAID extension is specified, .62c, will automatically be used. If .62c is unavailable, then .66c, then .60c extension will be used. The ZAID extension used in the calculation will be listed in the output file. Numerically higher ZAIDs are more likely to have unresolved resonance treatment and delayed neutron data available. Lower extensions may be preferred if their evaluation temperature is more representative of the temperatures found in the problem, but they may not have the unresolved resonance treatment or delayed neutron data available, and were derived from a older ENDF/B release. Sometimes it is preferable, due to more up-to-date data evaluations, to explicitly include each nuclide in an element than to use the naturally occurring (-nat) mixture. Consult Appendix G of the MCNP manual for information.

ISOTOPE	ZAID
H-1	1001
H-2	1002
H-3	1003
He-3	2003
He-4	2004
Li-6	3006
Li-7	3007
Be-7	4007
Be-9	4009
B-10	5010
B-11	5011
C-nat	6000
C-12	6012
C-13	6013
N-14	7014
N-15	7015
O-16	8016
O-17	8017
F-19	9019
Ne-20	10020
Na-23	11023
Mg-nat	12000
Al-27	13027*
Si-nat	14000
Si-28	14028
Si-29	14029
Si-30	14030
P-31	15031

MCNP Criticality Primer II

S-nat	16000
S-32	16032
Cl-nat	17000
Cl-35	17035
Ar-nat	18000
K-nat	19000
Ca-nat	20000
Ca-40	20040
Sc-45	21045
Ti-nat	22000
V-nat	23000
V-51	23051
Cr-nat	24000
Cr-50	24050
Cr-52	24052
Cr-53	24053
Cr-54	24054
Mn-55	25055
Fe-nat	26000
Fe-54	26054
Fe-56	26056
Fe-57	26057
Fe-58	26058
Co-59	27059
Ni-nat	28000
Ni-58	28058
Ni-60	28060
Ni-61	28061
Ni-62	28062
Ni-64	28064
Cu-nat	29000
Cu-63	29063
Cu-65	29065
Zn-nat	30000
Ga-nat	31000
As-74	33074
As-75	33075
Br-79	35079
Br-81	35081
Kr-78	36078
Kr-80	36080
Kr-82	36082
Kr-83	36083
Kr-84	36084
Kr-86	36086
Rb-85	37085

MCNP Criticality Primer II

Rb-87	37087
Y-88	39088
Y-89	39089
Zr-nat	40000
Zr-90.....	40090
Zr-91.....	40091
Zr-92.....	40092
Zr-93.....	40093
Zr-94.....	40094
Zr-96.....	40096
Nb-93.....	41093
Mo-nat	42000
Mo-95	42095
Tc-99	43099
Ru-101	44101
Ru-103	44103
Rh-103	45103
Rh-105	45105
Pd-102	46102
Pd-104	46104
Pd-105	46105
Pd-106	46106
Pd-108	46108
Pd-110	46110
Ag-nat	47000
Ag-107	47107
Ag-109	47109
Cd-nat	48000
Cd-106	48106
Cd-108	48108
Cd-110	48110
Cd-111	48111
Cd-112	48112
Cd-113	48113
Cd-114	48114
Cd-116	48116
In-nat	49000
In-120	49120
In-125	49125

MCNP Criticality Primer II

Sn-nat	50000
Sb-nat	51000
I-127	53127
I-129	53129
I-135	53135
Xe-nat	54000
Xe-124	54124
Xe-126	54126
Xe-128	54128
Xe-129	54129
Xe-130	54130
Xe-131	54131
Xe-132	54132
Xe-134	54134
Xe-135	54135
Xe-136	54136
Ce-133	55133
Ce-134	55134
Ce-135	55135
Ce-136	55136
Ce-137	55137
Ba-138	56138
Pr-141	59141
Nd-143	60143
Nd-145	60145
Nd-147	60147
Nd-148	60148
Pm-147	61147
Pm-148	61148
Pm-149	61149
Sm-147	62147
Sm-149	62149
Sm-150	62150
Sm-151	62151
Sm-152	62152
Eu-nat	63000
Eu-151	63151
Eu-152	63152
Eu-153	62153
Eu-154	62154
Eu-155	62155
Gd-nat	64000
Gd-152	64152
Gd-154	64154
Gd-155	64155

MCNP Criticality Primer II

Gd-156	64156
Gd-157	64157
Gd-158	64158
Gd-160	64160
Ho-165	67165
Tm-169	69169
Lu-175	71175
Lu-176	71176
Hf-nat	72000
Hf-174	72174
Hf-176	72176
Hf-177	72177
Hf-178	72178
Hf-179	72179
Hf-180	72180
Ta-181	73181
Ta-182	73182
W-nat	74000
W-182	74182
W-183	74183
W-184	74184
W-186	74186
Re-185	75185
Re-187	75187
Ir-nat	77000
Ir-191	77191
Ir-193	77193
Pt-nat	78000
Au-197	79197
Hg-nat	80000
Hg-196	80196
Hg-198	80198
Hg-199	80199
Hg-200	80200
Hg-201	80201
Hg-202	80202
Hg-204	80204
Pb-nat	82000
Pb-206	82206
Pb-207	82207
Pb-208	82208
Bi-209	83209
Th-230	90230
Th-231	90231
Th-232	90232
Th-233	90233

MCNP Criticality Primer II

Pa-231	91231
Pa-233	91233
U-232	92232
U-233	92233
U-234	92234
U-235	92235
U-236	92236
U-237	92237
U-238	92238
U-239	92239
U-240	92240
Np-235	93235
Np-236	93236
Np-237	93237
Np-238	93238
Np-239	93239
Pu-236	94236
Pu-237	94237
Pu-238	94238
Pu-239	94239
Pu-240	94240
Pu-241	94241
Pu-242	94242
Pu-243	94243
Pu-244	94244
Am-241	95241
Am-242m	95242
Am-243	95243
Cm-241	96241
Cm-242	96242
Cm-243	96243
Cm-244	96244
Cm-245	96245
Cm-246	96246
Cm-247	96247
Cm-248	96248
Bk-249	97249
Cf-249	98249
Cf-250	98250
Cf-251	98251
Cf-252	98252

*The delayed gamma ray at an energy of 1.7791 MeV from the reaction:
 $n + {}^{27}\text{Al} \rightarrow {}^{28}\text{Al} \rightarrow {}^{28}\text{Si} + \beta + \gamma$ has been included in the thermal-capture photon-production data for two ZAIDs. These are not the default ZAIDs, however.

S(a,b) IDENTIFIERS FOR THE MT CARD

The thermal neutron scattering laws shown here are available at a temperature of 300 Kelvin. Other temperatures may also be available. The ENDF/B-VI evaluation is denoted by the extension .6xt, where x varies as the temperature of the evaluation. {Appendix G of the MCNP manual gives a complete listing of the $S(\alpha,\beta)$ cross sections.}

ZAID	Description	Isotopes
lwtr	Hydrogen (H-1) in Light Water	1001
hortho	Ortho Hydrogen	1001
hpara	Para Hydrogen	1001
lmeth	Hydrogen in Liquid Methane	1001
smeth	Hydrogen in Solid Methane	1001
poly	Hydrogen in Polyethylene	1001
benz	Benzene	1001, 6000, 6012
h/zr	¹ H in ZrHx	1001
dortho	Ortho Deuterium	1002
dpara	Para Deuterium	1002
hwtr	Deuterium in Heavy Water	1002
be	Beryllium Metal	4009
beo	Beryllium Oxide	4009, 8016
grph	Graphite	6000, 6012
Zr/h	Zr in ZrHx	40000, 40090, 40091, 40094, 40096

APPENDIX E: Geometry PLOT and Tally MC PLOT Commands

This appendix contains only a summary of the available commands for the geometry and tally plotting capabilities included in MCNP. All commands can be shortened to the fewest letters that unambiguously identify the command. {Please refer to Appendix B of the MCNP5 manual for a complete listing of commands.}

PLOT

Used to plot two-dimensional slices of a problem geometry specified in the input file. This feature is invaluable when debugging geometries. Commands are shown in upper case but can be input in lower case. PLOT examples have been shown in several of the Primer chapters.

A. Geometry PLOT Input and Execute Line Options

To plot geometries with MCNP, enter the following command:

```
mcnp ip inp=filename options
```

where 'ip' stands for initiate and plot. 'options' is explained in the following paragraphs. The most common method of plotting is with an interactive graphics terminal. MCNP will read the input file, perform the normal checks for consistency, and then display the interactive geometry-plotting window on the terminal screen.

When X Windows is in use, the plot window supports a variety of interactive features that assist the user in selecting the plot. The interactive options are discussed after the discussion of the command-line plot options.

The following four additional plot options can be entered on the execution line in addition to the standard MCNP execution options:

NOTEK

Suppress plotting at the terminal and send all plots to the graphics metafile, PLOTM. This is used for production and batch situations and when the user's terminal has no graphics capability.

COM=*aaaa*

Use file *aaaa* as the source of plot requests. When an EOF is read, control is transferred to the terminal. In a production or batch situation, end the file with an END command to prevent transfer of control. Never end the COM file with a blank line. If COM is absent, the terminal is used as the source of plot requests.

PLOTM=*aaaa*

Name the graphics metafile *aaaa*. The default name is PLOTM.ps. This file is a standard postscript file.

COMOUT=aaaa

Name the plot-commands output file *aaaa*. The default name is COMOUT. MCNP writes the COMOUT file in order to give the user the opportunity to do the same plotting at some later time, using all or part of the old COMOUT file as the COM file in the second run.

When names are defaulted, unique names for the output files, PLOTM.ps and COMOUT, will be chosen by MCNP to avoid overwriting existing files. Unique names are created by changing the last letter of the default name until the next available name is found. For example, if the file PLOTM.ps already exists, MCNP tries the name PLOTN.ps, etc., until it finds an available name.

MCNP can be run in a batch environment without much difficulty, but the user interaction with the plotter is significantly reduced. When not using an interactive graphics terminal, use the NOTEK option on the MCNP execution line or set TERM=0 along with other PLOT commands when first prompted by PLOT. (*Note: For geometry plotting with X Windows, a plot window will appear before the first plot request as the interactive plot window is created. To prevent this, use the NOTEK option.*) Every view plotted will be put in a postscript file called PLOTn where n begins at M and goes to the next letter in the alphabet if PLOTM exists. In the interactive mode, plots can be sent to this graphics metafile with the FILE keyword (see the keyword description in Section B for a complete explanation). The PLOTn.ps file is a postscript file that can be sent to a postscript printer.

A plot request consists of a sequence of commands terminated by pressing the ENTER key. A command consists of a keyword, usually followed by some parameters. Lines can be continued by typing an & (ampersand) before pressing the ENTER key, but each keyword and its parameters must be complete on one line. The & character can be used in the COM file as well as at the plot prompt. Keywords and parameters are blank-delimited. A plot request line cannot have more than 80 characters on a single line. Use the & to enter more complex commands. Commas and equal signs are interpreted as blanks. Keywords can be shortened to any degree as long as they are not ambiguous and are spelled correctly. Parameters following the keywords cannot be abbreviated.

Numbers can be entered in free-form format and do not require a decimal point for floating point data. Keywords and parameters remain in effect until you change them. *Note: If a shortened, ambiguous keyword is used, the entire command line will be rejected and a message to that effect will be printed to the terminal. The commands OPTIONS, HELP and '?' display a list of the keywords to help the user recall the correct keyword.*

Before describing the individual plotting commands, it may help to explain the mechanics of 2-dimensional (2D) plotting. To obtain a 2D slice of a geometry, the user must decide where the slice should be taken and how much of the slice should be viewed on the terminal screen. The slice is actually a 2D plane that may be arbitrarily oriented in

space; therefore, the first problem is to decide the plane position and orientation. In an orthogonal 3dimensional coordinate system, the three axes are perpendicular to each other. An orthogonal axis system is defined with a set of BASIS vectors on the 2D plane used to slice the geometry to determine the plot orientation. The first BASIS vector is the horizontal direction on the screen. The second BASIS vector is the vertical direction on the screen. The surface normal for the plane being viewed is perpendicular to the two BASIS vectors.

How much of the slice to view is determined next. The center of the view plane is set with the ORIGIN command which serves two purposes: first, for planes not corresponding to simple coordinate planes, it determines the position of the plane being viewed; second, the origin becomes the center of the cross-sectional slice being viewed. For example, for a Y-Z plot, the x -coordinate given with the PX command determines the location of the PX plane. The ORIGIN is given as an x , y , and z -coordinate and is the center of the plot displayed.

Because planes are infinite and only a finite area can be displayed at any given time, you must limit the extent of the cross-sectional plane being displayed with the EXTENT command. For instance, a plane defined with $PX=X1$ at an ORIGIN of $X1, Y1$, and $Z1$ would produce a YZ plane at $X = X1$, centered at $Y1$ and $Z1$ using the default BASIS vectors for a PX plane of 0 1 0 and 0 0 1..

The BASIS vectors are arbitrary vectors in space. This may seem confusing to the new user, but the majority of plots are PX, PY, or PZ planes where the BASIS vectors are defaulted. For the majority of geometry plots, these simple planes are sufficient and you do not have to enter BASIS vectors. The flexibility of the BASIS option can also be used to examine the geometry from more obscure views.

All the plot parameters for the MCNP plotter have defaults. To obtain a plot, click on the plot area of the interactive screen or, if in command line mode, press ENTER. The default geometry plot is a PX plane centered at 0,0,0 with an extent of 100 to 100 on Y and 100 to 100 on Z. The y -axis will be the horizontal axis of the plot, and the z -axis will be the vertical axis. Surface labels are printed. This default is the equivalent of entering the command line:

```
origin 0 0 0 extent 100 100 basis 0 1 0 0 0 1 label 1 0
```

By resetting selected plot parameters, any desired plot can be obtained. Most parameters remain set until changed, either by the same command with new values or by a conflicting command.

Warning: Placing the plot plane exactly on a surface of the geometry is not a good idea. For example, if the input geometry has a PX plane at $X=0$, that plane coincides with the default plot plane. Several things can result when such alignment occurs. Some portion of the geometry may be displayed in dotted lines, which usually indicates a geometry error. Some portion of the geometry may simply not show up at all. Very infrequently the code

may crash with an error. To prevent all of these unpleasanties, move the plot plane a short space away from surfaces.

1. Device-Control Commands

Normally PLOT draws plots on the user's terminal and nowhere else. By using the following commands, the user can specify that plots not be drawn on the terminal and/or that they be sent to a graphics metafile or postscript file for processing later by a graphics utility program that will send the plots to other graphics devices.

TERM *n* This command sets the output device type according to *n*:

0 terminal with no graphics capability. No plots will be drawn on the terminal, and all plots will be sent to the graphics file. TERM 0 is equivalent to putting NOTEK on MCNP's execute line.

1 Restore visible plotting window on next plot request.

FILE *aa*

Send (or do not send) plots to the postscript file PLOTM.PS according to the value of the parameter *aa*. The graphics file is not created until the first FILE command is entered. FILE has no effect in the NOTEK or TERM=0 cases. The allowed values of *aa* are:

blank - only the current plot is sent to the graphics metafile.

ALL - the current plot and all subsequent plots are sent to the metafile until another FILE command is entered.

NONE the current plot is not sent to the metafile nor are any subsequent plots sent until another FILE command is entered.

VIEWPORT *aa* Make the viewport rectangular or square according to the value of *aa*.

The default is RECT. This option does not affect the appearance of the plot. It only determines whether space is provided beside the plot for a legend and around the plot for scales. The allowed values of *aa* are:

RECT

allows space beside the plot for a legend and around the plot for scales.

SQUARE

The legend area, the legend, and scales are omitted, making it possible to print a sequence of plots on some sort of strip medium so as to produce one long picture free from interruptions by legends. *Note: use of the SQUARE option disables the interactive window plotter capability.*

2. General Commands

&

Continue reading commands for the current plot from the next input line. The & must be the last item on the line.

INTERACT

Return to the interactive, mouse-driven geometry plot interface. This Command is used to return from the terminal-command interface when the PLOT option is invoked from the interactive plotter.

RETURN

If PLOT was called by MCNPLOT, control returns to MCNPLOT. Otherwise RETURN has no effect.

MCNPLOT

Call or return to MCNPLOT, the tally/cross-section plotter.

PAUSE *n*

Use with the COM=aaaa option. Hold each picture for *n* seconds. If no *n* Value is provided, each picture remains until the ENTER key is pressed.

END

Terminate execution of PLOT.

3. Inquiry Commands

When one of these commands is encountered, the requested display is made and then PLOT waits for the user to enter another line, which can be just pressing the ENTER key, before resuming. The same thing will happen if PLOT sends any kind of warning or comment to the user as it prepares the data for a plot.

OPTIONS or ? or HELP

Display a list of the PLOT command keywords and available colors.

STATUS

Display the current values of the plotting parameters.

4. Plot Commands

Plot commands define the values of the parameters used in drawing the next plot. Parameters entered for one plot remain in effect for subsequent plots until they are overridden, either by the same command with new values or by a conflicting command.

BASIS X1 Y1 Z1 X2 Y2 Z2

Orient the plot so that the direction (X1 Y1 Z1) points to the right and the direction (X2 Y2 Z2) points up. The default values are 0 1 0 0 0 1, causing the y-axis to point to the right and the z-axis to point up. The two vectors do not have to be normalized, but they should be orthogonal. If the two vectors are not orthogonal, MCNPLOT will choose an arbitrary second vector that is orthogonal to the first vector. MCNPLOT will ignore the command if parallel or zero-length vectors are entered.

MCNP Criticality Primer II

ORIGIN VX VY VZ

Position the plot so that the origin, which is in the middle of the plot, is at the point (VX,VY,VZ). The default values are 0 0 0. The BASIS vectors are relative to this point.

EXTENT EH EV

Set the scale of the plot so that the horizontal distance from the plot origin to either side of the plot is EH and the vertical distance from the origin to the top or bottom is EV. If EV is omitted, it will be set equal to EH. If EV is not equal to EH, the plot will be distorted. The default values are 100 and 100 giving a 200x200 viewport.

PX VX

Plot a cross section of the geometry in a plane perpendicular to the x -axis at a distance VX from the geometry origin. This command is a shortcut equivalent of BASIS 0 1 0 0 0 1 ORIGIN VX vy vz, where vy and vz are the current values of VY and VZ.

PY VY

Plot a cross section of the geometry in a plane perpendicular to the y -axis at a distance VY from the geometry origin.

PZ VZ

Plot a cross section of the geometry in a plane perpendicular to the z -axis at a distance VZ from the geometry origin.

LABEL S C DES

Put labels of size S on the surfaces and labels of size C in the cells. Use the quantity indicated by DES for the cell labels. C and DES are optional parameters. The sizes are relative to 0.01 times the height of the view surface. If S or C is zero, that kind of label will be omitted. If S or C is not zero, it must be in the range from 0.2 to 100. The defaults are S=1, C=0 and DES=CEL. The allowed values of DES follow, where “:p” can be :N for neutrons, :P for photons, and :E for electrons. Following each DES value is a short description of the meaning of the values.

CEL cell names

IMP:p importances

RHO atom density

DEN mass density

VOL volume

FCL:p forced collision

MAS mass

MCNP Criticality Primer II

PWT photon-production weight

MAT material number

TMPn temperature (n=index of time)

WWNn : p weight window lower bound (n=energy or time interval)

EXT : p exponential transform

PDn detector contribution (n=tally number)

DXC : p DXTRAN contribution

U universe

LAT lattice type

FILL filling universe

NONU fission turnoff

LEVEL n

Plot only the nth level of a repeated structure geometry. A negative entry (default) plots the geometry at all levels.

MBODY

Use macrobody surface numbers or macrobody surface facet numbers as surface labels.

on display only the macrobody surface number. This is the default.

off display the macrobody surface facet numbers.

MESH n

Plot the superimposed weight-window mesh. Only a weight-window mesh read in from a WWINP file can be plotted. n can have the following values:

0 no lines

1 cell lines only

2 weight window mesh lines only

3 both cell and weight window mesh lines

MCNP Criticality Primer II

To plot the values of the mesh windows, set the cell labels to WWNn:p, where n" is the weight-window energy interval and ":p" is :N for neutrons, P for photons, or E for electrons (See the LABEL command).

SCALES *n*

Put scales and a grid on the plot. Scales and grids are incompatible with VIEWPORT SQUARE. *n* can have the following values:

- 0 neither scales nor a grid. This is the default.
- 1 scales on the edges.
- 2 scales on the edges and a grid on the plot.

COLOR *n*

Turn color on or off, set the resolution, or select physical property for color shading. The parameter *n* can have the following values:

- on turn color on.
- off turn color off.
- 50.*n*.3000 set the color resolution to *n*. A larger value increases resolution and drawing time.
- by *aa* Select physical property to use for geometry shading
Currently allowed options for 'COLOR BY' are:
 - mat material (default)
 - den gram density
 - rho atomic density
 - tmp temperature

When (den/rho/temp) is used, the geometry will be shaded by the value of the selected property using a set of 64 shades. Linear interpolation between the minimum non-zero value and the maximum value is used to select the color. A color bar legend of the shades will be drawn in the right margin. The legend is labeled with the property name and the minimum and maximum values. See Figure B-1 for an example of coloring by density (den). Coloring by material (mat) does not invoke a color bar legend.

SHADE *M1* = parameter... *M K* = parameter

Parameter can be a color name or a number from 1-64 representing the color index. Make the cells containing problem material number *M_i* a particular color. This is only valid when 'MAT' is used to COLOR BY (the default). Use the LABEL command to display material numbers. Parameter designates the desired color (e.g., green, blue, etc.). Note: color names are case-sensitive. The OPTIONS command will list available colors if your display is a color monitor. (The index of a color name is in top-bottom, left-right order.)

APPENDIX F: MCNP Surface Cards

Mnemonic	Type	Description	Equation	Card Entries
P	Plane	General	$Ax + By + Cz - D = 0$	<i>ABCD</i>
PX	"	Normal to X-axis	$x - D = 0$	<i>D</i>
PY	"	Normal to Y-axis	$y - D = 0$	<i>D</i>
PZ	"	Normal to Z-axis	$z - D = 0$	<i>D</i>
SO	Sphere	Centered at Origin	$x^2 + y^2 + z^2 - R^2 = 0$	<i>R</i>
S	"	General	$(x - \bar{x})^2 + (y - \bar{y})^2 + (z - \bar{z})^2 - R^2 = 0$	$\bar{x}\bar{y}\bar{z}R$
SX	"	Centered on X-axis	$(x - \bar{x})^2 + y^2 + z^2 - R^2 = 0$	$\bar{x}R$
SY	"	Centered on Y-axis	$x^2 + (y - \bar{y})^2 + z^2 - R^2 = 0$	$\bar{y}R$
SZ	"	Centered on Z-axis	$x^2 + y^2 + (z - \bar{z})^2 - R^2 = 0$	$\bar{z}R$
C/X	Cylinder	Parallel to X-axis	$(y - \bar{y})^2 + (z - \bar{z})^2 - R^2 = 0$	$\bar{y}\bar{z}R$
C/Y	"	Parallel to Y-axis	$(x - \bar{x})^2 + (z - \bar{z})^2 - R^2 = 0$	$\bar{x}\bar{z}R$
C/Z	"	Parallel to Z-axis	$(x - \bar{x})^2 + (y - \bar{y})^2 - R^2 = 0$	$\bar{x}\bar{y}R$
CX	"	On X-axis	$y^2 + z^2 - R^2 = 0$	<i>R</i>
CY	"	On Y-axis	$x^2 + z^2 - R^2 = 0$	<i>R</i>
CZ	"	On Z-axis	$x^2 + y^2 - R^2 = 0$	<i>R</i>
K/X	Cone	Parallel to X-axis	$\sqrt{(y - \bar{y})^2 + (z - \bar{z})^2} - t(x - \bar{x}) = 0$	$\bar{x}\bar{y}\bar{z}t^2 \pm 1$
K/Y	"	Parallel to Y-axis	$\sqrt{(x - \bar{x})^2 + (z - \bar{z})^2} - t(y - \bar{y}) = 0$	$\bar{x}\bar{y}\bar{z}t^2 \pm 1$
K/Z	"	Parallel to Z-axis	$\sqrt{(x - \bar{x})^2 + (y - \bar{y})^2} - t(z - \bar{z}) = 0$	$\bar{x}\bar{y}\bar{z}t^2 \pm 1$
KX	"	On X-axis	$\sqrt{y^2 + z^2} - t(x - \bar{x}) = 0$	$\bar{x}t^2 \pm 1$
KY	"	On Y-axis	$\sqrt{x^2 + z^2} - t(y - \bar{y}) = 0$	$\bar{y}t^2 \pm 1$

MCNP Criticality Primer II

KZ	"	On Z-axis	$\sqrt{x^2 + y^2} - t(z - \bar{z}) = 0$	$\bar{z}t^2 \pm 1$ ± 1 used only for sheet cone
SQ	Ellipsoid Hyperboloid Paraboloid	Axes Parallel to X-, Y-, or Z-axis	$A(x - \bar{x})^2 + B(y - \bar{y})^2 + C(z - \bar{z})^2$ $+ 2D(x - \bar{x}) + 2E(y - \bar{y})$ $+ 2F(z - \bar{z}) + G$	$ABCDE$ $FG\bar{x}\bar{y}\bar{z}$
GQ	Cylinder Cone Ellipsoid Hyperboloid Paraboloid	Axes Not Parallel to X-, Y-, Z-axis	$Ax^2 + By^2 + Cz^2 + Dxy + Eyz$ $+ Fxz + Gx + Hy + Jz + K = 0$	$ABCDE$ $FGHJK$
TX	Elliptical or Circular Torus. Axis is Parallel to the X-, Y-, or Z-axis	$\frac{(x - \bar{x})^2}{B^2} + \frac{(\sqrt{(y - \bar{y})^2 + (z - \bar{z})^2} - A)^2}{C^2} - 1 = 0$	$\bar{x}\bar{y}\bar{z}AB$	
TY		$\frac{(y - \bar{y})^2}{B^2} + \frac{(\sqrt{(x - \bar{x})^2 + (z - \bar{z})^2} - A)^2}{C^2} - 1 = 0$	$\bar{x}\bar{y}\bar{z}AB$	
TZ		$\frac{(z - \bar{z})^2}{B^2} + \frac{(\sqrt{(x - \bar{x})^2 + (y - \bar{y})^2} - A)^2}{C^2} - 1 = 0$	$\bar{x}\bar{y}\bar{z}AB$	

X Y Z P Surfaces defined by points

{See Chapter 3 of the MCNP manual for examples using the surface cards listed here.}

Macrobody Surfaces

(See Chapter 3 for more details):

The following macrobody surfaces are also available.

Mnemonic	Description	Card Entries
BOX	Arbitrarily oriented orthogonal box (all corners are 90°)	$V_x V_y V_z A1_x A1_y A1_z$ $A2_x A2_y A2_z A3_x A3_y$ $A3_z$
RPP	Rectangular Parallelepiped, surfaces normal to major axes, x, y, z values relative to origin.	$X_{min} X_{max} Y_{min}$ $Y_{max} Z_{min} Z_{max}$
SPH	Sphere. Equivalent to surface equation for general sphere.	$V_x V_y V_z R$
RCC	Right Circular Cylinder, can	$V_x V_y V_z H_x H_y H_z R$
RHP or HEX	Right Hexagonal Prism. Differs from ITS (ACCEPT) format.	$v1 v2 v3 h2 h2 h3 r1$ $r2 r3 s1 s2 s3 t1 t2 t3$
REC	Right Elliptical Cylinder	$V_x V_y V_z H_x H_y H_z$ $V1_z V1_y V1_z V2_x V2_y$ $V2_z$
TRC	Truncated Right-angle Cone	$V_x V_y V_z H_x H_y H_z R1$ $R2$
ELL	ELLipsoids	$V1_x V1_y V1_z V2_x V2_y$ $V2_z Rm$
WED	Wedge	$V_x V_y V_z V1_x V1_y V1_z$ $V2_x V2_y V2_z V3_x V3_y$ $V3_z$
ARB	ARBitrary polyhedron	$ax ay az bx by bz cx cy$ $cz \dots hx by hz N1 N2$ $N3 N4 N5 N6$

APPENDIX G: MCNP Forum FAQ

This appendix contains some common user questions and answers on criticality topics presented to the email group [0](#). The common answers are also given. The complete list of MCNP questions and answers can be found on the RSICC MCNP Notebook webpage,

<http://www-rsicc.ornl.gov/enote.html>

Emails relating to specific versions of MCNP are found at:

<http://www-rsicc.ornl.gov/ENOTE/enotmcnp.html> [for MCNP]

<http://www-rsicc.ornl.gov/ENOTE/past.html> [for Versions prior to MCNP4C]

<http://epicws.epm.ornl.gov/ENOTE/enotmcnp4c.html> [for MCNP4C]

<http://www-rsicc.ornl.gov/ENOTE/enotmcnp5.html> [for MCNP5]

Question: Best Nuclear Data for Criticality Calculations

Hello All

MCNP5-ENDFBVI Release 2:

Is there any general guidance available for the user with respect to choosing the 'best' nuclear data for any given criticality calculation?

E.g. I have seen 92235 and 92235.50c used in various places.

I appreciate that there probably isn't a simple answer to this one - broad guidance only is sought, and pointers to any useful more detailed guidance documentation on this subject would be appreciated.

Thanks in advance

Regards

Andrew Barnes

andrew.barnes@nuclear.co.uk

Answer

The nuclear data in the MCNP libraries are intended to be faithful reproductions of the data source -- e.g., ENDF60 (.60c) is based on ENDF/B-VI release 2, ENDF66 (.66c) is based on ENDF/B-VI release 6, and the .50c data are based on ENDF/B-V. The sources for the individual data files are identified in Table G.2 in Appendix G of the MCNP manual.

There is no single set that always gives the best agreement with experimental data. For criticality calculations, for example, one set may tend to give better agreement for cases with fast spectra and another for cases with thermal spectra. In general terms, newer data are preferable to older data, but that is not necessarily the case for every isotope in all possible configurations. For criticality applications, probably the best way to proceed is to select a single set of data (e.g., .60c or .66c), perform validation calculations to establish a reactivity bias, and then use that set of data in combination with the bias to determine reactivity for similar cases. Sorry, but there just isn't an easy answer to your question.

One thing I definitely would not recommend is using identifiers without a suffix (92235 as opposed to 92235.50c). In such cases, MCNP uses the first file for that isotope listed in the XS DIR file. The XS DIR file that is released from Los Alamos with the data libraries lists the most recent dataset first, the next most recent next, etc. However, if you or someone else has altered that sequence, the only way to know in advance which cross sections you actually will be using is to check the XS DIR file.

Russ Mosteller

mosteller@lanl.gov

Question: Transformation and Source Coordinates Problem

Hi All-

I have a transformation applied to cells to rotate and translate. When i place my point sources, do i place them in the "new" coordinate system or the "old" one? The cells containing sources were tranformed but other cells stayed fixed.

Please inform me. Thanly you in advance!

Cynthia Tozian

CTozian@aol.com

Answer

Hi,

I think you can place the point sources in the new coordinate system. You can verify it by checking the geometry in a viewer (to observe if the rotation/translation is OK) and add a print card (print 110) to check the first 50 starting histories in mcnp coordinate system. Moreover, you can specify for example SDEF X=x0 Y=y0 Z=z0 Cell=6, where cell 6 has been transformed. Then if particles do not start in cell 6, MCNP indicates an error.

Benjamin Gonzalez
be_gonzalez@yahoo.fr

The point source coordinates are AFTER the transformation is applied.
For example, consider a sphere centered on the origin with a transformation that is only a translation (10, 0, 0). After the transformation, the sphere is centered at (10, 0, 0). To specify a point source at the center of the sphere, the location of the source is (10, 0, 0), NOT (0, 0, 0).

You can use the MCNP geometry plotter or the 2D plots in Sabrina to find the coordinates for the point source. The plots show the geometry after the transformation is applied.

Kenneth A. Van Ripper
kvr@rt66.com

Question: Bad Trouble, New Source Has Overrun the Old Source

Dear MCNP users,
running MCNP4B engaged with Monteburn I met the following error I never saw before:

bad trouble in subroutine colidk of mcrun
source particle no. 2078
starting random number = 158979194342901
the new source has overrun the old source.
run terminated because of bad trouble.

has anyone seen the same?
bye all
Piero Neuhold
neuhold@ansaldo.it

Answer

Fission sites for each cycle are those points generated by the previous cycle. For the initial cycle, fission sites can come from an SRCTP file from a similar geometry, from a KSRC card, or from a volume distribution specified by an SDEF card.

If in the first cycle the source being generated overruns the current source, the initial guess (2nd entry on kcode card) is probably too low. The code then proceeds to print a comment, continues without writing a new source, calculates keff, reads the initial source back in, and begins the problem using instead of keff. If the generated source again overruns the current source after the first cycle, the job terminates and either a better initial guess of keff or more source space (5th entry on kcode card) should be specified on the next try.

MCNP5 Manual.

Question: Photo-neutron Production in Deuterium

Does anyone know of a patch for photoneutron production in Deuterium?
Thanks and Best Regards
Dean
DTaylor@nbpower.com

Answer

Hello Dean,
A patch for photoneutron production in Deuterium(and Be) was given in old(1985) reprint:
ORNL/TM-13073,F.X.Gallmeier, General Purpose Photoneutron Production in MCNP4A
Best regards,
A_Rogov
rogov@nf.jinr.ru

Question: Zero Lattice Element Hit – Source Difficulty

Hello

I have made a box (10 x 10 x 20) chopped up in smaller boxes (1 x 1 x 1) but when I try to run it, I get the following message; "zero lattice element hit"

My guess is that something is wrong (?) with the indices for the smaller boxes in the tally row below.

My code looks like this:

```
1 1 -1.00 -1 fill=1 imp:n=1
2 1 -1.00 -2 lat=1 u=1 imp:n=1
3 0 1 imp:n=0
```

```
1 box -5 -5 -10 10 0 0 0 10 0 0 0 20
2 box -5 -5 -10 1 0 0 0 1 0 0 0 1
```

```
F4:n 1 (2<2[0:9 0:9 0:19])
```

Does somebody know what to do?

Kind regards

Christofer Willman

willman@tsl.uu.se

Answer

It would be most helpful if the entire input file is provided when asking for help. This file has no source so I added the following

```
sdef pos 0 0 0
```

The code gave the following error message:

```
bad trouble in subroutine findel of mcrun
source particle no.      1
starting random number = 6647299061401
zero lattice element hit.
```

It would also be helpful if the entire error is provided when asking for help. Assuming that this is the real input file and that it gave the error above the problem is pretty simple. The point 0 0 0 is on a surface of the problem. I moved the source off the surface:

```
sdef pos .1 .1 .1
```

and seem to have successfully transported particles. You could also specify sur=

The entire input file is:

```
1 0 -1 fill=1 imp:n=1
2 0 -2 lat=1 u=1 imp:n=1
3 0 1 imp:n=0
```

```
1 box -5 -5 -10 10 0 0 0 10 0 0 0 20
2 box -5 -5 -10 1 0 0 0 1 0 0 0 1
```

```
f4:n 1 (2<2[0:9 0:9 0:19])
```

```
sdef pos .1 .1 .1
```

```
print
```

Judith Briesmeister

jfb@lanl.gov

Question: Zero Lattice Element Hit – Fill Problem

Dear Colleague,

I've been trying to specify a source in the case of repeated structures in a geometry having a number of levels, i.e. a hexagone lattice filled with another hexagone lattice where each hexagone has a small cylinder where I'd like to place my source. Perhaps someone has already had a similar problem.

I get 2 different error messages:

```
a) bad trouble in subroutine sourceb of mcrun
source particle no.      3
starting random number = 274972369747969
the sampling efficiency in source cell  8 is too low.
b) bad trouble in subroutine newcel of mcrun
source particle no.     24
starting random number = 127574596640797
zero lattice element hit.
```

depending on the level where I try to place my source. I attach my sample to this message. Thanks for your help or coments in advance.

Yours Sincerely,
Danas Ridikas
ridikas@cea.fr

Answer

I took your file, placed another sphere around your geometry and tried starting source particles in that sphere, at pos 0 0 505 and changed the importances to allow this. MCNP reports;
mcnp ver=4c2 ld=01/20/01 12/20/01 10:48:32
warning. universe map (print table 128) disabled.

```
warning. surface  22  appears more than once in a chain.
warning. surface  23  appears more than once in a chain.
total fission nubar data are being used.
warning.  1 materials had unnormalized fractions. print table 40.
warning. surface  11 is not used for anything.
warning. surface  12 is not used for anything.
imcn  is done
dump  1 on file runtpe  nps =    0  coll =    0
          ctm =  0.00  nrn =    0
xact  is done
dynamic storage =  648512 words,  2594048 bytes.  cp0 = 0.01
geometry error in newcel
```

```
bad trouble in subroutine newcel of mcrun
source particle no.      2
starting random number = 130407176137285
zero lattice element hit.
```

This usually indicates that you have your fills incorrectly defined. I have not considered what geometry description you have wrong. Have you set up this file in sections, verifying that each piece is correct before you add the next complicated fill? If not, I suggest that you do so. Then after your geometry is correctly defined, worry about the sdf card.

Judith Briesmeister
jfb@lanl.gov

MCNP Criticality Primer II

Dear Danas,

it seems to me, that at the source definition you need a more, lower level cell, because cell 10 is a lattice.

I modified the sdfef to cel 1:2:8:10:11 eff

0.0001

and the code calculated some value of keff, while it it stopped because of zero element hit. **I met with this error earlier, and the reason was, that I did not fill a cell with with a lattice completely, i.e. the lattice had elements without explicit definitions on lat card, which were used in filling the cell.**

Best regards and Merry Christmas

Gabor Hordosy

KFKI Atomic Energy Research Institute

hordosy@sunserv.kfki.hu

Question: Zero Lattice Element Hit – Large Lattices

Dear MCNPers,

in the past I asked the forum for advice on the simulations of CT voxel based simulations. My runs seemed to stop in the lack of enough memory to run the problems. In one of the input files I have then provided in the list I had a CT input data package of 36 slices and an image resolution of 512x512 pixels. Now that I have modified the input file again with a lower in plane resolution of 128 x 128 pixels I tried to rerun the modified input deck on a Windows PC with a Pentium 1GHz processor and 512MBRAM memory, but as soon as I execute the command line it comes to the following error message:

fortrl: severe (157): Programm Exception - access violation

As I am not able to run my input deck on a supercomputer or on a UNIX workstation, could someone try to run the input deck I am attaching to my email (zipped) and tell me if this error message comes due to a wrong input (maybe geometry) or because of inadequate memory? Is there one that could tell me how to recompile MCNP4c2 and how could I increase the mdas value to overcome this limitation, if of course this is the reason. Maybe people who have already experience with such big amount of input data and worked on CT based geometries could give me specific advice. Please be patient and find the time to have a look and make comments and suggestions. I would be grateful to you.

Thank you very much

Giorgos A.

ganagnos@ix.urz.uni-heidelberg.de

Dear MCNP-users,

first of all I would like to thank all of you who responded and made me understand the errors that were evident in my input file geometry. First of all I made a mistake in the material card input and then it was found that the lattice element number was more than 128x128x36 and this because some space characters were interpreted as zeros, a material number that is not defined and not allowed as well. So this was the main mistake. I corrected both mistakes and I am now attaching the new input file. When I tried to execute the new input file I now got another error message:

bad trouble in mcrun in routine newcel
source particle no. 1
starting random number 54879631254789
zero lattice element hit.

MCNP Criticality Primer II

Tim Goorley wrote that this problem happened in the past too, but as I haven't found any related emails and answers, could someone tell what is wrong in order to correct it?

Thanks all of you once more in advance. I am attaching the corrected input file as a .txt file (zipped)

Kind regards,
Giorgos A.

Answer

Dear Giorgos,
after giving the lattice cell, when you specify the index boundaries as -64:63 -64:63 -18:17, you fill the volume $-11.69994 < x < 11.517$, $-11.69994 < y < 11.517$ and $-0.8172 < z < 0.7718$ (with universes 1, 2 or 3). Beside this volume the filling of the lattice element is undefined, but you try to fill the volume $-11.7 < x < 11.7$, $-11.7 < y < 11.7$ and $-5.4 < z < 5.4$. You can check this if you make two plots, for example $0.1 \ 0.1 \ 0.1 \ ex \ 0.5 \ pz \ 0$ and or $0.1 \ 0.1 \ 0.1 \ ex \ 0.5 \ pz \ 1$. When I modified the boundaries of cell 501 as written above, (more exactly, a little bit narrower), the MCNP run terminated properly. I think that the "zero lattice element hit" message is caused by this type of problem in some other cases too.

Best regards,
Gabor

hordosy@sunserv.kfki.hu

APPENDIX H: Example Problem Input Decks

The example problems have file names *ex##*. The first digit corresponds to the chapter they are presented in. The second digit corresponds to the section they first appear. Some of the more complex input decks span several sections. You should be able to cut and paste each example problem (excluding the line of text stating “Example Problem x-y.”) into an individual ascii text file and then run them with MCNP.

Example Problem 1-2.

Example 1-2. Jezebel problem. Bare Pu sphere w/ Ni shell

```
C      Cell cards
1 1  4.0290e-2  -1      imp:n=1
2 2  9.1322e-2   1 -2   imp:n=1
3 0                      2   imp:n=0

C      Surface cards
1      so  6.38493
2      so  6.39763

C      Data cards
C      Criticality Control Cards
kcode 5000 1.0 50 250
ksrc   0 0 0
m1    94239.66c 3.7047e-2  94240.66c 1.751e-3
      94241.66c 1.17e-4    31000.66c 1.375e-3
m2    28058.66c 0.6808    28060.66c 0.2622
      28061.66c 0.0114    28062.66c 0.0363
      28064.66c 0.0093
```

Example Problem 2-3.

Example 2-3. Bare Pu Cylinder

```
C      Cell Cards
1      1 -15.8      -1 2 -3 imp:n=1
2      0                      1:-2:3 imp:n=0

C      Surface Cards
1      cz  4.935
2      pz  0
3      pz 17.273

C      Data Cards
C      Material Data Cards
m1    94239.66c 1.0
C      Criticality Control Cards
kcode 5000 1.0 50 250
ksrc  0 0 8.6
```

Example Problem 2-3m.

Example 2-3. Bare Pu Cylinder - Macrobody

```

C      Cell Cards
1      1 -15.8      -1 imp:n=1
2      0              1 imp:n=0

C      Surface Cards
1      rcc 0 0 0      0 0 17.273      4.935

C      Data Cards
m1      94239.66c 1.0
kcode 5000 1.0 50 250
ksrc 0 0 8.6

```

Example Problem 2-4.

Example 2-4. Pu cylinder, radial U(nat) reflector

```

C      Cell Cards
1      1 -15.8      -1 2 -3      imp:n=1
2      2 -18.8      1 -4 2 -3 imp:n=1
3      0              4:-2:3      imp:n=0

C      Surface Cards
1      cx  4.935      $ Pu Cylinder
2      px  0.0        $ bottom
3      px  6.909      $ top
4      cx  9.935      $ U reflector

C      Data Cards
C      Material Data Cards
m1      94239.66c 1.0
m2      92238.66c 0.992745 92235.66c 0.007200
C      Criticality Control Cards
kcode 5000 1.0 50 250
ksrc 3.5 0 0

```

Example Problem 2-4m.

Example 2-4. Pu cylinder, radial U(nat) refl. - Macrobody

```

C      Cell Cards
1      1  -15.8      -1      imp:n=1
2      2  -18.8      1 -2    imp:n=1
3      0              2      imp:n=0

C      Surface Cards
1      rcc  0  0  0      6.909  0  0  4.935  $ Pu cylinder
2      rcc  0  0  0      6.909  0  0  9.935  $ U reflector

C      Data Cards
m1     94239.66c 1.0
m2     92238.66c 0.992745 92235.66c 0.007200
kcode  5000 1.0 50 250
ksrc   3.5 0  0

```

Example Problem 2-5.

Example 2-5. Pu cylinder, radial U(nat) reflector

```

C      Cell Cards
1      1  -15.8      -1  2 -3    imp:n=1
2      2  -18.8      -4 -6  5 #1 imp:n=1
3      0              4:-5:6    imp:n=0

C      Surface Cards
1      cx   4.935
2      px   0.0
3      px   6.909
4      cx   9.935
5      px  -5.0
6      px  11.909

C      Data Cards
C      Material Data Cards
m1     94239.66c 1.0
m2     92238.66c 0.992745 92235.66c 0.007200
C      Criticality Control Cards
kcode  5000 1.0 50 250
ksrc   3.5 0  0

```

Example Problem 2-5m.

Example 2-5, Pu cylinder, radial U(nat) reflector - Macrobody

```

C      Cell Cards
1      1  -15.8      -1      imp:n=1
2      2  -18.8      1 -2      imp:n=1
3      0              2      imp:n=0

C      Surface Cards
1      rcc  0  0  0      6.909  0  0  4.935  $ Pu cylinder
2      rcc -5  0  0      16.909  0  0  9.935  $ U reflector

C      Data Cards
m1     94239.66c 1.0
m2     92238.66c 0.992745 92235.66c 0.007200
kcode  5000 1.0 50 250
ksrc   3.5 0 0

```

Example Problem 3-4.

Example 3-4. S(alpha, beta) Treatment

```

C      Cell Cards
1      1      9.6586E-2  -1 3 -4      imp:n=1
2      0              -1 4 -5      imp:n=1
3      2      -2.7      (1 -2 -5 3):(-2 -3 6)  imp:n=1
4      0              2:5:-6      imp:n=0

C      Surface Cards
1      cz  20.12
2      cz  20.2787
3      pz  0.0
4      pz  100.0
5      pz  110.0
6      pz -0.1587

C      Data Cards
C      Material Data Cards
m1     1001.62c 5.7058e-2  8016.62c 3.2929e-2
      9019.62c 4.3996e-3  92238.66c 2.0909e-3
      92235.66c 1.0889e-4
mt1    lwtr.60t
m2     13027.62c 1

C      Criticality Control Cards
kcode  5000 1.0 50 250
ksrc   0 0 50.0

```

Example Problem 3-4m.

Example 3-4. S(alpha, beta) Treatment with Macrobodyes

```

C      Cell Cards
1      100 9.6586E-2 -10                               imp:n=1
2      0 -20                                           imp:n=1
3      101 -2.7 10 20 -30                             imp:n=1
4      0 30                                             imp:n=0

C      Surface Cards
10     rcc 0 0 0 0 0 100.0 20.12 $ Can of UO2F2
20     rcc 0 0 100 0 0 10.0 20.12 $ Void gap above UO2F2
30     rcc 0 0 -0.1587 0 0 110.1587 20.2787 $ Exterior shell of Al

C      Data Cards
m100   1001.62c 5.7058e-2 8016.62c 3.2929e-2
        9019.62c 4.3996e-3 92238.66c 2.0909e-3
        92235.66c 1.0889e-4
mt100  lwtr.60t
m101   13027.62c 1
kcode  5000 1.0 50 250
ksrc   0 0 50.0

```

Example Problem 3-4nomt.

Example 3-4. NO S(alpha, beta) Treatment!

```

C      Cell Cards
1      1 9.6586E-2 -1 3 -4                             imp:n=1
2      0 -1 4 -5                                       imp:n=1
3      2 -2.7 (1 -2 -5 3):(-2 -3 6)                 imp:n=1
4      0 2:5:-6                                         imp:n=0

C      Surface Cards
1      cz 20.12
2      cz 20.2787
3      pz 0.0
4      pz 100.0
5      pz 110.0
6      pz -0.1587

C      Data Cards
m1     1001.62c 5.7058e-2 8016.62c 3.2929e-2
        9019.62c 4.3996e-3 92238.66c 2.0909e-3
        92235.66c 1.0889e-4
c mt1  lwtr.60t
m2     13027.62c 1
kcode  5000 1.0 50 250
ksrc   0 0 50.0

```

Example Problem 4-3.

Example 4-3, Repeated Structures: Two Cylinders

C Cell Cards

```

1 1 9.9605e-2 -1 -4 5 u=3 imp:n=1 $ Solution
2 0 -1 4 u=3 imp:n=1 $ Void region above solution
3 2 -2.7 1:-5 u=3 imp:n=1 $ Al container
4 0 -2 -3 6 fill=3 imp:n=1
5 like 4 but trcl (17 0 0) imp:n=1
6 3 -1.0 10 -11 8 -9 7 -3 #4 #5 imp:n=1
7 0 -10:11:-8:9:-7:3 imp:n=0

```

C Surface Cards

```

1 cz 6.35 $ Solution radius
2 cz 6.50 $
3 pz 80.0 $ Top of container
4 pz 70.2 $ Top of solution
5 pz 0.0
6 pz -0.15
7 pz -20.15 $ Bottom of tank

```

C Sides of Tank

```

8 px -16.5
9 px 43.5
10 py -26.5
11 py 26.5

```

C Data Cards

C Materials Cards

```

m1 1001.62c 6.2210e-2 8016.62c 3.3621e-2 9019.62c 2.5161e-3
    92235.66c 1.1760e-3 92238.66c 8.2051e-5
mt1 lwtr.60t
m2 13027.62c 1.0
m3 1001.62c 2 8016.62c 1
mt3 lwtr.60t

```

C Control Cards

```

kcode 5000 1.0 50 250
ksrc 0 0 35 17 0 35

```

Example Problem 5-3.

Example 5-3, Square Lattice of 3x2 Pu Cylinders

C Cell Cards

```

1 1 9.9270e-2 -1 5 -6          u=1 imp:n=1 $Pu Soln.
2 0          -1 6 -7          u=1 imp:n=1 $ void above Pu Soln.
3 2 8.6360e-2 -2 #1 #2       u=1 imp:n=1 $ SS
4 0          2                u=1 imp:n=1 $ void
5 0   -8   9 -10 11 lat=1 fill=1 u=2 imp:n=1 $ lattice
6 0   9 -12 11 -14 3 -4   fill=2   imp:n=1 $ window
7 0  -9:12:-11:14:-3:4     imp:n=0 $ outside

```

C Solution Cylinder Surface Cards

```

1 cz 12.49
2 cz 12.79
5 pz 0.0
6 pz 39.24
7 pz 101.7

```

C Beginning of lattice surfaces - Updated Lattice

```

8 px 17.79
9 px -17.79
10 py 17.79
11 py -17.79

```

C Beginning of Window Surfaces

c window surfaces can be coincident with lattice surfaces.

```

3 pz -1.0
4 pz 102.7
12 px 88.95
14 py 53.37

```

C Control Cards

```

kcode 5000 1.0 50 250
c one source point in each volume of Pu Solution
ksrc 0 0 19.62 35.58 0 19.62 71.16 0 19.62
      0 35.58 19.62 35.58 35.58 19.62 71.16 35.58 19.62

```

C Material cards

```

m1 1001.62c 6.0070-2 8016.62c 3.6540-2 7014.62c 2.3699-3
    94239.66c 2.7682-4 94240.66c 1.2214-5 94241.66c 8.3390-7
    94242.66c 4.5800-8
mt1 lwtr.60t
m2 24050.62c 7.195-4 24052.62c 1.38589-2 24053.62c 1.5713-3
    24054.62c 3.903-4
    26056.62c 3.704-3 26056.62c 5.80869-2 26057.62c 1.342-3
    26058.62c 1.773-4
    28058.62c 4.432-3 28060.62c 1.7069-3 28061.62c 7.42-5
    28062.62c 2.363-4 28064.62c 6.05-5

```

Example Problem 5-4.

Example 5-4, Hexahedral Lattices. Change in Material in 2 elements.

C Cell Cards

```

1 1 9.9270e-2 -1 5 -6 u=1 imp:n=1 $Pu Soln.
2 0 -1 6 -7 u=1 imp:n=1 $ void above Pu Soln.
3 2 8.6360e-2 -2 #1 #2 u=1 imp:n=1 $ SS
4 0 2 u=1 imp:n=1 $ void
5 0 -8 9 -10 11 lat=1 fill=0:2 0:1 0:0
  1 1 3 1 3 1 u=2 imp:n=1 $ lattice
6 0 9 -12 11 -14 3 -4 fill=2 imp:n=1 $ window
7 0 -9:12:-11:14:-3:4 imp:n=0 $ outside
11 like 1 but mat=3 rho=-1.60 u=3 imp:n=1
12 like 2 but u=3 imp:n=1
13 like 3 but u=3 imp:n=1
14 like 4 but u=3 imp:n=1

```

C Solution Cylinder

```

1 cz 12.49
2 cz 12.79
5 pz 0.0
6 pz 39.24
7 pz 101.7

```

C Beginning of lattice surfaces

```

8 px 17.79
9 px -17.79
10 py 17.79
11 py -17.79

```

C Beginning of Window Surfaces

```

3 pz -1.0
4 pz 102.7
12 px 88.95
14 py 53.37

```

C Control Cards

kcode 5000 1.0 50 250

c one source point in each volume of Pu Solution

```

ksrc 0 0 19.62 35.58 0 19.62 71.16 0 19.62
      0 35.58 19.62 35.58 35.58 19.62 71.16 35.58 19.62

```

C Material cards

```

m1 1001.62c 6.0070-2 8016.62c 3.6540-2 7014.62c 2.3699-3
    94239.66c 2.7682-4 94240.66c 1.2214-5 94241.66c 8.3390-7
    94242.66c 4.5800-8
mt1 lwtr.60t
m2 24050.62c 7.195-4 24052.62c 1.38589-2 24053.62c 1.5713-3
    24054.62c 3.903-4
    26056.62c 3.704-3 26056.62c 5.80869-2 26057.62c 1.342-3
    26058.62c 1.773-4
    28058.62c 4.432-3 28060.62c 1.7069-3 28061.62c 7.42-5
    28062.62c 2.363-4 28064.62c 6.05-5
m3 6000.66c 1
mt3 grph.60t

```

Example Problem 5-5.

Example 5-5, Hexahedral Lattices. Lattice with 1 empty element.

C Cell Cards

```

1 1 9.9270e-2 -1 5 -6 u=1 imp:n=1 $Pu Soln.
2 0 -1 6 -7 u=1 imp:n=1 $ void above Pu Soln.
3 2 8.6360e-2 -2 #1 #2 u=1 imp:n=1 $ SS
4 0 2 u=1 imp:n=1 $ void
5 0 -8 9 -10 11 lat=1 fill=0:2 0:1 0:0
  2 1 3 1 3 1 u=2 imp:n=1 $ lattice
6 0 9 -12 11 -14 3 -4 fill=2 imp:n=1 $ window
7 0 -9:12:-11:14:-3:4 imp:n=0 $ outside
11 like 1 but mat=3 rho=-1.60 u=3 imp:n=1
12 like 2 but u=3 imp:n=1
13 like 3 but u=3 imp:n=1
14 like 4 but u=3 imp:n=1

```

C Solution Cylinder

```

1 cz 12.49
2 cz 12.79
5 pz 0.0
6 pz 39.24
7 pz 101.7

```

C Beginning of lattice surfaces

```

8 px 17.79
9 px -17.79
10 py 17.79
11 py -17.79

```

C Beginning of Window Surfaces

```

3 pz -1.0
4 pz 102.7
12 px 88.95
14 py 53.369

```

C Control Cards

kcode 5000 1.0 50 250

c one source point in each volume of Pu Solution

```

ksrc 0 0 19.62 35.58 0 19.62 71.16 0 19.62
      0 35.58 19.62 35.58 35.58 19.62 71.16 35.58 19.62

```

C Material cards

```

m1 1001.62c 6.0070-2 8016.62c 3.6540-2 7014.62c 2.3699-3
    94239.66c 2.7682-4 94240.66c 1.2214-5 94241.66c 8.3390-7
    94242.66c 4.5800-8
mt1 lwtr.60t
m2 24050.62c 7.195-4 24052.62c 1.38589-2 24053.62c 1.5713-3
    24054.62c 3.903-4
    26056.62c 3.704-3 26056.62c 5.80869-2 26057.62c 1.342-3
    26058.62c 1.773-4
    28058.62c 4.432-3 28060.62c 1.7069-3 28061.62c 7.42-5
    28062.62c 2.363-4 28064.62c 6.05-5
m3 6000.66c 1
mt3 grph.60t

```

Example Problem 5-6.

Example 5, Hexahedral Lattices. Different Fill Cell Size

C Cell Cards

```

1 1 9.9270e-2 -1 5 -6 u=1 imp:n=1 $Pu Soln.
2 0 -1 6 -7 u=1 imp:n=1 $ void above Pu Soln.
3 2 8.6360e-2 -2 #1 #2 u=1 imp:n=1 $ SS
4 0 2 u=1 imp:n=1 $ void
5 0 -8 9 -10 11 lat=1 fill=0:2 0:1 0:0
   1 3 1 1 1 3 u=2 imp:n=1 $ lattice
6 0 9 -12 11 -14 3 -4 fill=2 imp:n=1 $ window
7 0 -9:12:-11:14:-3:4 imp:n=0 $ outside
21 3 -1.60 -21 5 -6 u=3 imp:n=1
22 0 -21 6 -7 u=3 imp:n=1
23 2 8.6360e-2 -22 #21 #22 u=3 imp:n=1
24 0 22 u=3 imp:n=1

```

C Solution Cylinder

1 cz 12.49

2 cz 12.79

5 pz 0.0

6 pz 39.24

7 pz 101.7

C Beginning of lattice Surfaces

8 px 17.79

9 px -17.79

10 py 17.79

11 py -17.79

C Beginning of Window Surfaces

3 pz -1.0

4 pz 102.7

12 px 88.95

14 py 53.369

C Beginning of Smaller Cylinder Surfaces

21 cz 5

22 cz 5.5

C Control Cards

kcode 5000 1.0 50 250

c one source point in each volume of Pu Solution

ksrc 0 0 19.62 35.58 0 19.62 71.16 0 19.62

0 35.58 19.62 35.58 35.58 19.62 71.16 35.58 19.62

C Material cards

m1 1001.62c 6.0070-2 8016.62c 3.6540-2 7014.62c 2.3699-3

94239.66c 2.7682-4 94240.66c 1.2214-5 94241.66c 8.3390-7

94242.66c 4.5800-8

mt1 lwtr.60t

m2 24050.62c 7.195-4 24052.62c 1.38589-2 24053.62c 1.5713-3

24054.62c 3.903-4

26056.62c 3.704-3 26056.62c 5.80869-2 26057.62c 1.342-3

26058.62c 1.773-4

28058.62c 4.432-3 28060.62c 1.7069-3 28061.62c 7.42-5

28062.62c 2.363-4 28064.62c 6.05-5

m3 6000.66c 1

mt3 grph.60t

Example Problem 6-3.

Example 6-3, Hexagonal Lattice of Pu Cylinders

C Cell Cards

```

1 1 9.8983e-2 -1 5 -4 u=1 imp:n=1
2 0 -1 4 u=1 imp:n=1
3 2 -2.7 -2 (1:-5) u=1 imp:n=1
4 3 -1.0 2 u=1 imp:n=1
5 0 -8 11 -7 10 -12 9 lat=2 fill=1 u=2 imp:n=1
6 0 -13 6 -3 fill=2 imp:n=1
7 3 -1.0 (13:-6) -3 15 -14 imp:n=1
8 0 14:3:-15 imp:n=0

```

C Solution Cylinder Surface Cards

```

1 cz 7.60 $ outer radius of the solution
2 cz 7.75 $ outer radius of container
4 pz 23.4 $ top of solution
5 pz 0.0 $ bottom of solution

```

C Surfaces 7-12 are the array lattice cell

```

7 p 1 1.73205 0 23.1
8 px 11.55
9 p -1 1.73205 0 -23.1
10 p 1 1.73205 0 -23.1
11 px -11.55
12 p -1 1.73205 0 23.1

```

C Window Surfaces

```

3 pz 40.0 $ Top of aluminum cylinder
6 pz -1.0 $ bottom of aluminum container
13 cz 32.0 $ cylinder for array window

```

C Reflector Surfaces

```

14 cz 52.0 $ outer radius of reflector
15 pz -21.0 $ botmmon edge of reflector

```

C Data Cards

C Material Cards

```

m1 1001.62c 6.1063-2 8016.62c 3.3487-2 9019.62c 2.9554-3
    92235.66c 1.3784-3 92238.66c 9.9300-5

```

mt1 lwtr.60t

m2 13027.62c 1.0

m3 1001.62c 2 8016.62c 1

mt3 lwtr.60t

C Criticality Control Cards

kcode 5000 1.0 50 250

```

ksrc 0 0 11.7 -23.1 0 11.7 23.1 0 11.7
    -11.55 20.0 11.7 -11.5 -20.0 11.7
    11.55 20.0 11.7 11.5 -20.0 11.7

```

Example Problem 6-5.

Example 6-5, Expanded Fill card in triangular lattice.

C Cell Cards

```

1 1 9.8983e-2 -1 5 -4 u=1 imp:n=1
2 0 -1 4 u=1 imp:n=1
3 2 -2.7 -2 (1:-5) u=1 imp:n=1
4 3 -1.0 2 u=1 imp:n=1
5 0 -8 11 -7 10 -12 9 lat=2 u=2 fill=-2:2 -2:2 0:0
    2 2 2 1 2 $ x=-2 to x=2; y=-2
    2 1 3 1 1 $ " " ; y=-1
    2 1 1 1 2 $ " " ; y= 0
    1 1 1 1 2 $ " " ; y= 1
    2 1 2 2 2 imp:n=1 $ " " ; y= 2
6 0 -13 6 -3 fill=2 imp:n=1
7 3 -1.0 (13:-6) -3 15 -14 imp:n=1
8 0 14:3:-15 imp:n=0
9 like 1 but mat=4 rho=-1.60 u=3 imp:n=1
10 like 2 but u=3 imp:n=1
11 like 3 but u=3 imp:n=1
12 like 4 but u=3 imp:n=1

```

C Solution Cylinder Surface Cards

```

1 cz 7.60 $ outer radius of the solution
2 cz 7.75 $ outer radius of container
4 pz 23.4 $ top of solution
5 pz 0.0 $ bottom of solution
C Surfaces 7-12 are the array lattice cell
7 p 1 1.73205 0 23.1
8 px 11.55
9 p -1 1.73205 0 -23.1
10 p 1 1.73205 0 -23.1
11 px -11.55
12 p -1 1.73205 0 23.1
C Window Surfaces
3 pz 40.0 $ Top of aluminum cylinder
6 pz -1.0 $ bottom of aluminum container
13 cz 32.0 $ cylinder for array window
C Reflector Surfaces
14 cz 52.0 $ outer radius of reflector
15 pz -21.0 $ bottom edge of reflector

```

C Data Cards

```

m1 1001.62c 6.1063-2 8016.62c 3.3487-2 9019.62c 2.9554-3
    92235.66c 1.3784-3 92238.66c 9.9300-5
mt1 lwtr.60t
m2 13027.62c 1.0
m3 1001.62c 2 8016.62c 1
mt3 lwtr.60t
m4 6000.66c 1
mt4 grph.60t

```

C Criticality Control Cards

```

kcode 5000 1.0 50 250
ksrc 0 0 11.7 -23.1 0 11.7 23.1 0 11.7
    -11.55 20.0 11.7 -11.5 -20.0 11.7
    11.55 20.0 11.7 11.5 -20.0 11.7

```

Example Problem 6-6.

Example 6-6, Hexagonal Lattices: Nonequilateral triangular lattice.

C Cell Cards

```

1  1  9.8983e-2  -1  5  -4  u=1  imp:n=1
2  0              -1  4  u=1  imp:n=1
3  2  -2.7      -2  (1:-5)  u=1  imp:n=1
4  3  -1.0       2          u=1  imp:n=1
5  0          -8  11  -7  10  -12  9  lat=2  fill=1  u=2  imp:n=1
6  0          -13  6  -3          fill=2  imp:n=1
7  3  -1.0      (13:-6)  -3  15  -14  imp:n=1
8  0          14:3:-15          imp:n=0

```

C Solution Cylinder Surface Cards

```

1  cz  4.60  $  outer radius of the solution
2  cz  4.75  $  outer radius of container
4  pz  23.4  $  top of solution
5  pz  0.0   $  bottom of solution

```

C Surfaces 7-12 are the array lattice cell

```

7  p  1  1.73205  0  23.1
8  px  5.55
9  p -1  1.73205  0 -23.1
10 p  1  1.73205  0 -23.1
11 px -5.55
12 p -1  1.73205  0  23.1

```

C Window Surfaces

```

3  pz  40.0  $  Top of aluminum cylinder
6  pz  -1.0  $  bottom of aluminum container
13 cz  32.0  $  cylinder for array window

```

C Reflector Surfaces

```

14 cz  52    $  outer radius of reflector
15 pz -21    $  bottom edge of reflector

```

C Data Cards

C Material Cards

```

m1  1001.62c  6.1063-2  8016.62c  3.3487-2  9019.62c  2.9554-3
    92235.66c  1.3784-3  92238.66c  9.9300-5
mt1 lwtr.60t
m2  13027.62c  1.0
m3  1001.62c  2      8016.62c  1
mt3 lwtr.60t

```

C Criticality Control Cards

```

kcode 5000 1.0 55 250
ksrc   0    0 11.7  -23.1  0  11.7  23.1  0  11.7
      -11.55 20.0 11.7  -11.5 -20.0 11.7
           11.55 20.0 11.7   11.5 -20.0 11.7

```

Example Problem 7-3.

Example 7-3, 3-D (3x2x2) Lattice

C Cell Cards

```

1 1 9.9270e-2      -1 5 -6      u=1      imp:n=1
2 0                -1 6 -7      u=1      imp:n=1
3 2 8.6360e-2      -2 -4 #1 #2 u=1      imp:n=1
4 0                2:4        u=1      imp:n=1
5 0      -8 9 -10 11 -16 3 lat=1 u=2 fill=1 imp:n=1
6 0      9 -12 11 -14 18 -16      fill=2 imp:n=1
7 0      -9:12:-11:14:-18:16      imp:n=0

```

C Solution Cylinder Surface Cards

```

1 cz 12.49 $ Inner cylinder
2 cz 12.79 $ Outer SS cylinder
4 pz 102.7 $ Top of SS tank
5 pz 0.0 $ Bottom of Solution
6 pz 39.24 $ Top of Solution
7 pz 101.7 $ Top of void above soln.

```

C Beginning of Lattice Surfaces

```

8 px 17.79
9 px -17.79
10 py 17.79
11 py -17.79

```

C Window Surfaces

```

3 pz -1.0
12 px 88.95
14 py 53.37

```

C Surfaces 16 and 18 bound the lattice in the z direction

```

16 pz 112.7 $ Top of lattice cell
18 pz -114.7 $ Bottom of lattice cell

```

C Data Cards

C Material Cards

```

m1 1001.62c 6.0070-2 8016.62c 3.6540-2
    7014.62c 2.3699-3
    94239.66c 2.7682-4 94240.66c 1.2214-5
    94241.66c 8.3390-7 94242.666c 4.5800-8
mt1 lwtr.60t
m2 24050.62c 7.195-4 24052.62c 1.38589-2
    24053.62c 1.5713-3 24054.62c 3.903-4
    26056.62c 3.704-3 26056.62c 5.80869-2
    26057.62c 1.342-3 26058.62c 1.773-4
    28058.62c 4.432-3 28060.62c 1.7069-3
    28061.62c 7.42-5 28062.62c 2.363-4
    28064.62c 6.05-5

```

C Criticality Control Cards

kcode 5000 1.0 50 250

```

ksrc 0 0 19.62 35.58 0 19.62 71.16 0 19.62
      0 35.58 19.92 35.58 35.58 19.62 71.16 35.58 19.62

```

C These source points are place in the added cylinders

```

0 0 -94.08 35.58 0 -94.08 71.16 0 -94.08
0 35.58 -94.08 35.58 35.58 -94.08 71.16 35.58 -94.08

```

Example Problem 7-9.

Example 7-9, 3-D Lattice with one water element.

C Cell Cards

```

1 1 9.9270e-2      -1 5 -6      u=1      imp:n=1
2 0                -1 6 -7      u=1      imp:n=1
3 2 8.6360e-2      -2 -4 #1 #2 u=1      imp:n=1
4 0                2:4        u=1      imp:n=1
5 0      -8 9 -10 11 -16 3 lat=1 u=2 fill=0:2 0:1 -1:0
                                1 1 1 1 3 1
                                1 1 1 1 1 1
                                imp:n=1
6 0      13 -12 15 -14 18 -17      fill=2 imp:n=1
7 0      -13:12:-15:14:-18:17      imp:n=0
11 like 1 but mat=3 rho=-1.0      u=3      imp:n=1
12 like 2 but                        u=3      imp:n=1
13 like 3 but                        u=3      imp:n=1
14 like 4 but                        u=3      imp:n=1

```

C Solution Cylinder Surface Cards

```

1 cz 12.49 $ Inner cylinder
2 cz 12.79 $ Outer SS cylinder
4 pz 102.7 $ Top of SS tank
5 pz 0.0 $ Bottmon of Solution
6 pz 39.24 $ Top of Solution
7 pz 101.7 $ Top of void above soln.

```

C Beginning of Lattice Surfaces

```

8 px 17.79
9 px -17.79
10 py 17.79
11 py -17.79

```

C Window Surfaces

```

3 pz -1.0
12 px 88.949
13 px -17.789
14 py 53.369
15 py -17.789
16 pz 112.7 $ Top of lattice cell
C Surfaces 17 and 18 bound the lattice in the z direction
17 pz 102.69
18 pz -114.699

```

C Data Cards

C Material Cards

```

m1 1001.62c 6.0070-2 8016.62c 3.6540-2 7014.62c 2.3699-3
    94239.66c 2.7682-4 94240.66c 1.2214-5 94241.66c 8.3390-7
    94242.666c 4.5800-8
mt1 lwtr.60t
m2 24050.62c 7.195-4 24052.62c 1.38589-2 24053.62c 1.5713-3
    24054.62c 3.903-4
    26056.62c 3.704-3 26056.62c 5.80869-2 26057.62c 1.342-3
    26058.62c 1.773-4
    28058.62c 4.432-3 28060.62c 1.7069-3 28061.62c 7.42-5
    28062.62c 2.363-4 28064.62c 6.05-5
m3 1001.62c 2 8016.62c 1
mt3 lwtr.60t

```

MCNP Criticality Primer II

C Criticality Control Cards

kcode 5000 1.0 50 250

ksrc 0 0 19.62 35.58 0 19.62 71.16 0 19.62
0 35.58 19.92 35.58 35.58 19.62 71.16 35.58 19.62

C These source points are place in the added cylinders

0 0 -94.08 35.58 0 -94.08 71.16 0 -94.08
0 35.58 -94.08 35.58 35.58 -94.08 71.16 35.58 -94.08

Example Problem 7-10.

Example 7-10, 3-D (3x2x2) Lattice with SDEF card.

C Cell Cards

```

1 1 9.9270e-2      -1 5 -6      u=1      imp:n=1
2 0                -1 6 -7      u=1      imp:n=1
3 2 8.6360e-2      -2 -4 #1 #2 u=1      imp:n=1
4 0                2:4          u=1      imp:n=1
5 0      -8 9 -10 11 -16 3 lat=1 u=2 fill=1 imp:n=1
6 0      9 -12 11 -14 18 -16      fill=2 imp:n=1
7 0      -9:12:-11:14:-18:16      imp:n=0

```

C Solution Cylinder Surface Cards

```

1 cz 12.49 $ Inner cylinder
2 cz 12.79 $ Outer SS cylinder
4 pz 102.7 $ Top of SS tank
5 pz 0.0 $ Bottom of Solution
6 pz 39.24 $ Top of Solution
7 pz 101.7 $ Top of void above soln.

```

C Beginning of Lattice Surfaces

```

8 px 17.79
9 px -17.79
10 py 17.79
11 py -17.79

```

C Window Surfaces

```

3 pz -1.0
12 px 88.95
14 py 53.37

```

C Surfaces 16 and 18 bound the lattice in the z direction

```

16 pz 112.7 $ Top of lattice cell
18 pz -114.7 $ Bottom of lattice cell

```

C Data Cards

C Material Cards

```

m1 1001.62c 6.0070-2 8016.62c 3.6540-2
    7014.62c 2.3699-3
    94239.66c 2.7682-4 94240.66c 1.2214-5
    94241.66c 8.3390-7 94242.666c 4.5800-8
mt1 lwtr.60t
m2 24050.62c 7.195-4 24052.62c 1.38589-2
    24053.62c 1.5713-3 24054.62c 3.903-4
    26056.62c 3.704-3 26056.62c 5.80869-2
    26057.62c 1.342-3 26058.62c 1.773-4
    28058.62c 4.432-3 28060.62c 1.7069-3
    28061.62c 7.42-5 28062.62c 2.363-4
    28064.62c 6.05-5

```

C Criticality Control Cards

kcode 5000 1.0 50 250

sdef cel=d1 pos=0 0 19.62

```

sil L (1<5[0 0 -1]<6) (1<5[1 0 -1]<6) (1<5[2 0 -1]<6)
      (1<5[0 1 -1]<6) (1<5[2 1 -1]<6)
      (1<5[0 0 0]<6) (1<5[1 0 0]<6) (1<5[2 0 0]<6)
      (1<5[0 1 0]<6) (1<5[1 1 0]<6) (1<5[2 1 0]<6)

```

```

spl 1 1 1 1 1 1 1 1 1 1 1

```

Appendix I: Overview of the MCNP Visual Editor Computer

L.L. Carter and R.A. Schwarz

Background

The Monte Carlo N-Particle (MCNP) Visual Editor (References 1-9) was developed to help users of the MCNP code view and create MCNP input files. Work on the Visual Editor started around 1992. Starting with Version 5 of MCNP, the Visual Editor is included with the release of the MCNP package.

The Visual Editor is a graphical interface written in C++ that is linked directly to the MCNP Fortran code. Thus the Visual Editor contains all of MCNP inside the executable. When running the Visual Editor, it is not using the MCNP you have installed on your system but is using the MCNP internally compiled into the code.

Additional information on the Visual Editor can be found in the references, especially the manual supplied with MCNP Version 5 (Reference 8).

Display Capabilities

The Visual Editor provides a graphical interface for viewing the geometry, using the basic plotting capabilities within MCNP. This allows the user to change the view by selecting the origin, extent and basis and to show cell labels. The graphical user interface also incorporates the tally plotting features of MCNP contained in the MCPLOT package. This will allow the user to plot tally and cross section data.

The Visual Editor includes some advanced visualization options including a 3D ray tracing option, a 3D radiography option, and the ability to project source points and collision points onto the plot plane and also source generation points for a KCODE calculation. For these advanced options the Visual Editor is running the internal version of MCNP, this means the input file must be a valid input file that does not produce any fatal errors.

The Visual Editor also has an input window that will show the complete contents of the input file. If the user changes the input by hand and then chooses the "Save - Update" option in the input window menu the plot views will be updated to show the changes.

Creation Capabilities

Along with the display capabilities outlined above, the Visual Editor provides a number of different aids for creating an MCNP geometry. The Visual Editor allows the user to create surfaces, which show up as infinite surfaces in the plot window. The user can then create cells from these infinite surfaces, by dragging across the surfaces that bound the cell and then selecting the inside region of the cell to get the proper sense for the surfaces. Additional aids exist for creating and editing rectangular and hex lattices. The Visual Editor also supports the use of fills and universes.

The Visual Editor supports all data cards and allows the enhanced creation and modification of materials, transformations and importances.

For the creation of materials, the Visual Editor reads the xsdir file for the MCNP set up on the computer to determine the set of isotopes available for creating materials. The Visual Editor then allows the user to select the isotopes that make up the material and specify the mass or atom fractions to create a new material. Materials can be store in a material library so that any input file that is read into the Visual Editor can access them.

For importances, the user can set the importance for each cell by clicking on the cell in the plot window with the mouse. Additionally the user can drag the mouse across a number of cells and set the importance in all the cells that have been dragged across. The importance can be set to a specific value or it can be set to increase by a user specified factor for each cell in the drag to set the importance to increase in a uniform fashion.

Installation Notes

With release 5 the Visual Editor is only available on Windows platforms. For most applications, the Visual Editor executable can be used as distributed.

If you want to have access to the material libraries, you need to create a “vised.defaults” file indicating the location of the material library files.

The size of the fonts used by the windows are fixed and can not be changed. The font used is called “small fonts”. If the Visual Editor windows appear too large for your screen, it is recommended that you increase your screen resolution. The ideal screen resolution is 1280x1024.

The development of the Windows Visual Editor is done on a Windows 2000 platform. For best performance, it is recommended that users run the Visual Editor in Windows 2000 or Windows XP. Table 1 below lists the different operating systems and what is

known about its compatibility with the Visual Editor. If an operating system is not listed, than the code has not been tested on that platform and its functionality is not known.

Table 1. Operating System Compatibility.

Operating System	Compatibility
Windows 2000	Most compatible, this is the Visual Editor development platform.
Windows XP	Very compatible with 2000 version and should be just as stable.
Windows NT	Somewhat compatible with 2000, should still be fairly stable.
Windows 98	Somewhat unstable, not recommended.
Windows 95	Very unstable, not recommended.

References

1. R. A. Schwarz, L. L. Carter, and N. Shrivastava, "Creation of MCNP Input Files With a Visual Editor," *Proceedings of the 8th International Conference on Radiation Shielding* Arlington, Texas, April 24-27, 1994, pp 454-459, American Nuclear Society, La Grange Park, Illinois(1994).
2. L.L. Carter, R.A. Schwarz, "Visual Creation of Lattice Geometries for MCNP Criticality Calculations," *Transactions of the American Nuclear Society*, **77**, 223 American Nuclear Society, La Grange Park, Illinois (1997).
3. R.A. Schwarz, L.L. Carter, "Visual Editor to Create and Display MCNP Input Files," *Trans. Amer. Nucl. Soc.*, **77**, 311-312 American Nuclear Society, La Grange Park, Illinois (1997).
4. R.A. Schwarz, L.L. Carter, K.E. Hillesland, V.E. Roetman, "Advanced MCNP Input File Creation Using the Visual Editor," *Proc. Am. Nucl. Soc. Topical, Technologies for the New Century*, **2**, 317-324, April, 1998, Nashville TN.
5. L.L. Carter, R.A. Schwarz, "The Visual Creation and Display of MCNP Geometries and Lattices for Criticality Problems," *Trans. Amer. Nucl. Soc.*, American Nuclear Society, La Grange Park, Illinois (1999).
6. R.A. Schwarz, L.L. Carter, W Brown, "Particle Track Visualization Using the MCNP Visual Editor," *Proc. Am. Nucl. Soc. Topical Radiation Protection for Our National Priorities Medicine, the Environment and, the Legacy*, 324-331, 2000, Spokane, Washington.
7. R.A. Schwarz, L.L. Carter, "Current Status Of the MCNP Visual Editor," 12th Biennial RPSD Topical Meeting, April 14-18, 2002, Santa Fe, New Mexico.
8. R.A. Schwarz, L.L. Carter, "MCNP Visual Editor Computer Code Manual," included in MCNP 5 release, 2003.
9. A.L. Schwarz, R.A. Schwarz, L.L. Carter, "3D Plotting Capabilities in the Visual Editor for Release 5 of MCNP," *Nuclear Mathematical and Computational Sciences: A Century in Review, A Century Anew*, April 6-11, 2003 on CD-ROM, American Nuclear Society, La Grange Park, Illinois (2003).