

Oil Spill Response in Fast Currents A Field Guide

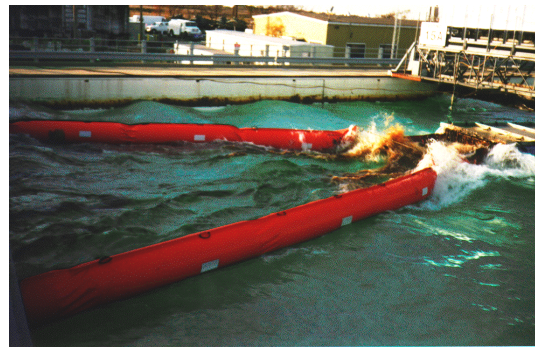

**U.S. COAST GUARD
RESEARCH & DEVELOPMENT CENTER**

U.S. Coast Guard Research and Development Center
1082 Shennecossett Road, Groton, CT 06340-6096

Report No. CG-D-01-02

**Oil Spill Response in Fast Currents
A Field Guide**



**FINAL REPORT
OCTOBER 2001**



This document is available to the U.S. public through the
National Technical Information Service, Springfield, VA 22161

Prepared for:

U.S. Department of Transportation
United States Coast Guard
Marine Safety and Environmental Protection (G-M)
Washington, DC 20593-0001

N O T I C E

This document is disseminated under the sponsorship of the Department of Transportation in the interest of information exchange. The United States Government assumes no liability for its contents or use thereof.

The United States Government does not endorse products or manufacturers. Trade or manufacturers' names appear herein solely because they are considered essential to the object of this report.

This report does not constitute a standard, specification, or regulation.



Marc B. Mandler, Ph.D.
Technical Director
United States Coast Guard
Research & Development Center
1082 Shennecossett Road
Groton, CT 06340-6096

1. Report No. CG-D-01-02		2. Government Accession Number		3. Recipient's Catalog No.	
4. Title and Subtitle Oil Spill Response in Fast Currents – A Field Guide				5. Report Date October 2001	
				6. Performing Organization Code Project No. 4001/4120.12	
7. Author(s) Kurt Hansen, Thomas J. Coe				8. Performing Organization Report No. R&DC 450	
9. Performing Organization Name and Address U.S. Coast Guard Research and Development Center 1082 Shennecossett Road Groton, CT 06340-6096				10. Work Unit No. (TR AIS)	
				11. Contract or Grant No.	
12. Sponsoring Organization Name and Address U.S. Department of Transportation U.S. Coast Guard Marine Safety and Environmental Protection Washington, DC 20593-0001				13. Type of Report & Period Covered Final	
				14. Sponsoring Agency Code Commandant (G-MOR) U.S. Coast Guard Headquarters Washington, DC 20593-0001	
15. Supplementary Notes The R&D Center's technical point of contact is Mr. Kurt Hansen, 860-441-2865, email: khansen@rdc.uscg.mil.					
16. Abstract (MAXIMUM 200 WORDS) From 1992 to 1996, over 58 percent of oil spills larger than 100 gallons have occurred in waters that routinely exceed one knot. Efforts to quickly deploy effective fast-water spill response have been hampered by the lack of technology and adequate training. The objective of this guide is to serve as a training aid and a field manual to increase the effectiveness of fast-water responses. It was developed with the cooperation of multiple government agencies, U.S. Coast Guard units and commercial spill response firms. This document starts with a decision guide to determine what techniques can be used in various spill response scenarios. Additional details are provided for hydrodynamic issues, individual tactics, fast-water skimmers and support equipment such as boats and anchors. The appendices provide additional background information needed to make decisions during a response in fast-water conditions. This guide is designed to be useful for responders as well as those who monitor responses. Whenever possible, figures are accompanied by pictures to provide a full explanation of each tactic or methodology.					
17. Key Words fast-water response skimmer booms response oil spill training			18. Distribution Statement This document is available to the U.S. public through the National Technical Information Service, Springfield, VA 22161		
19. Security Class (This Report) UNCLASSIFIED		20. Security Class (This Page) UNCLASSIFIED		21. No of Pages 121	22. Price

Form DOT F 1700.7 (8/72) Reproduction of form and completed page is authorized.

ACKNOWLEDGEMENTS

The following individuals and organizations should be acknowledged for their contributions in making this guide possible by providing information or participating in the Working Group:

LCDR Robert Loesch
USCG Headquarters (G-SEC)
Washington, DC

CPO Chris Weiller
USCG Marine Safety Office
Wilmington, NC

Mr. Dennis McCarthy
Clean Harbors Cooperative
Linden, NJ

Mr. Mike Popa
Marine Pollution Control
Detroit, MI

Mr. John J Dec
USCG District 1
Boston, MA

Mr. Tom Rayburn
Great Lakes Commission
Ann Arbor, MI

Mr. Ken Bitting
USCG R&D Center
Groton, CT

USCG Atlantic Strike Team
Fort Dix, NJ

CWOP Jim Crouse
USCG Pacific Strike Team
Novato, CA

CDR Mike Drieu
USCG District 8
New Orleans, LA

Mr. Scott Knutson
USCG District 13
Seattle, WA

CPO Timothy Adams
USCG Gulf Strike Team
Mobile, AL

Carl Oskins
DOWCAR Environmental Management
Taos, NM

CDR Steve Garrity
USCG Marine Safety Office
Detroit, MI

CDR Chris Doane
USCG District 5
Portsmouth, VA

Mr. Ross Powers
U.S. EPA
Grosse Ile, MI

LT Tarik Williams
USCG Headquarters (G-MOR)
Washington, DC

LCDR Mike Long
USCG Marine Safety Office
New Orleans, LA

LCDR Roger Laferriere
USCG Marine Safety Office
Toledo, OH

Special thanks to Mr. Tom Coe of CSC Marine who wrote the initial guide in 1999 and was responsible for many of the figures. Also special thanks to Dennis McCarthy and Carl Oskins for many of the photographs.

ACKNOWLEDGEMENTS	iv
CHAPTER 1. INTRODUCTION	1
1.1 Purpose	1
1.2 Objective	1
1.3 Background	1
1.4 Threat	1
1.5 Organization and Use of the Guide	2
CHAPTER 2. DECISION GUIDE	3
2.0 General Guidelines	3
2.1 Decision Steps for Selecting Fast Water Strategies	3
CHAPTER 3. HYDRODYNAMIC CONSIDERATIONS	7
3.1 Reading Currents and Flow Patterns	7
3.2 Natural Collection Sites	7
3.3 Estimating Current and Deflection Angles	7
3.4 Forces on Boom and Rigging	9
3.4.1 Current Drag Forces on Boom	9
CHAPTER 4. SCENARIOS & TACTICS	11
4.1 Rivers/Canals	11
4.2 Inland Rivers (no tides)	13
4.2.1 Diversion Booming	13
4.2.1.1 Double or Parallel Booming	16
4.2.2 Cascade Diversion Booming	17
4.2.3 Chevron Booming	18
4.2.3.1 Closed Chevron	18
4.2.3.2 Open Chevron	18
4.2.4 Encircle and Divert	19
4.3 Rivers/Canals (Tidal)	21
4.3.1 Tidal Seal Booms	23
4.3.2 Other Techniques	24
4.4 Small Streams/Creeks/Culverts	25
4.5 Coastal Areas	29
4.5.1 Single Diversion Boom	29
4.5.2 Cascade Boom	31
4.5.3 Exclusion Booming	32
4.5.4 Other Techniques	33
4.6 Harbors/Bays	34
4.7 Breachways and Harbor Entrances	34
4.7.1 Single Diversion	35
4.7.2 Cascade Systems	35
4.7.3 Blocking	36
CHAPTER 5. BOOMING TECHNIQUES	37
5.1 Cascade Booming DOWCAR Technique	37
5.2 Overlapping J-Shape Booming	38
5.3 Continuous Boom	38
5.3.1 Trans Mountain Pipeline Tactic	39
5.4 Multiple Anchors	40
5.5 Boom Deflectors	41
5.6 Boom Vane	42
5.7 PROSCARAC River Boom Deployment Scheme (PROSCARAC, 1992)	44

CHAPTER 6. SKIMMING TECHNIQUES.....	46
6.1 Fast Water Skimmers.....	46
6.1.1 V-shape Boom with Attached In-line Skimmer.....	46
6.1.2 V-shape Boom with Tapered Channel Separator.....	47
6.1.3 Wide-Mouth V-Shape Boom.....	49
6.1.4 Inclined Plane.....	51
6.1.5 Rope Mop Zero Relative Velocity (ZRV).....	53
6.1.6 Expansion Weir.....	54
6.1.7 Circulation Weir.....	54
6.1.8 Recovery Channel with Conveyor Brush.....	56
6.1.9 Lifting Filter Belt.....	57
CHAPTER 7. SPECIAL CONDITIONS/ALTERNATE TECHNIQUES.....	58
7.1 Oil Under Sheet Ice.....	58
7.1.1 Trenching Ice.....	58
7.2 Oil in Broken Ice.....	59
7.3 Sorbent Applications.....	59
7.4 Alternative Methods of Containment or Exclusion.....	60
7.4.1 Pneumatic Boom.....	60
7.4.2 Water Jet.....	61
7.5 Other Flow Diversion Techniques/Issues.....	63
7.5.1 Moored Vessels and Barges.....	63
7.5.2 Ship Propeller Wash.....	64
7.5.3 Log Booms.....	64
7.6 Flow Diverters.....	64
7.7 Debris.....	66
CHAPTER 8. SUPPORT EQUIPMENT.....	67
8.1 Mooring Systems.....	67
8.1.1 Anchoring.....	67
8.1.2 Shoreline.....	71
8.1.3 Mooring Techniques.....	73
8.2 Boats and Power Selection.....	74
8.3 Temporary Oil Storage.....	76
8.3.1 Floating Oil Storage.....	76
8.3.2 Shore-Side Storage.....	76
CHAPTER 9. SPECIALIZED METHODS AND TECHNIQUES.....	78
9.1 Equipment and Practices Adapted to Fast-Water Response.....	78
9.2 Computer Support.....	80
APPENDICES.....	A-1
APPENDIX A. Table and Worksheet for Fast Water Response.....	A-1
APPENDIX B. Definitions.....	B-1
APPENDIX C. Conversion Tables.....	C-1
APPENDIX D. Processes Accelerated in Swift Current.....	D-1
APPENDIX E. Cascade Tactic for Booming a River.....	E-1
APPENDIX F. Current Estimation and Mooring Line Issues.....	F-1
Current Calculations.....	F-1
Mooring Angle Considerations.....	F-2
Symmetrical Boom.....	F-2
APPENDIX G. Diversion Boom and Mooring Line Force Worksheet.....	G-1
APPENDIX H. Vector Analysis for Currents and Wind.....	H-1
APPENDIX I. Heavy Oils.....	I-1

APPENDIX J. Culvert Calculations	J-1
APPENDIX K. Safety	K-1
APPENDIX L. Technology Assessment	L-1
APPENDIX M. Notes	M-1

REFERENCES	Reference-1
INTERNET REFERENCES	Reference-4

FIGURES

Figure 3-1. Maximum boom deployment angles required to prevent oil entrainment	8
Figure 3-2. Angle measurement	8
Figure 3-3. Boom submergence failure in swift current	9
Figure 4-1. Oil collection	11
Figure 4-2. Typical river flow patterns and boom deployments	12
Figure 4-3. Oil collection with diversion booming to shore	13
Figure 4-4. Exclusion booming around sensitive areas	14
Figure 4-5. Exclusion Booming of Inlet	15
Figure 4-6. Exclusion booming of side stream	15
Figure 4-7. Two parallel diversion booms and collection pit	16
Figure 4-8. Cascade diversion booming	17
Figure 4-9. Cascade diversion booms deployed	17
Figure 4-10. Chevron booming	18
Figure 4-11. Closed and open Chevron booming tactics	19
Figure 4-12. Procedure used by one boat to capture oil and divert it to slower waters	19
Figure 4-13. Sea anchor and boom configuration for one boat capture	20
Figure 4-14. Use of two boats for oil spill capture	20
Figure 4-15. Double booming arrangement in tidal river	21
Figure 4-16. Boom at high tide	22
Figure 4-17. Boom at low tide	22
Figure 4-18. Shore seal boom protects shallow inlets and seals	23
Figure 4-19. Shore seal boom during tidal fluctuation	23
Figure 4-20. Deployed tidal boom	24
Figure 4-21. Earth underflow dam	25
Figure 4-22. Sandbag underflow dam	25
Figure 4-23. Underflow dam with debris boom	26
Figure 4-24. Wooden underflow dam	26
Figure 4-25. Underflow dam with sorbent material	26
Figure 4-26. Overflow dam	27
Figure 4-27. Sorbent barrier	27
Figure 4-28. Sorbent barrier	28
Figure 4-29. Hay filter barrier	28
Figure 4-30. Diversion booming	30
Figure 4-31. Correct booming near shore	30
Figure 4-32. Pockets forming as result of incorrect booming	31
Figure 4-33. Cascaded deflection booms	31
Figure 4-34. Cascading booms in open area	32
Figure 4-35. Protecting inlets with exclusion booming	32
Figure 4-36. Exclusion booming	33
Figure 4-37. Exclusion booming	33
Figure 4-38. Booming in beachway	34
Figure 4-39. Booming harbor or tidal inlet	35
Figure 4-40. Barrier Island inlet spill response strategy	35
Figure 4-41. Cascade boom in inlet	36

Figure 5-1.	Deploying cascade boom in a narrow river	37
Figure 5-2.	Cascade J-shape deflection booming requires more overlap	38
Figure 5-3.	Trans mountain pipeline tactic	39
Figure 5-4.	Multiple anchors on sections of boom	40
Figure 5-5.	Boom deflector	41
Figure 5-6.	Boom deflectors push the boom into the current	41
Figure 5-7.	Boom deflectors can be used without multiple anchors	42
Figure 5-8.	Boom vane is quickly assembled	42
Figure 5-9.	Boom vane deploys and retrieves deflection boom from shore to allow vessel passage	43
Figure 5-10.	Boom vane deployed in Martha's Vineyard	43
Figure 5-11.	River boom deployment schematic	45
Figure 6-1.	In-line skimmer attached to V-shape boom in VOSS configuration	46
Figure 6-2.	USCG VOSS system	47
Figure 6-3.	The NOFI Vee Sweep™ with tapered channel separator	48
Figure 6-4.	NOFI Current Buster™ in Ohmsett tank	48
Figure 6-5.	Wide-mouth V-shape boom with attached skimmer	49
Figure 6-6.	Boom deflectors and wide-mouth V-shape sweep systems	50
Figure 6-7.	Inclined plane skimmers (static and dynamic)	51
Figure 6-8.	28-foot HIB static inclined plane skimmer	52
Figure 6-9.	Fast-Sweep™ boom with USCG high-speed DIP skimmer	52
Figure 6-10.	Typical rope mop ZRV design	53
Figure 6-11.	Fasflo™ expanding weir skimmer (top and profile view)	54
Figure 6-12.	Blomberg High Speed Circus on a VOSS	55
Figure 6-13.	Blomberg High Speed Circus shelters oil from the current	55
Figure 6-14.	Lori Brush Skimmer in dedicated skimming boat	56
Figure 6-15.	Filter Belt™ skimmer design	57
Figure 7-1.	Slots cut in ice for oil recovery	58
Figure 7-2.	Cross-section of ice slots	59
Figure 7-3.	Boom deployed in ice slot	59
Figure 7-4.	Sheet absorbents at 3.5 knots	60
Figure 7-5.	Balance of forces between a bubble plume and oil layer	60
Figure 7-6.	Air flow needed for specific currents	61
Figure 7-7.	Horizontal water jet stops oil in current	62
Figure 7-8.	Plunging water jet creates counter current to stop oil	62
Figure 7-9.	Air jet induces water current to stop oil	63
Figure 7-10.	Barges deployed on Mississippi River	64
Figure 7-11.	Diverters conceptual deployment	65
Figure 7-12.	Prototype diverters	65
Figure 7-13.	Flow diverters at Ohmsett	66
Figure 8-1.	Typical boom mooring configuration	67
Figure 8-2.	Anchor system	68
Figure 8-3.	Boom guide	68
Figure 8-4.	Standard anchors	69
Figure 8-5.	Rake anchor	70
Figure 8-6.	Mooring boom with multiple anchors	71
Figure 8-7.	Typical shoreline boom mooring system using posts	72
Figure 8-8.	Multiple anchors used to moor boom	72
Figure 8-9.	Multiple booms being anchored	72
Figure 8-10.	Boom faked out in zigzag with anchor attached	73
Figure 8-11.	Boom deployment approach	74
Figure 8-12.	A 12-inch draft boom is too much for this boat and motor	75
Figure 8-13.	Sea slug barge floating bladders	77
Figure 9-1.	Ascenders used in gripping mooring lines	79
Figure 9-2.	Ascenders in use for tightening lines	79
Figure D-1.	Effects of fast water on oil spill processes	D-1
Figure E-1.	Sequence of DOWCAR system deployment	E-3

Figure E-2.	Photographs of boom deployment	E-4
Figure E-3.	Ferry system deployed	E-4
Figure F-1.	Projected boom sweep	F-2
Figure G-1.	Example	G-2
Figure I-1.	Plume containment	I-2
Figure I-2.	Bottom containment	I-2
Figure I-3.	Trench containment	I-3

TABLES

Table 1-1.	Quick reference table	2
Table 2-1.	Fast current scenarios and tactics	4
Table 2-1.	Fast current scenarios and tactics (continued)	5
Table 2-2.	Factors and effects for oil spill trajectory	6
Table 3-1.	Current drag force on one-foot boom profile to current	9
Table 8-1.	Anchor holding power as a multiple of dry weight for 100 pounds	70
Table 8-2.	Nominal breaking strengths (pounds)	71
Table 8-3.	Pounds of force per foot of boom	75
Table C-1.	Conversion tables	C-1
Table D-1.	Wind drift of oil	D-1
Table F-1.	Current chip log and maximum boom deflection angle	F-1
Table F-2.	Mooring line loads	F-2
Table G-1.	Mooring line force worksheet	G-1
Table G-2.	Projected deflection boom width to the current	G-2
Table G-3.	Current drag force on one-foot boom profile to current	G-3
Table G-4.	Tension force multiplier for boom catenary angles	G-3
Table I-1.	Guide to heavy oil response	I-1
Table J-1.	Channel parameters	J-1
Table J-2.	Segments of a circle given h/D	J-2
Table L-1.	Technology assessment of strategies and equipment	L-3

CHAPTER 1. INTRODUCTION

1.1 Purpose

The purpose of this guide is to provide advice, strategies and tactics to spill planners, responders and monitors/field observers to improve spill response in swift currents greater than one knot. The guide is largely a consolidation of research conducted for the United States Coast Guard concerning technology assessment of fast-water oil spill response in more practical application terms (Coe and Gurr, 1999). Technology and tactics are presented in a practical scheme to show how to improve oil spill response capabilities for currents from one to five knots.

1.2 Objective

The objective of this guide is to provide specific methodologies and techniques that have shown effective in fast water conditions. This guide is intended for personnel who have previous oil spill response training with hands-on experience; however, it does not cover all of the topics needed for a complete spill response. The recommendations in this guide should not take the place of procedures in local contingency and safety plans but should be considered when updating these plans.

1.3 Background

Controlling and recovering oil spills in fast moving water above one knot is difficult to accomplish because oil entrains under booms and skimmers in swift currents. Fast water accelerates many spill processes necessitating quicker and more efficient responses compared to stagnant water or slow moving current conditions. The severity of the impact of oil depends on many factors including the properties of the oil itself. Natural conditions such as current speed, turbulence, temperature and wind also influence the behavior of oil in water. Some physical and chemical properties of oil are important to consider when developing a spill response strategy, selecting tactics and choosing the best equipment. Spilled oil properties and processes that affect its behavior are in multiple references and sources on the Internet ([see References](#)). [Appendix D](#) contains a brief description of how processes are affected by fast water.

More experience and skill is needed to successfully complete responses. Timely response efforts are required in order to minimize environmental damage, economic losses and associated cleanup costs. Some containment and control devices slow or divert the surface current and oil without causing entrainment, which allows recovery with most conventional skimmer designs. Specialized fast-water skimmers can also remove oil as it passes by at high speeds. Oil can also be diverted away from sensitive areas or to containment or recovery devices near shore where currents are slower due to bottom frictional effects. In some cases the techniques and equipment presented for fast-water conditions can also be applied successfully as high-speed recovery systems in slow current conditions, thus improving oil recovery rates and coverage factors where advancing systems are used.

1.4 Threat

Annually, sixty-nine percent (645 million tons) of oil is transported on United States waterways where currents routinely exceed one knot (Coe and Gurr, 1999). In addition, thousands of facilities located on the banks of fast-current waterways store millions of gallons of oil, and thousands of oil pipelines traverse fast-water rivers and bays, posing oil spill threats. Between 1992 and 1998, fifty-eight percent of all oil spilled in the United States occurred in fast-current waterways. This figure represents 4.5 million gallons of oil spilled in swift flowing rivers, harbors, bays and coastal areas where conventional boom and skimmers are often ineffective (Coe and Gurr, 1999).

1.5 Organization and Use of the Guide

This guide is organized in a sequence that informs you of the need, concerns, limitations and methods to effectively respond to an oil spill in swift currents. It outlines the specific challenges and provides viable strategies and tactics to combat those problems. Aids are provided to assist with planning and implementing a response. Recommendations are given to help you make informed decisions on all aspects of effectively responding to fast-water oil spills. Table 1-1 is a chart that will connect you directly to the appropriate chapter by clicking on it for the CD version.

Table 1-1. Quick reference table.

CHAPTER 1. INTRODUCTION
CHAPTER 2. DECISION
CHAPTER 3. HYDRODYNAMIC CONSIDERATIONS <ul style="list-style-type: none"> • Estimating currents and boom deflection angles • Selecting the best control points considering flow and topography • Determining forces on boom and the effects of mooring line angles
CHAPTER 4. SCENARIOS & TACTICS
CHAPTER 5. BOOMING TECHNIQUES
CHAPTER 6. SKIMMING TECHNIQUES
CHAPTER 7. SPECIAL CONDITIONS/ALTERNATE TECHNIQUES
CHAPTER 8. SUPPORT EQUIPMENT <ul style="list-style-type: none"> • Mooring Systems and Techniques • Boats & powering considerations and Aircraft • Temporary Oil Storage: Floating & Land
CHAPTER 9. SPECIALIZED METHODS AND TECHNIQUES
APPENDICES <ul style="list-style-type: none"> A. Table and Worksheet for Fast Water Response B. Definitions C. Conversion Tables D. Processes Accelerated in Swift Current E. Cascade Tactic for Booming a River (DOWCAR, 1997) F. Current Estimation and Mooring Line Issues G. Diversion Boom Mooring Line Force Worksheet H. Vector Analysis for Currents and Wind I. Heavy Oils J. Culvert Calculations K. Safety L. Technology Assessment
REFERENCES

CHAPTER 2. DECISION APPROACH

2.0 General Guidelines

This chapter provides a method to decide what techniques or methods are the most appropriate for conditions and operating environments that are encountered. This process should be used to develop effective contingency plans and also during actual spill responses. The tables and lists contained in this chapter have links to other parts of this document.

2.1 Decision Steps for Selecting Fast Water Strategies:

The steps needed to activate a response are contained in this section. Refer to the remainder of the guide for specific use and implementation methods.

1. **Gather information:** Use the list in [Appendix A](#) for reminders. The table and worksheet can be printed out and the information filled in as needed.
2. **Determine Oil Trajectory:** Where is the oil going? Use Area Contingency Plan and/or Environmental Sensitivity Index to identify areas to be protected or where oil can be recovered along the route of the oil trajectory. Determine the time of oil impact on land and identify locations where a protection or collection strategy is warranted. Look for natural collection points.
3. **Identify Potential Tactics:** Use Table 2-1 to select tactics that can be used for each location. Table 2-2 contains a brief description of factors that should be considered. For additional details, refer to other sections of this guide. If multiple tactics are applicable, evaluate with respect to the equipment available in combination with the next step below.
4. **Risk/benefit analysis:** Conduct a human health risk assessment (see example in [Appendix K](#)) and a net environmental benefit analysis for each strategy and alternative at each location.
5. **Choose the final strategy:** Select the option that yields the highest net human health and environmental benefit.
6. **Implement strategy:** Place equipment and personnel into position. Preposition equipment in optimal locations whenever possible.
7. **Monitor and adjust strategy as appropriate.**

Table 2-1. Fast current scenarios and tactics.

Scenario	Amplifying Information	Tactics	Page
Rivers/Canals (Non-Tidal): Depth is greater than typical boom skirt depth May have tidal influence, but current always goes in same direction	Current speed dependent Vessel traffic dependent	Single Diversion Boom <ul style="list-style-type: none"> Current < 2 knots use boom skirt of 12 inches Current > 2 knots use boom skirt 6 inches or less 	13
	Currents over 2 knots	Cascading Diversion Boom <ul style="list-style-type: none"> Use short skirts, shorts boom lengths and sufficient overlap 	17
	Collection areas available on both sides	Chevron Booms <ul style="list-style-type: none"> Open for vessel traffic Closed if no traffic 	18
	Currents less than 2 knots and river is wide	Single Diversion Boom Exclusion Boom for Sensitive Areas Encircle & Divert to Collection Area	13 13 19
	Sufficient room to maneuver	Skimmers for Collection	46
	No Vessels Available	Boom Vane Flow Diverters	42 64
	Special Conditions	Air and Water Jets	61
	Isolated Areas	Sorbents and Pom-Poms	59
Rivers/Canals-(Tidal): Depth is greater than typical boom skirt depth Current reverses direction	Current speed dependent Vessel traffic dependent Special methods needed to compensate for tides	Diversion Boom – need double set <ul style="list-style-type: none"> Current < 2 knots use boom skirt of 12 inches Current > 2 knots use boom skirt 6 inches or less 	21
	Currents over 2 knots	Cascade Boom - may need double set <ul style="list-style-type: none"> Use short skirts, shorts boom lengths and sufficient overlap 	17
	Collection areas available on both sides	Chevron - may need double set <ul style="list-style-type: none"> Open for vessel traffic Closed if no traffic 	18
	Currents less than 2 knots and river is wide	Encircling	19
	Isolated Areas	Sorbents and Pom-Poms	
	Sufficient room to maneuver	Skimmers	46
	No Vessels Available	Boom Vane Flow Diverters	42 64
	Special Conditions	Air and Water Jets	61
Isolated Areas	Sorbents and Pom-Poms	59	
Small streams, creeks, culverts: Depth is less than boom skirt depth	Dependent upon flow rate (see Appendix J)	Single Diversion for volume greater than about 10 cubic feet/second	25
	Block for low volume flow	Sealing <ul style="list-style-type: none"> Fill Dams Weirs 	25
	Design for volume	Overflow/Underflow dams	25
	Low Flow	Sorbents and Pom-Poms	59

Table 2-1. Fast current scenarios and tactics (continued).

Scenario	Amplifying Information	Tactics	Page
Coastal Areas: Near shore wave dependent Includes near shore and straits Various depths Usually tidal		Single Diversion Boom <ul style="list-style-type: none"> Current < 2 knots use boom skirt of 12 inches if no waves 	29
	Currents over 2 knots	Cascade Boom <ul style="list-style-type: none"> Use short boom lengths and sufficient overlap 	31
	Currents less than 2 knots and river is wide	Encircling	19
	Sufficient room to maneuver	Skimmers	46
		VOSS/SORS	46
	Isolated Areas	Sorbents and Pom-Poms	59
Harbors/Bays: Near shore wave dependent Depth is usually greater than typical boom skirt depth	Use river techniques in specific areas Current speed dependent Vessel traffic dependent	Single Diversion Boom <ul style="list-style-type: none"> Current < 2 knots use boom skirt of 12 inches if no waves Current > 2 knots use boom skirt 6 inches or less if no waves 	13
	Currents over 2 knots	Cascade Boom <ul style="list-style-type: none"> Use short skirts, short boom lengths and sufficient overlap 	17
	Currents less than 2 knots and area is large	Encircling	19
	Sufficient room to maneuver	Skimmers	46
	Special Conditions Isolated Areas	Air and Water Jets Sorbents and Pom-Poms	61 59
Breach ways and Harbor Entrances: Various depths Usually tidal	Current speed, vessel traffic and wave dependent	Single Diversion Boom <ul style="list-style-type: none"> Current < 2 knots use boom skirt of 12 inches if no waves Current > 2 knots use boom skirt 6 inches or less if no waves 	35
	Currents over 2 knots	Cascade Boom <ul style="list-style-type: none"> Use short skirts (if no waves), shorts boom lengths and sufficient overlap 	35
	Collection areas available on both sides	Chevron - <ul style="list-style-type: none"> Open for vessel traffic Closed if no traffic 	18
	Block for low volume flow	Sealing <ul style="list-style-type: none"> Fill Dams Weirs 	25
	Design for volume	Overflow/Underflow dams	25
	No Vessels Available	Boom Vane Flow Diverters	42 64
	Isolated Areas	Sorbents and Pom-Poms	59

Table 2-2. Factors and effects for oil spill trajectory.

Factors Influencing Oil Trajectory	Effect
Wind	<ul style="list-style-type: none"> • Increases speed of flow, and determines direction with current vector
Culverts, Eroded cuts, Inlets, Oxbows, Recesses	<ul style="list-style-type: none"> • Changes flow direction • Capillary flow into recessed areas • Good collection points
River bends/curves	<ul style="list-style-type: none"> • Flow outside of bend is faster/deeper • Flow inside of bend is slower/shallower
Tributaries	<ul style="list-style-type: none"> • Increases flow downstream • Decreases flow upstream • Below & above tributaries are good collection points (due to eddies)
Eddies	<ul style="list-style-type: none"> • Good collection points in vicinity of eddy
Islands	<ul style="list-style-type: none"> • Constricts flow, increases speed • Eddies form below islands
Sloughs, Oxbows, Jug handles	<ul style="list-style-type: none"> • Reduces main current flow • Good natural collection points
Obstructions, Dams, Debris barriers	<ul style="list-style-type: none"> • Effects speed & direction of current, depending on configuration

CHAPTER 3. HYDRODYNAMIC CONSIDERATIONS

3.1 Reading Currents and Flow Patterns

Selection of a good location to deploy the oil containment system is dependent upon prior planning and understanding of the currents. Drift studies, oceanographic surveys, river runoff histories, tidal current tables and charts, and computer modeling are all useful tools to understand the flow patterns and to develop strategies. The day of the spill may present different current and circulation patterns or other factors that require accurate field observations. Reading the currents and flow patterns require practice and understanding of the hydrodynamics involved. Several things may be helpful to define these patterns. Selection of a containment area where a lower current exists is desirable. This will allow wider deflection angles and reduce drag forces on the boom.

3.2 Natural Collection Sites

Natural collection sites should be identified and categorized in Area Contingency Plans (ACP) as part of the planning process to select control points for spill response operations. This can be effectively accomplished by surveying the coastline and then conducting an investigation of promising sites by land or water. Viable control points should afford favorable currents, helpful circulation patterns and effective logistics support such as roads, wide-open banks, sufficient water depth for fully loaded vessel and good mooring selections. These sites also collect oiled debris that will complicate the collection and removal process. Cleaning the site before the oil arrives is recommended.

3.3 Estimating Current and Deflection Angles

An accurate determination of current direction and velocity is important in order to select the proper tactic and deploy the equipment correctly. Current meters can be used to measure the velocity, but they are not always practical during a spill response. The current velocity profile can be estimated by observing the incline of buoys, floating debris, and the amount of turbulence around buoys and pilings. Current speed can be calculated by timing the movement of floating debris over a measured distance. The chip log technique only requires floating debris, a tape measure or two buoys spaced a measured distance apart, and a stopwatch (see [Appendix F](#)).

Oil will be lost under a boom when the current exceeds about .75 knots. This value is independent of boom skirt depth. Wind loads are not significant in high-current areas but the loads created by wind-induced currents can affect the equipment performance so the effect of the wind must be included. [Appendices D](#) and [H](#) provide a method for calculating the combined effect of the current and wind-induced flow. This method can also be used to calculate relative velocity for ship motion if a Vessel of Opportunity Skimming System (VOSS) system is used. Once the current is known, the angle for boom deployment can be determined. Oil losses can be minimized if the angle is set at a maximum angle as shown in [Figure 3-1](#) and in [Appendix F](#).

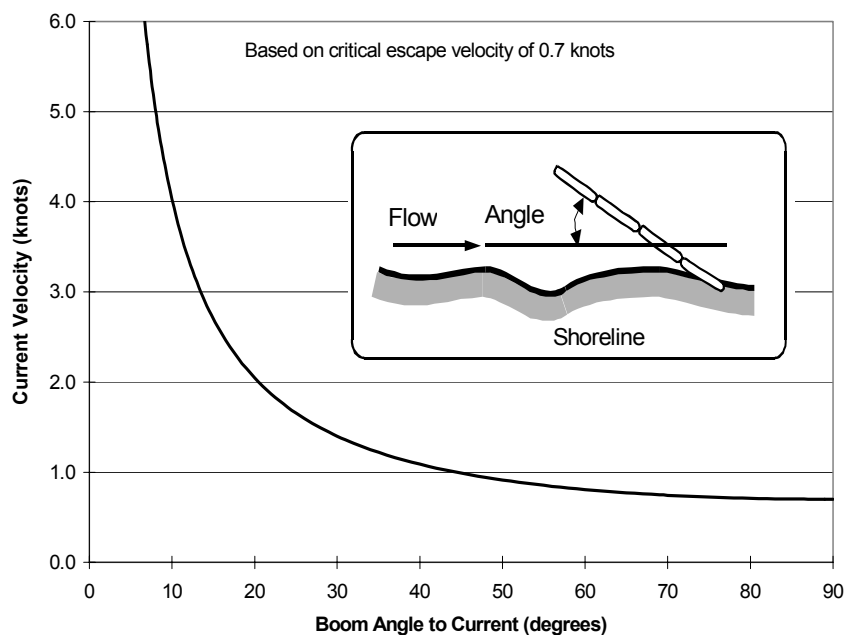

Figure 3-1. Maximum boom deployment angles required to prevent oil entrainment.

To estimate an angle, use the triangle and table below. The length of the sides can be estimated using lengths of boom, line or boat lengths. For example, to get a 14-degree angle, secure the upstream end of the boom about one boat length off the shore, and then move down the shore four boat lengths and secure the other end of the boom. More exact angles can be set using surveying instruments. Another alternative is to determine boom angles at pre-selected booming sites so that decisions do not have to be made during an emergency.

X	ANGLE
1	45.0
2	26.0
3	18.0
4	14.0
5	11.0
6	9.5
7	8.0
8	7.0
10	5.7
20	3.0
30	2.0

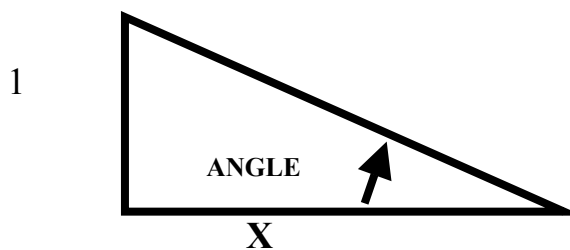

Figure 3-2. Angle measurement.

3.4 Forces on Boom and Rigging

The major force exerted on a boom is caused by the water drag on the skirt. Wave forces can increase the drag by a factor of two or three depending upon the wave height, period and loading dynamics. Wind force is less than current and waves, but it is also a factor. In high current situations, draft is sometimes increased by water piling up on the boom causing some submergence and increased drag forces often resulting in mooring failure, see Figure 3-3. In this situation, the 100-foot section of 4 x 6 diversion boom (4-inch floatation and 6-inch draft) could not take the hydrodynamic load. A replacement section 50-feet long was able to withstand the reduced forces without submerging.



Figure 3-3. Boom submergence failure in swift current.

3.4.1 Current Drag Forces on Boom

The effects of current velocity and boom draft on boom drag force can be seen in Table 3-1. Drag increases with draft in a linear fashion while current increased drag more dramatically, to the square of the velocity. The high values given in Table 3-1 also show why the recommended angles provided in Figure 3-1 are so important.

Table 3-1. Current drag force on one-foot boom profile to current.

Velocity (knots)	Boom Drag Force (pounds)			
	Draft 0.5 Feet	Draft 1.0 Feet	Draft 1.5 Feet	Draft 2.0 Feet
0.5	0.7	1.3	2.0	2.7
1.0	2.7	5.3	8.0	10.7
1.5	6.0	12.0	18.0	24.0
2.0	10.7	21.3	32.0	42.6
2.5	16.7	33.3	50.0	66.6
3.0	24.0	48.0	72.0	95.9
3.5	32.6	65.3	97.9	130.6
4.0	42.6	85.3	127.9	170.6
4.5	54.0	107.9	161.9	215.9
5.0	66.6	133.3	199.9	266.5
5.5	80.6	161.2	241.8	322.5
6.0	95.9	191.9	287.8	383.8
6.5	112.6	225.2	337.8	450.4
7.0	130.6	261.2	391.8	522.3

For a quick approximate load on a boom that is anchored at an angle of between 10 and 30 degrees to the current, use the following formula (Hansen, DeVitis, Potter, Ellis, and Coe, 2001).

$$T = K * A * V^2$$

where: T = tensile force, lb_f
K = constant, lb_f/(ft² x knots²)
A = projected area of the submerged portion of the boom, ft²
V = tow speed, knots

The projected area of the boom was calculated based on the boom draft, and the length of the boom normal to the water current (i.e., the direction of travel):

$$A = d * L * \sin \theta$$

where: A = projected area of the submerged portion of the boom, ft²
d = boom draft, feet
L = boom length, feet (100 ft)
 θ = diversion angle (10°, 20°, 30°)

It is recommended that values of 2 be used for K in calm water and 3-4 when waves are encountered. A detailed method to calculate forces on booms and attachment points is given in [Appendix G](#).

CHAPTER 4. SCENARIOS & TACTICS

Strategies are general plans to be applied to a particular scenario. Tactics are the specific methods and equipment selected to accomplish the strategy for a specific situation. Efforts leading up to this guide included a general evaluation of tactics and methods by the American Society of Testing and Materials, (ASTM) Committee F20 on Hazardous Substances and Oil Spill Response. The results are provided in [Appendix L](#).

4.1 Rivers/Canals

Currents are highest in the deep channels of the river and diminish as depth decreases near shore due to bottom friction effects. Oil will generally follow the higher current flow downriver. It will be distributed much like river debris in areas where slow current, eddies and alternate watercourses exist. Differential surface velocities tend to separate the oil into elongated ribbons and stretch it out over long distances downstream. Changes in water levels (stages) due to runoff and dam releases can dramatically change the currents and flow patterns. Collection sites may have to be moved if significant changes of the river height occur during the spill event. In small to medium size rivers, recovery equipment is generally affixed to the riverbank or structures in the river. The water with the spilled oil is doing the work moving the oil into slower current areas guided by the deflection boom, [Figure 4.1](#).

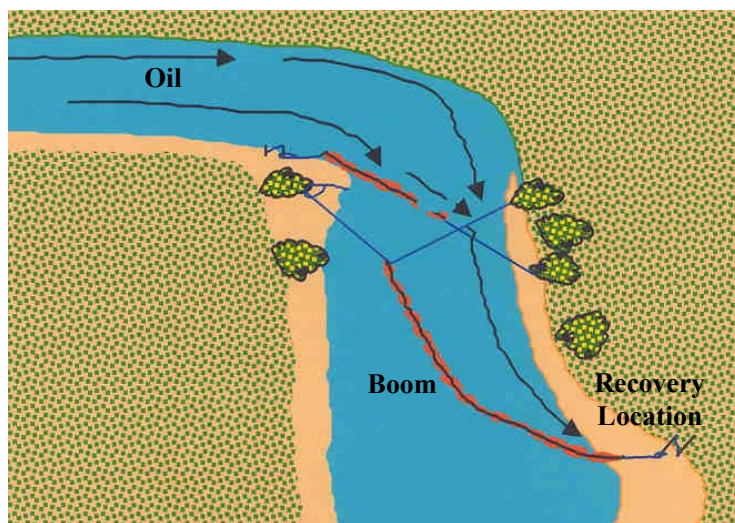

Figure 4-1. Oil collection (DOWCAR, 1997).

In larger rivers, a combination of fixed and self-propelled response equipment is usually required. Make sure that the equipment will not go aground with a full load of oil or debris. The following characteristics of a river affect decisions regarding strategies and tactics:

- **Eroded Cuts** are formed into banks where the flow changes direction. These may be good natural collection pockets if access is available.
- **Flow** of a river tends to form deep fast-flowing channels on the outboard side of the curves in the river. Very often, the banks are steep in these locations while the inboard side is often shallow with sandy banks with slower currents. Always try to deflect the oil to the slow side (the inner bank at a curve) of the river, as shown in [Figure 4-2](#).
- **Tributaries** feed into the main river and often cause the current to increase downstream of the intersection, [Figure 4-2](#). Diversion and containment of oil should be accomplished upstream of the intersection point where currents are lower. There are usually eddies above and below a discharging tributary that may be natural collection points. Low flow tributaries or inlets may be very useful for collection of diverted oil from the main river if they are not sensitive areas.

- **Islands** cause constriction in the river flow, which usually results in higher currents around islands. Oil should be contained and recovered before or after such constriction areas. Back flow and eddies often form on the downstream side of islands, which may facilitate recovery in low current areas, [Figure 4-2](#).
- **Sloughs** are small diversions off the main river that lead back to the river downstream. If the slough widens or deepens, currents usually diminish facilitating oil recovery. In these situations, oil can be diverted into these natural collection areas.
- **Man-made structures** such as piers and marinas tend to trap oil and make recovery much more difficult. Oil should be diverted around such structures. Revetments covered with stone material or concrete mats designed to prevent erosion can make anchoring difficult and if oiled they are difficult to clean. Silt and sand collect behind dikes in eddies and floating oil may collect there. Working near sandbars behind islands and dikes should be done with caution since the bars may be unstable and unable to support weight of people and equipment. Dams and locks can form collection points for oil, but high current flooding conditions often require that they remain open to prevent flooding over river banks and levees.

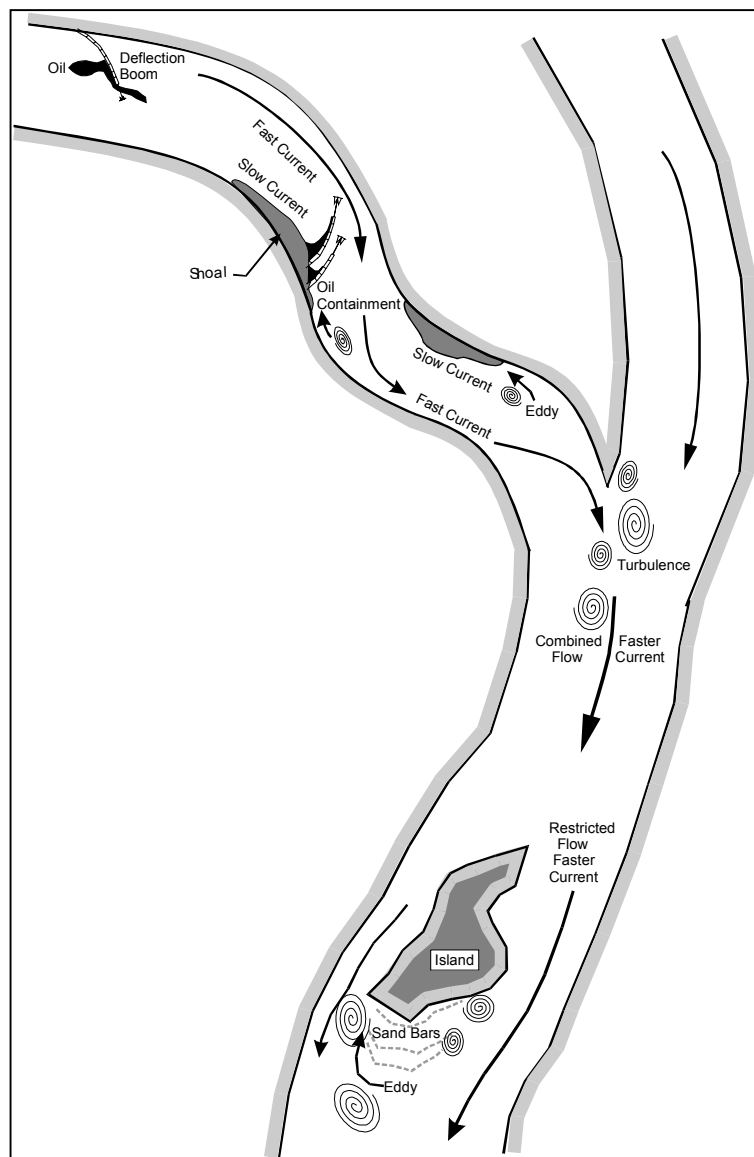

Figure 4-2. Typical river flow patterns and boom deployments.

4.2 Inland Rivers (no tides)

Tactics used for both containment and exclusion are dependent upon the desired effect and the direction the deflection system is deployed. Containment is preferred. Exclusion may protect the sensitive area but the oil is still free to do damage elsewhere. Some tactics are specifically for narrow non-tidal bodies but still can be used on wide rivers and along the coast.

Tides are not a factor on inland rivers above a point that the riverbed slope exceeds the high tide range. This makes response a little more manageable because the entire flow of the surface currents does not change direction in a cyclical manner. There will still be reverse flow on inland rivers in eddies and possibly in some backwater inlets and tributaries depending upon the hydrodynamic forces, wind driven currents and in some cases snow melt. These reverse flows will remain constant during the response unless rain increases the water level or strong winds dramatically shift. Published currents are difficult to find and are not generally accurate as a predictive tool due to the variable water runoff. The United States Geological Survey (USGS) has quite a bit of near real-time river stream flow and stage height data available through the Internet at <http://water.usgs.gov/public/realtime.html>. They also provide the data in graph form along with historical averages. Seasonal trends provide general high current periods. Local knowledge or river cross-sectional area data, however, is required to convert stream flow (cubic feet per second) data to surface velocities for a particular river station.

4.2.1 Diversion Booming

Diversion booming can be used for containment or exclusion. Containment booming moves oil from fast flow areas in the center of the river to calm water in a protected inlet along the bank. This approach allows the use of conventional containment and recovery techniques. If a natural collection point is not available, a sump collection area can be dug out of the bank. The boom can be deployed in a single long section as shown in Figure 4-3 or as multiple booms staggered across a river or harbor. As discussed earlier, the maximum deflection angle must be maintained to prevent oil entrainment. It is better to limit the boom draft for deflection applications. Boom with draft greater than six inches is not recommended for currents above 1.5 knots. For currents of three knots and greater, boom with only a short chain pocket and no more than three inches draft is recommended to maintain shallow deflection angle to the current. The requirements for anchoring will depend upon the situation. Details about anchoring methods are contained in Chapter 8.



Figure 4-3. Oil collection with diversion booming to shore (DOWCAR, 1997).

Boom should be trenched into the bank to prevent oil loss at the shoreline. Plastic sheeting or another boom should be used along the shore to keep the beach clean at the apex. Lightweight durable skimmers and power packs are recommended for easy transport and reliability. Typical skimmers include disk and drum skimmers to reduce water collection. Small weir skimmers, vacuum (VAC) trucks, air conveyor systems or portable VAC units can be used, however, these systems collect more water than oil unless self-adjusting floating skimmer heads are used or the oil is thickened in the pocket before skimming.

Deflection booming is used to keep oil away from water intakes and environmentally sensitive areas as seen in Figures 4-4 through 4-6. Fewer booms may be required than those used for containment, but the oil may be directed to another sensitive area.

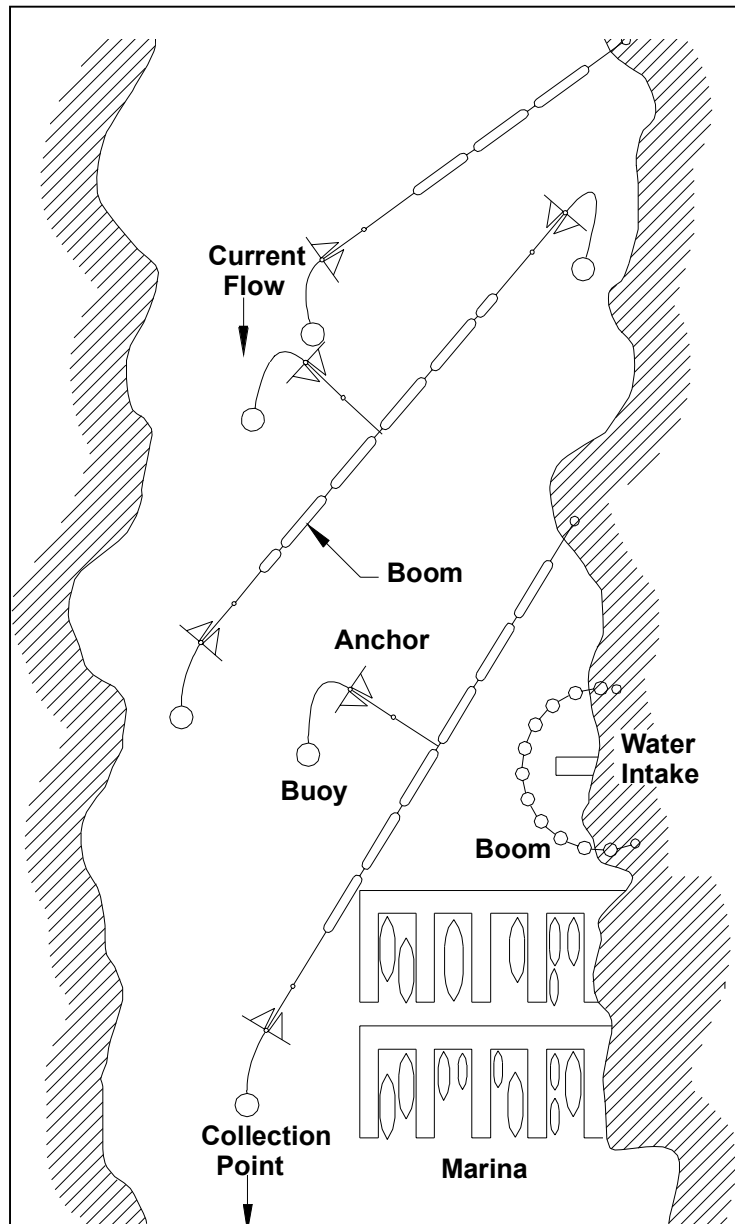

Figure 4-4. Exclusion booming around sensitive areas.

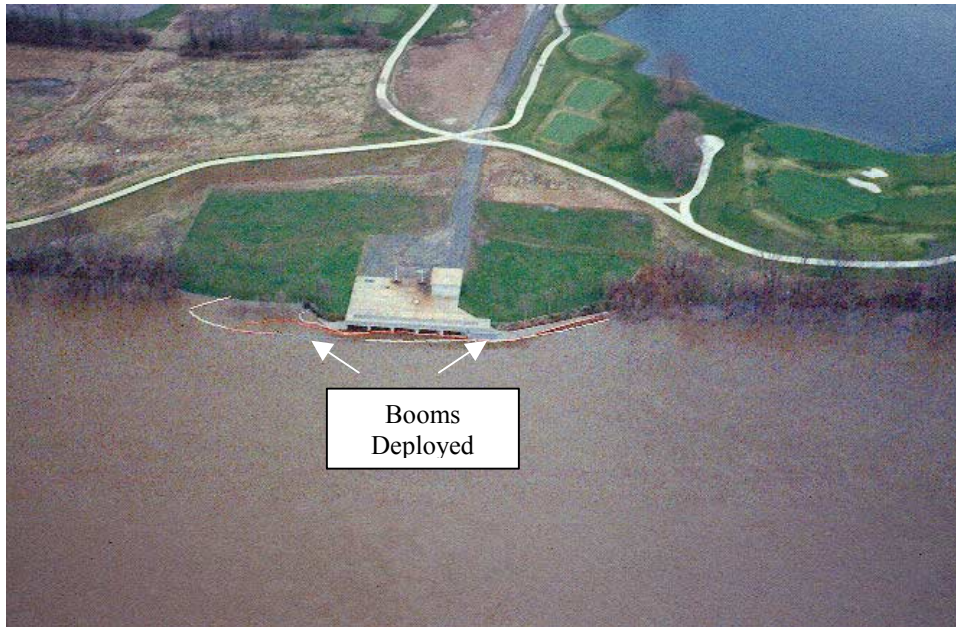

Figure 4-5. Exclusion booming of inlet.



Figure 4-6. Exclusion booming of side stream.

4.2.1.1 Double or Parallel Booming

Two booms deployed in parallel will tend to deflect oil more effectively at steeper angles to the current. Entrained oil will tend to collect in the quiescent area between the two booms. When a low current area is not available for diversion, a collection pit can be dug into the bank to facilitate oil containment and skimming as seen in [Figure 4-7](#). If the upstream boom is effective, a sorbent boom can be used downstream to collect residue.

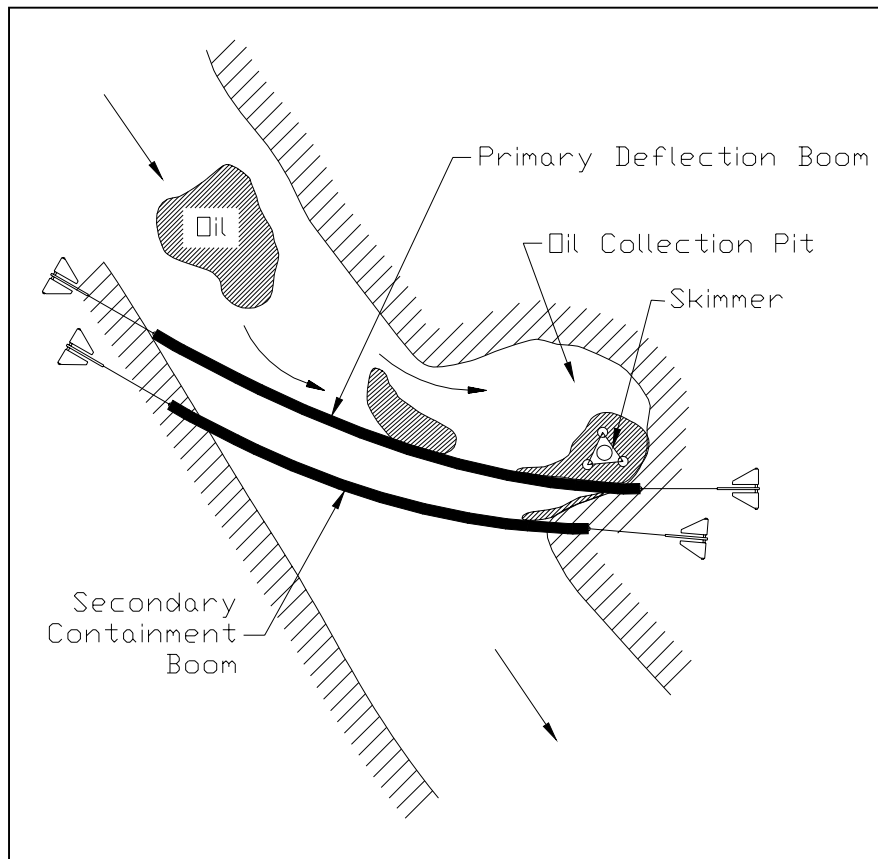

Figure 4-7. Two parallel diversion booms and collection pit.

4.2.2 Cascade Diversion Booming

Cascade booming can be used when a single length of boom is difficult to handle or the loads are too high, especially when the currents exceed three knots. Multiple sections of boom are displayed to overlap (see Figures 4-8 and 4-9) so that the next boom deflects oil lost from under or around the previous upstream boom. This technique is most useful for covering large areas or for high-speed currents.

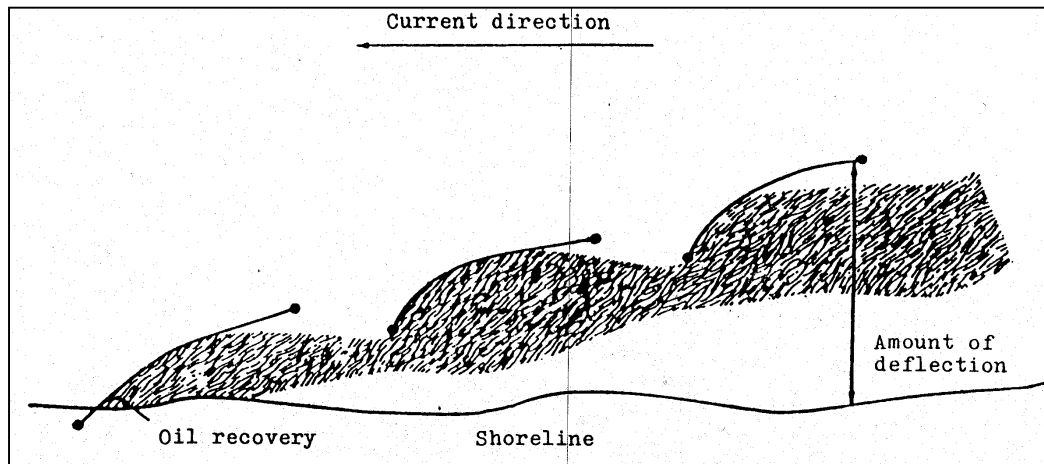

Figure 4-8. Cascade diversion booming (Exxon, 1992).



Figure 4-9. Cascade diversion booms deployed.

4.2.3 Chevron Booming

Chevron booming is used when deflection to both sides of a small bay, channel or river is desirable (Figure 4-10). It is effective in currents up to two knots and it can be deployed quickly. The angles of the booms to the current must still meet the criteria given in Figure 3-1. Losses can be reduced to some extent by double booming behind the first cascade system. Use of boom deflectors between 50-foot boom sections would assist with keeping the boom angled into the current and allow containment at a higher velocity. The two chevron tactics described below are shown Figure 4-11.



Figure 4-10. Chevron booming.

4.2.3.1 Closed Chevron

The standard closed chevron uses one anchor point in the center of a channel. Two sections of boom are attached to the mid-channel anchor, Figure 4-11. They trail downstream to opposite banks, where they are secured to shore anchor points. The shape of the boom is controlled by tension on the boom. Additional anchors along the boom are usually not used. The length of boom obtains the desired angle. This method is most effective when permanent mooring points are in place and the boom can be deployed very quickly. Use of chevrons at locations where rivers widen increases the amount of boom needed, but the lower current in these areas make containment and recovery easier.

4.2.3.2 Open Chevron

An open chevron uses two mid-channel anchors separated by a distance that allows vessels to pass between them safely, Figure 4-11. Each boom forms a single leg to the opposite shore. The booms can overlap to some extent to prevent oil from getting by. This operation takes more time to deploy; however, it is recommended where vessel passage is desired. This tactic can also be deployed from each shore with boom deflectors and/or boom vanes in lieu of anchors.

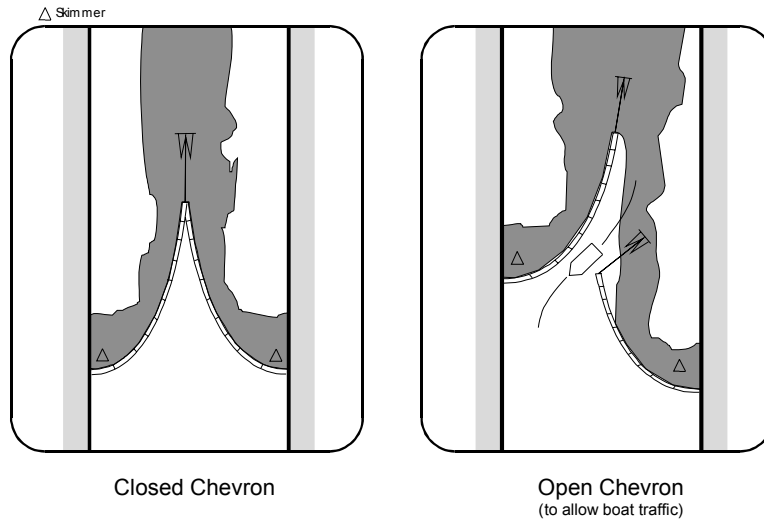

Figure 4-11. Closed and open Chevron booming tactics.

4.2.4 Encircle and Divert

In wide rivers and coastal areas boom can also be used to encircle the large oil patches that move with the current. A patch of oil can be encircled by one boat by using a sea anchor to resist boom movement while the boat circles the oil as seen in Figure 4-12. The oil is then slowly diverted at a velocity less than one knot relative to the surface current into a low current eddy or inlet for skimming. A high level of competency is needed to be able to quickly execute this technique and should only be used as a last resort due to the complexity of the maneuvers required.

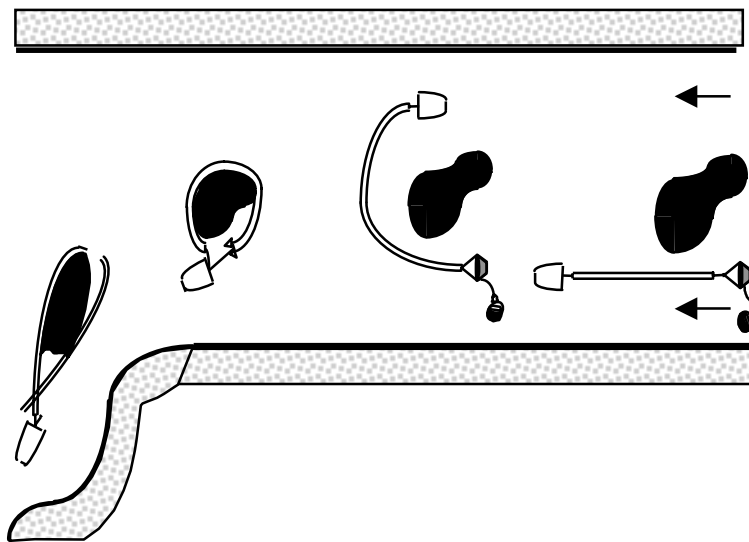

Figure 4-12. Procedure used by one boat to capture oil and divert it to slower waters (Coe and Gurr, 1999).

One method of fabricating a drogue system is shown in Figure 4-13. The actual configuration is dependent upon the size of the vessel and the length of boom. The use of two boats provides better control and requires less training to perform (see Figure 4-14).

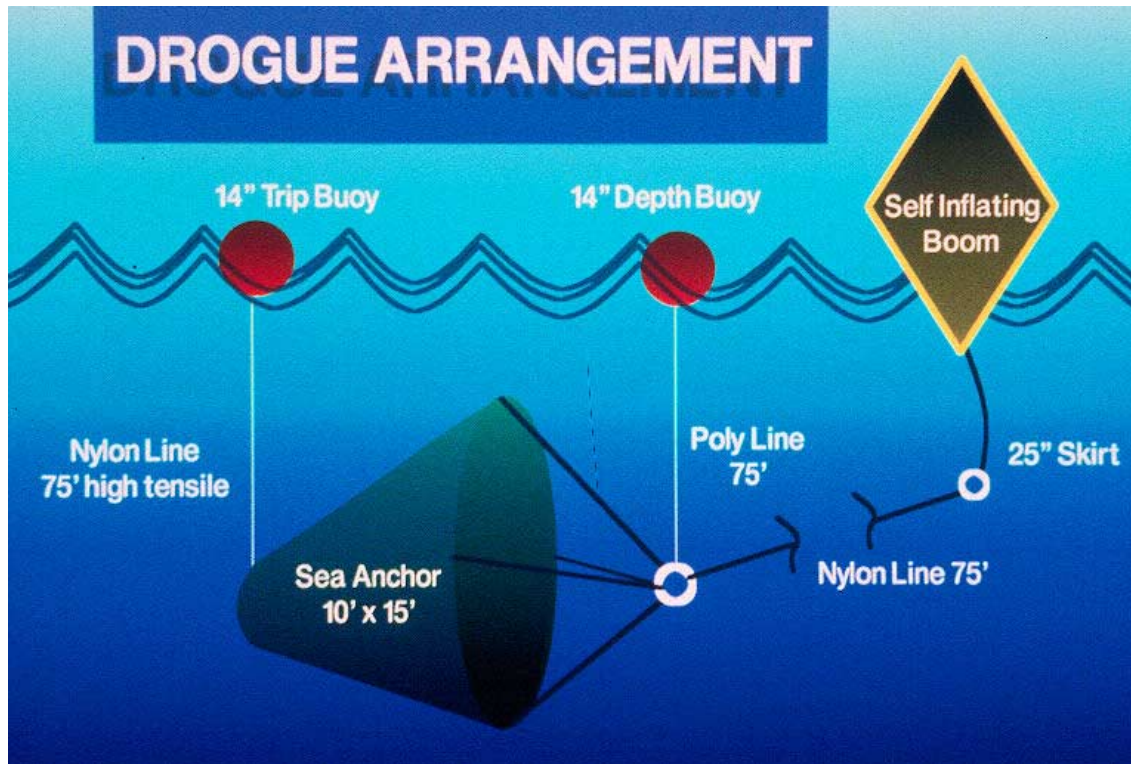

Figure 4-13. Sea anchor and boom configuration for one boat capture (McCarthy).



Figure 4-14. Use of two boats for oil spill capture.

4.3 Rivers/Canals (Tidal)

The presence of tides on a navigable river will significantly complicate an oil spill response. Approximately every six hours the tidal currents will change from maximum flood to maximum ebb tide. This requires constant tending of the deflection boom as the current changes. Tidal current reversals often require that the equipment be repositioned on each tidal change, up to 4 times in each 24-hour period. Maximum currents in fast water tidal rivers vary between 1 and 3 knots, which is lower than the inland rivers. The ebb current is usually slightly stronger than the flood tide due to fresh water runoff. Rains will dramatically increase ebb tides while diminishing and delaying flood tides. Local conditions can dramatically change the time and magnitude of maximum currents and slack water. Strong winds can pile up water against coastal areas and accentuate high tides or reduce low tides depending upon the timing.

The same methods used in non-tidal areas can be utilized in tidal areas with some modifications. In tidal areas, all booms must be stabilized to stay in place during slack and reversing currents. The configuration should not rely on the force of the current to maintain its shape. One method to control spilled oil from a point source in a tidal situation is shown in Figure 4-15.

Inlets, attached bays and tributaries are generally sensitive areas that must be protected during flood tides to prevent oil from entering. Oil that has been collected during an ebb tide by a diversionary boom angled to the shore will be lost on a reversing flood tide unless it is skimmed or contained from escaping. Booms often have to be moved as the tide starts to shift in order to protect sensitive areas or contain oil during the flow reversal. Booms should be configured to withstand and be effective in the most severe current predicted for the next tidal cycle. If the boom is to remain in the same position during both tides then it should be anchored on both upstream and downstream sides to keep it in place and to prevent anchor dislodgment.

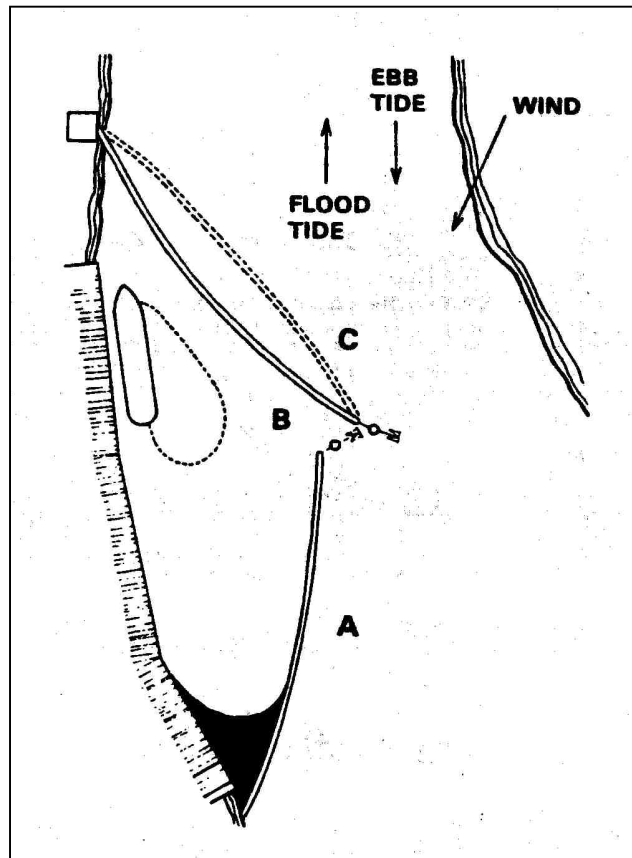

Figure 4-15. Double booming arrangement in tidal river (National Spill Control School, 1998).

The other major problem caused by tidal cycles is the change in water levels. Multiple booms may be needed to handle oil movement for both high and low tide levels (see Figures 4-16 and 4-17). Tidal seal booms (see section 4.3.1) are made specifically for this type of application.



Figure 4-16. Boom at high tide.



Figure 4-17. Boom at low tide.

4.3.1 Tidal Seal Booms

Although originally designed for tidal conditions, tidal seal booms can be used under low flow conditions. A typical design (see Figures 4-18 through 4-20) uses water ballast to settle on the bottom. This technique is most useful for culverts on a tidal estuary. These booms can also be attached to conventional boom as shown in Figure 4-18.

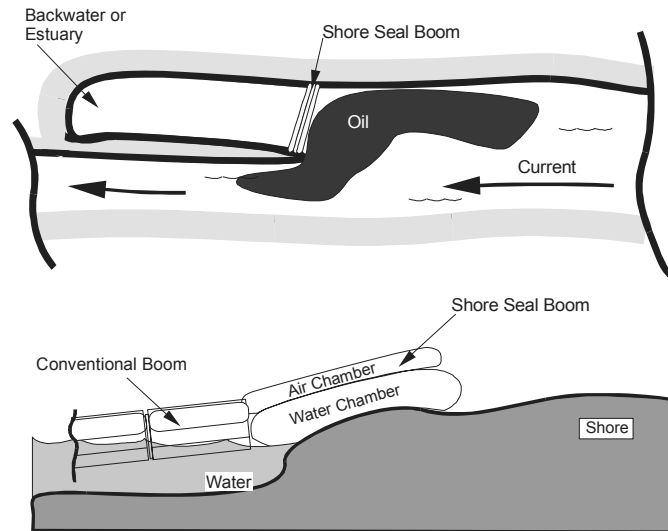

Figure 4-18. Shore seal boom protects shallow inlets and seals.

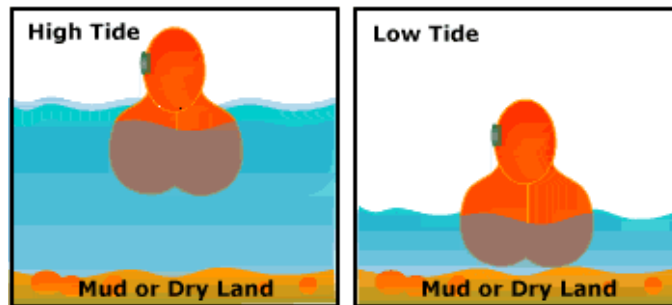

Figure 4-19. Shore seal boom during tidal fluctuation (Texas Boom Company, Inc. 1997).



Figure 4-20. Deployed tidal boom.

4.3.2 Other Techniques

Open water techniques such as Encircling ([section 4.2.4](#)) and Skimmers ([see Chapter 6](#)) can also be used in the tidal areas. Cascade Diversion booming ([section 4.2.2](#)) and Chevron booming ([section 4.2.3](#)) can be used when protecting a particular area, but care must be taken to control the oil on the reverse tide. In many cases, a complete second boom configuration has to be deployed. Whenever possible, these systems should be deployed outside of channel mouths instead of the narrow neck to reduce the flow velocity that the boom encounters.

4.4 Small Streams/Creeks/Culverts

Shallow streams and culverts are susceptible to spills from pipelines, storage facilities, highway accidents and storm drains. Boom is generally ineffective in shallow water where the draft is greater than about one-third of the water depth. The restricted flow under the skirt increases the flow, which increases oil entrainment. For low flow rates or small spills, standard booms, especially the sorbent type, can be used. Filled fire hose can also serve this function. A rule of thumb for low flow rate is less than 10 cubic feet per second. Methods to estimate the flow are provided in [Appendix J](#). Above this flow rate, underflow dams, overflow dams or sorbent barriers can be used. Under very low flow conditions, a berm can be built that completely stops the flow. Changing weather conditions can drastically alter the flow so caution should be taken during severe weather. All of these techniques require constant monitoring to ensure that the oil does not reach the intake. In some conditions, a combination of techniques can be used such as using a sorbent barrier backed by an underflow dam.

Underflow Dams

Dams can be built in shallow rivers, culverts and inlets using hand tools or heavy machinery as available. Pipes are used to form an underflow dam to allow water passage out while oil stays behind, as seen in [Figure 4-21](#). The inlet of the pipe is cut at an angle to permit a larger entrance area for the water in order to reduce the inlet velocities and the possibility of oil draw down due to formation of vortices. Caution should be taken to prevent whirlpools from forming and pulling the oil down. Face the cut pipe opening down (or insert a 90 degree angle) to help eliminate this. This technique is effective for water bodies less than two feet deep where flow volume can be accommodated by pipe flow (see [Figures 4-22 through 4-25](#)). This method can also be used in deep, narrow culverts.

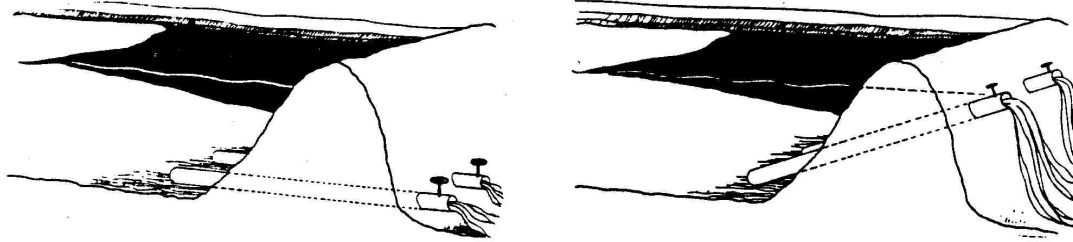

Figure 4-21. Earth underflow dam (DOWCAR, 1997).



Figure 4-22. Sandbag underflow dam.



Figure 4-23. Underflow dam with debris boom.

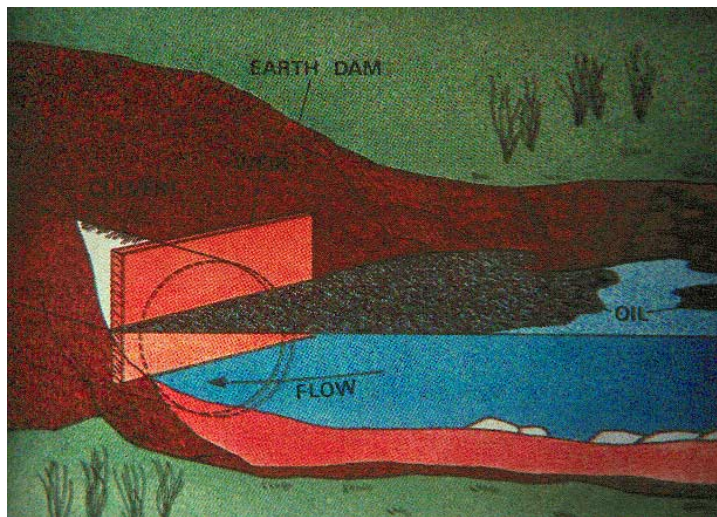

Figure 4-24. Wooden underflow dam.

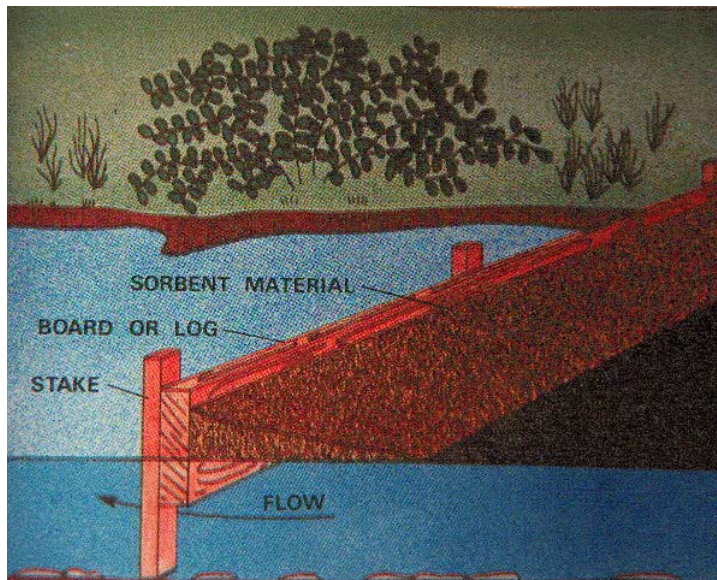

Figure 4-25. Underflow dam with sorbent material.

Overflow Dams

An overflow dam can be utilized if a pump is available and the flow of the stream is low, [Figure 4-26](#). This method allows more control over the amount of water that is moved past the dam.

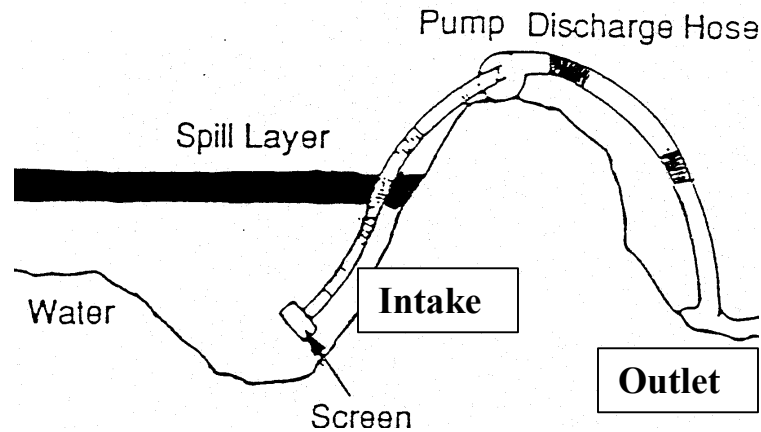

Figure 4-26. Overflow dam (National Spill Control School, 1998).

Berms

Berms can be built in shallow rivers, culverts and inlets using hand tools or heavy machinery as available. It can be used to totally block the flow into and out of a sensitive area. In this case, outflow from the area must be very slow. This technique is effective for water bodies less than two feet deep. Berms can also be used as a diversionary system at angles to the current to divert flow and oil from sensitive areas. Erosion of the berms can occur which may require maintenance to prevent breakthrough.

Sorbent/Filter Barriers

Sorbent barriers can be used for small spills in areas with low flow rates. The sorbent sandwich barrier is shown in [Figures 4-27 through 4-29](#). Any type of fencing or screening can be used to stabilize the sorbents. Silt barriers, hay or other similar materials can also be used.

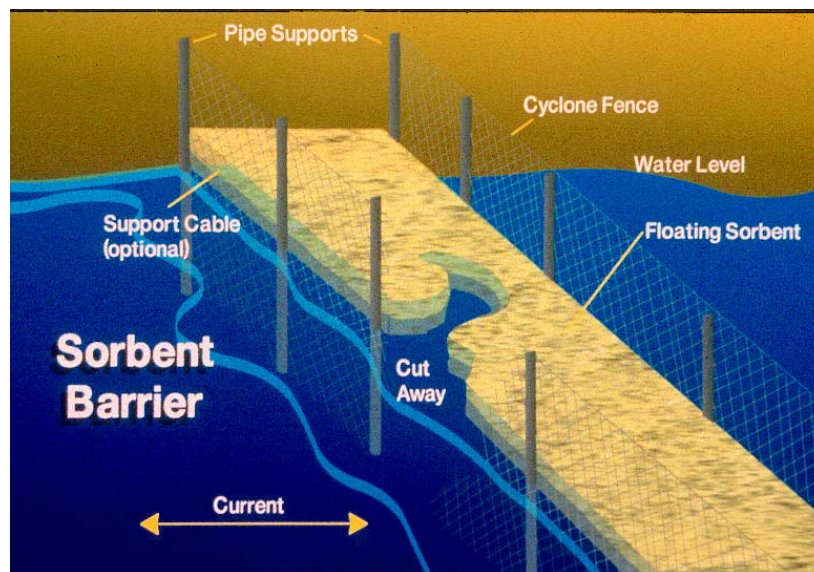

Figure 4-27. Sorbent barrier.



Figure 4-28. Sorbent barrier.



Figure 4-29. Hay filter barrier.

Tidal Seal Booms

Short sections of tidal seal booms can be used to seal off shallow streams and culverts ([see sections 4.3.1](#)).

4.5 Coastal Areas

Coastal regions have cyclical tidal currents that complicate response efforts due to constantly changing current velocity and direction. A great containment site on one tide could be easily cleared of oil when the current reverses on the next tide. River runoff, wind shifts and dramatic changes in barometric pressure will affect tidal currents significantly from prediction tables. Local knowledge and awareness of changing weather patterns are required to make informed decisions on ideal collection locations and determining where exclusion boom is required. Control points are likely to change during a spill event.

The techniques used for rivers and canals need to be modified for use in coastal areas. Water depth is usually greater along the coast than in rivers and bays, thus requiring more anchor chain and line to moor boom. Open sea conditions bring the potential for higher wind-driven waves and swells. This will necessitate the use of larger freeboard and deeper draft boom. Higher drag forces on deep-draft boom will complicate the response in fast water by deforming the shape of the boom requiring more anchor attachment points along the boom and larger anchors. Heavier anchoring equipment is needed to handle the waves and deeper water that may be encountered. Waves also make recovery more difficult. Boats are required to place equipment offshore. Incline submergence plane and oleophilic skimmers are more effective in waves than surface slicing and weir skimmers. Self-adjustable weir lips follow wave motions and maintain higher efficiencies in waves. Boom diversion systems can amplify waves making skimming more difficult. Tests of offshore oil booms have shown that a reserve buoyancy to weight ratio of at least 20 to 1 is required in high seas states offshore (Nordvik, Sloan, and Stohovic, 1995). Typically, oil will move at 3.5 percent of the wind velocity downwind with no other currents present. [Appendix D](#) shows calculations for calculating wind drift.

Inlets to marshes, rivers and harbors are usually constricted resulting in high currents during maximum ebb and flood tides. Oil containment should be conducted in lower current locations inside or outside of these inlets. Tidal gates or similar structures may be helpful to protect sensitive areas. When waves increase offshore, the only recourse is open water containment outside the inlet using advancing systems and several fixed diversionary control points inside the opening. Tidal currents are generally lower than inland river currents, however, they can routinely exceed one knot. The most challenging areas are at the mouth of inlets where velocities increase and directions change. If oil is originating from an inland water body source, it can be swept down the coast to new areas or return to the originating water body depending upon the local tidal current conditions.

Harbors are generally high traffic areas where many spills originate. In addition to selection of containment locations, consideration has to be given to control or restriction of vessel traffic. Points, islands and shoreline indentations can be used to facilitate containment and diversion of oil. The downstream side of flow obstructions will have reduced currents and eddies that can be used to assist with oil containment. Once oil has started to enter the harbor or inlet, the response methods will be similar to rivers and canals.

4.5.1 Single Diversion Boom

The main factor in diversion in coastal areas is waves. Most booms do not work in breaking waves. A diversion boom configuration as seen in [Figure 4-30](#) can be used for ripple waves. A shore seal boom ([see Figure 4-18](#)) would be more efficient than a standard boom in the shallow water zone. For a more severe wave environment, a V-shaped arrangement ([see Figure 4-31](#)) should be used to keep oil out of the wave zone. The apex could be located outside of the waves if a skimmer is available. Lack of sufficient tension in the boom will result in pockets forming ([see Figure 4-32](#)) and loss of oil.

Selection of mooring point locations on the boom should be done to ensure the boom remains stable. Typical mooring points use end connectors with bridles to stabilize the boom. Additional mooring connection points along the boom for deflection applications should also be made at the center of the drag force or by using bridles connected to top and bottom tension members. This may require a support bar at the boom to prevent the bridle from collapsing the skirt under load. Using boom with a deeper draft will usually increase stability; however, drag is dramatically increased with draft, which is undesirable in high-speed currents. Some manufacturers offer fast current boom with holes cut in the bottom of the skirt or net for the lower end of the skirt to add stability but at reduced drag. However, this design may cause turbulence, thereby facilitating oil entrainment.

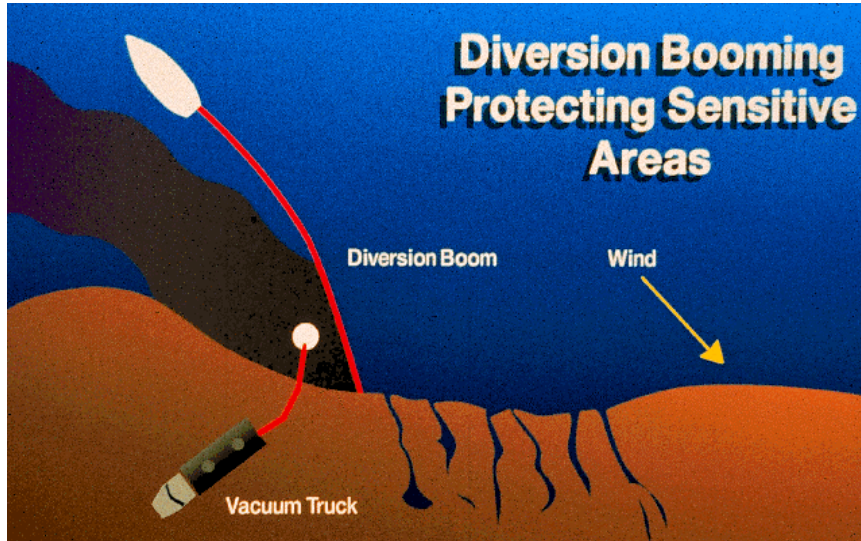

Figure 4-30. Diversion booming.

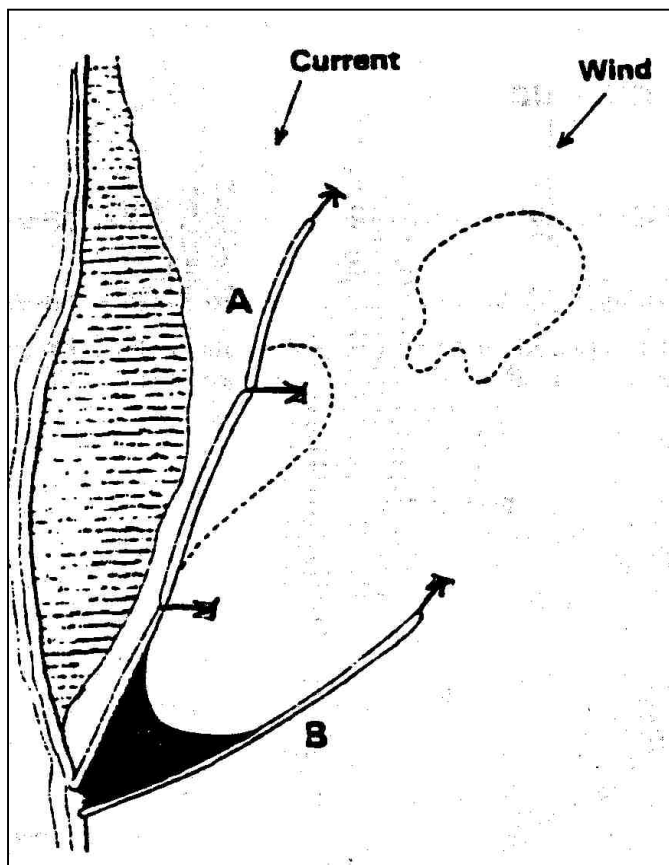

Figure 4-31. Correct booming near shore (National Spill Control School, 1998).

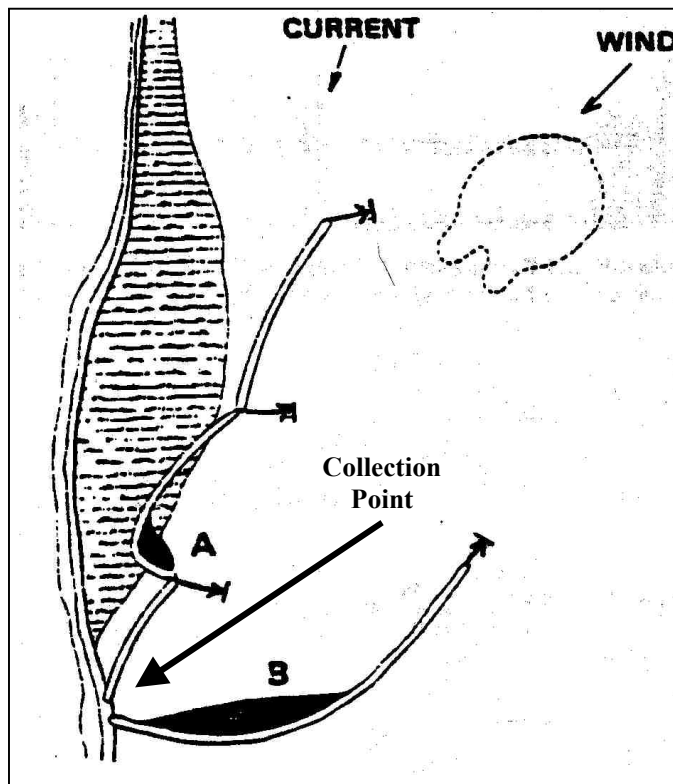

Figure 4-32. Pockets forming as result of incorrect booming.
 (Note that oil is not arriving at collection point)

4.5.2 Cascade Boom

A cascade boom system can be used if current and wind are consistent and especially if directed along the shore (see Figure 4-33). The booms can be used to protect sensitive areas or to deflect the oil to skimmers that cannot approach the shore (see Figure 4-34).

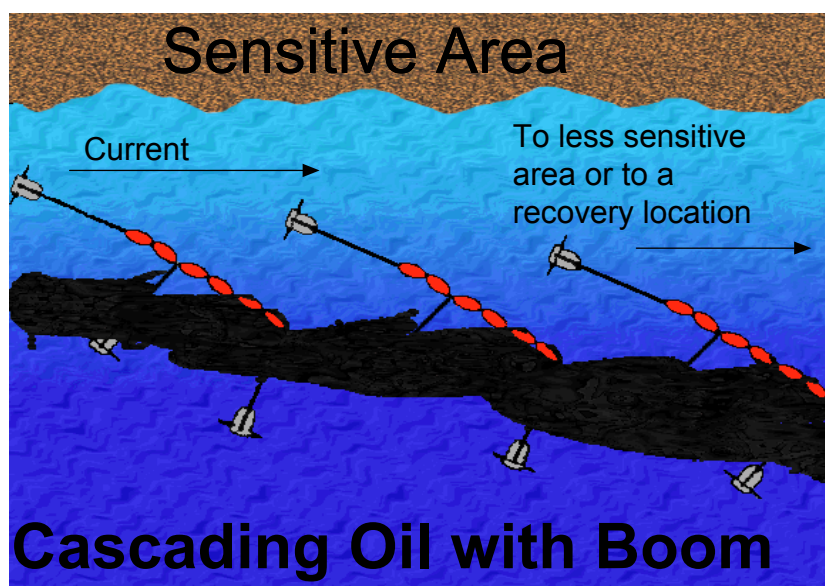

Figure 4-33. Cascaded deflection booms (U.S. Navy, 1991).



Figure 4-34. Cascading booms in open area.

4.5.3 Exclusion Booming

Exclusion booming (see Figures 4-35 through 4-37) may be used for inlets and sensitive coastal areas. Tidal currents vary in these large areas, but maximum flood and ebb tides range from 1 to 2 knots with higher velocities at choke points and inlet entrances.

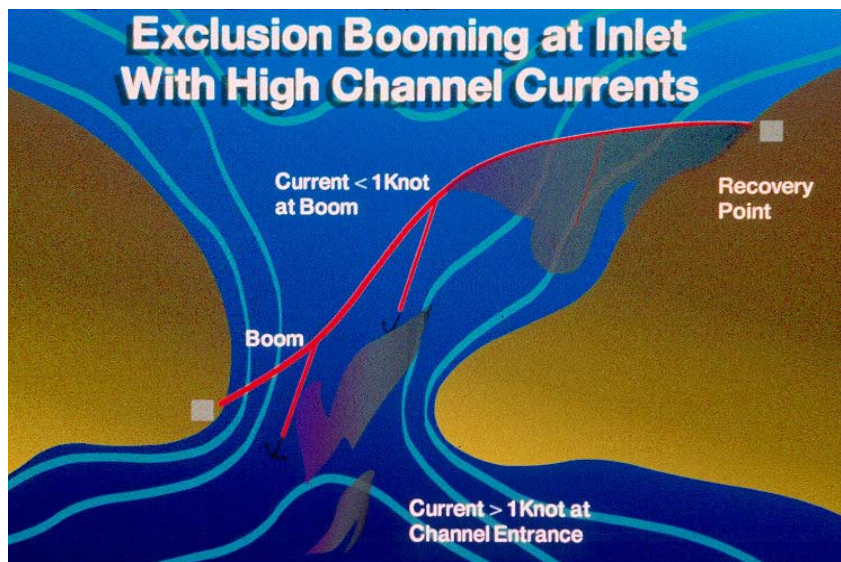

Figure 4-35. Protecting inlets with exclusion booming.

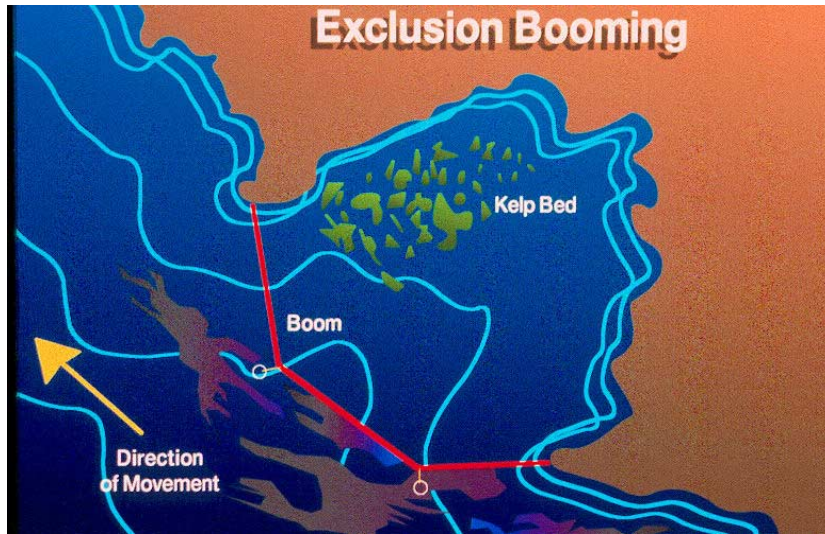

Figure 4-36. Exclusion booming.

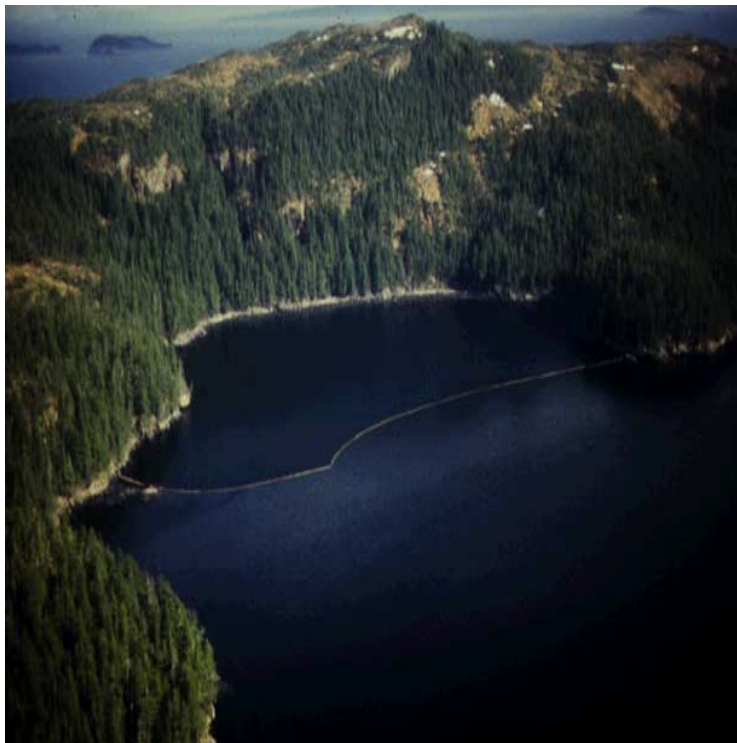

Figure 4-37. Exclusion booming.

4.5.4 Other Techniques

Open water techniques such as Encircling (see paragraph 4.2.4) and Skimmers (see Chapter 6) can also be used in the Coastal zones.

4.6 Harbors/Bays

All of the techniques used in the rivers and the coastal areas can be adapted for use in open harbors and bays. Areas with a low wave environment and higher currents can directly use the river approaches given in [sections 4.2 and 4.3](#). Areas with waves and varying currents should use the approaches for coastal areas in [section 4.5](#). Special arrangements may be needed to keep oil from getting beneath piers and away from structures built to protect anchorage. In situations where the water becomes shallow, ensure that cleanup equipment can transit out of the area when filled with a full load of oil.

These techniques include:

- [4.2.1.1](#) Double or Parallel Booming
- [4.2.2](#) Cascade Diversion Booming
- [4.2.3](#) Chevron Booming
- [4.2.4](#) Encircle and Divert
- [4.5.1](#) Single Diversion Boom
- [4.5.3](#) Exclusion Booming
- [6.1](#) Fast Water Skimmers

4.7 Breachways and Harbor Entrances

There are several options to protect a harbor or breachway from an ocean or coastal spill entering during a flood tide. The first line of defense is to deflect oil past the harbor entrance ([see Figure 4-38](#)). Oil can also be trapped and contained by setting up diversion boom to deflect oil to the shoreline outside the harbor entrance. Long shore currents may be helpful since they can transport oil along the coast into collection booms that are properly placed. Once the oil has started to enter the harbor or breachway entrance, the response methods similar to rivers and canals can be used.

Generally, oil should be herded away from piers, marinas and breakwaters as they are difficult to access and to clean. In some situations, wharves and bulkheads with solid, easy to clean surfaces can be used as collection and diversion sites. Large vessels or barges can be positioned to assist with flow control and oil diversions.



Figure 4-38. Booming in beachway.

4.7.1 Single Diversion

The first but most difficult place for a diversion boom is right at the entrance (see Figure 4-39). This approach minimizes the oiling of the shoreline, but the boom may be exposed to waves. The deployment angle is determined using Figure 3-1. Boom tension calculations are shown in Appendices F and G. A secondary location would be just inside of the opening as it widens and the current slows. This lower current permits a steeper boom angle, but may require more booms.

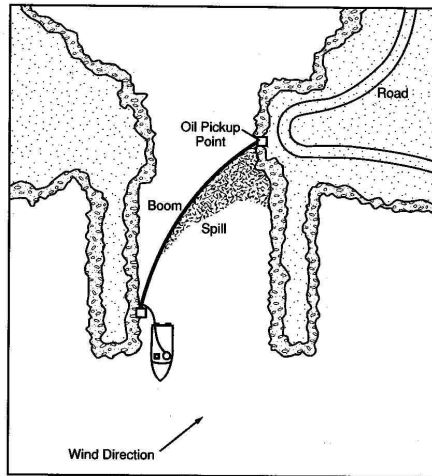

Figure 4-39. Booming harbor or tidal inlet (Exxon, 1992).

4.7.2 Cascade Systems

For larger or deeper entrances, those wider than 200 yards, cascade systems can be used. They may need to be combined with other methods as seen in Figures 4-40 and 4-41. The concept of this type of arrangement is to deflect the oil into the slower current areas and seal the sensitive areas. Additional boom would be needed to keep oil from floating back out during an ebb tide. Planning should occur well ahead of any spills and contingency plans should be implemented for training to ensure that the plan is viable as this type of response is very complex and challenging.

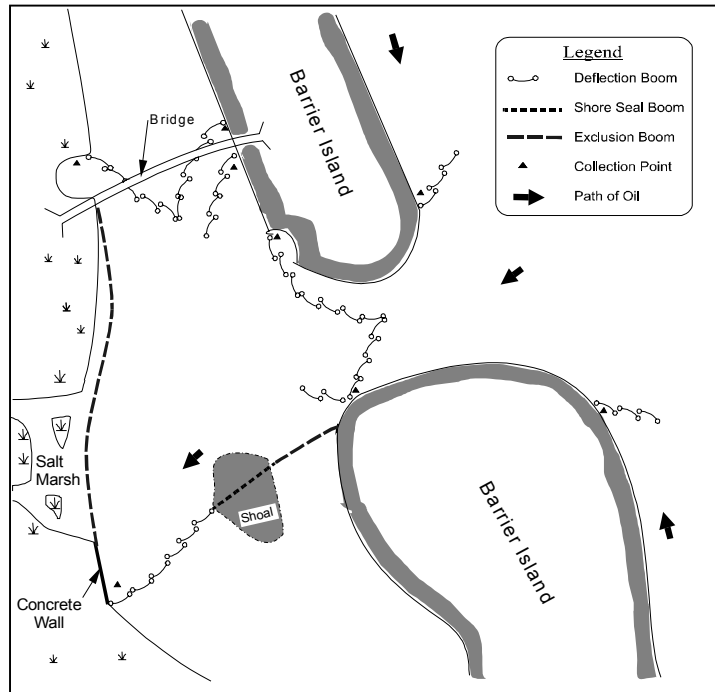

Figure 4-40. Barrier Island inlet spill response strategy (Hayes and Montello, 1995).



Figure 4-41. Cascade boom in inlet.

4.7.3 Blocking

For small, non-navigable inlets, the use of dams and weirs can be employed in the same manner they were deployed for small creeks and culverts (see [section 4.4](#)). Due to changing tidal cycles and possible waves, more concise control of the flow is needed. Pumps should be utilized and the method should not rely on gravity feed. Multiple dams may be needed, especially to keep oil that is already in an area from escaping and affecting other areas. Intertidal (sealing) boom works as a quick dam in almost any location.

CHAPTER 5. BOOMING TECHNIQUES

Many organizations, companies and individuals have developed techniques for particular applications. See [Appendix L](#) for ASTM Committee F20 evaluation of techniques.

5.1 Cascade Booming DOWCAR Technique

This technique (U.S. Navy, 1991) has been perfected and taught by DOWCAR Environment Management, Inc. of Taos, New Mexico for many years. It can be effective in currents up to 5 knots with a trained crew. This procedure can be used across waterways up to 600 feet wide. All boom anchors and tending lines are attached to shore for better control. They recommend using short 50-foot sections of 4 by 6 foam boom (4-inch floatation, 6-inch draft) when currents exceed 3 knots, [Figure 5-1](#). This prevents excessive mooring, loading and boom shape distortion. Use 3/8-inch polypropylene mooring lines to prevent excessive drag in high current. Small boats and a ferry line system are used to move people and equipment across the river. Special mountain climbing equipment such as ascenders is used in conjunction with pulleys to grab onto the mooring line and pull out the slack.

To position the boom properly, two upstream and two downstream lines are attached to each boom section to provide complete control from shore. A trained crew can boom a 200-foot wide river with a current of 3 knots in approximately 45 minutes. Systematic procedures for booming a narrow river using the DOWCAR tactic are presented in [Appendix E](#).



Figure 5-1. Deploying cascade boom in a narrow river (DOWCAR, 1997).

5.2 Overlapping J-Shape Booming

This tactic is used where cascade booming is desired in wide rivers or along the coast. It is similar to the DOWCAR technique but requires submerged anchors and the use of powered boats to deploy them. It can also be used offshore for exclusion away from sensitive areas. The benefits of all cascade systems are that loads are lower on individual booms requiring smaller anchors, and if one boom is taken out by debris the rest of the system remains in place. This affords easier adjustments when problems develop. If vessel passage is desired, the spacing between booms can be increased. Short sections of 50 to 100 feet lengths are recommended to keep the desired shape. Mooring lines of submerged anchors cannot be tensioned as well as shoreline anchors resulting in a slack boom condition that usually forms a J-shape. Oil often entrains under the downstream end of the boom where the angle exceeds the maximum deflection angle for the current. This requires that the booms downstream be overlapped a greater distance to capture the oil which is lost upstream as seen in Figure 5-2. Use of multiple anchors is difficult in fast-currents over 2 knots so planning and training are required.

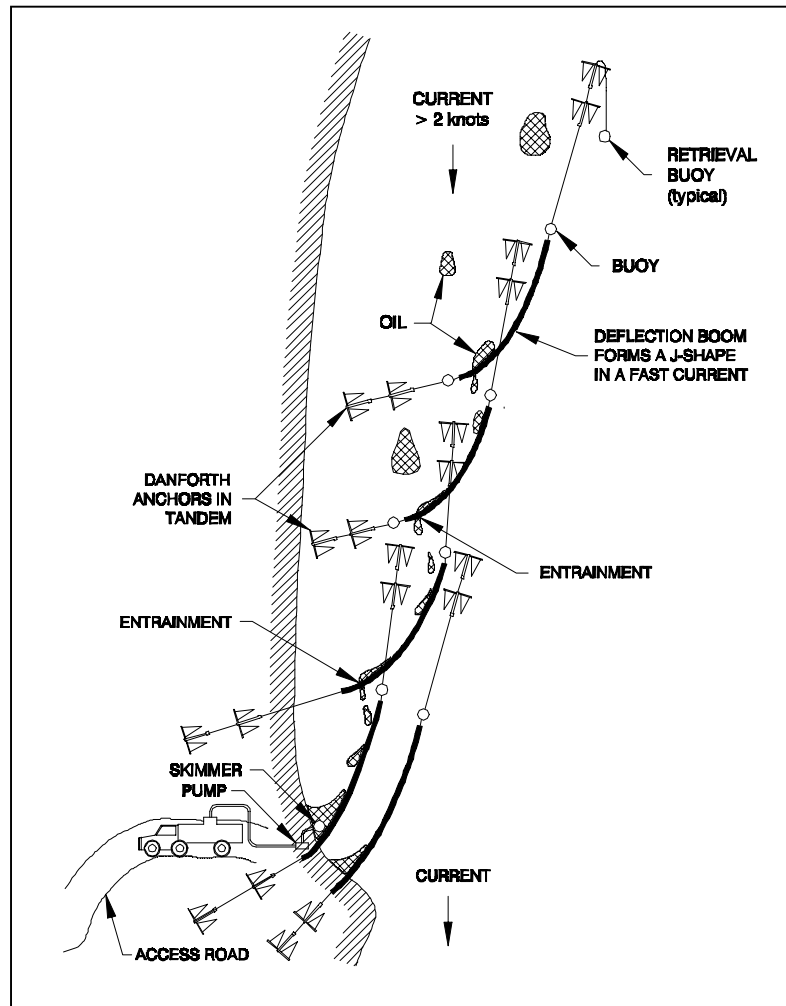

Figure 5-2. Cascade J-shape deflection booming requires more overlap (Coe and Gurr, 1999).

5.3 Continuous Boom

Long sections of continuous boom require less setup rigging than cascade booming and are usually deployed more quickly. The disadvantages are that it is difficult to keep it from bellowing out and to handle. This causes oil entrainment when the boom angle exceeds the maximum deflection angle for the current.

5.3.1 Trans Mountain Pipeline Tactic

The Trans Mountain Pipeline in British Columbia, Vancouver, Canada, has adopted and modified a version of the Canadian Petroleum Producers (CPP) (Coe and Gurr, 1999) deflection booming technique. They use continuous sections of 6" X 6" (6-inch buoyancy and 6-inch skirt) foam boom for deflection and containment on fast flowing rivers. The boom distortion is reduced by attaching shoreline ropes to the boom at intervals and pulling the boom downstream to keep it straight. The shoreline ropes attach to the boom with special bridles. The ends of the bridle are separated by a light pipe with snap hooks on each end that snap to rings on the top and bottom of the boom. The pipe keeps the boom from collapsing when shoreline ropes are pulled to shore under tension. This process puts a large force on the boom anchor line upstream, so a 3/8-inch cable is used to take this high tensile load to the anchor. A tow paravane is attached to the leading edge of the boom for added buoyancy. Three mooring techniques are depicted in Figure 5-3: (1) bridge, (2) cable ferry and (3) anchors.

The cable ferry system allows for changes in the deflection angle to compensate for changing currents and to avoid large debris. Use shallow draft self-adjusting weir, disk or drum skimmers in the apex of the boom. Suction trash pumps remove oil collected by the skimmer. A 200-foot wide fast-water river can be protected in approximately 25 minutes using this technique. For wider rivers, a second layout of the boom system shown can be set up downstream on the opposite bank.

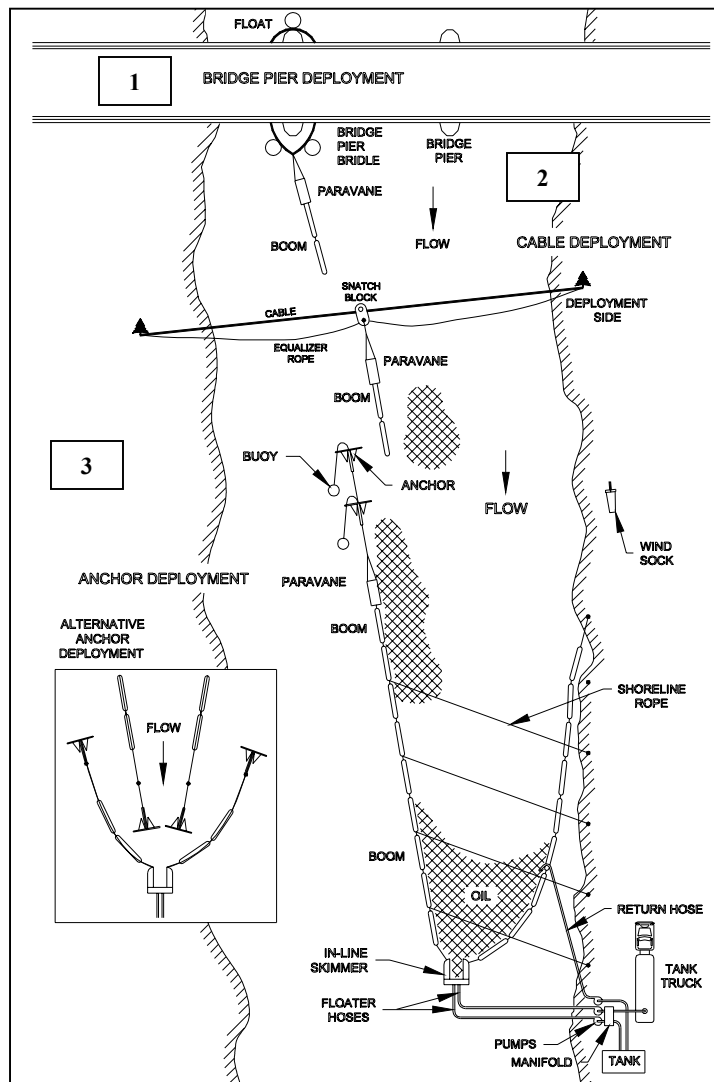

Figure 5-3. Transmountain pipeline tactic.

5.4 Multiple Anchors

Multiple anchors are required on long sections of deflection boom deployed away from the shoreline as shown in [Figure 5-4](#). The use of multiple anchors prevents the boom from bellowing out and reduces loads on end anchors. This shape-keeping tactic allows boom to maintain a consistent deflection angle to prevent oil entrainment in swift currents. This tactic can be used for deflection of oil to shore or into an inlet with slower currents where it can be more readily contained. This tactic can also be used in deeper water to exclude and direct oil away from sensitive areas or inlets. In reversing tidal current areas, additional anchors are also required on the opposite side of the boom to ensure it stays in place after the tide changes. The liability is that debris or a strong current can dislodge or completely take out the entire system. Adjustment of the anchors takes time to get the correct deflection angle and boom shape. The use of multiple anchors makes this method difficult to use at higher speed currents over 2 knots.

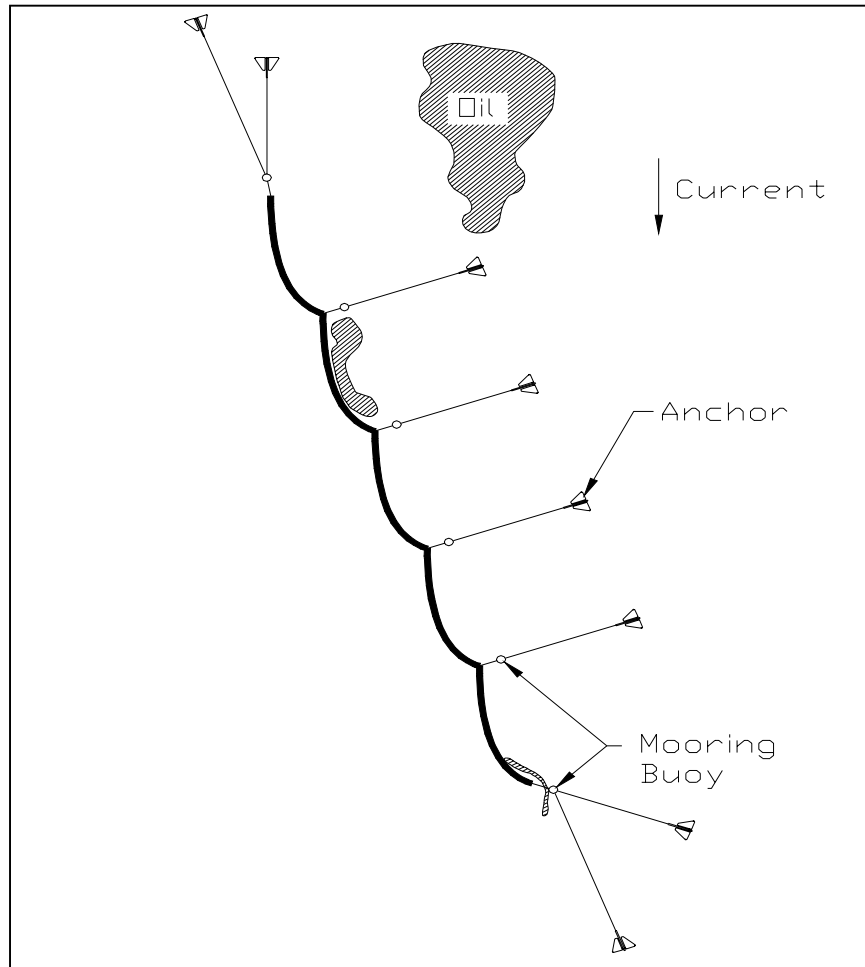

Figure 5-4. Multiple anchors on sections of boom.

5.5 Boom Deflectors

Boom deflectors (see Figure 5-5) allow quick deployment of deflection boom with a long continuous run and only requires one upstream anchor line. They are useful where fast response is needed and deployment of multiple anchors or cascade booming is too difficult. The deflectors are placed between each section of boom using 50-foot sections for speeds over 2 knots. A floating arm extends out the downstream side of the deflector body and pushes the boom into the current. The push on the deflector corresponds to the speed of the current and the angle set on the deflector. In faster currents a shallower boom angle and thus less extension of the deflector arm is required. The boom is deflected up to a maximum of 20 degrees into the current. The number of deflectors is based on the number of boom sections and not on the speed of the current or the amount of oil being contained.

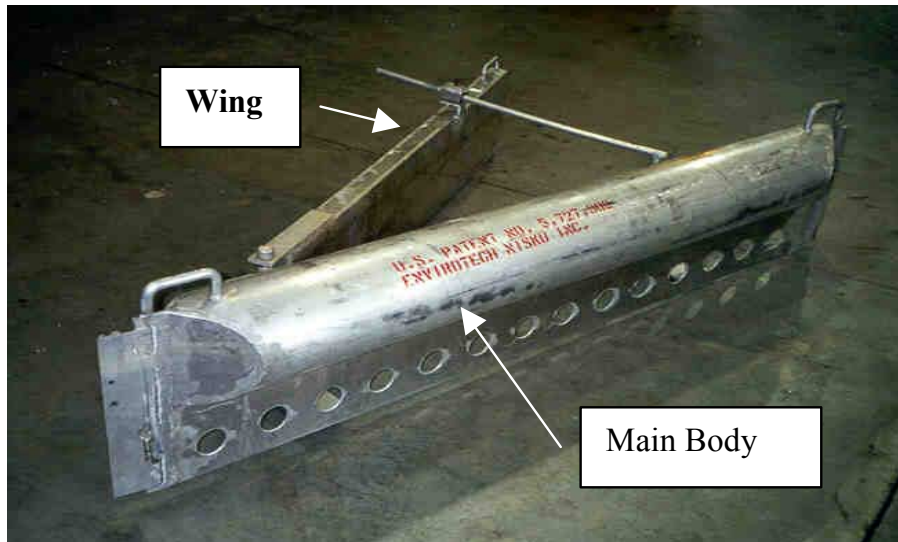

Figure 5-5. Boom deflector.

Boom deflectors are effective in currents up to 8 knots and require a minimum current of 1.5 knots to work well. They were developed and patented by Envirotech Nisku Inc. of Alberta, Canada. Recently, deflectors were successfully demonstrated in tests conducted on the Columbia River in Washington, Figure 5-6. These tests were sponsored by the USCG (Hansen, 1999). There are no ropes connected to the shore to snag debris or inadvertently deflect oil to shore upstream of the skimmer, Figure 5-7.



Figure 5-6. Boom deflectors push the boom into the current.

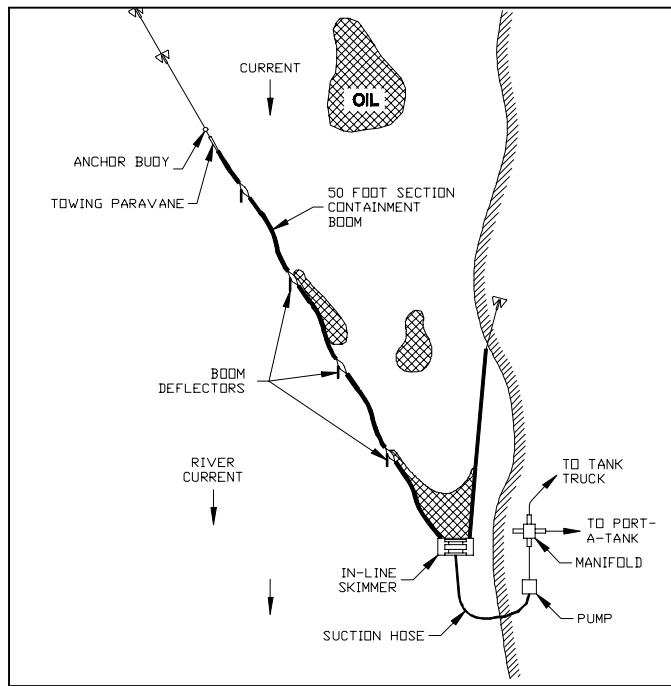

Figure 5-7. Boom deflectors can be used without multiple anchors.

5.6 Boom Vane

The boom vane (see Figure 5-8) allows a diversionary boom to be deployed from shore without use of anchors and boats. The boom vane pulls the boom off the shore by developing hydrodynamic forces from the current passing over the paravanes. It consists of a frame with vertical curved paravanes, which float upright. A stabilizing arm with a control fin is controlled by a person on shore (see Figure 5-9). Pulling on the control line flips the fin and causes the boom vane to stall and return to shore. Release of the line again restores the fin and the boom vane returns out to the channel. It also shows promise for use with advancing sweeps using high speed skimmers to keep the boom pulled out from a vessel without the use of rigid and bulky outriggers.

The Coast Guard evaluations on the Columbia River (Hansen, 1999) and in Martha's Vineyard (Hansen, 2000) showed the boom vane to be effective in high currents (Figure 5-10). It requires a minimum current velocity of approximately 1 knot to develop enough lift force to pull a boom into the current. The Boom Vane is built by ORC of Frolunda, Sweden. It is distributed in the United States by QualiTech Environmental of Chaska, Minnesota and overseas by ORC.



Figure 5-8. Boom vane is quickly assembled.

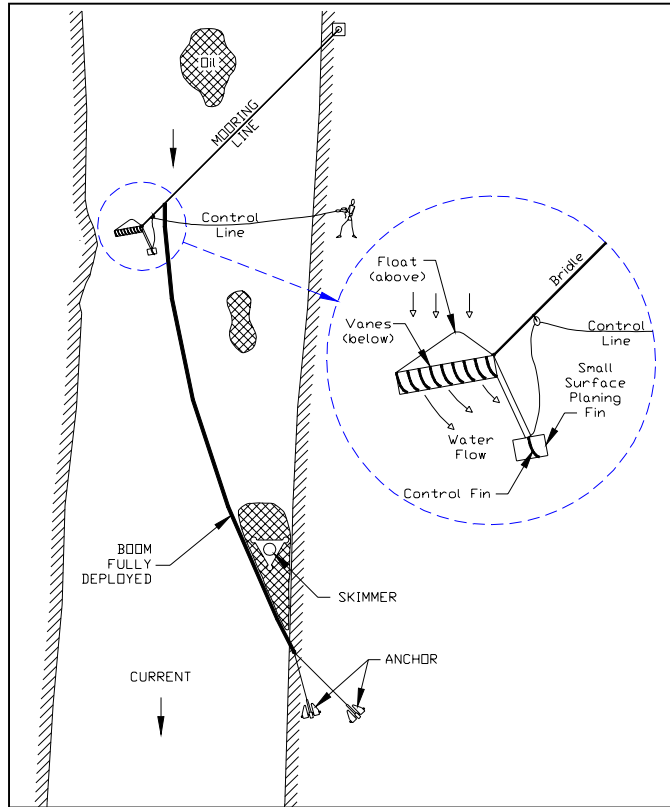

Figure 5-9. Boom vane deploys and retrieves deflection boom from shore to allow vessel passage (ORC AB, 2000).

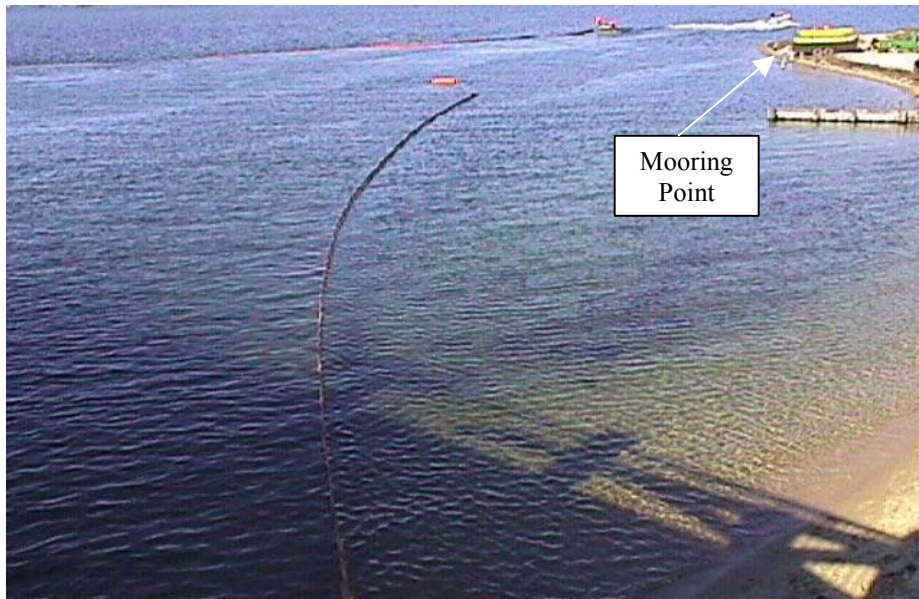

Figure 5-10. Boom vane deployed in Martha's Vineyard.
 (Mooring line is attached to point of land in upper right-hand part of picture)

5.7 PROSCARAC River Boom Deployment Scheme (PROSCARAC, 1992).

The final configuration is shown in Figure 5-11.

Step 1

Install anchor buoys at upstream and downstream ends of control points.

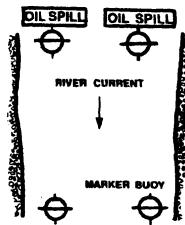

Step 2

Connect two CPA anchors together on work barge deck with appropriate cable. Anchor chains and anchor marker buoys together.

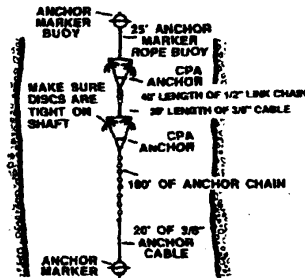

Step 3

Mark approximate location where river boom will be deployed using a fixed landmark. Move upstream approximately 200 feet.

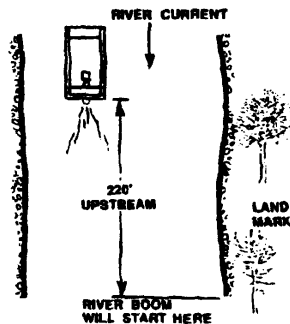

Important – Never set anchors out farther than the maximum deflection angle and boom length allowed by the current conditions.

Step 4

Put out anchor marker buoy, deploy front SPA anchor, once anchor is on bottom workboat slowly drifts downstream – do not get the rope into teeth of anchor.

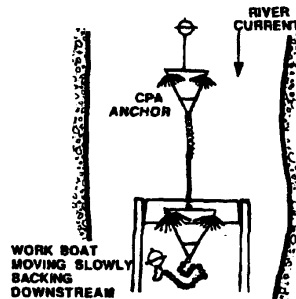

Step 5

As chain from front CPA anchor tightens, start deploying rear CPA anchor. Be careful not to tangle rope or chain into anchor.

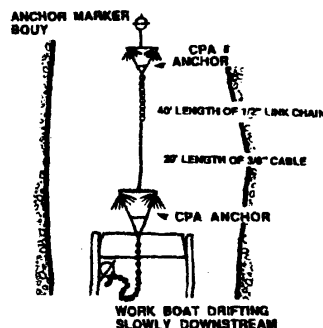

Step 6

After both anchors are in river, hook work boat onto anchor cable marker buoy and start pulling anchors downstream to set them.

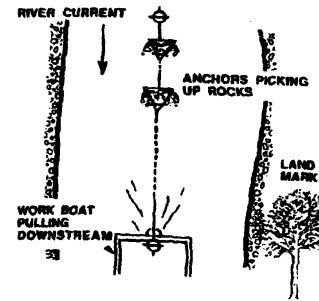

Step 7

After the CPA anchors are set, tow the river boom to the anchoring cable for attachment.

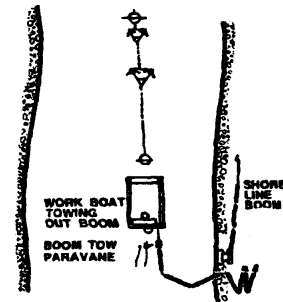

Step 8

After the river boom is attached to the anchor, attach shoreline ropes or cables to the boom.

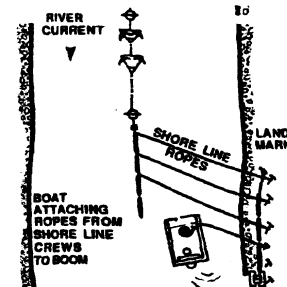

Step 9

After the shoreline ropes or cables are attached, pull the boom toward the shore. Ensure that the angle of the boom doesn't exceed the critical angle.

Step 10

Burn is conducted once boom is in place. After the burn is complete, boom and anchors are removed and all equipment cleaned and returned.

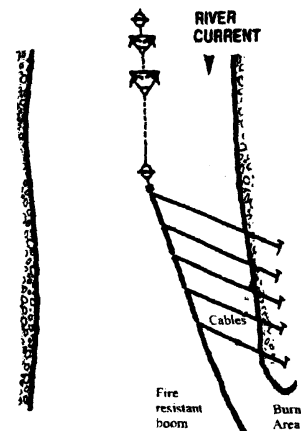

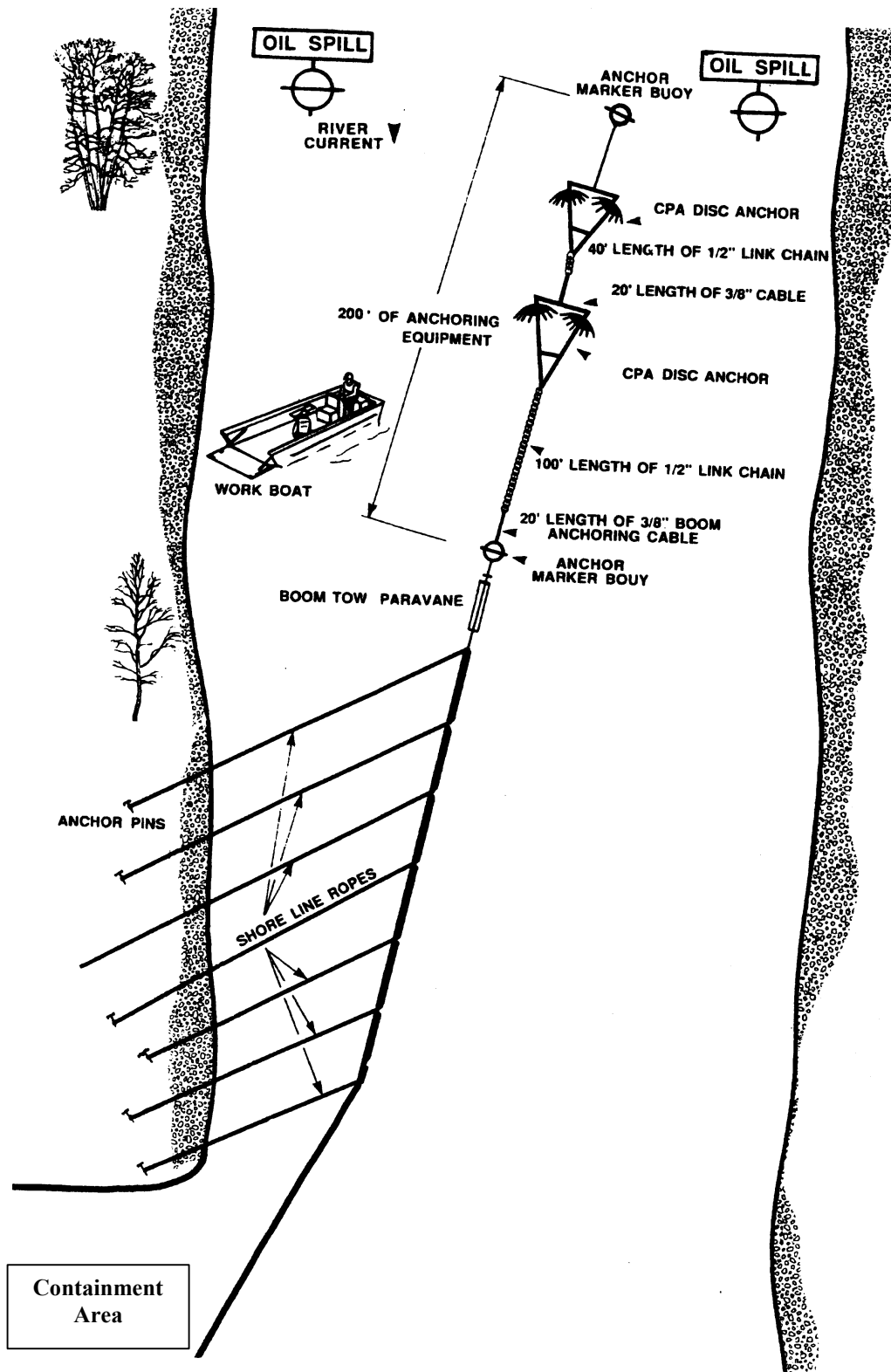

Figure 5-11. River boom deployment schematic.

CHAPTER 6. SKIMMING TECHNIQUES

Environmental damage and cleanup costs are much more extensive once oil drifts ashore dictating that every effort should be taken to collect the oil while it is still on the open water before beaching. The figures in this section are not complete enough to show all of the details of a particular technique or skimmer. The manufacturers will be able to provide additional details concerning individual units. General information about skimmers that have been designed and evaluated is contained in reference (Schulze, 1998). The ASTM evaluation is contained in [Appendix L](#). Environmental conditions will vary so planning and training should be conducted to determine which individual methods works the best for the typical scenarios expected to be encountered.

6.1 Fast Water Skimmers

High-speed skimmers are devices that can collect and remove oil from the surface water flowing at a relative velocity of one knot or greater to the skimmer. They can be used in a stationary mode in swift currents or as high-speed advancing skimmers. Several representative types of skimmers are presented that have proven successful at oil removal in fast currents. Inclusion of a skimmer type or brand is not an endorsement of that skimmer or company. Exclusion of any type or brand of skimmer does not necessarily mean it cannot be effective in swift currents.

6.1.1 V-shape Boom with Attached In-line Skimmer

The V-shape boom shown in [Figure 6-1](#) is kept in shape by nets attached to the foot of the boom. Faster skimming speeds are attained by attaching an in-line skimmer to an open apex. The boom can be deployed in a VOSS configuration with outriggers or towed by two smaller boats. V-Shape boom is built by NOFI Tromso AS and is sold by All Maritime of Bergen Norway as the Vee-Sweep™. A similar product called Fast-Sweep™ is manufactured by Oil Stop, Inc. of Harvey Louisiana. A variety of floating skimmers can be placed within the closed apex if an in-line system is not available. A vessel using a similar arrangement is shown in [Figure 6-2](#).

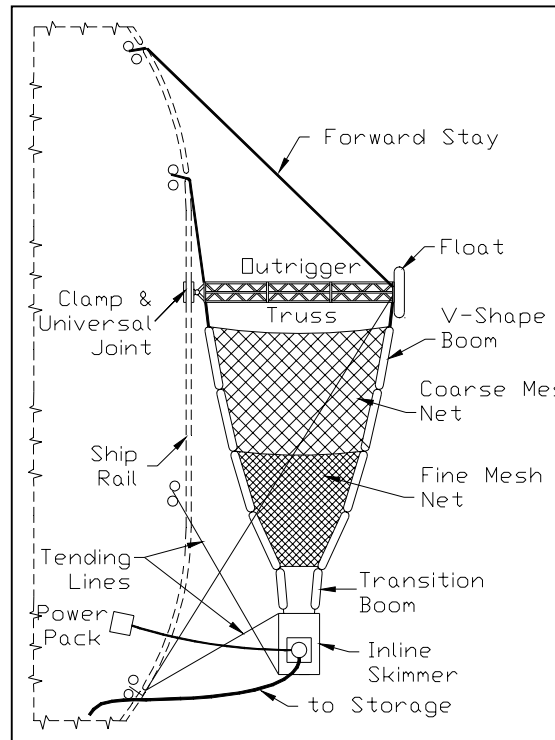

Figure 6-1. In-line skimmer attached to V-shape boom in VOSS configuration.



Figure 6-2. USCG VOSS system.

6.1.2 V-shape Boom with Tapered Channel Separator

A wide mouth (20-meter) V-shape boom keeps its shape in fast water by a net attached to the bottom of the skirt. A tapered separation channel and storage area capable of holding 20 metric tons is attached to the open apex of the boom. This system is designed to operate at speeds up to four knots either moored in a current or advanced by two vessels as seen in [Figure 6-3](#). This maneuver is very difficult unless practice and training are conducted with the individual vessels and their operators. The inflatable boom has a high freeboard and reserve buoyancy that is suitable for use offshore, in bays and on large navigable rivers with waves. It can accommodate several different types of floating skimmers in the temporary storage chamber or it can be used without a skimmer. The storage chamber has a slotted fabric bottom that regulates water escape out the bottom and limits oil entrainment escape. Caution must be taken to prevent the net from snagging the bottom in shallow water. The system was tested at Ohmsett in 1999 and collected over 88 percent of the oil encountered in calm conditions at 3.5 knots (DeVitas, Nolan, and Hansen, 2000) ([see Figure 6-4](#)). The equipment was also evaluated by the Canadian Coast Guard in February, 2000 (Counterspill Research, 2000). The qualitative tests indicated that the system could operate in 20-knot winds and at speeds up to 4-5 knots. It is produced by All Maritime of Bergen, Norway and is distributed in the United States by Applied Fabrics Technologies, Inc. of Orchard Park, New York.

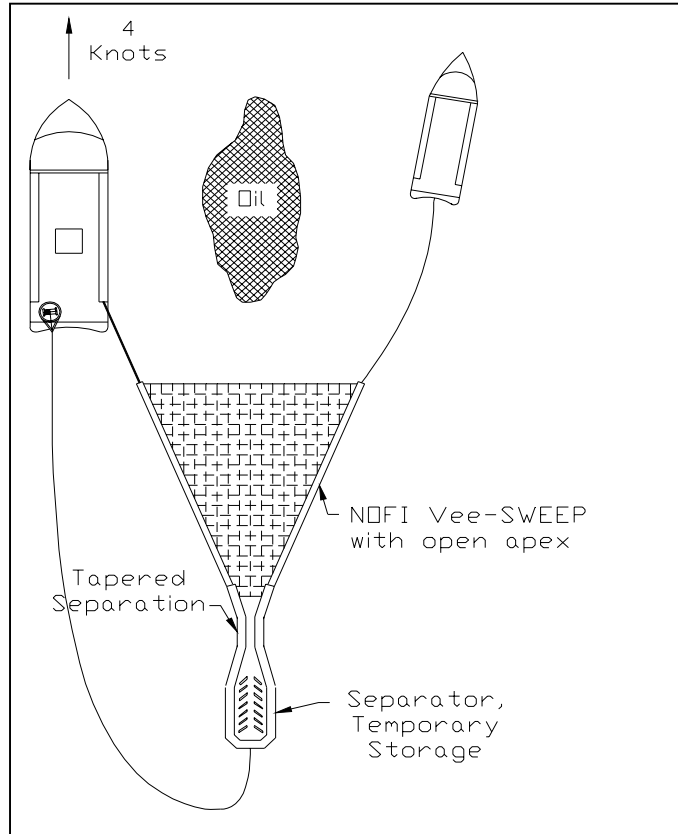

Figure 6-3. The NOFI Vee Sweep™ with tapered channel separator.



Figure 6-4. NOFI Current Buster™ in Ohmsett tank.

6.1.3 Wide-Mouth V-Shape Boom

Using Cross Bridles with Attached Skimmer

Wide-mouth boom can also be held in shape with cross bridles (Coe and Gurr, 1999). These should be fabricated of premeasured chain or wire cables. They can be used as advancing collection systems with attached skimmers and anchored in currents as seen in Figure 6-5. This is a difficult configuration to safely deploy in higher currents. A shallow-draft transition boom allows water to escape thus reducing the flow velocity of oil into the attached skimmer. A self-propelled skimmer can tail behind the boom in lieu of the attached skimmer when being operated in an advancing mode.

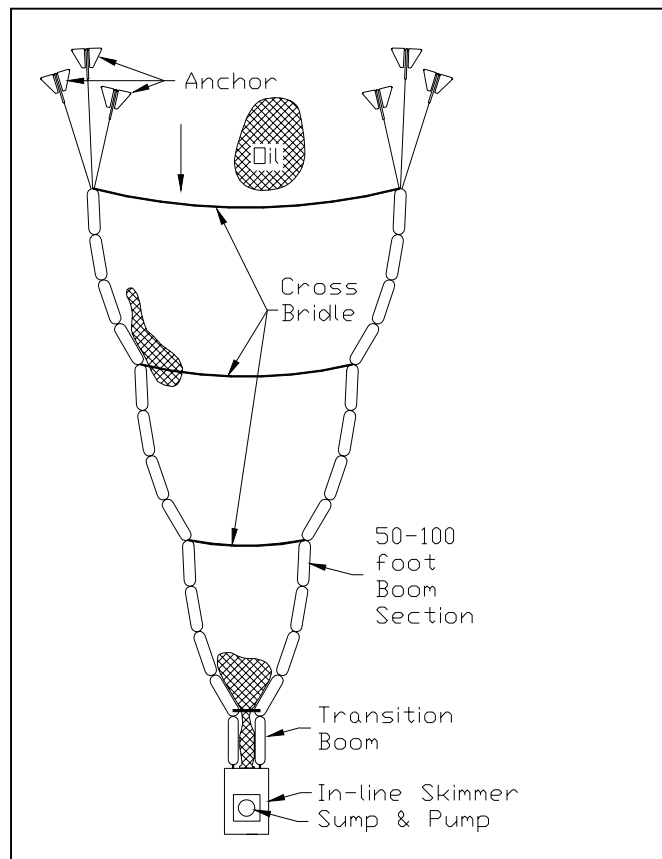

Figure 6-5. Wide-mouth V-shape boom with attached skimmer.

The speed limitations are dependent upon the angle of the boom and the effectiveness of the skimmer. The liability of this type sweep system is that the long bridles take time to deploy and can also snag on the bottom. Bridles may also cause discontinuities in the boom shape causing eddies and premature oil entrainment where they attach to the boom.

Using Boom Deflectors and a Trailing Skimmer

Wide mouth V-Shape containment systems that use boom deflectors (see Section 5.5 Boom Deflectors) to keep their shape have several advantages over the bridle system. There are no long bridles to snag on the bottom or to rig during deployment. This allows the sweep to be deployed more quickly. The design also provides more flexibility and maneuverability for the boats to open and close the mouth of the sweep as required for oil collection or debris avoidance. When a trailing skimmer configuration is used, two drogues are needed at the end of each boom to provide resistance to keep the boom from forming a U-shape at the apex opening, Figure 6-6. The trailing skimmer collects the oil that is concentrated by the deflection boom. This assists with maneuverability of the system and offloading logistics. The self-propelled skimmer can also tow a barge or temporary storage device for added capacity. Short 50-foot sections of boom are required with boom deflectors for optimum performance. Trained personnel should determine towline and boom lengths using the actual equipment involved.

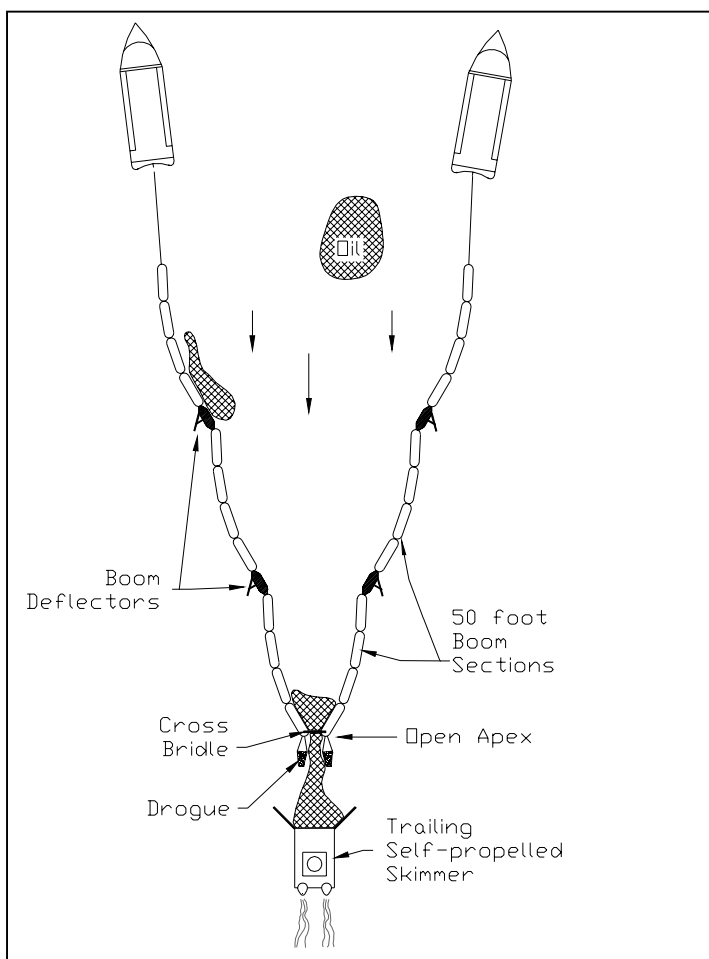

Figure 6-6. Boom deflectors and wide-mouth V-shape sweep systems.

6.1.4 Inclined Plane

Inclined or submergence plane skimmers force the oil to follow an incline below the surface of the water. The buoyancy of the oil causes the oil to rise and separate from the surrounding water. These skimmers are usually more effective in waves because the oil is displaced from the surface of the water before separation. Both light and viscous products are collected efficiently. There are two types of inclined plane skimmers, static and dynamic, as seen in Figure 6-7.

Static Inclined Plane

The static inclined plane skimmer consists of a fixed incline at the bow. It separates oil during three phases while advancing or held stationary in a current. It can operate in 1 to 5 knots and is effective in both light and viscous oils. It is not effective in static conditions. If the oil is very dense, it may go under the collection well during high-speed operation due to its limited buoyancy. The skimmer, as shown in Figure 6-8, uses a hydrodynamic induction bow foil that assists with oil entry down the plane. It helps reduce bow wave interference. At speeds above 3 knots, operation is recommended without deflection boom or with a short shallow-draft deflection system. The Hydrodynamic Induction Bow (HIB) skimmer has no moving parts except for the pump, so reliability is high and maintenance is low. It can be configured as a VOSS skimmer with or without a side sweep system, as an inline skimmer in the apex of a boom or as a self-propelled unit. Hyde Marine Inc, of Cleveland, Ohio, distributes it as the Hydrodynamic Induction Bow (HIB) skimmer. It is available in several lengths and displacements, however, it cannot be used as a portable skimmer.

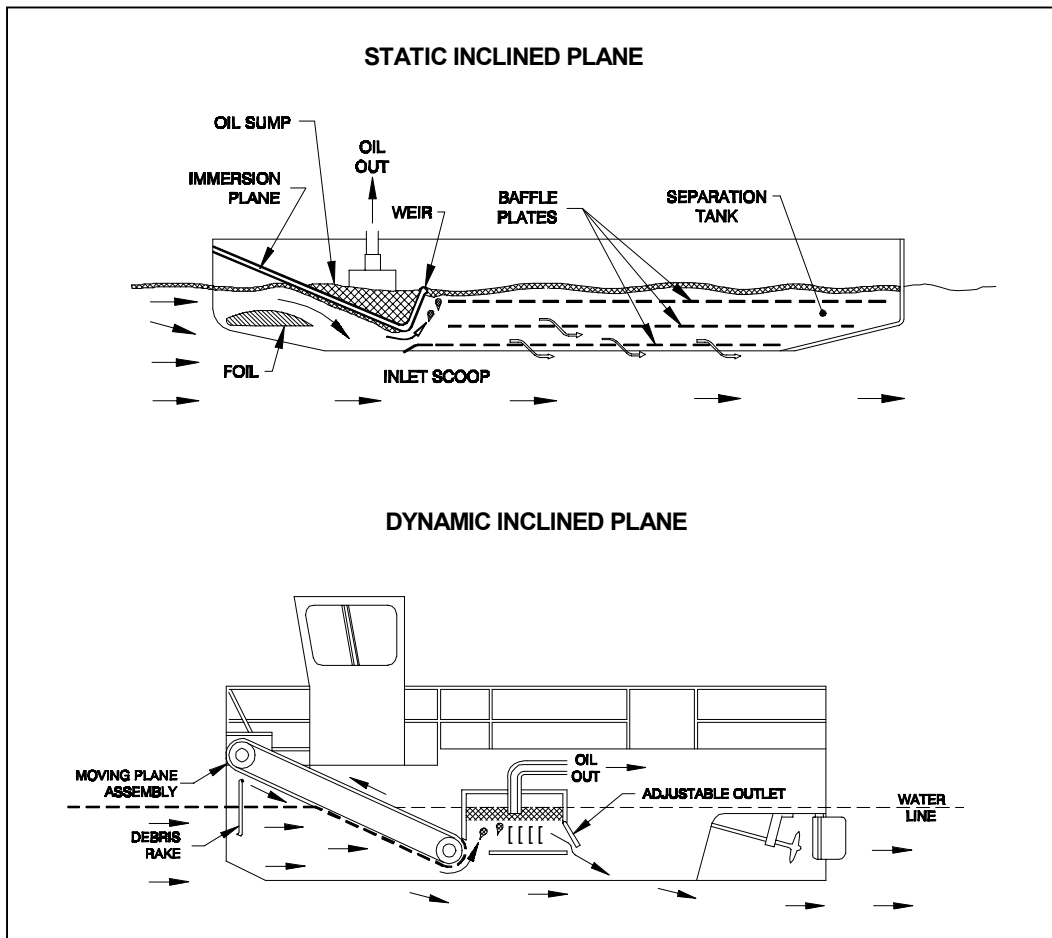

Figure 6-7. Inclined plane skimmers (static and dynamic) (Coe and Gurr, 1999).



Figure 6-8. 28-foot HIB static inclined plane skimmer.

Dynamic Inclined Plane

The dynamic inclined plane (DIP) skimmer operates at 0 to 4+ knots. A belt is rotated down the submergence plane at the speed of the vessel over the water. This facilitates the flow of oil down the incline and up into the collection well. Although the belt adds mechanical complexity, it allows oil to be collected in stagnant water by inducing flow to the collection well. The DIP has shown to be most effective with heavy oils by collecting over 90 percent of heavy Sundex oil at Ohmsett at speeds up to three knots (DeVitas, Nolan and Hansen, 2000). If the oil is very dense, it may go under the collection well during high-speed operation due to its limited buoyancy. The dynamic inclined plane skimmer is commercially available through Slickbar of Seymour, CT. It has been produced as a self-propelled or drag-along design in various capacities and displacements.

There are many configurations of the DIP skimmer ranging from small portable units to large ships. The USCG recently procured six DIP skimmers for the USCG VOSS (although they are not operational at this time). These High Speed Skimmers attach to the apex of the Fast Sweep™ V-shaped boom (Figure 6-1) as an in-line skimmer (Figure 6-9) in rough water conditions as tested in Ohmsett. A shallow-draft transition boom is used to attach the sweep to the skimmer.

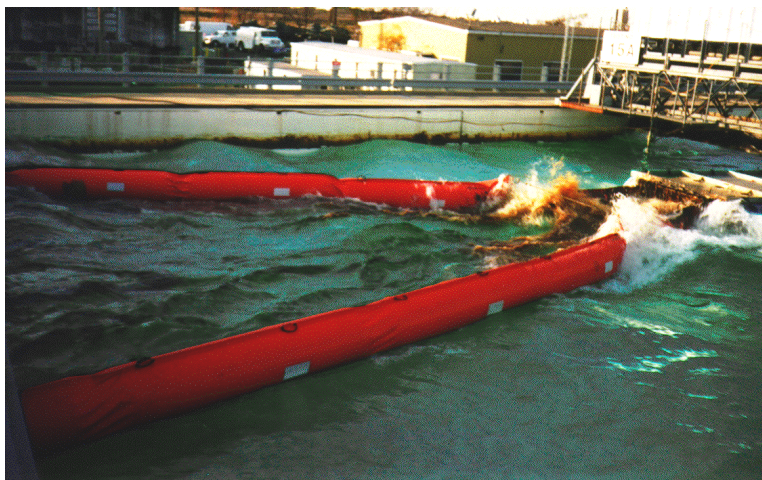

Figure 6-9. Fast-Sweep™ boom with USCG high-speed DIP skimmer.

6.1.5 Rope Mop Zero Relative Velocity (ZRV)

A rope mop consists of oleophilic fibers that are woven into a rope that floats on the surface of the water. A set of ropes is suspended between catamaran hulls as seen in Figure 6-10. They are propelled between the side hulls at the speed of the vessel over the water. Oil adheres to the rope and it is brought aboard where water continues to drop off along the way. The oil is then completely removed from the rope when it is pressed as it goes through a wringer up near the bow of the skimmer. They can recover oil over a wide viscosity range but are most effective with medium to heavy viscosity oils. Mops function well in a variety of wave conditions, in debris and broken ice and are more efficient when recovering heavier oils.

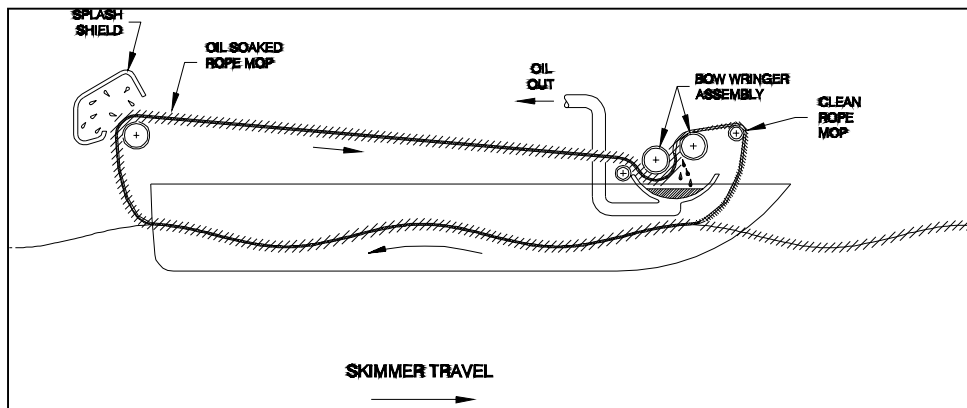

Figure 6-10. Typical rope mop ZRV design (Coe and Gurr, 1999).

Although there have been several types of ZRV skimmers (belt and rope) developed over the years, only the rope mop ZRV is commercially available today. Ro Clean/Desmi A/S of Odense S, Denmark produces a variety of Pollcat rope mop ZRV skimmers in multipurpose workboat configurations. Oil Mop Inc. (OMI) of Belle Chasse, Louisiana also manufactures a variety of these skimmers including smaller portable units.

A prototype rope mop system call the Stream Stripper was developed by Ro Clean/Desmi and tested at Omsett in 2000 (Hansen et. al, 2001). It is a lightweight system that is 19 feet long and has 13 mops mounted between two catamaran hulls. The mops can be powered by a paddle wheel mounted at the stern or a hydraulic motor mounted at the bow. Throughput efficiency was over 80 percent for heavy oil at three knots. At four knots, the paddle wheel arrangement recorded TE performance of over 60 percent. It is not commercially available.

6.1.6 Expansion Weir

The expansion weir uses several methods to remove and separate oil in a fast current. A diversion boom funnels oil into the narrow mouth of the skimmer. A surface slice is taken using a deflector to separate the concentrated oil from the water below. The water is forced to expand into a larger collection area that causes the velocities to slow, facilitating gravity separation of the oil. A floating weir lip further separates the oil from the water in a sump in the aft section of the skimmer where a pump or suction hose removes the oil. Water exits just forward of the weir towards the rear of the skimmer, which is controlled by a manually adjustable hydroplane. Vikoma International of Isle of Wight, United Kingdom manufactures the Fasflo skimmer (Figure 6-11). Two different sizes are available for rivers and coastal applications. This system was evaluated at Ohmsett in 1999 and performed well up to 2 knots (Devitas, Nolan, and Hansen, 2000).

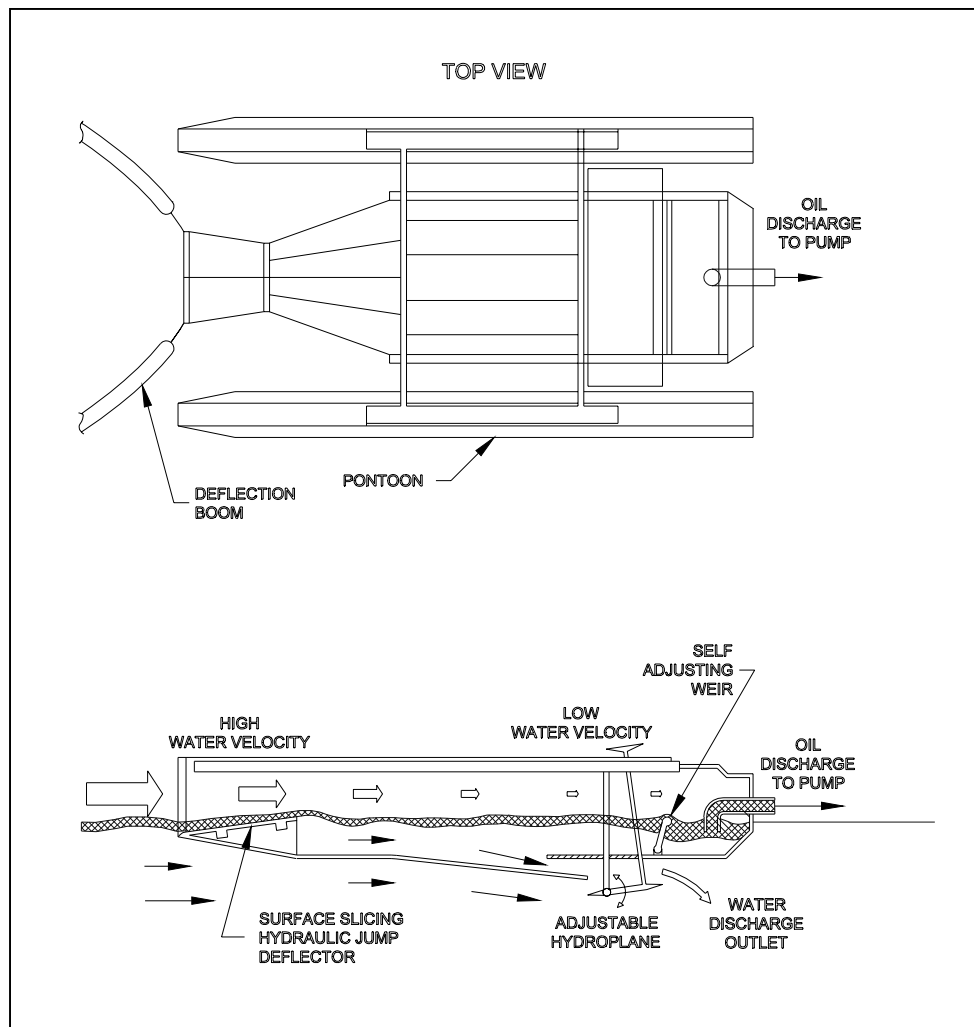

Figure 6-11. Fasflo expanding weir skimmer (top and profile view).

6.1.7 Circulation Weir

A quiescent zone circulation weir skimmer called the Blomberg High Speed Circus can be used for high-speed sweeping or as a stationary system deployed in fast flowing waters to collect and concentrate oil in an artificial lagoon that facilitates oil recovery with a high recovery efficiency (PROSCARAC, 1992). It is operated as a

rotation chamber for oil/water separation. The Circus is used with a boom off one side that deflects oil into the circular lagoon as seen in the VOSS configuration, [Figure 6-12](#). The boom was recently developed by Blomberg Offshore AS of Frolunda, Sweden. It is distributed in the United States by QualiTech Environmental of Chaska, Minnesota and overseas by ORC of Frolunda, Sweden.



Figure 6-12. Blomberg High Speed Circus on a VOSS.

The shallow guiding boom has a draft about one half the height of the entrance opening in the side of the skimmer and the skimmer has a bottom plate that prevents fast flowing water below it from entraining the oil out of the protected lagoon. This configuration allows the water to exit under the boom while oil remains in a circular pattern on the surface ([Figure 6-13](#)). The oil is forced to the center of the lagoon where it is removed by a floating weir lip attached to a positive displacement screw pump or suction hose. This system is designed to function in 0.5 to 3-knot currents and is available in several sizes. It can also be used on the side of a riverbank, bulkhead or along a coastal area. The concept has also been incorporated into a catamaran vessel. This system recovers oil that enters between the hulls using deflectors to divert oil into two hull quiescent chambers. It is also equipped with an automated debris removal system as a dual-purpose vessel. A small version of this system was tested at Ohmsett with good results at 2 knots (DeVitas, Nolan, and Hansen, 2000).

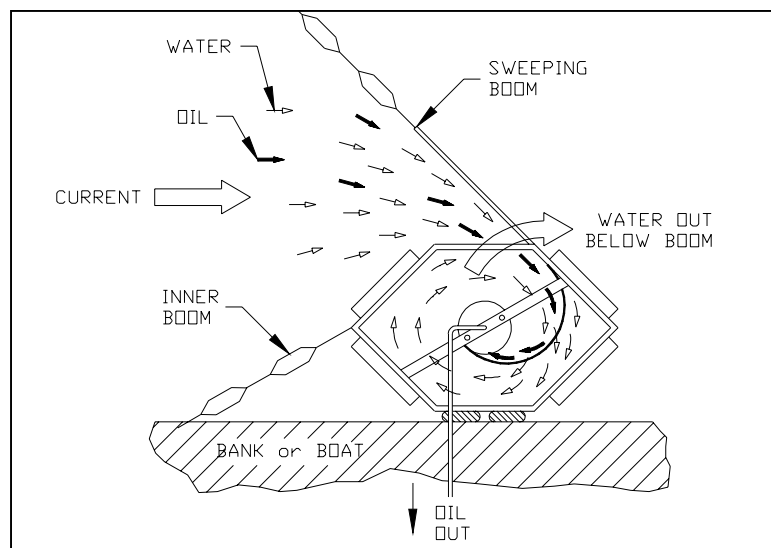

Figure 6-13. Blomberg High Speed Circus shelters oil from the current.

6.1.8 Recovery Channel with Conveyor Brush

The Lori skimmer uses an oleophilic brush-conveyor system that rotates up into the slick to pick up oil and debris on the bristles of a brush. Several continuous loop brushes are mounted on chains. Oil is scraped and squeezed off the brushes by finger-like cleaners at the top where the oil is gravity fed into a sump and storage tank. The skimmer is effective in higher currents because the area where the brushes contact the oil is protected from entrainment in a recovery channel that has a bottom plate. The oil is deflected into the channel by the hydrodynamic flow of the water through the rotating brush conveyor. Clarified water recirculates back to the collection area. The channel is located inside a dedicated skimming vessel (Figure 6-14), or inside a removable side collector unit for VOSS applications. These skimmers are effective in currents up to 3 knots. They recover heavy oil and emulsions very well, but are less effective in light and medium viscosity oils (Mar, Inc., 1994). Recovery efficiency is high and brush skimmers are not adversely affected by waves. The Lori Skimmer is manufactured by Oy LMP Patents Ltd. AB of Loviisa, Finland and distributed in the United States by Hyde Marine, Inc. of Cleveland Ohio.



Figure 6-14. Lori Brush Skimmer in dedicated skimming boat.

6.1.9 Lifting Filter Belt

A lifting belt skimmer uses a porous oleophilic belt that rotates oil up an open incline. An induction pump behind the belt helps draw the oil into the system as water passes through the belt and oil is deposited on it, [Figure 6-15](#). The oil and debris are scraped and squeezed off the belt at the top where oil flows into a collection well and a screen catches debris. The flow created by the induction pump also permits oil collection in still water. These units, manufactured by Marco Pollution Control of Seattle, Washington, are usually self-propelled advancing skimmers. They can skim up to 3 knots but effectiveness drops off above 2 knots. The downward slope of the belt tends to force the skimmer down into the water at higher speeds (Lichte and Breslin, 1998). The type of oil that these systems can handle is dependent upon the belt that is installed.

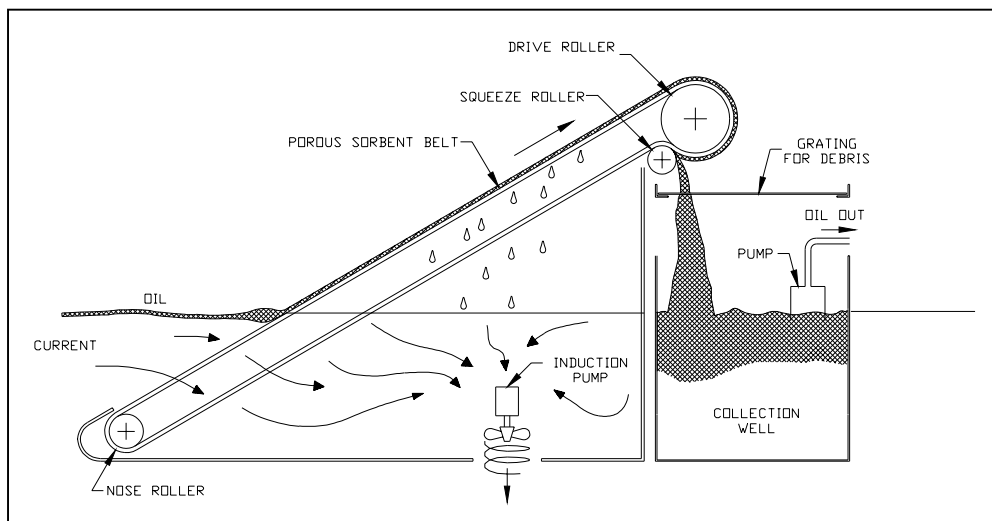

Figure 6-15. Filter Belt™ skimmer design.

CHAPTER 7. SPECIAL CONDITIONS/ALTERNATE TECHNIQUES

There are some conditions in which standard booms cannot be used. These include areas with ice or other debris or obstructions. This chapter describes some alternate techniques that may be useful in those situations. More information on responding to spills around ice is contained in references (Coe and Gurr, 1999) (Arctic Council, 1998).

7.1 Oil Under Sheet Ice

The scenario to remove the oil is to deflect it to a collection trough or opening cut in the ice. A current meter can be inserted into these holes sequenced across the river to determine the current profile for selection of the proper boom and slot diversion angles to prevent oil entrapment. Current measured just below the ice should be used for determining the deflection angle used (see Figure 3-1). Exploratory holes should be drilled to determine the proper bearing capacity of the ice sheet using the appropriate safety chart before heavy equipment or personnel are deployed. Oil velocity under and adjacent to the ice is less than the average water velocity below it.

7.1.1 Trenching Ice

The technique of cutting long slots approximately four feet wide through an ice sheet 28-inches thick at a 30-degree or less angle to the current has proven to be an effective method for capturing oil flow under a thick sheet in a one knot current (Figure 7-1) (Allen, 1979). The oil flows down the slot to the downstream end where it can be recovered with a skimmer. A second slot angled to the opposite side of the river will provide complete coverage. Usually a chain saw with a 48-inch length is needed to cut the ice. The engine may need extra care to be protected from getting wet. The effectiveness of oil collection in slots cut in thin ice in the field is unknown. However, cutting slots in thin ice will alter its structural properties and should only be done using extreme caution (Figure 7-2).

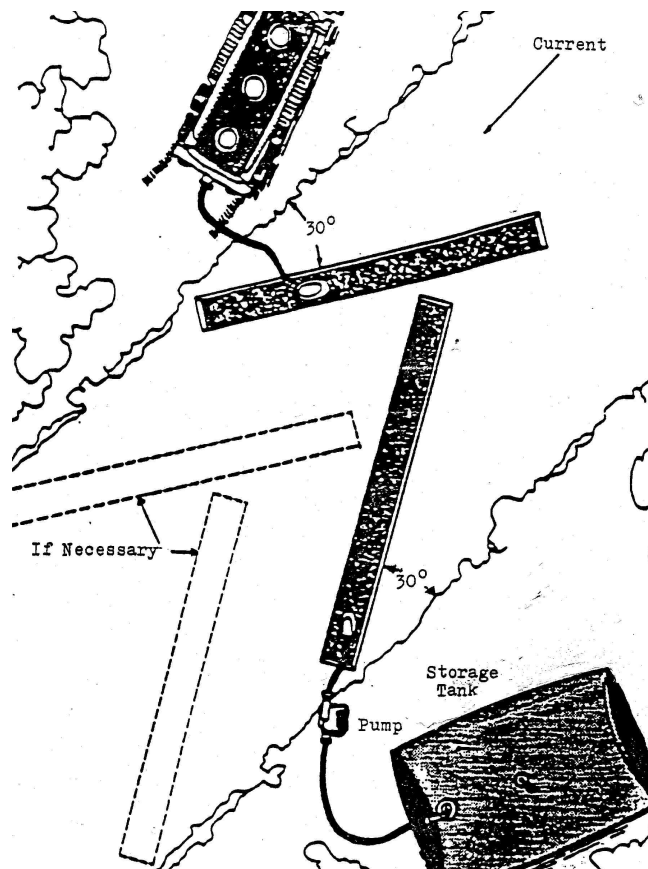

Figure 7-1. Slots cut in ice for oil recovery.

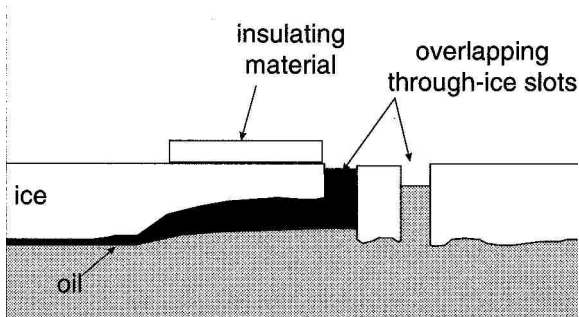

Figure 7-2. Cross-section of ice slots.

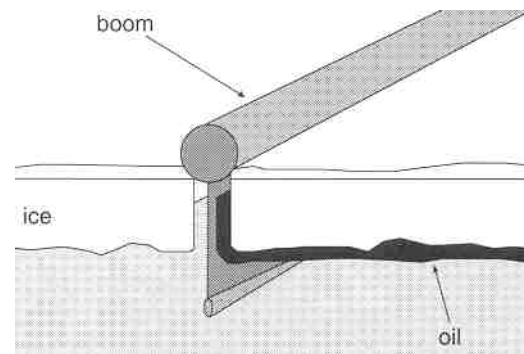

Figure 7-3. Boom deployed in ice slot.

Plywood or booms (see Figure 7-3) can be used as diversion booms in sheet ice. Two 2 by 4-inch boards are nailed on opposite sides along the length of the sheet at the desired height of the boom. A diversion slot is cut perpendicular to the ice sheet slightly larger than the width of plywood sheet thickness. The sheets are then slid into the slots so that they extend approximately one foot into the water below the ice. This technique can be used to divert oil into the ice slot described above or to shore where the ice is cleared for collection and skimming operations.

7.2 Oil in Broken Ice

The strategy response to oil in broken ice is similar to that used in debris conditions. Inflatable boom is susceptible to punctures from sharp corners on the ice, so foam-filled boom or rigid structures are recommended. The coverage of broken ice on water may prevent the use of conventional boats. Boom fabricated from logs have been used in a diversionary mode to create a clear area for oil containment with conventional boom downstream on small rivers with light ice cover (Telford and Quam, 1979).

7.3 Sorbent Applications

Conventional sorbent boom is used for recovery of trace amounts of oil and sheen in stagnant or slow moving water or as some call it, a "polishing technique." They are typically made with limited strength that cannot withstand drag forces associated with swift currents. Their conventional cylinder boom floatation design limits oil collection due to the freeboard and draft away from the thin oil contact waterline and the blocking effect of oil laden sorbent material. Very often only about a one-half inch strip of sorbent near the waterline on the upstream side absorbs oil. Oil is then blocked from penetrating the sorbent material and it entrains under the boom at currents above 0.7 knots as it starts to accumulate in the apex of the boom. Standard melt blown polypropylene (MBPP) boom or pad only picks up seven percent of its total oil sorption capacity while dragging out up to ten times its weight in water. The majority of sorbent material never sees the oil. Mostly water is absorbed or trapped in the boom sorbent material adding weight and drag to the system. Operators find it very difficult to remove water and oil saturated sorbent boom due to its tremendous weight.

Shorter draft is better when it comes to deflection boom. The objective is to move the oil on the surface, not block and deflect the water below it. In the deflection mode at steep angles, oil will not build up against a deflection boom, but it will move downstream against it close to the boundary layer. Shallow draft sorbent boom can be used to deflect oil in high currents. Sorbent deflection boom that is reinforced with a tension member has proven effective deflecting oil in currents up to three knots with deflection angles much larger than predicted. Tests have also been carried out on sheet type sorbents and have shown them to pick up twice their weight in oil at speeds up to three knots (Hansen, DeVitis, Potter, Ellis and Coe, 2001). The sheet boom is designed to reduce drag and increase the surface area contacted by the oil (Figure 7-4). These are made by MYCELEX Technologies, Inc. of Gainesville, GA.

Sorbent sheets or pom-poms can also be used in some situations. If moderate currents exist, these can be staked into the ground and recovered on the next opportunity or tide.



Figure 7-4. Sheet absorbents at 3.5 knots.

7.4 Alternative Methods of Containment or Exclusion

7.4.1 Pneumatic Boom

Pneumatic boom consists of a pipe or hose submerged below the surface of the water that is supplied with compressed air. The air escapes through small holes in the pipe and creates a large number of fine bubbles. The bubbles rise to the surface due to buoyancy, moving water with them and creating a vertical current. The vertical current splits into two currents on the surface moving away from the boom in opposite directions. This surface current will block the approach of oil on the surface of the water as seen in [Figure 7-5](#). Turbulence in the water column can cause oil entrainment.

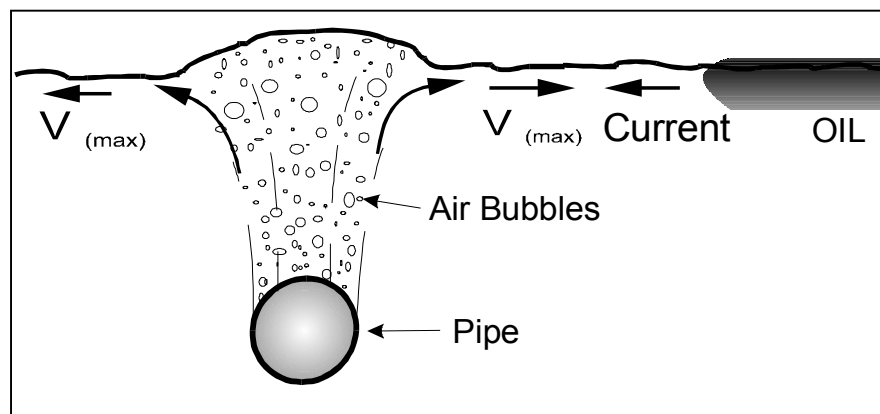

Figure 7-5. Balance of forces between a bubble plume and oil layer.

The maximum surface water velocity, $V_{(max)}$, generated by rising bubbles is related to the airflow rate per unit length of discharge line. In waves, the oil must be kept away from the boom to keep oil from being carried across the

boom by orbital motions in the wave field. A current of one knot can be generated with a modest flow rate of two standard cubic feet per minute per foot of discharge pipe (SCFM/FT). This will require 30 hp/ft in 12 feet of water. Airflow rates above five SCFM/FT are not practical because considerably larger and costlier blowers are required to obtain even marginally greater water velocities (Williams and Cooke, 1985). This would require an excessive amount of horsepower, approximately 75 hp/ft. A 1.3-knot current is created with five SCFM/FT (Figure 7-6). The current produced by a pneumatic boom can also be used in a diversionary mode to deflect oil away from sensitive areas or into a containment area. The stagnation line produced will allow most types of floating debris such as pack ice and logs to pass through while maintaining its oil deflection capabilities.

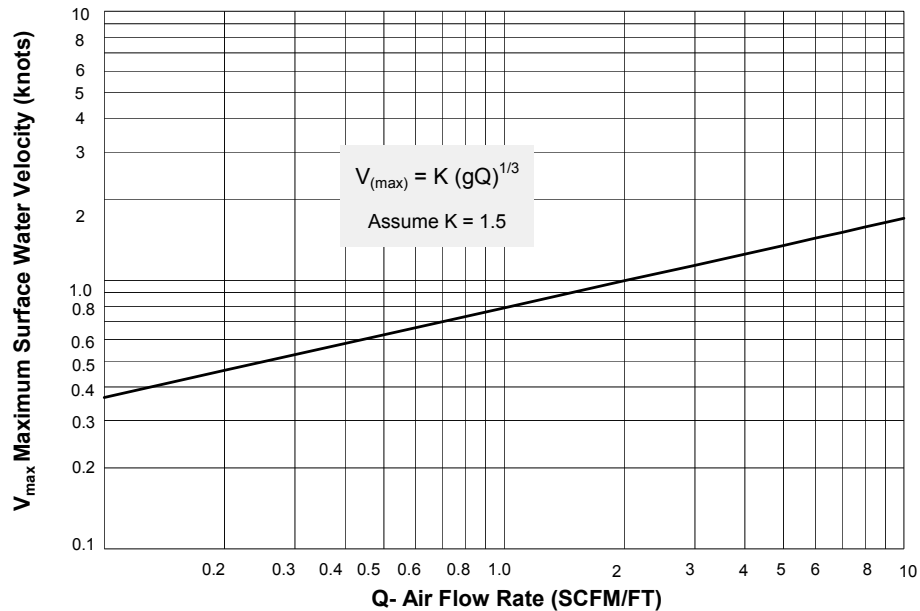

Figure 7-6. Airflow needed for specific currents.

This type of system is best suited for permanent installations around vessel traffic areas or fuel transfer piers for currents less than two knots. This way, it can be ready whenever needed. Regular maintenance is required to keep the air compressor or blower operational and the pipes free from silt. Air pipes on land and near the surface of the water will have to be insulated and/or heated for applications in winter icing conditions. Air bubblers have the added advantage of keeping ice from forming above them if they are kept running continuously. The combination of the warmer water from below that is circulated to the surface by the vertical current and the motion of the water prevents ice from forming.

7.4.2 Water Jet

Water jets can induce surface currents and thereby control the flow and direction of oil movement within certain limitations.

Horizontal

High-pressure water is forced through nozzles that are suspended about one foot above the surface of the water. They can be used perpendicular to the water surface or depressed about 15 degrees (Figure 7-7). Tests conducted showed that both horizontal and depressed spray water jets can contain oil in currents up to 1.2 knots (Laperriere, Whittaker, and Yanagisawa, 1987). The depressed jet, however, required 27 percent less pressure but turbulence could occur if pressure exceeds 1,138 PSI. The water spray system is more efficient than the pneumatic boom system because it creates a surface current in only one direction. The water jet system requires much less power to create the same surface current than pneumatic boom, in some cases ten times the power is required by the pneumatic boom (Comfort, Menon, and Noble, 1979). Control of the water pressure to the jets on the downstream side of the pipe can be used to move the arms into position. Fire and garden hoses can also be used to herd oil into the apex of a boom for skimming.

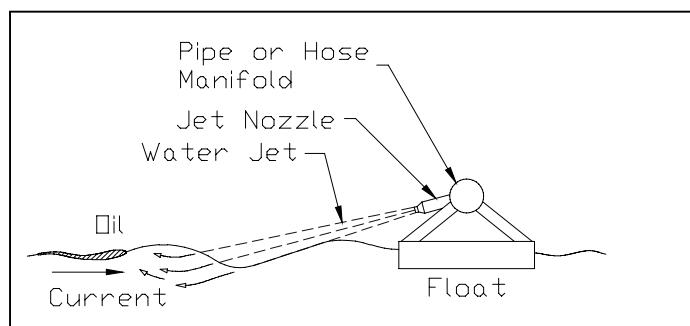

Figure 7-7. Horizontal water jet stops oil in current.

Horizontal water jets can be effective to deflect oil in currents up to two knots in a diversion mode. They may be more effective in permanent installations than deployable free-floating systems. This method may be effective keeping oil out from under piers and low-lying bridges where tidal height fluctuations are less than one foot. They may be most effective as diversion systems suspended in front of high-speed skimmers to concentrate oil into the skimmer and increase its sweep width. Horizontal water jets require maintenance to ensure the jets do not clog or ice up. The high-pressure pump and power pack must also be maintained. Horsepower requirements are approximately three hp/foot of discharge hose with nozzles. Significant logistics are required to transport and deploy equipment needed to use horizontal water jets.

Plunging

A plunging water jet is a high-velocity (35 ft/sec), non-spraying stream of water directed vertically downward into the water. Large and small air bubbles are entrained into the water column. As the air rises to the surface, it creates a vertical current that spreads out in a radial direction on the surface pushing oil away, [Figure 7-8](#). The surface of the water is also higher due to the water entrained by the large bubbles. Small bubbles rise more slowly and continue to contribute to the vertical and radial surface current. Plunging water jets can produce a current that lasts up to one minute. Tests have demonstrated that plunging water jets can be effective as oil deflection devices in front of a high speed skimmer at speeds up to 6 knots (Nash and Johnson, 1981). The jets were most effective when suspended 1.5 to 3 feet above the water. Plunging water jet tests in the St. Claire River, Detroit, were able to divert oil 13 feet in a 4.2 knot current and 35 feet in a 1.6 knot current (Farlow and Cunningham, 1993). Deployment tactics also include boats anchored at a diversion angle with each boat deploying one plunging water jet over the side. This deflects oil in a cascade effect away from a sensitive area or toward a containment area.

Plunging water jets are most effective suspended from vessels to deflect or concentrate oil. They can also be used in permanent installations such as under piers and low-lying bridges to prevent oil passage. They have relatively low power requirements compared to horizontal high-pressure jets and pneumatic boom. Maintenance is required for the pump, hoses and power pack; however, the jets are less likely to be clogged with larger orifices than horizontal jets.

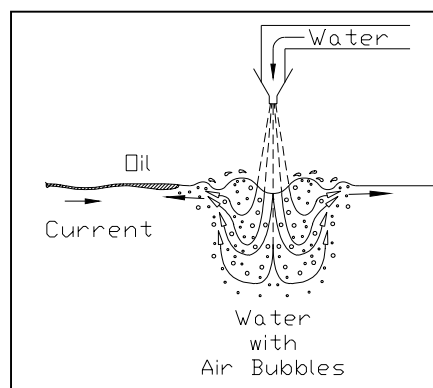

Figure 7-8. Plunging water jet creates counter current to stop oil.

Air jet

An air jet directed at 45 degrees to the surface of the water will move oil on the surface by means of induced water current, [Figure 7-9](#). A linear series of low-pressure air jets supported by a float or suspended by a structure from a boat or skimmer forms a line that will repel oil. The air jet system can be set at an angle to the advancing current in order to divert the oil to a collection system. Air jets directed horizontally can also be used to induce surface currents from a slightly submerged position. Air jet tests conducted from a prototype skimmer required one horsepower per linear foot and showed success at speeds up to 2 knots. However, turbulence was associated with the bow wave of the submerged jet (Freestone, Anderson, and Trentacoste, 1975). Tests of an air jet oil boom were successful in diverting oil at 3 knots with 85 percent efficiency when deployed at an angle of 30 degrees to the current (Cohen, Lindemuth, and Farlow, 1979). In 4-foot waves performance only degraded 5-10 percent. The 33-foot long boom had a shallow draft and low drag. Nozzles were positioned four inches above the surface of the water. The air boom airflow requires low-pressure, high volume air.

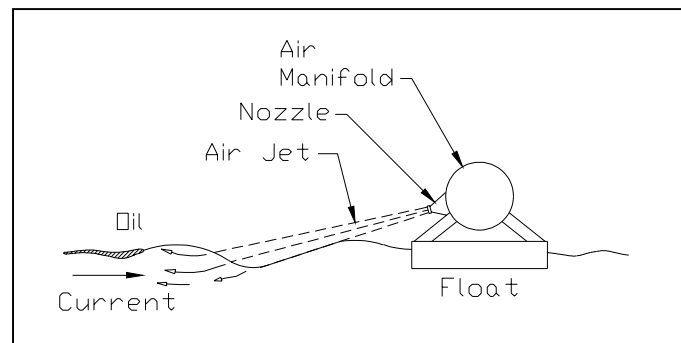

Figure 7-9. Air jet induces water current to stop oil.

This technology is suited for diversion systems in currents up to three knots and in waves. It can be adapted to skimmer systems or used as a stand-alone oil diversion system. Air jets are less likely to clog and fail than water jets and submerged pneumatic boom. Gas powered leaf blowers can be used to move oil away from sensitive areas or into the apex of a boom to facilitate skimming.

7.5 Other Flow Diversion Techniques/Issues

7.5.1 Moored Vessels and Barges

In emergencies when boom is not available, vessels and barges can be substituted to divert current flow and oil into natural collection areas or away from sensitive areas. Generally, bow and stern anchors are required to maintain the desired position. Vessels can be cascaded similar to boom tactics to move oil in the desired direction, [Figure 7-10](#). The vessel should be anchored at an angle to the current to be effective. It will function like a boom and oil will entrain under a boat when the current perpendicular to the hull exceeds approximately 0.7 knots. Use [Figure 3-1](#) as a guide for angle determination at maximum currents expected.



Figure 7-10. Barges deployed on Mississippi River.

7.5.2 Ship Propeller Wash

The water propelled from the stern of a ship or boat while it is moored, will influence the surface current and oil. This technique can be effective to keep oil away from piers, water intakes or other sensitive areas. It is not recommended in shallow areas where the turbulence may mix sediment into the oil causing it to sink. Excessive power may cause turbulence and force the oil to disperse into the water column.

7.5.3 Log Booms

In some river areas, large amount of floating logs may be available. These usually have very little draft so they need to be deployed in multiple locations or with angles shallower than those given for standard boom in [Figure 3-1](#). These can be very useful in capturing debris before it reaches the boom. Boats must be available to periodically clear the debris to permit water to flow under the logs and facilitate oil movement along the boom.

7.6 Flow Diverters

Flow diverters are comprised of a series of paravanes or wing-like hydrofoils positioned vertically. With the control cables anchored, the Flow Diverter (Patent Pending) system can be launched into the current and “flies out” into a steady state angle to the current and deflects the surface water and thus the oil with it.⁴⁰ Small debris can pass through them and the oil is diverted according to the angle of attack. Field tests on the St. Lawrence diverted over twice as many plastic pellets as the regular flow into a low current area. A conceptual cascade technique is shown in [Figure 7-11](#) (Eryuzlu and Hausser, 1977). Tests were performed in June of 2000 at Ohmsett. During these tests, four diverters ([Figures 7-12](#) and [7-13](#)) were shown to move oil as much as 19 feet to the side at 5 knots (Hansen, DeVitis, Potter, Ellis and Coe, 2001). This type of equipment can also be deployed from a boat to divert oil into its wake where a trailing skimmer can recover it. More work needs to be done to refine the system because the existing prototype entrains a significant amount of oil at tow speeds over 3 knots. CSC Advanced Marine has teamed with Hyde Marine, Inc. to improve and market this system.

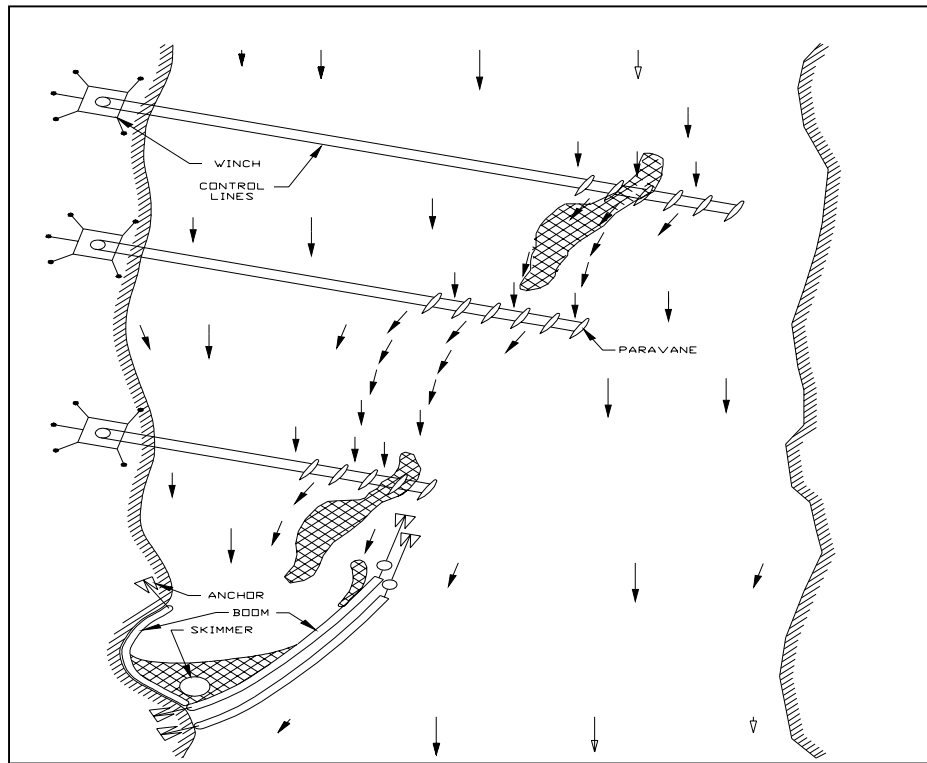

Figure 7-11. Diversers conceptual deployment.



Figure 7-12. Prototype diversers.



Figure 7-13. Flow diverters at Ohmsett.

7.7 Debris

Tactics are required to contain and remove oil in fast currents with both heavy and light debris. Methods to minimize the oiling of debris and to effectively handle and process this oil-coated debris are presented below (Hancock, Jacobs, and Knapp, 1974).

- Double barriers: Two barriers are deployed in parallel. The first barrier retains debris only while the second barrier retains oil in the quiescence zone between them. Foam filled boom is recommended. Log booms or wire cable can also reduce the amount of debris that a diversion boom may encounter.
- Protective barriers: An upstream barrier that allows water and oil passage but retains debris such as snow fence, chain-link fence and chicken wire can be used with added flotation and/or ballast and attached to the existing boom.
- Diversionary booming: Deflection boom is deployed at an angle to reduce the impact damage from debris. Booms deflect debris and oil to calm water areas for removal and disposal.
- Manual tending: Debris trapped in oil pockets and next to skimmers is removed manually with rakes and nets.
- Debris handling equipment: Cranes, front-end loaders, trucks, barges, automated water intake debris screens and specialized debris handling boats are used for removal of big items and large quantities of oil-soaked debris
- Diversionary water jets and propeller wash: The current moves debris away from collection points.
- Debris and logjams: Diversionary containment boom can be positioned downstream of the jam and collect oil that entrains under the jam.
- Boats: Used to collect debris at a location upstream so that the boom is not threatened.

Transportation of collected debris is accomplished with trucks, boats, barges and sometimes aircraft. The debris must be put in watertight containers or wrapped in plastic to prevent further oil leakage during storage and transportation. Debris should be incinerated near the collection site when a permit can be granted in order to reduce handling costs.

CHAPTER 8. SUPPORT EQUIPMENT

Support equipment in fast-water spill response is geared to delivering and deploying the recovery systems quickly and safely. This requires strong and sturdy equipment to withstand the forces involved in high current situations. Transportation of equipment and debris is accomplished with trucks, boats, barges and sometimes aircraft. Recovered oil must be stored and transported. Good communications between the field teams, other resources and the command center are essential for effective operations.

8.1 Mooring Systems

To form an effective barrier to the oil, containment booms must be held stationary and kept in a fairly straight line without discontinuities that can cause oil entrainment. Small changes in the deflection angle or shape of the boom due to anchor drift can cause the boom to fail due to oil entrainment. Mooring lines that do not stretch under tension are preferred. Whenever possible, anchoring should be done on shore where more control is available for positioning, moving and selecting secure anchor points. Permanent mooring systems should be positioned at critical locations to reduce the amount of time needed to deploy boom. Fixed structures on the shore should be identified or permanent anchoring systems installed. There are a variety of anchors available and their holding power is variable based on bottom type, weight, anchor type, scope of line, and amount of chain. Various configurations of multiple anchors can be used to increase the combined holding power.

8.1.1 Anchoring

Mooring-leg tension should be held close to the bottom to ensure that the anchor holds properly. This is obtained by using the proper scope of line and the appropriate length and weight of chain. Approximately six to eight feet of chain should be attached to the anchor shaft to keep the anchor at the proper angle for digging in and setting properly. Mooring line legs should be at least five to seven times the depth of water in order to hold in swift currents, as shown in Figures 8-1 and 8-4.

The mooring leg should provide a good horizontal restraint to the boom without pulling it down below the surface in swift currents. A buoy is used about 10 feet from the boom to help prevent downward tension. A buoy, paravane or boom guide (see Figure 8-3) can be attached to the leading edge of the boom if additional buoyancy is needed in swift currents. The guides are usually streamlined to prevent turbulence and vortices that will cause oil entrainment. An anchor retrieval line is attached to the crown of the anchor and has a separate buoy. This aids in positioning the anchor during deployment and breaking the anchor free for retrieval. This buoy should be just large enough to keep it from being submerged by the current. The force of the current on a large buoy could cause anchor failure. Permanent anchoring systems should be designed to handle all conditions that may be encountered. Multiple anchors may be required for tidal and ice conditions. When using multiple anchors, it is usually safer to deploy them separately, using the pull of the boat to ensure each is set.

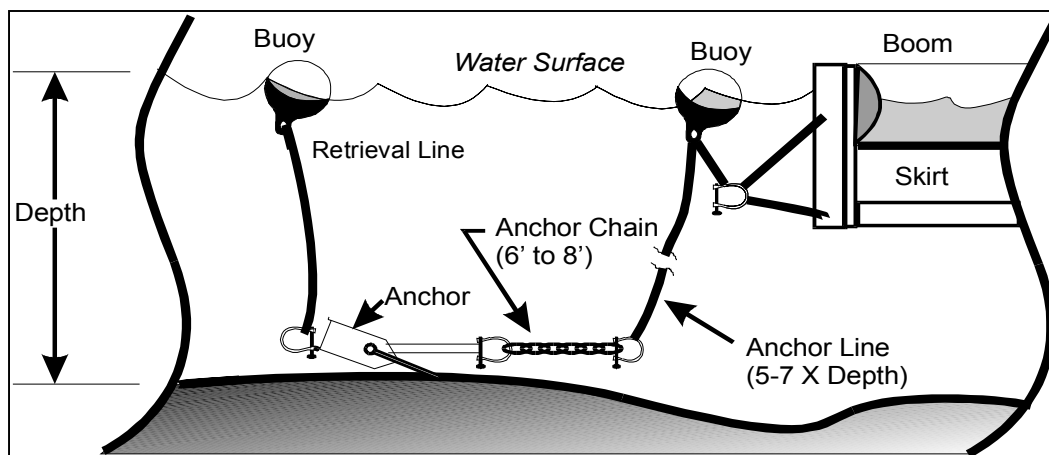

Figure 8-1. Typical boom mooring configuration.



Figure 8-2. Anchor system.



Figure 8-3. Boom guide.

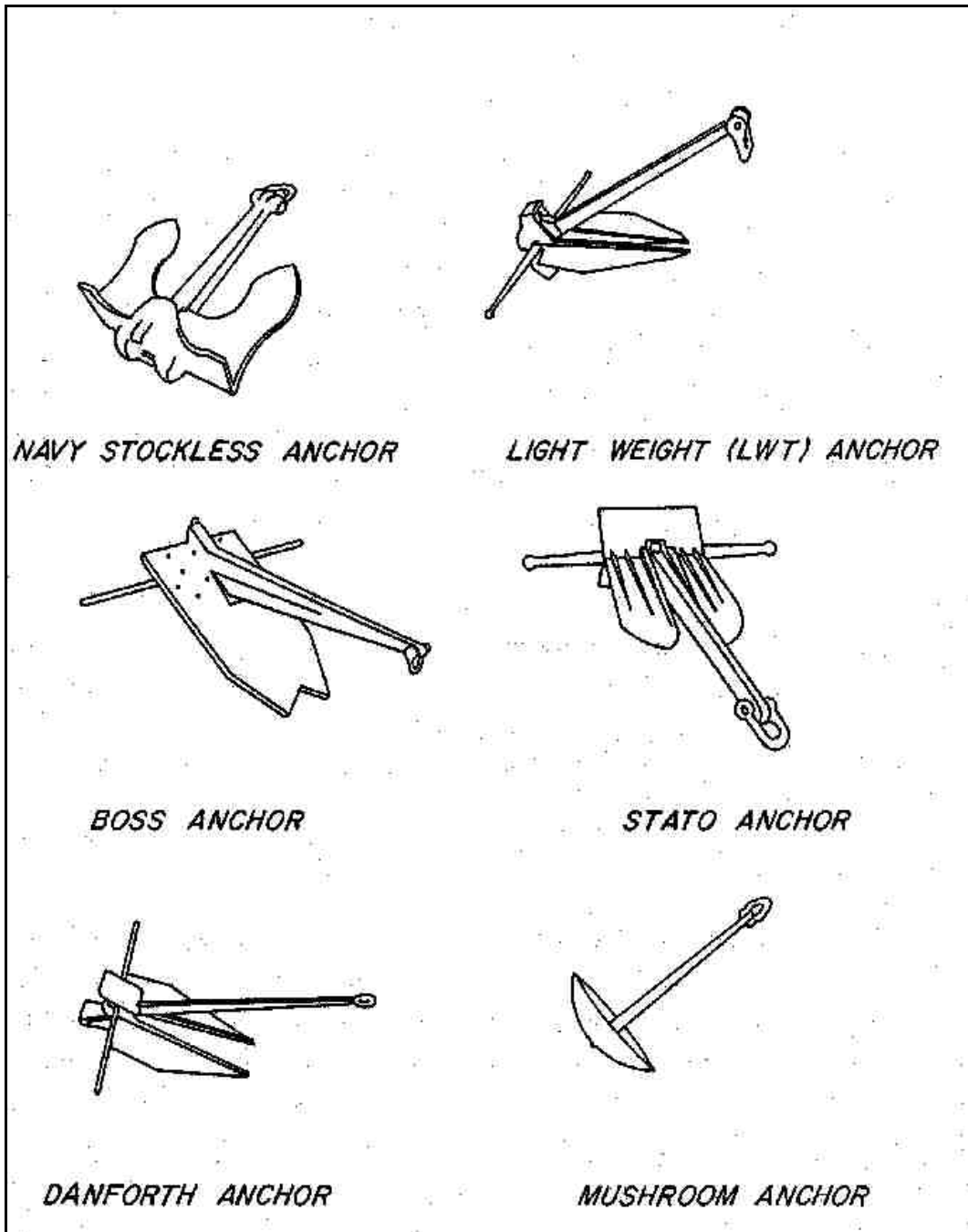

Figure 8-4. Standard anchors (Berteaux, 1991).

The most common anchor found in spill response is an embedment anchor such as the standard steel Danforth®. Specialty type anchors provide greater holding power at lighter weights. Danforth® has specialty anchors such as the High Tensile® and Deepset® that look similar to the standard Danforth® and Lightweight anchor and are more applicable to fast water booming because they have higher holding power and strength. Holding power can be obtained from the manufacturers and some anchors have holding power to dry weight ratios of over 500. Conservative holding power information can be found in Table 8-1 from the U.S. Navy Ship Salvage Manual, Volume 6. Typically, the heavier anchors are used to get the holding power required. Handling the larger anchors is difficult, cumbersome and sometimes dangerous when deploying from a small boat. In some cases, it may be advisable to pay more money for high strength aluminum alloy anchors that weigh about half that of steel anchors

with the same holding power. For example, the Fortress FX-55, a 32-pound aluminum alloy anchor rated at 16,000 pounds pullout force, is used by the USCG for offshore boom mooring packages. Some Cooperatives use them for fast-water booming rivers. They take a little longer to settle to the bottom when deployed compared to steel anchors of similar size. Additional chain or lead weights can be added to get the anchor to the bottom faster. Other anchor types available are shown in Figure 8-4. The mushroom anchor is effective in mud. Holding power can be increased by adding more anchors in line or at angles to the mooring line shackle. A three-anchor mooring configuration on a shoreline is shown in Figure 8-6. This configuration will also allow use of lighter anchors making deployment easier ashore or from a boat in the water. A popular anchor used in many river responses is the rake anchor (see Figure 8-5). This type of anchor can provide a better embedment and is less susceptible to failing.

Table 8-1. Anchor holding power as a multiple of dry weight for 100 pounds (U.S. Navy(a), 1990)

Anchor Type	Soft Soils	Hard Soils
Danforth®/LWT	12.6	31.6
STATO/NAVMOOR	27.7	25-33
Navy Stockless	3.5	11



Figure 8-5. Rake anchor.

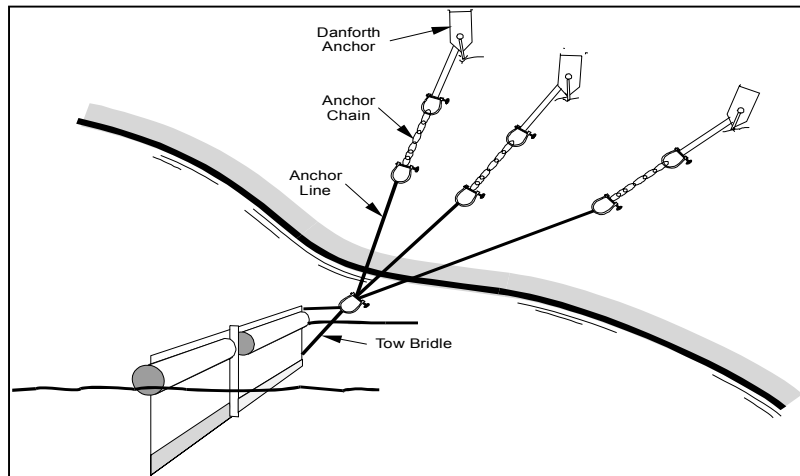

Figure 8-6. Mooring boom with multiple anchors (Alaska Clean Seas, 1998).

Selection of lines is very important for fast-water moorings. Lines that have polypropylene tend to float and thus have less of a chance of snagging on the bottom but may snag debris at the surface. Synthetic lines handle easier than wire so only use wire rope for arrangements that don't require handling or are permanent. Specialty lines such as Kevlar and Spectra may also be used but may be susceptible to abrasion if they don't have a protective jacket. Choose a line that works best for the situation. Some nominal strength values are given in Table 8-2 although the manufacturer's specification may vary. Standard recommendations for working strength are about one-quarter to one-half of these values.

Table 8-2. Nominal breaking strengths (pounds) (U.S. Navy(b), 1990).

Diameter (inches)	Manila	Polypropylene (Three-Strand)	Nylon (Triple Strand)	Nylon (Double Braid)	Polyester (Double Braid)
5/16	900	1700	2300	3400	2400
1/2	2380	3800	5600	8500	5750
5/8	3960	5600	8910	15200	9000
1	9000	13000	23000	26500	26800
2	22500	32000	60000	74000	69900

8.1.2 Shoreline

Shoreline moorings are preferred over setting anchors in the water because better selection can be made and control is easier. A big rock, tree or man-made structure can usually handle the required load. The next choices are steel pipes, fence posts or T-stock that can be pounded into the soil. These posts are staggered in line along the booming direction and connected to each other with lines to prevent them from pulling out (Figures 8-7 through 8-9). A fence post hammer is effective and safe for pounding in posts. Use a round turn at the base and top of the aft supporting stakes and a clove hitch at the top of the forward stake. A loop of several turns is used around the bottom of the forward post. A D-ring, bowline or sheet bend is used in the loop for attachment of the mooring line. Attaching floats to the mooring lines will help keep them from snagging on the bottom and makes them visible on the surface.

A log about three feet long and at least 6-inches in diameter can be used as a deadman anchor. The deadman should be buried horizontally about three deep into the bank perpendicular to the applied load. The line attached to the center of the log should be trenched into the soil adjacent to the log. Conventional anchors can also be buried to increase their load bearing capacity. Screw type anchors are recommended for rocky shores. Spade anchors are useful for attachment of boom tending lines that lead to the shore.

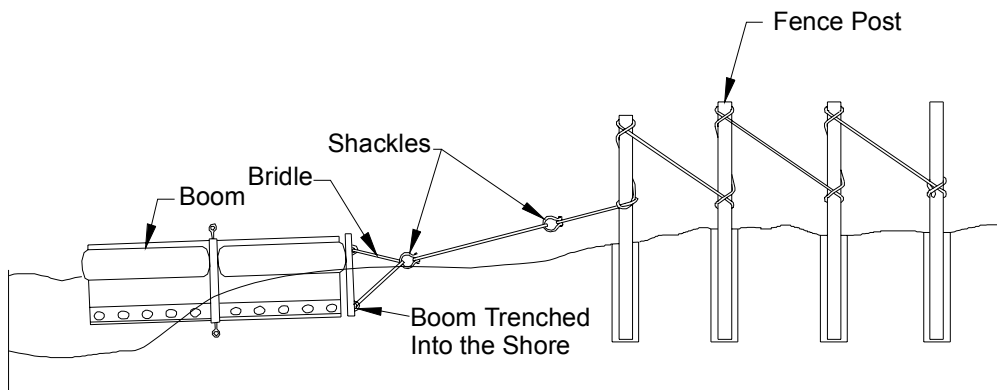

Figure 8-7. Typical shoreline boom mooring system using posts (Alaska Clean Seas, 1998).

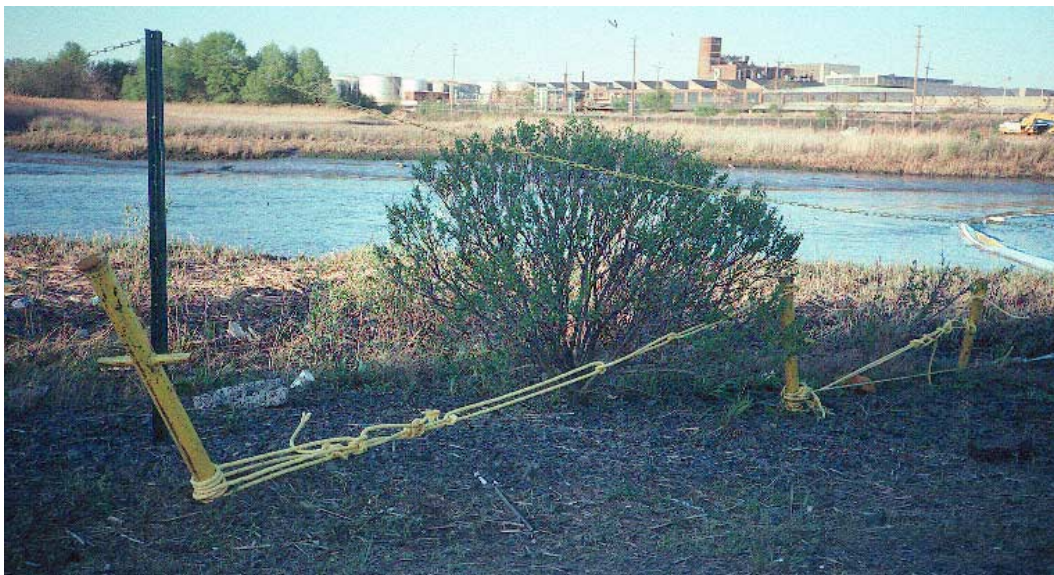

Figure 8-8. Multiple anchors used to moor boom.



Figure 8-9. Multiple booms being anchored (DOWCAR, 1997).

8.1.3 Mooring Techniques

There are many techniques to set and attach boom to get the proper angle and shape. The upstream lead anchor should be set first with the boom trailing parallel to the current. If the boat can hold all of the equipment and boom, the vessel moves to the anchor location, sets the anchor and backs down deploying the boom. A load should not be placed on the mooring line until the anchor is on the bottom. The anchor can be lowered by the mooring line from a small boat. However, the current may move it quite a distance before it sets. A preferred method is to use the anchor retrieval line attached to the crown of the anchor to position it while it is just off the bottom. Then releasing the line will ensure that it sets close to the desired location. Quick release hooks placed on the mooring buoy assist with making connections quickly. A spotter on shore should direct the boat to help with anchor placement. The downstream anchor is then set again using the anchor retrieval line to assist with placement and adjustments.

Another method to deploy an anchor from a small boat is to fake down the boom on shore with the anchor and line ready to go as seen in [Figure 8-10](#). The anchor release line is attached to the stern of the vessel. If sufficient amount of boom or line is available to keep slack in the boom, the vessel should tow out slowly, taking account of the current and wind. If additional boom or line is not available to provide slack, towing the anchor quickly away from the shore causes the Danforth® anchor to plane on the surface. When tension is on the boom and it is at the desired angle, the retrieval line is released by cutting a safety attachment line to drop the anchor in place. The shore crew then pulls in on the shoreside mooring line to set the anchor.



Figure 8-10. Boom faked out in zigzag with anchor attached.

Taking a line or boom across a river can be a dangerous operation. Whenever possible, the lead line should be pulled across, and safe and proper line handling techniques should be used. Sometimes a vessel is required to deploy a boom across a wide river or body of water. The boat should cross at an angle to the current, as seen in [Figure 8-11](#), to reduce the load on the vessel and equipment.

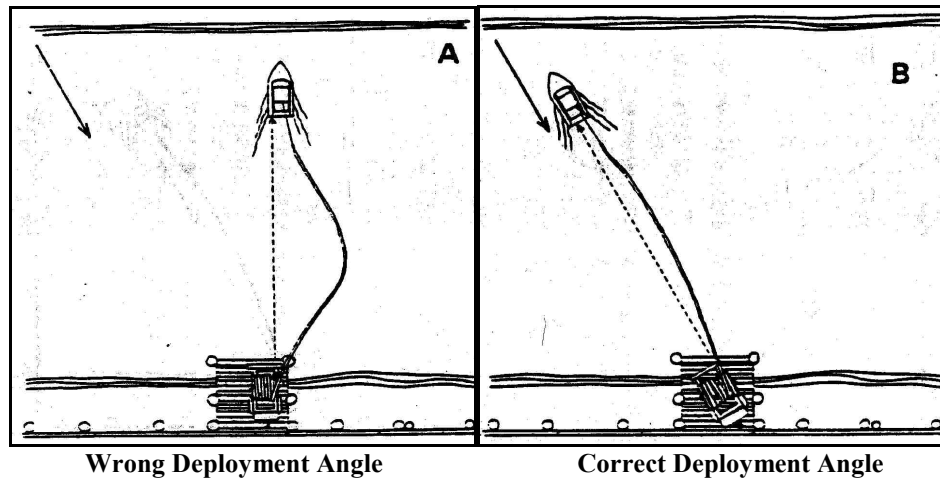

Figure 8-11. Boom deployment approach (National Spill Control School, 1998).

8.2 Boats and Power Selection

Power, maneuverability and speed are necessary to get safely out of trouble quickly in the dangerous conditions common in swift currents. The open bay and coastal regions invite higher waves and require larger boom and boats. It is very important to have enough horsepower to respond to these high forces when towing boom. Boom drag and mooring angle considerations should be used to determine the boat bollard pull required for the scenario and operating area at hand. Speed is essential in order to get to the spill site quickly when transiting against high currents. Adequate horsepower should be selected with assistance from the boat manufacturer and based upon the calculated towing forces required (maximum boom drag) with a margin of safety of approximately 30 percent. For outboards, one horsepower is required for 15 pounds of force exerted on a boom while approximately 20 pounds of force is exerted for each horsepower of an inboard workboat. Systems with kort nozzles can double these values. This will vary based upon the boat and propulsion type. Boats powered by standard jet drives can expect to provide only about one horsepower for 8-10 pounds of force. Jet drives specifically designed for towing can increase these values up to 20 pounds of force.

If a boat is being overwhelmed by the drag force on a boom as shown in [Figure 8-12](#), reduce the drag by collapsing the sweep width profile to the current. After maneuvering into position the boom can be opened again to maintain station or anchored as required. If control cannot be maintained, the boom length or draft should be reduced or another boat selected that is more powerful.



Figure 8-12. A 12-inch draft boom is too much for this boat and motor.

There are two configurations for putting boom into position, and the methods used to calculate the tow forces required are very different. The configuration that is mostly used is the straight-line/transit tow. Using standard drag coefficients, the drag per foot of inflatable or foam-filled boom is given in table 8-3. For example, 100 feet of boom with a 4-inch skirt in 5 knots of current results in a load of 66 pounds. If this same boom is towed on end upstream at 5 knots against the 5-knot current, the load is 265 pounds and a boat with at least 17 horsepower (265 divided by 15) is required plus additional power for the boat drag. Fence boom drag forces may be slightly less than those listed but booms with many appendages can be twice as high. Wave chop can increase the values given in the table below by up to three times.

Table 8-3. Pounds of force per foot of boom (towed from end).

Skirt Depth (inches)	Current (knots)									
	1	2	3	4	5	6	7	8	9	10
4	0.03	0.11	0.24	0.42	0.66	0.95	1.30	1.69	2.14	2.65
6	0.04	0.16	0.36	0.64	0.99	1.43	1.95	2.54	3.22	3.97
8	0.05	0.21	0.48	0.85	1.32	1.91	2.59	3.39	4.29	5.29
12	0.08	0.32	0.71	1.27	1.98	2.86	3.89	5.08	6.43	7.94

The second method that is used to position a boom is with it in a "U" configuration. This may occur (although not recommended) when stretching boom across a body of water. Tests at Ohmsett were performed for simple "U" configurations with openings of about one-third of the boom length. Based on tests, a simple relationship was developed correlating the tensile force developed in a boom versus the projected area of the submerged portion of the boom and the tow speed (Potter, McCourt, and Small, 1999):

$$T = K * A * V^2$$

where:

- T** = tensile force, lb_f
- K** = constant, lb_f/(ft² x knots²)
- A** = projected area of the submerged portion of the boom, ft²
- V** = tow speed, knots

The values to use for K are 1.7 for calm water, 4.3 for protected waters in regular waves, and 4.7 for open water under harbor chop conditions. For shallow angle boom arrangements, see [Appendix F](#) for additional calculations. Boats and barges should be selected to make the tasks easier and safer to perform. Vessel configurations that allow for boom and equipment to be easily pulled overboard and retrieved through a bow or stern ramp that can be lowered to the water's edge are very useful. Boat stability, working area, visibility, deck arrangement, freeboard, sea keeping, propulsion type and horsepower are all-important factors. Towing points should be located forward of the rudder or outboard motor for good maneuverability. If this is not possible, rig a slack bridle across the two stern cleats and behind the outboard. Place a shackle over the bridle and attach the boom to that shackle. The shackle will slide back and forth on the bridle to allow the boat to turn under load from the boom.

8.3 Temporary Oil Storage

The preferred method for oil storage and removal are tank or VAC trucks and barges. If they are not available or access is restricted then temporary oil storage is required. Oil storage by use of portable tanks and bladders is useful for locations that need storage quickly. These devices are relatively lightweight and can be transported by truck, boat or aircraft to the spill site. They are made of reinforced fabric and are more susceptible to damage by groundings and abuse than barges. Towable bladders can be used behind skimmers. Inflatable barges with open tops facilitate debris handling and oil offloading. Oil pits can also be dug with earth moving equipment. Portable open top tanks can be quickly assembled on shore over level ground.

8.3.1 Floating Oil Storage

Shallow Water Modular Barges

Several types of small barges used for shallow water can be transported by truck to the spill site. They have less drag in swift water and can take much more abuse than fabric temporary-storage devices. Some are designed to attach to each other in a side-by-side or end-to-end modular form.

Inflatable barges

Temporary storage devices (TSDs) are bladders or barges that float and can be towed for storage of recovered oil. They can be packed in a small space and transported quickly to a spill response site by land, sea or air. Once at the staging area, an inflatable barge can be unpacked, inflated, and launched in approximately two hours. If a beach is available, barges can be launched without a crane. The barge has an open top with a removable cover that facilitates offloading of viscous oil and soft debris and this feature makes cleaning easier. The TSDs can be deployed along side or behind a vessel. Barges can be towed empty to the scene at 15 knots and once filled it can be towed at approximately 5 knots. Various sizes are available from several manufacturers. The Coast Guard has purchased from Lancer Ltd. of Auckland, New Zealand 55 inflatable barges that can each hold 100 metric tons (26,000 gallons) of oil. They are 50-foot long, 22-foot wide with a freeboard of 3 feet and have a draft of 8 feet when full. Two of the barges are stored with each USCG VOSS, and the additional barges are located with each of the three Coast Guard Strike Teams.

Bladders

Bladders (see [Figure 8-13](#)) have the same logistics advantages of inflatable barges but do not always require blowers for inflation. Most use some foam floatation for stability. They can be unpacked and deployed in approximately one hour. There are many manufacturers of floating bladders but only a few make very large capacity units. Some are robust enough to be used for storage of oil on land or on the deck of a vessel but it should be secured to prevent it from rolling. Care must be used to prevent puncture of the bladder fabric. Hose connections and sometimes hatches are provided for filling and offloading.

8.3.2 Shore-Side Storage

Tank, Air Conveyors and Vacuum Trucks and Portable VAC Units

Tank, vacuum (VAC) and air conveyor trucks are the preferred method for shoreside oil storage and removal when road access is available. Portable VAC units are useful in remote locations and can be used to fill 55-gallon drums that can be sealed. Oil is generally pumped directly into the tank truck from the skimmer or portable transfer pump. Ensure that the tank truck is clean of debris or any other material before using.



Figure 8-13. Sea slug barge floating bladders.

The air conveyor, VAC truck and portable VAC units can function as a skimmer pump source. The VAC suction hose can be fitted with various types of nozzles and floating skimmer heads. The floating suction and weir skimmer heads are recommended for increased efficiency, however they cannot be used in swift currents. They can be easily be clogged by debris and if suction is lost, the height that the oil can be lifted is reduced. A spare fill hose is recommended and a method to free debris or back flush the fill hose is needed. The air conveyor hose uses a large diameter opening and cannot use a skimmer head because it would restrict airflow that it needs to operate. The hose can remove oil and debris off the surface by being positioned a few inches above the oil. The vacuum truck is limited to a maximum lifting height of approximately 30 feet due to the limits of a vacuum at atmospheric pressure. The portable units generate less lifting suction pressure and have a lift capability of 15 to 20 feet. The air conveyor system, however, can convey oil and debris much higher because it relies on airflow to lift. Conveyor systems can handle very viscous oil. Vacuum and conveyor units tend to collect a lot of water but the water can be decanted back into the collection area if local permits allow.

Portable Tanks

Open top portable tanks can be set up quickly on cleared level ground to provide temporary storage of recovered oil. When pumping up very high banks they can be used to pump the oil in stages to the desired level to reach a truck on a road above. They cannot be used on vessels.

Lined Pits

Pits can be dug in the ground with heavy equipment adjacent to the recovery area and lined with plastic. Some jurisdictions require two layers of plastic with sorbent pads below the liners. Recovered oil can then be temporarily pumped into the pits until trucks or barges can be brought in. This procedure usually requires local permits. Decontamination can be difficult and expensive.

Bladders

As discussed above, some floating bladders can also be used on land. Other products are only designed for land operations. It is a good idea to construct a temporary berm around the bladders in case one ruptures or leaks.

CHAPTER 9. SPECIALIZED METHODS AND TECHNIQUES

Some support equipment is unique to fast water operations. Laser range finders built into binoculars are very useful to determine distances required for booming strategies and calculating the number of boom sections and mooring line lengths required. They can also be used to determine distances between distant objects, angles between objects and declination angles to objects. Standard binoculars are used to quickly scope out good staging areas and shoreline mooring points. Binoculars are available with a compass readout that is helpful to select a mooring point to obtain the desired boom deflection angle. A stopwatch and tape measure are needed to measure the current velocity accurately using floating debris. An anchor and light line with two small floats attached 100 feet apart is handy for measuring the current with a chip log as discussed in [Appendix F](#).

Line handling equipment is required to deploy lines across inlets and rivers in order to move equipment and people. There are various methods to get a line across a wide water area. The first step is to get a lightweight tag line across the inlet or river. Once the tag line is across, heavier lines can be pulled over. Do not underestimate the drag force exerted on a long line in a swift current. Use of a small boat, throwing a line with a weighted end or using a line-throwing gun are typical methods to get a tag line across. Experienced swift-water small boat personnel outfitted with the proper safety equipment can get across currents towing a light line using row boats, outboards, canoes or kayaks. Weighted lines and projectiles from line throwing guns should be used with caution to prevent injuries. Use padded projectiles marked with florescent paint to minimize the chance of injuries.

9.1 Equipment and Practices Adapted to Fast-Water Response

Special techniques and equipment are needed for pulling boom across a swift current and applying the high tension required to get the desired deflection angle and minimize the boom catenary. Mountain climbing and other specialized equipment are useful in some situations. All equipment must be checked to ensure that it can handle the expected loads.

Use the smallest diameter line or cable that will take the load. The drag on mooring and tending lines of diversionary boom can be significant as the diameter increases. Significant catenary in the boom can sometimes be attributed to drag on a long mooring line in addition to the boom drag. Shallower draft boom and shorter sections used for cascade booming allows lighter small diameter mooring lines to be used. Higher strength synthetic materials can also help reduce the diameter while retaining the desired strength. Wire rope can be used but this requires gloves to handle and special tightening equipment. Boom tending lines that run perpendicular to the current have lighter loads and can be smaller in diameter. When the lines are at the surface they can inadvertently deflect oil away from the apex and snag debris. Spare shackles can be placed on these tending lines to weight them down below the surface to prevent interference of oil flow into the apex. Larger draft boom should not be used because it requires a more shallow deflection angle to keep it from bowing out and becoming useless for deflection.

Mechanical leveraging devices can also assist with tightening mooring lines to reduce boom catenary angles. Several devices are available that use hand-operated leverage and pulleys to haul in a line or cable. A Grip Hoist™ is used in the USCG VOSS package to lift a skimmer with a cable on a davit. A Come-Along™ is another ratchet type device that uses mechanical leverage to exert large forces by one person. Some pulleys can be attached to a line without running the bitter end of the line through them. When these devices are being attached to other lines, it is useful to have multiple anchor points in line so they can take temporarily handle the mooring line tension.

Ascenders with handgrips can be used to assist gripping line while hauling in the last few feet of a boom mooring line. These can be put on a line that is tied off at both ends. They usually have holes in the handle that can be used for attaching other equipment. Ascenders are also available without handles solely for attaching lines or pulleys to the main line. Several different types of ascenders available are shown in [Figure 9-1](#). Each provides a good handhold that can be quickly slid up the line when slack is taken out.



Figure 9-1. Ascenders used in gripping mooring lines.



Figure 9-2. Ascenders in use for tightening lines (DOWCAR, 1997).

Other Tricks of the Trade:

A loop of rope can also be effective to grab a line when ascenders are not available by wrapping around the line and inside its own loop. This technique reduces the effective line strength by as much as one-half.

A portable gas powered winch can greatly assist pulling the catenary out of a deflection boom. Care should be taken to prevent pulling out anchors, snapping mooring lines, or breaking the boom when using powered equipment.

The boom skirt can be rolled up and tied around the floatation to reduce drag and facilitate deployment. Deploy the boom so that the current faces the smooth backside of the rolled up skirt. After deployment, cut enough of the ties loose starting at the apex to permit the boom to bow out due to increased drag on the skirt. Leave the remainder of the skirt tied. The floatation and compressed skirt are enough to deflect oil at shallow angles.

Using shorter sections of boom and a more shallow draft boom for the cascade tactic also helps keep the boom in its desired shape and reduces the load on anchors.

It is difficult to overcome the drag forces when towing boom with a wide belly or “U” configuration into the current. Maneuvering the boats together to collapse the boom allows transit into the current. When moving upstream, boom and vessel drag can also be reduced by staying close to shore where currents are slower.

Use shorter bridle when towing and anchoring to maintain control.

9.2 Computer Support

Many types of oil spill drift models are available that can help with the planning process. Computer programs are also used to track resources during a spill and handle logistics requirements. Strategies, boom placement locations and equipment requirements can be integrated into existing models to assist with managing field deployments. Several organizations have developed a computer program to compute forces on booms in various configurations. Portable laptop and palm size computers can be brought into the field to use as required. The availability and diversity of these computer systems make them more useful to planners and responders with specific needs.

Trajectory models are only as good as the wind and current data that they use. It is important that for response applications, the model is capable to receive updated overflight spill location information as well as changing environmental data. Local knowledge of hydrodynamic circulation patterns and anomalies are helpful to supplement the models. Drift models are more applicable to coastal estuaries, coastal rivers and open water response, not inland rivers where runoff is less predictable. These models are not refined enough to predict effectiveness of booming and skimming strategies in complex fast-water conditions. However, many will provide accurate average surface current and direction predictions that will assist with the initial planning for strategies and tactics.

APPENDICES

Appendix A. Table and Worksheet for Fast Water Response

The following tables are included as references in order to make a rapid assessment of spill conditions, the selection factors involved in determining an effective response and the tactics associated with the applicable scenario.

Selection Factors for an Effective Response

Selection Factor	Related Sub-Factors	Checklist Notes
<ul style="list-style-type: none"> Nature of the spill 	<ul style="list-style-type: none"> Amount and type of oil Time & place of oil impact (ETA) Weathering/emulsion issues History of spills 	
<ul style="list-style-type: none"> Weather forecast 	<ul style="list-style-type: none"> Wind affects oil drift and sea state Rain affects currents in rivers and coastal areas Temperature, oil evaporation rate & people endurance Visibility 	
<ul style="list-style-type: none"> Type and Nature of Water body 	<ul style="list-style-type: none"> River, lake, swamp, inlet, bay, ocean, etc. Presence of debris or ice Navigable or not, traffic type & density 	
<ul style="list-style-type: none"> Shoreline 	<ul style="list-style-type: none"> River (winding, width, etc.), estuary, strait, headland, harbor, inlet, island, etc. Natural collection points Sensitive areas 	
<ul style="list-style-type: none"> Shoreline type 	<ul style="list-style-type: none"> Salt marshes & mangroves, sheltered tidal flats, sheltered rocky coasts, exposed tidal flats and vegetation, gravel beaches, beaches, etc. Other threatened or historical areas 	
<ul style="list-style-type: none"> Environment 	<ul style="list-style-type: none"> Current speed and direction Tidal action: height, cycle time, reversing currents, slack water, etc. Waves: height, wave direction, period, breaking or non-breaking, etc. 	
<ul style="list-style-type: none"> Bottom 	<ul style="list-style-type: none"> Water depth and contours Bottom type (relating to habitat damage and anchoring potential) 	
<ul style="list-style-type: none"> Man-made structures and commercial enterprises 	<ul style="list-style-type: none"> Piers, breakwaters, bulkheads, bridges, etc. Water intakes (drinking water, desalination, etc.) Floating houses, casinos, commercial & recreational traffic Commercial logs, fish hatcheries, etc. High traffic volume water commerce 	
<ul style="list-style-type: none"> Available resources/Logistics (Response Time to Plan and Deploy) 	<ul style="list-style-type: none"> Response organizations: On Scene Coordinator (OSC), Responsible Party (RP), Oil Spill Response Organization (OSRO), etc. Estimated Time of Deployment (ETD) Response equipment, locations and availability (effectiveness in fast-water conditions) Boats (HP for speed & towing in currents) Response personnel, their training, location & availability (experience in swift currents) Logistics support network & equipment Repair and Maintenance facilities Communications 	
<ul style="list-style-type: none"> Accessibility 	<ul style="list-style-type: none"> Land accesses (bridges, roads, shoreline grade, shoreline vegetation, etc.) Water access (boat ramps, marinas, fuel, boat draft, specialty vehicles such as jet boats, air cushion vehicles, airboats, etc.) Air accesses (airports & areas for helicopters) Approval may be needed 	
<ul style="list-style-type: none"> Safety 	<ul style="list-style-type: none"> Personnel Safety Site specific issues such as accidental ignition sources 	
<ul style="list-style-type: none"> Debris 	<ul style="list-style-type: none"> Collection and disposal procedures Natural Collection Points 	

FAST WATER WORKSHEET	1. Incident Name:		2. Date/time prepared:			3. Operational Period			4. Attachments				
5. Fast Water Type	Rivers/Canals (non-tidal) <input type="checkbox"/> Rivers/Canals (tidal) <input type="checkbox"/> Small Streams/Culverts/Creeks <input type="checkbox"/> Coastal areas <input type="checkbox"/> Harbors/Bays <input type="checkbox"/> Breakwaters and Harbor entrances <input type="checkbox"/> Other (specify):												
6. Background Info	Oil Type	Oil Amount	Temperature F	Humidity %	Evaporation in 24 hours %	Wind (mph)	Visibility (Ft)	Rain, Sleet, Snow	Water (F) Temperature	Other			
7. Safety Hazards	Confined Space <input type="checkbox"/> Noise <input type="checkbox"/> Heat Stress <input type="checkbox"/> Cold Stress <input type="checkbox"/> Electrical <input type="checkbox"/> Animal/Plant/Insect <input type="checkbox"/> Ergonomic <input type="checkbox"/> Ionizing Rad <input type="checkbox"/> Slips/Trips/Falls <input type="checkbox"/> Struck by <input type="checkbox"/> Water <input type="checkbox"/> Violence <input type="checkbox"/> Excavation <input type="checkbox"/> Biomedical waste and/or needles <input type="checkbox"/> Fatigue <input type="checkbox"/> Other (specify)												
8. Personal Protection	Life Jackets <input type="checkbox"/> Oil resistant gloves <input type="checkbox"/> Shoulder length resistant gloves <input type="checkbox"/> Level D <input type="checkbox"/> Eye protection <input type="checkbox"/> Cold WX Gear <input type="checkbox"/> Level C <input type="checkbox"/> Splash Suits <input type="checkbox"/> Hearing protection <input type="checkbox"/> Fall protection <input type="checkbox"/> Water <input type="checkbox"/> Sun screen <input type="checkbox"/> Wet Suits <input type="checkbox"/> Dry Suits <input type="checkbox"/> Portable first aid kits <input type="checkbox"/> Other (specify)												
9. Potential Booming Locations	ETA Oil Impact	Natural Collection Point	Shoreline wave energy	Current Speed & Direction	Access	Water Depth	Tidal Influence	Bottom Amenable to Anchors	Debris, Ice	Shore Sensitivity	Historical Economic Concern	Nav Traffic	Strategy Selection
	Yes <input type="checkbox"/> No <input type="checkbox"/>	High <input type="checkbox"/> Med <input type="checkbox"/> Low <input type="checkbox"/>	High <input type="checkbox"/> Med <input type="checkbox"/> Low <input type="checkbox"/>		Land <input type="checkbox"/> Water <input type="checkbox"/> Air <input type="checkbox"/>		High <input type="checkbox"/> Med <input type="checkbox"/> Low <input type="checkbox"/>	Yes <input type="checkbox"/> No <input type="checkbox"/>	High <input type="checkbox"/> Med <input type="checkbox"/> Low <input type="checkbox"/>	High <input type="checkbox"/> Med <input type="checkbox"/> Low <input type="checkbox"/>	High <input type="checkbox"/> Med <input type="checkbox"/> Low <input type="checkbox"/>	High <input type="checkbox"/> Med <input type="checkbox"/> Low <input type="checkbox"/>	
	Yes <input type="checkbox"/> No <input type="checkbox"/>	High <input type="checkbox"/> Med <input type="checkbox"/> Low <input type="checkbox"/>	High <input type="checkbox"/> Med <input type="checkbox"/> Low <input type="checkbox"/>		Land <input type="checkbox"/> Water <input type="checkbox"/> Air <input type="checkbox"/>		High <input type="checkbox"/> Med <input type="checkbox"/> Low <input type="checkbox"/>	Yes <input type="checkbox"/> No <input type="checkbox"/>	High <input type="checkbox"/> Med <input type="checkbox"/> Low <input type="checkbox"/>	High <input type="checkbox"/> Med <input type="checkbox"/> Low <input type="checkbox"/>	High <input type="checkbox"/> Med <input type="checkbox"/> Low <input type="checkbox"/>	High <input type="checkbox"/> Med <input type="checkbox"/> Low <input type="checkbox"/>	
	Yes <input type="checkbox"/> No <input type="checkbox"/>	High <input type="checkbox"/> Med <input type="checkbox"/> Low <input type="checkbox"/>	High <input type="checkbox"/> Med <input type="checkbox"/> Low <input type="checkbox"/>		Land <input type="checkbox"/> Water <input type="checkbox"/> Air <input type="checkbox"/>		High <input type="checkbox"/> Med <input type="checkbox"/> Low <input type="checkbox"/>	Yes <input type="checkbox"/> No <input type="checkbox"/>	High <input type="checkbox"/> Med <input type="checkbox"/> Low <input type="checkbox"/>	High <input type="checkbox"/> Med <input type="checkbox"/> Low <input type="checkbox"/>	High <input type="checkbox"/> Med <input type="checkbox"/> Low <input type="checkbox"/>	High <input type="checkbox"/> Med <input type="checkbox"/> Low <input type="checkbox"/>	
	Yes <input type="checkbox"/> No <input type="checkbox"/>	High <input type="checkbox"/> Med <input type="checkbox"/> Low <input type="checkbox"/>	High <input type="checkbox"/> Med <input type="checkbox"/> Low <input type="checkbox"/>		Land <input type="checkbox"/> Water <input type="checkbox"/> Air <input type="checkbox"/>		High <input type="checkbox"/> Med <input type="checkbox"/> Low <input type="checkbox"/>	Yes <input type="checkbox"/> No <input type="checkbox"/>	High <input type="checkbox"/> Med <input type="checkbox"/> Low <input type="checkbox"/>	High <input type="checkbox"/> Med <input type="checkbox"/> Low <input type="checkbox"/>	High <input type="checkbox"/> Med <input type="checkbox"/> Low <input type="checkbox"/>	High <input type="checkbox"/> Med <input type="checkbox"/> Low <input type="checkbox"/>	
	Yes <input type="checkbox"/> No <input type="checkbox"/>	High <input type="checkbox"/> Med <input type="checkbox"/> Low <input type="checkbox"/>	High <input type="checkbox"/> Med <input type="checkbox"/> Low <input type="checkbox"/>		Land <input type="checkbox"/> Water <input type="checkbox"/> Air <input type="checkbox"/>		High <input type="checkbox"/> Med <input type="checkbox"/> Low <input type="checkbox"/>	Yes <input type="checkbox"/> No <input type="checkbox"/>	High <input type="checkbox"/> Med <input type="checkbox"/> Low <input type="checkbox"/>	High <input type="checkbox"/> Med <input type="checkbox"/> Low <input type="checkbox"/>	High <input type="checkbox"/> Med <input type="checkbox"/> Low <input type="checkbox"/>	High <input type="checkbox"/> Med <input type="checkbox"/> Low <input type="checkbox"/>	
	Yes <input type="checkbox"/> No <input type="checkbox"/>	High <input type="checkbox"/> Med <input type="checkbox"/> Low <input type="checkbox"/>	High <input type="checkbox"/> Med <input type="checkbox"/> Low <input type="checkbox"/>		Land <input type="checkbox"/> Water <input type="checkbox"/> Air <input type="checkbox"/>		High <input type="checkbox"/> Med <input type="checkbox"/> Low <input type="checkbox"/>	Yes <input type="checkbox"/> No <input type="checkbox"/>	High <input type="checkbox"/> Med <input type="checkbox"/> Low <input type="checkbox"/>	High <input type="checkbox"/> Med <input type="checkbox"/> Low <input type="checkbox"/>	High <input type="checkbox"/> Med <input type="checkbox"/> Low <input type="checkbox"/>	High <input type="checkbox"/> Med <input type="checkbox"/> Low <input type="checkbox"/>	
10. Selection Strategies	Current < 2 Knots			Current > 2 Knots			Room to Maneuver			Collection Possible on Opposite Sides			
Rivers/Canals (non-tidal)	Single Diversion Booming (Skirt < 12 inches) (SDB<12) Sorbents (isolated areas) (SRB) Exclusion Booming (EXB) Encircle Booming (ECB)			Single Diversion Booming (Skirt < 6 inches) (SDB<6) Cascade Booming (CSC)			Skimmers (SK)			Chevron Booming (CHV)			
Rivers/Canals (tidal)	Double SDB<12, ECB, SRB			Double SDB<6, CSC			SK			CHV			
Small Streams /Creeks/Culverts	Fill, Dams, Weirs Underflow/Overflow Dams (UFD/OFD) SRB						SK (small)						
Coastal Areas	ENC, SDB<12 (no waves), SRB			CSC			SK						
Harbor/Bays	SDB<12, ECB, SRB			SDB<6, CSC			SK			CHV			
Breakwaters/Harbor Entrances	SDB<12, ECB, SRB, Fill, Dams, Weirs, UFD, OFD			SDB<6, CSC			SK			CHV			
Prepared by:				Notes: Use codes in section 10 to complete strategy section in section 9.						Page ____ of ____			

Appendix B. Definitions

advection	The horizontal (surface) and sometimes vertical (subsurface) transportation of oil caused by currents, turbulent mixing and wind.
Area Contingency Plans	These are planning documents that are developed by each area committee in all locations throughout the country. Their general format is set by the National Response Team (NRT), but the details and content of each varies.
ASTM	American Society for Testing and Materials --This organization sets industry standards through Committee F 20 on Hazardous Substances and Oil Spill Response.
boom deflectors	Aluminum devices with a wing, which can be deployed between boom sections to help keep the boom straight.
boom vane	A device that is flown like a kite into the current with a boom attached. It replaces the anchor and rigging hardware.
chevron	Boom deployment method used when access to both shorelines is available.
convergence line	A line on the water surface where floating objects and oil collect. A convergence can be the interface between two different types or bodies of water, or it can be caused by significant changes of depth and tidal changes.
critical velocity	Velocity at which oil starts to entrain under a boom when the boom is perpendicular to the current. A conservative value of 0.7 knots is used in this guide.
dispersion	The breaking up of an oil slick into small droplets that are mixed into the water column due to breaking waves and other turbulence. This process is accelerated when dispersant chemicals are used.
emulsification	The formation of a water-in-oil mixture. This occurs over time as the slick weathers and surface mixing occurs. Oil viscosity greatly increases making collection and pumping the emulsion or "chocolate mousse" very difficult. Some emulsion can contain up to 70 percent water but they become stable and will not separate unless heat or chemicals are applied.
entrainment	The loss of oil from containment when it is pulled under a boom by the water passage below. Entrainment typically occurs from booms deployed perpendicular.
fast water	Water where surface currents are one knot or greater.
ICS	Integrated Command System --The organization to be used for major responses as dictated by the NRT and USCG as part of the National Interagency Incident Management System (NIIMS).
slough	Tributary diversion of a river that branches out but that returns to the river downstream.
weathering	A combination of physical and environmental processes affecting oil such as evaporation, emulsification, dissolution and dispersion that act on spilled oil to change its physical properties and composition.
windrows	Streaks of oil that line up in the direction of the wind. Windrows typically form early during a spill when the wind speed is at least 10 knots. A very thin sheen is more likely to form in windrows.
VOSS	Vessel of Opportunity Skimming System --This system that can be mounted on a variety of vessels. Planning is usually needed to ensure the equipment is compatible with the vessel's arrangement.
ZRV	Zero Relative Velocity --A type of skimmer that has the belt or mop speed adjusted to match the speed of the current.

Appendix C. Conversion Tables

Table C-1. Conversion Tables.

VOLUME

1 U.S. Gallon = 231 in³ = 0.1337 ft³
 1 BBL = 42 Gal = 5.615 ft³
 1 BBL = 158.97 L = 0.159 m³
 1 gal = 3.785 L
 1 L = 0.26 gal
 1 "ton" of oil = 1,000 L = 1 m³ = about 264 gal
 1 m³ = 6.29 BBL = 264.2 gal
 1 ft³ = 0.0283 m³ = 7.48 gal
 1 m³ = 10⁶ cm³ = 10³ L
 Imperial gallons X 1.2 = U.S. gallons
 U.S. gallons X 0.83 = Imp. gallons
 Gallons X 0.0038 = m³

VOLUME RATE

L/hr X 0.0063 = BBL/hr
 L/hr X 0.0044 = gpm
 L/s X 3.6 = m³/hr
 Tons/hr (or m³/hr) X 4.4 = gpm
 Tons/hr X 6.3 = BBL/hr
 BBL/hr X 0.159 = m³/hr
 gpm X 1.43 = BBL/hr
 BBL/hr X 0.7 = gpm
 L/sec X 15.9 = gpm
 gpm X 0.23 = m³/hr
 gpm X 1.43 = BBL/hr
 gpm X 34.29 = BBL/day
 m³/hr X 16.7 = L/min
 m³/hr X 6.29 = BBL/hr
 L/min X 0.06 = m³/hr
 L/min X 0.377 = BBL/hr
 gpm X 3.785 = L/min
 BBL/day X 0.11 = L/min
 BBL/day X 0.0292 = gpm
 m³/sec X 10⁻³ X 3.6 = m³/hr

AREA

1 hectare = 10,000 m² (a 100 m square)
 1 acre = 43,560 ft² = 0.4047 hectares
 1 hectare = 2.471 acres
 1 ft² = 0.0929 m²

AREA APPLICATION

gallons/acre X 9.35 = L/hectare
 L/m² = thickness in mm
 Area (ft²) X Thickness (inches) X 0.623 = Volume (gallons)

SPILL ENCOUNTER RATE

Spill Encounter Rate (BBL/hr) = (Sweep Width [ft]/6076) X Skimming Speed (knots) X Slick Thickness (mm) X 21,570

Spill Encounter Rate (m³/hr) = (Sweep Width [m]/1,852) X Skimming Speed (knots) X Slick Thickness (mm) X 3,430

LENGTH

1 inch = 2.54 cm = 25.4 mm
 1 foot = 30.48 cm
 1 foot = 0.3048 m
 1 meter = 3.2808 feet
 cm X 0.0328 = FT
 1 statute mile = 0.87 NM
 1 nautical mile = 6,076 feet
 1 kilometer = 0.54 nautical miles
 1 NM = 1.852 km = 1,852 m
 1 NM = 1.15 Statute miles
 1 micron = m X 10⁶ = mm X 10³
 1 fathom (6 ft) = 1.829 m
 1 m = 0.547 fathoms

DISTANCE RATE

1 knot = 1.69 ft/sec
 ft/sec X 0.593 = knots
 m/sec X 1.94 = knots (about 2 X)
 m/s X 3.28 = FT/sec
 mph X 1.5 = ft/sec
 knots X 51.4 = cm/sec

WEIGHT

1 pound = 0.45 kilograms
 1 kilogram = 2.2 pounds
 lb/ft X 1.48 = kg/m
 kg/m X 0.672 = pounds/ft
 1 metric ton = 1,000 kg
 1 long ton = 2240 pounds

Appendix D. Processes Accelerated in Swift Current

The most obvious effect that a fast current has on oil is the transport or drift of oil in the direction and speed of the surface current. Other less obvious consequences of fast water are the accelerated effects on the oil weathering process (see Figure D-1) (Exxon, 1992).

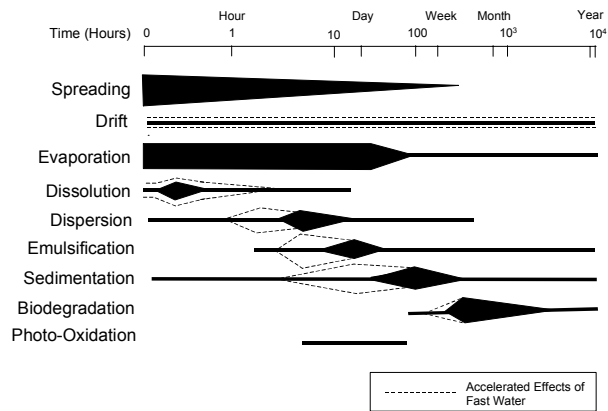

Figure D-1. Effects of fast water on oil spill processes.

Oil drift or advection is directly affected by current velocity because oil is swept along by the surface current. Drift is influenced by the currents and circulation anomalies associated with the water body, including one or more of the following: river currents, tidal currents, long shore currents, eddies, seiche currents and wind driven currents. Wind drift is calculated using 3.5 percent of the wind velocity in Table D-1.

Table D-1. Wind drift of oil.

Wind Velocity (knots)	Wind Drift Current (knots)
10	0.35
20	0.70
30	1.05
40	1.40

Spreading is not generally affected by currents because it is dependent upon oil viscosity, surface tension, slick thickness and gravity forces.

Evaporation is not affected by fast water unless related turbulence drives the oil into the water column where evaporation cannot occur.

Dissolution will be increased through turbulent mixing and oil entrainment into the water affording more oil/water contact for the dissolution process to occur.

Dispersion of oil droplets into the water column is accelerated by turbulence. The increased surface area of oil to water resulting from dispersion increases the rate of dissolution and sedimentation.

Emulsification of water and oil is accelerated by fast currents and associated turbulent mixing. Emulsified oil dramatically increases in volume due to captured water and viscosity also increases quickly making retrieval and pumping oil more difficult.

Sedimentation reduces buoyancy and sometimes causes oil to eventually sink. The rate of sedimentation is further accelerated in turbulent waters where bottom roughness, constriction points, waterfalls and higher currents exist.

Biodegradation may be accelerated when turbulent mixing and dispersion creates small oil droplets.

Photooxidation may be reduced if turbulent mixing removes oil from the surface.

Appendix E. Cascade Tactic for Booming a River (DOWCAR, 1997)

Overview

This DOWCAR cascade booming technique is recommended for rivers 600-foot wide or less. All three team leaders, the incident commander and the ferry system operator should have two-way radios for communications. All personnel shall have appropriate safety equipment that includes as a minimum: life jacket, hardhat, safety glasses, work gloves, knife and steel toe rubber boots. Beware of lines under tension because they may part. Select mooring points that are strong. If available, the base of large trees and boulders should be used for boom anchor points. Use multiple anchors if required for the main upstream and downstream anchor points. Follow the setup and deployment of cascade booming in [Figures E-1](#) and [E-2](#).

Team A Duties in Cascade Boom Deployment

Setting up for Boom Deployment:

Lay each boom section out along the shoreline. Leave a 10-foot overlap between each boom section.

The first boom should be closest to the water's edge with each succeeding boom laid on the inland side of the previous one, ([Figure E-2](#)).

Establish the main anchor point at the containment area. The first boom should be anchored here within 5 to 10 feet of the downstream end of the boom on shore and then entrenched in place after deployment. Shore sealing (water ballast) boom can also be used as the first boom, instead of entrenching, where tidal fluctuations are significant.

Place towing bridles and tie anchor lines onto the downstream end of each boom. Lay them along the shore while walking back to the main anchor point.

If any diagonal lines from the upstream end of the boom are crossed, be sure to weave your line under them.

If additional anchor points are needed, place them inland of the initial anchor point no more than 12 inches apart.

In some cases, you may want to put a second (safety) line on the downstream end of the boom. It will help keep the downstream end of the boom from slipping under the downstream boom. It can be secured anywhere on shore perpendicular to the boom.

Safety lines are generally run under the downstream anchor lines and forward "diagonal lines" are run over the upstream anchor "pull line."

During Boom Deployment:

The Team Leader should stand near the anchor line tie-down point and take direction from the Incident Commander. If any adjustments are needed in the line, Team Members should release or pull in while the Team Leader issues commands to adjust the boom properly.

Someone may also be needed to tend the safety line during deployment. Team A leader must be in a position so that Team Members at both lines can hear them.

Team B Duties in Cascade Boom Deployment

Setting up for boom deployment:

Assist Team A in laying the boom sections along the shoreline leaving a 10-foot overlap between the boom sections.

On the upstream end of each boom section, connect a towing bridle, buoy and two lines. One line will be long enough to go across the river to Team C. It is referred to as the "pull line." The other "diagonal line" will be tended by Team B.

If any lines from the downstream end of the boom are crossed, place the upstream lines over them.

The Team C pull line should be laid along the shoreline parallel to the boom. Each succeeding line should be inland of the previous one. String the line upstream to the ferry system and then add enough rope to cover the distance across the river.

The diagonal line should be secured on the near shoreside about 30 to 50 feet upstream from the end of the boom. Be sure there is enough line to release the boom out into the water. Each succeeding boom will need additional line as more width of the river is boomed.

During boom deployment:

The B Team Leader should stand near the diagonal line tie-down point listening to the Incident Commander. As adjustments are required in your line, Team Members should release or pull in as directed by the Team Leader.

Team C Duties in Cascade Boom Deployment

Setting up for boom deployment:

Team C is responsible for setting up the Ferry System (Figure E-3) and anchor points on the far shoreside of the river for the pull lines of each boom. The Ferry System is a set of three lines strung across the river and connected with a pulley. It is used for moving things across the river. It consists of a static line with a near-shore ferry line and a far-shore ferry line attached to a pulley that runs on the static line.

The static line must be strung across the river using a boat, bridge or line-throwing gun. If a line gun is used there must be a person on the far shore. The static line must be free of knots and strung tightly out of the water. Place the near-shore end of the static line upstream and higher than the far-shore side. This will take advantage of gravity and the current forces when pulling the pull lines and boom across the river. Once the static line is in place, repeat the process to get the far-shore ferry line across the river. The near shore ferry line and the pulley can be attached on the near shoreside to complete the system. After the ferry system is complete as shown in Figure E-3, all Team C members except one should go the far shoreside.

The ferry system operator on the near shoreside should have a two-way radio or use a predetermined hand signal system for directions on when to send the pull line for each boom across the river.

When ready the Team Leaders should contact the Incident Commander. The Team C leader shall work with the Incident Commander to select the anchor point for the first boom. Succeeding anchor points for additional booms should be selected after the previous boom has been deployed.

During boom deployment:

Once the Incident Commander has indicated that he or she is ready to deploy a boom, they will give the signal or command to the team members on the ferry line to release the ferry line with the boom's pull line.

The boom pull line should be taken off the ferry system and moved to the anchor point, secured, and all of the slack should be pulled out of the line. The Team C leader should then contact the Incident Commander to let them know that slack is out of the line and wait for the command from the Incident Commander to pull the boom into position. This will require a lot of effort. It is usually accomplished by pulling the line through the anchor system and down the shore adjacent to the pull line. Pulleys can be used to make it easier to take the final slack out of the boom.

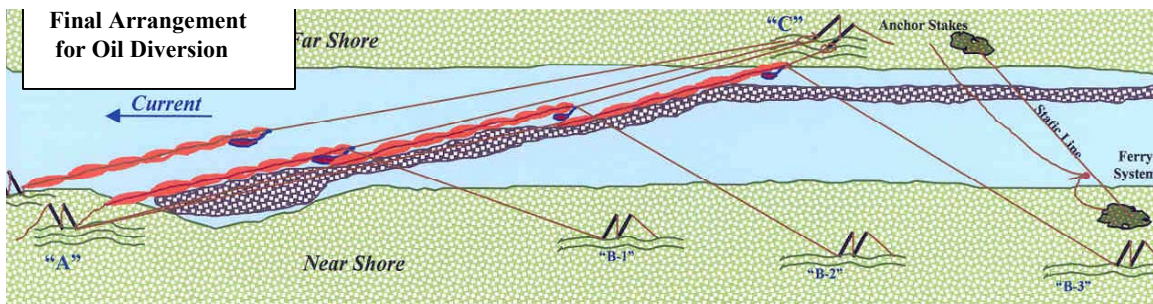
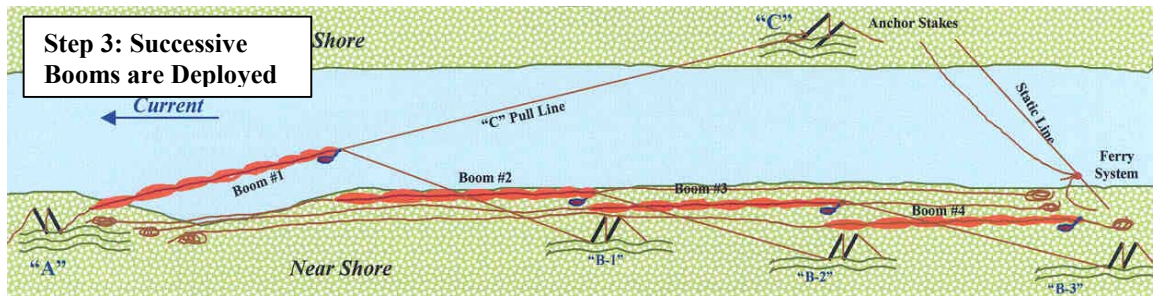
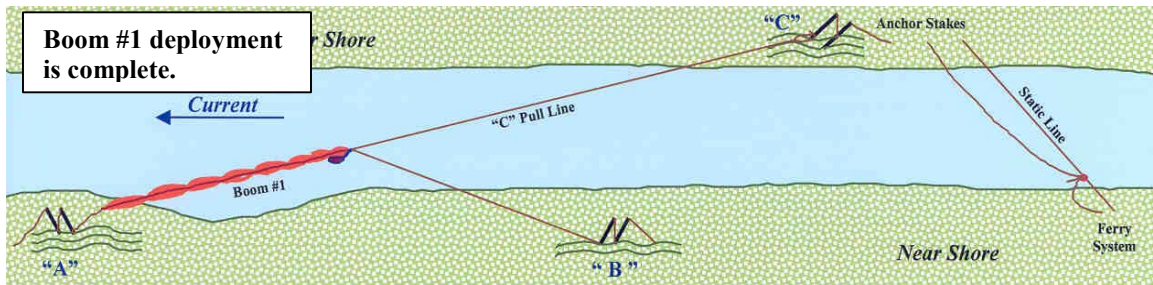
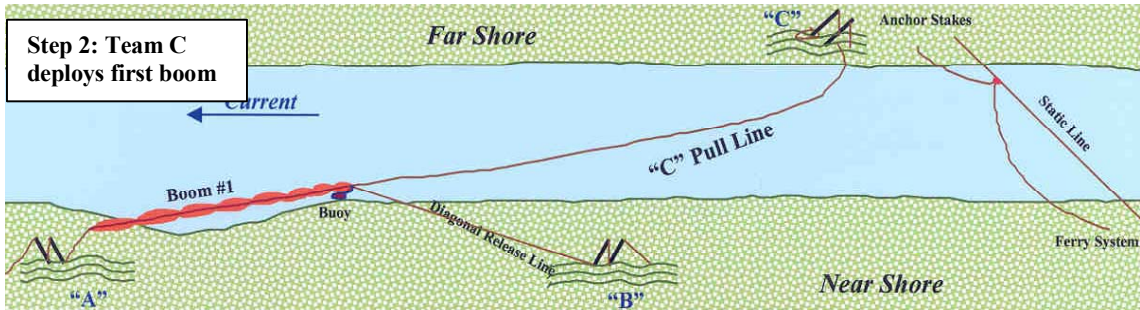
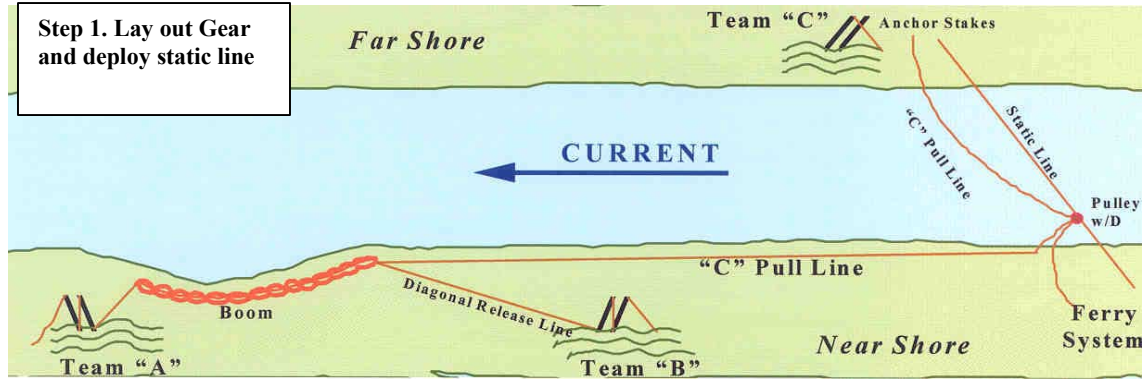

Figure E-1. Sequence of DOWCAR system deployment.



Equipment is deployed along shore.



First boom is deployed.



Fourth boom is deployed.



Final configuration.

Figure E-2. Photographs of boom deployment.



Figure E-3. Ferry system deployed.

Appendix F. Current Estimation and Mooring Line Issues

This appendix provides some basic information about calculating current velocity and considerations for boom tension. Methods are first provided for current velocity and maximum boom deflection angle calculations. Then methods to calculate mooring line forces for booms in a “U” configuration are described. This arrangement is not normally used in fast water since the tensions are very high and the oil will most likely escape under the apex of the boom.

Current Calculations

Table E-1 presents the time for floating debris to drift 100 feet. This is most accurately determined by anchoring a line with two floating buoy markers attached at a spacing 100 feet apart. Floating debris is then thrown into the water approximately 20 feet upstream of the first buoy marker. Determine the time it takes the debris to transit the distance between the two marker buoys in seconds. This assumes that the minimum escape velocity under a boom perpendicular to the current (90 degrees) is 0.7 knots. Table F-1 also provides an estimate of the length of boom required for deflecting oil at a specified angle for a 100-foot profile (perpendicular width) to the current. It also provides an estimate of the number of anchors or shoreline tiebacks required for that length of boom assuming anchor points are required every 50 feet.

Table F-1. Current chip log and maximum boom deflection angle.

Time to Drift 100 Feet (seconds)	Velocity (ft/sec)	Velocity (m/sec)	Velocity (knots)	Max Boom Deflection Angle (degrees)	Boom Required for 100-foot Profile to Current (feet)	Anchors if Placed Every 50 feet (number)
6	16.7	5.1	10.00	4.0	1,429	30
8	12.5	3.8	7.50	5.4	1,071	22
10	10.0	3.1	6.00	6.7	857	18
12	8.3	2.5	5.00	8.0	714	15
14	7.1	2.2	4.29	9.4	612	13
17	5.9	1.8	3.53	11.4	504	11
20	5.0	1.5	3.00	13.5	429	10
24	4.2	1.3	2.50	16.3	357	8
30	3.3	1.0	2.00	20.5	286	7
40	2.5	0.8	1.50	27.8	214	5
60	1.7	0.5	1.00	44.4	143	4
>86	≤1.2	≤0.35	≤0.70	90.0	100	3

Mooring Angle Considerations

The additional forces exerted on a boom caused by the mooring line angle are often neglected, but they become very large at shallow angles. A boom in a slack “U” configuration has mooring lines parallel with the current or at 0 degrees. The total tension load on each mooring line is simply the drag force on the boom divided by two. As the orientation of the boom mooring line relative to the current approaches 90 degrees, the tension on each mooring line increases dramatically. Tension in each mooring line is calculated for a 6-inch draft boom at various current speeds with a 100-foot projected sweep width (boom profile) to the current as seen in Figure F-1.

Symmetrical Boom

Boom Draft – 0.5 feet

Mooring line tension at different boom drafts can be calculated by dividing the boom draft in feet by 0.5 and multiplying that number by the value from the table below. For example, a boom draft of 1 foot (1/0.5=2) would double all values in the table below.

Boom profile to the current – 100 feet

This is the effective sweep width of the boom or projected sweep width as seen in Figure F-1.

Angle of the boom mooring line to the current

An angle of 0 degrees represents a boom in a slack U configuration with the mooring lines parallel to the current. As the angle is increased, the shape of the boom flattens out and mooring line angle approaches 90 degrees perpendicular to the current.

Table F-2. Mooring line loads.

Mooring Line Angle (degrees)	Each Mooring Line Tension (pounds force)					
	1 knot	2 knots	3 knots	4 knots	5 knots	6 knots
0	137	547	1,231	2,188	3,419	4,923
5	137	549	1,235	2,196	3,432	4,942
10	139	555	1,250	2,222	3,471	4,999
20	146	582	1,310	2,328	3,638	5,239
25	151	604	1,358	2,414	3,772	5,432
30	158	632	1,421	2,526	3,948	5,685
40	179	714	1,607	2,856	4,463	6,427
45	193	774	1,741	3,094	4,835	6,962
50	213	851	1,915	3,404	5,319	7,659
60	274	1,094	2,462	4,376	6,838	9,846
70	400	1,599	3,598	6,397	9,996	14,394
80	788	3,150	7,088	12,600	19,688	28,350
85	1,569	6,276	14,121	25,104	39,226	56,485
89	7,836	31,342	70,520	125,370	195,890	282,081

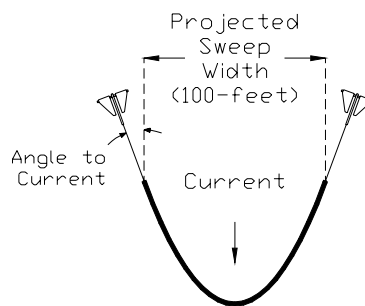

Figure F-1. Projected boom sweep.

Example

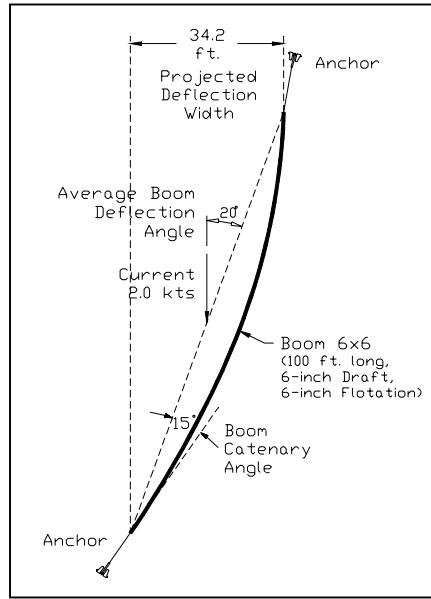

Figure G-1. Example.

Anchor Selection: A 100-foot section of 6-inch draft boom is deployed at an angle of 20 degrees in a two-knot current. The estimated catenary angle of the boom mooring line is 15 degrees as seen in the figure to the left. The incremental drag force from Table G-3 is 10.7 pounds/foot. The projected area of the 100-foot boom section to the current at a 20-degree angle to the current is 34.2 feet as determined from Table G-2. Total drag force on the boom is 10.7 lbs./ft X 34 ft or 363.8 lbs. The tension force multiplier for a boom catenary angle of 15 degrees from Table G-4 is 3.9. Total tension on the boom is 363.8 lbs. X 3.9 or 1,418.8 pounds. Each mooring line will see approximately half that load or 709.4 lbs. The boom selected for this application should have a minimum breaking strength of 1,784 pounds to prevent damage using a 25 percent safety factor (1,427 X 1.25 = 1,784 lbs.). Each anchor system should be capable of holding 900 lbs. safely.

Boom Length: Divide width of river (or covered area) by the Projected Deflection Width (Table G-2, Column 3) to get the number of boom sections required. For example, if the river is 340 feet wide, divide 340 by 34 and get 10. About 1000 feet (100X10) of boom is needed. For a cascade technique, if a 20 percent overlap is needed, then add 20 percent (or 200 feet) to the overall boom length.

Table G-2. Projected deflection boom width to the current.

Mean Boom Angle to the Current* (degrees)	Projected Boom Width to the Current* (feet)	
	50-foot Section	100-foot Section
10	8.7	17
20	17.1	34
30	25.0	50
40	32.1	64
50	38.3	77
60	43.3	87
70	47.0	94
80	49.2	98
90	50.0	100

Table G-3. Current drag force on one-foot boom profile to current.

Velocity (knots)	Boom Drag Force (pounds)			
	Draft 0.5 Feet	Draft 1.0 Feet	Draft 1.5 Feet	Draft 2.0 Feet
0.5	0.7	1.3	2.0	2.7
1.0	2.7	5.3	8.0	10.7
1.5	6.0	12.0	18.0	24.0
2.0	10.7	21.3	32.0	42.6
2.5	16.7	33.3	50.0	66.6
3.0	24.0	48.0	72.0	95.9
3.5	32.6	65.3	97.9	130.6
4.0	42.6	85.3	127.9	170.6
4.5	54.0	107.9	161.9	215.9
5.0	66.6	133.3	199.9	266.5
5.5	80.6	161.2	241.8	322.5
6.0	95.9	191.9	287.8	383.8
6.5	112.6	225.2	337.8	450.4
7.0	130.6	261.2	391.8	522.3

Table G-4. Tension force multiplier for boom catenary angles.

Boom Catenary Angle (degrees)	Tension Force Multiplier
85	1.0
65	1.1
60	1.2
50	1.3
45	1.4
40	1.6
35	1.7
30	2.0
25	2.4
20	2.9
15	3.9
10	5.8
5	11.5
4	14.3
3	19.1
2	28.7
1	57.3

Appendix H. Vector Analysis for Currents and Wind

The speed of the water past a boom can be calculated by using vector analysis. A vector is represented by a line having direction and magnitude. The effect of the wind is determined by multiplying the speed in knots by 3.5 percent. The two vectors can then be added in the manner described below. A calculator should be used to ensure correct results.

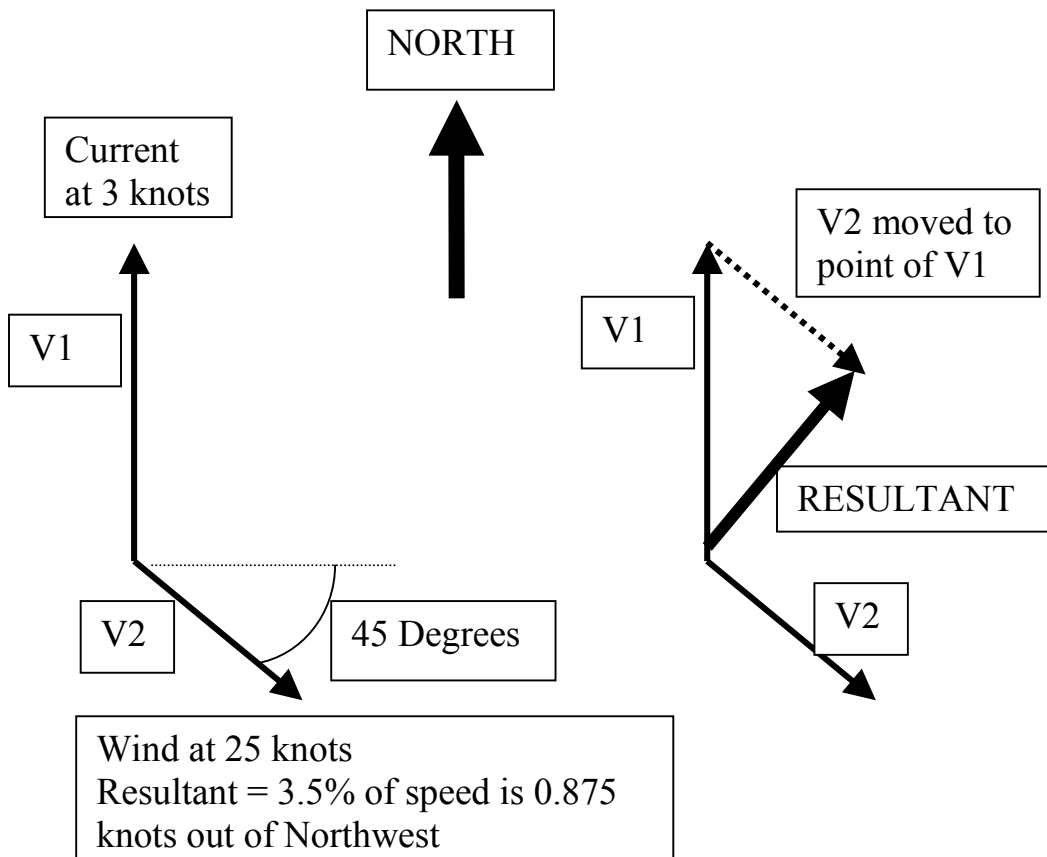

Graphically, the vector V2 is moved so that its tail is on the point of V1. This can be performed graphically by using parallel rulers. The resultant relative current is shown in bold. Using geometrical equations, the vectors are broken down in components in the y (north-south) direction and in the x (east-west) direction.

For the example above:

In the Y direction: $V1(y) = 3 \text{ knots}$
 $V2(y) = -\cos(45) \cdot .875 = .62$
 $V1(y) - v2(x) = 2.38 \text{ knots}$

In the X direction: $V1(x) = 0$
 $V2(x) = \sin(45) \cdot .876 = .62$

The resulting current looks like:

The length of the vector is:
 $= \text{SQRT}[(.62)^2 + (2.38)^2] = 2.45 \text{ knots}$
 Angle - $\tan^{-1}(2.38/.62) = 3.8 \text{ at } 75 \text{ Degrees}$

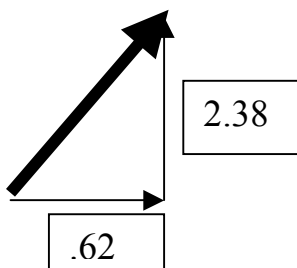

Another example using a radar transfer-plotting sheet can be found on page 2-20 of the U.S. Navy Salvage Manual.

Appendix I. Heavy Oils

Group V oils are defined in the Federal Register as "persistent" oils with a specific gravity greater than 1. The Coast Guard asked the National Research Council to research heavy oils in 1998 (National Research Council, 1999). The Committee on Marine Transportation of Heavy Oils used the term "nonfloating oil" to describe all oils that do not float on water. These oils move into the water column by the nature of their properties or by becoming mixed with sand or soil. These types of oils can be heavy crude oils, fuels oils, (such as No. 4, no. 6 and Bunker C) as well as asphalt, coal tar, carbon black coke and pitch. The committee found that from 1991-1996, approximately 23 percent of products spilled in United States waters were nonfloating oils, and barges accounted for about 80 percent of these spills. The committee also determined that tracking subsurface oil is difficult and few of the containment and recovery techniques are effective, especially in fast currents. The report can be accessed from the Internet ([see reference section](#)).

A general approach is provided by Brown (Brown, Owens, and Green, 1997) and is modified in the table below.

Table I-1. Guide to heavy oil response.

SITUATION ASSESSMENT	REMARKS
Can the oil be accurately located?	Visual - not very useful in fast currents unless oil stays at bottom and divers can locate Photobathymetric techniques - not good for changing bottom Water Column Sampling - only provides quick look Acoustic - has not been proven Grab Samples - good for bottom deposits Bottom Trawls - difficult to determine pre-existing conditions <i>In Situ</i> Detectors - only provides point evaluation but may be useful built near intakes
How long will the oil likely stay there?	Need knowledge of oil and local area
Is the oil likely to move, be eroded or be buried?	Very likely in fast currents
What are the environmental effects of the submerged or sunken oil?	Sensitive areas or wildlife Intakes
POSSIBLE OBJECTIVES (select only one)	
Allow to weather and disperse naturally	Reasonable for small spills with limited sensitive areas
Contain and recover all of the oil	Time-critical
Contain/recover as much oil as practical and safe	Time-critical
SELECT APPROPRIATE STRATEGIES OR TOOLS	
Containment	
Physical Barrier	If shallow enough, use dams or trenches
Silt Curtain	Not very good in fast currents, but multiple curtains could slow down or force oil to surface
Pneumatic Curtain	Difficult in fast current
Net Booms	Not effective in fast currents
Shrimp Netting	More effective when filled with debris but difficult to handle in fast currents.
Removal	
Vacuum pumps and air lift	Good for small areas, pump to shore provides more recovery options
Dredges	Consider environmental effects
Clamshells	Good for large pieces
Physical	Divers collect hard pieces, visibility is usually limited in currents
FEASIBILITY ANALYSIS	
Is the operation feasible logistically and is it safe?	Logistics are important
Are the appropriate resources available?	Contingency planning required
Can the objective be met with any degree of confidence?	Training needed
Will there likely be a net environmental benefit?	Determine the impact

As the table indicates, in shallow water with low flow rates, curtains and dams can be used. For known trouble areas or near intakes, dams and trenches can be pre-built but need to be maintained. Most of the removal techniques may require the use of divers to local the oil, but visibility is usually limited in fast currents and the manpower and logistics requirements are high.

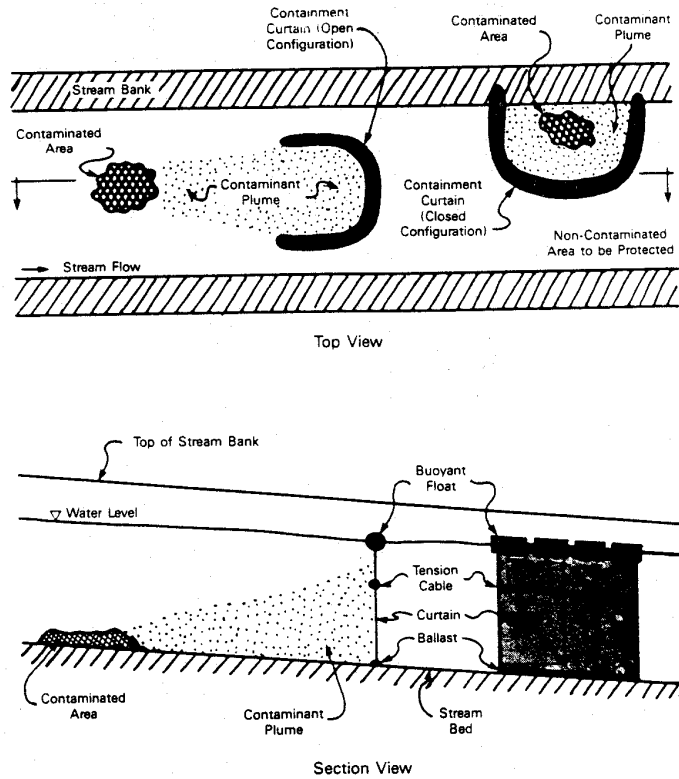

Figure I-1. Plume containment (U.S. EPA, 2000).

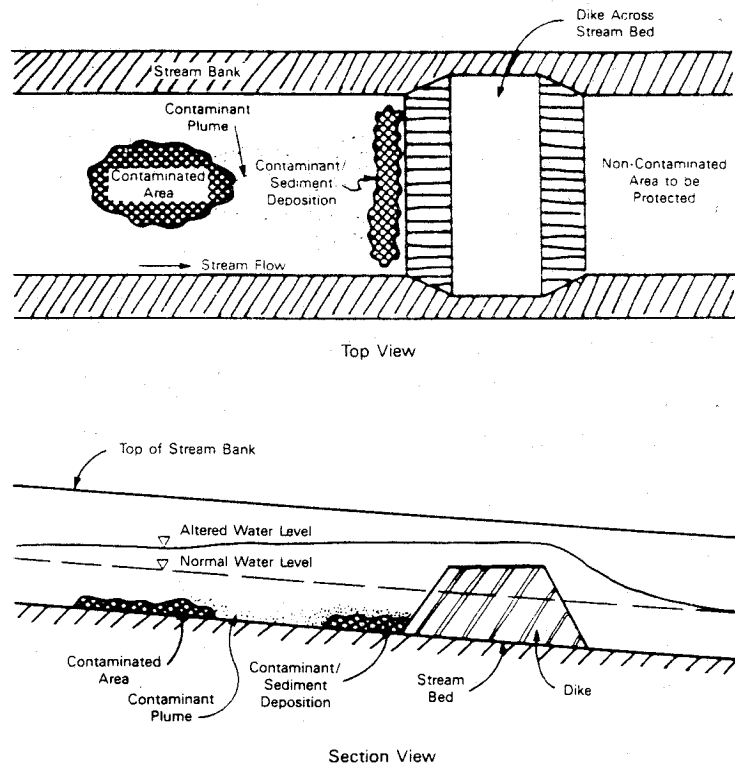

Figure I-2. Bottom containment (U.S. EPA, 2000).

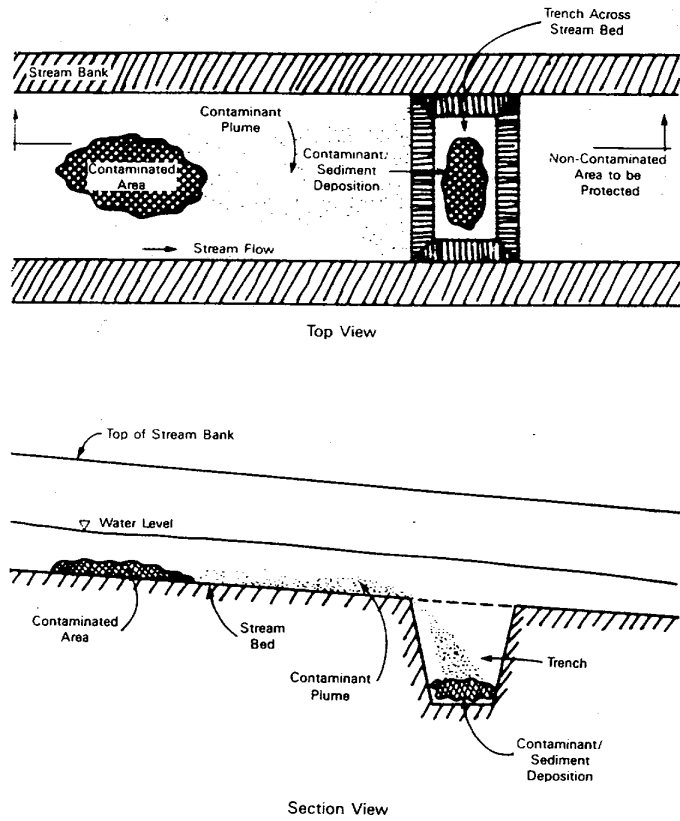

Figure I-3. Trench containment (U.S. EPA, 2000).

There are many barriers to an effective response for non-floating oils. These include the lack of contingency planning and the absence of information and resources available for a response. Discussions should be held with area committees, resources identified and training conducted so that the response can be started quickly and conducted safely.

Appendix J. Culvert Calculations

The major parameter in dealing with small streams and culverts is the flow rate, usually given in cubic feet per minute. There are many configurations for flow through a culvert and the results vary depending upon the input source, the slope and the outlet conditions. This appendix will provide some general guidance that will help to approximate flow conditions so that dam dimensions and pump sizes can be estimated.

Open Channel Flow

Flow for most streams and culverts can be approximated using the simple formulas for open channel flow. The equation that is used is:

$$Q = V \times A$$

Where Q = flow in cubic feet per second

V = velocity in feet per second. This can be easily calculated from Table F-1 or using a flow meter.

A = area of stream in square feet.

Some configurations and formulas for areas are given below. Use the ones that are the closest to the type culvert or stream being dammed.

Table J-1. Channel parameters (Streeter and Wylie, 1975), (CRC, 1973).

<u>CONFIGURATION</u>	<u>AREA</u>	<u>WETTED PERIMETER</u>
	$A = b \times h$	$P = b + 2h$
	$A = by + h^2$	$P = b + 2.8h$
	$A = 1/2 y^2$	$P = 2.8h$
	<p>If h (water level) is less than R (radius) then: $A = R^2 \cos^{-1}[(R-h)/R] - (R-h) [(2Rh-h^2)]^{1/2}$ or see table J-2</p> <p>If h is larger than R then: Calculate the total area = $\pi \times R^2$ And estimate how much of the opening has water and multiply by that fraction</p>	

Table J-2. Segments of a circle, given h/D (Baumeister, 1978).

h/D	Arc/D	Area/D²
.05	.451	.015
.1	.643	.041
.15	.795	.074
.2	.927	.112
.25	1.047	.153
.3	1.159	.198
.33	1.224	.226
.35	1.266	.245
.4	1.369	.293
.45	1.471	.343
.5	1.571	.393

Directions for Arc, multiply D x (arc/D) from chart
for Area, multiply D² x (area/D²) from chart

If the velocity cannot be determined because of obstructions, another method to calculate flow is the equation (Baumeister, 1978):

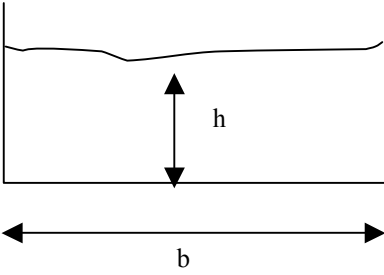
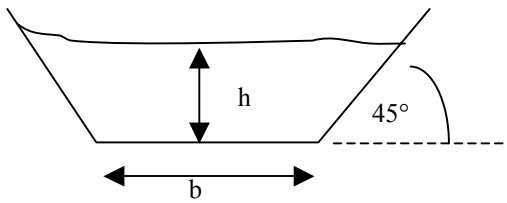
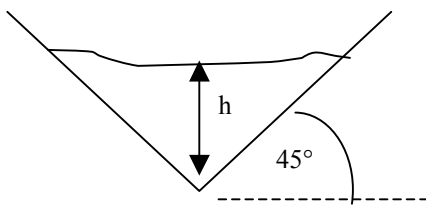
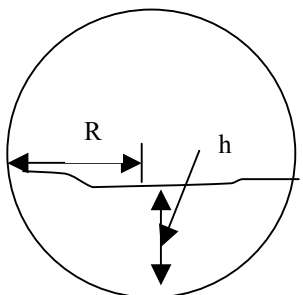
$$Q = \frac{1.49}{n} \times A \times R^{2/3} \times S^{1/2}$$

Where n = average roughness factor

Finished concrete = 0.012

Unfinished Concrete = 0.014

Corrugated pipe = .025

Earth and gravel = .03

A = area in square feet

R = hydraulic radius in feet (Area / wetted perimeter, see Table J-1)

S = slope in foot of drop per foot of length.

For example, if a culvert drops one foot over a 100-foot Length, the slope is 1/100 or 0.001.

Weirs

In some situations, if water is flowing so slowly or a slope is difficult to determine, flow can be calculated by the amount of water going over a dam before the oil arrives. The approach taken here is using weir calculations. A weir is a barrier that causes water to back up behind it and eventually flow over it. There are multiple configurations for the shapes and sizes of weirs but three general configurations will cover most of the conditions found in the field. These include the rectangular sharp-crested weir, a V-notch sharp-crested weir and a broad crested weir. The major measurement is to determine the height of the water that is being held back. The arrangements and equations for the three configurations are shown below where L is the width (Streeter and Wylie, 1975):

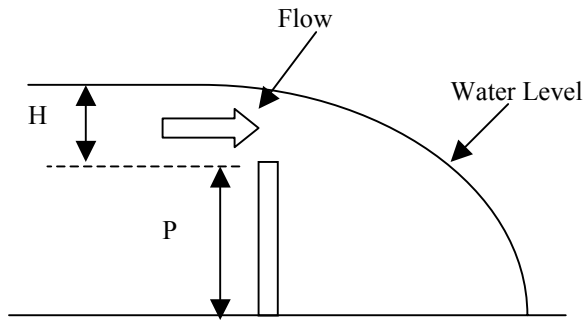

$$Q = 3.33 \times L \times H^{3/2}$$

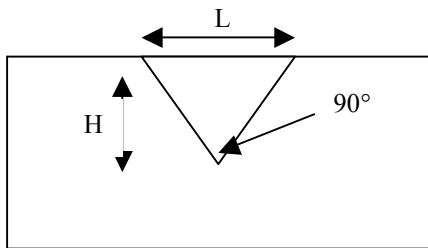

$$Q = 2.5 \times H^{2.5}$$

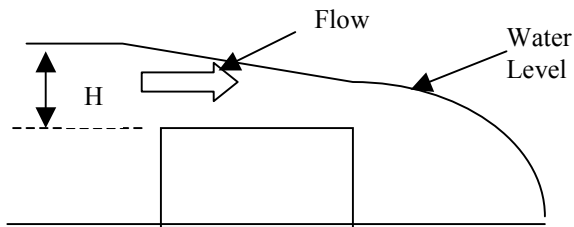

$$Q = 3.09 \times L \times H^{3/2}$$

Appendix K. Safety

Safety of response personnel is a primary objective in all spill response operations, and fast water response is no exception. A safety plan must be developed prior to the deployment of resources. Before deploying resources on scene, an operational risk assessment and site characterization must also be performed. Trained health and safety professionals must review the oil properties, toxicity and physical hazards, environmental factors and working conditions prior to deploying resources on scene (Title 29 Code of Federal Regulations, Part 1910.120). Under no conditions should response personnel be subjected to *unnecessary* risks for purely environmental reasons. Fast water response is more complex and inherently more dangerous than response in slower waters. *Fast water response should only be accomplished when the human health risk assessment and net environmental benefit indicate that responding in fast waters is a better alternative overall to recovery on shore or in calmer waters.*

Large brim hard hats and fireman helmets are not recommended because they can act as a scoop in swift water causing neck injuries. Use exposure suits, wet suits or dry suits for response personnel in cold-water conditions. Life jackets with zippers are preferred. Those equipped with clips or snaps are not recommended as they can get tangled with lines. If only life jackets with clips are available, consider wearing them inside out or turn the working end of the clip inwards towards the body to reduce the chance of snagging. A sharp knife, preferably those with one-handed opening design, should always be handy to cut lines if an emergency occurs. Due to the extreme forces on boom and skimmers in swift currents, personnel should avoid lines that are under tension. **Beware of line snap back in both directions.** A method to recover personnel who have fallen in the water should be in place. This should include a rescue boat, line throwers or a safety line. The safety line should be placed at an angle to the current.

Several organizations such as the American Canoe Association, Rescue 3 and PRI provide courses in fast water/swift water rescue ([see internet references](#)). In addition, many local Fire Departments have fast water rescue/recovery teams that can provide training in recovery procedures or be activated to assist as a safety measure when working in fast water environments.

Response operations pose many significant hazards and the following table lists some of the more prominent hazards. This list is not all inclusive, but is provided for planners and persons unfamiliar with response operations hazards that may be encountered.

HAZARD	INJURY POTENTIAL	CONTROL
Slips, Trips and Falls	Critical - broken ankles, arms, head injuries, etc.	<ul style="list-style-type: none"> • Avoidance • Proper footwear • Stabilizing lines • Walking mats • Hard hat/bicycle helmets
Ergonomic (Back strain)	Critical - back injuries, sprains, hernias, etc.	<ul style="list-style-type: none"> • Proper lifting • Proper tools • Minimal handling • Mechanical Assistance
Heat/Cold Stress, Environmental Exposure	Critical - Frost bite, heat stroke	<ul style="list-style-type: none"> • Proper clothing (Cold: dry, wet, exposure suits) • Proper eating & drinking • Work/rest periods • Medical Monitoring • Sunscreen/Sunglasses
Flammability	Critical - Fire/explosion	<ul style="list-style-type: none"> • Air Monitoring • Ventilation • Secure ignition sources • Beware of culverts, enclosed spaces, under piers, bottom of steep river banks

HAZARD	INJURY POTENTIAL	CONTROL
Oil Toxicity: Benzene, Toulene, Ethyl-benzene, Xylene, Polycyclic Aromatic Hydrocarbons, Hydrogen Sulfide, Benzo-a-pyrene, etc.	Critical: Carcinogens, asphyxiants, skin absorbers, dermatitis, eye irritation, central nervous system effects: nausea, dizziness	<ul style="list-style-type: none"> • Air monitoring • Respiratory protection • Dermal protection • Wait until toxics volatilize, verify through monitoring
Water (drowning)	<p>Critical - death, hypothermia</p> <p><u>Consider the following:</u></p> <ul style="list-style-type: none"> • Don't swim against current, Swim perpendicular • Swim on back, feet downstream • Use hands & feet to fend off obstructions • Do not tie rope around swimmer or rescuer • Angle rescue lines down current • Stay on upstream side of the line • Never clip into the line 	<ul style="list-style-type: none"> • Buddy system • Life jackets • Cold weather gear • Fall restraints • Life rings, boat hooks • Rescue boats • Avoid waders • Bicycle helmets can be substituted for hardhats only if no overhead hazards exist. • Avoid slip on fireman boots • Avoid loose clothing
Line Hazards	Critical – death, loss of limbs, eyes, broken appendages	<ul style="list-style-type: none"> • Keep free lines coiled • Keep (coiled) lines clear of work area • Have knife available to cut lines • Use “tattles” to warn of line breakage • Use safety observer • Use proper line plus large safety margin for force anticipated • Ensure “system” breaks at preferred “weak” link
Equipment Hazards: Power units, pumps, hoses, skimmers, control stands, etc.	<p>Critical and varied:</p> <ul style="list-style-type: none"> • Eyes from hydraulic lines • Noise from power units • Inhalation of diesel exhaust • Pinch points, cut points resulting in lacerations, bruises and finger loss 	<ul style="list-style-type: none"> • Goggles around hydraulic hoses • Hearing protection • Guards around danger points • Secure loose clothing & remove jewelry • Keep clear of exhaust

Appendix L. Technology Assessment

Technology Ratings

Booming strategies, specialized boom, alternate containment methods and high-speed skimmers are rated in several categories and presented in Table L-1. This is a general summary of their capabilities as discussed throughout the report. The rating process was based upon independent data, manufacturers' information, experience and engineering estimates. Technology names identified with an asterisk indicate that ratings are less reliable because data from controlled tests with oil were not available. Although data were used to determine the ratings whenever possible, rating determinations were made by the author in somewhat of a subjective manner for categories of: ease of deployment, effectiveness in debris/ice and effectiveness in shallow water. All category ratings, however, were reviewed, discussed and in some cases, revised based on input provided by participants at a ASTM F-20 committee meeting workshop. Direct comparison between individual technologies is not recommended due to the variability in the test conditions.

1. Highest Effective Speed

The highest effective speed rating assumes that the equipment being rated is used by people who have been trained and are experienced in fast water response with that technology. The speed in knots represents the highest practical current or speed of advance, as applicable, that the technology can still effectively deflect, contain or skim oil from the water. Calm water conditions are assumed. Effectiveness will generally be diminished at the higher velocities, however, the majority of the oil (more than 50 percent) encountering the device will be controlled or recovered as desired at that upper limit speed rating.

2. Effective in Waves

Effectiveness in waves is dependent upon the oil recovery rate and oil recovery efficiency or deflection/containment capability. Generally, a technology that has good reserve buoyancy, adequate freeboard and draft, or can be decoupled from the influences of waves, will continue to be effective in waves. Short-crested waves usually degrade the performance of equipment more than large long-period swells. A low (L) rating represents effectiveness in calm water conditions up to one-foot short crested waves. A medium (M) rating indicates effectiveness in short crested waves between 1 and 3-feet high, while a high (H) rating represents satisfactory performance in waves 3 to 6-feet high. Effectiveness in these conditions means that the technology will contain or collect the majority of the oil it encounters.

3. Effective in Debris/Ice

Floating debris will cause problems with equipment by damaging it, moving it or rendering it ineffective. Some equipment is less affected by debris and floating ice due to its robust nature or method of containment/recovery. Some skimmers use debris screens that protect the pump but often require manual tending to remove the debris. A high (H) rating means that the skimmer will continue to function well in floating debris and ice with minimal manual tending required. Medium (M) rating represents a degraded performance level in debris, while a low (L) rating indicates serious problems with performance in debris. Both M and L ratings require significant manual tending to remove debris.

4. Effective in Shallow Water

Effectiveness in shallow water indicates the technology has a low or no draft requirement and that it will effectively contain, deflect or remove oil as designed. A yes (Y) indicates that a skimmer or boom system is manufactured that is effective in 2-feet deep water or it is not limited by a water depth of two feet. It is possible that some skimmers or boom systems receiving a no (N) rating could be produced by the manufacturer to function in shallow water (if requested by a customer).

5. Ease of Deployment

The ease of deployment rating reflects the amount of complexity, training required, people and logistics involved to deploy and use the technology successfully. The more resources and training required to deploy the technology and use it effectively, the lower the rating. The faster a technology can be deployed with a minimum number of people and support equipment, the higher the rating. Generally, technology with a good (G) or a very good (VG) ease of deployment rating will continue to be effective close to the highest effective speed rating when using inexperienced personnel.

6. Oil Viscosity Range

A low (L) rating indicates that a skimmer is effective in light oil with a viscosity between 1 and 100 cSt. Medium (M) indicates effectiveness in medium grade oils with a viscosity between 100 and 1,000 cSt, while high (H) means the skimmer was effective at recovering heavy oil with a viscosity between 1,000 and 60,000 cSt. A skimmer was considered effective if tests recorded reasonable recovery rates and recovery efficiencies of at least 50 percent. If a viscosity range is not listed for a skimmer, then the skimmer is not effective at recovering oil in that viscosity range.

7. Oil Recovery Efficiency and Oil Recovery Rate

Skimmer specific performance ratings are based upon independent performance test data when available and manufacturer claims. When data were not available, physics and engineering principles were used to approximate performance. Generally, oil recovery efficiency will decrease and oil recovery rate will increase with speed. Technologies with the higher efficiencies and recovery rates that were not significantly degraded by increases in speed were given higher ratings. Skimmers with comparatively lower efficiencies and recovery rates that degraded quickly at faster speeds were given lower ratings. For details on skimmer performance, see discussions in the High-Speed Oil Skimmers section and cited references. Skimmers that demonstrated a poor (P) performance for recovery efficiency and/or oil recovery rate in currents above one knot were not included in this report and table.

**Table L-1. Technology assessment of strategies and equipment (from ASTM Committee F20) (Coe and Gurr, 1999)
Technology Ratings For Oil Containment and Recovery Systems In High Speed Currents (1-6 knots)**

Technology Name	Highest Effective Speed (kts.)	Effective in Waves ¹	Effective in Debris/Ice	Effective in Shallow ²	Ease of Deployment	Skimmer Specific Performance			Comments:
						Oil Viscosity Range ³	Oil Recovery Efficiency ⁴	Oil Recovery Rate ⁵	
Booming Strategies									
Cascade (DOWCAR Environmental)*	4	L	M	Y	F				Short sections independently moored to shore.
Deflection (Trans Mount. Pipeline)*	4	L	M	Y	F/G				Longer sections with shore tiebacks downstream.
Chevron (closed)*	3	M	M	Y	G				Quick to deploy because it uses fewer anchor points.
Chevron (open)*	3	M	M	Y	G				Allows for vessel traffic between openings.
Current Rudder (Blomberg Offshore)*	3	M	H	N	F				Allows for vessel traffic by control of rudder from shore.
Double Boom*	3	M	H	Y	F				Improved containment but hard to keep separated properly.
Boom Deflectors (Envirotech Nisku)*	4	M	M	Y	G				Deflectors used to keep boom at an angle without anchors.
Boom (Specialized)									
Fast Sweep (V-Shaped)	1.5	H	L	N	G				Net across foot of boom keeps it in a V-shape.
Rapid Current Boom (UNH)	2.5	L	L	N	P				Inclined plane, fabric bottom with outlet holes in pocket.
Horizontal Oil Boom	2.5	M	L	N	F				Two booms connected by net & filter fabric.
Holes in lower draft*	2	M	L	N	G				Larger draft with relief holes in lower skirt to reduce drag.
Net in foot of boom (NOFI)	1.3	H	L	N	G				Short vertical net at foot of the boom.
Foam 6" X 6", two tension lines*	4	L	L	Y	VG				Typical fast water diversion boom with upper & lower tension.
External Tension Line foam	2	M	L	N	F				High stability, limited reserve buoyancy.
Shell High Current "Boom"	3	L	M	Y	P				Rigid aluminum perforated inclined plane structure, diversion system.
Alternate Methods									
Pneumatic Boom	1.5	M	H	N	G				High power required (30 hp/ft).
Water Jet (Horizontal)	3.5	M	M	Y	F				Reasonable power requirements (3 hp/ft).
Water Jet (Plunging)	4	M	M	N	F				Reasonable power requirements.
Air Jet	3	M	M	Y	F				Low power required (1 hp/ft).
Flow Diverters (paravanes)	6	H	M	Y	VG				No power, changes surface currents to direction of anchor point.
Floating Paddle Wheel	3	M	M	Y	G				Low power required (0.25 hp/ft), high-energy transfer.
Earth Dam (underflow)*	2	M	M	Y	P				Barrier blocking low flow into an inlet or out of a stream.

Technology Name	Highest Effective Speed (kts.)	Effective in Waves ¹	Effective in Debris/Ice	Effective in Shallow ²	Ease of Deployment	Skimmer Specific Performance			Comments:
						Oil Viscosity Range ³	Oil Recovery Efficiency ⁴	Oil Recovery Rate ⁵	
Skimmers									
Incline Skimmers									
Dynamic (JBF)	3	M/H	M	Y	G	L,M,H	G	G	VOSS & self propelled versions.
Static (Hyde Products)	5	M/H	M	N	G	L,M,H	G	G	VOSS, low maintenance
ZRV Skimmer									
Rope Mop (Ro-Clean Desmi)	5	H	H	N	G	L,M,H	VG	F	VOSS & self propelled catamarans
Sorbent Belt (USCG)	6	M	M	N	G	L,M,H	VG	F	Very high maintenance but effective
Quiescent Zone									
Expansion Weir (Vikoma)*	3	L	L	Y	G	L,M	F	G	Expansion slows flow
Circulation Weir (Blomberg Circus)*	3	M	L	Y	G	L,M,H	G	G	VOSS, portable lagoon
Brush Conveyor (Lori)	3	M/H	M/H	N	G	M,H	VG	F	VOSS, barge & self-propelled
Streaming Fiber & Belt (USCG)	3	M	L	N	G	L,M	G	F	Fibers slow flow, belt & weir remove oil
Lifting Belt									
Filter Belt (Marco)	3.5	M/H	M/H	Y	G	M,H	VG	F	Self-propelled & induction impeller
Rotating Disk Brush									
Rotating Brushes (Lamor)	3	M/H	M/H	Y	G	M,H	VG	G	VOSS, barge & self-propelled
Surface Slicing									
High Current Oil Boom	6	L	L	N	G	L,M,H	F	G	Weir with foil bow
Multi-purpose Oil Skimmer Sys.	3	M/H	L	N	G	L,M,H	F	G	Wave following weir
Russian Debris Skimmer	3	L	M/H	N	G	L,M,H	G	G	Debris filter, weir and gravity separator tank.
Trailing Adsorption									
Trailing Rope Mop (Force 7)*	4	H	H	N	F	L,M,H	VG	F	Batch processing requires retrieval of rope mops and paravane.
Free Floating Sorbent*	5	H	H	Y	G	L,M,H	VG	F	Free drifting sorbents and recover them downstream
Legend									
	H	High		Y	Yes		VG	Very Good	
	M	Medium		N	No		G	Good	
	L	Low					F	Fair	
							P	Poor	
Notes:									
	1. Low is effective in calm water to 1 foot waves, Medium is effective in 1 to 3 foot waves, and High is effective in 3 to 6 foot waves								
	2. Yes indicates that a skimmer or boom system is effective in 2 foot of (shallow) water.								
	3. Low indicates a skimmer is effective in light oil 1-100 cSt viscosity, Medium 100-1,000 cSt and High 1,000-60,000 cSt								
	4. Oil recovery efficiency is the percent of oil recovered compared to the total volume of oil and free water collected.								
	5. Oil recovery rate is the rate of oil collected which is a combination of recovery efficiency and throughput efficiency.								
	* Controlled tests results with oil were not available so ratings were based on engineering principles, expert opinions and field experience. Technology names with no asterisk were rated based upon data obtained from controlled tests with oil.								

Appendix M. Notes

REFERENCES

- Alaska Clean Seas (1998). Boom Deployment on Rivers (SC05), Course Curriculum.
- Allen, Alan A. (1979). Containment and Recovery Techniques for Cold Weather, Inland Oil Spills. 1979 International Oil Spill Conference, Crowley Environmental Services, Alaska.
- Arctic Council (1998, September). Field Guide for Oil Spill Response in Arctic Waters, Emergency Prevention, Preparedness and Response Working Group.
- Baumeister, Theodore (1978). Marks' Standard Handbook for Mechanical Engineers, 8th Edition, Editor, McGraw-Hill, New York.
- Berteaux, Henri O. (1991). Coastal and Oceanic Buoy Engineering, Woods Hole, MA.
- Brown, H. M., Owens, E.H., & M. Green (1997). Submerged and Sunken Oil, Behavior Response, Options - Feasibility and Expectations. Proceedings of the Twentieth Arctic and Marine Oilspill Program (AMOP) Technical Seminar, Environmental Canada, ON.
- Coe, Thomas, & Gurr, Brian (1999, May). Control of Oil Spills in Fast Water Currents, A Technology Assessment (CG-D-18-99). Groton, CT: USCG Research & Development Center.
- Cohen, Steven H., Lindemuth, William T., & Farlow, John S. (1979). Development and Tests of an Air-Jet Oil Boom. 1979 International Oil Spill Conference.
- Comfort, G., Menon, B., & Noble, P. (1979). Feasibility of Air and Water Spray Barriers for the Collection, Concentration and In-Situ Burning. Proceedings of the Arctic Marine Oilspill Program Technical Seminar, Environment Canada, Ontario.
- Counterspill Research, Inc. (2000, March). Field Trials of the NOFI Current Buster 600, prepared for the Canadian Coast Guard.
- CRC (1973). Standard Mathematical Tables, CRC Press, Chemical Rubber Company, Cleveland, OH.
- DeVitis, David, Nolan, Kathleen, & Kurt Hansen, (2000, November). Evaluation of Four Oil Spill Recovery Systems in Fast Water Conditions at Ohmsett (CG-D-18-99). Groton, CT: USCG Research & Development Center.
- DOWCAR Environmental Management, Inc. (DOWCAR, 1997). Inland Waters Oil Spill Response, Training Manual, Vol. 1.
- Eryuzlu, N. E., & Hausser, R., (1977). Use of Floating Deflectors for Oil Spill Control in Fast Flowing Waters. 1977 Oil Spill Conference, Canadian Coast Guard.
- Exxon (1992). Oil Spill Response Field Manual, Exxon Production Research Co.
- Farlow, John S., & Cunningham, John M. (1993). Plunging Water Jets: Evaluating an Innovative High-Current Diversionary Boom. 1993 International Oil Spill Conference Proceedings, U.S.EPA.
- Freestone, Frank, Anderson, Reg, & Trentacoste, Nicholas (1975). US EPA Research in High-Speed Devices for the Recovery of Thin-Film Oil Spills. 1975 Conference on Prevention and Control of Oil Pollution, EPA and others.
- Hancock, J. A., Jacobs, R. P., & Knapp, M. R. (1974). Waterborne Debris in Marine Pollution Incidents, Columbus Laboratories.

Hansen, Kurt (1999, September). Columbia River Fast Water Tests, <http://www.rdc.uscg.gov/reports/CR.pdf>.

Hansen, Kurt A. (2000, June 14-16) Equipment Evaluation of Fast-Water Oil Recovery Equipment. Proceedings of the Twenty-Third Arctic and Marine Oilspill Program (AMOP) Technical Seminar, Environment Canada, Ontario.

Hansen, Kurt A., DeVitis, Dave, Potter, Steve, Ellis, Stewart, & Coe, Thomas (2001, June 12-14). Evaluation of Fast-Water Recovery Equipment. Proceedings of the Twenty-fourth Arctic and Marine Oilspill Program (AMOP) Technical Seminar, Environmental Canada, Ontario.

Hayes, Miles O. & Montello, Todd (1995). The Development of Potential Protection Strategies for Tidal Inlets, 1995 International Oil Spill Conference, Research Planning Inc.

Laperriere, F., Whittaker, H., & Yanagisawa, M. (1987). High Pressure Water Jet Testing for Oil Containment in Simulated Environmental Conditions. Proceedings of the 10th Arctic Marine Oilspill Program Technical Seminar, Environment Canada, Ontario.

Lichte, H. W., & Breslin, M. K. (1998). Performance testing of Three Offshore Skimming Device, EPA-600/7-78-082, Mason & Hanger-Silas Com. Inc., 1978.

Mar, Inc. (1994, November). OHMSETT Tests of Lori LSC-2 Skimmer Systems (CG-D-17-94), Groton, CT: USCG Research & Development Center.

McCarthy, Dennis, Clean Harbors Cooperative, Linden, NJ.

Nash, J. H., & Johnson, M.G. (1981). Coherent, Plunging Water Jets for Oil Spill Control. 1981 International Oil Spill Conference Proceedings.

National Research Council (1999). Spills of Nonfloating Oils, Risk and Response, National Academy Press, Washington, D.C.

National Spill Control School (1998, May). Oil Spill Response and Safety, Texas A&M University-Corpus Christi, 2nd Edition.

Nordvik, Atle B., Sloan, Stacy, & Stohovic, Joe (1995). Phase 3, Oil Containment Boom At-Sea Performance Tests, Technical Report Series 95-003, Marine Spill Response Corporation (MSRC), Research and Development Program.

ORC AB (2000). Boom Vane Manual, 2nd Version, <http://www.orc.se>.

Potter, Steve, James McCourt, & Robert Small. (1999, June 2-4). Estimation of Towing Forces on Oil Spill Containment Booms. Proceedings of the Twenty-Second Arctic and Marine Oilspill Program (AMOP) Technical Seminar, Environment Canada, Ontario.

PROSCARAC (1992). Prairie Regional Oil Spill Containment and Advisory Committee. Anchor Design and Deployment Review, prepared by Paul Wotherspoon & Associates Inc., Calgary, AB, Canada.

Schulze, Robert (1998). Oil Spill Response, Performance Review of Skimmers. Manual Series, MNL34, American Society for Testing and Materials.

Texas Boom Company, Inc. (1997). Tideboom Series (Shorebarrier), Houston, TX.

Streeter, Victor L., & E. Benjamin Wylie (1975). Fluid Mechanics, 6th Edition, McGraw-Hill, New York.

Telford, A. S., & Quam, H. A. (1979). Oil Recovery from Under River Ice. 1979 International Oil Spill Conference, Esso Resources Canada, Ltd.

U.S. EPA (2000). District 10 Oil and Hazardous Substances Response Manual, CD-ROM Seattle, WA.

U.S. Navy (1990). U.S. Navy Salvor's Handbook, S0300-A7-HBK-010/0910-LP-107-7300, Naval Sea Systems Command and JMS Publishing.

U.S. Navy. (1991, December). U.S. Navy Ship Salvage Manual Vol. 6 (Oil Spill Response), JMS Publishing, Groton, CT.

U.S. Navy (1990). Various manufacturers' specifications.

Williams, R.E., & Cooke, T.S. (1985). Feasibility of Using a Bubble Barrier for the Containment/Incineration of Spilled Oil. Proceedings of the 8th Arctic Marine Oilspill Program Technical Seminar, Environment Canada, Ontario, p 214.

INTERNET REFERENCES

Related Web-Based Links

The following web-based links have been included in the field guide to provide the user a quick reference to related Internet web pages:

WEBSITE	INFORMATION
• http://water.usgs.gov/public/realtime.html	Near real-time river stream flow and stage height data
• http://www.nrt.org/	National Response Team
• http://response.restoration.noaa.gov/oilaid.html	NOAA Response Aids
• http://www.epa.gov/oilspill/index.htm	EPA Web Site
• http://www.epa.gov/region5oil/datamap.html	EPA Region 5
• http://www.uscg.mil/hq/g-m/nmc/response/	USCG Response Publications and ICS Job Aids
• http://www.mms.gov/offshore/	Minerals Management Service (MMS)
• http://www.glo.state.tx.us/oilspill/	Texas General Land Office
• http://www.usace.army.mil/	US Army Corps of Engineers
• https://www.denix.osd.mil/denix/Public/News/Army/Dig/toc.html *	US Army Corps Response Manual
• http://www.rdc.uscg.gov/	US Coast Guard R&D Center
• http://www.ohmsett.com/	MMS Ohmsett Facility
• http://www.freshwaterspills.net/	Great Lakes Commission
• http://www.nrc.uscg.mil/index.htm	CG National Response Center
• http://www.nap.edu/books/0309065909/html/	NRC, Spills of Nonfloating Oils
• http://www.acanet.org/acanet.htm	American Canoe Association
• http://www.swiftwater-rescue.com/	P.R.I. Rescue Training Specialists
• http://www.h2orecue.com/	Rescue 3 International
• http://www.arctic-council.org/flguide/index.asp	Arctic Council Field Guide for Oil Spill Response
• http://www.freshwaterspills.net/	Freshwater Spills Information Clearinghouse

* If unable to link, please type in Internet address to access site.