

Shoreline Assessment Manual

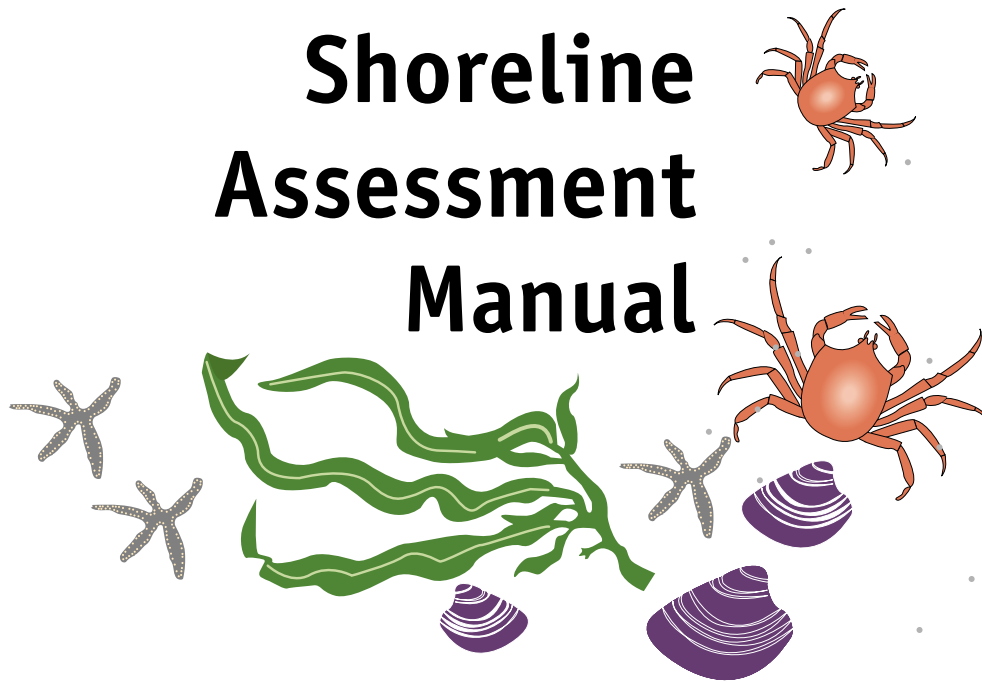

Third Edition

Office of Response and Restoration
Hazardous Materials Response Division
National Ocean Service
National Oceanic and Atmospheric Administration
7600 Sand Point Way NE
Seattle, Washington 98115

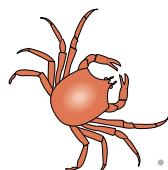

Shoreline Assessment Manual

Office of Response and Restoration
Hazardous Materials Response Division
National Ocean Service
National Oceanic and Atmospheric Administration
7600 Sand Point Way NE
Seattle, Washington 98115



CITATION NOAA. 2000. Shoreline Assessment Manual, Third Edition.
HAZMAT Report 2000-1. Seattle: Office of Response and Restoration,
National Oceanic and Atmospheric Administration.
54 pp. + appendices.

United States
Department of Commerce
Norman Y. Mineta
Secretary

National Oceanic and
Atmospheric Administration
D. James Baker
Under Secretary for Oceans
and Atmosphere

National Ocean Service
Margaret A. Davidson (Acting)
Assistant Administrator
for Ocean Services and
Coastal Zone Management

Purpose and use of this guidance

This manual and any internal procedures adopted for its implementation are intended solely as guidance. They do not constitute rulemaking by any agency and may not be relied upon to create a right or benefit, substantive or procedural, enforceable by law or in equity, by any person. Any agency or person may take action at variance with this manual or its internal implementing procedures.

Table of Contents



	Page
1 The Shoreline Assessment Process	1
2 The Flexibility of Shoreline Assessment Methods	5
“Geographic” Shoreline Assessments	6
“Topical” or “Hot-Spot” Shoreline Assessments	6
Other Examples of Shoreline Assessments customized to Spill Conditions	8
3 Responsibilities of the Shoreline Assessment Team	11
4 Roles of the Shoreline Assessment Team	13
Team Coordinator	13
Field Team Leader	14
Agency Representatives	14
Operations Representative	15
5 Shoreline Assessment Activities	17
5.1 Aerial Reconnaissance Survey	19
5.2 Segmenting the Shoreline	20
5.3 Developing Spill-Specific Cleanup Guidelines and Endpoints	22
5.4 Pre-survey Planning and Team Assignments	29
5.5 Shoreline Surveys	30
5.6 Submitting Reports to Planning Section	31
5.7 Cleanup Evaluation/Effectiveness Monitoring	32
5.8 Post-Cleanup Inspections	33
5.9 Final Sign-off of Cleanup Activities	34

Contents (cont'd)

Page

6	Shoreline Survey Terminology, Codes, and Forms	35
	Field Survey Terms, Codes, and Forms	35
	Information Flow and Formats	44
7	Planning for Shoreline Assessments	51
8	Pre-Impact Assessments	53
9	References	55

Appendices

- A** Shoreline Assessment Equipment Checklist
- B** Brief Descriptions of Shoreline Cleanup Methods
- C** Shoreline Descriptors, including Oil Behavior and Response Considerations
- D** Copies of Shoreline Assessment Forms, Form Explanations or Codes, Sketch Map Form, and Field Estimators
- E** A Primer on Drawing Field Sketches

Contents (cont'd)

List of Figures

Page

1	The Unified Command Structure (UCS)	3
2	Example of "Topical" cleanup guidelines for a shoreline type	8
3	Example of a shoreline division and segment map	21
4	A hierarchy of endpoints for shoreline cleanup	24
5	Shoreline oil terminology/codes for spills of black oil	36
6	Shoreline oil terminology codes for spills of light, refined oil	37
7	Shoreline oiling summary form	38
8	Short shoreline assessment form for medium-sized spills	39
9a	Tarball shoreline assessment form	40
9b	Wetlands shoreline assessment form	41
10	Matrix for defining terms for shoreline oiling summaries	42
11	Example of shoreline assessment field sketch showing use of symbols	44
12	Shoreline assessment information flow	45
13	Example of shoreline assessment report from the 1996 <i>Buffalo 292</i> spill, Galveston, Texas	47
14	Example of shoreline assessment report from the 1996 <i>Cape Mohican</i> spill, San Francisco, California	48
15	Example of shoreline oiling summary map from the 1996 <i>Julie N</i> spill in Portland, Maine	49

Acknowledgments

NOAA appreciates the contributions of the reviewers, Gary Sergy, Environment Canada; Edward Owens, Owens Coastal Consultants; Buzz Martin, Texas General Land Office; and Lieutenant James Hanzalik, U.S. Coast Guard Gulf Strike Team.

1 The Shoreline Assessment Process



When spilled oil contaminates shoreline habitats, responders must survey the affected areas to determine the appropriate response. Although general approvals or decision tools for using shoreline cleanup methods can be developed during planning stages, responders' specific cleanup recommendations must integrate field data on shoreline habitats, type and degree of shoreline contamination, and spill-specific physical processes. Cleanup endpoints must be established early so that appropriate cleanup methods can be selected to meet the cleanup objectives. Shoreline surveys must be conducted systematically because they are crucial components of effective decisions. Also, repeated surveys are needed to monitor the effectiveness and effects of ongoing treatment methods (changes in shoreline oiling conditions, as well as natural recovery), so that the need for changes in methodology, additional treatment, or constraints can be evaluated.

This manual outlines methods for conducting shoreline assessments and incorporating the results into the decision-making process for shoreline cleanup at oil spills.

During a spill response shoreline assessment is a function that is commonly conducted under the Environmental Unit within the Planning Section of the Incident Command System (ICS). Further information regarding ICS and response structures and roles can be found in the Field Operations Guide (FOG) (USCG 2000). Figure 1 highlights how the shoreline assessment function fits into a typical ICS structure. Depending on the complexity of the spill response, the Technical Specialist role may actually exist as a team. The teams are often made up of representatives from state and federal resource agencies, the responsible party and the USCG or USEPA and should be trained and knowledgeable in their roles. Members of the team can be 1) Shoreline Assessment Coordinator and 2) Shoreline Assessment Team Leader or 3) Team member.

Bringing their agency's expertise, Shoreline Assessment Teams collect the data needed to develop a shoreline cleanup plan that maximizes the recovery of oiled habitats and resources, while minimizing the risk of injury from cleanup efforts. Consideration should always be given to:

- Potential for human exposure, by direct contact or by eating contaminated seafood;
- Extent and duration of environmental impacts if the oil is not removed;
- Natural removal rates;
- Potential for remobilized oil to affect other sensitive resources; and
- Likelihood of cleanup to cause greater harm than the oil alone.

Information from these assessments must meet the requirements of the cleanup operation, being both timely and of uniform quality and content. Finally, the teams must coordinate their field activities with the operational Divisions working in the areas being assessed. This ensures that all operations are conducted safely and that important information is exchanged.

The Shoreline Assessment Coordinator should be designated to manage the teams and synthesize their field data into reports used by the Environmental Unit and Planning Section to support the daily Incident Action Plan (IAP). The information and recommendations generated are used by the Planning Section and implemented by the Operations Section in shoreline cleanup. The National Oceanic and Atmospheric Administration's (NOAA) Scientific Support Coordinator (SSC) can help identify and coordinate staff to form the teams.

Other positions in the response structure may be involved in shoreline assessment. One such position is the Field Observer. They are usually two-person teams (sometimes called Rapid Assessment Teams) made up of representatives from the U.S. Coast Guard and the State lead agency that quickly deploy to problem sites to determine what is happening. The Field Observers report directly to the Situation Unit Leader who in turn communicates their information to other units in Planning and Operations. At least one of the Field Observers on the two-person team should have an operations background, with the other member trained in shoreline assessment.

Figure 1.
The Unified Command Structure (UCS).
Shoreline Assessment Teams and Technical Specialists under the Planning Section collect information on shoreline oiling conditions to support cleanup decision making. They can be involved in all phases of the cleanup until segments are signed off as complete.

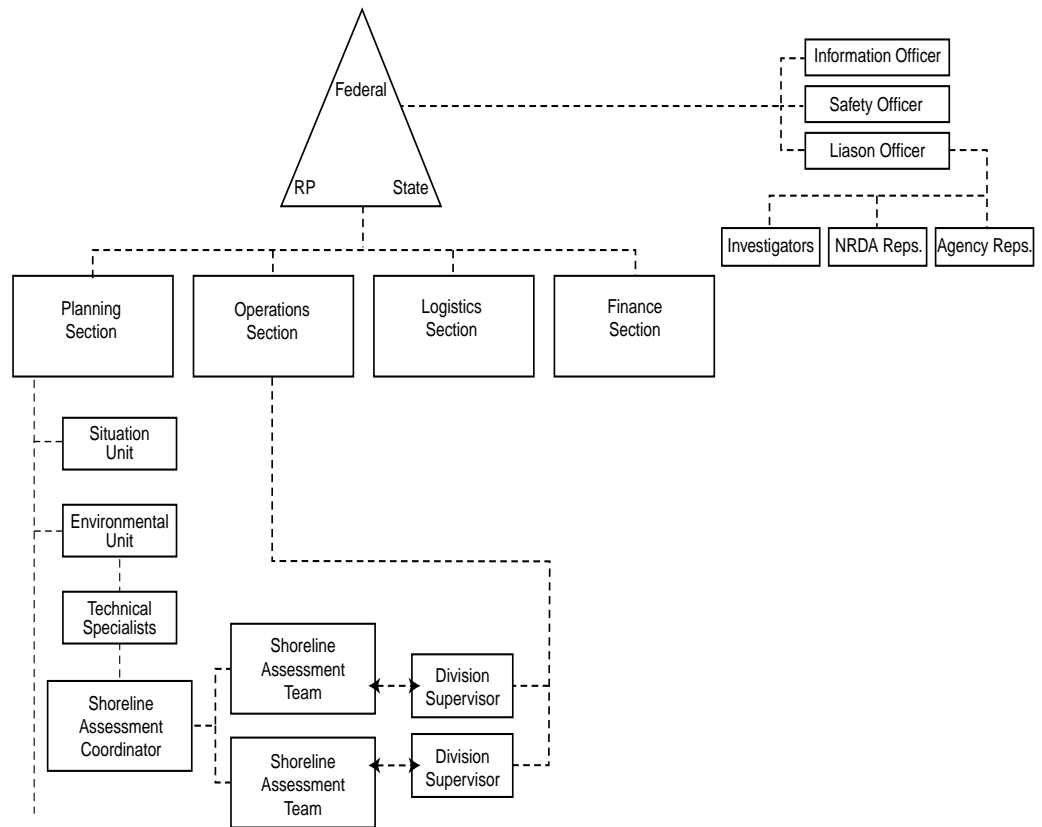

Shoreline assessment supports the response cleanup objectives and mandates of the response operations, as directed and managed by the Incident Commanders. Appropriate staff from all stakeholders in the spill response are involved in this activity. Problems have arisen in the past when agency and responsible party (RP) representatives were unavailable to support the response operational needs because of their focus on natural resource damage assessment (NRDA) activities. Much of the information collected during shoreline assessments applies directly to natural resource damage assessments and is readily shared. The shoreline assessment data must be collected quickly since it is necessary for operational decision-making. Experience has shown that the dual objectives of NRDA and shoreline assessment are best met when field surveys for these activities are well coordinated. A typical ICS structure includes a NRDA Representative who works through the Liaison Officer at the Command Staff level. The NRDA representative is responsible for coordinating NRDA needs and the activities of the Natural Resource trustees.

A commonly used acronym for all these activities is SCAT. This stands for *Shoreline Cleanup Assessment Team*, a name first developed during the *Exxon Valdez* oil spill (Owens & Teal 1990). SCAT programs have been adopted in many areas, particularly Canada, where SCAT manuals have been developed for the Atlantic Coast, Great Lakes, and British Columbia (Environment Canada 1992). The Texas General Land Office has incorporated SCAT teams into its response organization. However, SCAT has different connotations in different areas. Throughout this manual, we use “shoreline assessment” instead of SCAT to describe a process consistent with the basic objectives listed above.

The following sections of this manual describe the organizational and technical aspects of conducting a shoreline assessment. This manual is designed to be used as a field guide as well as a training tool.

At times, the needs or interests of private land users may not be fully addressed during spill response, since emergency-response cleanup objectives are developed specifically to protect natural resources and maximize recovery.

**Information needs
early in the spill**

In the initial phase of a spill, the conditions may require immediate information on shoreline oiling in order to deploy cleanup contractors to problem areas. The Unified Command can direct Field Observers, who are organized under the Situation Unit, to gather such information. As well as knowing accepted terminology and cleanup guidelines, Field Observers must understand the key agency concerns about a spill, such as the types of shoreline or resource issues that need to be addressed by a Shoreline Assessment Team before the startup of cleanup activities. In some cases, Field Observers can scout-out spill areas to identify sites where shoreline assessment surveys are needed.

2 The Flexibility of Shoreline Assessment Methods

What is a Shoreline Assessment Program?

- A systematic approach that uses standard terminology to collect data on shoreline oiling conditions and support decision-making for shoreline cleanup;
- Flexible in terms of scale of the survey and detail of the data sets collected; and
- Multi-agency, with trained representatives from all interested parties, who have authority to make decisions:
 - Federal On-Scene Coordinator (FOSC)
 - Member of the NOAA Scientific Support Team
 - State On-Scene Coordinator (SOSC)
 - Resource managers (state and Federal agencies)
 - Responsible party (RP)
 - Landowners

The shoreline assessment process should be easily modified to fit the spill conditions; it should be as simple as possible, yet comprehensive enough to address all of the issues and concerns of shoreline cleanup. It must not be a slow, cumbersome process that keeps Planning and Operations waiting for key data. When delays occur, Operations will be forced get the information it needs on its own, and thus the work products of the Shoreline Assessment Teams will not be used. Two types of shoreline assessment are outlined below, representing a range of complexity. Many spills will require some elements of both: detailed surveys of specific problem areas, and application of general guidelines for cleanup of shorelines with simple cleanup requirements.

**“Geographic”
Shoreline
Assessments**

This assessment approach generates site-specific recommendations on resource protection and cleanup methodology.

involve...

- Completing forms and sketches for each segment; and
- Making detailed cleanup recommendations unique to each segment, identifying specific locations to be cleaned.

are used for...

- Very small spills where all sites can be readily inspected by the same team;
- Very large spills where many teams are required;
- Sites where many different shorelines types have been oiled; and
- Areas where full documentation of oiling conditions is required, such as:
 - Spill conditions where cleanup problems are not readily apparent (e.g., buried oil that must be located by digging, and when repeated surveys are needed to ensure that removal is complete); and
 - Areas with resource constraints that need to be specifically identified in the field.

**“Topical” or
“hot spot” shoreline
assessments**

This assessment approach is based on the assumption that the Operations Division Managers (who are responsible for directing the cleanup in a specific geographic area using several types of resources, such as task forces) can successfully implement spill-specific cleanup guidelines, thus reducing the need for site-specific surveys. Most often, this approach is appropriate when the degree of oiling is relatively uniform or uncomplicated, or when the shoreline type is not particularly sensitive, such as man-made structures. The cleanup guidelines should be detailed enough to prevent confusion about their use. Terminology used in the guidelines should reflect local usage (e.g., use “seaweed” rather than “brown algae” or “*Fucus*” if that is what the cleanup workers call it). **Figure 2** is an example of general cleanup guidelines.

involve...

- Conducting familiarization surveys by the team to identify oiling conditions and cleanup issues for each shoreline type or resource of concern;
- Developing spill-specific cleanup guidelines for each shoreline type, to be implemented in the field by Division Managers;

**“Topical” or
“hot spot” shoreline
assessments (cont.)**

- Meeting with Division Managers to make sure that they understand the cleanup guidelines, what leeway they have in implementing them, and the key issues of concern to the resource agencies;
- Spot-checking cleanup operations for compliance with cleanup guidelines and effectiveness toward achieving target cleanup endpoints; and
- Responding to requests from Operations to resolve “hot spot” problems encountered during cleanup activities.

are used for...

- Small-volume spills that spread over very large areas (such as stranding of tarballs on Gulf of Mexico beaches);
- Man-made shoreline types, such as seawalls, with few site-specific sensitive resource issues; and
- Cleanup work that continues for very long times because of chronic re-oiling or seasonal changes in shoreline oiling.

**Other examples of
shoreline
assessments
customized to spill
conditions...**

**Tarball assessments
during the Buffalo 292
spill (Galveston)**

The cleanup of the *Buffalo 292* spill at Galveston, Texas in March 1996 was divided into two phases: the first 12 days of the spill, when much of the oil stranded along the upper Texas coast near Galveston; and the next several weeks, when tarballs spread to the mid- and lower Texas coast, beyond Corpus Christi (Martin et al. 1997). During the first phase, a full geographic shoreline assessment was effectively conducted. However, the approach changed when the tarballs stranded on remote beaches with few structures, roads, or other landmarks to reference during surveys and communications. Instead of filling out forms and making sketches, the team:

- Established mile marker stakes at 1-mile intervals on the beach, with operational zones and shoreline segments then redefined in terms of the mile markers;
- Recorded the concentration and distribution of tarballs between the mile markers, using standard terminology;
- Used surveyors’ flags to mark buried oil locations for the cleanup crews;
- Reported the shoreline impact descriptions by cellular phone to the Command Post (eliminating the need for face-to-face briefings); and
- Generated tabular reports by the Team Coordinator that were submitted to Planning and then Operations.

Figure 2.
Example of “topical”
cleanup guidelines for
a shoreline type.

GUIDELINES FOR HOT-WASH OF OILED RIPRAP/BULKHEADS

Julie N Spill, Portland, Maine

October 4, 1996

- Water temperature of hot wash not to exceed 40°C.
- Spray nozzle will be held at a distance of 6 inches or greater from the surface. All spraying/flushing will be into water for collection.
- No attached seaweed will be sprayed with hot water.
- Once the water level reaches the seaweed, hot-water washing will be terminated.
- Once hot-water washing is terminated, all released oil will be recovered immediately. Cold-water flushing of the seaweed is allowed when oil has accumulated in it.
- Removal of heavily oiled seaweed will be allowed in specified areas identified by the Shoreline Assessment Team. If seaweed is to be cut, the root attachment and a 12-inch stem will be left.
- Cold-water flushing will be conducted until no more oil is mobilized.
- Hot wash will be repeated until no free oil is released by the hot wash and no more than a stain (can't be scraped off with a fingernail) remains on the surface.
- Sorbents will be deployed along areas where sheens are being released from the shoreline.

***NOTE: These guidelines will be revised, as needed,
in response to changing conditions
as the oil weathers.***

Buried oil during the Bouchard 155 (Tampa Bay) and Buffalo 292 (Galveston) spills

Buried oil is a site-specific problem that must be delineated by labor-intensive digging to determine the areal extent of the buried layers. The presence of buried oil is noted on the shoreline survey form and delineated on a sketch map. However, depending on the skill of the sketcher and the complexity of the segment, cleanup crews may not be able to locate the buried oil by reading the forms and maps. Another approach, used during both the *Buffalo 292* spill in Texas and the 1993 *Bouchard 155* spill in Tampa Bay, is to provide the survey team with surveyor's flags to mark the location of buried oil to be removed.

3 Responsibilities of the Shoreline Assessment Team

- Describe shoreline types, oiling conditions, and physical setting
- Identify sensitive resources (ecological, recreational, cultural)
- Determine the need for cleanup
- Recommend shoreline cleanup methods and endpoints:
 - specify generic and site-specific constraints for cleanup activities
 - determine the need for follow-up surveys if archaeological and cultural resources are present
 - establish cleanup priorities
 - identify safety concerns for cleanup operations
 - monitor cleanup effectiveness and effects, suggesting changes where needed
 - determine when cleanup operations are no longer effective
 - conduct post-cleanup inspections before sign-off

Teams must answer these questions

- Is cleanup necessary at this site?
- Which cleanup methods are appropriate or recommended?
- Which constraints are needed to protect sensitive resources?
- What is the priority for cleanup at this site?
- Are cleanup operations being conducted properly?
- Is the cleanup method no longer effective, or causing collateral damage? Do we need to try another method?
- Are the targeted endpoints realistic and obtainable for the current spill conditions?
- Should cleanup operations be terminated at this site?

4 Roles of the Shoreline Assessment Team

The Shoreline Assessment Team consists of a Coordinator (usually from NOAA's Scientific Support Team or the State counterpart), Team Leaders for each team, and team members. Roles and responsibilities of each member are outlined below.

Team Coordinator *sets schedules and priorities*

- Coordinates Shoreline Assessment Team response activities
- Conducts aerial reconnaissance survey to scope the shoreline oiling issues
- Ensures that all teams have the necessary representation and all members have the necessary training
- Develops daily assignments for each team, according to the needs of the Planning and Operations sections to meet the Unified Command response objectives
- Coordinates with natural resource damage assessment (NRDA) concerns on shoreline assessment to optimize data sharing
- Integrates cleanup concerns of the various resource agencies and managers into the decision-making process
- Arranges for equipment and transportation for the Shoreline Assessment Teams through the Logistics Section

leads development of cleanup guidelines

- Leads development of cleanup endpoints considering shoreline type, ecological sensitivity, recreational use, and aesthetic requirements, etc.
- Leads development of cleanup guidelines for implementing each cleanup method for the impacted shoreline types, based on agency concerns

leads reporting requirements

- Develops a survey and reporting schedule to produce survey results in time for incorporation into the Incident Action Plan (IAP)
- Ensures that teams use proper terminology and apply guidelines uniformly
- Receives reports from field teams and synthesizes them into a daily summary in IAP format and is accessible to the field teams if problems arise

**Team Coordinator
(cont.)**

- Helps team reach consensus and reports dissenting opinions when consensus is not reached
- Briefs Planning and Operations chiefs on issues raised by the Shoreline Assessment Teams, particularly where cleanup methods must be modified to increase effectiveness or decrease impacts
- Continues to lead evaluation of targeted cleanup endpoints and modifies them as necessary
- Officially recommends termination of cleanup actions to the Unified Command when:
 - 1) cleanup endpoints have been reached,
 - 2) actions are no longer effective, or
 - 3) further cleanup would cause more harm than good.

Field Team Leader

- Is the most experienced person on the Team
- Manages the Team while it conducts field surveys
- Completes forms and sketches in the field
- Guides the Team toward consensus on cleanup recommendations, priorities, special constraints, etc., and notes dissenting opinions
- Briefs Team Coordinator on field survey results
- Reports cleanup issues identified by the Team that need to be addressed
- Recommends modifications to cleanup methods and target cleanup endpoints

**Agency Reps.
(local, state, and
federal)**

- Help collect data on oiling conditions and special agency considerations
- Are experts in resource sensitivity and priorities for response considerations
- Recommend site-specific constraints or precautions to be followed during cleanup
- Determine need for cleanup, considering cleanup guidelines and endpoints
- Recommend cleanup methods, priorities, and endpoints
- Identify need for surveys by archaeological or cultural resource specialists.

**Operations
Representative**

- Is often the FOSC representative from the U.S. Coast Guard, either from the Marine Safety Office or one of the Strike Teams, or can also be provided by the RP representative or the State
- At times may include the Division Supervisor when the Team is in his/her area of responsibility (note dashed line in Figure 1 between the teams and the Division Supervisor)
- Helps collect data on oil conditions
- Evaluates appropriateness and operational feasibility of cleanup techniques
- Identifies logistical constraints and solutions, and estimates the level of effort needed



NOTE: Keeping the same individuals on a Team during the entire event ensures continuity in reporting and describing oil distribution and types of oiling.

5 Shoreline Assessment Activities

The following sections describe the full range of activities normally conducted as part of the shoreline assessment process.

- 5.1 *Reconnaissance survey*
- 5.2 *Segmenting the shoreline*
- 5.3 *Developing spill-specific cleanup guidelines and endpoints*
- 5.4 *Pre-survey planning and team assignments*
- 5.5 *Shoreline surveys*
- 5.6 *Submitting reports to the Planning Section*
- 5.7 *Cleanup evaluation/effectiveness monitoring*
- 5.8 *Post-cleanup inspections*
- 5.9 *Final sign-off of cleanup activities*

The degree to which each activity is implemented depends on the complexity of the spill. Flexibility is important; activities should be modified as appropriate to specific spill conditions.

NOAA and others have developed various resources and tools to assist Shoreline Assessment Teams in conducting each of these activities. Each section on an activity includes a list of the tools or resources that can be used. These tools and resource are briefly summarized below.

Shoreline Assessment Manual, 3rd edition: Describes the framework and process for developing shoreline cleanup strategies, including the formation of Shoreline Assessment Teams and the development of cleanup recommendations and target cleanup endpoints, standard methods for conducting field surveys and collecting data, reporting activities, and inspection and sign-off methods. The manual provides guidance, examples, and forms to assist decision-making and documentation for shoreline assessment and cleanup. The revised third edition was published by NOAA in August 2000.

Shoreline Assessment Job-Aid: A pocket-sized, laminated field guide used by members of Shoreline Assessment Teams to assist them in recording accurate field observations in a concise, systematic, and standard format. It consists of color photographic examples of all shoreline assessment terms, shoreline types, and cleanup methods. The Job-Aid was produced by NOAA in 1998.

Environmental Considerations for Oil Spill Response (“Marine Manual”):

Provides information for making trade-off decisions in the selection of appropriate cleanup methods for specific habitats and oil types. Includes matrices for shallow subtidal and shoreline intertidal habitats which classify cleanup methods for five different oil types, according to their potential for causing adverse habitat impacts. Developed jointly by NOAA, the American Petroleum Institute (API), the U.S. Coast Guard (USCG), and the U.S. Environmental Protection Agency. In press.

Options for Minimizing Environmental Impacts of Freshwater Spill Response

(“Freshwater Manual”): Similar to the Marine Manual, but addresses spill response in freshwater habitats. Prepared jointly by NOAA and API in 1995.

Environmental Sensitivity Index (ESI) Maps: Provide detailed data on shoreline habitats, sensitive biological and human-use resources, and life-history data on biological resources. Most ESI maps for the U.S. continue to be updated. Available in both hardcopy and digital formats.

Area Contingency Plan (ACP) Sensitive Areas Annex: Usually identifies sensitive resources and protection and cleanup priorities based on Area Committee input. Often a first responder’s tool that may also include other useful information such as access points, collection areas, boom requirements, and expert and resource trustee contacts.

Facility Response Plans: Information related to the facility’s response strategies for identifying and protecting sensitive resources.

Open-Water Oil Identification Job Aid for Aerial Observation: Field guide to assist in aerial observations of floating oil.

5.1 Reconnaissance survey

Objectives

- Obtain overall perspective on shoreline types and degree of contamination for a gross overview
- Determine areal extent of oiling on the shoreline
- Identify logistical constraints to shoreline access for both shoreline assessment and cleanup teams

Responsibility

- Usually conducted by the Shoreline Assessment Team Coordinator, although someone with local-area knowledge can also be a valuable participant

Methods

- Review Area Contingency Plan and ESI maps to become familiar with area and resource concerns
- Fly entire impact area (<400-500 feet at a max. 80-90 knots) in helicopter or high-wing aircraft
- Use GPS if available and topographic maps, nautical charts, and other maps identified in the Area Plan to record
 - flight path, including date and time,
 - objective descriptors of shoreline oiling conditions,*
 - location of floating oil, possibly affecting shoreline oiling conditions,
 - references to photographs/video taken,
 - access points for survey teams, especially in remote areas, and
 - visit representative ground sites to confirm and scale the degree of shoreline impacts and note special problems, such as potential for burial of oil, that could affect cleanup decision planning.

Tools

Overflight Job-Aid
Shoreline Assessment Job-Aid
ESI maps
Area Contingency Plan Sensitive Areas Annex
Facility Response Plans

* Objective oiling descriptors (Chap. 6, Fig. 5) must be modified according to observations made during aerial mapping.

5.2 Segmenting the shoreline

Objective

- Divide the shoreline into units, called segments, for recording and tracking survey data and making cleanup recommendations.

Responsibility

- Usually conducted by the Shoreline Assessment Team Coordinator, although someone with local-area knowledge can also be a valuable participant.

Methods

- When paper maps are used, 1:24,000-scale topographic maps provide consistent coverage and show access from land. When working from boats, nautical charts may be preferred.
- Base maps can be generated from digital databases, although they must have enough detail, such as street names and landmarks, so the teams can locate themselves in the field.
- Remember that the scale on nautical charts is in nautical miles, not statute miles as shown on vehicle odometers (1 nautical mile = 1.15 statute miles).
- Mark segments based on similarity of geomorphology (refer to ESI maps) and degree of oiling (ascertained from reconnaissance flight); local staff familiar with area should be involved.
- Segment boundaries should be readily recognizable in the field.
- Size segments appropriate to spill conditions and total area of impact (often 0.2 to 2.0 km long) using various lengths. Because separate forms are completed for each segment, interval should not be so small that the number of forms required becomes unmanageable for the size of the spill.
- Use divisions or names already in use by cleanup operations, when possible. Develop the segment-naming scheme with Operations so it is most useful.
- Pre-number segments with alphanumeric code (e.g., BI-9 for segment number 9 on Block Island; or 1-A for the first segment in cleanup zone 1). Remember that the spill responders may not be familiar with local geographic names.

Tools

ESI maps
Area Contingency Plan maps
Shoreline Assessment Manual

Figure 3 shows a map with segments delineated from the 1996 *Cape Mohican* spill, San Francisco, California. The scale of the maps should be a function of the complexity of the area and the length of the segments. Different scales can be used for different zones within the same spill-impact area. The final maps should be 8.5 x 11 inches to fit into field packs and be readily copied and faxed.

Figure 3. Example of a shoreline division and segment map.

CAPE MOHICAN Incident

Shoreline Division & Segment Map

Date/Time: 04 NOV 96, 1300

prepared by NOAA

USE ONLY AS A GENERAL REFERENCE

Graphics do not show precise amounts or locations of oil

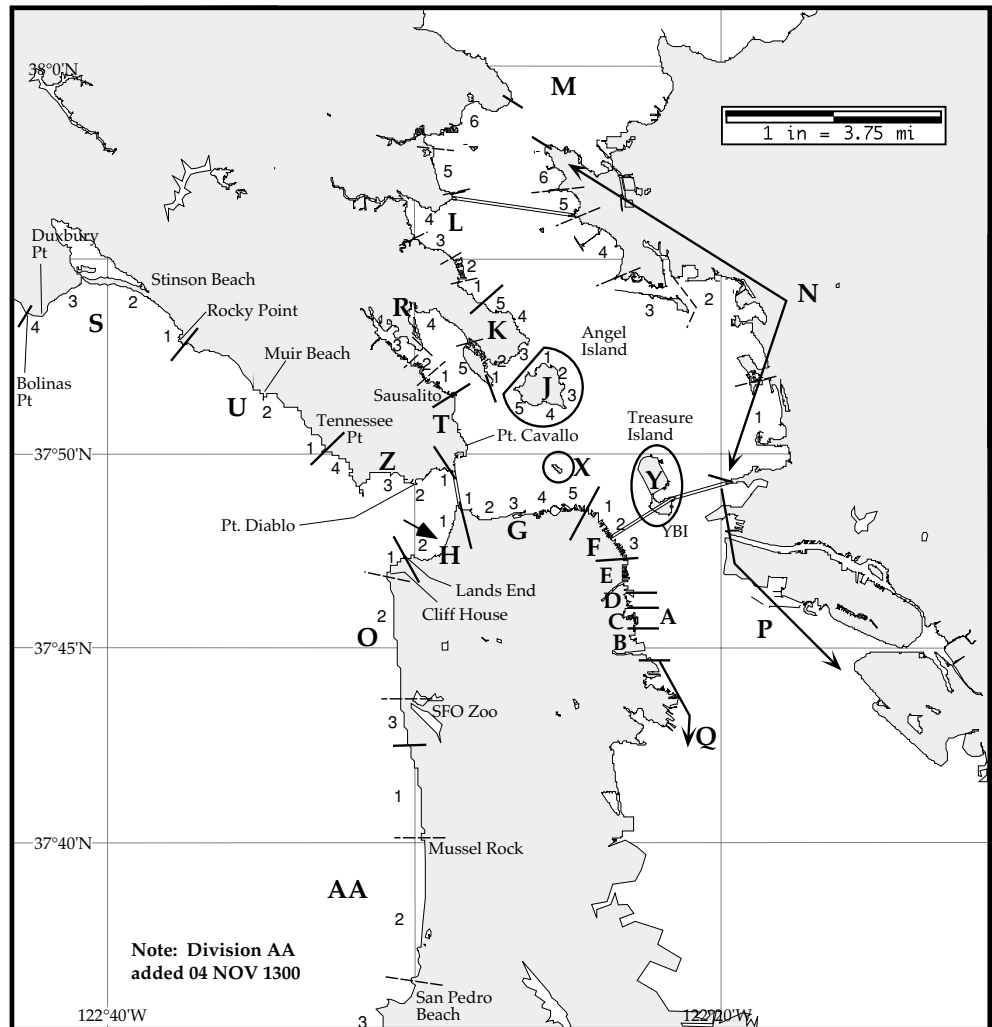

5.3 Developing spill-specific cleanup guidelines and endpoints

Objectives

- Guide Operations in conducting a specific *cleanup method* to minimize adverse environmental impact.
- Provide Operations with environmental and safety constraints on conducting cleanup activities in a *specific habitat*.
- Identify resource-specific constraints on cleanup activities.

Responsibility

- Shoreline Assessment Team Coordinator, Federal and state agency representatives, major landowners, and Team Leaders.

Methods

The NOAA/API response manuals for freshwater and marine spills are good sources of information on cleanup methods, applicable habitat types, guidelines on method selection, and probable biological constraints and environmental effects. Consult these manuals when evaluating cleanup methods.

- Develop spill-specific cleaning objectives, guidelines, and target endpoints (Appendix B briefly describes current cleanup techniques; Appendix C describes response considerations; examples of cleanup endpoints for different shoreline types are provided in Figure 4).
- Evaluate proposed cleanup methods for potential habitat or resource effects.
- Identify time-critical and degree-of-use issues to be combined with cleanup priorities and endpoints.
- Identify sensitive resources associated with the oiled shorelines that may be adversely affected by the proposed treatment methods (e.g., rich intertidal biota on rocky shores where low-pressure ambient-water flushing will be used).
- Note archaeological or cultural resources along the shoreline or in nearby upland areas that could be disturbed by cleanup activities. Notify the State Historical Preservation Office (SHPO), if necessary.
- Write operational guidelines to minimize adverse impacts (e.g., restrict flushing operations to times when the rich biota zones are underwater). Date the guidelines in order to track revisions.
- Develop detailed plans to monitor the effectiveness and/or biological effects of a method, if needed.
- Have the Shoreline Assessment Teams observe actual operations to confirm the method's use, i.e., that the cleanup method is necessary and is not more damaging than the oil alone.
- Modify cleanup guidelines as the oil changes from weathering, rendering the technique ineffective, or when unacceptable impacts occur under actual use.

Tools

Shoreline Assessment Manual
Marine and freshwater response manuals

Responders can produce spill-specific cleanup guidelines more easily if the issues were covered in the Area Contingency Plan and cleanup methods for these special concerns identified ahead of time. However, the Shoreline Assessment Team Coordinator should form a work group to evaluate cleanup options and make recommendations on other issues that arise during a spill. Besides reviewing published studies and case histories, they can also look at on-site testing for effectiveness and environmental effects of the proposed method(s) under the spill-specific conditions.

Selecting Cleanup Endpoints

Target cleanup endpoints are an integral part of spill-specific cleanup guidelines used for emergency oil-spill response. Endpoints are selected based on cleanup objectives to 1) minimize exposure hazards for human health; 2) speed recovery of impacted areas; and 3) reduce the threat of additional or prolonged natural resource impacts. These objectives lead to developing cleanup strategies that do not cause more harm to the environment than good.

Ideally, cleanup efforts will return the resource to its baseline condition without suffering further impact or affecting resources not initially impacted by the spill. Aggressive and inappropriate cleanup techniques can make matters worse. Less intrusive methods or natural recovery are often preferable. The best cleanup strategy is often not the one that removes *the most* oil. Rather, it is the strategy that removes oil that poses a greater risk of injury than would result from cleanup, and allows remaining oil to be removed by natural processes.

Figure 4 shows a hierarchy of cleanup endpoints that reflect this concept. Although the highest cleanup endpoint is removal of all visible oil, this is often impossible, particularly if there is a background rate of oil deposition (e.g., natural oil seeps or shipping traffic). In these cases, a more appropriate endpoint would be cleanup of visible oil, but not exceeding the background amount. When shoreline cleanup to achieve these endpoints is likely to cause added harm to the environment, three additional endpoints may be considered:

Figure 4.
Hierarchy of endpoints for shoreline cleanup.
Use these guidelines to develop spill-specific cleanup endpoints for terminating active cleanup.

<p>No visible oil: not detectable by sight, smell, feel</p>	<p>This endpoint is often used for sand beaches where oil removal can be effective without delaying resource recovery.</p> <p>Visual inspections are preferred over chemical analyses because it is difficult to sample areas with high variability; time and costs of analysis; and lack of guidelines on what levels are safe.</p> <p>It may be appropriate to conduct limited sampling and analysis to confirm the visual endpoint as safe for human use, such as on recreational beaches.</p>
<p>Visible oil, but no more than background</p>	<p>This endpoint is often applied where there is a significant background rate of tarball deposition on the shoreline.</p>
<p>No longer releases sheens that will affect sensitive areas, wildlife, or human health</p>	<p>This endpoint is used where sheening persists after cleanup efforts become ineffective, or on sensitive habitats where further cleanup efforts will cause more harm than natural removal. Residual sheening should persist over a relatively short time period.</p> <p>A sheen is an oil film ranging from barely visible to dull colors. Sorbents effectiveness is usually limited in recovery of sheens.</p> <p>Consider the amount and duration of sheening, and the distance to sensitive resources, to determine if sheening poses a significant threat.</p> <p>Consider the degree of exposure: high wave/tidal exposure speeds removal, breaks up sheens; sheltered areas will sheen longer and sheens will be more persistent.</p> <p>Consider the degree and timing of use: temporary sheening may be tolerated in areas or during periods of low use; even minor sheens may not be tolerated in areas of high use, such as swimming beaches.</p>
<p>No longer rubs off on contact</p>	<p>This endpoint is usually defined as oil removal to a stain or coat, or weathering to the point that it is no longer sticky. It is appropriate for hard substrates (rocky shores, seawalls, riprap, gravel) and vegetation (salt marsh, mangroves).</p> <p>The objective is to prevent oiling of fur, feathers, and feet of wildlife, people, and property during contact with oiled surfaces.</p> <p>Consider the degree and timing of use: high-use areas often require higher cleanliness, whereas natural removal is allowed in low-use areas where further cleanup efforts will be disruptive.</p>
<p>Oil removal to allow recovery/recolonization without causing more harm than natural removal of oil residues</p>	<p>This endpoint is used where further oil removal will result in excessive habitat disruption (e.g., trampling of soft sediments and plant roots, mixing oil deeper, extensive sediment removal, vegetation cutting) or high biota mortality (e.g., from high-pressure, hot-water washing of intertidal communities).</p> <p>It is also used for areas with difficult access which limits the type of cleanup which can be conducted along that shoreline segment.</p> <p>Consider the potential for erosion from excessive sediment removal, particularly where erosion/deposition patterns of the beach cycle will re-work and clean sediments within an acceptable time frame.</p>

Figure 4. Hierarchy of cleanup endpoints.

Examples of Cleanup Endpoints

1. Oil removal to the point where the shoreline no longer generates sheens that affect sensitive areas, wildlife, or human health;
2. Oil removal to the point where it no longer rubs off (e.g., becomes like a coat of black paint); and
3. Oil removal to the point that allows recovery/recolonization without causing more harm than leaving the oil in place.

Note that “visible” oil applies not only to oil on the surface, but also to buried oil that must be exposed by digging trenches into the sediments.

Examples of cleanup endpoints used at previous oil spills for different shoreline types are included below, to help you develop spill- and site-specific endpoints. Each spill will have a unique combination of oil type, rate of natural removal, biological sensitivity, and human-use issues that may lead to different endpoints.

Exposed Rocky Shores and Wave-Cut Platforms (ESI = 1A and 2)

Cleanup Trade-off Issues

Shoreline access is often difficult, dangerous, and limited to low tide and wave conditions.

Rapid natural removal rates are expected, so these shorelines usually have lower priority for cleanup. Thus, cleanup endpoints are seldom an issue because onshore cleanup activities are not initiated.

High wave energy at these sites usually breaks up sheens, limiting the distance sheens can spread and thus the areal extent of threat to sensitive resources.

Timing is often a critical component in allowing natural removal to proceed, particularly relative to the presence of migratory waterfowl, seabird nesting activity, and breeding activities of marine mammals.

Limited removal of persistent residues that are affecting sensitive resources (e.g., sources of sheens very near active bird nesting colonies) may be considered.

Examples of Cleanup Endpoints

Cleanup can be terminated when the shoreline no longer releases sheens that affect sensitive wildlife.

On exposed rocky shores used as marine mammal haulouts, persistent oil should be removed until the oil is no longer sticky, unless cleanup is too disruptive to animals at the site.

Solid Man-Made Structures (ESI = 1B and 8B)

Cleanup Trade-off Issues

Because these shoreline types often occur in developed areas with chronic sources of pollutants or habitat degradation nearby, they usually have low biological sensitivity.

More intrusive techniques are considered because of their lower biological use and the need to minimize human exposure in areas of high public use.

The lower part of the structure may have rich attached biota that should be protected during use of intrusive techniques.

Examples of Cleanup Endpoints

In industrial areas, cleanup can be terminated when the shoreline no longer releases liquid oil and heavy rainbow sheens when in contact with water. Sorbents are deployed until sheening ceases.

In areas of high public use, more intensive cleanup should be conducted to remove the oil until it no longer rubs off on contact (to no more than a stain) to minimize human contact or oiling of boats. In areas of low public use, visible oil can remain as stain and patches of coat.

Sand Beaches (ESI = 3 and 4)

Cleanup Trade-off Issues

High public use on beaches usually requires a quick cleanup and high degree of cleanliness.

The sand beach cycle is short, so reworked and relocated sediments often can be rapidly returned to their normal distribution on exposed beaches. Wave action can be an effective final “polishing” process, removing stain from sediments.

Oil on the surface of sand beaches is relatively easy to clean; however, difficulties arise when the oil is buried because of the amount of sediment that must be removed.

If sand can be replaced by existing nourishment projects, more sediment removal is generally allowed where oil must be quickly removed from public beaches.

Examples of Cleanup Endpoints

Cleanup can be terminated when no visible oil remains on the surface, except for scattered tarballs or swash lines of minute tarballs which may occur as the sand is reworked by the waves. All tarballs or tar patties that can be removed by reasonable cleanup techniques, or that can be remobilized, should be removed. Remaining tarballs and tar patties should be at or below normal background frequency. Increases in tarball frequency above background will require further cleanup.

Cleanup can be terminated when no oil layers are found in trenches dug into the beach. Buried tarballs should be at or below background frequency.

Mixed Sand and Gravel Beaches (ESI = 5) and Gravel Beaches (ESI = 6A) *Cleanup Trade-off Issues*

Beaches with a significant amount of gravel are relatively difficult to clean because they have high potential for deep penetration and burial. Deeply penetrated oil can be a chronic source of sheens for months or longer.

Because natural replenishment rates of gravel are slow, sediment removal is usually minimal and natural removal is considered following gross oil removal.

The most difficult issue is removal of persistent, deeply penetrated oil because of the degree of physical disruption to both the beach profile and sediment distribution patterns. It is difficult to predict how long natural removal will take at a specific site.

Because gravel is mobilized mostly during storms, it could take months to years for a beach to return to normal after extensive physical disruption.

Examples of Cleanup Endpoints

Cleanup can be terminated when all liquid oil in the sediments has been removed. No more than a stain may remain on the gravel-sized sediments.

There should be no oil layers in pits dug by the inspection team. Occurrences of buried tarballs should be at or below background frequency.

Riprap Structures (ESI = 6B)

Cleanup Trade-off Issues

Riprap often occurs in developed areas with chronic sources of pollutants or habitat degradation nearby.

More intrusive techniques are considered because of their lower biological use and need to minimize human exposure in populated areas.

It is extremely difficult to completely remove oil from crevices and undersides of the riprap because of their inaccessibility. Sometimes the structure must be replaced, which can be highly intrusive.

With higher residues remaining, they can release sheens for weeks or longer.

Examples of Cleanup Endpoints

In industrial areas, cleanup can be terminated when the shoreline no longer releases liquid oil or heavy rainbow sheens when in contact with water.

Visible oil can remain as stain and patches of coat on the outer surface of the structure. All flushable oil in the crevices and on the sides and bottom of individual pieces of the riprap should be removed. It is not necessary to remove oil coat from these surfaces.

Sorbents can be deployed to recover sheens where needed to reduce impacts to sensitive resources.

In areas of high public use, more intensive cleanup is needed to remove the oil until it no longer rubs off on contact (to no more than a stain) to minimize human contact with the oil.

Exposed and Sheltered Tidal Flats (ESI = 7 and 9)

Cleanup Trade-off Issues

The risks of physical disruption and mixing of the oil are very high, thus passive cleanup (e.g., deploying sorbents) is often the only activity considered. Even then, extreme care is needed. Since there is usually another shoreline type at the upper intertidal zone, care is needed to prevent impacts to the lower tidal flat during cleanup activities along the higher shoreline.

Examples of Cleanup Endpoints

Use of sorbents can be terminated when the shoreline no longer releases sheens that will affect sensitive areas, wildlife, or human health.

Gross oil removal can be terminated when further cleanup efforts would result in excessive habitat disruption, causing more harm than natural removal of oil residues.

Marshes (ESI = 10A and 10 B)

Cleanup Trade-off Issues

Natural removal rates are very slow. Heavy oil on vegetation is usually removed only when the vegetation dies back and sloughs off.

Efforts generally focus on recovery of free oil trapped in the marsh and deployment of sorbents to pick up sheens. Most types of active cleanup in the marsh can cause significant habitat impact and slow recovery.

Heavy oil on marsh vegetation generally weathers to a dry coat within weeks, after which it poses a lower threat of oiling wildlife using the marsh.

Examples of Cleanup Endpoints

Cleanup can be terminated when there is no more free-floating oil in the marsh.

Use of sorbents can be terminated when the shoreline no longer releases sheens that will affect sensitive areas, wildlife, or human health.

5.4 Pre-survey planning and team assignments

Objective

- Determine areas to be surveyed and logistical and team assignments.

Responsibility

- Shoreline Assessment Team Coordinator.

Methods

- Revise the standard shoreline oiling codes and forms, if needed, to fit spill conditions.
- Select base maps showing the segment boundaries and names.
- Form teams with appropriate membership.
- Ensure that all team members have the required safety training. Each team member must review and sign the site safety plan, and discuss specific safety concerns related to shoreline assessment activities.
- Determine logistical requirements for the teams and coordinate requests through the Logistics Section.
- Assign team leaders.
- Assign survey areas (primary and backup) for each team, based on priorities, logistics, local expertise, and ownership.
- Distribute segment maps for primary and backup areas; distribute blank forms, codes, sketch maps (see Chapter 7 for forms and codes).
- Distribute field equipment (see checklist in Appendix A).
- Brief team on survey objectives, logistics, and safety issues.
- Discuss cleanup options guidelines and criteria for priorities.
- Discuss reporting requirements and schedules.
- “Calibrate” on the first day by having all team members visit a segment together and agree on how the oiling descriptions will be applied.

Tools

Shoreline Assessment Manual
Area Contingency Plan maps
Facility Response Plan maps

5.5 Shoreline surveys

Objectives

- Collect data on shoreline types, oiling conditions, and ecological and human-use resources for specific segments.
- Reach agreement on cleanup recommendations for specific segments.
- Confirm that recommendations are effective and beneficial to the environment (refer to list of questions in Chapter 3).

Responsibility

- Shoreline Assessment Team.

Methods

- Confirm segment boundaries.
- Conduct survey to identify shoreline types and extent of oiling.
- Describe the shoreline characteristics, surface oil conditions, buried oil conditions, and special considerations (ecological, recreational, cultural) using standard terms and codes.
- Sketch the segment, if appropriate, focusing on the oil distribution and special considerations.
- Note presence of submerged oil in nearshore zone for spills of heavy oil.
- Log and locate all photographs taken, and note the objective of each photograph.
- Collect oil and/or sediment samples based on identified needs.
- Discuss and agree on cleanup recommendations and priorities.
- Complete the surveys each day in time to meet reporting deadlines.

Tools

Shoreline Assessment Job-aid
Shoreline Assessment Manual

5.6 Submitting reports to the Planning Section

Objective	<ul style="list-style-type: none">■ Provide data needed to support shoreline cleanup decisions and operations.
Responsibility	<ul style="list-style-type: none">■ Shoreline Assessment Team Leader.
Methods	<ul style="list-style-type: none">■ Check all data for accuracy, completeness, and legibility.■ Copy all forms, sketches, and field notes for the field team as needed; keep originals on file.■ Summarize cleanup recommendations by segment.■ Debrief Shoreline Assessment Coordinator on special issues, problems, and recommendations.■ Create summary maps identifying segments to be cleaned, degree-of-oiling categories, or other products as needed (see Chapter 6 for sample formats for reporting results to Planning).
Tools	Shoreline Assessment Manual

NOTE: Shoreline Assessment Teams cannot direct cleanup contractors in the field, although the teams can document unapproved cleanup methods or improper techniques. The Coordinator will contact Operations staff, including division or group supervisors in the area, if possible, to rectify the problem.

5.7 Cleanup evaluation/effectiveness monitoring

Objective	<ul style="list-style-type: none">■ Evaluate field data routinely to monitor progress of cleanup activities and assess the need for modifying cleanup methods or endpoints.
Responsibility	<ul style="list-style-type: none">■ Shoreline Assessment Team Coordinator, Federal and State agency representatives, major landowners, and Team Leaders.
Methods	<ul style="list-style-type: none">■ Visit segments where cleanup activities are being conducted to ensure that approved methods are being properly implemented.■ Respond to requests from Operations for changes in approved cleanup methods to address specific problems or changes in oiling conditions that render the approved methods ineffective.■ Organize and conduct field testing and monitoring programs, if needed, during evaluation or use of innovative cleanup methods.■ Modify cleanup endpoints, as needed, with changes in oiling conditions or timing.■ Produce summary reports and documentation on special issues, problems, and changes in recommendations related to shoreline cleanup methods and endpoints.
Tools	Shoreline Assessment Manual Marine and Freshwater Manuals Area Contingency Plan

5.8 Post-cleanup inspections

Objective	<ul style="list-style-type: none">■ Inspect segments that Operations declares ready for sign-off before final approval.
Responsibility	<ul style="list-style-type: none">■ Each Shoreline Assessment Team.
Methods	<ul style="list-style-type: none">■ Operations notifies the Shoreline Assessment Team Coordinator that a segment is ready for inspection.■ Inspect the segment against agreed-upon cleanup endpoints (preferably using the same team that did the original survey). The original field sketch can be very helpful for evaluating effectiveness of the cleanup.■ Identify additional cleanup needed using standard shoreline assessment terminology forms and sketches, or develop special forms for this purpose (see Appendix D for sample forms).■ Recommend segment for final inspection.■ Recommend any longer-term monitoring or iterative procedures needed.
Tools	Shoreline Assessment Manual Shoreline Assessment Job-Aid

5.9 Final sign-off of cleanup activities

Objective	<ul style="list-style-type: none">■ Approve the termination of cleanup activities at each segment.
Responsibility	<ul style="list-style-type: none">■ Sign-off Team (SOFT). Agencies must delegate sign-off authority to their representatives on the team. We recommend that, if possible, the same staff doing the shoreline assessments of an area be assigned to the SOFT.
Methods	<ul style="list-style-type: none">■ A SOFT is designated, usually with one member each from the FOSC, the SOSOC, and the RP. Representatives from local agencies or land managers may be added for specific properties or resource concerns.■ The Team reviews cleanup endpoint guidelines and develops procedures for interpreting them. These guidelines are revised, as needed, relative to the oiling and resource conditions at the time of final inspection.■ Operations notifies Planning that the segment has passed inspection by the shoreline Assessment Team and is ready for final sign-off.■ The SOFT inspects the segment against the cleanup endpoint guidelines, approving those segments that meet the guidelines and recommending further cleanup for those segments which do not.■ A formal sign-off sheet for each segment is signed by each member.■ The sign-off approval can specify maintenance activities (e.g., deploying sorbent booms to recover oil sheens as long as sheens are being released, or maintaining an area to remove tarballs as they wash ashore after storms), but it is important that criteria for ending the maintenance activity be clearly specified.
Tools	Shoreline Assessment Manual

6 Shoreline Survey Terminology, Codes, and Forms

Field survey terms, codes, and forms

Using standard terminology to describe and report shoreline oiling conditions is the basic foundation of shoreline assessment. Ambiguous words, such as “heavy” oiling, do not provide the necessary detail to document the oiling condition or the need for and type of cleanup to be conducted. **Figure 5** lists the terminology and codes to be used by Shoreline Assessment Teams and demonstrates the need for trained teams who can consistently apply these terms to spill-specific conditions. Appendix D includes field estimator charts for uniformly applying percent cover estimates. The *Shoreline Assessment Job-Aid* is a valuable field tool to help teams use proper terminology. All team members must agree on how they will use these terms and codes for a specific spill. Thus, a calibration field exercise, conducted jointly by all team members, is always necessary.

You will need to modify these terms as appropriate for the spill. For example, most oiling descriptors have been developed for black oils. The Shoreline Assessment Team at the 1996 *North Cape* spill had to modify the descriptors for that spill of home heating oil (a light, refined oil that is essentially No. 2 fuel oil; **Figure 6**). Appendix D contains copies of all forms and terms.

We have used a range of forms to record the observations of shoreline assessment teams. All of the forms use the standard codes and terminology in **Figure 7**. Figure 7 shows the Shoreline Oiling Summary Form, as modified from the *Exxon Valdez* SCAT surveys and Environment Canada (1992). This form is the most complex and usually requires a high level of training to complete it properly. Operations staff also need specialized training to interpret the data, although they usually see summary reports.

Figure 5.
Shoreline oil
terminology/codes for
spills of black oil.

<u>Oil Distribution</u>			<u>Surface Oiling Descriptors - Width</u>	
C	Continuous	91 - 100%	Very Narrow	< ____ m
B	Broken	51 - 90%	Narrow	> ____ - < ____ m
P	Patchy	11 - 50%	Medium	> ____ - < ____ m
S	Sporadic	1 - 10%	Wide	< ____ m
T	Trace	<1%		
<u>Surface Oiling Descriptors - Thickness</u>				
PO	Pooled Oil (fresh oil or mousse > 1 cm thick)			
CV	Cover (oil or mousse from >0.1 cm to <1 cm on any surface)			
CT	Coat (visible oil <0.1 cm, which can be scraped off with fingernail)			
ST	Stain (visible oil, which cannot be scraped off with fingernail)			
FL	Film (transparent or iridescent sheen, or oily film)			
<u>Surface Oiling Descriptors - Type</u>				
FR	Fresh Oil (unweathered, liquid oil)			
MS	Mousse (emulsified oil occurring over broad areas)			
TB	Tarballs (discrete accumulations of oil <10 cm in diameter)			
PT	Patties (discrete accumulations of oil >10 cm in diameter)			
TC	Tar (highly weathered oil, of tarry, nearly solid consistency)			
SR	Surface Oil Residue (non-cohesive, heavily oiled surface sediments, characterized as soft, incipient asphalt pavements)			
AP	Asphalt Pavement (cohesive, heavily oiled surface sediments)			
NO	No Oil			
DB	Debris: logs, vegetation, rubbish, garbage, and response items such as booms			
<u>Subsurface Oiling Descriptors</u>				
SAP	Subsurface asphalt pavement (cohesive)			
OP	Oil-Filled Pores (pore spaces are completely filled with oil to the extent that the oil flows out of the sediments when disturbed). May also consist of weathered oil, such as a buried lens of asphalt pavement.			
PP	Partially Filled Pores (pore spaces partially filled with oil, but the oil does not flow out of the sediments when disturbed)			
OR	Oil Residue (sediments are visibly oiled with black/brown coat or cover on the clasts, but little or no accumulation of oil within the pore spaces).			
OF	Oil Film (sediments are lightly oiled with an oil film, or stain, on the clasts)			
TR	Trace (discontinuous film or spots of oil, an odor, or tackiness)			
NO	No Oil (no evidence of any type of oil)			
<u>Sediment Types</u>				
R	Bedrock outcrops		S	Sand (0.06-2 mm)
B	Boulder (>256 mm in diameter)		M	Mud (silt and clay, <0.06 mm)
C	Cobble (64-256 mm)		RR	Riprap (man-made permeable rubble)
P	Pebble (4-64 mm)		SW	Seawalls (impermeable)
G	Granule (2- mm)			

Figure 6.
Shoreline oil
terminology/codes for
spills of light, refined
oil.

Surface Oil Distribution (on sediments and nearshore water)

C	Continuous	91 - 100% cover
B	Broken	51 - 90%
P	Patchy	11 - 50%
S	Sporadic	1 - 10%
T	Trace	<1%

Surface and subsurface Oiling Descriptors - Thickness

SM	Smell	No visible oil; detectable only by smell
FL	Film	Feels greasy when sediments are rubbed
SH	Sheen	Visible sheen on water surfaces
CT	Coat	Visible coating of oil
PO	Pooled	Liquid oil accumulated on surface

Surface Oiling Descriptors - Color

None	Brown
Shiny	Yellow
Rainbow	Red

Surface Oiling Descriptors - Width

N	Narrow	< 1 m
M	Medium	> 1 to <3 m
W	Wide	> 3 m; estimate width if possible

Sediment Types

R	Bedrock outcrops	S	Sand (0.06-2 mm)
B	Boulder (>256 mm in diameter)	M	Mud (silt and clay, <0.06 mm)
C	Cobble (64-256 mm)	RR	Riprap (man-made permeable rubble)
P	Pebble (4-64 mm)	SW	Seawalls (impermeable)
G	Granule (2-4 mm)		

Sheen on Water Descriptors

	Approx. Layer-Thickness		Approx. Volume per Area	
	mm	inches	liters/km ²	gallons/nm ²
barely visible	0.00004	0.000002	50	40
silver sheen	0.00007	0.000003	100	75
first color trace	0.0001	0.000004	200	150
bright colors	0.0003	0.00001	400	300
dull colors	0.001	0.00004	1200	1000
dark colors	0.003	0.0001	3600	3000

Surface Oiling Descriptors - Width (modify for spill-specific conditions)

Very Narrow	< ____m
Narrow	> ____-<____m
Medium	> ____-<____m
Wide	< ____m

Figure 7. Example of a completed Shoreline Assessment Form, updated from a form developed by Owens and Teal (1990) and used by Environment Canada (1992). Forms in Figures 7 and 8 are completed for the same hypothetical survey conditions.

SHORELINE ASSESSMENT FORM for EXAMPLE Spill Page 1 of 1

1. GENERAL INFORMATION		Date (dd/mm/yy)	Time (24h standard/daylight)	Tide Height															
Segment ID: <u>SP-02</u>		<u>28/08/00</u>	<u>1400</u> hrs to <u>1600</u> hrs	L/M/H <u>H/M/L</u>															
Segment Name: <u>STATE PARK BCH</u>																			
Survey By: <u>Foot</u> / Boat / Helicopter / Overlook / _____		<u>Sun</u> / Clouds / Fog / Rain / Snow / Windy																	
2. SURVEY TEAM No. <u>1</u> Name _____ Organization _____ Phone Number _____																			
<u>A. SMITH</u>		<u>STATE DNR</u>																	
<u>B. JONES</u>		<u>STATE PARKS</u>																	
<u>C. HILL</u>		<u>NOAA</u>																	
<u>D. ADAMS</u>		<u>USCG</u>																	
3. SEGMENT Total Length <u>750</u> (m)/yd Length Surveyed <u>750</u> (m)/yd Differential GPS Yes/ <u>No</u>																			
Start GPS: LAT _____ deg. _____ min LONG _____ deg. _____ min																			
End GPS: LAT _____ deg. _____ min LONG _____ deg. _____ min																			
4. SHORELINE TYPE Select only ONE Primary (P) and ANY Secondary (S) types present																			
		Rocky Cliffs		Riprap															
		Exposed Man-made Structures		Exposed Tidal Flats															
		Wave-cut Platforms		Sheltered Rocky Shores															
<u>P</u>		Fine-Medium grained Sand Beaches		Sheltered Man-made Structures															
		Coarse-grained Sand Beaches		Sheltered Tidal Flats															
		Mixed Sand and Gravel Beaches		Wetlands															
		Gravel Beaches		Other _____															
5. OPERATIONAL FEATURES Oiled Debris? <u>Yes</u> No Type <u>WRACK</u> Amount <u>10</u> bags																			
Direct backshore access? <u>Yes</u> No Access restrictions <u>NONE. PARKING LOT NEARBY</u>																			
Alongshore access from next segment? <u>Yes</u> No Suitable backshore staging? <u>Yes</u> No																			
6. SURFACE OILING CONDITIONS Begin with "A" in the lowest tidal zone																			
Zone ID	Tidal Zone				Oil Cover			Oil Thickness					Oil Character						
	LI	MI	UI	SU	Length (m)/ft	Width (m)/ft	Distr. %	PO	CV	CT	ST	FL	FR	MS	TB	TC	SR	AP	No
<u>A</u>		<u>✓</u>			<u>250</u>	<u>2</u>	<u>20</u>	<u>✓</u>						<u>✓</u>					
<u>B</u>			<u>✓</u>		<u>750</u>	<u>1</u>	<u>50</u>	<u>✓</u>						<u>✓</u>					
7. SUBSURFACE OILING CONDITIONS Use letter of Zone location plus Number of trench, e.g., "A1"																			
Trench No.	Tidal Zone				Trench Depth (cm) in	Oiled Interval (cm-cm/in-in)	Subsurface Oil Character					Water Table (cm) in	Sheen Color B,R,S,N	Clean Below? Yes/No					
	LI	MI	UI	SU			OP	PP	OR	OF	TR				No				
<u>A1</u>		<u>✓</u>			<u>20</u>	<u>0-7</u>			<u>✓</u>			<u>20</u>	<u>S</u>	<u>Y</u>					
<u>B1</u>			<u>✓</u>		<u>30</u>	<u>0-10</u>			<u>✓</u>			<u>30</u>	<u>S</u>	<u>Y</u>					
<u>B2</u>			<u>✓</u>		<u>30</u>	<u>5-10</u>			<u>✓</u>			<u>30</u>	<u>R</u>	<u>Y</u>					
8. COMMENTS Cleanup Recommendations; Ecological/Recreational/Cultural Issues/Wildlife Obs.																			
<u>MANUAL REMOVAL ONLY - TO MINIMIZE SEDIMENT REMOVAL.</u>																			
<u>V. HIGH PRIORITY - STATE PARK AND HIGH RECREATIONAL USE.</u>																			
<u>SAW TWO PLOVERS WITH OIL SPOTS ON BREAST, NEAR PIER.</u>																			
Sketch: Yes <u>No</u> Photos: <u>Yes</u> / No (Roll# 1-1 Frames 7-9) Video Tape: Yes / <u>No</u> (Tape# _____)																			

Figure 8 is a shorter form that allows field teams to circle the appropriate descriptors, minimizing the need to fill-in information and encouraging the use of standard terms. This form is most useful when the oiling is very uniform or simple.

Figure 8.
Example of a completed Shoreline Assessment Form for a hypothetical survey.

SHORT SHORELINE ASSESSMENT FORM for EXAMPLE Spill Page 1 of 1

1. GENERAL INFORMATION		Date (dd/mm/yy)	Time (24h standard/daylight)	Tide Height
Segment ID: <u>SP-02</u>		<u>28/08/00</u>	<u>1400</u> hrs to <u>1600</u> hrs	L/M/H H/M/L
Segment Name: <u>STATE PARK BCH</u>				
Survey By: <u>Foot</u> / Boat / Helicopter / Overlook / _____			<u>Sun</u> / Clouds / Fog / Rain / Snow / Windy	
2. SURVEY TEAM No. <u>1</u>		Name	Organization	Phone Number
A. <u>SMITH</u>			<u>STATE DNR</u>	
B. <u>JONES</u>			<u>STATE PARKS</u>	
C. <u>HILL</u>			<u>NOAA</u>	
D. <u>ADAMS</u>			<u>USCG</u>	
3. SEGMENT		Total Length <u>250</u> (m)/yd	Length Surveyed <u>250</u> (m)/yd	Differential GPS Yes/No
Start GPS: LAT _____ deg. _____ min		LONG _____ deg. _____ min		
End GPS: LAT _____ deg. _____ min		LONG _____ deg. _____ min		
4. SHORELINE TYPE		Select only ONE Primary (P) and ANY Secondary (S) types present		
	Rocky Cliffs		Riprap	
	Exposed Man-made Structures		Exposed Tidal Flats	
	Wave-cut Platforms		Sheltered Rocky Shores	
<u>P</u>	Fine-Medium grained Sand Beaches		Sheltered Man-made Structures	
	Coarse-grained Sand Beaches		Sheltered Tidal Flats	
	Mixed Sand and Gravel Beaches		Wetlands	
	Gravel Beaches		Other _____	
5. OPERATIONAL FEATURES		Oiled Debris? <u>Yes</u> / No	Type <u>WRACK</u>	Amount <u>10</u> bags
Direct backshore access? <u>Yes</u> / No		Access restrictions <u>NONE. PARKING LOT NEARBY</u>		
Alongshore access from next segment? <u>Yes</u> / No		Suitable backshore staging? <u>Yes</u> / No		
Zone ID <u>A</u>		Description of oil in: Supra / Upper / <u>Mid</u> / Lower Tidal Zone (circle oil location)		
Oil Band Dimensions	Surface Oil Distribution	Surface Oil Thickness	Surface Oil Type	Subsurface Oil Penetration
Width: <u>2</u> (m)/ft Length: <u>250</u> (m)/ft	<1%	Film	Fresh Oil	<1 cm / in
	1-10%	Stain	<u>Mousse/Tar</u>	1-5 cm / in
	11-50%	Coat	Tarballs/Patties	<u>5-10</u> (cm) / in
	51-90%	<u>Cover</u>	Surface Oil Residue	>10 cm / in
	91-100%	Pooled	Asphalt Pavement	_____ cm / in
	<u>20</u> %	_____ cm / in	Other _____	_____ cm / in
				Clean Layer _____ cm / in
				<u>NONE</u>
				Oiled Layer _____ cm / in
				_____ cm / in
Zone ID <u>B</u>		Description of oil in: Supra / <u>Upper</u> / Mid / Lower Tidal Zone (circle oil location)		
Oil Band Dimensions	Surface Oil Distribution	Surface Oil Thickness	Surface Oil Type	Subsurface Oil Penetration
Width: <u>1</u> (m)/ft Length: <u>750</u> (m)/ft	<1%	Film	Fresh Oil	<1 cm / in
	1-10%	Stain	<u>Mousse/Tar</u>	1-5 cm / in
	11-50%	Coat	Tarballs/Patties	<u>5-10</u> (cm) / in
	51-90%	<u>Cover</u>	Surface Oil Residue	>10 cm / in
	91-100%	Pooled	Asphalt Pavement	_____ cm / in
	<u>50</u> %	_____ cm / in	Other _____	_____ cm / in
				Clean Layer _____ cm / in
				<u>5</u> (cm) / in
				Oiled Layer _____ cm / in
				<u>5-10</u> (cm) / in
8. COMMENTS		Cleanup Recommendations; Ecological/Recreational/Cultural Issues; Wildlife Obs.		
MANUAL REMOVAL ONLY - TO MINIMIZE SEDIMENT REMOVAL. V. HIGH PRIORITY - STATE PARK AND HIGH RECREATIONAL USE. SAW TWO PLOVERS WITH OIL SPOTS ON BREAST, NEAR PIETR.				
Sketch: Yes / <u>No</u> Photos: <u>Yes</u> / No (Roll# <u>1-1</u> Frames <u>7-9</u>) Video Tape: Yes / <u>No</u> (Tape# _____)				

Figure 9a.
 Example of a completed Tarball Shoreline Assessment form for a hypothetical survey. This form is appropriate for spills where shoreline oiling is primarily in the form of tarballs.

TARBALL SHORELINE ASSESSMENT FORM for EXAMPLE Spill Page 1 of 1

1. GENERAL INFORMATION		Date (dd/mm/yy)	Time (24h standard/daylight)	Tide Height
Segment ID: <u>SP-02</u>		<u>28/08/00</u>	<u>1400</u> hrs to <u>1600</u> hrs	L/M/H
Segment Name: <u>STATE PARK BCH</u>				H/M/L <input checked="" type="checkbox"/>
Survey By: <input checked="" type="checkbox"/> Foot / <input type="checkbox"/> Boat / <input type="checkbox"/> Helicopter / <input type="checkbox"/> Overlook / _____		<input checked="" type="checkbox"/> Sun / <input type="checkbox"/> Clouds / <input type="checkbox"/> Fog / <input type="checkbox"/> Rain / <input type="checkbox"/> Snow / <input type="checkbox"/> Windy		
2. SURVEY TEAM No. <u>1</u>		Name	Organization	Phone Number
A. <u>SMITH</u>		<u>STATE DNIR</u>		
B. <u>JONES</u>		<u>STATE PARKS</u>		
C. <u>HILL</u>		<u>NOAA</u>		
D. <u>ADAMS</u>		<u>USCG</u>		
3. SEGMENT		Description of Shoreline Surveyed: <u>FROM PARKING LOT ACCESS, SOUTH TO THE NORTH SIDE OF THE PIER</u>		
Total Length: <u>750</u> <input checked="" type="checkbox"/> m/yd		Length Surveyed: <u>750</u> <input checked="" type="checkbox"/> m/yd		Differential GPS? Yes / <input checked="" type="checkbox"/> No
Start GPS: LAT _____ deg. _____ min		LONG _____ deg. _____ min		
End GPS: LAT _____ deg. _____ min		LONG _____ deg. _____ min		
4. SHORELINE TYPE		Select only ONE Primary (P) and ANY Secondary (S) types present		
<input type="checkbox"/>	Rocky Cliffs	<input type="checkbox"/>	Riprap	
<input type="checkbox"/>	Exposed Man-made Structures	<input type="checkbox"/>	Exposed Tidal Flats	
<input type="checkbox"/>	Wave-cut Platforms	<input type="checkbox"/>	Sheltered Rocky Shores	
<input checked="" type="checkbox"/>	Fine-Medium grained Sand Beaches	<input type="checkbox"/>	Sheltered Man-made Structures	
<input type="checkbox"/>	Coarse-grained Sand Beaches	<input type="checkbox"/>	Sheltered Tidal Flats	
<input type="checkbox"/>	Mixed Sand and Gravel Beaches	<input type="checkbox"/>	Wetlands	
<input type="checkbox"/>	Gravel Beaches	<input type="checkbox"/>	Other _____	
5. TAR BALL DESCRIPTION		AREA 1	AREA 2	AREA 3
Tar Balls Observed?		<input checked="" type="checkbox"/> Yes / No	<input checked="" type="checkbox"/> Yes / No	Yes/No
Oiled Debris Observed? (Describe below)		<input checked="" type="checkbox"/> Yes / No	<input checked="" type="checkbox"/> Yes / No	Yes/No
Tidal Zone		LI / MI / <input checked="" type="checkbox"/> UI / SU	LI / MI / <input checked="" type="checkbox"/> UI / SU	LI / MI / UI / SU
Where the area of tarballs is located				
Length		Approximate alongshore length of shore in which tarballs/oiled debris are observed	<u>250</u> <input checked="" type="checkbox"/> m/yd	<u>500</u> m/yd
Width		Across-shore width of the band on the shore in which tarballs/oiled debris are observed	<u>2</u> <input checked="" type="checkbox"/> m/yd	<u>1</u> <input checked="" type="checkbox"/> m/yd
Average Number of Tar Balls within Area (e.g., 2/yd ² within band; 3 per 100 yds along-shore; 6 total within area, etc.) Be specific.		<u>1-15/m²</u> <u>X = 10/m²</u>	<u>20 per 100m</u>	
Average Size of Tar Balls		<u>5</u> <input checked="" type="checkbox"/> cm/in	<u>2</u> <input checked="" type="checkbox"/> cm/in	cm/in
Size of Largest Tar Ball		<u>10</u> <input checked="" type="checkbox"/> cm/in	<u>5</u> <input checked="" type="checkbox"/> cm/in	cm/in
Type of Tar Balls		Weathered/ <input checked="" type="checkbox"/> Fresh	Weathered/ <input checked="" type="checkbox"/> Fresh	Weathered/Fresh
		Sticky? <input checked="" type="checkbox"/> Yes / No	Sticky? <input checked="" type="checkbox"/> Yes / No	Sticky? Yes/No
Tar Balls Collected?		Yes / <input checked="" type="checkbox"/> No	Yes / <input checked="" type="checkbox"/> No	Yes / No
6. COMMENTS		Cleanup Recommendations; Ecological/Recreational/Cultural Issues; Wildlife Obs.		
<p><u>PATCHES OF OILED WRACK (TARBALLS) ALL ALONG HIGH-TIDE LINE. ESTIMATE 20 BAGS TO BE REMOVED. AREA 1, WITH MOST OILING, IS ADJACENT TO PIER. MANUAL REMOVAL ONLY. HIGH PRIORITY - STATE PARK WITH HIGH RECREATIONAL USE. SAW TWO PLUMERS WITH OIL SPOTS ON BREAST, NEAR PIER.</u></p> <p>Sketch: Yes / <input checked="" type="checkbox"/> No Photos: <input checked="" type="checkbox"/> Yes / No (Roll# <u>1-1</u> Frames <u>7-9</u>) Video Tape: Yes / <input checked="" type="checkbox"/> No (Tape# _____)</p>				

August 2000

You may need to report summary statistics on the number of shoreline miles by degree-of-oiling categories. Use the descriptors in Figure 5, if possible. However, if you must use terms such as "heavy" and "moderate," use survey data to define them objectively. **Figure 10** shows a matrix that can be used to generate summary oiling

Figure 9b. Example of a completed Wetland Assessment Form for a hypothetical survey of a wetland.

WETLAND ASSESSMENT FORM for EXAMPLE Spill Page 1 of 1

1. GENERAL INFORMATION			Date (dd/mm/yy)	Time (24h standard/daylight)	Tide Height															
Segment ID: <u>SP-03</u>			<u>28/08/00</u>	<u>1206</u> hrs to <u>1400</u> hrs	L/M/H <u>H(MSL)</u>															
Segment Name: <u>STATE PARK MARSH</u>			Survey By: <u>Foot</u> Boat / Helicopter / Overlook / <u>Sun</u> Clouds / Fog / Rain / Snow / Windy																	
2. SURVEY TEAM No. <u>1</u>		Name	Organization	Phone Number																
<u>A. SMITH</u>			<u>STATE DNR</u>																	
<u>B. JONES</u>			<u>STATE PARKS</u>																	
<u>C. HILL</u>			<u>NOAA</u>																	
<u>D. ADAMS</u>			<u>USCG</u>																	
3. SEGMENT		Total Length <u>400</u> m/yd	Length Surveyed <u>400</u> m/yd	Differential GPS Yes/ <u>No</u>																
Start GPS: LAT _____ deg.		_____ min	LONG _____ deg.	_____ min																
End GPS: LAT _____ deg.		_____ min	LONG _____ deg.	_____ min																
4. WETLAND CHARACTER		Physical Setting: <u>FRINGING MARSH ALONG INTRACOASTAL W.U.</u>																		
Wetland Type: <u>Salt Marsh</u>		Fresh Marsh / Mangrove / Hardwood Bottomland / Other _____																		
Dominant Vegetation Type/Species: <u>S. ALTERNIFLORA - SPARSELY VEGETATED</u>																				
5. OPERATIONAL FEATURES		Oiled Debris? Yes/ <u>No</u>	Type _____	Amount _____ bags																
Direct backshore access? Yes/ <u>No</u>		Alongshore access from next segment? <u>Yes</u> /No	Access only via boat? Yes/ <u>No</u>																	
Suitable back- or alongshore staging? Yes/ <u>No</u>		Can substrate support foot traffic? <u>Yes</u> /No	Access restrictions: <u>Rough trail on land side of marsh - NO easy access to outer fringe</u>																	
6. SURFACE OILING CONDITIONS		Enter oil on substrate vs vegetation on different lines, using S or V after the Zone ID (e.g., AS for sediment, AV for vegetation). Indicate each on the cross-section below.																		
Zone ID	Tidal Zone				Oil Cover			Oil Thickness					Oil Character				Oil on Plants (e.g. all, trunks, stems, leaves)			
	LI	MI	UI	SU	Length (m/ft)	Width (m/ft)	Distri. %	PO	CV	CT	ST	FL	FR	MS	TB	TC		SR	AP	No
<u>AV</u>			<input checked="" type="checkbox"/>		<u>400</u>	<u>3</u>	<u>100</u>			<input checked="" type="checkbox"/>			<input checked="" type="checkbox"/>							<u>Stems</u>
<u>AS</u>			<input checked="" type="checkbox"/>		<u>400</u>	<u>1</u>	<u>10</u>		<input checked="" type="checkbox"/>				<input checked="" type="checkbox"/>							

7. SUBSURFACE OILING CONDITIONS Describe in Comments Section and indicate on the cross-section below.

8. COMMENTS Cleanup Recommendations; Ecological/Recreational/Cultural Issues; Wildlife Observations.

OIL ON SUBSTRATE AT HIGH-TIDE LINE. DEPLOY SORBENTS ALONG OUTER MARSH FRINGE TO RECOVER RE-MOBILIZED OIL. EXPOSED TO SOME WAVES AND SIGNIFICANT BOAT WAVES, SO EXPECT HIGH RATE OF RE-MOBILIZATION. STAKE SORBENTS TO PREVENT FOULING IN VEGETATION. NO ENTRY INTO MARSH - WORK ONLY FROM THE WATER SIDE.

Sketch: Yes / No Photos: Yes / No (Roll# 1-2 Frames 10-15) Video Tape: Yes / No (Tape# _____)

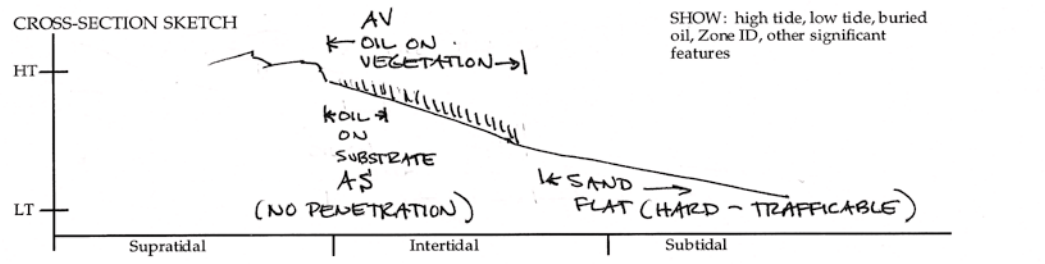

descriptors, in terms of what is defined as “heavy,” “medium,” “light,” and “very light” for a specific spill. These summary descriptors are derived by combining the width of the oiled area and the surface oil distribution for each shoreline segment. The Shoreline Assessment Team Coordinator should complete this matrix when statistics and maps with summary oiling descriptors are needed. However, these terms should NOT be used by the Shoreline Assessment Teams during their field surveys. Terms such as heavy, moderate, light, and very light are *only* for final summaries and maps.

Figure 10.
Matrix for defining terms for shoreline oiling summaries (modified from Environment Canada 1992). Modify this matrix, especially the intervals for width of oiled areas, for specific spill conditions.

		Width of Oiled Areas			
		>3 m	1 - 3 m	0.5 - 1 m	
		Wide	Medium	Narrow	Very Narrow
		>6 m	3 - 6 m	0.5 - 3 m	<0.5 m
Oil Distribution	Continuous 91 - 100%	Heavy	Heavy	Moderate	Light
	Broken 51 - 90%	Heavy	Moderate	Light	Light
	Patchy 11 - 50%	Moderate	Moderate	Light	Very Light
	Sporadic 1 - 10%	Light	Light	Very Light	Very Light
	Trace <1%	Very Light	Very Light	Very Light	Very Light

Use a summary oil descriptor to report the surface oil conditions along the shoreline on maps and tabular summaries. These descriptors are:

- Heavy
- Moderate
- Light
- Very Light

We have assigned these summary oiling descriptors based on the Oil Category Width and the Surface Oil Distribution, as defined in the Shoreline Oil Terminology/ Codes (Fig. 5). The Shoreline Assessment Team Coordinator should obtain consensus on which combinations of oil width and distribution are used field by the

Shoreline Assessment Team to define heavy, moderate, light, and very light oiling. These descriptors are used only in summaries and not in the field by the Shoreline Assessment Team.

Shoreline Terminology/Codes

Remember that SCAT forms are not always needed and usually are not included in the reports generated for Planning and Operations. They are useful as a trigger for reminding the Assessment Team members of the types of observations they need to make during their surveys, as well as for detailed documentation of the shoreline oiling conditions. Operations is mostly interested in the final products of the survey: a description of the shoreline type and oiling conditions, the recommendation for cleanup, the cleanup method to be applied, and any site-specific guidance on how to proceed. These are the priority results that must be transmitted to Operations.

The Shoreline Terminology/Codes sheet in Figure 5 lists the common terms and abbreviations for describing the oil, sediments, and other features on the forms and sketch maps. The team walks the segment to collect field data while a team member records observations on the oiling conditions. It is very important to accurately measure or estimate the dimensions of each type of oil.

Areas containing surface oil are shown on a field sketch of the shoreline segment and described on the survey form. The oil locations, which can be designated by letters, are described systematically on the sketch. To investigate buried oil, trenches must be dug and measurements recorded of the degree and depths of subsurface oil. Number each trench and show each location on the sketch, using solid or open triangle symbols to distinguish oiled from clean trenches.

Field sketches are important

Sketches are a very important component of the field survey data. **Figure 11** shows a sample field sketch that accompanies the field form completed in Figures 7-9. Sketches are better than photographs at characterizing overall conditions. Sketches help reviewers put the tabular data on oiled area and type into perspective, which assists decision-making. They document conditions better than photographs, videotapes, or statistics, and they allow better temporal comparisons. The sketches are particularly useful for spills when Shoreline Assessment Teams change over time. They can be used during post-cleanup inspections of segments to identify the locations of oil that were to be removed, and become the blueprint against which the

SKETCH MAP

CORPUS CHRISTI

Site Name NORTH BEACH, BAY, TEXAS

Site No. CC-1A

Date 30 JULY 1995

Time 1100

Names MOH/SM/10

Checklist

- North Arrow
- Scale
- Oil Distribution
- High Tide Line
- Low Tide Line
- Substrate Types
- Trench Locations

Legend

1 Δ Trench Number.
No Subsurface Oil

2 ▲ Trench Number.
Subsurface Oil

#●→

#●

Photographs

N

0 20 40 60
METERS

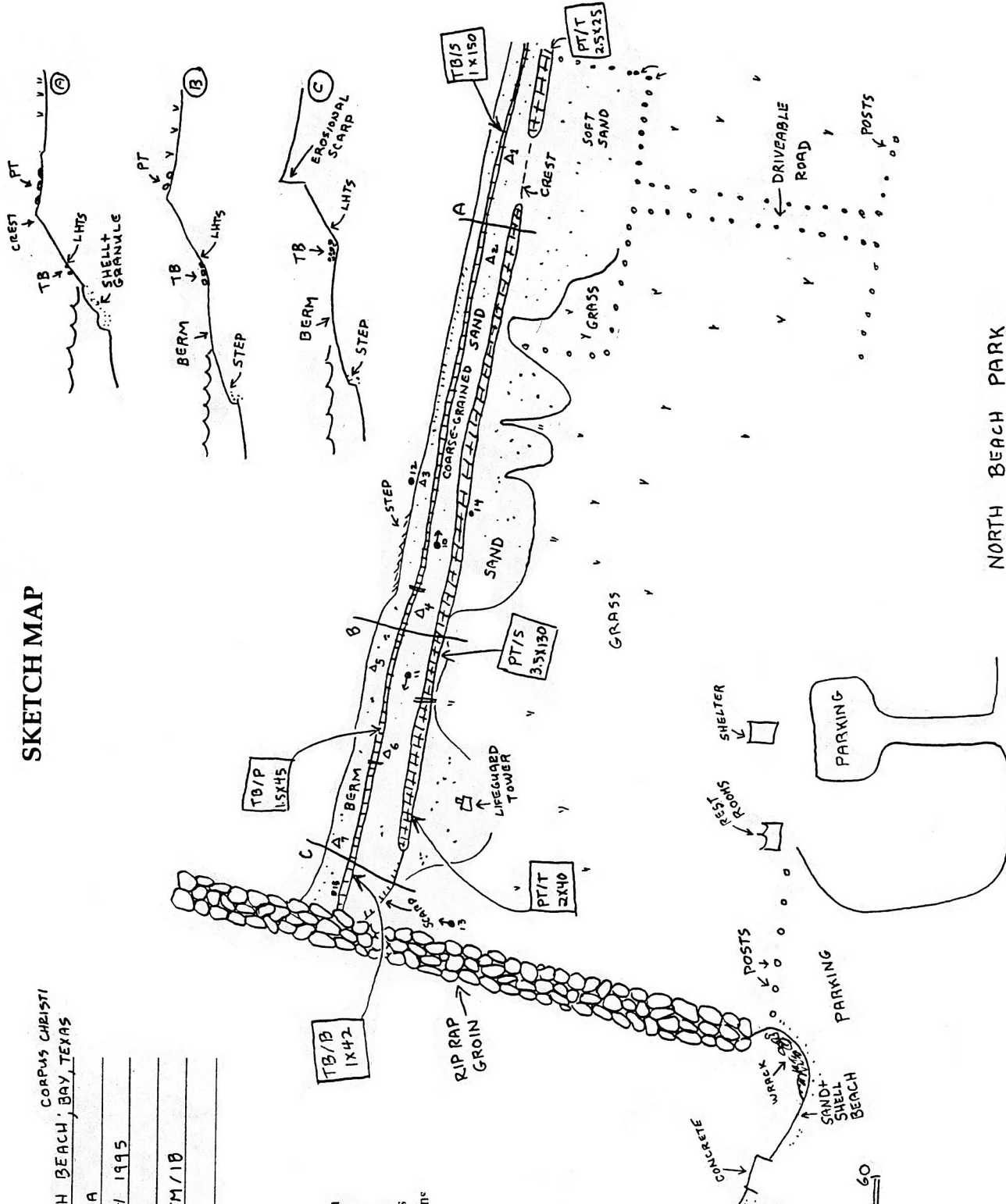

NORTH BEACH PARK

Figure 11. Example shoreline assessment field sketch, showing how the symbology in Figure 10 is used.

effectiveness of the cleanup can be compared. Appendix E is a primer on drawing field sketches.

The objective of the shoreline surveys should always be remembered: to collect the information needed by decision-makers to formulate and approve shoreline cleanup plans. From these surveys, an Operations Section manager or supervisor should be able to use the data to develop a detailed cleanup plan, including equipment and manpower needs. Government agencies should be able to use this data, along with natural resources information, to develop cleanup priorities, identify site-specific or temporal constraints, and understand and approve the proposed cleanup plan.

The shoreline assessment results must be concisely and promptly reported to the Planning Section so that they can be incorporated into the IAP in a timely manner and distributed to other users (**Figure 12**).

Information flow and formats

- The Shoreline Assessment Team reviews the observations and cleanup recommendations for each segment for accuracy and completeness. Each team member signs each form.

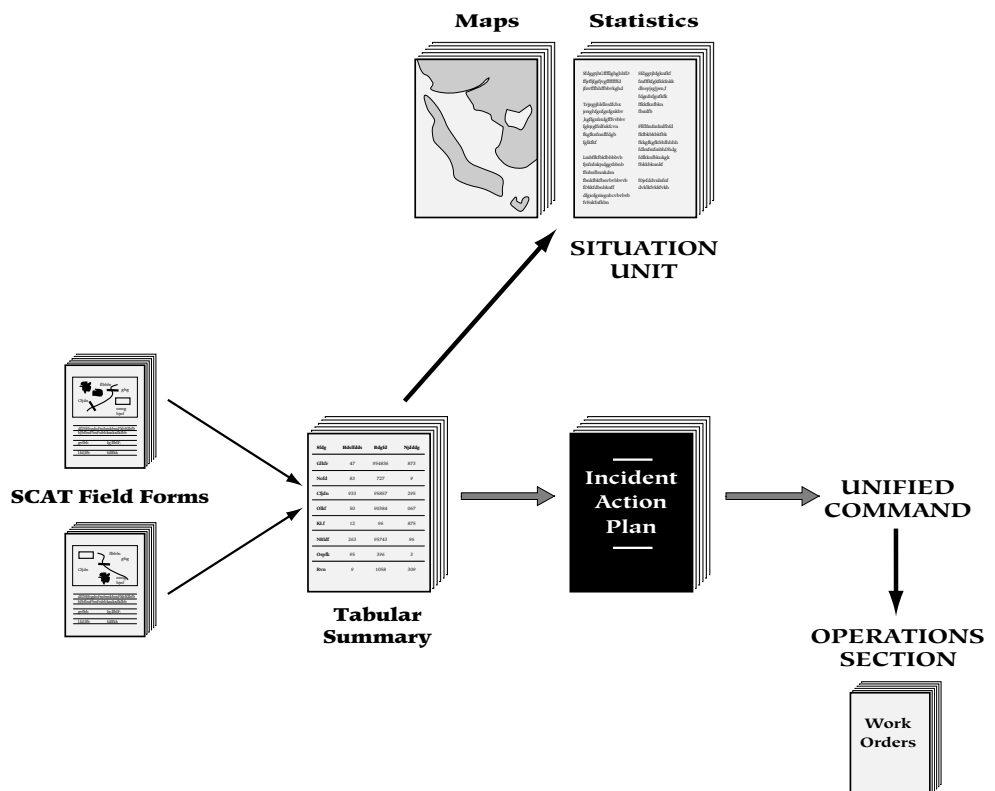

Figure 12. Shoreline assessment information flow.

- The Shoreline Assessment Team Leader compiles all the survey forms for the day and submits them to the Team Coordinator. The Team Leader verbally debriefs the Team Coordinator on the results, issues, etc.
- The Shoreline Assessment Team Coordinator compiles the survey results into summaries by cleanup Division, in a format suitable for incorporating information for the IAP.

SCAT forms always contain this information

The Team Coordinator also verbally debriefs the Planning and Operations Section Chiefs on issues identified by the field teams. At this time, Operations can identify issues for the Shoreline Assessment Team to address. The original field forms must be summarized, and often two types of data summaries are needed: a tabular summary by segment or Division for the IAP; and graphic and tabular summaries for display by the Situation Unit. The Unified Command can specify the format of the tabular summary. **Figures 13-14** show examples of reporting summaries used in the past. The types of data that should be included in any format are:

Date: For some spills, changing conditions will require repeat surveys, so the date of the survey is very important.

Segment Number(s), Name, Division Number: Use the appropriate terms to refer to the shoreline segment. Group segments by Division.

Summary of oiling conditions: The oiling condition can rapidly change. You need to describe the oiling condition when the cleanup recommendation was made. The cleanup supervisor can determine whether the cleanup recommendation is no longer applicable and request a new assessment.

Cleanup recommendations: Use standard terms, as listed in the cleanup descriptions in Appendix B.

Site-specific constraints: Clearly identify these as to location and refer to unambiguous conditions in the field (e.g., do not allow cleanup crews to enter marshes).

You can graphically represent shoreline assessment data on maps and as statistical summaries. Use maps to show the distribution of oiled shoreline and the degrees of oiling. **Figure 15** shows a shoreline oiling map prepared for the 1996 *Julie N* spill

Figure 13.
Example of shoreline
assessment report
from the 1996 Buffalo
292 spill, Galveston,
Texas.

Operational Period: 3-21-96/2100 to 3-22-96/2100		
Shoreline segments visited (See attached maps for segment locations)		
Fort Point (FP) Big Reef Park (BR1, BR2, BR3, BR4) South Jetty (BR5) NE Pelican Island (PI) Pelican Island, Sea Wolf Park (SP1, SP2, SP3) Goat Island (GI1, GI2) North Ferry Landing (NFL1, NFL2)		
Shoreline segments requiring no cleanup action at this time (barring future impact).		
Many of the segments visited by SCAT on 3-20-96 require no cleanup action at this time.		
SP1 -	Oily film and trace tarballs in swash zone.	RECOMMENDATION No cleanup recommended.
SP2 -	Trace to sporadic tarballs in swash zone.	RECOMMENDATION No cleanup recommended.
SP3 -	No oil present.	
FP -	One spot of rip-rap near Big Reef impacted. 10 yds long, broken <5% coverage 200 yards due west from interchapter of Seawall Blvd. and shoreline.	RECOMMENDATION No cleanup recommended, but watch for oiling on front and back of rip-rap with tidal change over next 2 days.
Shoreline segments requiring cleanup action. See attached reports for more detail.		
BR1 -	<u>Reimpacted</u> , sporadic mousse and tarballs with 10-15% coverage, no subsurface impact. No cleanup activity present.	RECOMMENDATION Revisit by cleanup crew doing manual recovery, revisit daily.
BR2 -	<u>Reimpacted</u> , continuous to sporadic with 10% coverage of film, mousse, and tarballs, no subsurface impact. No cleanup activity present.	RECOMMENDATION Revisit by cleanup crew doing manual recovery, revisit daily.
BR3 -	Continuous to patchy oiling with 20% coverage more evenly dispersed as compared to yesterday, no subsurface impact. Small cleanup crew (approx. 15 people) present.	RECOMMENDATION Continue cleanup.
BR4 -	10-15% coverage, continuous to sporadic, no subsurface impact. Cleanup activity in progress.	RECOMMENDATION Continue cleanup operations.
BR5 -	Oil still leaching from South Jetty, snare being deployed and tended.	RECOMMENDATION Maintain snare on both south and north side of South Jetty with frequent tending to ensure effective capture of oil leaching from riprap.
EB -	No oil, but some type of film is present on surface, (maybe organic), some snare is starting to float up on East Beach near the jetty.	RECOMMENDATION Visit by cleanup crew for manual recovery of snare and other oily debris washing up.
P1 -	Trace to sporadic tarballs stranded in water and upper intertidal zone, film cover in wide to medium width with 100 yds of patchy tarballs trapped within, no subsurface impact.	RECOMMENDATION Manual removal with snare placed in swash zone.
SCAT was performed at low to mid tide. High tide may relocate observed oil.		
202 ICS 3/80	Prepared by:	Approved by (Incident Commander):

in Portland, Maine. Standardize definitions for the shoreline oiling categories (modify your definitions from Fig. 10). Use computer mapping software to tabulate the number of kilometers (or miles) of shoreline by oiling degree and cleanup status. These are important measures for reporting the progress of the cleanup.

While it is clear that Shoreline Assessment Teams should not direct cleanup contractors in the field, the team can meet with the Operations Division Supervisor when conducting surveys in his/her division. The team can invite the Operations Division Supervisor to:

Figure 14.
Example of shoreline
assessment report
from the 1996 Cape
Mohican spill, San
Francisco, California.

SCAT Cleanup Priorities and Methods		Page 1
SEGMENT NAME:	Ocean Beach	
DIVISION:	O	
OIL TYPE:	Tarballs	
OIL EXTENT:	1 m wide by 4.7 miles long	
OIL LOCATION:	The high tide zone along the entire length of Ocean Beach	
CLEANUP TECHNIQUES:	Small crew needed with a lawn roller and sorbent pads. The roller wrapped in pads picks up the tarballs from the beach. Tarballs mixed with vegetative debris in wrack line. The federally threatened snowy plovers (birds) have been oiled. A National Park Service representative should be on-scene during cleanup. Recommend 1 crew for manual removal.	
SEGMENT NAME:	Muir Beach	
DIVISION:	S	
OIL TYPE:	Tarballs	
OIL EXTENT:	1 m wide by 1,600 m long	
OIL LOCATION:	In the high tide swash of the sand beach	
CLEANUP TECHNIQUES:	Manual removal of tarballs. Rakes, shovels, and plastic bags required. Need 6 men.	
SEGMENT NAME:	China Beach	
DIVISION:	H-2	
OIL TYPE:	Tarballs	
OIL EXTENT:	Entire length of beach	
OIL LOCATION:		
CLEANUP TECHNIQUES:	Trace tarballs scattered on beach. No further cleanup required. Ready to be examined for sign-off.	

- accompany them on their survey (which is unlikely for most spills because of time demands on the Division Supervisor);
- accompany them on a quick walk-through after the survey is completed, going over the team’s recommendations; or
- meet after the survey to go over their recommendations.

Direct communication with the Shoreline Assessment Team gives the Division Supervisor immediate feedback and a better understanding of the agency concerns, the details of which are lost as the survey reports are filtered through the IAP and the chain of command. However, this means that the Shoreline Assessment Team must be very concise during their debriefing with the Division Supervisor and not burden that individual with unnecessary technical detail.

Tanker JULIE N Incident

Shoreline Oiling Map
prepared by NOAA

Date/Time: 04 OCT 96, 1000

USE ONLY AS A GENERAL REFERENCE

Graphic does not represent precise amounts or locations of oil

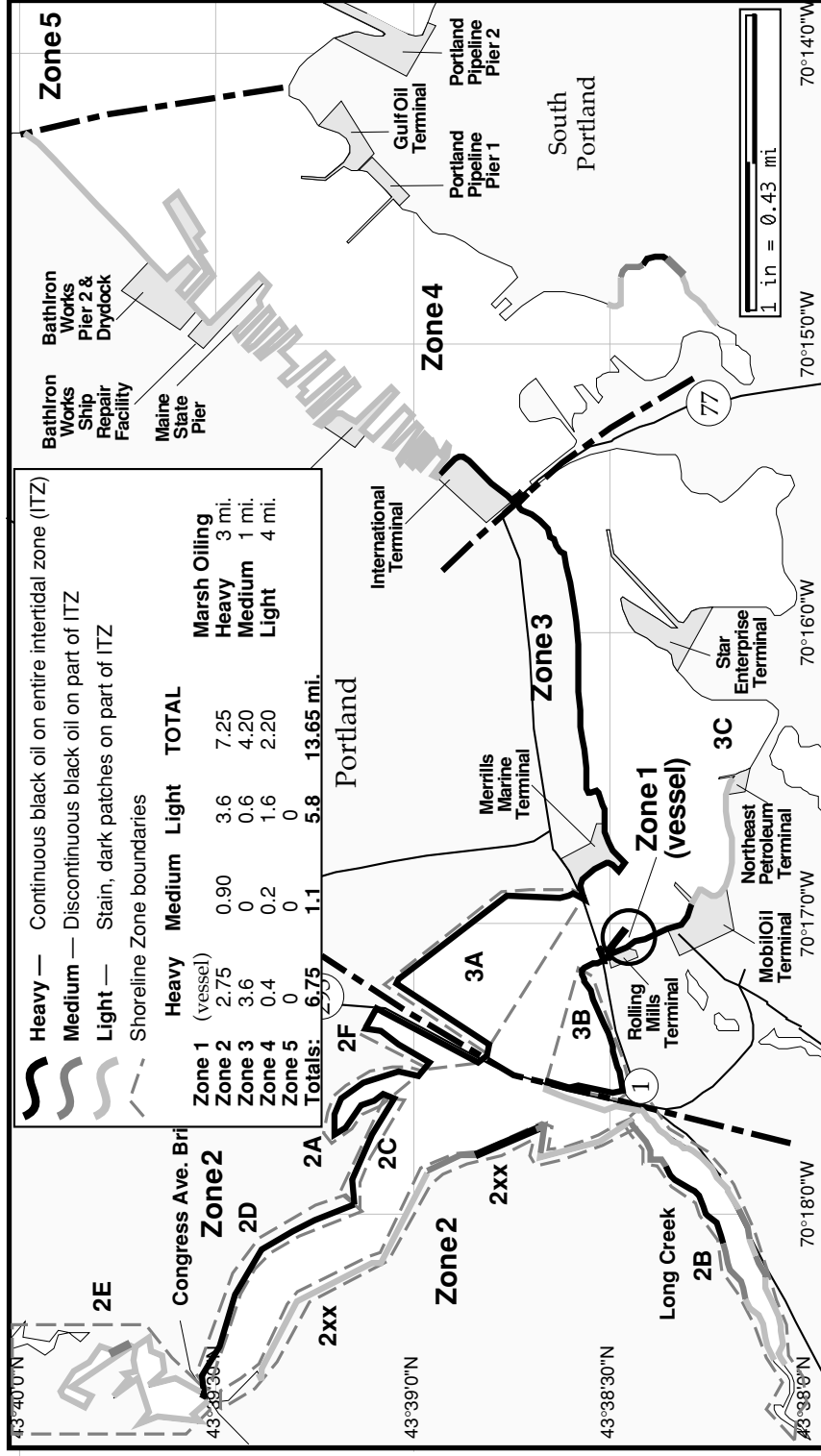

CJH

Figure 15. Example of shoreline oiling summary map, from the 1996 Julie N spill in Portland, Maine.

7 Planning for Shoreline Assessments

Define the Roles in the Area Plan

You are encouraged to plan ahead for shoreline assessments through the Area Committee. The Area Contingency Plan can identify the personnel, process, and logistics to be used for shoreline assessments before a spill occurs. It can also pre-approve the use of cleanup methods for special problem areas. This kind of pre-planning should include:

- Identifying Shoreline Assessment Team Coordinator (NOAA SSC or state counterpart); and
- Identifying a pool of state and Federal personnel who can represent their agencies' concerns and be available to do shoreline assessments for the duration of a spill. *These personnel must be trained in shoreline processes, terminology, and cleanup methods.*

Process

- Adopt a Shoreline Survey Evaluation Form.
- Develop a strategy for segmenting shorelines in your area on maps or charts.
- Pre-approve the use of cleanup methods for each shoreline type. Form workgroups to identify special cleanup concerns (e.g., cutting of oiled seaweeds, use of shoreline cleaning agents, recovery of submerged oil), research the cleanup options, and make recommendations on their use for inclusion in the Area Plan.
- Develop general guidelines for cleanup endpoints.
- Decide how to transition Shoreline Assessment Teams into Sign-off Teams;

Logistics

- Identify and acquire shoreline assessment equipment.
- Identify the need for air boats, boats, or special vehicles, particularly in remote areas.
- Identify the types of communications needed by field teams (e.g., radios, cellular phones).

8 Pre-Impact Assessments

Many times we are called to respond to the threat of an oil spill, such as when a grounding occurs close to shore or when an offshore slick threatens a coastline. In such cases, we often have time to develop useful spill-specific contingency plans.

An important part of planning for potential shoreline impacts is shoreline assessment. Pre-impact assessments focus primarily on identifying priority resources at risk and recommending the necessary preparedness actions in order to protect those resources in the event of an oil release. The use of a Shoreline Assessment Team, as identified for normal shoreline cleanup assessment, is an appropriate way to accomplish pre-impact shoreline assessment.

- Pre-impact Activities**
- Collecting data on shoreline types, and ecological and human-use resources along the entire coastline at risk.
 - Identifying access and staging locations;
 - Identifying any natural or preferred collection points;
 - Identifying any areas that should be pre-cleaned of wrack or other debris; and
 - Evaluating and recommending protection options, requirements, and priorities.

It is the responsibility of the Unified Command to scale the risk associated with potential spill scenarios and make a judgment call as to the level of pre-assessment effort that is warranted.

9 References

Environment Canada. 1992. Oilspill SCAT manual for the coastlines of British Columbia. Edmonton, Alberta, Canada: Technology Development Branch, Conservation and Protection, Environment Canada. 245 p.

Martin, R.D., I. Byron, & R. Pavia. 1997. Evolution of shoreline cleanup assessment team activities during the *Buffalo* 292 oil spill. In Proceedings of the International Oil Spill Conference, April 7-10, 1997, Fort Lauderdale, Florida, p. 33-39. API Publ. 4651. Wash. DC: American Petroleum Institute.

NOAA & American Petroleum Institute. 1994. Options for minimizing environmental impacts of freshwater spill response. Seattle: Hazardous Materials Response and Assessment Division, National Oceanic and Atmospheric Administration. 130 p. + appendices.

NOAA & American Petroleum Institute. In press. Environmental considerations for oil spill response. Seattle: Hazardous Materials Response and Assessment Division, National Oceanic and Atmospheric Administration.

Owens, E., & A. Teal. 1990. Shoreline cleanup following the *Exxon Valdez* oil spill: Field data collection within the S.C.A.T. program. In Proceedings of the 13th Arctic and Marine Oil Spill Program Technical Seminar, June 6-8, 1990, Edmonton, Alberta, Canada, p. 411-421. Ottawa, Ontario, Canada: Emergency Sciences Div., Environment Canada.

USCG (U.S. Coast Guard). 1996. Field operations guide: Incident Command System (ICS). ICS-OS-420-1. Wash. DC: Office of Response, U.S. Coast Guard.

Appendix A: Shoreline Assessment Equipment Checklist

Survey Gear

- Maps or charts of the survey area
- Clipboards and rubber bands
- Pencils, erasers, waterproof markers
- Field forms (code sheets, shoreline form, sketch sheets, photo logs)
- Field estimation charts (sand size, gravel size, percent cover)
- Field notebooks (waterproof)
- Segment map sheets
- Base sketch maps, if available
- Shovels
- Camera (35 mm) and color print film (ASA 64 and 100); extra batteries
- Videocamera and video tapes, if required; extra batteries
- Photo scale (15 cm)
- Tape measure (30 m) and ruler
- Range finder
- Hand-held GPS
- Compass, preferably Brunton
- Field pack
- Communication device (e.g., radio or cellular phone)
- First-aid kit

Personal Gear

- Good rain gear
- Knee-high, rubber boots or hip waders
- Work gloves
- "Tar-off" towelettes or similar hand cleaner
- Hat
- Sunscreen
- Drinking water
- Personal Flotation Device (PFD) if traveling by water/helicopter
- Personal day pack

Appendix B: Brief Descriptions of Shoreline Cleanup Methods

Shoreline Cleanup Methods

Introduction

This section describes methods currently in use during cleanup of oil spills in marine environments and habitats. For each method the following is provided: a summary of the objective in using the method, a general description of the method, applicable habitat types, conditions under which the methods should be used (constraints commonly applied to the use of the method to protect sensitive biological resources), and the environmental effects expected from the proper use of the method. Some of the methods listed require special authorization for use during a spill; appropriate agencies must be contacted about the need for special approvals.

A problem which occurs after all major oil spills is that there is a large quantity of oily wastes and debris that is generated and must be dealt with as part of the response action. A cleanup strategy that minimizes the impact to all sensitive aspects of the environment and minimizes the amount of oily wastes is the most optimal. History has shown that oily wastes or debris that have been buried inappropriately can result in formation of leachates that contaminate surface and groundwater resources. Each cleanup option should be examined with the problem of waste generation and disposal in mind.

Additional information and guidance for the application of shoreline cleanup methods appropriate for each shoreline type can be found in the "Marine Manual" and the "Freshwater Manual" jointly published by NOAA, the American Petroleum Institute, and others. In these manuals different cleanup methods are classified by shoreline and oil types according to their potential for causing habitat impact. The matrixes in these manuals are a good starting point for identifying appropriate cleanup methods for specific spill conditions.

Natural Recovery

Objective No attempt is made to remove any stranded oil, when there is no effective method for cleanup or to minimize impact to the environment. Oil is left to degrade naturally.

Description No action is taken, although monitoring of contaminated areas is required.

**Applicable
Habitat Types** All habitat types.

When to Use When natural removal rates are fast (e.g., gasoline evaporation or high energy coastlines), when the degree of oiling is light, access is severely restricted or dangerous to cleanup crews, or when cleanup actions will do more harm than natural removal.

Biological Constraints This method may be inappropriate for areas used by high numbers of mobile animals (birds, marine mammals) or endangered species.

Environmental Effects Same as from the oil alone.

Waste Generation None.

Barriers/ Berms

Objective To prevent entry of oil into a sensitive area or to divert oil to a collection area.

Description A physical barrier other than a boom is placed across an area to prevent oil from passing. Barriers can consist of earthen berms or filter fences. When it is necessary for water to pass because of water volume, underflow or overflow dams are used.

Applicable Habitat Types At the mouths of creeks or streams to prevent oil from entering from offshore, or to prevent oil from being released from the creek into offshore waters. Also, on beaches where a high berm can be built above the high-tide line to prevent oil from over-washing the beach and entering a sensitive back-beach habitat (e.g. lagoon).

When to Use When the oil threatens sensitive habitats, and other barriers are not feasible. To protect sensitive areas when cleaning adjacent shorelines.

Biological Constraints Responders must minimize disturbance to sensitive areas, such as shorebird nesting sites on beaches. Placement of dams and filter fences could cause excessive physical disruptions to the site, particularly in wetlands.

Environmental Effects May disrupt or contaminate sediments and adjacent vegetation. The natural beach or shore profile should be restored (may take weeks to months on gravel beaches).

Waste Generation Sediment barriers will become contaminated on the oil side and filter fence materials will have to be disposed of as oily wastes.

Physical Herding

Objective	To free any oil trapped in debris or vegetation on-water; to direct the movement of floating oil towards containment and recovery devices; or to divert oil away from sensitive areas.
Description	Plunging water jets, water or air hoses, and propeller wash can be used to dislodge trapped oil and divert or herd it to containment and recovery areas. May emulsify the oil. Mostly conducted from small boats.
Applicable Habitat Types	In nearshore areas where there are little or no currents, and in and around man-made structures such as wharves and piers. In streams where oil is trapped by debris.
When to Use	In low-current or stagnant water bodies, to herd oil towards recovery devices. In high current situations to divert floating oil away from sensitive areas, or dislodge oil from debris.
Biological Constraints	When used near shore and in shallow water, must be careful to not disrupt bottom sediments or submerged aquatic vegetation.
Environmental Effects	May generate high levels of suspended sediments and mix them with the oil, resulting in deposition of contaminated sediments in benthic habitats.
Waste Generation	None.

Manual Oil Removal/Cleaning

Objective	To remove oil with hand tools and manual labor.
Description	Removal of surface oil with hands, rakes, shovels, buckets, scrappers, sorbents, pitchforks, etc., and placing in containers. No mechanized equipment is used. Includes underwater recovery of submerged oil by divers with hand tools, for example.
Applicable Habitat Types	Can be used on all habitat types.
When to Use	Light to moderate oiling conditions for stranded oil or heavy oils that have formed semi-solid to solid masses that can be picked up manually. Also can be used in areas where roosting or birthing animals cannot or should not be disturbed.
Biological Constraints	Foot traffic over sensitive areas (wetlands, tidal pools, etc.) should be restricted or prevented. There may be periods when shoreline access should be avoided, such as during bird nesting.
Environmental Effects	Minimal, if surface disturbance by crew movement and waste generation is controlled.
Waste Generation	May generate significant quantities of oil mixed with sediment which must be properly disposed of or treated. Decontamination of hand tools may produce oily wastewater that must be treated properly. Worker personal protective gear is usually disposed of daily or decontaminated and the resulting oily wastewater treated properly.

Mechanical Oil Removal

Objective To remove oil from shorelines and bottom sediments with mechanical equipment.

Description Oil and oiled sediments are collected and removed using mechanical equipment such as backhoes, graders, bulldozers, dredges, draglines, etc. Requires systems for temporary storage, transportation, and final treatment and disposal.

Applicable Habitat Types On land, wherever surface sediments are both amenable to and accessible to heavy equipment. For submerged oil, used in sheltered areas where oil accumulates. On water, used on viscous to solid oil.

When to Use When large amounts of oiled materials must be removed. Care should be taken to remove sediments only to the depth of oil penetration, which can be difficult when using heavy equipment. Should be used carefully where excessive sediment removal may cause erosion.

Biological Constraints Heavy equipment may be restricted in sensitive habitats (e.g., wetlands, soft substrate) or areas containing endangered species. Will need special permission to use in areas with known cultural resources. Dredging in seagrass beds or coral reef habitats may be prohibited. The noise generated by the mechanical equipment may also be a constraint.

Environmental Effects The equipment is heavy, with many support personnel required. May be detrimental if excessive sediments are removed without replacement. All organisms in the sediments will be affected, although the need to remove the oil may make this response method the best overall alternative. Resuspension of exposed oil and fine-grained oily sediments can affect adjacent bodies of water.

Waste Generation Can generate significant quantities of contaminated sediment that must be cleaned or landfilled. The amount of waste generated by this cleanup option should be given careful consideration by response planners when reviewing potential environmental impacts of the oily wastes, debris, and residues.

Sorbents

Objective To remove surface oil by absorption onto oleophilic (oil-attracting) material placed in water or at the waterline.

Description Sorbent material is placed *on the floating oil or water surface* to allow it to sorb oil, or alternatively, the material can be used to wipe or dab stranded oil. Forms include sausage boom, pads, rolls, sweeps, snares, and loose granules or particles. These products can be either synthetic or natural substances. Efficacy depends on the capacity of the particular sorbent, energy available for lifting oil off the substrate, and stickiness of the oil. Recovery of all sorbent material is mandatory. Loose particulate sorbents must be contained in a mesh or other material.

Applicable Habitat Types Can be used on any habitat or environment type.

When to Use When oil is free-floating close to shore or stranded on shore. The oil must be able to be released from the substrate and absorbed by the sorbent. Often used as a secondary treatment method after gross oil removal and in sensitive areas where access is restricted. Selection of sorbent varies by oil type; heavy oils only coat surfaces, requiring a high surface area to be effective, whereas lighter oils can penetrate sorbent material.

Biological Constraints Access for deploying and retrieving sorbents should not be through soft or sensitive habitats or affect wildlife. Sorbent use should be monitored to prevent overuse and generation of large volumes of waste. Sorbents should not be used in a fashion that would endanger or trap wildlife. Sorbents left in place too long can break apart and present an ingestion hazard to wildlife.

Environmental Effects Physical disturbance of habitat during deployment and retrieval. Improperly deployed or tended sorbent material can crush or smother sensitive substrates.

Waste Generation Sorbents must eventually be collected for proper disposal so care should be taken to select and use sorbents properly, and prevent generation of large amounts of lightly-oiled sorbents. Recycling should be emphasized rather than disposal.

Vacuum

Objective	To remove oil pooled on a shoreline substrate or subtidal sediments.
Description	A vacuum unit is attached via a flexible hose to a suction head that recovers free oil. The equipment can range from small, portable units that fill individual 55-gallon drums to large supersuckers that are truck- or vessel-mounted and can generate enough suction to lift large rocks. Removal rates from substrates can be extremely slow.
Applicable Habitat Types	Any accessible habitat type. May be mounted on barges for water-based operations, on trucks driven to the recovery area, or hand-carried to remote sites.
When to Use	When oil is stranded on the substrate, concentrated in trenches or trapped in vegetation. Usually requires shoreline access points.
Biological Constraints	Special restrictions should be established for areas where foot traffic and equipment operation may be damaging, such as soft substrates. Operations in wetlands need to be very closely monitored, with a site-specific list of restrictions developed to prevent damage to vegetation.
Environmental Effects	Minimal, if foot and vehicular traffic is controlled and minimal substrate is damaged or removed.
Waste Generation	Collected oil and or oil/water mix will need to be stored temporarily prior to recycling or disposal. Oil may be recyclable; if not, it will require proper disposal. Large amounts of water are often recovered, requiring separation and treatment.

Debris Removal

Objective	To remove contaminated debris from the shoreline or water surface.
Description	Manual or mechanical removal of debris from the shore or water surface. Can include cutting and removal of oiled logs.
Applicable Habitat Types	Can be used on any habitat or environment type where access is safe.
When to Use	When driftwood and debris are heavily contaminated and provide a potential source of chronic oil release. When it may create aesthetic problems, be a source of contamination for other resources in the area, cause clogging problems in the skimmer, or create safety problems for responders. Used in areas of debris accumulation on beaches prior to oiling to minimize the amount of oiled debris to be handled.
Biological Constraints	Foot traffic over sensitive areas (wetlands, spawning grounds) needs to be restricted. May be periods when access should be restricted (spawning periods, influx of large numbers of migratory waterbirds).
Environmental Effects	Physical disruption of substrate, especially when mechanized equipment must be deployed to recover a large quantity of debris.
Waste Generation	Will generate contaminated debris (volume depends on what, and how much, is collected, e.g., logs, brush). Unless there is an approved hazardous waste incinerator that will take oily debris, burning will seldom be allowed, especially on-site burning. However, this option should still be explored, especially for remote locations, with the appropriate state or federal agencies who must give approvals for burning.

Sediment Reworking/Tilling

Objective	To enhance the rate of degradation, by breaking up oily sediments and surface oil deposits, increasing the surface area, and mixing deep subsurface oil layers to the surface.
Description	The oiled sediments are roto-tilled, disked, or otherwise mixed using mechanical equipment or manual tools. Along beaches, oiled sediments may also be pushed to the water's edge (surf washing) to enhance natural cleanup by wave activity. The process may be aided with high-volume flushing of gravel.
Applicable Habitat Types	On any sedimentary substrate that can support mechanical equipment or foot traffic.
When to Use	On sand to gravel beaches with subsurface oil, where sediment removal is not feasible (due to erosion or disposal problems). On sand beaches where the sediment is stained or lightly oiled. Appropriate where oil is stranded above normal high waterline.
Biological Constraints	Avoid use on shores near sensitive wildlife habitat, such as fish-spawning areas or bird-nesting or concentration areas because of the potential for release of oil and oiled sediments into adjacent bodies of water. Should not be used in shellfish beds.
Environmental Effects	Due to the mixing of oil into sediments, this method could further expose organisms that live below the original layer of oil. Repeated mixing over time could delay reestablishing organisms. Refloated oil from treated sites could contaminate adjacent areas.
Waste Generation	None.

Vegetation Cutting/Removal

Objective	To remove portions of oiled vegetation or oil trapped in vegetation to prevent oiling of wildlife or secondary oil releases.
Description	Oiled vegetation is cut with weed wackers, blades, etc., and picked or raked up and bagged for disposal.
Applicable Habitat Types	Habitats composed of vegetation such as wetlands, seagrass beds, and kelp beds.
When to Use	When the risk of oiled vegetation contaminating wildlife is greater than the value of the vegetation that is to be cut, and there is no less-destructive method that removes or reduces the risk to acceptable levels.
Biological Constraints	Operations must be strictly monitored to minimize the degree of root destruction and mixing of oil deeper into the sediments. Access in bird-nesting areas should be restricted during nesting seasons. Cutting only the oiled portions of the plants and leaving roots and as much of the stem as possible minimizes impact to plants.
Environmental Effects	Vegetation removal will destroy habitat for many animals. Cut areas will have reduced plant growth, and in some instances, plants may be killed. Cutting at the base of the plant stem may allow oil to penetrate into the substrate, causing subsurface contamination. Along exposed sections of shoreline, the vegetation may not recover, resulting in erosion and habitat loss. Trampled areas will recover much more slowly.
Waste Generation	Cut portions of oiled plants must be collected and disposed.

Flooding

Objective To wash oil stranded on the land surface to the water's edge for collection.

Description A perforated header pipe or hose is placed above the oiled shore or bank. Ambient-temperature water is pumped through the header pipe at low pressures and flows downslope to the water. On porous sediments, water flows through the substrate, pushing loose oil ahead of it, or floating oil to the water's surface and transporting the oil down the slope for pickup. On saturated, fine-grained sediments, the technique becomes more of a flushing of the surface.

Applicable Habitat Types All shoreline types where the equipment can be effectively deployed. Not effective in steep intertidal areas.

When to Use In heavily oiled areas when the oil is still fluid and adheres loosely to the substrate, and where oil has penetrated into gravel sediments. This method is frequently used with other washing techniques (low- or high-pressure, cold-to-hot-water flushing).

Biological Constraints Special care should be taken to recover oil where nearshore habitats contain rich biological communities. Not appropriate for muddy substrates.

Environmental Effects Habitat may be physically disturbed by foot traffic during operations and smothered by sediments washed down the slope. Oiled sediment may be transported to shallow nearshore areas, contaminating them and burying benthic organisms.

Waste Generation Depends on the effectiveness of the collection method.

Low-Pressure, Ambient- Water Flushing

Objective To remove fluid oil that has adhered to the substrate or man-made structures, pooled on the surface, or become trapped in vegetation.

Description Ambient-temperature water is sprayed at low pressures (<10 psi), usually from hand-held hoses, to lift oil from the substrate and direct it to the water's edge for recovery by skimmers, vacuum, or sorbents. Can be used with a flooding system to prevent released oil from re-adhering to the substrate downstream of the treatment area.

Applicable Habitat Types On substrates, riprap, and solid man-made structures, where the oil is still fluid. In wetlands and along vegetated banks where oil is trapped in vegetation.

When to Use Where fluid oil is stranded onshore or floating on shallow intertidal areas.

Biological Constraints May need to restrict use so that the oil/water effluent does not drain across sensitive intertidal habitats and mobilized sediments do not affect rich subtidal communities. Use from boats will reduce the need for foot traffic in soft substrates and vegetation. Flushed oil must be recovered to prevent further oiling of adjacent areas.

Environmental Effects If containment methods are not sufficient, oil and oiled sediments may be flushed into offshore areas. Some trampling of substrate and attached biota will occur.

Waste Generation Depends on the effectiveness of the collection method.

High-Pressure, Ambient- Water Flushing

Objective	To remove oil that has adhered to hard substrates of man-made structures.
Description	Similar to low-pressure flushing except that water pressure is 100-1,000 psi. High-pressure spray will more effectively remove sticky or viscous oils. If low-water volumes are used, sorbents are placed directly below the treatment area to recover oil.
Applicable Habitat Types	On bedrock, man-made structures, and gravel substrates.
When to Use	When low-pressure flushing is not effective at removing adhered oil that must be removed to prevent continued oil release or for aesthetic reasons. When a directed water jet can remove oil from hard-to-reach sites.
Biological Constraints	May have to restrict flushing so that the oil does not drain across sensitive habitats. Flushed oil must be recovered to prevent further oiling of adjacent areas.
Environmental Effects	Attached animals and plants in the direct spray zone will be removed. May drive oil deeper into the substrate or erode shorelines of fine sediments if water jet is improperly applied. If containment methods are not sufficient, oil and oiled sediments may be flushed into offshore areas. Some trampling of substrate and attached biota will occur.
Waste Generation	Depends on the effectiveness of the collection method.

**Low-Pressure,
Hot-Water
Flushing**

Objective To remove non-fluid oil that has adhered to the substrate or man-made structures, or pooled on the surface.

Description Hot water (90°F up to 170°F) is sprayed with hoses at low pressures (<10 psi) to liquefy and lift oil from the substrate and direct it to the water's edge for recovery by skimmers, vacuums, or sorbents. Used with flooding to prevent released oil from re-adhering to the substrate.

Applicable Habitat Types On bedrock, sand to gravel substrates, and man-made structures.

When to Use Where heavy, but relatively fresh oil is stranded onshore. The oil must be heated above its pour point, so it will flow. Less effective on sticky oils.

Biological Constraints Avoid wetlands or rich intertidal communities so that hot oil/water effluent does not contact sensitive habitats. Operations from boats will help reduce foot traffic in soft substrates and vegetation. Flushed oil must be recovered to prevent further oiling of adjacent areas.

Environmental Effects Hot-water contact can kill all attached animals and plants. If containment methods are not sufficient, oil may be flushed into downstream areas. Some trampling of substrate and biota will occur.

Waste Generation Depends on the effectiveness of the collection method.

High-Pressure, Hot-Water Flushing

Objective To mobilize weathered and viscous oil strongly adhered to surfaces.

Description Hot water (90°F [32°C] up to 171°F [77°C]) is sprayed with hand-held wands at pressures greater than 100 psi (720 kpa). If used without water flooding, this procedure requires immediate use of vacuum or sorbents to recover the oil/water runoff. When used with a flooding system, the oil is flushed to the water surface for collection by skimmers, vacuum, or sorbents.

Applicable Habitat Types Gravel substrates, bedrock, and man-made structures.

When to Use When oil has weathered to the point that warm water at low pressure no longer effectively removes oil. To remove viscous oil from man-made structures for aesthetic reasons.

Biological Constraints Use should be restricted so that the oil/water effluent does not drain across sensitive habitats (damage can result from exposure to oil, oiled sediments, and hot water). Should not be used directly on attached algae nor rich, intertidal areas. Released oil must be recovered to prevent further oiling of adjacent areas.

Environmental Effects All attached animals and plants in the direct spray zone will be removed or killed, even when used properly. Oiled sediment may be transported to shallow nearshore areas, contaminating them and burying benthic organisms.

Waste Generation Depends on the effectiveness of the collection method.

Steam Cleaning

Objective To remove heavy residual oil from solid substrates or man-made structures.

Description Steam or very hot water (171°F [77°C] to 212°F [100°C]) is sprayed with hand-held wands at high pressure (2000+ psi [14,400 kpa]). Water volumes are very low compared to flushing methods.

Applicable Habitat Types Man-made structures such as seawalls and riprap.

When to Use When heavy oil residue must be removed for aesthetic reasons, and when hot-water flushing is not effective and no living resources are present.

Biological Constraints Not to be used in areas of soft substrates, vegetation, or high biological abundance directly on, or below, the structure.

Environmental Effects Complete destruction of all organisms in the spray zone. Difficult to recover all released oil.

Waste Generation Depends on the effectiveness of the collection method. Usually sorbents are used, generating significant waste volumes.

Sand Blasting

Objective	To remove heavy residual oil from solid substrates or man-made structures.
Description	Use of sandblasting equipment to remove oil from the substrate. May include recovery of used (oiled) sand in some cases.
Applicable Habitat Types	On heavily oiled bedrock, artificial structures such as seawalls and riprap.
When to Use	When heavy oil residue must be cleaned for aesthetic reasons, and even steam-cleaning is not effective.
Biological Constraints	Not to be used in areas of soft substrate, vegetation, or high biological abundance directly below, or adjacent to, the structures.
Environmental Effects	Complete destruction of all organisms in the blast zone. Possible smothering of downstream organisms. Unrecovered, used sand will introduce oiled sediments into the adjacent habitat.
Waste Generation	Will need to recover and dispose of oiled sand used in blasting.

Dispersants

Objective	To reduce impact to sensitive shoreline habitats and animals that use the water surface by chemically dispersing oil into the water column.
Description	Dispersants reduce the oil/water interfacial tension, thereby decreasing the energy needed for the slick to break into small particles and mix into the water column. Specially-formulated products containing surface-active agents are sprayed (at concentrations of 1-5 percent by volume of the oil) from aircraft or boats onto the slicks. Products can be applied undiluted or mixed with water. Some agitation is needed to achieve dispersion.
Applicable Habitat Types	Water bodies with sufficient depth and volume for mixing and dilution.
When to Use	When the impact of the floating oil has been determined to be greater than the impact of dispersed oil on the water-column community.
Biological Constraints	Use in shallow water could affect benthic resources. Consideration should be made to avoid directly spraying any wildlife, especially birds or fur-bearing marine mammals.
Environmental Effects	Until sufficiently diluted, the dispersed oil may adversely impact organisms in the upper 30 feet (10 meters) of the water column. Because dispersion will only be partially effective, some water-surface and shoreline impacts could occur.
Waste Generation	None.

Emulsion-Treating Agents

Objective	To break or destabilize emulsified oil into separate oil and water phases. Can be used to prevent emulsion formation, increasing oil recovery rates, extending the window for dispersant application, or making burning possible.
Description	Emulsion-treating agents are surfactants that are applied to emulsified oil at low concentrations (0.1-2 percent). They can be injected into skimmer reservoirs to break the emulsion as it is skimmed from the water. They can be sprayed (similar to dispersants) directly onto slicks to break or prevent emulsions, although this type of application has not been used operationally.
Applicable Habitat Types	On all water environments where emulsified oil is present.
When to Use	Where storage capacities are very limited, to separate the recovered, emulsified oil and water so that the water can be treated and discharged. On floating slicks, where emulsified oil can reduce skimmer efficiency.
Biological Constraints	There is insufficient information to evaluate biological constraints.
Environmental Effects	Because this is a new method, there are few data available to evaluate environmental effects. Effective dosages are one to two orders of magnitude lower than dispersants. Environmental concerns include the potential for increased oil content of separated water; whether the oil will be more readily dispersed; and how the treated oil will behave upon contact with skimming equipment, birds, mammals, and shorelines.
Waste Generation	May enable recycling of oil/water mixtures by breaking down emulsions.

Elasticity Modifiers

Objective	To impart visco-elastic properties to floating oil, thereby increasing skimming rates.
Description	The product is applied as a liquid, slurry, or solid onto the oil. Some mixing is required and is usually provided by the water spray during application. Treated oil is rendered visco-elastic (gelatinous, or semi-solid), but still fluid; there is no chemical change in the oil. The primary purpose is to increase skimmer efficiency removal rates while minimizing water recovery amounts. Increases the efficiency of some skimmers, but may clog other skimmers and pumps.
Applicable Habitat Types	On all water environments where oil can be contained for skimming. Not for use near wetlands nor debris because of increased adhesive properties of the treated oil.
When to Use	When skimmer efficiency is low. Must be used with booming or other physical containment. Not for use on heavy oils, which are already highly viscous.
Biological Constraints	Not suitable for vegetated shores or where there is extensive debris mixed in the oil. Should be avoided when birds or other wildlife cannot be kept away from the treated oil.
Environmental Effects	May increase the smothering effect of oil on organisms; therefore, the treatment should be considered only where recovery of the treated oil is likely.
Waste Generation	If skimming efficiency is increased, will reduce the volume of water in oil/water collections. Effects on recycling of oil treated with elasticity modifiers is unknown.

Herding Agents

Objective	To collect or herd oil into a smaller area and thicker slick in order to increase recovery. Can be used to herd oil away from sensitive areas or to help keep oil contained when it is necessary to move a boom.
Description	These agents, which are insoluble surfactants and have a high spreading pressure, are applied in small quantities (1-2 gallons per lineal mile) to the clean water surrounding the edge of a fresh oil slick. They contain the oil, prevent spreading, but do not hold the spill in place. Hand-held or vessel-mounted systems can be used. Must be applied early in spill, when oil is still fluid.
Applicable Habitat Types	On all still water environments.
When to Use	Potential use for collection and protection. For collection, used to push slicks out from under docks and piers where it has become trapped, or in harbors where the equipment is readily accessible for use early in the spill. For protection in low-current areas, use to push slicks away from sensitive resources such as wetlands. Not effective in fast currents, rough seas, or rainfall.
Biological Constraints	Not suitable for use in very shallow water or fish-spawning areas.
Environmental Effects	Direct acute toxicity to surface-layer organisms possible, though available products vary greatly in their aquatic toxicity.
Waste Generation	Same as for manual oil recovery.

Solidifiers

Objective To change the physical state of spilled oil from a liquid to a solid.

Description Chemical agents (polymers) are applied to oil at rates of 10-45 percent or more, solidifying the oil in minutes to hours. Various broadcast systems, such as leaf blowers, water cannons, or fire suppression systems, can be modified to apply the product over large areas. Can be applied to both floating and stranded oil. Can be placed in booms, pillows, sausages, etc. and used like sorbents, although this type of solidifier application has not been used operationally.

Applicable Habitat Types All water environments, bedrock, sediments, and artificial structures.

When to Use When immobilization of the oil is desired, to prevent refloating from a shoreline, penetration into the substrate, or further spreading. However, the oil may not fully solidify unless the product is well mixed with the oil, and may result in a mix of solid and untreated oil. Generally not used on heavy oil spills which are already viscous.

Biological Constraints Must be able to recover all treated material.

Environmental Effects Available products are insoluble and have very low aquatic toxicity. Unrecovered solidified oil may have longer impact because of slow weathering rates. Physical disturbance of habitat is likely during application and recovery.

Waste Generation If skimming efficiency is increased, solidifiers may reduce the volume of water collected during oil recovery. Effects on recycling oil treated with solidifiers is unknown. Most solidifier producers state that treated oil can pass leachate tests, allowing disposal in landfills.

**Shoreline Cleaning
Agents
(Surface Washing
Agents)**

Objective To increase the efficiency of oil removal from contaminated substrates.

Description Special formulations are applied to the substrate, as a presoak and/or flushing solution, to soften or lift weathered or heavy oils from the substrate to enhance flushing methods. The intent is to lower the water temperature and pressure required to mobilize the oil from the substrate during flushing. Some agents will disperse the oil as its washed off the beach, others will not.

Applicable Habitat Types On any habitat where water flooding and flushing procedures are applicable.

When to Use When the oil has weathered to the point where it cannot be removed using ambient water temperatures and low pressures. This approach may be most applicable where flushing effectiveness decreases as the oil weathers.

Biological Constraints When the product does not disperse the oil into the water column, the released oil must be recovered from the water surface. Use may be restricted where suspended sediment concentrations are high, near wetlands, and near sensitive nearshore resources.

Environmental Effects The toxicity and effects on dispersability of treated oil vary widely among products. Selection of a product should consider the toxicity of the product.

Waste Generation Because treated oil must be recovered, waste generation is a function of recovery method, which often includes sorbents.

Nutrient Enrichment (Biostimulation)

Objective To accelerate the rate of oil hydrocarbon degradation due to natural microbial processes using a form of bioremediation that adds nutrients (generally nitrogen and phosphorus) that stimulate microbial growth.

Description If nutrients are a limiting factor (as measured using the interstitial pore water) in an area where shoreline oiling has occurred, water-soluble nutrients can be applied by a spray irrigation system. Nutrients should be applied daily if the impacted area gets completely submerged by tides and waves and if maximum biostimulation is desired. If the impacted area gets submerged only during spring tides, the frequency of nutrient addition will be determined by the intertidal zone water coverage. Using slow-release granular or encapsulated nutrients or oleophilic fertilizer (which adheres to the oil residue on the surface) should require less frequent addition, but time-series monitoring of interstitial pore water nutrient levels is needed to ensure target levels are being maintained, especially throughout the depth of the impacted intertidal zone.

**Applicable Habitat
Types** Any shoreline habitat type where access is allowed and nutrients are deficient

When to Use On moderate- to heavily-oiled substrates, after other techniques have been used to remove free product on lightly-oiled shorelines, where other techniques are destructive or ineffective; and where nutrients limit natural attenuation. Most effective on light to medium crude oils and fuel oils (asphaltenes tend to inhibit rapid biodegradation). Less effective where oil residues are thick. Not considered for gasoline spills, which evaporate rapidly.

- Biological Constraints** Avoid using ammonia-based fertilizers at highly elevated concentrations because un-ionized ammonia is toxic to aquatic life. Nitrate is an equally good nitrogen source, minus the toxicity. Sodium tripolyphosphate is a better phosphorus source than orthophosphates because it is more soluble in seawater. If nutrients are applied properly with adequate monitoring, eutrophication should not be a problem. Only nutrient additives proven to be nontoxic and effective in either the laboratory or the field should be used in the environment. Contact toxicity of oleophilic nutrients may restrict their use as other chemicals in the product could be more toxic to aquatic organisms in the presence of oil.
- Environmental Effects** Detrimental effects to shoreline from foot or vehicle traffic caused by workers applying nutrients (unless nutrients are sprayed from a vessel or aircraft).
- Waste Generation** None.

Natural Microbe Seeding (Bioaugmentation)

Objective	To accelerate natural microbial degradation of oil by using a form of bioremediation that adds high numbers of oil-degrading microorganisms.
Description	<p>Formulations containing specific hydrocarbon-degrading microbes are added to the oiled area because indigenous hydrocarbon degraders are low in number, or, those that are present cannot degrade the oil effectively. Since microbes require nitrogen and phosphorus to convert hydrocarbons to biomass, formulations containing these oil degraders must also contain adequate nutrients.</p> <p>Research studies conducted with bioengineered organisms or organisms enriched from different environments, grown in the laboratory to high numbers, and applied to an oiled beach to stimulate rapid biodegradation, have failed to prove conclusively that seeding is effective.</p> <p>Bioaugmentation appears less effective than biostimulation because: 1) hydrocarbon degraders are ubiquitous in nature and, when an oil spill occurs at a given site, the influx of oil will cause an immediate increased response in the hydrocarbon degrading populations; but, 2) if nutrients are in limited supply, the rate of oil biodegradation will be less than optimal; thus, 3) supplying nutrients will enhance the process initiated by the spill, but adding microorganisms will not, because they still lack the necessary nitrogen and phosphorus to support growth.</p>
Applicable Habitat Types	There is insufficient information on impact or effectiveness of this method to make a judgment on applicable habitat.
When to Use	There is insufficient information on impact or effectiveness of this method to make a judgment on when to use it.

- Biological Constraints** Avoid using products containing ammonia-based fertilizers at elevated concentrations because un-ionized ammonia is toxic to aquatic life. Nitrate is an equally good a nitrogen source, minus the toxicity. If the product containing nutrients is applied properly with adequate monitoring, eutrophication should not be a problem; but, toxicity tests should be evaluated carefully, as other chemicals in the product could be toxic to aquatic organisms.
- Environmental Effects** Detrimental physical effects to shoreline from foot or vehicle traffic caused by workers applying bioaugmentation products (unless nutrients are sprayed from a vessel or aircraft).
- Waste Generation** None.

In-situ Burning

Objective To remove oil from the water surface or habitat by burning it in place.

Description Oil floating on the water surface is collected into slicks at least 2-3 mm thick and ignited. The oil can be contained in fire-resistant booms, or by natural barriers such as ice or the shore. On land, oil can be burned when it is on a combustible substrate such as vegetation, logs, and other debris. Oil can be burned from non-flammable substrates using a burn promoter. On sedimentary substrates, it may be necessary to dig trenches for oil to accumulate in pools to a thickness that will sustain burning. Heavy oils are hard to ignite but can sustain a burn. Emulsified oils may not ignite nor sustain a burn when the water content is greater than 30 to 50 percent.

Applicable Habitat Types On most habitats except dry muddy substrates where heat may impact the biological productivity of the habitat. May increase oil penetration into permeable substrates. Use in marshes should be undertaken using special precautions. Not suitable for woody vegetation such as mangroves and hardwood swamps.

When to Use On land, where there is heavy oil in sites neither amenable nor accessible to physical removal and it is important to remove the stranded oil quickly. In wetlands and mud habitats, a water layer will minimize impacts to sediments and roots. Many potential applications for spills in ice. There are many operational and public health limitations.

Biological Constraints The possible effect of smoke on wildlife and populated areas should be evaluated.

Environmental Effects Temperature and air quality effects are likely to be localized and short-lived. Toxicological impact from burn residues have not been evaluated. On-water, burn residues are likely to sink. On land, removal of residues is often necessary for crude and heavy oils. Limited data on burning oiled wetlands indicate recovery of wetland vegetation will depend on season of burn, type of vegetation, and water level in the marsh at time of burn.

Waste Generation Any residues remaining after burning will need to be collected and landfilled, but with an efficient burn will be a small fraction of the original oil volume.

Appendix C: Shoreline Descriptors, including Oil Behavior and Response Considerations

EXPOSED ROCKY CLIFFS

ESI = 1A

DESCRIPTION

- The intertidal zone is steep (greater than 30° slope), with very little width.
- Sediment accumulations are uncommon and usually ephemeral, because waves remove the debris that has slumped from the eroding cliffs.
- There is strong vertical zonation of intertidal biological communities.
- Species density and diversity vary greatly, but barnacles, snails, mussels, seastars, limpets, sea anemones, shore crabs, polychaetes, and macroalgae are often very abundant.

PREDICTED OIL BEHAVIOR

- Oil is held offshore by wave reflecting off the steep cliffs.
- Any oil that is deposited is rapidly removed from exposed faces.
- The most resistant oil would remain as a patchy band at or above the high-tide line.
- Impacts to intertidal communities are expected to be short-term in duration. An exception would be where heavy concentrations of a light refined product came ashore very quickly.

RESPONSE CONSIDERATIONS

- Cleanup is usually not required.
- Access can be difficult and dangerous.

EXPOSED, SOLID MAN-MADE STRUCTURES

ESI = 1B

DESCRIPTION

- This shoreline type consist of solid man-made structures such as seawalls, groins, revetments, piers, and port facilities.
- They are constructed of concrete, wood, or metal.
- Often there is no exposed substrate at low tide, but a wide range of habitats may be present .
- They are built to protect the shore from erosion by waves, boat wakes, and currents, and thus are exposed to rapid natural removal processes.
- Attached animals and plants are sparse to moderate.

PREDICTED OIL BEHAVIOR

- Oil is held offshore by waves reflecting off the steep, hard surface in exposed settings.
- Oil readily adheres to the dry, rough surfaces, but it does not adhere to wet substrates.
- The most resistant oil would remain as a patchy band at or above the high-tide line.

RESPONSE CONSIDERATIONS

- Cleanup is usually not required.
- High-pressure water spraying may be conducted to: remove persistent oil in crevices; improve aesthetics; or reduce leaching of oil.

EXPOSED WAVE-CUT PLATFORMS

ESI = 2

DESCRIPTION

- The intertidal zone consists of a flat rock bench of highly variable width.
- The shoreline may be backed by a steep scarp or low bluff.
- There may be a beach of sand- to boulder-sized sediments at the base of the scarp.
- The platform surface is irregular and tidal pools are common.
- Small amounts of gravel can be found in the tidal pools and crevices in the platform.
- These habitats can support large populations of encrusting animals and plants, with rich tidal pool communities.

PREDICTED OIL BEHAVIOR

- Oil will not adhere to the rock platform, but rather be transported across the platform and accumulate along the high-tide line.
- Oil can penetrate in beach sediments, if present.
- Persistence of oiled sediments is usually short-term, except in wave shadows or where the oil has penetrated sediments at the high-tide line.

RESPONSE CONSIDERATIONS

- Cleanup is usually not required.
- Where the high-tide area is accessible, it may be feasible to remove heavy oil accumulations and oiled debris.

FINE-GRAINED SAND BEACHES

ESI = 3A

DESCRIPTION

- These beaches are generally flat and hard-packed.
- Though they are predominately fine sand, there is often a small amount of shell hash.
- There can be heavy accumulations of wrack present.
- They are utilized by birds and turtles for nesting and feeding.
- Upper beach fauna are generally sparse, although amphipods can be abundant; lower beach fauna can be moderately abundant, but highly variable.

PREDICTED OIL BEHAVIOR

- Light oil accumulations will be deposited as oily bands along the upper intertidal zone.
- Heavy oil accumulations will cover the entire beach surface; oil will be lifted off the lower beach with the rising tide.
- Maximum penetration of oil into fine-grained sand is about 10 cm.
- Burial of oiled layers by clean sand within the first week after a spill typically will be less than 30 cm along the upper beach face.
- Organisms living in the beach sediment may be killed by smothering or lethal oil concentrations in the interstitial water.
- There may be declines in infauna, which can affect important shorebird foraging areas.

RESPONSE CONSIDERATIONS

- These beaches are among the easiest shoreline types to clean.
- Cleanup should concentrate on removing oil and oily debris from the upper swash zone once oil has come ashore.
- Activity through oiled and dune areas should be limited, to prevent oiling of clean areas.
- Manual cleanup, rather than road graders and front-end loaders, is usually advised to minimize the volume of sand removed from the shore and requiring disposal.

- All efforts should focus on preventing the mixture of oil deeper into the sediments by vehicular and foot traffic.
- Mechanical reworking of lightly oiled sediments from the high-tide line to the upper intertidal zone can be effective along outer beaches.

SCARPS AND STEEP SLOPES IN SAND

ESI = 3B

DESCRIPTION

- This shoreline type occurs where sandy bluffs are undercut by waves or currents and slump.
- They normally form along embankments of sandy dredge material and at cutbanks in rivers; they also form where tidal creeks intercept old sandy beach ridge deposits.
- Some scarps are fronted by narrow beaches, if the erosion rates are moderate and episodic.
- Trees growing at the top of these slopes are eventually undercut and the debris can accumulate at the base of the scarp.
- Biological utilization by birds and infauna is low.

PREDICTED OIL BEHAVIOR

- Any stranded oil will concentrate at the high-water line and may penetrate sandy sediments.
- Oil will adhere to the dry surfaces of any woody debris accumulated at the base of the scarp.
- There is little potential for burial except when a major slumping of the bluff occurs.
- Active erosion of the scarp will remove the oil.

RESPONSE CONSIDERATIONS

- In most cases, cleanup is not necessary because of the short residence time of the oil
- The need for removal of oiled sediments and debris should be carefully evaluated because of the potential for increased erosion.
- Closely supervised manual labor should be used so that the minimal amount of material is removed during cleanup.

MEDIUM- TO COARSE-GRAINED SAND BEACHES

ESI = 4

DESCRIPTION

- These beaches have relatively steep beach faces and soft substrates.
- Coarse-sand beaches can undergo rapid erosion/deposition cycles, even within one tidal cycle.
- The amount of wrack varies considerably.
- They are utilized by birds and turtles for nesting and feeding.

PREDICTED OIL BEHAVIOR

- Light oil accumulations will be deposited as oily bands along the upper intertidal zone.
- Heavy oil accumulations will cover the entire beach surface; oil will be lifted off the lower beach with the rising tide.
- Maximum oil penetration is about 20 cm.
- Burial of oiled layers by clean sand within the first week after a spill can be up to 50 cm.
- Organisms living in the beach sediments may be killed by smothering or lethal oil concentrations in the interstitial water.
- There may be declines in infauna, which can affect important shorebird foraging areas.

RESPONSE CONSIDERATIONS

- Coarse sand sediments are less traffikable, increasing the risk of mixing oil into the substrate by foot and vehicular traffic.
- Cleanup should concentrate on removing oil and oily debris from the upper swash zone once oil has come ashore.
- Traffic through oiled and dune areas should be limited, to prevent oiling of clean areas.

- Manual cleanup, rather than road graders and front-end loaders, is advised to minimize the volume of sand removed from the shore and requiring disposal.
- All efforts should focus on preventing the mixture of oil deeper into the sediments by vehicular and foot traffic.
- Mechanical reworking of lightly oiled sediments from the high-tide zone to the upper intertidal zone can be effective along outer beaches.

MIXED SAND AND GRAVEL BEACHES

ESI = 5

DESCRIPTION

- These beaches are moderately sloping and composed of a mixture of sand and gravel.
- Because of the mixed sediment sizes, there may be zones of pure sand, pebbles, or cobbles.
- There can be large-scale changes in the sediment distribution patterns depending upon season, because of the transport of the sand fraction offshore during storms.
- Because of sediment desiccation and mobility on exposed beaches, there are low densities of attached animals and plants.
- The presence of attached algae and animals indicates beaches that are relatively sheltered, with the more stable substrate supporting a richer biota.

PREDICTED OIL BEHAVIOR

- During small spills, oil will be deposited along and above the high-tide swash.
- Large spills will spread across the entire intertidal area.
- Oil penetration into the beach sediments may be up to 50 cm; however, the sand fraction can be quite mobile, and oil behavior is much like on a sand beach if the sand exceeds 40 percent.
- Burial of oil may be deep at and above the high-tide line, where oil tends to persist, particularly where beaches are only intermittently exposed to waves.
- In sheltered pockets on the beach, pavements of asphalted sediments can form if there is no removal of heavy oil accumulations, because most of the oil remains on the surface.
- Once formed, these asphalt pavements can persist for many years.
- Oil can be stranded in the coarse sediments on the lower part of the beach, particularly if the oil is weathered or emulsified.

RESPONSE CONSIDERATIONS

- Remove heavy accumulations of pooled oil from the upper beachface.
- All oiled debris should be removed.
- Sediment removal should be limited as much as possible.
- Low-pressure flushing can be used to float oil away from the sediments for recovery by skimmers or sorbents. High-pressure spraying should be avoided because of potential for transporting contaminated finer sediments (sand) to the lower intertidal or subtidal zones.
- Relocation of oiled sediments from the high-tide zone to the upper intertidal zone can be effective in areas regularly exposed to wave activity (as evidenced by storm berms). However, oiled sediments should not be relocated below the mid-tide zone.
- Tilling may be used to reach deeply buried oil layers in the middle zone on exposed beaches.

GRAVEL BEACHES

ESI = 6A

DESCRIPTION

- Gravel beaches are composed of sediments ranging in size from pebbles to boulders. The gravel-sized sediments can be made up of shell fragments.
- They can be very steep, with multiple wave-built berms forming the upper beach.
- Attached animals and plants are usually restricted to the lowest parts of the beach, where the sediments are less mobile.

- The presence of attached algae, mussels, and barnacles indicates beaches that are relatively sheltered, with the more stable substrate supporting a richer biota.

PREDICTED OIL BEHAVIOR

- Deep penetration and rapid burial of stranded oil is likely on exposed beaches.
- On exposed beaches, oil can be pushed over the high-tide and storm berms, pooling and persisting above the normal zone of wave wash.
- Long-term persistence will be controlled by the depth of penetration versus the depth of routine reworking by storm waves.
- On the more sheltered portions of beaches, formation of asphalt pavements is likely where accumulations are heavy.

RESPONSE CONSIDERATIONS

- Heavy accumulations of pooled oil should be removed quickly from the upper beach.
- All oiled debris should be removed.
- Sediment removal should be limited as much as possible.
- Low- to high-pressure flushing can be used to float oil away from the sediments for recovery by skimmers or sorbents.
- Relocation of oiled sediments from the high-tide zone to the upper intertidal zone can be effective in areas regularly exposed to wave activity (as evidenced by storm berms). However, oiled sediments should not be relocated below the mid-tide zone.
- Tilling may be used to reach deeply buried oil layers in the upper to-mid-tide zone on exposed beaches.

RIPRAP

ESI = 6B

DESCRIPTION

- Riprap is composed of cobble- to boulder-sized blocks of granite, limestone, or concrete.
- Riprap structures are used for shoreline protection and channel stabilization (jetties)
- Attached biota are sparse.

PREDICTED OIL BEHAVIOR

- Oil adheres readily to the rough surfaces of the blocks.
- Deep penetration of oil between the blocks is likely.
- Uncleaned oil can cause chronic leaching until the oil solidifies.

RESPONSE CONSIDERATIONS

- When the oil is fresh and liquid, high pressure flushing and/or water flooding may be effective, making sure to recover all liberated oil.
- Heavy and weathered oils are more difficult to remove, requiring scrapping and/or hot-water flushing.
- In extreme cases, it may be necessary to remove heavily oiled blocks and replace them.

EXPOSED TIDAL FLATS

ESI = 7

DESCRIPTION

- Exposed tidal flats are broad intertidal areas composed primarily of sand and minor amounts of shell and mud.
- The dominance of sand indicates that currents and waves are strong enough to mobilize the sediments.
- They are usually associated with another shoreline type on the landward side of the flat, though they can occur as separate shoals; they are commonly associated with tidal inlets.

- Biological utilization can be very high, with large numbers of infauna, heavy use by birds for roosting and foraging, and use by foraging fish.

PREDICTED OIL BEHAVIOR

- Oil does not usually adhere to the surface of exposed tidal flats, but rather moves across the flat and accumulates at the high-tide line.
- Deposition of oil on the flat may occur on a falling tide if concentrations are heavy.
- Oil does not penetrate water-saturated sediments.
- Biological damage may be severe, primarily to infauna, thereby reducing food sources for birds and other predators.

RESPONSE CONSIDERATIONS

- Currents and waves can be very effective in natural removal of the oil.
- Cleanup is very difficult (and possible only during low tides).
- The use of heavy machinery should be restricted to prevent mixing of oil into the sediments.

SHELTERED ROCKY SHORES

ESI = 8A

DESCRIPTION

- These are bedrock shores of variable slope (from vertical cliffs to wide, rocky ledges) that are sheltered from exposure to most wave and tidal energy.
- Wide shores may have some surface sediments, but bedrock is the dominant substrate type
- Species density and diversity vary greatly, but biota are often very abundant.

PREDICTED OIL BEHAVIOR

- Oil will adhere readily to the rough rocky surface, particularly along the high-tide line, forming a distinct oil band.
- Even on wide ledges, the lower intertidal zone usually stays wet (particularly when algae covered), preventing oil from adhering to the rock surface.
- Heavy and weathered oils can cover the upper zone with little impacts to the rich biological communities of the lower zone.
- Where surface sediments are abundant, oil will penetrate into the crevices formed by the surface rubble, forming persistent pavements.
- Where the rubble is loosely packed, oil will penetrate deeply, causing long-term contamination of the subsurface sediments.

RESPONSE CONSIDERATIONS

- Low-pressure flushing at ambient temperatures is most effective when the oil is fresh.
- Extreme care must be taken not to spray in the biologically rich lower intertidal zone or when the tidal level reaches that zone.
- Cutting of oiled, attached algae is not recommended; tidal action will eventually float this oil off, so sorbent booms should be deployed.

SHELTERED, SOLID MAN-MADE STRUCTURES

ESI = 8B

DESCRIPTION

- These structures are solid man-made structures such as seawalls, groins, revetments, piers, and port facilities.
- Most structures are constructed of concrete, wood, or metal, and their composition, design, and condition are highly variable.
- Often there is no exposed beach at low tide, but a wide variety habitats may be present.
- Attached animal and plant life can be moderate to high.

PREDICTED OIL BEHAVIOR

- Oil will adhere readily to the rough surface, particularly along the high-tide line, forming a distinct oil band.
- The lower intertidal zone usually stays wet (particularly if algae covered), preventing oil from adhering to the surface.

RESPONSE CONSIDERATIONS

- Cleanup of seawalls is usually conducted for aesthetic reasons or to prevent leaching of oil.
- Low- to high-pressure flushing at ambient water temperatures is most effective when the oil is fresh. Hot water is needed for heavy or weathered oils.

SHELTERED TIDAL FLATS

ESI = 9A

DESCRIPTION

- Sheltered tidal flats are composed primarily of mud with minor amounts of sand and shell.
- They are present in calm-water habitats, sheltered from major wave activity, and are frequently backed by marshes.
- The sediments are very soft and cannot support even light foot traffic in many areas.
- They can be sparsely to heavily covered with algae and/or seagrasses.
- They can have very heavy wrack accumulations along the high-tide line.
- There can be large concentrations of shellfish, worms, and snails on and in the sediments.
- They are heavily utilized by birds and fish for feeding.

PREDICTED OIL BEHAVIOR

- Oil does not usually adhere to the surface of sheltered tidal flats, but rather moves across the flat and accumulates at the high-tide line.
- Deposition of oil on the flat may occur on a falling tide if concentrations are heavy.
- Oil will not penetrate the water-saturated sediments, but could penetrate burrows and root cavities.
- Biological damage may be severe.

RESPONSE CONSIDERATIONS

- These are high-priority areas for protection since cleanup options are very limited.
- Cleanup is very difficult because of the soft substrate; many methods may be restricted.
- Deluge flooding and deployment of sorbents from shallow-draft boats may be helpful.

VEGETATED LOW RIVERINE BANKS

ESI = 9B

DESCRIPTION

- This shoreline type consists of either low banks with grasses or low eroding banks with trees and tree roots exposed to the water.
- The banks are flooded occasionally by high water.
- These shorelines are generally found in fresh or brackish water localities.

PREDICTED OIL BEHAVIOR

- During low water stages there could be little impact, with the oil coating a narrow band of sediment at the water level.
- During high water, the oil will cover and coat the grasses and base of the trees.
- May cause loss of the grasses, but the trees should survive unless oil penetrates and persists in

RESPONSE CONSIDERATIONS

- Low-pressure flushing of oiled areas is effective in removing moderate to heavy accumulations of oil from along the banks.
- Sorbent and containment boom should be placed on the water side of the cleanup operations to contain and collect oil outflow.
- Low- to high-pressure flushing can be used to remove oil from tree roots and trunks, if deemed necessary in high-use areas.

SALT- AND BRACKISH-WATER MARSHES

ESI = 10A

DESCRIPTION

- These marshes contain vegetation which tolerates water salinity down to about 5 ppt.
- Width of the marsh can vary widely, from a narrow fringe to extensive areas.
- Sediments are composed of organic-rich muds except on the margins of barrier islands where sand is abundant.
- Exposed areas are located along waterbodies with wide fetches and along busy waterways.
- Sheltered areas are not exposed to significant wave or boat wake activity.
- Resident flora and fauna are abundant with numerous species with high utilization by birds, fish, and shellfish.

PREDICTED OIL BEHAVIOR

- Oil adheres readily to intertidal vegetation.
- The band of coating will vary widely, depending upon the water level at the time oil slicks are in the vegetation. There may be multiple bands.
- Large slicks will persist through multiple tidal cycles and coat the entire stem from the high-tide line to the base.
- If the vegetation is thick, heavy oil coating will be restricted to the outer fringe, although lighter oils can penetrate deeper, to the limit of tidal influence.
- Medium to heavy oils do not readily adhere to or penetrate the fine sediments, but can pool on the surface or in burrows and root cavities.
- Light oils can penetrate the top few centimeters of sediment and deeply into burrows and mud cracks (up to one meter).

RESPONSE CONSIDERATIONS

- Under light oiling, the best practice is to let the area recover naturally.
- Natural removal processes and rates should be evaluated prior to conducting cleanup.
- Heavy accumulations of pooled oil can be removed by vacuum, sorbents, or low-pressure flushing. During flushing, care must be taken to prevent transporting oil to sensitive areas down slope or along shore.
- Cleanup activities should be carefully supervised to avoid vegetation damage.
- Any cleanup activity must not mix the oil deeper into the sediments. Trampling of the roots must be minimized.
- Cutting of oiled vegetation should only be considered when other resources present are at great risk from leaving the oiled vegetation in place.

Appendix D

*Copies of Shoreline Assessment Forms,
Form Explanations or Codes, Sketch Map Form, and Field
Estimators*

SHORELINE ASSESSMENT FORM for _____ **Spill** Page ___ of ___

1. GENERAL INFORMATION				Date (dd/mm/yy)		Time (24h standard/daylight)				Tide Height										
Segment ID:										L/M/H										
Segment Name:						hrs to				hrs										
Survey By: Foot / Boat / Helicopter / Overlook / _____						Sun / Clouds / Fog / Rain / Snow / Windy														
2. SURVEY TEAM No. ____		Name		Organization				Phone Number												
3. SEGMENT		Total Length ____m/yd		Length Surveyed ____m/yd		Differential GPS		Yes/No												
Start GPS: LAT		____ deg.		____ min		LONG		____ deg.		____ min										
End GPS: LAT		____ deg.		____ min		LONG		____ deg.		____ min										
4. SHORELINE TYPE		Select only ONE Primary (P) and ANY Secondary (S) types present																		
		Rocky Cliffs								Riprap										
		Exposed Man-made Structures								Exposed Tidal Flats										
		Wave-cut Platforms								Sheltered Rocky Shores										
		Fine-Medium grained Sand Beaches								Sheltered Man-made Structures										
		Coarse-grained Sand Beaches								Sheltered Tidal Flats										
		Mixed Sand and Gravel Beaches								Wetlands										
		Gravel Beaches								Other _____										
5. OPERATIONAL FEATURES		Oiled Debris? Yes / No		Type _____		Amount _____		bags												
		Direct backshore access? Yes / No		Access restrictions _____																
		Alongshore access from next segment? Yes / No		Suitable backshore staging? Yes / No																
6. SURFACE OILING CONDITIONS		Begin with "A" in the lowest tidal zone																		
Zone ID	Tidal Zone				Oil Cover			Oil Thickness					Oil Character							
	LI	MI	UI	SU	Length m/ft	Width m/ft	Distr. %	PO	CV	CT	ST	FL	FR	MS	TB	TC	SR	AP	No	
7. SUBSURFACE OILING CONDITIONS		Use letter of Zone location plus Number of trench, e.g., "A1"																		
Trench No.	Tidal Zone				Trench Depth cm / in	Oiled Interval cm-cm/in-in	Subsurface Oil Character					Water Table cm / in	Sheen Color B,R,S,N	Clean Below? Yes/No						
	LI	MI	UI	SU			OP	PP	OR	OF	TR				No					
8. COMMENTS		Cleanup Recommendations; Ecological/Recreational/Cultural Issues/Wildlife Obs.																		
Sketch: Yes / No Photos: Yes / No (Roll# _____ Frames _____) Video Tape: Yes / No (Tape# _____)																				

Calibration IS VERY IMPORTANT! Do a calibration exercise to make sure that all teams are consistently using the same terminology and estimations.

Units: Use either metric (m, cm) or English (yd, ft, in). Circle the units used.

Tide Height: Circle the two letters indicating the progression of the tidal stage during the survey.

Segment/Survey Length: Always record both lengths on the first survey, especially where the SCAT team creates the segments in the field. On repeat surveys, always enter in the Survey Length, especially if only part of the segment is surveyed.

Start/End GPS: Use of decimal degrees is preferred, but be consistent among teams.

SURFACE OILING CONDITIONS

Zone ID: Use a different ID for each different oil occurrence, e.g., two distinct bands of oil at mid-tide and high-tide levels, or alongshore where the oil distribution changes from 10 % to 50%. Describe each different occurrence on a separate line.

Tidal Zone: Use the codes to indicate the location of the oil being described, as in the lower (LI), mid (MI), or upper (UI) intertidal zone, or in the supra (SU) tidal zone (above the normal high tide level).

Distribution: Enter the estimated percent of oil on the surface, or codes for the following intervals:

C	Continuous	91-100% cover
B	Broken	51-90%
P	Patchy	11-50%
S	Sporadic	<1-10%
T	Trace	<1%

Surface Oiling Descriptors - Thickness: Use the following codes:

PO	Pooled Oil (fresh oil or mousse > 1 cm thick)
CV	Cover (oil or mousse from >0.1 cm to <1 cm on any surface)
CT	Coat (visible oil <0.1 cm, which can be scraped off with fingernail)
ST	Stain (visible oil, which cannot be scraped off with fingernail)
FL	Film (transparent or iridescent sheen or oily film)

Surface Oiling Descriptors - Type

FR	Fresh Oil (unweathered, liquid oil)
MS	Mousse (emulsified oil occurring over broad areas)
TB	Tarballs (discrete accumulations of oil <10 cm in diameter)
TC	Tar (highly weathered oil, of tarry, nearly solid consistency)
SR	Surface Oil Residue (non-cohesive, oiled surface sediments)
AP	Asphalt Pavements (cohesive, heavily oiled surface sediments)
No	No oil (no evidence of any type of oil)

SUBSURFACE OILING CONDITIONS

Oiled Interval: Measure the depths from the sediment surface to top/bottom of subsurface oiled layer. Enter multiple oil layers on separate lines.

Subsurface Oiling Descriptors: Use the following codes:

OP	Oil-Filled Pores (pore spaces are completely filled with oil)
PP	Partially Filled Pores (the oil does not flow out of the sediments when disturbed)
OR	Oil Residue (sediments are visibly oiled with black/brown coat or cover on the clasts, but little or no accumulation of oil within the pore spaces)
OF	Oil Film (sediments are lightly oiled with an oil film, or stain on the clasts)
TR	Trace (discontinuous film or spots of oil, or an odor or tackiness)

Sheen Color: Describe sheen on the water table as brown (B), rainbow (R), silver (S), or none (N).

SHORT SHORELINE ASSESSMENT FORM for _____ Spill Page __ of __

1. GENERAL INFORMATION		Date (dd/mm/yy)	Time (24h standard/daylight)	Tide Height
Segment ID:				L/M/H
Segment Name:			hrs to hrs	H/M/L
Survey By: Foot / Boat / Helicopter / Overlook / _____			Sun / Clouds / Fog / Rain / Snow / Windy	

2. SURVEY TEAM No. ____	Name	Organization	Phone Number

3. SEGMENT	Total Length ____m/yd	Length Surveyed ____m/yd	Differential GPS	Yes/No
Start GPS:	LAT _____ deg. _____ min	LONG _____ deg. _____ min		
End GPS:	LAT _____ deg. _____ min	LONG _____ deg. _____ min		

4. SHORELINE TYPE	Select only ONE Primary (P) and ANY Secondary (S) types present		
	Rocky Cliffs		Riprap
	Exposed Man-made Structures		Exposed Tidal Flats
	Wave-cut Platforms		Sheltered Rocky Shores
	Fine-Medium grained Sand Beaches		Sheltered Man-made Structures
	Coarse-grained Sand Beaches		Sheltered Tidal Flats
	Mixed Sand and Gravel Beaches		Wetlands
	Gravel Beaches		Other _____

5. OPERATIONAL FEATURES	Oiled Debris? Yes / No	Type _____	Amount _____ bags
Direct backshore access? Yes / No Access restrictions _____			
Alongshore access from next segment? Yes / No Suitable backshore staging? Yes / No			

Zone ID _____ Description of oil in: Supra / Upper / Mid / Lower Tidal Zone (circle oil location)

Oil Band Dimensions	Surface Oil Distribution	Surface Oil Thickness	Surface Oil Type	Subsurface Oil	
				Penetration	Burial
Width: _____ m/ft	<1%	Film	Fresh Oil	<1 cm / in	Clean Layer
	1-10%	Stain	Mousse/Tar	1-5 cm / in	_____ cm / in
Length: _____ m/ft	11-50%	Coat	Tarballs/Patties	5-10 cm / in	Oiled Layer
	51-90%	Cover	Surface Oil Residue	>10 cm / in	
	91-100%	Pooled	Asphalt Pavement	_____ cm / in	
	_____ %	_____ cm / in	Other _____		

Zone ID _____ Description of oil in: Supra / Upper / Mid / Lower Tidal Zone (circle oil location)

Oil Band Dimensions	Surface Oil Distribution	Surface Oil Thickness	Surface Oil Type	Subsurface Oil	
				Penetration	Burial
Width: _____ m/ft	<1%	Film	Fresh Oil	<1 cm / in	Clean Layer
	1-10%	Stain	Mousse/Tar	1-5 cm / in	_____ cm / in
Length: _____ m/ft	11-50%	Coat	Tarballs/Patties	5-10 cm / in	Oiled Layer
	51-90%	Cover	Surface Oil Residue	>10 cm / in	
	91-100%	Pooled	Asphalt Pavement	_____ cm / in	
	_____ %	_____ cm / in	Other _____		

8. COMMENTS	Cleanup Recommendations; Ecological/Recreational/Cultural Issues; Wildlife Obs.
Sketch: Yes / No Photos: Yes / No (Roll# _____ Frames _____) Video Tape: Yes / No (Tape# _____)	

Calibration IS VERY IMPORTANT! Do a calibration exercise to make sure that all teams are consistently using the same terminology and estimations.

Units: Use either metric (m, cm) or English (yd, ft, in). Circle the units used.

Tide Height: Circle the two letters indicating the progression of the tidal stage during the survey.

Segment/Survey Length: Always record both lengths on the first survey, especially where the SCAT team creates the segments in the field. On repeat surveys, always enter in the Survey Length, especially if only part of the segment is surveyed.

Start/End GPS: Use of decimal degrees is preferred, but be consistent among teams.

Shoreline Type: Use a "P" to indicate the primary shoreline type for the entire segment or sub-segment being surveyed. Use an "S" to indicate the presence of other, secondary shoreline types. Provide more explanation in the Comments section, where necessary.

Zone ID: Use a different Zone ID for each different oil occurrence, e.g., two distinct bands of oil at mid-tide and high-tide levels, or alongshore where the oil distribution changes from 10% to 50%. Describe each different occurrence in a separate block. Use as many blocks (and sheets) as needed for each segment.

Tidal Zone: Circle the location of the oil being described in the block, as being in the lower, mid, or upper intertidal zone, or in the supra-tidal zone (above the normal high tide level).

Surface Oil Distribution: Enter the estimated percent of oil on the surface, or circle the intervals.

Surface Oiling Thickness: Use the following terms:

- Film (transparent or iridescent sheen or oily film)
- Stain (visible oil, which cannot be scraped off with fingernail)
- Coat (visible oil <0.1 cm, which can be scraped off with fingernail)
- Cover (oil or mousse from >0.1 cm to <1 cm on any surface)
- Pooled Oil (fresh oil or mousse > 1 cm thick)

Surface Oiling Type: Use the following terms:

- Fresh Oil (unweathered, liquid oil)
- Mousse (emulsified oil occurring over broad areas)
- Tar (highly weathered oil, of tarry, nearly solid consistency)
- Tarballs (discrete accumulations of oil <10 cm in diameter)
- Patties (discrete accumulations of oil >10 cm in diameter)
- Surface Oil Residue (non-cohesive, oiled surface sediments)
- Asphalt Pavements (cohesive, heavily oiled surface sediments)
- No Oil (no evidence of any type of oil)

Subsurface Oil Penetration: Circle the average depth of oil penetration from the surface, in either cm or inches, as measured in trenches dug into the sediment throughout the zone being described.

Subsurface Oil Burial: Use this column when there is a clean layer of sediment overlying an oiled layer.

Subsurface Oiling Descriptors: In the Comments Section, use the following terminology to describe the degree of oiling of subsurface sediments:

- Oil-Filled Pores (pore spaces are completely filled with oil)
- Partially Filled Pores (the oil does not flow out of the sediments when disturbed)
- Oil Residue (sediments are visibly oiled with black/brown coat or cover on the clasts, but little or no accumulation of oil within the pore spaces)
- Oil Film (sediments are lightly oiled with an oil film, or stain on the clasts)
- Trace (discontinuous film or spots of oil, or an odor or tackiness)

TARBALL SHORELINE ASSESSMENT FORM for _____ Spill Page __ of __

1. GENERAL INFORMATION		Date (dd/mm/yy)	Time (24h standard/daylight)	Tide Height
Segment ID:			hrs to hrs	L/M/H
Segment Name:				H/M/L
Survey By: Foot / Boat / Helicopter / Overlook / _____			Sun / Clouds / Fog / Rain / Snow / Windy	
2. SURVEY TEAM No. ____	Name	Organization	Phone Number	
3. SEGMENT	Description of Shoreline Surveyed:			
Total Length: _____ m/yd Length Surveyed: _____ m/yd Differential GPS? Yes / No				
Start GPS: LAT _____ deg. _____ min LONG _____ deg. _____ min				
End GPS: LAT _____ deg. _____ min LONG _____ deg. _____ min				
4. SHORELINE TYPE	Select only ONE Primary (P) and ANY Secondary (S) types present			
	Rocky Cliffs		Riprap	
	Exposed Man-made Structures		Exposed Tidal Flats	
	Wave-cut Platforms		Sheltered Rocky Shores	
	Fine-Medium grained Sand Beaches		Sheltered Man-made Structures	
	Coarse-grained Sand Beaches		Sheltered Tidal Flats	
	Mixed Sand and Gravel Beaches		Wetlands	
	Gravel Beaches		Other _____	
5. TAR BALL DESCRIPTION	AREA 1	AREA 2	AREA 3	
Tar Balls Observed?	Yes / No	Yes / No	Yes/No	
Oiled Debris Observed? (Describe below)	Yes / No	Yes / No	Yes/No	
Tidal Zone Where the area of tarballs is located	LI / MI / UI / SU	LI / MI / UI / SU	LI / MI / UI / SU	
Length Approximate alongshore length of shore in which tarballs/oiled debris are observed	m/yd	m/yd	m/yd	
Width Across-shore width of the band on the shore in which tarballs/oiled debris are observed	m/yd	m/yd	m/yd	
Average Number of Tar Balls within Area (e.g., 2/yd ² within band; 3 per 100 yds along-shore; 6 total within area, etc.) Be specific.				
Average Size of Tar Balls	cm/in	cm/in	cm/in	
Size of Largest Tar Ball	cm/in	cm/in	cm/in	
Type of Tar Balls	Weathered/Fresh Sticky? Yes/No	Weathered/Fresh Sticky? Yes/No	Weathered/Fresh Sticky? Yes/No	
Tar Balls Collected?	Yes / No	Yes / No	Yes / No	
6. COMMENTS	Cleanup Recommendations; Ecological/Recreational/Cultural Issues; Wildlife Obs.			
Sketch: Yes / No Photos: Yes / No (Roll# _____ Frames _____) Video Tape: Yes / No (Tape# _____)				

Calibration IS VERY IMPORTANT! Do a calibration exercise to make sure that all teams are consistently using the same terminology and estimations.

Tide Height: Circle the two letters indicating the progression of the tidal stage during the survey.

Description of Shoreline Surveyed: Fill in this field when only part of a segment is surveyed. Be as specific as possible (e.g., from Berry Creek to 1 mile north).

Total/Surveyed Length: Always record both lengths on the first survey, especially where the SCAT team creates the segments in the field. On repeat surveys, always enter in the Length Surveyed, especially if only part of the segment is surveyed.

Start/End GPS: Use of decimal degrees is preferred, but be consistent among teams.

Shoreline Type: Use a "P" to indicate the primary shoreline type for the entire segment or sub-segment being surveyed. Use an "S" to indicate the presence of other, secondary shoreline types. Provide more explanation in the Comments section, where necessary.

TAR BALL DESCRIPTION

This section is divided into "Areas". Use a different Area to describe changes in: presence/absence, size, or concentration of tar balls.

Tar Balls Observed? It is important to indicate if no tar balls are observed.

Oiled Debris Observed? If yes, describe type, location, and degree oiling for oiled debris under Comments. Use the following descriptors for type:

wrack	unattached vegetation that can be important feeding areas for shorebirds
logs	large pieces of wood that can not be readily removed by hand
trash	man-made materials (e.g., plastic, glass, paper) that can be removed by hand
sorbents	sorbent pads, rolls, boom, etc. used during the spill response
peat	degraded organic material that has been eroded; includes coffee grounds

Tidal Zone: Check off the location of the area of tarballs being described, as in the lower (LI), mid (MI), upper (UI), or supra (SU) tidal zone.

Length and Width: Enter the dimensions where tar balls of uniform average size and density are observed. If no tar balls are observed, enter the dimensions of the area surveyed. Also, indicate the location of the tar balls as being in the lower (LITZ), mid (MITZ), or upper (UITZ) intertidal zone, or in the supra-tidal (SUPRA) zone (above the normal high tide level).

Average Number of Tar Balls within Area: Enter the estimate of the number of tar balls in the surveyed area. Options include:

- Total number - use where so few tar balls are present that they can be readily counted
- Concentration - enter as an average, range, or max per unit area (e.g., 1-2/yd², 3-5 max)

Average Size of Tar Balls: Visually estimate the most common or frequent size of tar balls in the surveyed area. Enter a range if tar ball sizes are not uniform. Indicate units by circling.

Tar Balls Collected? Provide details in the Comments Section. Indicate of all or only part of the observed tar balls were collected. Indicate units by circling.

Calibration IS VERY IMPORTANT! Do a calibration exercise to make sure that all teams are consistently using the same terminology and estimations.

Units: Use either metric (m, cm) or English (yd, ft, in). Circle the units used.

Tide Height: Circle the two letters indicating the progression of the tidal stage during the survey.

Segment/Survey Length: Always record both lengths on the first survey, esp. where the SCAT team creates the segments in the field. On repeat surveys, always enter in the Survey Length, esp. if only part of the segment is surveyed. Make a sketch when dealing with irregular wetland shapes.

Start/End GPS: Use of decimal degrees is preferred, but be consistent among teams.

SURFACE OILING CONDITIONS

Zone ID: Use a different ID for each different oil occurrence and differentiate between oil on the substrate (S) and vegetation (V). Describe each different occurrence on a separate line.

Tidal Zone: Use the codes to indicate the location of the oil being described, as in the lower (LI), mid (MI), or upper (UI) intertidal zone, or in the supra (SU) tidal zone (above the normal high tide level).

Distribution: Enter the estimated percent of oil on the surface, or codes for the following intervals:

C	Continuous	91-100% cover
B	Broken	51-90%
P	Patchy	11-50%
S	Sporadic	<1-10%
T	Trace	<1%

Surface Oiling Descriptors - Thickness: Use the following codes:

PO	Pooled Oil (fresh oil or mousse > 1 cm thick)
CV	Cover (oil or mousse from >0.1 cm to <1 cm on any surface)
CT	Coat (visible oil <0.1 cm, which can be scrapped off with fingernail)
ST	Stain (visible oil, which cannot be scrapped off with fingernail)
FL	Film (transparent or iridescent sheen or oily film)

Surface Oiling Descriptors - Type

FR	Fresh Oil (unweathered, liquid oil)
MS	Mousse (emulsified oil occurring over broad areas)
TB	Tarballs (discrete accumulations of oil <10 cm in diameter)
TC	Tar (highly weathered oil, of tarry, nearly solid consistency)
SR	Surface Oil Residue (non-cohesive, oiled surface sediments)
AP	Asphalt Pavements (cohesive, heavily oiled surface sediments)
No	No oil present in Zone ID

Oil on Plants: Describe what part of the vegetation is oiled. Terms will vary depending on vegetation type (e.g., stems for marshes, trunks for trees).

Subsurface Oil Conditions

Describe in Comments Section 8, using the following terminology and codes:

OP	Oil-Filled Pores (pore spaces are completely filled with oil)
PP	Partially Filled Pores (the oil does not flow out of the sediments when disturbed)
OR	Oil Residue (sediments are visibly oiled with black/brown coat or cover on the clasts, but little or no accumulation of oil within the pore spaces)
OF	Oil Film (sediments are lightly oiled with an oil film, or stain on the clasts)
TR	Trace (discontinuous film or spots of oil, or an odor or tackiness)

Cross-Section Sketch: Draw entire intertidal and supra-tidal zone, showing the oil relative to normal high tide (important to determine re-mobilization and potential for natural removal).

SKETCH MAP

Site Name _____
Site No. _____
Date _____
Time _____
Names _____

Checklist

- ___ North Arrow
- ___ Scale
- ___ Oil Distribution
- ___ High Tide Line
- ___ Low Tide Line
- ___ Substrate Types
- ___ Trench Locations

Legend

1△
Trench Number.
No Subsurface Oil

2▲
Trench Number.
Subsurface Oil

#●→
#●
Photographs

Appendix E

A Primer on Drawing Field Sketches

A Primer on Drawing Field Sketches

The field sketch is an important component of the shoreline assessment process for two principal reasons: (1) it provides a focused picture of the oil distribution within the entire segment, or subsegment, on a single piece of paper (or image); and (2) it adds discipline to the field observation process, because it forces the person doing the sketch to make detailed mental notes of all the relevant features.

Step 1 Once you arrive at the segment, imagine yourself held aloft 200 feet by a balloon as you quickly walk around the entire segment. This will give you a mental overview of the spatial distribution of all the relevant features in the segment that should be included in the sketch.

Step 2 Determine the dimensions of the segment and dig trenches to look for subsurface oil. Divide the duties among team members (e.g., one to sketch, one or two to pace or tape distances). Pace (or tape) the length and width of the intertidal zone and the size of some of the more conspicuous features, such as groins or seawall segments. Using a pencil, lightly sketch these measurements on the field sheet in Figure E-1 below. Orient the longest dimension along the long axis of the paper. Add scale and north arrow (use English or metric units, as dictated by the situation).

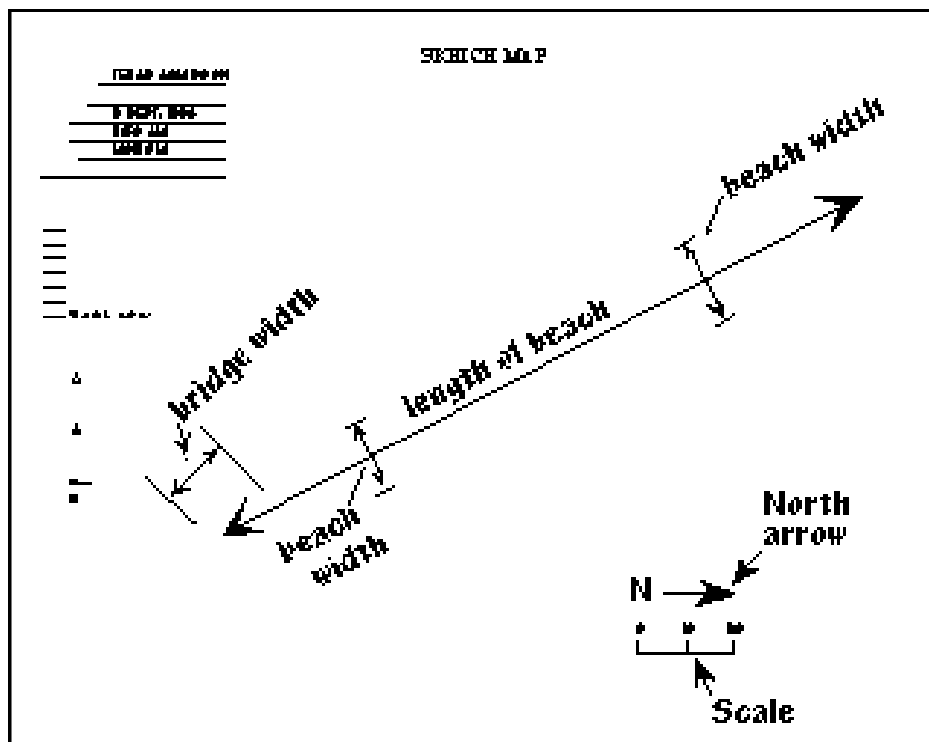

Figure E-1. Example of field sketch map dimensions and scale.

Step 3 Lightly sketch in the outline of the intertidal zone or habitat being surveyed. Show in final form (i.e., heavy pencil marks) the areal distribution of the oil, using a hatched pattern. The oil distribution should be the most conspicuous feature on the sketch, as shown in Figure E-2 below.

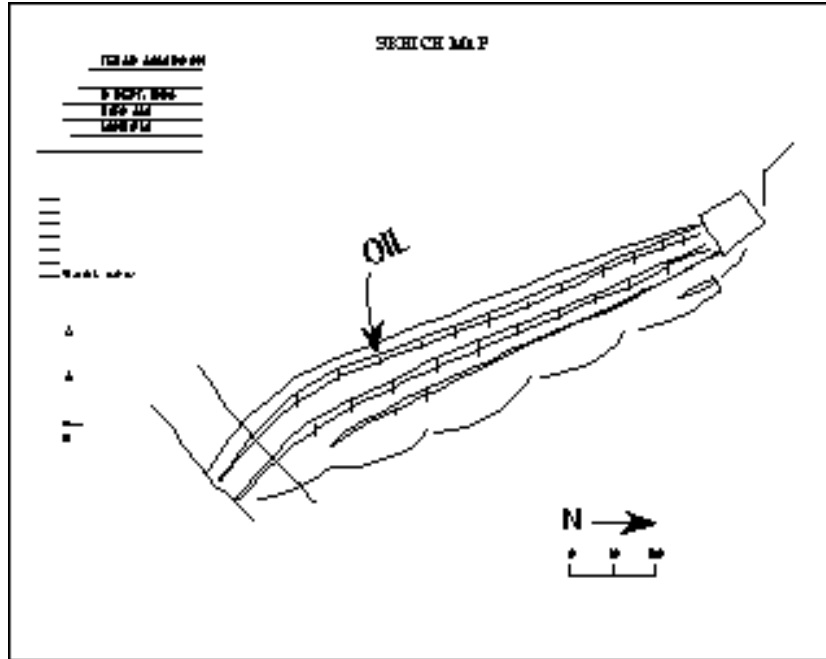
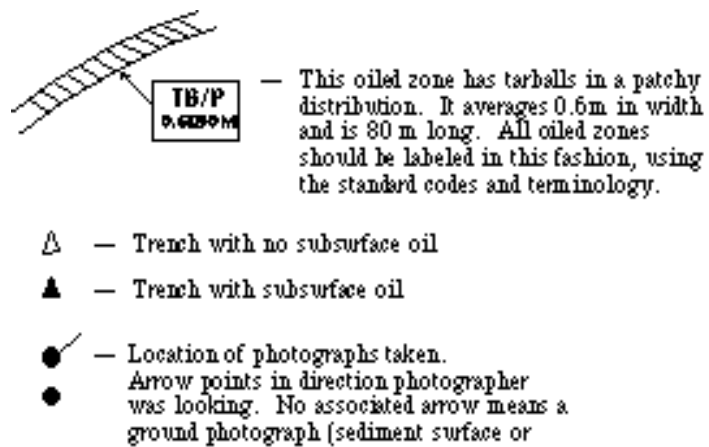

Figure E-2. Example of a field sketch map with outline of surveyed area.

Step 4 Identify critical elements of the sketch, using the following symbology:



- Step 5** Fill in the rest of the details of the sketch, showing highlights of the morphology (e.g., beach berms, tidal channels); conspicuous features, such as fences, large logs, and seawalls that would help identify the site; zones of vegetation; and access points, such as roads and parking areas.
- Step 6** (Optional) Where appropriate, draw a topographic cross-chapter of the intertidal zone, showing significant topographic breaks (e.g., beach berm crests) and oiled zones.
- Step 7** Make sure that the form is completely filled in with site location, date and time of survey, and names of survey team members. Review the checklist on the left side of form.

Figure E-3 is an example of a completed beach sketch. Figure E-4 is an example of a field sketch map for a detailed survey of subsurface oil at the *Exxon Valdez* spill site. The exact location of the subsurface oil was surveyed in and identified with permanent markers (i.e., stakes just above high-tide line), because of the expense of removing the overburden.

SKETCH MAP

Site Name Port Huen, P.O. 5, Alaska
 Site No. KB-405A (under 50,000)
 Date 4 March 1991
 Title _____
 Names T. G. Kelly (Bossy), B. L. Lammert
K. G. Smith (Smith), J. R. Simpson (Simpson)

SUBSURFACE OIL REVIEW

4-June-'91



- Checklist**
- West Area
 - Soil
 - Oil Distribution
 - High Table Line
 - Low Table Line
 - Substrate Types
 - Trench Locations

Legend

- 12 Trench Number
- No Subsurface Oil
- 24 Trench Number
- Subsurface Oil
- OP Present
- PO Present
- MO Present

