

***PROCEEDINGS: PUBLIC WORKSHOP***

***DECOMMISSIONING AND REMOVAL  
OF OIL AND GAS FACILITIES  
OFFSHORE CALIFORNIA:***

***RECENT EXPERIENCES AND FUTURE  
DEEPWATER CHALLENGES***

**Ventura, California  
September 23-25, 1997**

**Sponsored by:**

**U.S. Department of the Interior, Minerals Management Service  
California State Lands Commission**

**Co-Sponsored by:**

**E & P Forum  
Chevron, USA, Inc.  
Torch Operating Company**

**Hosted by:**

**University of California, Santa Barbara  
University of California, Berkeley**

**Edited by:**

**Frank Manago, Minerals Management Service  
Bonnie Williamson, University of California, Santa Barbara**



***PROCEEDINGS: PUBLIC WORKSHOP***

**DECOMMISSIONING AND REMOVAL OF OIL AND GAS  
FACILITIES OFFSHORE CALIFORNIA:  
RECENT EXPERIENCES AND FUTURE DEEPWATER CHALLENGES**

**Sponsored by:  
U.S. DEPARTMENT OF THE INTERIOR, MINERALS MANAGEMENT SERVICE  
and  
CALIFORNIA STATE LANDS COMMISSION**

**Co-Sponsored by:  
E & P FORUM  
CHEVRON, USA, INC.  
TORCH OPERATING COMPANY**

**Doubletree Hotel  
Ventura, California  
September 23-25, 1997**

**Edited by:  
Frank Manago  
and  
Bonnie Williamson**

**Prepared by:  
Southern California Educational Initiative  
Coastal Research Center  
Marine Science Institute  
University of California, Santa Barbara  
Santa Barbara, CA 93106  
May 1998**

### **Disclaimer**

This document was prepared by the Southern California Educational Initiative which is jointly funded by the Minerals Management Service and the University of California, under Minerals Management Service Cooperative Agreement Number 14-35-0001-30761. The report has not been reviewed by the Service for either content or compliance with its editorial standards. The intent of the proceedings is to record what transpired at the workshop. Its publication should not be interpreted as necessarily representing the official policies, either expressed or implied, of the U.S. Government or any other sponsor or cosponsor. Issue papers, plenary speeches and presentations were edited for form only.

### **Availability of Report**

A limited number of copies of this report will be available for distribution. To order, please contact:

Bonnie Williamson  
Marine Science Institute  
University of California  
Santa Barbara, California 93106  
phone: 805-893-2051  
fax: 805-893-3777  
email: b\_willia@lifesci.ucsb.edu

This document is also available via FTP at the MMS Pacific Region web site:  
<ftp://www.mms.gov/pub/pacific/>

### **Citation**

The suggested citation for these proceedings is:

Manago, F. and B. Williamson (eds.) Proceedings: Public Workshop, Decommissioning and Removal of Oil and Gas Facilities Offshore California: Recent Experiences and Future Deepwater Challenges, September 1997. MMS OCS Study 98-0023. Coastal Research Center, Marine Science Institute, University of California, Santa Barbara, California. MMS Cooperative Agreement Number 14-35-0001-30761. 269 pp.

## SPONSORSHIPS

The **Minerals Management Service** and the **California State Lands Commission** sponsored the workshop.

In addition, the following organizations made financial contributions to the workshop:

- ★**Gold**            **E & P Forum**
- ★**Silver**        **Chevron, USA, Inc.**
- ★**Bronze**      **Torch Operating Company**

The following made in-kind contributions:

- **UC Coastal Toxicology Program**
- **Ecomar, Inc.**
- **Twachtman, Snyder & Byrd, Inc.**

## ACKNOWLEDGEMENTS

Acknowledgements are extended to all the participants involved in this very successful workshop.

## BACKGROUND

There are a total of 27 oil and gas platforms and approximately 200 miles of associated pipelines located off the coast of southern California. Of the 27 platforms, four are located in state tidelands within 3 miles of the coast and 23 on the Federal Outer Continental Shelf (OCS). There are also six artificial islands located in State tidelands that have been constructed to recover oil and gas resources. As the end of the service life approaches for these facilities, plans for decommissioning and removing the facilities must be developed.

In 1994, the Minerals Management Service (MMS) and the California State Lands Commission (SLC) jointly sponsored a workshop to familiarize the public with the decommissioning process and disseminate information on upcoming projects. Since that time several major decommissioning projects have been completed and several others are underway or moving forward. This includes a recently-announced project that could involve the decommissioning and removal of as many as five OCS platforms and two associated onshore processing facilities. The decommissioning and removal of these platforms, which are located in water depths ranging from 318 to 740 feet, will present significant technical, environmental and material disposal challenges.

To facilitate the continuation of public involvement and participation in the decommissioning process, the MMS and SLC decided to sponsor a 1997 workshop to review recent experiences and discuss future deepwater decommissioning challenges.

## WORKSHOP GOALS

The goals of this workshop were to disseminate information to the public on the results of recently completed projects, identify issues of concern, and elicit recommendations on future California decommissioning operations and associated technical, environmental, socio-economic and disposition issues.

## **WORKSHOP ORGANIZING COMMITTEE**

**Frank Manago**, Minerals Management Service, Pacific OCS Region

**John Smith**, Minerals Management Service, Pacific OCS Region

**Pete Johnson**, California State Lands Commission

**Marina Voskanian**, California State Lands Commission

**Mark Carr**, Department of Biology, University of California, Santa Cruz

**Bonnie Williamson**, Marine Science Institute, University of California, Santa Barbara

## **WORKSHOP SESSION CO-CHAIRS**

### **Technical Workshop Session**

**Robert Byrd, Co-Chair**, Twachtman, Snyder & Byrd, Inc.

**Marina Voskanian, Co-Chair**, California State Lands Commission

### ***Environmental Workshop Session***

**Bill Douros, Co-Chair**, Santa Barbara County, Energy Division

**Simon Poulter, Co-Chair**, Padre Associates, Inc.

### ***Disposition Workshop Session***

**Mark Carr, Co-Chair**, University of California, Santa Cruz

**John Stephens, Co-Chair**, Vantuna Research Group and  
University of California, Los Angeles

## TABLE OF CONTENTS

<b>Workshop Program</b> .....	1
<b>Workshop Steering Committee</b> .....	5
<b>Workgroup Chairs and Members</b> .....	6
<b>Workshop Presentations</b>	
<b>PLENARY ADDRESSES</b>	
<b>Introductory Remarks</b> , Carolita Kallaur, Associate Director, Offshore, Minerals Management Service.....	9
<b>Pacific Region Decommissioning Update, Outlook, and Perspectives</b> , Tom Dunaway, Minerals Management Service, Pacific OCS Region .....	11
<b>California State Lands Commission Management Responsibility and Recent Decommissioning Experience</b> , Paul Mount, California State Lands Commission .....	13
<b>Update on Decommissioning Issues</b> , Bud Danenberger, Minerals Management Service, Headquarters .....	14
<b>California State Lands Commission: Decommissioning Policy and Regulations</b> , Dwight Sanders, California State Lands Commission .....	16
<b>Regulatory Framework and Environmental Review Process for the Decommissioning of Oil and Gas Facilities</b> , Simon Poulter, Padre Associates, Inc. ....	18
<b>International Developments: Lessons Learned and Need for Public Input</b> , W.S. (Bill) Griffin, Jr., Phillips Petroleum Company .....	20
<b>TECHNICAL SESSION</b>	
<b>The Plugging Process: Securing Old Gas and Oil Wells for the Protection of the Environment</b> , Steve Fields, California Dept. of Conservation, Division of Oil, Gas & Geothermal Resources and Max Martin, Twachtman, Snyder & Byrd, Inc. ....	25
<b>Offshore Production Facilities: Decommissioning of Topsides Production Equipment</b> , Dr. Peter Prasthofer, Offshore Decommissioning Communications Project .....	38
<b>Removal and Disposal of Deck and Jacket Structures</b> , Andy Culwell, American Pacific Marine, Inc. ....	48
<b>Pipeline and Power Cable Decommissioning</b> , Andy Culwell, American Pacific Marine, Inc. and Jack McCarthy, Minerals Management Service, Pacific OCS Region.....	66
<b>Site Clearance and Verification</b> , Jack McCarthy, Minerals Management Service Pacific OCS Region .....	74
<b>Decommissioning of Onshore Facilities: Technical Issues</b> , Luis Perez, Santa Barbara County Department of Planning and Management, Energy Division.....	83
<b>ENVIRONMENTAL SESSION</b>	
<b>Air Quality</b> , Peter Cantle, Santa Barbara County Air Pollution Control District .....	93
<b>Platform Decommissioning: Commercial and Recreational Fisheries Effects</b> , Dr. Craig Fusaro, Joint Oil / Fisheries Liaison Office .....	95
<b>The Commercial Fishing Industry in South/Central California</b> , Dr. Craig Fusaro, Joint Oil/Fisheries Liaison Office and John Richards, UC Santa Barbara.....	97
<b>Fisheries Impacts of Explosives Used in Platform Salvage</b> , Dr. Ann Bull, Minerals Management Service, Gulf of Mexico OCS Region .....	104
<b>Effects of Decommissioning Activities on Marine Benthos</b> , Leray deWit, DeWit Consulting, Inc. ....	105

<b>DISPOSITION SESSION</b>	
<b>Commercial Fisheries: Long-term Effects of Offshore Oil and Gas Facilities     Decommissioning</b> , John Richards, UC Santa Barbara .....	111
<b>Ecological Consequences of Alternative Decommissioning Strategies for     POCS Offshore Facilities</b> , Dr. Mark Carr, UC Santa Cruz, Dr. Graham Forrester, UC Los Angeles and Dr. Michael McGinnis, UC Santa Barbara .....	116
<b>Effect of Offshore Oil Platform Structures on the Distribution Pattern of     Commercially Important Benthic Crustaceans, with Emphasis on the     Rock Crab</b> , Dr. Mark Page and Dr. Jenny Dugan, UC Santa Barbara .....	119
<b>Enhancement of Platforms as Artificial Reefs</b> , Dave Parker, California Department of Fish and Game .....	122
<b>Long-term Socio-economic Effects of Onshore Facility Decommissioning</b> , Dr. James Lima, Minerals Management Service, Pacific OCS Region .....	124
<b>SUMMARY AND RECOMMENDATIONS</b>	
<b>Technical Session</b> .....	137
<b>Environmental Session</b> .....	140
<b>Disposition Session</b> .....	145
<b>AGENCY PANEL DISCUSSION</b> .....	149
<b>POSITION PAPERS</b>	
<b>Environmental Defense Center</b> , Linda Krop and Nichole Camozzi .....	172
<b>Exxon Co., USA</b> , Dave Tyler .....	177
<b>Recreational Fishers</b> , Merit McCrea .....	179
<b>Santa Barbara Lobster Trappers</b> , Chris Miller .....	181
<b>Southern California Trawlers Association</b> .....	182
<b>United Anglers of Southern California / American Sportfishing Association</b> , Daniel Frumkes .....	184
<b>APPENDICES</b>	
<b>APPENDIX I: REGULATORY FRAMEWORK AND ENVIRONMENTAL REVIEW PROCESS FOR THE DECOMMISSIONING OF OIL AND GAS FACILITIES</b> .....	193
<b>APPENDIX II: PLATFORM SCHEMATIC AND LOCATIONS</b> .....	221
<b>APPENDIX III: GLOSSARY AND ABBREVIATIONS</b> .....	231
<b>APPENDIX IV: BIOGRAPHICAL SKETCHES</b> .....	245
<b>APPENDIX V: LIST OF ATTENDEES</b> .....	257



## LIST OF FIGURES

<b>Author</b>	<b>Figure</b>	
Danenberger	Rigs to Reefs.....	15
	Existing OCS Structures by Age .....	15
	Existing OCS Structures by Water Depth .....	15
	Structures Removed by Water Depth .....	15
	Structures by Age at Time of Removal .....	15
Poulter	Permitting Jurisdictions .....	18
	Major Steps in the Permitting Process .....	19
Griffin	Worldwide Distribution of Platforms .....	20
	Platform Size Comparison .....	20
	Finding the Right Balance .....	22
Fields & Martin	Figure 1. Well P&A Rig vs. Rigless, Step 1 .....	28
	Figure 2. Well P&A Rig vs. Rigless, Step 2.....	28
	Figure 3. Well P&A Rig vs. Rigless, Step 3.....	28
	Figure 4. Well P&A Rig vs. Rigless, Step 4.....	28
Prasthofer	Figure 1. Integrated Topsides / Deck .....	39
	Figure 2. Modular Topsides / Deck .....	39
	Figure 3. Hybrid Topsides on Concrete Gravity-based Structure.....	39
	Figure 4. Topsides Removal / Disposal Options .....	40
	Figure 5. Removal in One Piece .....	40
	Figure 6. Lifting of Combined Modules.....	41
	Figure 7. Reverse Installation.....	41
	Figure 8. Piece Small Removal .....	42
Culwell	Figure 1. Facilities Decommissioned on the West Coast.....	49
	Figure 2. Platforms Hope, Heidi, and Hilda Design.....	51
	Figure 3. Platform Hazel Design .....	51
	Figure 4. Pipeline Bypass at Platform Hope.....	53
	Figure 5. OS&T Abandonment Project Facilities Layout .....	54
	Figure 6. SALM Base Structure.....	55
	Figure 7. Equipment Spread – Shallow Water Decommissioning.....	56
	Figure 8. Lift Plan – Crane Chart.....	57
	Figure 9. Lift Plan – Lift Points and CG Locations.....	57
	Figure 10. Materials Transport Planning .....	57
	Figure 11. Preparations to Deck Packages.....	60
	Figure 12. Pile and Conductor Severing Using Explosives .....	63
Culwell & McCarthy	Figure 1. Diagram of Articulated Concrete Mat .....	70
	Figure 2. Exxon OS&T Project Facilities .....	71

**LIST OF FIGURES  
(continued)**

<b>Author</b>	<b>Figure</b>	
Fusaro & Richards	Figure 1. Crab & Lobster Traps as Deployed .....	98
	Figure 2. Crab or Lobster Vessel, Fore Deck .....	98
	Figure 3. Set Gillnet Deployed .....	100
	Figure 4. Drift Gillnet – Structure of Gear .....	100
	Figure 5. Vessel Gillnet.....	100
	Figure 6. Hook & Line Gear, Deployed.....	101
	Figure 7. Trawl.....	101
	Figure 8. Vessel, Purse Seine .....	102
	Figure 9. Purse Seine .....	102
	Figure 10. Troll.....	103
Page & Dugan	Figure 1. Summary of Distribution & Movement Scenarios for the Rock Crab .....	121
Appendix I	Figure 1. Permit Requirements by Facility Location .....	196
	Figure 2. NEPA Environmental Review Process: An Overview.....	199
	Figure 3. Steps in the Environmental Review Process under CEQA .....	211
Appendix II	Platform Schematic .....	223
	Offshore Facilities, Santa Barbara Channel .....	226
	Offshore Facilities, Southern California.....	227
	Onshore Oil & Gas Facility Decommissioning Tree .....	228
	Offshore Oil & Gas Facility Decommissioning Tree .....	229

**LIST OF TABLES**

<b>Author</b>	<b>Table</b>	
Poulter	Overview of Permitting Requirements.....	19
Fields & Martin	Table 1. Basic Cementing Materials.....	31
Perez	Table 1. Listing of Potential Contaminants Associated with Oil & Gas Operations .....	85
	Table 2. Potential Hazards of Hydrocarbons.....	87
	Table 3. Remediation Techniques.....	88
Lima	Table 1. Criteria for the Assessment of Social & Economic Impact in Onshore Facilities Decommissioning .....	125
Appendix II	Platforms Located in Federal Waters, Pacific OCS Region.....	224
	State Waters Offshore Facilities.....	225

**DECOMMISSIONING AND REMOVAL  
OF OIL AND GAS FACILITIES OFFSHORE CALIFORNIA:  
RECENT EXPERIENCES AND FUTURE DEEPWATER CHALLENGES  
DOUBLETREE HOTEL, VENTURA, CALIFORNIA  
SEPTEMBER 23 - 25, 1997  
WORKSHOP PROGRAM**

**TUESDAY, SEPTEMBER 23 - MORNING**

**8:00-8:30 Registration**

**PLENARY SESSION**

**8:30 - 9:00 Welcome and Introduction**

- Dr. Russell Schmitt, Professor of Ecology, UC Santa Barbara
- Carolita Kallaur, Associate Director, Offshore, Minerals Management Service
- Robert Hight, Executive Officer, California State Lands Commission

**9:00 - 9:50 Pacific Region Decommissioning Update, Outlook and Perspectives**

- Tom Dunaway, Regional Supervisor, Office of Development, Operations & Safety, Minerals Management Service, Pacific OCS Region
- Paul Mount, Chief, Minerals Resources Management Division, California State Lands Commission
- John Patton, Director, Santa Barbara County, Dept. of Planning and Development
- Linda Krop, Senior Staff Attorney, Environmental Defense Center
- Frank Holmes, Coastal Coordinator, Western States Petroleum Association

**9:50 - 10:40 Decommissioning Policy, Regulations and International Developments**

- Bud Danenberger, Chief, Engineering and Technology Division, Minerals Management Service
- Dwight Sanders, Chief, Div. of Environmental Planning and Management, California State Lands Commission
- Susan Hansch, Deputy Director, Energy & Ocean Resources Unit, California Coastal Commission
- Bill Griffin, Director of Special Projects, Phillips Petroleum Company
- Simon Poulter, Principal, Padre Associates, Inc.

**10:40-11:00 Break**

**11:00 - 11:45 Preview of the Workgroup Sessions**

**Technical Workgroup Co-Chairs**

- Marina Voskanian, Chief Reservoir Engineer, Minerals Resources Mgmt. Div., California State Lands Commission
- Dr. Robert Byrd, Principal, Twachtman, Snyder & Byrd, Inc.

**Environmental Workgroup Co-Chairs**

- Bill Douros, Deputy Director, Energy Division, Santa Barbara County, Dept. of Planning and Development
- Simon Poulter, Principal, Padre Associates, Inc.

**Disposition Workgroup Co-Chairs**

- Dr. John Stephens, Director, Vantuna Research Group and Office of Research, UC Los Angeles
- Dr. Mark Carr, Assistant Professor of Biology, UC Santa Cruz

**11:45 - 12:15 Public Discussion Period**

Moderator: Dr. Russell Schmitt, Professor of Ecology, UC Santa Barbara

**12:15 - 1:30 Lunch Break**

**TUESDAY, SEPTEMBER 23 - AFTERNOON**

**TECHNICAL SESSION**

**1:30 - 3:15 The Process of Decommissioning and Removing Offshore and Associated Onshore Oil and Gas Facilities**

Co-Chair: Dr. Robert Byrd, Principal, Twachtman, Snyder & Byrd, Inc.

Co-Chair: Marina Voskanian, Chief Reservoir Engineer, Minerals Resources Management Division, California State Lands Commission

**Making Oil & Gas Wells Safe: The Plugging Process**

- Steve Fields, Operational Engineer, California Department of Conservation, Division of Oil, Gas and Geothermal Resources

**Offshore Production Facilities: Decommissioning of Topside Production Equipment**

- Dr. Peter Prasthofer, Technical Manager, Offshore Decommissioning Communications Project

**Decommissioning of Decks, Jackets, Pipelines and Cables**

- Andy Culwell, Vice President of Special Projects, American Pacific Marine, Inc.

**3-15 - 3:30 Break**

**3:30 - 4:30 TECHNICAL SESSION - (continuation)**

**Site Clearance and Verification**

- Jack McCarthy, Geophysicist, Minerals Management Service, Pacific OCS Region

**Onshore Facility Cleanup and Removal**

- Luis Perez, Energy Specialist, Energy Division, Santa Barbara County, Dept. of Planning & Development

**4:30 - 5:30 Public Discussion Period**

**WEDNESDAY, SEPTEMBER 24 - MORNING**

**8:00 - 8:30 Registration**

**ENVIRONMENTAL SESSION**

**8:30 - 10:30 Environmental and Socio-Economic Effects Occurring During the Decommissioning and Removal Process and Measures for Mitigating Impacts**

Co-Chair: Bill Douros, Deputy Director, Energy Division, Santa Barbara County, Dept. of Planning and Development

Co-Chair: Simon Poulter, Principal, Padre Associates, Inc.

**Air Quality**

- Peter Cantele, Santa Barbara County Air Pollution Control District

**Commercial / Recreational Fisheries**

- Dr. Craig Fusaro, Director, Joint Oil Fisheries Liaison Office

**Fisheries Research**

- Villere Reggio, Outdoor Recreation Planner, Minerals Management Service, Gulf of Mexico OCS Region

**Marine Mammals**

- Peter Howorth, Principal, Marine Mammal Consulting Group

**Marine Benthic Organisms**

- Ray de Wit, L.A. de Wit, Consulting

**Water Quality**

- Dr. Peter Raimondi, Assistant Professor of Biology, UC Santa Cruz

**10:30 - 10:45 Break**

**10:45 - 11:25 ENVIRONMENTAL SESSION - (continuation)**

**Cleanup Standards: Assessment and Remediation of Onshore Sites**

- Frank DeMarco, Associate Water Resource Control Engineer, Central Coast Regional Water Quality Control Board

**Future Land Use**

- Kim Schizas, Land Use Planner, Wynmark Company

- 11:25 - 12:30 Perspectives of Ocean User Groups and Public Discussion Period**  
Moderator: Dr. Russell Schmitt, Professor of Ecology, UC Santa Barbara  
Ocean User Group Representatives  
**Commercial Fishing**
  - Mike McCorkle, President, Southern California Trawlers Association**Recreational Fishing**
  - Merit McCrea, Owner, Captain McCrea's Sportfishing**Oil and Gas Industry**
  - David Tyler, Public Affairs Advisor, Exxon Co., USA, Inc.**Environmental Interest Groups**
  - Marc Chytilo, Chief Counsel, Environmental Defense Center
- 12:30 - 1:30 Lunch Break**

## SEPTEMBER 24 - AFTERNOON

### DISPOSITION SESSION

- 1:30 - 3:10 Long-term Environmental and Socio-Economic Effects Related to the Disposition of Oil and Gas Facilities**  
Co-Chair: Dr. John Stephens, Director, Vantuna Research Group and Office of Research, UC Los Angeles  
Co-Chair: Dr. Mark Carr, Assistant Professor of Biology, UC Santa Cruz  
**Commercial Fishing**
  - John Richards, Sea Grant Extension Program, Marine Science Institute, UC Santa Barbara**Recreational Fishing**
  - Dr. Milton Love, Associate Research Biologist, Marine Science Institute, UC Santa Barbara**Habitat Value of Oil and Gas Facilities**
  - Dr. Mark Carr, Assistant Professor of Biology, UC Santa Cruz**Enhancement of Platforms as Artificial Reefs**
  - Dave Parker, Senior Biologist, California Dept. of Fish and Game**Site Clearance: Long-term Issues**
  - Jack McCarthy, Geophysicist, Minerals Management Service, Pacific OCS Region
- 3:10 - 3:30 Break**
- 3:30 - 4:10 DISPOSITION SESSION - (continuation)**  
**Onshore Disposition: Ultimate Fate**
  - Dr. James Lima, Social Scientist, Minerals Management Service, Pacific OCS Region**Social and Economic Effects**
  - Dr. Robert Ditton, Professor of Wildlife and Fisheries Sciences, Texas A&M University
- 4:10 - 5:30 Perspectives of Ocean User Groups and Public Discussion Period**  
Moderator: Dr. Russell Schmitt, Professor of Ecology, UC Santa Barbara  
Ocean User Group Representatives  
**Commercial Fishing**
  - Gordon Cota, Member, Southern California Trawlers Association**Recreational Fishing**
  - Dan Frumkes, Director, Conservation Network, American Sportfishing Association**Oil and Gas Industry**
  - Lee Bafalon, Senior Land Representative, Chevron U.S.A., Inc.**Environmental Interest Group**
  - Linda Krop, Senior Staff Attorney, Environmental Defense Center

**THURSDAY, SEPTEMBER 25 - MORNING**

**SUMMARY AND RECOMMENDATIONS SESSION**

Moderator: Dr. Russell Schmitt, Professor of Ecology, UC Santa Barbara

**9:00 - 10:00 Report of Session Co-Chairs**

**Technical Workgroup Session**

- Dr. Robert Byrd / Marina Voskanian

**Environmental Workgroup Session**

- Bill Douros / Simon Poulter

**Disposition Workgroup Session**

- Dr. Mark Carr / Dr. John Stephens

**10:00 - 12:30 Agency Panel Discussion With Public**

**Federal Agency Representatives**

- Dr. J. Lisle Reed, Regional Director, Minerals Management Service, Pacific OCS Region
- Richard Schubel, Chief, Regulatory Functions Branch, U.S. Army Corps of Engineers, Los Angeles District
- Maureen Walker, Deputy Director, Office of Ocean Affairs, U.S. Department of State

**State Agency Representatives**

- Robert Hight, Executive Officer, California State Lands Commission
- Brian Baird, Ocean Program Manager, California Resources Agency
- Susan Hansch, Deputy Director, Energy & Ocean Resources Unit, California Coastal Commission
- Pete Bontadelli, Administrator, Oil Spill Prevention and Response Office, California Dept. of Fish & Game

**Local Agency Representatives**

- Nancy Settle, Manager, Regional Programs Section, Ventura County, Planning Division, Resources Management Agency
- John Patton, Director, Santa Barbara County, Dept. of Planning and Development

**Summary and Closing Remarks**

Moderator: Dr. Russell Schmitt, Professor of Ecology, UC Santa Barbara

**STEERING COMMITTEE MEMBERS / PARTICIPANTS**

**RICHARD WILHELMESEN, Co-Chair**, Minerals Management Service, Pacific OCS Region

**PAUL MOUNT, Co-Chair**, California State Lands Commission

**Doug Anthony, Santa Barbara County, Energy Division**

Lee Bafalon, Chevron, USA, Inc.

Chandra Basavalinganadoddi, California State Lands Commission

Dennis Bedford, CA Department of Fish & Game

Theresa Bell, Minerals Management Service, Pacific OCS Region

John Brown, U.S. Coast Guard

Dr. Robert Byrd, Twachtman, Snyder & Byrd, Inc.

Andy Caldwell, Coalition of Labor, Agriculture & Business

Peter Cante, Santa Barbara County, Air Pollution Control District

Dr. Mark Carr, UC Santa Cruz

Brian Collins, UC Berkeley

Andy Culwell, American Pacific Marine, Inc.

John Deacon, Torch Operating Company

Bill Douros, Santa Barbara County, Energy Division

**Tom Dunaway, Minerals Management Service, Pacific OCS Region**

Steve Fields, CA Dept. of Conservation, Division of Oil, Gas and Geothermal Resources

Nancy Francis, County of Ventura, Planning Division

Daniel Frumkes, United Anglers of Southern California

Dr. Craig Fusaro, Joint Oil / Fisheries Liaison Office

Troy Gillum, Worley International, Inc.

Bill Grady, Exxon Company, USA, Inc.

Jim Grant, Minerals Management Service, Pacific OCS Region

Richard Habrat, Minerals Management Service, Pacific OCS Region

Frank Holmes, Western States Petroleum Association

Jean Holmes, League of Women Voters

Peter Howorth, Marine Mammal Consulting Group

Pete Johnson, California State Lands Commission

Pat Kinnear, CA Dept. of Conservation, Division of Oil, Gas and Geothermal Resources

Linda Krop, Environmental Defense Center

Irma Lagomarsino, National Marine Fisheries Service

John Lane, Minerals Management Service, Pacific OCS Region

Herb Leedy, Minerals Management Service, Pacific OCS Region

Roger Lyon, Surfrider Foundation

Frank Manago, Minerals Management Service, Pacific OCS Region

Nabil Masri, Minerals Management Service, Pacific OCS Region

Jack McCarthy, Minerals Management Service, Pacific OCS Region

Mike McCorkle, Southern California Trawlers Association

Dr. Daniel Meade, UC Santa Barbara

Elaine Meckenstock, UC Berkeley

Dr. Saahed Meshkatj, University of Southern California, Petroleum Engineering Program

Aiden Naughton, California State Lands Commission

Dave Parker, CA Department of Fish & Game

Dr. Fred Piltz, Minerals Management Service, Pacific OCS Region

Simon Poulter, Padre Associates, Inc.

Greg Sanders, U.S. Fish & Wildlife Service

Jerry Schiebe, Santa Barbara County, Air Pollution Control District

John Segerstrom, Texaco, Inc.

Glenn Shackell, Minerals Management Service, Pacific OCS Region

John Smith, Minerals Management Service, Pacific OCS Region

Robert Sollen, Sierra Club

Rick Sorrell, U.S. Coast Guard

Dr. John Stephens, Vantuna Research Group, UC Los Angeles

Theresa Stevens, U.S. Army Corps of Engineers

Win Thornton, WINMAR Consulting Services, Inc.

Lyman Thorsteinson, U.S.G.S., Biological Resources Division

Marina Voskanian, California State Lands Commission

Kirk Walker, California State Lands Commission

Tiffany Welch, U.S. Army Corps of Engineers

Al Willard, California State Lands Commission

Bonnie Williamson, UC Santa Barbara

James Wiseman, UC Berkeley

**WORKING GROUP MEMBERS**

Frank Manago and John Smith, Minerals Management Service, Pacific OCS Region,  
served as liaisons among the working groups

**Technical Working Group**

**DR. ROBERT BYRD, Co-Chair**, Twachtman, Snyder & Byrd, Inc.  
Dolores Aguilar-Zepeda, Chevron, USA, Inc.  
Roma Armbrust, League of Women Voters  
Dr. Robert Bea, UC Berkeley  
Peter Brooks, Worley International, Inc.  
Andrew Culwell, American Pacific Marine, Inc.  
Steve Fields, CA Dept. of Conservation, Division of Oil, Gas & Geothermal Resources  
Bill Grady, Exxon Company, USA, Inc.  
James Grant, Minerals Management Service, Pacific OCS Region  
Cathy Hoffman, Minerals Management Service, Pacific OCS Region  
Jean Holmes, League of Women Voters  
Maher Ibrahim, Minerals Management Service, Pacific OCS Region  
Pete Johnson, CA State Lands Commission  
Mike Kelley, Exxon Company, USA, Inc.  
Pat Kinnear, CA Dept. of Conservation, Division of Oil, Gas & Geothermal Resources

**MARINA VOSKANIAN, Co-Chair**, CA State Lands Commission  
Daniel Knowlson, Minerals Management Service, Pacific OCS Region  
Herb Leedy, Minerals Management Service, Pacific OCS Region  
Roger Lyon, Surfrider Foundation  
Jack McCarthy, Minerals Management Service, Pacific OCS Region  
Paul Mount, CA State Lands Commission  
Luis Perez, Santa Barbara County, Energy Division  
Gregory Scott, CA State Lands Commission  
Glenn Shackell, Minerals Management Service, Pacific OCS Region  
Arvind Shah, Minerals Management Service, Gulf of Mexico OCS Region  
Win Thornton, WINMAR Consulting Services, Inc.  
Robin Villa, Fugro West, Inc.  
Bonnie Williamson, UC Santa Barbara  
Wes Winkler, Chevron, USA, Inc.  
Lou Zylstre, American Pacific Marine, Inc.

**Environmental Working Group**

**BILL DOUROS, Co-Chair**, Santa Barbara County, Energy Division  
Doug Anthony, Santa Barbara County, Energy Division  
Lee Bafalon, Chevron, USA, Inc.  
Dr. Art Barnett, MEC Analytical Systems, Inc.  
Theresa Bell, Minerals Management Service, Pacific OCS Region  
Peter Cantle, Santa Barbara County, APCD  
Dr. Mark Carr, UC Santa Cruz  
Alison Dettmer, California Coastal Commission  
Nancy Francis, Ventura County, Planning Division  
Dr. Craig Fusaro, Joint Oil / Fisheries Liaison Office  
Bill Grady, Exxon Company USA, Inc.  
Frank Holmes, Western States Petroleum Association  
Peter Howorth, Marine Mammal Consulting Group

**SIMON POULTER, Co-Chair**, Padre Associates, Inc.  
Pete Johnson, CA State Lands Commission  
Karl Krause, Ventura County, APCD  
Linda Krop, Environmental Defense Center  
Herb Leedy, Minerals Management Service, Pacific OCS Region  
Joan Leon, League of Women Voters  
Roger Lyon, Surfrider Foundation  
Richard Nitsos, CA Department of Fish & Game  
Bob Sollen, Sierra Club  
John Storrer, Storrer Environmental Services  
Rosie Thompson, SAIC  
Marina Voskanian, CA State Lands Commission  
Bonnie Williamson, UC Santa Barbara  
Dr. Charles Woodhouse, Santa Barbara Museum of Natural History

**Disposition Working Group**

**DR. MARK CARR, Co-Chair**, UC Santa Cruz  
Lee Bafalon, Chevron, USA, Inc.  
Art Boehm, Nuevo Energy Company  
Bill Douros, Santa Barbara County, Energy Division  
Alison Dettmer, California Coastal Commission  
Dr. Jenifer Dugan, UC Santa Barbara  
Dan Frumkes, United Anglers of Southern California  
Dr. Craig Fusaro, Joint Oil / Fisheries Liaison Office  
Michelle Gasperini, Santa Barbara County, Energy Division  
Jean Holmes, League of Women Voters  
Pete Johnson, CA State Lands Commission  
John Lane, Minerals Management Service, Pacific OCS Region  
Herb Leedy, Minerals Management Service, Pacific OCS Region

**DR. JOHN STEPHENS, Co-Chair**, Vantuna Research Group & UC Los Angeles  
Dr. Milton Love, UC Santa Barbara  
Annisa Mayer, UC Los Angeles  
Merit McCrea, Captain McCrea's Sportfishing  
Elaine Meckenstock, UC Berkeley  
Dave Parker, CA Department of Fish & Game  
Dr. Mark Page, UC Santa Barbara  
Simon Poulter, Padre Associates, Inc.  
John Richards, UC Santa Barbara  
Theresa Stevens, U.S. Army Corps of Engineers  
Rosie Thompson, SAIC  
Win Thornton, WINMAR Consulting Services, Inc.  
Marina Voskanian, CA State Lands Commission  
Tiffany Welch, U.S. Army Corps of Engineers  
Bonnie Williamson, UC Santa Barbara  
James Wiseman, UC Berkeley



---

---

## PLENARY ADDRESSES

---

Introductory Comments, Carolita Kallaur .....	9
Pacific Region Decommissioning Update, Outlook, and Perspectives, Tom Dunaway .....	11
California State Lands Commission Management Responsibility and Recent Decommissioning Experience, Paul Mount.....	13
Update on Decommissioning Issues, Bud Danenberger .....	14
California State Lands Commission: Decommissioning Policy and Regulations, Dwight Sanders.....	16
Regulatory Framework and Environmental Review Process for the Decommissioning of Oil and Gas Facilities, Simon Poulter.....	18
International Developments: Lessons Learned and Need for Public Input, W.S. (Bill) Griffin, Jr. ....	20



## INTRODUCTORY REMARKS

### CAROLITA KALLAUR

#### Associate Director for Offshore Minerals Management U.S. Department of the Interior, Minerals Management Service

Good morning, it's my pleasure to be here today to welcome you to this important workshop.

For those of you who may be unfamiliar with the MMS, the MMS is the agency within the Department of the Interior responsible for administering oil and gas and other mineral development on the Federal Outer Continental Shelf (OCS). Offshore California, Federal OCS lands are those submerged lands located seaward of State tidelands, which extend from the coastline to three miles offshore.

Although the MMS is a relatively small bureau, we play a very significant role in managing development of our Nation's energy resources. We manage mineral development on 27 million acres of the OCS, which supplies over 25% of the natural gas and 12% of the oil produced in the United States. We also collect more than \$4 billion annually in revenues from OCS and onshore mineral leases. This money is distributed to Federal and State Treasuries, to allottees, including Indian Nations, and to the Land and Water Conservation Fund and the National Historic Preservation Fund.

As the stewards of America's offshore resources, MMS has a duty to ensure safe and environmentally sound development of our Nation's offshore oil and gas resources. This responsibility applies not only to development but also to the decommissioning of offshore production facilities once they have reached the end of their service life.

As many of you are aware, decommissioning operations are commonplace in the Gulf of Mexico where there are more than 4000 offshore platforms currently in place. Between 100 – 200 structures are removed there each year. Of the 1200 structures removed to date in the Gulf of Mexico, the majority (80%) have been small structures located in less than 100 feet of water. To date, there have not been any platforms removed in the Gulf located in water depths greater than 400 feet.

In comparison, there are currently 27 oil and gas platforms (23 OCS and 4 State) located off

the coast of southern California. Only seven offshore platforms have been removed to date, all from State tidelands. All of the platforms were relatively small structures located in less than 150 feet of water.

Industry is in the preliminary stages of developing plans for removing as many as five California OCS platforms and two associated onshore processing facilities early in the next century. Three of the platforms are located in water depths ranging from greater than 600 to 740 feet. If scheduling goes as planned, this could very well be the world's first ultra-deepwater decommissioning project. In terms of its combined onshore and offshore components, it will be the largest and most complex decommissioning project ever to be undertaken.

The decommissioning of deepwater oil and gas structures is a topic that has come to the forefront in the North Sea and is a topic that will be coming to the forefront in California, and the Gulf of Mexico in the near future. The topic is a timely one because it has implications for future deepwater development activity in the Gulf of Mexico, Pacific Region, North Sea, and other parts of the world. In the North Sea, decommissioning of offshore structures has been stymied by public controversy surrounding the Brent Spar Project, which involved the proposed decommissioning and ocean disposal of a large offshore loading structure. Due to this controversy, industry has had to re-evaluate its decommissioning strategy and consider the long-term implications for future development in the North Sea.

In contrast to shallow water, the decommissioning of deepwater facilities (> 200 foot water depths) will present significant technical, safety, environmental, and material disposal challenges. From a technical standpoint, the technology has yet to be developed to remove certain deepwater structures. This is particularly true in water depths exceeding 400 feet. The environmental impacts associated with decommissioning

large deepwater structures are also of much greater significance due to the size of the structures, which can be as large as the Empire State Building. The onshore infrastructure required to dispose of these massive steel structures also may not exist, which may necessitate consideration of other options such as converting the structures to artificial reefs or other uses.

In the Gulf of Mexico, statistics show that the greater the water depth the more likely decommissioned structures are to be converted to artificial reefs. Of the 1200 structures removed to date in the Gulf, about 10% have been converted to artificial reefs. However, 40% of the structures located in 100-200 feet of water, and 85% of the structures located in 200-400 feet of water have been converted to artificial reefs.

Let me assure you, MMS does not have a position one way or the other as to the rigs-to-reef program here in California. We believe that is an issue that falls primarily within the regulatory jurisdiction of the California Department of Fish and Game, Army Corps of Engineers, and the California Coastal Commission. The States of Louisiana and Texas have active rigs-to-reef programs, and MMS is involved to the extent that the decommissioning of OCS platforms takes place in a safe and environmentally sound manner. We are committed to working cooperatively with all interested parties to ensure that this goal is achieved off California.

Although our experience off California is limited, we recognize that the removal of offshore structures is a sensitive issue in California and that the utmost care must be taken to ensure that it is done in a manner that addresses the needs and concerns of all parties.

To accomplish that goal, we must all work closely together to develop a consensus on how to best proceed. That is why public workshops such as this are so important. They provide an opportunity for everyone who has an interest in the subject to share their viewpoints, discuss issues, and develop recommendations.

Offshore California, as in other offshore areas, we continue to place a very high priority on

safety. We will also continue to work closely with all interested parties to ensure that the removal and disposal of platforms is conducted in an environmentally sound manner.

To that end, we are pleased to be co-sponsoring this workshop with the California State Lands Commission (SLC). We are also pleased to have participated with the State in sponsoring previous workshops such as the 1994 Decommissioning Workshop at UC Santa Barbara and the 1997 California and the World Oceans Conference in San Diego.

Before closing, I would like to thank the SLC for co-sponsoring this workshop with the MMS and UC Santa Barbara and UC Berkeley for the administrative support they have provided. I also want to thank those who made financial contributions – the E & P Forum, Chevron, USA, and Torch Operating Company – as well as those who have made in-kind contributions.

Finally, I would like to thank members of the Workshop Organizing Committee for facilitating workshop planning meetings and organizing the workshop. These individuals include Frank Manago and John Smith from MMS, Pete Johnson and Marina Voskanian from the SLC, and Bonnie Williamson from UC Santa Barbara. I also want to thank the many people who attended workshop planning sessions and contributed to the development of what I consider to be a well rounded and balanced program. In particular, I would like to thank the co-chairs of the Workshop Steering Committee, Paul Mount of SLC and Dick Wilhelmsen of MMS, as well as session co-chairs, speakers and panel members for the significant time and effort they devoted to organizing and planning their respective sessions.

On behalf of the MMS, I welcome your participation in this effort. I want to ensure you that we will carefully consider the views of all parties as well as the recommendations that will be forthcoming. During the open panel discussion with the public on day three, we will share with you our perspectives on the workshop and recommendations.

I am looking forward to an interesting and productive workshop and encourage you all to actively participate. We value your input and look forward to your recommendations.

## **PACIFIC REGION DECOMMISSIONING UPDATE, OUTLOOK, AND PERSPECTIVES**

**TOM DUNAWAY**

**Regional Supervisor, Office of Development, Operations and Safety  
Minerals Management Service, Pacific Outer Continental Shelf Region**

I'm going to start off with a short overview of our Region. The Minerals Management Service Pacific Outer Continental Shelf Region oversees development of Federal mineral resources, primarily oil and gas, offshore California, Oregon, and Washington. Currently, we manage 83 leases, all of which are off the coast of California. The Federal Outer Continental Shelf (OCS) off California begins 3 miles from the coast adjacent to State tidelands.

We have 23 platforms producing a total of about 150,000 barrels of oil a day and 180 million cubic feet of gas per day, from 43 of the leases in the Region.

The Pacific OCS Region is organized by major program functions: an Office of Environmental Evaluation, an Office of Resource Evaluation, and an Office of Development, Operations and Safety.

The Office of Environmental Evaluation analyzes proposed and ongoing offshore oil and gas operations to ensure the activities are done in a way that safeguards the environment. This office also conducts a comprehensive environmental studies program.

The Office of Resource Evaluation analyzes oil, gas, and other mineral potential on the Federal OCS, using a wide range of geologic and geophysical information, and provides technical support for marine mineral investigations.

I'm the Regional Supervisor of the third office, the Office of Development, Operations and Safety, which is responsible for proper development of OCS resources on existing leases and the safety and environmental integrity of operations on the OCS.

Our office is responsible for the offshore inspections program, and we have inspectors offshore overseeing operations every day of the year.

This Plenary Session covers Pacific Region

Decommissioning Update, Outlook and Perspectives, so I'll begin with an update.

The newest of the Pacific OCS Region's 23 platforms have been in place 8 years; the oldest was installed 30 years ago this month. The Pacific OCS Region's facilities range from small shallow water to world class deepwater structures. We have one platform in less than a 100 feet of water; we also have two platforms in water depths of over a thousand feet. We haven't had any platforms decommissioned yet, but we had an offshore storage and treating vessel, a converted tanker, decommissioned in 1994. Though it wasn't a platform, the decommissioning was a technically complex operation, with separate phases involving disconnecting and removal of the vessel, the mooring buoy, and a riser section; cutting of piles and removal of the mooring base and subbase from the seafloor; cutting and removal of pipeline and power cable segments; and a survey of the area to recover debris. The Pacific OCS Region worked cooperatively with all interested parties before, during, and after that work. We learned from the experience, and we'll build on what we learned, for future decommissionings.

As to outlook, our first platform decommissionings will likely take place over the next 5-10 years. Chevron has started the planning process for decommissioning of their 5 platforms. Of those 5, the oldest was installed 18 years ago, and the newest only 11 years ago. The water depths range from around 300 feet to about 700 feet. Platform Harvest, off Point Arguello, is in 675 feet of water. And Platform Gail, in the Santa Barbara Channel, is in 739 feet of water.

These deeper waters, which would set a decommissioning world record to date for water depths, and the necessarily larger structures provide challenges for both industry and regulatory agencies. And these challenges will

be met with a collective effort that gives consideration to the various perspectives and concerns of all interested parties.

With regard to perspectives, we see decommissioning not as a surprise, but as an integral part of each oil and gas project. The careful planning for these final phases of the projects will thoroughly address safety of operations and of the environment. The planning will be a cooperative process involving industry, regulatory agencies, and the public, to ensure that everyone's concerns are heard and addressed.

## **CALIFORNIA STATE LANDS COMMISSION MANAGEMENT RESPONSIBILITY AND RECENT DECOMMISSIONING EXPERIENCE**

### **PAUL MOUNT**

**Chief, Minerals Resources Management Division  
California State Lands Commission**

#### ***STATE LANDS COMMISSION***

- Created in 1938
- 3 Independent Commissioners
  - Lt. Governor
  - State Controller
  - Director of Finance
- Manages
  - Sovereign lands - 1 million acres
  - 1100 miles of coastline
  - 30 rivers and 40 lakes
  - School lands - 5.5 million acres

#### ***OFFSHORE FACILITIES CURRENTLY ON STATE LANDS***

- 4 Platforms
  - Emmy
  - Esther
  - Eva
  - Holly
- 6 Islands
  - 4 Thums Islands
  - Rincon
  - Belmont

#### ***MINERAL RESOURCE MANAGEMENT***

- Oil                      60,000 BBL/D
- Gas                     27,000 MCF/D
- Geothermal          5,217,000 Lb/Hour
- Mineral               220,000 Tons/Year

Cumulative \$ to date    \$6 Billion

#### ***RECENT DECOMMISSIONING***

- Chevron 4-H project
  - Hope, Hazel, Hilda, Heidi
  - Four year project
  - About \$40 million
- SWARS – Subsea Well Abandonment
  - Currently decommissioning wells and pipelines
- Belmont Island
  - Currently decommissioning wells
  - Island decommissioning in 1998

#### ***LESSONS LEARNED FROM 4-H***

- Intensive advance planning and coordination prevented accidents and minimized environmental effects
- Early and complete coordination with all involved agencies
- Provide information early to community on project
- Must understand the needs of fishermen
- Explosives can be used safely underwater with detailed engineering and environmental pre-planning
- SLC engineering staff onsite essential to timely approval of plan modifications and prevention of problems

## UPDATE ON DECOMMISSIONING ISSUES

### ELMER “BUD” DANENBERGER

Chief, Engineering and Technology Division, Minerals Management Service

#### **EXPLOSIVES HAVE PROVEN TO BE SAFE AND EFFECTIVE**

- Used in 70% of removals
- Not diver dependent
- Mitigations have minimized the risk to turtles and dolphins

#### **WHY 15 FEET?**

- Proven to be effective in preventing seafloor obstructions
- Allows margin for error
- Reduces operator’s liability risk
- District Supervisor may adjust

#### **THREE-FOOT REMOVAL DEPTH MAY BE RISKY**

- 3-5 feet scour potential in water depths less than 30 feet
- Bottom conditions affect removal depth measurements

#### **SERIOUS CONCERNS ABOUT OBSTRUCTIONS**

- Any exposed casing stubs or pilings could remain in place for 100+ years
- Thousands of trawling vessels work in the Gulf

#### **PIPELINE BURIAL TO 3 FEET HAS NOT ALWAYS PROVEN TO BE SUFFICIENT**

- *Hurricane Andrew:*
  - *9+ pipeline segments were exposed*
  - *10 segments damaged by mud slides*
  - *18 segments damaged by anchor dragging*
- Shrimpers have often raised concerns about pipeline obstructions

#### **PARTIAL REMOVALS**

- Both Marine Board and Workshop support partial removals

#### **MARINE BOARD AND WORKSHOP RECOMMENDED CHANGES IN MITIGATIONS**

- Develop guidelines for determining the size of explosive charges
- Remove the limit on the number of detonations at any one time
- Shorten the observation time to 24 hours before the blast



**MARINE BOARD AND WORKSHOP  
RECOMMENDED MORE STUDIES**

- Turtle detection and scaring devices
- Compare natural reefs and oil and gas platforms
- Advanced explosive and non-explosive removal technology
- Consider deep-water pipeline abandonment procedures
- Evaluate the reef effect associated with deep-water platforms
- Evaluate the habitat value of structures in cold water environments
- Determine the water depth profile for fish killed by explosives
- Consider the effects of platform size on fish attraction
- Evaluate platform disposal options

**INTERNATIONAL CONVENTIONS**

- London Convention of 1972 (LC)
- International Maritime Organization guidelines

**LESSEES ARE RESPONSIBLE FOR  
ALL LEASE ABANDONMENT COSTS**

**STATUS OF STRUCTURE ON THE  
OCS  
Age and Water Depth  
August 1997**

**Rigs to Reefs**

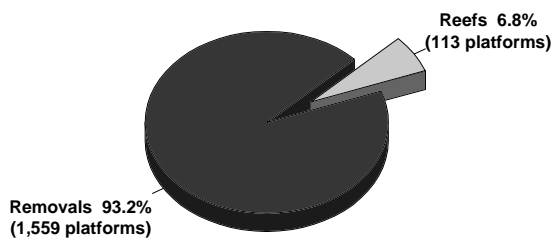

As of August 1997

Existing OCS Structures by Age

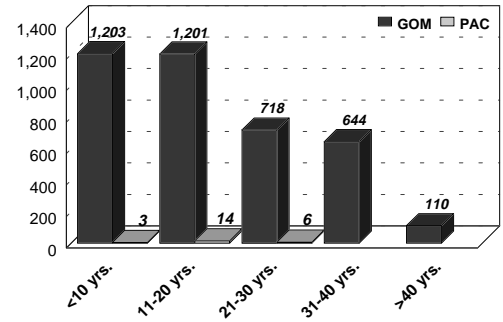

Existing OCS Structures by Water Depth

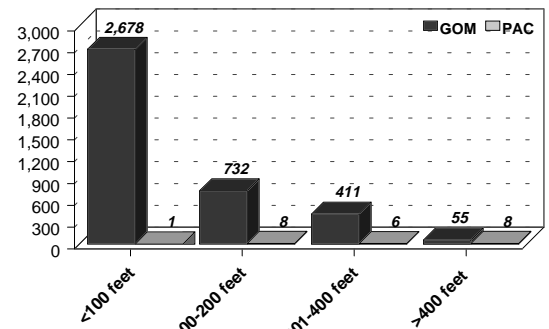

Structures Removed by Water Depth

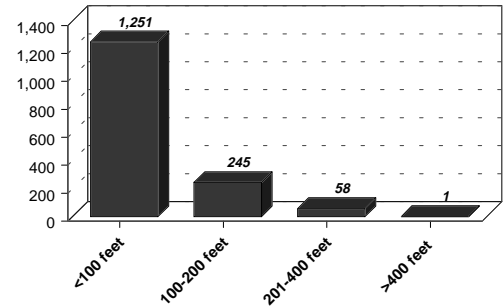

Structures by Age at Time of Removal

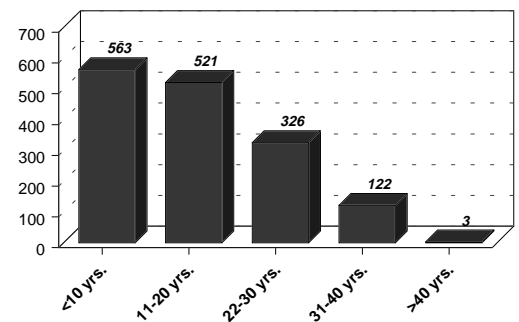

## **CALIFORNIA STATE LANDS COMMISSION: DECOMMISSIONING POLICY AND REGULATIONS**

**DWIGHT E. SANDERS**

**Chief, Division of Environmental Planning & Management  
California State Lands Commission**

As we prepare for the approaching decommissioning and removal of additional structures, both offshore and onshore, we should recall that California is no stranger to oil and gas development. The area of Ojai was the site of an oil discovery in 1857 and oil was discovered on the coast of Ventura County some years later.

In 1890, gas was discovered within the limits of Summerland in Santa Barbara County and a few years later, in 1894, oil was discovered in Summerland very near to the sea. By 1896, Summerland hosted the first offshore oil and gas development – wooden piers and platforms began to appear along the area's beaches and shoreline. I am sure that most of us at one time or another have seen pictures of the developments that changed a popular swimming area into a forest of derricks.

By 1920, most pumping activity in the wells was finished and the industry moved on to more productive prospects, as in the gold rush, the area was abandoned by man but his structures remained. During the next 50 years, these decaying facilities were a constant reminder of man's "What me worry" philosophy.

The vistas of the offshore area of the county of Santa Barbara began to change in the summer of 1988 with the abandonment and removal of platforms Helen and Herman from State waters. I can still use these terms here since as far as I can determine, decommissioning was not substituted for abandonment until 1996 at the 'International Workshop on Offshore Lease Abandonment and Platform Disposal' in New Orleans.

By August 1997, four more platforms, Hope, Hazel, Hilda, and Heidi, were removed from the State waters offshore Santa Barbara County. We are still dealing with some aspects of this project, the circumstances of which I am sure

you will hear more of both within and without the context of this workshop.

What has changed since the specter of Summerland? For one, the California State Lands Commission was created by the Legislature in 1938 and given the responsibility for the management, development and extraction of mineral resources located on State sovereign tide and submerged and State school lands. The State's sovereign offshore tide and submerged lands are those generally located from the mean high tide line to three nautical miles seaward.

The Commission's oil and gas leases, predominately issued in the fifties and sixties, contain the following language: "At the expiration of this lease or sooner termination thereof, the lessee shall surrender the premises leased, with all improvements thereon, in good order and condition, or, at the option of the State and as specified by the State, the lessee shall remove such structures and fixtures as have been put on the leased land by the lessee and otherwise restore the premises, all removal and restoration costs to be borne by the lessee, subject to the lessee's right to remove his equipment as provided in the statutes. Notwithstanding any provision of this lease, the lessee shall have the right to remove any oil drilling and producing platforms and other oil field development and producing equipment having a re-use or salvage value."

You can tell from the construct of this language that our attorneys were not paid on the basis of the number of periods used.

To date, the Commission has encouraged the removal of platforms rather than some form of abandonment in place. A Spring 1996 article in "Underwater Magazine" by Ross Saxon, Ph.D. entitled, 'Offshore Lease Abandonment and Platform Disposal, A Status Report' opines that

the removal of a platform involves five distinct steps:

1. Obtaining necessary permits and approvals, observed to be a complex, time consuming and difficult job of which I am sure Simon will inform us later
2. Plugging the well
3. Decommissioning, defined as ridding the platform of hydrocarbons
4. Removing the platform
5. Clearing the site

The Commission's lease terms, statutory authorities and responsibilities, and regulations governing the "decommissioning and removal" of oil and gas facilities offshore are augmented by the provisions of the California Environmental Quality Act or CEQA. Through the CEQA process, a project's potential adverse impacts on the environment are identified and analyzed. If any of these impacts are found to be significant, mitigation requirements are developed to avoid, substantially lessen or eliminate such impacts. Once adopted by the Commission, such mitigation is implemented by a Mitigation Monitoring Program administered by the Commission.

The CEQA process also provides opportunities for the public, public interest groups, other maritime user groups, and federal, state and local agencies to review and provide comments

on the project and its environmental documentation.

Within the context of the Commission's experiences in 1988 and 1997, the process has certainly encouraged debate and discussion, but little consensus on major issues affecting facility decommissioning and disposition. For instance, who will accept liability if some or all of a structure remains in place; or, what portion of a structure could, by itself or with augmentation, function as an artificial reef?

To heighten the challenge, the issues have issues. For example, do artificial reefs nurture marine life or merely attract it and in either case do they place marine life at a disadvantage with respect to sport or commercial fishing activities? Which fishing interests should prevail, sport or commercial? Which environmental perspective should govern, that which advocates the use of offshore structures for artificial reefs or that which holds that no such disposition should occur since such reefs could pose potential harm to fishing operations?

Unfortunately, I cannot wrap this up with "Have I got a deal for you." I do hope, however, to learn from the discussions planned in this workshop and from you, the participants. Thank you for the opportunity to do both.

# REGULATORY FRAMEWORK AND ENVIRONMENTAL REVIEW PROCESS FOR THE DECOMMISSIONING OF OIL AND GAS FACILITIES

**SIMON POULTER**  
Principal  
Padre Associates, Inc.

## Lead and Key Agencies

- Lead Agencies
  - Minerals Management Service
  - Army Corps of Engineers
  - State Lands Commission
  - County or City Governments
- Other Key Agencies
  - California Coastal Commission
  - Air Pollution Control District
  - Regional Water Quality Control Board
  - NMFS/CDF&G
  - U.S. Coast Guard

## Environmental Review Process

- National Environmental Policy Act (NEPA)
  - Environmental Impact Statement
  - Environmental Assessment/FONSI
- California Environmental Quality Act (CEQA)
  - Environmental Impact Report (EIR)
  - Mitigated Negative Declaration

## Permitting Jurisdictions

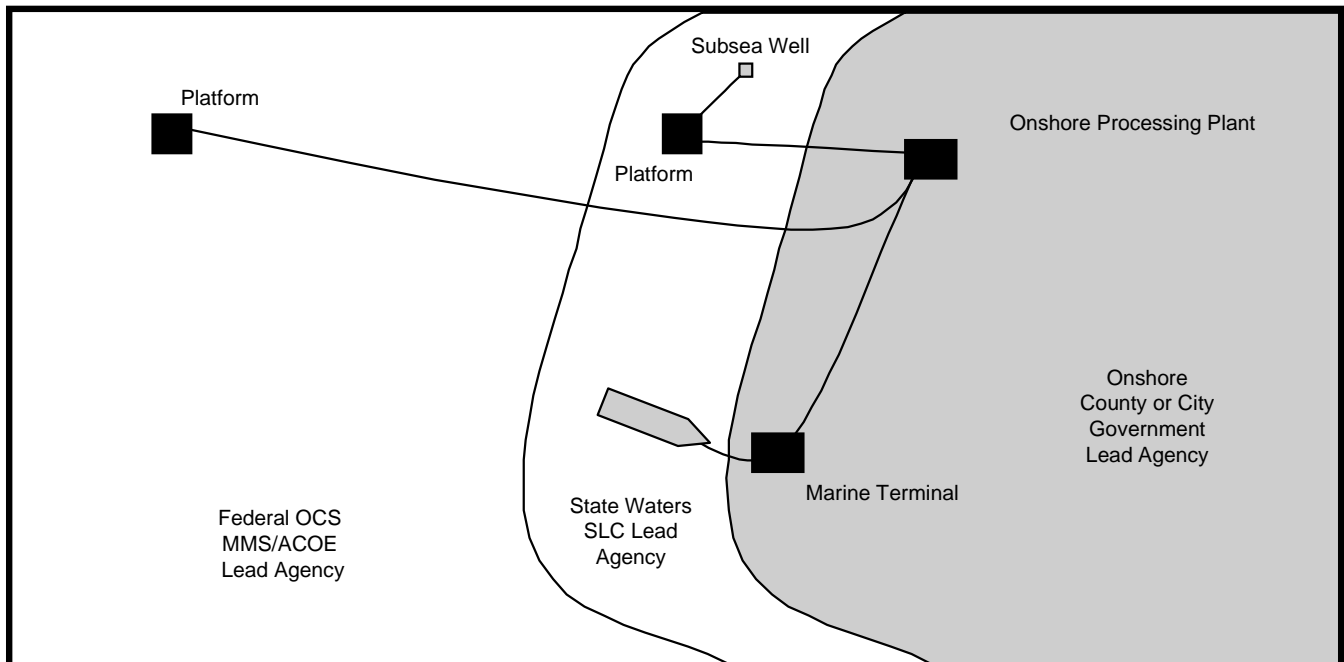

# Overview of Permitting Requirements

	Permit Requirement by Facility Location		
	Federal OCS	State Waters	Onshore - County or City
<b>Federal Agencies</b>			
Minerals Management Service			
- Lease Condition/Stipulations	●		
- Development and Production Plan	●		
- Lease Term Pipeline Application	●		
- Pipeline Right-of-Way	●		
EPA - NPDES Permit	●		
ACOE - Section 10/404 Permit	●	●	●
USCG - Aids to Navigation	●	●	
<b>State Agencies</b>			
California Coastal Commission			
- Consistency Certification	●		
- Coastal Development Permit		●	
SLC - Lease Agreement/Permit		●	
RWQCB - NPDES Permit		●	●
CDF&G - Section 1603			●
<b>County or City</b>			
Preliminary Development Plan			●
Conditional Use Permit			●
Final Development Plan			●
Coastal Development Permit			●
Misc. Permits			●
Air Pollution Control District			
- Authority to Construct	●	●	●
- Authority to Operate	●	●	●

# Major Steps in the Permitting Process

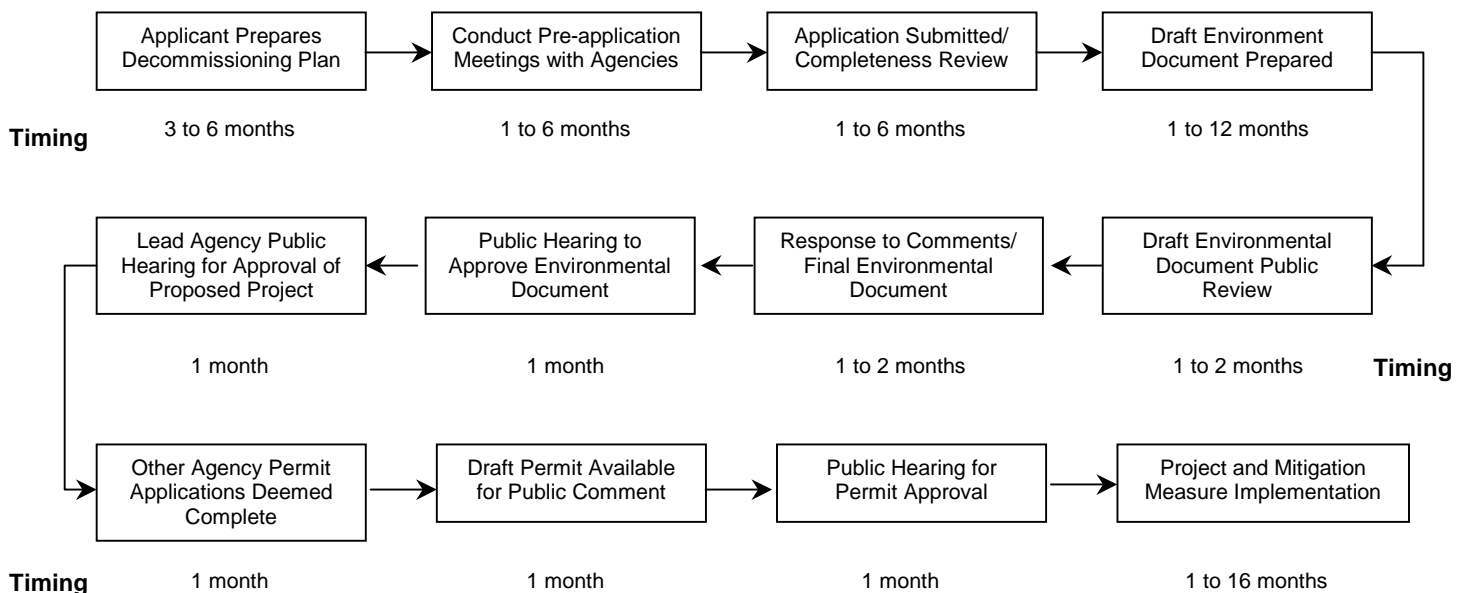

## INTERNATIONAL DEVELOPMENTS: LESSONS LEARNED AND NEED FOR PUBLIC INPUT

**W. S. (BILL) GRIFFIN, JR.**  
**Director of Special Projects**  
**Phillips Petroleum Company**

### INTRODUCTION

- Speaking about Decommissioning is only part of the equation - must listen and include feedback into decision
- No communication with the public before Brent Spar

### WORLDWIDE DISTRIBUTION OF PLATFORMS



### DISTRIBUTION

- 6500 structures in Continental Shelves of 53 countries
- Cost of total removal estimated at 35-40 billion USD
- 4000 structures in GOM cost 5 billion USD
- 400 structures in North Sea cost 12-15 billion USD

### PLATFORM SIZE COMPARISON

- Worldwide 600 larger than Shallow Water Structures
- About 50 larger than Deepwater Structures
- About 100 larger than 20 Story Building
- About 4500 smaller than 20 Story Building
- Deep Water Jacket shown weighs approximately 20,000 tonnes – Eiffel Tower weighs 7,100 tonnes

### PLATFORM SIZE COMPARISON

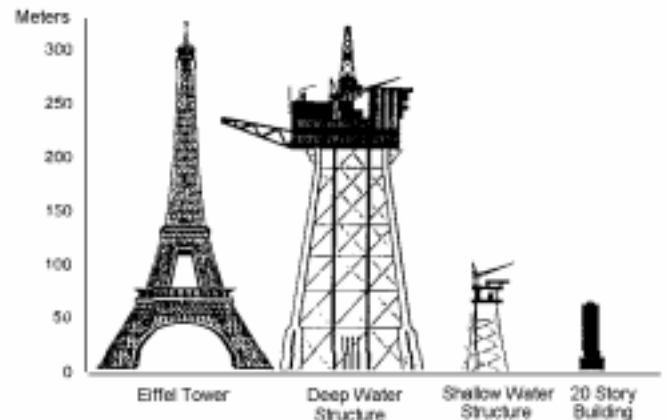

### HISTORY

- **1958 GENEVA CONVENTION – GLOBAL**
  - Set the legal framework to allow industry to explore and exploit continental shelves
  - Required total removal of platforms
- **1969 USGS - REGIONAL**
  - 1<sup>st</sup> State Practice under 1958 Geneva Convention
  - Required total removal to 15 feet below mud line and location dropped to be sure no obstruction
- **1972 – LS - GLOBAL**
  - The current authority for disposal at sea
- **1982 UNCLOS - GLOBAL**
  - Supercedes the 1958 Convention for platforms
  - Allows for competent body to set removal guidelines to ensure safety of navigation and not interfere with other users of the sea
- **1989 IMO GUIDELINES - GLOBAL**
  - Sets removal guidelines to ensure safety of navigation
  - After 1-1-98, no structure can be emplaced on any continental shelf that is not feasible to remove
- **1990 OSCOM - REGIONAL**
  - Specific guidelines for platform disposal at sea in NE Atlantic

- Must be sea disposed in at least 2000 meters of water and 150 nautical miles from level
- **1995 OSCOM MORATORIUM - REGIONAL**
  - After Brent Spar, banned sea disposal at sea in NE Atlantic
  - UK and Norway voted against, so not held to ban

## INTERNATIONAL DEVELOPMENTS

- LONDON CONVENTION
- IMO GUIDELINES
- OSPAR

### LONDON CONVENTION

- **New Protocol in 1996**
- **Precautionary Principle**  
Be sure of results before doing something
- **Polluter Pays Principle**  
The party doing the disposal pays all costs
- **Reverse List**  
1972 LC List what cannot be sea disposed  
1996 Protocol list what can be sea disposed
- **Waste Assessment Framework (WAF)**  
Procedure to follow for sea disposal
- **Will not be in force for several years.**  
**Until in force, 1972 LC Valid**

### IMO GUIDELINES

Want to have IMO Review to see if they need to be revised

Sets removal guidelines to ensure safety of navigation

After 1-1-98, no structure can be emplaced on any continental shelf that is not feasible to remove

- **Minimum Guidelines**  
Coastal State can require more removed
- **74 meters / 4,000 tonnes**  
All structures in water less than 75 meters deep and substructures weighing less than 4,000 tonnes must be removed
- **After 1-1-98 – 100 meters / 4,000 tonnes**  
All structures emplaced after 1-1-98 in less than 100 meters of water and substructures weighing less than 4,000 tonnes must be removed
- **After 1-1-98 - Design**  
Must be shown at time of installation that it is feasible to be removed – actual decision made in future when structure becomes redundant

- **Partial Removal Allowed**  
Structures not totally removed must have a minimum of 55 meters of clear water above parts remaining
- **Rigs-to-Reefs allowed**  
Structures can be converted to a new use

### OSPAR

Replace separate Oslo & Paris Conventions

Will be enforced by end of 1998

Jurisdiction in North East Atlantic

- **Five Categories**  
Sea bed completions – to shore  
Small steel – to shore  
Large steel - ?  
Floaters – to shore  
Concrete – left in place  
All structures come to shore regardless of water depth except for LARGE steel and they cannot reach agreement on definition of large steel
- **Not Agreed**  
Reverse list or prohibitive list – Will not have a reverse list or a prohibitive list to decide what disposal  
Definition of large steel – IMO definition of large steel or a more onerous definition  
Exceptions – There will always be need for exceptions to the rule  
Cut-off date – After a certain date in the future, any structure emplaced will come to shore for disposal  
Topside on large steel and concrete –  
Some topsides cannot be lifted because of design – special considerations  
Consultation Procedure – How will contracting parties give their approval?

### PIPELINES AND DRILL CUTTING PILES NOT CURRENT ISSUE, BUT WILL BE AFTER PLATFORMS AGREE

### LESSONS LEARNED

- **Decommissioning is a process not a construction project**  
Began with SPAR in 1991, removed in 1995, disposed in 1999?  
Engineering is the easy part.  
Politics is the hard part

## LESSONS LEARNED (continued)

- **Expect the unexpected**  
UK & Operator did not expect outrage  
Technical problems  
Not structural as drawing shows  
Unavailable equipment or service  
Weather
- **Time is important**  
Don't do anything until consequences are fully understood  
Don't be pushed  
Dead money spent. Only contractors have a return  
Maintaining structure may not be as expensive as thought  
New equipment may evolve
- **Not all should come ashore**  
Continue to enhance Marine Environment  
Clean seabed, but dirty atmosphere and land  
Recycled material, but not always cost efficient
- **Cost, Technology, Safety, Environment and Regulatory are important**  
ALL must be balanced
- **Public must be considered and involved**  
Prepare information for public as to what you are planning to do
- **Communicate and listen**

- **Regulatory work for Politicians**
- **Politicians elected by Public**
- **Target is where the four inter circles overlap**  
Target moves by pressure from the public

### NEED FOR PUBLIC INPUT

- **Industry beliefs**  
Bases their beliefs on Science, Technology & Economics
- **Public beliefs**  
Bases their beliefs on values and morals
- **Hazardous Risk Assessment**  
Industry performs calculation  
Public  
~ If they feel they are in control ~ SAFE  
~ If they do not feel in control ~ FEAR

### NEED FOR PUBLIC INPUT

**“IF YOU HAVE THE COURAGE TO SPEAK - YOU MUST HAVE THE DISCIPLINE TO LISTEN”**

- **SPEAK** – Give your message
- **LISTEN** – Hear public concerns
- **IMPLEMENT** – Incorporate public concerns into division or explain why not

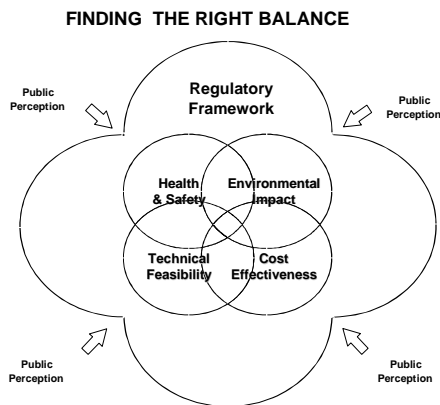

### FINDING THE RIGHT BALANCE

- **Balance Between**  
Health and Safety of workers  
Environment Impact to Land, Sea and Air  
Cost Effectiveness  
**Technical Feasibility**



---

---

## TECHNICAL SESSION

---

### **The Process of Decommissioning and Removing Offshore and Associated Onshore Oil and Gas Facilities**

The Plugging Process: Securing Old Gas & Oil Wells for the Protection of the Environment, Steve Fields and Max Martin .....	25
Offshore Production Facilities: Decommissioning of Topside Production Equipment, Dr. Peter Prasthofer .....	38
Removal and Disposal of Deck and Jacket Structures, Andy Culwell .....	48
Pipeline and Power Cable Decommissioning, Andy Culwell and Jack McCarthy .....	66
Site Clearance and Verification, Jack McCarthy .....	74
Decommissioning of Onshore Facilities: Technical Issues, Luis Perez .....	83



# THE PLUGGING PROCESS: SECURING OLD GAS & OIL WELLS FOR THE PROTECTION OF THE ENVIRONMENT

**STEVEN A. FIELDS**

Department of Conservation, Division of Oil, Gas, and Geothermal Resources  
and

**MAX M. MARTIN**

Twachtman Snyder & Byrd, Inc.

Reviewed by Members of the Technical Program Subcommittee consisting of representatives from the Minerals Management Service, California State Lands Commission, Department of Conservation, Division of Oil, Gas, and Geothermal Resources, County of Santa Barbara-Resources Management Division, League of Women Voters, Twachtman Snyder & Byrd, Inc., American Pacific Marine, Inc., and Chevron USA, Inc.

## INTRODUCTION

The waters off the coast of California contain a total of 27 oil and gas platforms. Of the 27, four are located in state tidelands (within three miles of the coast) and 23 are located in the Federal Outer Continental Shelf (OCS). There are also six artificial islands located in state tidelands. As the end of service life approaches for these facilities, plans for their decommissioning need to be developed.

The decommissioning process begins long before the cessation of production. An effective pre-planning program should be established at least two years before decommissioning the structure. Planning is the key to ensuring that the work performed will be effective, efficient, environmentally sound, and within the financial resources of the owners.

The scope of decommissioning work is defined through the coordinated efforts of platform operators and regulatory agencies who oversee the specific field involved. In California, these agencies are the Minerals Management Services (MMS), the Department of Conservation, Division of Oil, Gas, and Geothermal Resources (DOC), and the California State Lands Commission (CSLC).

## PRE-PLANNING

The key to optimizing asset value in a decommissioning project is allowing enough lead-time to properly create a strategy that allows an operator to choose the best disposal method for their property. The considerations to

be addressed when planning a decommissioning project are as follows:

### Platform/Site Evaluation

Available information regarding the site and the structure (amount of debris in the site, drawings, inspection records, etc.) will facilitate the possible sale/reuse of the platform, thus decreasing the overall liability.

### Environmental Considerations

An assessment of the environmental conditions surrounding the platform site needs to be performed, thereby informing the operator how the decommissioning operations might affect the surrounding marine ecosystem.

### Financial Strategy

The owner needs to know the current costs of decommissioning a facility (including well plugging and abandonment [P & A] costs) in order to accurately accrue them as a liability.

### Disposal Planning

Establishing a variety of potential disposal methods allows the company to derive the optimal value from the assets being removed.

### Contracting Strategy

By formulating a contracting strategy, the owner will minimize the overall costs of contracted work that will be performed during decommissioning activities.

## Regulatory Requirements

The regulatory requirements for well plugging and abandonment (P & A) in California are as follows:  
*Minerals Management Services (MMS)*

The basic plugging requirements are found in 30 CFR 250.110 Subpart G.

*Department of Conservation, Division of Oil, Gas, and Geothermal Resources (DOC)*

The basic plugging requirements are found in the California Code of Regulations Title 14 Division 2, Chapter 4 beginning with Section 1745.

*California State Lands Commission (CSLC)*

The basic plugging requirements in the California Code of Regulations Title 2 Section 2128(q).

The plugging design must meet or exceed regulatory requirements. These requirements have been developed in cooperation with industry participants through years of experience. The basic plugging requirements for all three agencies are written to have general application to all wells. In that all wells are not the same, specific procedures may be approved to fulfill these requirements.

The plugging and abandonment of offshore wells is performed by the operators of the wells with guidance provided by these regulatory agencies. In state tidelands, the DOC and CSLC directly oversee all plugging and abandonment operations. In outer continental shelf (OCS) waters, the operations are conducted under the direction of the MMS. Operators and regulatory agencies work together as a team to successfully achieve the same goals.

## Shutdown Planning

An early step in the process for decommissioning is to plan cessation of production and injection operations. The operator designs a shut down plan that will allow plugging and abandonment operations to proceed without the threat of pollution. This plan is designed to safely discontinue production and secure the platform and well until the actual P & A operations can commence.

## PLUGGING AND ABANDONMENT PLANNING

### Synthesize Information

The plugging and abandonment of wells is one of the primary stages of a facility abandonment program. An effective plugging and abandonment procedure is critical for the proper sealing of an oil and gas wellbore to safely secure it from future leakage. Techniques used to accomplish this process are based on industry experience, research, and conformance with applicable regulatory compliance standards and requirements. The synthesis of practical knowledge, current technology, and regulatory requirements results in the most effective wellbore plugging and abandonment possible. Only by planning ahead can this occur.

When an operator determines a need to plug and abandon wells on a given facility, they begin with a review of the existing well design along with records of past work, well past performance, and geological and reservoir conditions. The operator investigates all items that may relate to health and safety issues as well as regulatory requirements. The operator then designs a program based on reservoir and existing wellbore conditions. This will allow the operator to plan an abandonment program that will satisfy the goal of making the wells safe from future leakage and preserving the remaining natural resources.

### Inspection and Testing

A preliminary wellbore / wellhead inspection and survey should be performed to document present conditions. All of the valves on the wellhead and tree are checked to ensure operability; if not, they will be hot-tapped.

A slickline unit is then installed to check for wellbore obstructions, to verify measured depths, and to gauge the internal diameter of tubing. The slickline unit is also used to pull safety valves as needed. A slickline unit is a machine with a hydraulically controlled spool of wire used for setting and retrieving safety valves, lugs, gas lift valves, and running bottom hole pressures. Slicklines are also used for a variety of other jobs such as recovering lost tools and swedging out tubing.

The slickline unit is then removed and a well service pump is installed to fill annuli and tubing with fluid to establish an injection rate into perforations and/or to pressure up tubing and casing to check for integrity. Casing annuli are also pressure tested to check for communication problems between casing strings and to record test pressures over a period of time.

## Well Containment Plan

The operator must design a well containment plan. This plan includes determining the current reservoir condition and includes establishing contingency responses to events that may occur while working on the well.

Anytime work is performed on a well, there is a chance that something might go wrong. However, proper planning and use of appropriate safety equipment can reduce the potential for problems.

An important piece of equipment on the wellbore is the blowout prevention equipment (BOP). If the well head tree is to be removed, back-pressure valves are first installed, followed by removing the tree and then installing the BOP(s). The purpose of the BOP is to be able to close down and control the well in the event of a well flow. Prior to commencing downhole operations, the components of the BOP are function tested and then pressure tested to ensure that all components are in good working order. These tests are sometimes witnessed by representatives of the MMS (for federal waters) and/or the DOC (in state tidelands).

## WELL ABANDONMENT

### Basic Methods for P & A

The plugging and abandonment of offshore wells worldwide has been accomplished utilizing three different P & A methods: **Rig**, **Coil Tubing Unit**, and **Rigless**.

#### *Rig*

A rig is the derrick or mast, drawworks, and attendant surface equipment (circulation system, rotating equipment, hoisting system, well control equipment, power system, pipe and handling equipment, and any additional heavy equipment required) of a drilling or workover unit. The rig is powered by gas generators or diesel engines and has a basic crew of five to six men. This type of

equipment is either a small workover rig that is brought to the site or an existing drilling derrick that is already onsite. The rig must have the rated capacity to pull the downhole equipment out of the wellbore (including casing if necessary). Using a rig to P & A a well proceeds much like a normal workover on a well.

Before working on the well, fluid is either pumped into the wellbore or circulated to eliminate any pressures that might be present. Usually back pressure valves are usually installed in the well and the tree or wellhead is removed, after which the blowout prevention equipment is installed. After testing the BOP, the tubing is pulled and the pre-planned plugging procedure for the well is followed. Well plugging will usually require a minimum of three cement plugs to control migration of fluids (gas and oil) and protect fresh water sands. If necessary, rigs have the ability to pull tubing, cut and pull casing, recover scrap, set packers or retainers, and to drill out retainers in the well.

#### *Coil Tubing Unit (CTU)*

These are small units that carry tubing coiled around a large drum. In the mid-1980's, the coil tubing operations were limited to sand cleanouts and nitrogen jet services. However, recent advances have made CTU's useable in production and abandonment operations. The units are much like rigs in that they have pumps to circulate fluid and test BOP's (on a more limited scale). Coil tubing has been successfully used to P & A wells in the North Sea, the Gulf of Mexico, Southeast Asia, and the Middle East. Today's CTU's have the ability to perform almost any type of well P & A task that arises. Contemporary units operate with 10,000 psi and come in sizes up to 2.5 inches (ID) or larger. In addition, a 15,000 psi unit has been developed.

Offshore California plugging and abandonment operations using coil tubing has, to date, been limited to use on the Rincon Piers.

#### *Rigless Abandonment*

Rigless P & A involves several steps. First, a cementing unit mixes and pumps cement batches through the tubing placed in the wellbore. This results in the placement of the first and second (of at least three) cement plugs at different depths. Wireline and electric line units assist with the placement of the two

cement plugs. The P & A crew verifies the top of cement plugs by tagging it with the slick line units and pressure testing the top of the plugs. This method is used on both the initial and secondary plug. Afterwards, the platform crane, or a portable crane, is used to remove the very top portion of tubing from the hole. The crew then pumps the third cement plug. Well casings are cut below the sea floor with an electric line and/or an abrasive cutter, mechanical cutter, or other method. The casing is then pulled by casing jacks and/or a crane.

In the final examination of each plugged and abandoned well, there are no differences in the results of rig versus rigless methods (Figures 1-4). Step one shows two identical wells that will be plugged and abandoned with each method. Step two shows these wells after the bottom plugs have been set with the tubing having been pulled out of the well. Step three shows the balanced cement plug with the rigless method and the spotted cement plug with the rig method.

It is important to remember that with the rigless method the tree is still on, while the rig method uses BOP's which have to be tested. Figure 4 shows the rigless method having cut the production casing with a CIBP (cast iron bridge plug) set with 200+ feet of cement on top. The rig shows the same with a little more casing out of the hole.

Figure 1. Typical Wellbore Schematic.

**Well P&A -  
Rig vs.  
Rigless**

**Step 1**

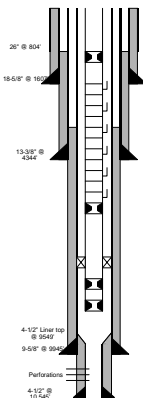

Figure 2. Bottom plugs set with tubing pulled out of hole.

**Well P&A -  
Rig vs.  
Rigless**

**Step 2**

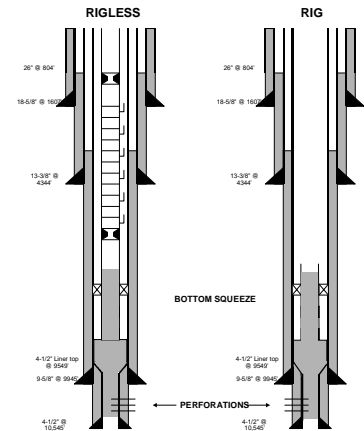

Figure 3. Balanced plug on rigless and stopped plug with the rig.

**Well P&A -  
Rig vs.  
Rigless**

**Step 3**

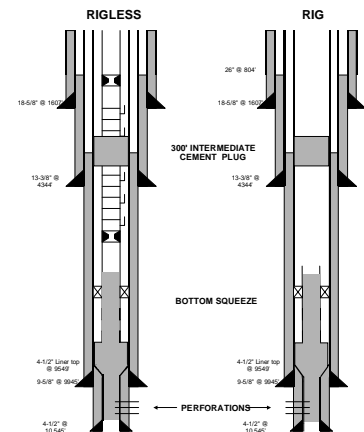
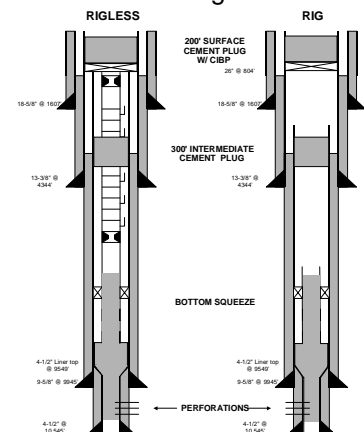

Figure 4. Rigless with cut casing and CIBP; Rig with same but with a little more casing out of hole.

**Well P&A -  
Rig vs.  
Rigless**

**Step 4**



At present, approximately five hundred wells per year are plugged and abandoned in the Gulf of Mexico (GOM) using the rigless method, as opposed to the 100-120 plugged and abandoned in the GOM using rigs. Acceptance of the rigless

method (the primary form of well P & A used in the Gulf of Mexico) has been expanded to North Sea operations to include both platform wells and subsea wells.

Although rigs have traditionally been used to plug and abandon subsea wells, several contractors in the North Sea region have experience using a diving support vessel and/or a dynamic positioning vessel for the procedure. Based on research regarding actual North Sea jobs, 3.6 days is the average time to plug and abandon non-problem subsea wells using the rigless method.

## Basic Steps for Well P & A

### *Remove Downhole Equipment*

In certain areas, like offshore California, the first step that is necessary for well P & A is the removal of the downhole equipment. This is accomplished by using a conventional workover or existing drilling rig that has the rated capacity to pull the downhole equipment from the wellbore. The operator is required to make a diligent effort to remove all downhole equipment. This includes items such as packers, production tubing, gas lift mandrels, and downhole pumps. Past work records on the well may be reviewed to determine if the effort has been made prior to commencing P & A operations. However, due to age and the conditions downhole, it is not always possible to retrieve all downhole equipment. Some of the equipment may be stuck in the wellbore due to scale, fill, or breakage. In any case, all downhole production or injection equipment that cannot be removed can be left in the well if approved by the appropriate agencies.

### *Wellbore Cleanout*

After the downhole well equipment has been removed, a concerted effort must be made to remove the fill, scale, and other debris covering perforations that have not been previously plugged. The circulating fluid used to clean out the wellbore is required to have a sufficient density to control subsurface pressure and should have physical characteristics capable of removing the unwanted material. Additional tools or additives may be necessary to properly clean the wellbore.

### *Cement Plugging Methods*

A cement plug is a volume of cement designed to fill a certain length of casing or open hole and

provide a seal against vertical migration of fluid or gas. There are various methods in which to place cement in the wellbore. The method used is dependent on wellbore conditions and regulatory requirements. Cement is pumped into the well (as a fluid) and placed in the desired location. Due to heat and pressure, through time (a number of hours) the cement hardens.

Plugging procedures throughout the world require a minimum of three (3) cement plugs. The first is usually the squeezing of the old producing zone to eliminate the influx into the wellbore of any fluid or gas. The second, middle plug, is usually placed near the middle of the wellbore or near a protective pipe shoe. Finally, the surface plug is installed within 200-300 feet below the mudline. Most plugs are 100 to 200 feet in length. Additional plugs are installed based on actual wellbore conditions.

### Squeezing

Squeeze cementing is the most common method for plugging reservoirs. Squeeze cementing is also used in plugging and abandonment operations to place cement below "junk" that may be left in the wellbore or to get cement outside of previously uncemented (or poorly cemented) casing.

Common types of cement squeezes are the braidenhead method and the bullhead method. The braidenhead method is when cement is placed in a fashion similar to the balance plug method (see below), but then the well is shut-in and additional pressure is placed at the surface from the casing valve to force the cement further down the wellbore. The bullhead squeeze is cement pumped from the surface and forced down the wellbore by pump pressure from the surface.

### Balance Plug/Displacement

This method is used for middle plug placement. The cement slurry is pumped down pipe, coiled tubing, workstring, or production tubing until the cement level outside the pipe is slightly below the top of cement (TOC) inside the pipe. The cement then falls out of the pipe, filling the void left as the pipe is slowly removed. Fluid spacers can be used both ahead and behind the cement slurry to aid in the proper placement of the cement.

### Dump Bailer

The dump bailer is a tool that contains a measured quantity of cement that is lowered into the wellbore on a wireline. The bailer is opened on impact (i.e. striking a bridge plug or cement retainer, etc.) or by electronic activation. This method is limited by the volume of cement that can be placed and by the depth at which placement can occur. However, the dump bailer method does have the advantage of accurate placement of small quantities of cement (i.e., 10 to 60 feet). In state tidelands this method of placing may not meet regulatory requirements, while in federal waters no specific regulations prohibit this method of placing cement plugs (when placed in conjunction with cast iron bridge plugs).

### Cement Grade and Quality

In state waters the grade and quality for the type of cement must meet standards defined by the American Petroleum Institute (API). API defines a competent cement plug as one that maintains a compressive strength of at least 1,000 pounds per square inch (psi) and a maximum liquid permeability of 0.1 millidarcy (md). The operator must have evidence that the proposed cement grade meets the minimum standards. All major cementing companies and P & A contractors use API cement. All cement grinds (batches of cement) are purchased with specification sheets showing the properties of the mixture. They also have the American Society for Testing and Materials (ASTM) C-150 Standard specifications for Portland cement explained on the same sheet (**Table 1**).

API cement comes in different classes which are based on the temperature downhole where the cement is to be placed. Cementing operations normally call for pumping in a fluid (which is the volume of the pipe depth plus 10 or more barrels) before the cement is started so that the cement will reach the desired location. After the desired amount of fluid has been pumped in, the cement is started. This procedure reduces the temperature near the wellbore (or wherever the cement is supposed to go), thereby causing a need for calculating the bottom hole temperature (BHT) when the cement arrives at the targeted depth. Some operators run lab tests on the cement before using it in the field to verify these calculations, but in doing so it is important to

remember to gather a sample of the mix water to be used (in the field) and include it in the lab test sample.

As there are many types of cements used in the plugging and abandonment of wells, the operator designs the cement slurry with three items in mind: 1) meeting the API definition for a competent cement plug; 2) meeting API recommended practices as detailed in API Spec 10; 3) creating a mixture that will perform the job in the most efficient manner.

### *Mud Program*

All portions of the well not plugged with cement are to be filled with a fluid having a sufficient density to exert a hydrostatic pressure in excess of the greatest formation pressure in the intervals between plugs. The purpose of this fluid is to control any possible influx of formation fluids (water, oil, or gas) into the wellbore. State and federal regulations differ somewhat in the fluid that is to be placed in the intervals between plugs.

In state tidelands, the fluid must be inert, the density of the fluid must exert a hydrostatic pressure exceeding the greatest formation pressure in the intervals between plugs encountered during drilling, and the fluid must have the proper characteristics to suspend the weight material in the fluid. Excessive mud weight can be detrimental in produced or depleted wells. If produced zones are pressure-depleted or below normal pressure, excess mud density can cause a leak-off and result in the loss of well control fluid.

Federal regulations require that the fluid only have the proper density to exert a hydrostatic pressure exceeding the greatest formation pressure in the intervals between plugs at the time of abandonment.

The fluid that is used to fill all portions of the well not plugged with cement can either be mixed on-site or can be used drilling mud or completion fluid brought from drilling or completion operations (if said fluid is reconditioned). Old mud that has not been run through and cleaned is not usable for containment purposes in the wells being abandoned.



**Table 1**  
**BASIC CEMENTING MATERIALS**

A basic cementing material is classified as one that, without special additives for weight control or setting properties, when mixed with the proper amount of water, will have cementitious properties. This may be a single ingredient or a combination of two or more ingredients, but they are always used in this combination of two or more ingredients, but they are always used in this combination even when special additives are used with them. The following are of this class:

Portland Cement	Pozmix Cement
High Early Cement	Pozmix 140
Retarded Cement	

**API CLASSIFICATION FOR OIL WELL CEMENTS\***

- Class A: Intended for use from surface to 6,000 feet (1830 m) depth\* when special properties are not required. Available only in ordinary type (similar to ASTM C 150, Type I).\*\*
- Class B: Intended for use from surface to 6,000 feet (1830 m) depth, when conditions require moderate to high sulfate-resistance. Available in both moderate (similar to ASTM C 150, Type II) and high sulfate-resistant types.
- Class C: Intended for use from surface to 6,000 feet (1830 m) depth, when conditions require high early strength. Available in ordinary and moderate (similar to ASTM C 150, Type III) and high sulfate-resistant types.
- Class D: Intended for use from 6,000 feet to 10,000 feet (1830 m to 3050 m) depth, under conditions of moderately high temperatures and pressures. Available in both moderate and high sulfate-resistant types.
- Class E: Intended for use from 10,000 feet to 14,000 feet (3050 m to 4270 m) depth, under conditions of high temperatures and pressures. Available in both moderate and high sulfate-resistant types.
- Class F: Intended for use from 10,000 feet to 16,000 feet (3050 m to 4880 m) depth, under conditions of extremely high temperatures and pressures. Available in both moderate and high sulfate-resistant types.
- Class G&H: Intended for use as a basic well cement from surface to 8,000 feet (2440 m) depth as manufactured or can be used with accelerators and retarders to cover a wide range of well depths and temperatures. No additions other than calcium sulfate or water or both, shall be interground or blended with the clinker during manufacture of Class G or H well cement. Available in moderate and high sulfate-resistant types.

\* Reproduced by permission from API Spec. 10 "API Specification for Materials and Testing for Well Cements." Depth limits are based on the conditions imposed by the casing-cement specification tests (Schedules 1, 4, 5, 6, 8, 9) and should be considered as approximate values.

\*\*ASTM C 150: Standard Specification for Portland Cement. Copies of this specification are available from American Society for Testing and Materials, 1916 Race Street, Philadelphia, PA 19103.

### *Verification and Pressure Testing of Plugs*

#### Tagging TOC (Top of Cement)

All cement work is handled using calculated cement volumes to achieve the appropriate TOC.

The two methods most commonly used to ensure proper cement plug placement are: 1) use open-ended pipe to tag the plug (having previously measured the pipe and using that measurement as a point of reference); 2) use wireline tools to tag the plug and determining the TOC by looking at the counter on the wireline.

#### Pressure Testing Method

The pressure testing of the integrity of each cement plug by tagging it with open-ended pipe (as required by governmental regulations) has both positive and negative points:

- Pressure is exerted only on cross sections of the working pipe. This concentrates loads on the area where the pipe touches the cement;
- Reliance on the weight indicators may or may not be accurate at 15,000 psi;
- Shallow plugs might not have enough pipe weight to test;
- When using pipe weight, buoyancy factors and friction from the pipe against the casing must be taken into consideration.

Testing with pump pressure for integrity (as required) also has both positive and negative points:

- Pressure is exerted uniformly on the entire area of the plug;
- Pump pressure can be checked more accurately;
- A recorder can be installed, allowing the pressure to be recorded over time;
- Pressure is in addition to the hydrostatic pressure already on the plug;
- Individual portions of the plug cannot be tested.

#### Swab Testing Method

Swabbing is another method for pressure testing cement plugs. The wellbore fluid is swabbed down until the hydrostatic fluid above the plug is below the reservoir pressure gradient of the zone isolated by the plug. The fluid level is monitored for a reasonable time to ensure that the wellbore fluids have stabilized. If the fluid level has not changed, plug competency is considered verified. It should be noted that this method is used exclusively in California.

Certain particulars about the swabbing method should be reviewed. They are:

- There is the possibility of running coil tubing in the hole where displacement occurs using nitrogen. This has the same effect as swabbing;
- Swabbing requires more time than other methods;
- The cement plug could weaken when differentially tested, resulting in possible failure at a later date when fluid is reintroduced on top of the plug;
- Accurate measurements of bubble rise rates are difficult to determine when using the swabbing method.

## **CONCLUSIONS**

By referring to past decommissioning projects and following guidelines set by regulatory agencies, a formal decommissioning plan can be developed which includes effective and efficient methodologies for plugging and abandoning wells. Although well P & A is generally considered one of the more sensitive portions of the decommissioning process, thorough pre-planning significantly reduces the number of associated uncertainties.

## REFERENCES

- American Petroleum Institute. 1993. Environmental Guidance. *Well Abandonment and Inactive Well Practices for U.S. Exploration and Production Operations*. API Bulletin E3. Washington, D.C.
- Amoco Corporation Worldwide Engineering & Construction. June 1997. *Gulf of Mexico Case Studies: Current and Further Developments in Decommissioning*. IBC Decommissioning Conference. Aberdeen, Scotland.
- California Division of Oil, Gas, and Geothermal Resources. 1997. *California Laws for Conservation of Petroleum and Gas*. DOC Pub. No. PRC01. Sacramento, CA.
- California Division of Oil, Gas, and Geothermal Resources. 1997. *California Code of Regulations, Title 14*. DOC Pub. No. PRC04. Sacramento, CA.
- Fields, Steve. March 1994. *Abandonment and Removal of Offshore Oil and Gas Facilities: Education and Information Transfer: Well Abandonment*. Santa Barbara, CA.
- Griggs, Mary. March 1994. *Abandonment and Removal of Offshore Oil and Gas Facilities: Education and Information Transfer: Overview of the Regulatory Framework and Environmental Review Process for Offshore California*. Santa Barbara, CA.
- Halliburton Company. 1995. *Cementing Tables-1995*. Duncan, OK.
- IBC Conference. Dec 1996. *Well Plugging and Abandonment*. Houston, TX.
- Journal of Petroleum Technology. May 1996. *Coil Tubing Technologies Update*.
- Journal of Petroleum Technology. June 1997. *Coil Tubing Applications*.
- Journal of Petroleum Technology. August 1997. *Cementing Operations*.
- Smith, Jack L. 1993. *Problems Associated with Coiled Tubing Operations During Well Abandonment*. California Division of Oil, Gas, and Geothermal Resources (unpublished study).
- World Oil. March 1997. *C-1 Cementing*.
- Wygle, Peter R. 1995. *Blowout Prevention in California*. California Division of Oil, Gas, and Geothermal Resources Pub. No. MO7. Sacramento, CA.

**Minimum Cased Hole Plugging Requirements**

**State (California)**

---

1. A cement plug shall be placed opposite all perforations extending to a minimum of 100 feet above the perforated interval, liner top, cementing point, water shut-off holes or the zone, whichever is higher (1745.1[c]).
2. The location and hardness of the cement plugs must be verified by placing the total weight of the pipe string, or an open-end pipe weight of 10,000 pounds and by application of pump circulation. DOC to witness location and hardness (1745.6).
3. Inside cemented casing, a cement plug at least 100 feet long must be placed above each oil or gas zone whether or not the zone is perforated (1745.1[d]).
4. The location and hardness of the cement plugs must be verified by placing the total weight of the pipe string, or an open-end pipe weight of 10,000 pounds and by application of pump circulation. DOC to witness location and hardness (1745.6).
5. A 100-foot cement plug above the shoe of the immediate or second surface casing (1745.1 [d]).
6. The location and hardness of the cement plugs must be verified by placing the total weight of the pipe string, or an open-end pipe weight of 10,000 pounds and by application of pump circulation. DOC to witness location and hardness (1745.6).
7. A 100 foot plug across the freshwater/saltwater interface or opposite any impervious strata between fresh and saltwater zones (1745.1 [d]).
8. The location and hardness of the cement plugs must be verified by placing the total weight of the pipe string, or an open-end pipe weight of 10,000 pounds and by application of pump circulation. DOC to witness location and hardness (1745.6).
9. In the event that junk cannot be removed from the hole and the hole below the junk is not properly plugged, then cement plugs must be placed as follows (1745.2):
  - (a) Sufficient cement must be squeezed through the junk to isolate the lower oil, gas, or freshwater zones and a minimum of 100 feet must be placed on top of the junk (but no higher than the sea bed).
  - (b) If the top of the junk is opposite uncemented casing, then the casing annulus immediately above the junk must be cemented with sufficient cement to insure isolation of the lower zones.
10. Anytime casing is cut and recovered, other than for the surface plug, a cement plug must be placed from at least 100 feet below to at least 100 feet above the stub (1745.3).
11. The location and hardness of the cement plug must be verified by placing the total weight of the pipe string, or an open-end pipe weight of 10,000 pounds and by application of pump circulation. Division to witness location and hardness (1745.6).
12. No annular space that extends to the ocean floor must be left open to drilled hole below. A minimum of 200 feet of the annulus immediately above the shoe must be plugged (1745.4).
13. A cement plug at least 100 feet long must be placed in the well with the top between 50 and 150 feet below the ocean floor. All inside casing strings with uncemented annuli must be pulled from below the

surface plug. The casing must not be shot or cut in a manner that will damage outer casing strings and prevent re-entry into the well (1745.5).

14. The location and hardness of the cement plug must be verified by placing the total weight of the pipe string, or an open-end pipe weight of 10,000 pounds and by application of pump circulation. DOC to witness location and hardness (1745.6).
15. All portions of the hole not plugged with cement must be filled with a inert fluid of sufficient density to exert hydrostatic pressure exceeding the greatest formation pressure encountered while drilling such interval. DOC will test the mud to determine that it meets minimum requirements (1745.7).
16. All casing and anchor piling must be cut and removed from not more than 5 feet below the ocean floor, and the ocean floor clearing of cleared of obstruction (1745.8).

---

**FEDERAL**

---

**30 CFR SUBPART G-- ABANDONMENT OF WELLS**

250.110 General Requirements

The lessee shall abandon all wells in a manner to assure downhole isolation of hydrocarbon zones, protection of freshwater aquifers, clearance of sites so as to avoid conflict with other uses of the Outer Continental Shelf (OCS), and prevention of migration of formation fluids within the wellbore or to the seafloor. Any well which is no longer used or useful for lease operations shall be plugged and abandoned in accordance with the provisions of this subpart. However, no production well shall be abandoned until its lack of capacity for further profitable production of oil, gas, or sulphur has been demonstrated to the satisfaction of the District Supervisor. No well shall be plugged if the plugging operations would jeopardize safe and economic operations of nearby wells, unless the well poses a hazard to safety or the environment.

250.111 Approvals

The lessee shall not commence abandonment operations without prior approval of the District Supervisor. The lessee shall submit a request on Form MMS-124, Sundry Notice and reports on Wells, for approval to abandon a well and a subsequent report of abandonment within 30 days from completion of the work in accordance with the following:

- (a) **Notice of Intent to Abandon Well.** A request for approval to abandon a well shall contain the reason for abandonment including supportive well logs and test data, a description and schematic of proposed work including depths, type, location, length of plugs, the plans for mudding, cementing, shooting, testing, casing removal, and other pertinent information.
- (b) **Subsequent report of abandonment.** The subsequent report of abandonment shall include a description of the manner in which the abandonment or plugging work was accomplished, including the nature and quantities of materials used in the plugging, and all information listed in paragraph (a) of this section with a revised schematic. If an attempt was made to cut and pull any casing string, the subsequent report shall include a description of the methods used, size of casing removed, depth of the casing removal point, and the amount of the casing removed from the well.

250.112 Permanent Abandonment

- (a) **Isolation of zones in open hole.** In uncased portions of wells, cement plugs shall be set to extend from a minimum of 100 feet below the bottom to 100 feet above the top of any oil, gas, or freshwater zones to isolate fluids in the strata in which they are found and to prevent them from escaping into

other strata or to the seafloor. The placement of additional cement plugs to prevent the migration of formation fluids in the wellbore may be required by the District Supervisor.

- (b) **Isolation of open hole.** Where there is an open hole below the casing, a cement plug shall be placed in the deepest casing by the displacement method and shall extend a minimum of 100 feet above and 100 feet below the casing shoe. In lieu of setting a cement plug across the casing shoe, the following methods are acceptable:
- (1) A cement retainer and a cement plug shall be set. The cement retainer shall have effective back-pressure control and shall be set not less than 50 feet and not more than 100 feet above the casing shoe. The cement plug shall extend at least 100 feet below the casing shoe and at least 50 feet above the retainer.
  - (2) If lost circulation conditions have been experienced or are anticipated, a permanent-type bridge plug may be placed within the first 150 feet above the casing shoe with a minimum of 50 feet of cement on top of the bridge plug. This bridge plug shall be tested in accordance with paragraph (g) of this section.
- (c) **Plugging or isolating perforated intervals.** A cement plug shall be set by the displacement method opposite all perforations which have not been squeezed with cement. The cement plug shall extend a minimum of 100 feet above the perforated interval and either 100 feet below the perforated interval or down to a casing plug, whichever is the lesser. In lieu of setting a cement plug by the displacement method, the following methods are acceptable, provided the perforations are isolated from the hole below:
- (1) A cement retainer and a cement plug shall be set. The cement retainer shall have effective back-pressure control and shall be set not less than 50 feet and not more than 100 feet above the top of the perforated interval. The cement plug shall extend at least 100 feet below the bottom of the perforated interval with 50 feet placed above the retainer.
  - (2) A permanent-type bridge plug shall be set within the first 150 feet above the top of the perforated interval with at least 50 feet of cement on top of the bridge plug.
  - (3) A cement plug which is at least 200 feet long shall be set by the displacement method with the bottom of the plug within the first 100 feet above the top of the perforated interval.
- (d) **Plugging of casing stubs.** If casing is cut and recovered leaving a stub, the stub shall be plugged in accordance with one of the following methods:
- (1) A stub terminating inside a casing string shall be plugged with a cement plug extending at least 100 feet above and 100 feet below the stub. In lieu of setting a cement plug across the stub, the following methods are acceptable:
    - (i) A cement retainer or a permanent-type bridge plug shall be set not less than 50 feet above the stub and capped with at least 50 feet of cement, or
    - (ii) A cement plug which is at least 200 feet long shall be set with the bottom of the plug within 100 feet above the stub.
  - (2) If the stub is below the next larger string, plugging shall be accomplished as required to isolate zones or to isolate an open hole as described in paragraphs (a) and (b) of this section.
- (e) **Plugging of annular space.** Any annular space communicating with any open hole and extending to the mud line shall be plugged with at least 200 feet of cement.
- (f) **Surface plug.** A cement plug which is at least 150 feet in length shall be set with the top of the plug within the first 150 feet below the mud line. The plug shall be placed in the smallest string of casing which extends to the mud line.

- (g) **Testing of plugs.** The setting and location of the first plug below the surface plug shall be verified by one of the following methods:
  - (1) The lessee shall place a minimum pipe weight of 15,000 pounds on the cement plug, cement retainer, or bridge plug. The cement placed above the bridge plug or retainer is not required to be tested.
  - (2) The lessee shall test the plug with a minimum pump pressure of 1,000 pounds per square inch with a result of no more than a 10 percent pressure drop during a 15-minute period.
- (h) **Fluid left in hole.** Each of the respective intervals of the hole between the various plugs shall be filled with fluid of sufficient density to exert a hydrostatic pressure exceeding the greatest formation pressure in the intervals between the plugs at time of abandonment.
- (i) **Clearance of location.** All wellheads, casings, pilings, and other obstructions shall be removed to a depth of at least 15 feet below the mud line or to a depth approved by the District Supervisor. The lessee shall verify that the location has been cleared of all obstructions in accordance with 250.114 of this part. The requirement for removing subsea wellheads or other obstructions and for verifying location clearance may be reduced or eliminated when, in the opinion of the District Supervisor, the wellheads or other obstructions would not constitute a hazard to other users of the seafloor or other legitimate uses of the area.
- (j) **Requirements for permafrost areas.** The following requirements shall be implemented for permafrost:
  - (1) Fluid left in the hole adjacent to permafrost zones shall have a freezing point below the temperature of the permafrost and shall be treated to inhibit corrosion.
  - (2) The cement used for cement plugs placed across permafrost zones shall be designed to set before freezing and to have a low heat of hydration.

250.113 Temporary abandonment.

- (a) Any drilling well which is to be temporarily abandoned shall meet the requirements for permanent abandonment (except for the provisions in 250.112 (f) and (i), and 250.114) and the following:
  - (1) A bridge plug or a cement plug at least 100 feet in length shall be set at the base of the deepest casing string unless the casing string has been cemented and has not been drilled out. If a cement plug is set, it is not necessary for the cement plug to extend below the casing shoe into the open hole.
  - (2) A retrievable or a permanent-type bridge plug or a cement plug at least 100 feet in length, shall be set in the casing within the first 200 feet below the mud line.
- (b) Subsea wellheads, casing stubs, or other obstructions above the seafloor remaining after temporary abandonment will be protected in such a manner as to allow commercial fisheries gear to pass over the structure without damage to the structure or fishing gear. Depending on water depth, nature and height of obstruction above the seafloor, and the types and periods of fishing activity in the area. the District Supervisor may waive this requirement.
- (c) In order to maintain the temporarily abandoned status of a well, the lessee shall provide, within 1 year of the original temporary abandonment and at successive 1-year intervals thereafter, an annual report describing plans for reentry to complete or permanently abandon the well.
- (d) Identification and reporting of subsea wellheads, casing stubs, or other obstructions extending above the mud line will be accomplished in accordance with the requirements of the U.S. Coast Guard.

# OFFSHORE PRODUCTION FACILITIES: DECOMMISSIONING OF TOPSIDE PRODUCTION EQUIPMENT

**DR. PETER PRASTHOFER**

**Technical Manager**

**Offshore Decommissioning Communications Project**

## EXECUTIVE SUMMARY

The removal and disposal of topside facilities is an integral part of the overall decommissioning activity for an offshore platform. Topsides can vary significantly in size, functionality and complexity, and hence, a range of decommissioning options has been identified in technical studies. The technologies to implement them are not all equally mature and, in general, removal is a more complex operation than installation. One feature common to all options is that the facilities will need to be cleaned and all prohibited substances removed in accordance with regulations.

The environmental impact of each option has generally been shown to be small. Other aspects to be considered are health and safety and cost. Opportunities for reuse are drawing increased attention, but are limited by the costs of refurbishment of the older facilities and the evolution of stricter technical standards. Further, particularly for the larger facilities, components were generally designed for a specific set of functional requirements that may not fit the operating and processing demands of a new facility.

The diversity and range of complexity of topside facilities suggest that no one option is likely to be the most appropriate in all cases, particularly when seen in the context of the decommissioning of the total installation.

## INTRODUCTION

The purpose of this paper is to provide some background into the issues associated with the removal and disposal of the topside facilities of offshore platforms. It discusses the many aspects that have to be considered, and describes the complexities that must be taken into account in developing a plan for removal and disposal of topside facilities. Topside facilities refer to the deck supporting structure and the plant for drilling, processing and export

of oil and/or gas, and the utilities, accommodation and life support facilities.

The document addresses the key issues related to the technical state of the art, safety and environmental considerations, including energy usage, cost, and opportunities for reuse and recycling. Areas are identified where further technical or scientific studies are warranted. It is intended that discussion of these issues, the significance of which vary among different decommissioning options and different types of facilities, will lead to a better understanding of the framework within which a balance has to be achieved between the protection of the environment and safety, health, technological and economic considerations.

## DESCRIPTION AND SPECIAL CONSIDERATIONS

"Topsides", "topside facilities", or "deck" is the terminology used, sometimes interchangeably, for the facilities which include the plant for processing oil/gas and accommodation. Also included, for the purpose of this report, is the steel supporting structure, either separate or integrated with the facilities, that supports the facilities on the substructure. The steel supporting structure is sometimes called "the deck" or "module support frame".

Topsides may vary greatly in functionality and complexity, from large integrated production, drilling and quarters platforms (PDQ) with accommodation for 200-300 workers, to processing only (manned or unmanned), drilling only, quarters only, gas compression or various combinations. Topside weights range from several hundred to a few thousand tonnes in the Gulf of Mexico and the southern North Sea to over 15 thousand tonnes offshore California, and to 10-40 thousand tonnes for very large PDQ structures such as those in the northern North Sea.



The configuration or arrangement of topsides is typically dictated by the capacity of available lift vessels used for installation. Topsides may be integrated, modular, or hybrid versions thereof, as illustrated in **Figures 1, 2 and 3**, respectively.

**Figure 1.** Integrated topsides / deck.

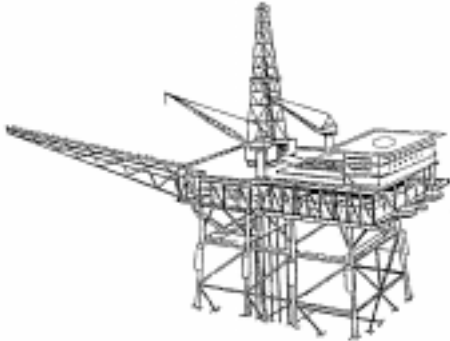

An integrated topsides refers to a system where the process facilities are installed in the deck structure in the fabrication yard and the facilities are hooked-up and commissioned onshore. The completed deck structure with the integrated facilities is then installed offshore onto the jacket or substructure. Integrated topsides are usually installed by a single offshore lift and are, therefore, limited to a weight of several thousand tonnes. A modular configuration is typically used for larger topsides where the deck structure is subdivided into modules or rectangular boxes that can be lifted by available crane vessels. The modules are supported on the jacket or substructure by a module support frame. Process facilities are yard-installed in the modules and then the interconnect and hook-up between the modules is performed offshore. Many of the very large topsides use a hybrid configuration where, in addition to the modules, process facilities are integrated into the module support frame.

**Figure 2.** Modular topsides / deck.

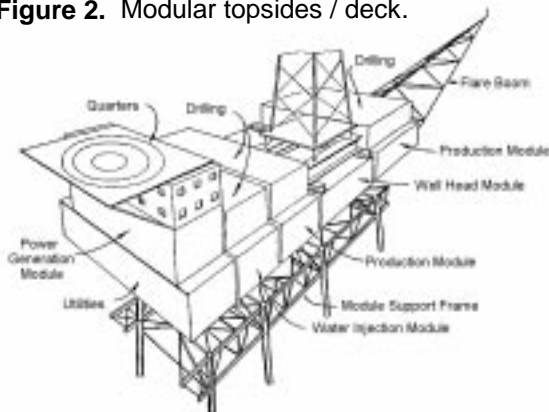

**Figure 3.** Hybrid topsides on concrete gravity-based structure.

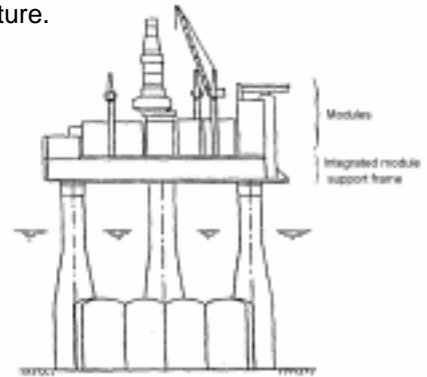

## OPTIONS FOR REMOVAL/DISPOSAL

The primary removal/disposal options are summarized in the chart in **Figure 4**. The decision as to removal options and the various disposal and reuse options will need to be made as part of the overall assessment for decommissioning of the installation. In any event, the platform will need to be cleaned and all prohibited substances removed in accordance with all regulations. Well established industry procedures are in place for this purpose (see Appendix A, p. 46).

## REMOVAL

Removal consists of removing the integrated deck or the deck modules and the modular support frame (MSF). This may be achieved by any of the following:

- Remove in one piece;
- Remove groups of modules together;
- Remove in reverse order to installation;
- Piece-small removal.

## REMOVAL IN ONE PIECE

The advantage of lifting off the topsides in one piece, as illustrated in **Figure 5**, is that it requires the least amount of work to be carried out offshore. The method requires a heavy lift crane vessel (HLV) with sufficient lifting capacity, or a large specialized decommissioning vessel. The current generation of HLV's would limit this method to topside weights in the 3 - 5000 tonne range (when safety factors and other constraints are taken into account) and no specialized decommissioning vessels have yet been fully developed or built.

Figure 4. Toppides Removal / Disposal Options

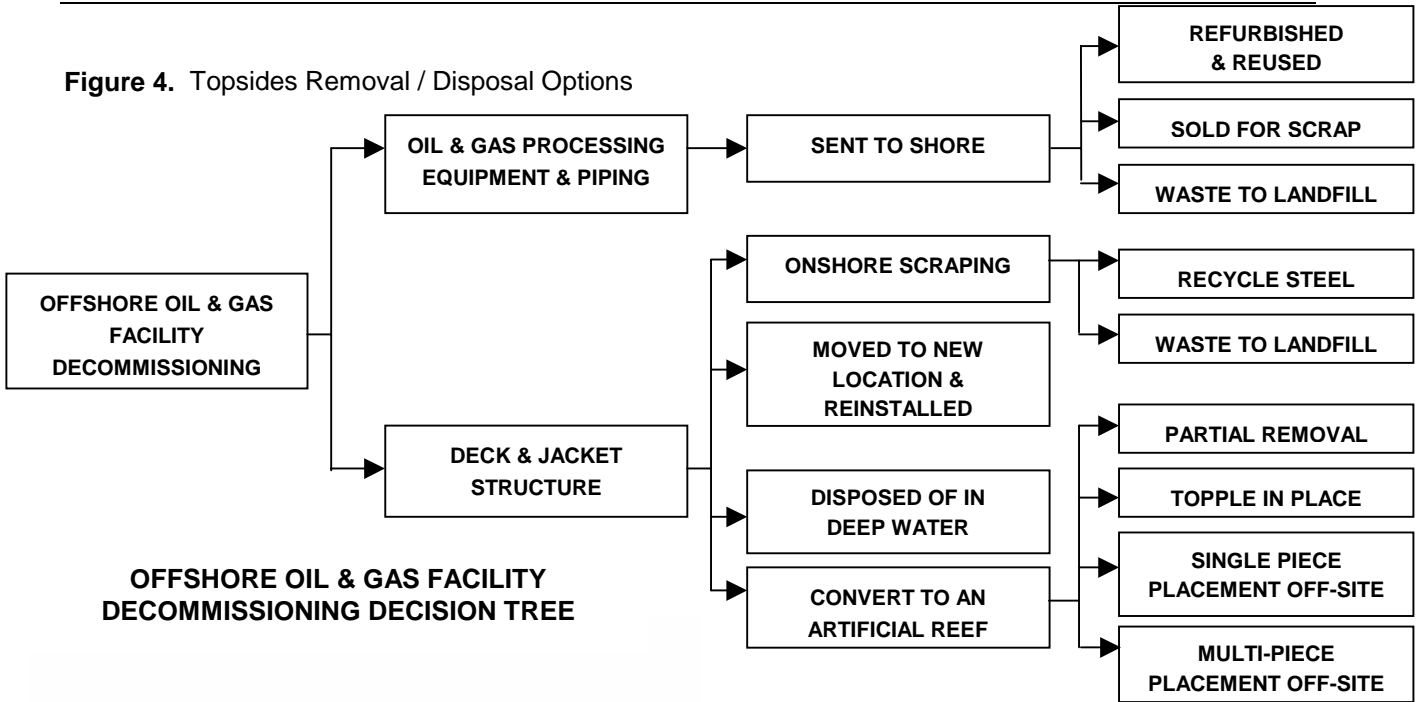
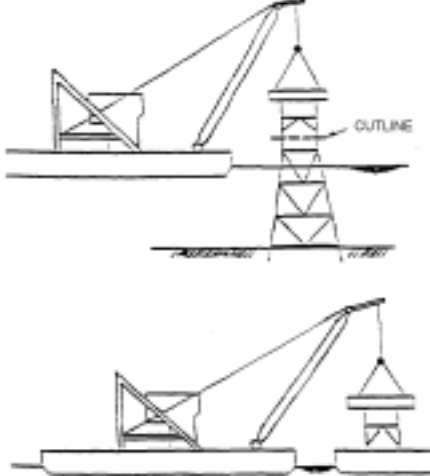

Figure 5. Removal in one piece.



One-piece removal of topsides is more practical for small platforms (e.g., the gas fields of the southern North Sea) which have topsides typically in the 1,000 to 2,000 tonne range. The larger platform decks (e.g., located offshore California in the northern sector of the North Sea) are too large to remove in one lift using a conventional HLV as the weight of some of the topsides facilities is in excess of 25,000 tonnes.

A major problem/drawback in the one-piece removal scenario is both how and where to offload the topsides onshore, particularly since onshore cranes do not have the capacity to lift large modules. Depending on the loading capacity of the quayside, it may be possible to

skid the topsides to the quayside. The other option would be to lift the topsides onto a cargo barge which could be moored alongside the quayside and the modules deconstructed on the barge itself.

**LIFTING OF COMBINED MODULES**

A recent study by an offshore contractor for the topsides of a large modular northern North Sea platform has shown that removing the topsides in groups of two to four modules at a time can be an effective option. This takes advantage of the increase in HLV capability that has occurred since the installation of the early large Northern North Sea platforms in the mid 70's. This option is illustrated in **Figure 6**. The advantage of this method is in reducing the time that heavy-lift vessels are required, since fewer lifts are necessary when compared to the reverse installation method, where modules are lifted individually.

This method, in addition to the preparations described below under Reverse Installation, needs sequencing, surveying and the fabricating and attaching of lift points as well as additional strengthening to allow for combined lifting. The position of the modules on the platform and their weight will dictate both whether or not combined removal is possible and which modules may be lifted at one time. Handling for onshore logistics will be difficult for the large units.

**Figure 6.** Lifting of combined modules.

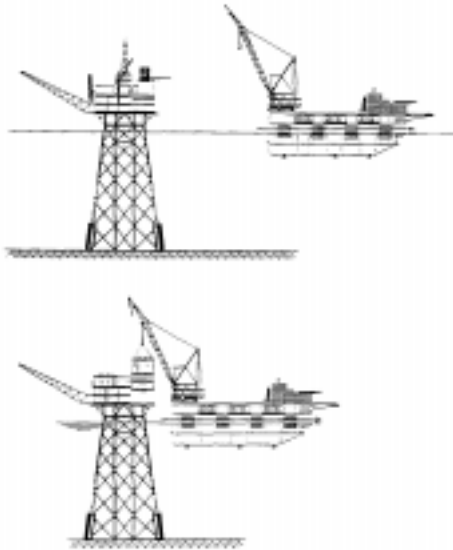

**Figure 7.** Reverse installation.

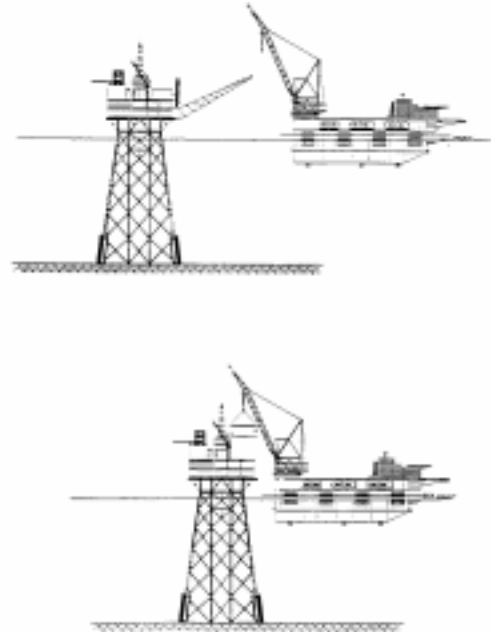

## REVERSE INSTALLATION – INDIVIDUAL MODULES

This option, illustrated in **Figure 7**, involves dismantling the topsides and deck in the reverse order in which they were installed, i.e., removing the topsides modules and deck components one at a time. Reverse installation requires the chartering of moderate capacity crane barges and/or heavy-lift barges for the larger modules. Surveys of pipework, cabling, module structures, etc. will need to be made to establish the extent of the module preparation required prior to lifting. The following measures will be necessary:

- The structural integrity of the modules would need to be checked, strengthening installed when deemed necessary, and centers of gravity of the loads established using jacking systems;
- Re-install lifting padeyes and slings or install lifting frames;
- All inter-module connections will need to be severed.

Preparation and lifting sequences will need to be planned in detail in order to maximize utilization of topside facilities such as accommodation and power and minimize the time the lifting vessel is on site.

## Piece Small Removal

Another method to remove all or part of the topsides is to deconstruct them on the platform using mechanical and other cutting devices, along with the platform cranes, temporary deck mounted cranes and/or crawler cranes. The pieces can then be loaded into standard cargo containers which, when full, can be offloaded onto a supply vessel and transported to shore. When the platform cranes need to be removed, lifting operations would revert entirely to the temporary deck mounted cranes or crawler cranes. The advantage of this method is that neither an HLV or cargo barges are required, hence offshore spread costs are substantially eliminated. (A smaller crane vessel would be required at the end of the operation to remove the deck mounted cranes). On the other hand, however, this method is time and labor intensive and hence individual circumstances for a specific platform will determine whether it is more advantageous than the other methods. Piece small removal is illustrated in **Figure 8**.

Figure 8. Piece small removal.

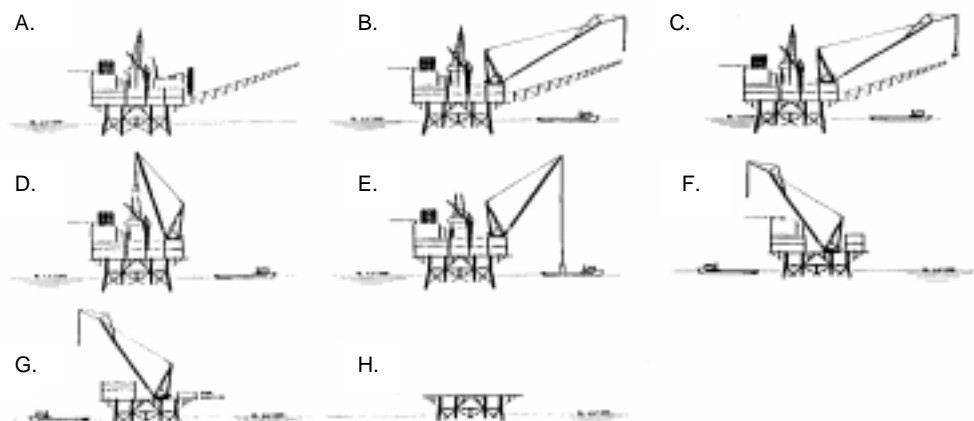

## DISPOSAL

There are three primary methods of disposal: refurbish and reuse, scrap and recycle, and dispose in designated landfills. In practice, a combination of those methods is likely to be employed, consistent with generally accepted waste disposal hierarchies. This means that to the extent that facilities or components of those facilities (such as pressure vessels and compressors, for example) can be refurbished and reused, and demand exists for this equipment, this will be the first method utilized. Whatever material or equipment cannot be refurbished or resold will then be sold for scrap and recycling, except for those elements that cannot be scrapped and recycled and hence need to be disposed in designated licensed landfills. While opportunities for reuse are drawing increased attention, there are inherent limitations in the cost of refurbishment, the evolution of stricter technical standards and the fact that, particularly for the larger facilities, many components were designed for a specific set of functional requirements that may not fit the operating and processing demands of a new facility.

In all cases, the facilities will have to be cleaned as necessary, and some materials, such as LSA, will require special handling and controlled disposal by specialized contractors. Additional information on cleaning is given in Appendix A (p. 46).

The steel support structure for the production facilities, sometimes referred to as module

support frame, may either be removed with the production facilities, or could alternatively be disposed with the jacket as an integral part of an artificial reef. This structure is purely a steel framework and does not contain any hydrocarbons or other equipment or materials.

## CONSTRUCTION EQUIPMENT AND NEW TECHNOLOGY

To-date crane barges have essentially been the only means to remove topside facilities (and jackets). These barges can be traditional offshore construction barges with lift capacities in the hundreds of tons range, to ship shape vessels in the 2 - 3,000 ton range, to the very large semi-submersible dual crane heavy lift vessels with combined lift capacity in the order of 14,000 tons. Removed facilities are typically lowered onto a transport barge to be taken to a shore facility. In some cases it can be advantageous to put the removal facilities directly on the deck of the heavy lift vessel, then using the heavy lift vessel for transport to shore.

The realization that a growing number of larger installations will have to be decommissioned in the next few years has fostered the development of alternative concepts to the use of crane barges for deck removal. These range from a system using a truss structure in combination with standard transport barges, to the evolution of unique decommissioning vessels, such as catamaran type vessels that could act in "forklift" fashion to remove and transport a complete deck. Some of these concepts are only on the

drawing board, others have had various degrees of engineering studies performed, and some, like the truss and barge system will actually be tested on a real installation in the Gulf of Mexico this year.

## EXPERIENCE TO DATE

The largest experience base with platform removal rests in the Gulf of Mexico, with some 1100 platforms decommissioned to date, although only 38 of those were in water depths over 200 feet, and none in water depths in excess of 400 feet. Toppers were typically in the 800 to 1000 ton range or less, with a maximum in the order of 3,000 tons, as compared to weights on the order of 8,000 to more than 16,000 tonnes offshore California. Of interest, however, is an established and growing market for reuse. One recent statistic claims that over the last three years, 25 percent of removed decks were stored for potential resale or reuse.

Probably the largest facility decommissioned to date is the Odin platform in 103 m (340 ft) of water in the Norwegian North Sea. The topsides consisted of 6 modules and a flare boom located on top of a module support frame. Total weight of those topsides was approximately 7600 tonnes, with three of those modules weighing over 1500 tonnes each, one just over 1000 tonnes, two in the 800 tonne range and the flare boom weighing just over 100 tonnes. The jacket weighs about 6200 tonnes. To date, the topsides have been removed and taken to shore for reuse and recycling, and part of the jacket has also been removed. The modules were removed individually (essentially reverse installation) by a heavy lift semi submersible crane barge with dual cranes, maximum lift capacity of 14,000 tonnes. They were placed on the deck of the heavy lift vessel and taken to the shore facility in two trips. Two other recently decommissioned North Sea platforms had topside facilities in the 4000 tonne range and were also taken to shore for reuse and recycling. In one case a final figure of 99.7 percent for reuse or recycling was achieved at the end of the project.

There is, however, experience also with the removal of larger individual modules in the North

Sea for platform refurbishment or upgrade projects.

## KEY ISSUES

This section describes the key technical, safety, environmental and cost issues as they relate to the various structural configurations and methods of removal and disposal.

## TECHNICAL ISSUES

In most cases, the removal of topsides is likely to be the reverse process of the installation. However, the removal process is inherently more complex than the installation process since it has to take into account modifications, both structural and through addition/deletion of equipment during the 20-30 year service life of the platform. This, together with an assessment of the structural integrity of the lifted parts, is essential to allow safe lifting operations when these topsides components (or modules) weighing several thousand tonnes are removed.

## SAFETY ISSUES

Safety issues relate primarily to personnel safety during multiple heavy lift operations. Hydrocarbon and other residues must be removed to the extent that they do not impact hot work and other operations during cutting and lifting. Structural integrity is of utmost importance to ensure safety during heavy lifts. Further, these operations are inherently more complex than during installation, especially when the removed topsides elements may need to be placed and tied down onto barges moving under the effect of sea swells. A thorough safety assessment would be required for each platform and this would be a key factor in understanding the overall balance of options.

## ENVIRONMENTAL ISSUES

These issues relate primarily to removal of hazardous material such as NORM/LSA scale, cleaning and disposal of hydrocarbon and other residues *in situ* and at the disposal site, potential for pollution at the final destination, and to the energy use (including CO<sub>2</sub> emissions) in various removal/ disposal options.

The technology for removal of hazardous material and cleaning of hydrocarbon and other residues is generally well proven (see detailed

description in Appendix A, p. 46). Technology and experience can be extrapolated and there is a good track record. Although, topsides will be taken to shore for recycling/reuse, some cleaning operations and removal of some equipment may be carried out offshore. Once onshore the potential pollutants will be disposed of in a controlled manner in licensed disposal facilities.

Energy consumption can be high for topsides removal, particularly where heavy lift vessels are required for an extended period of time.

## **COST ISSUES**

The costs associated with removal and disposal onshore of the topside facilities are significant, accounting for 30-40 percent of the total removal costs of the installation, which in the North Sea can range from the upper tens of million US dollars to 200-300 million US dollars. This compares to removal / disposal costs in the Gulf of Mexico in the order of 1-2 million US dollars for the relatively small installations removed to date.

Costs are driven by complexities discussed earlier such as strengthening to ensure structural integrity, the costs of cleaning and preparing the deck for offshore disposal, and the high cost of large-crane vessels and supporting spread and equipment (especially if lengthy operations are involved). The difference in size and complexity, and particularly the larger offshore operations and weather constraints imposed by the severe North Sea environment accounts for the large difference in costs between North Sea and Gulf of Mexico removal.

Cost estimates for different removal/disposal options can be generated for the specifics of each individual topside facility, including such considerations as size, weight, modular vs. integrated, complexity, amount of cleaning required, etc and the availability and market rates for construction vessels and equipment at the time. This will be a significant factor to be weighed in the overall balance of different options.

## **CONCLUSIONS**

The removal and disposal of topside facilities is an integral part of the overall decommissioning activity for an offshore platform. Topsides can vary significantly in size, functionality and complexity, and hence, a range of decommissioning options has been identified in technical studies. The technologies to implement them are not all equally mature and, in general, removal is a more complex operation than installation. One feature common to all options is that the facilities will need to be cleaned and all prohibited substances removed in accordance with regulations.

The environmental impact of each option has generally been shown to be small. Other aspects to be considered are health and safety and cost. Opportunities for reuse are drawing increased attention, but are limited by the costs of refurbishment of the older facilities and the evolution of stricter technical standards. Further, particularly for the larger facilities, components were generally designed for a specific set of functional requirements that may not fit the operating and processing demands of a new facility.

The diversity and range of complexity of topside facilities suggest that no one option is likely to be the most appropriate in all cases, particularly when seen in the context of the decommissioning of the total installation.

## **RECOMMENDED FUTURE STUDIES**

Because of the uniqueness of each offshore installation, specific engineering studies will be required to determine the cost and technical feasibility in each individual case.

There are, however, some aspects that will benefit from further generic studies:

- Further investigation of technical and economic feasibility of the range of alternative removal methods, including the truss and barge method and specialized decommissioning vessels proposed by various contractors.
- Further evaluation of reuse potential and the applicability of various technical standards to extended life facilities.

## REFERENCES

Bibliography of related reports:

AURIS Environmental. August 1995. *An Assessment of the Environmental Impacts of Decommissioning Options for Oil and Gas Installations in the UK North Sea*. Prepared for UKOOA Limited.

E & P Forum. July 1996. *Removal / Disposal of Large North Sea Steel Structures*. Report No. 10.14/243. London.

National Environmental Research Council for the Department of Trade and Industry. April 1996. *Scientific Group on Decommissioning Offshore Structures, First Report*.

National Research Council. 1996. *An Assessment of Techniques for Removing Offshore Structures. Committee on Techniques for Removing Fixed Offshore Structures*. Marine Board, Commission on Engineering and Technical Systems, Washington D.C.

Various general and technical publications and conference proceedings, including but not limited to:

*Strategies for Successful Abandonment*. 1995. October 1995. IBC Conference, London.

*Gulf of Mexico vs. North Sea Platform Abandonment*. March 27, 1996. One day business conference, Houston, TX.

*Minimizing the Impact of Decommissioning*. February 1996. Institute of Petroleum Conference.

*International Workshop on Offshore Lease Abandonment and Platform Disposal*. April 1996. New Orleans, LA.

*Decommissioning Projects and Techniques, IBC Conference*. June 1997. Aberdeen, Scotland.

**APPENDIX A:**

**CLEANING AND REMOVAL OF POTENTIALLY HARMFUL MATERIALS**

**A1. GENERAL DESCRIPTION**

**FLUSHING OF VESSELS AND PIPEWORK**

Vessels, tanks and piping will be classified as to whether or not they have contained hydrocarbons. Those classified as having contained hydrocarbons would have to be flushed to remove residual hydrocarbons. Procedures for such cleaning have been developed which are regularly exercised in the preparation of pipework for cutting or other such work in potentially flammable atmospheres. Elements of these procedures are presented in Section A2.

The objectives for cleaning in these instances are to eliminate the explosion and fire risks associated with hydrocarbon residues and to remove the potential for release of any hydrocarbons or pollutants into the marine environment. Prior to the cutting up of structures for full or partial removal, it would be necessary to follow a procedure similar to that outlined in Section A2.

Each of the non-hydrocarbon systems will require separate consideration to determine the need for flushing and cleaning.

**REMOVAL OF POTENTIALLY HARMFUL MATERIALS FROM TOPSIDE FACILITIES**

A combination of the following activities may be found on individual platforms:

- |  |  |
|--|--|
| <ul style="list-style-type: none"><li>• oil production/processing</li><li>• condensate production/processing</li><li>• gas production/processing</li><li>• hydrocarbon pumping/loading</li></ul> | <ul style="list-style-type: none"><li>• water injection</li><li>• gas re-injection</li><li>• power generation</li><li>• drilling</li><li>• accommodation and support</li></ul> |
|--|--|

Each of these facilities will have specific requirements for preparation for decommissioning.

As part of the disposal of the topsides, any material that cannot adequately be cleaned will be removed for onshore disposal. Among the materials to be considered on a particular platform are the following:

**1. Hydrocarbons or potentially hazardous chemicals contained in the following vessels or equipment:**

- |  |   |
|--|---|
| <ul style="list-style-type: none"><li>• transformers</li><li>• coolers</li><li>• scrubbers</li><li>• separators</li><li>• heat exchangers</li><li>• tanks for drilling consumables<br/>inc. bulk storage of muds, etc.</li><li>• biocide containers</li><li>• diesel tanks<br/>inc. bulk storage tanks</li></ul> | <ul style="list-style-type: none"><li>• paint containers</li><li>• batteries</li><li>• fire extinguishing /<br/>fighting equipment</li><li>• pumps</li><li>• engines</li><li>• generators</li><li>• oil sumps</li><li>• tanks</li><li>• hydraulic systems</li></ul> |
|--|---|

**2. Quantities of heavy metals (e.g., lead, zinc, mercury, cadmium, etc.), if any, in biologically available form.**

Where such elements are used on offshore installations they are predominantly in metallic form and thus not directly or easily available to the biological food chain. Bolts and other items made from alloys containing the above metals will not need to be removed before abandonment.

**3. Other undesirable substances such as radiation sources.**

**4. Light bulky materials such as  
→ life boats**



- life jackets
- thermal insulation
- lightweight panels
- accommodation module fittings.

#### 5. Chemicals used in drilling.

The principal use of chemicals on offshore installations is as additives in drilling muds employed in drilling the wells in the early phases of an oil or gas field development. It would be unlikely for there to be any such chemicals left on a platform at the time of removal. However, in the event of small quantities of chemicals remaining on the platform, e.g., corrosion inhibitors, such materials would be shipped back, preferably in their original containers, for disposal at appropriate reception facilities onshore.

### EXISTING PROCEDURES

For each of the above, procedures will already be established for maintenance work requiring cleaning and dismantling of the various systems. In general, the procedures necessary to prepare a hydrocarbon system for “hot work” would satisfy the requirements of being substantially “hydrocarbon free” prior to disposal. Such procedures have been developed by each operator over a number of years and are in routine day-to-day use.

### A2. ELEMENTS OF STANDARD INDUSTRY PROCEDURES FOR FLUSHING OF TANKS AND PIPEWORK

After the plant has been taken off stream, cooled down and pumped out, all items of equipment must then be depressured, drained and vented.

#### DEPRESSURING

Normal practice is to dispose of hydrocarbon gasses to fuel gas or flare systems.

As systems become depressured they should then be isolated by valving and subsequent blanking.

#### DRAINING

Prior to equipment being isolated, it is essential that it should be drained as far as is possible via fitted drain points.

Adequately sized drain lines should be installed at the lowest points and sized in accordance with operator's engineering practices.

#### VENTING

Where flammable or other harmful materials are to be vented, the point(s) for release must be located in order to preclude any possibility of vapors encroaching upon areas where personnel are working or where there is likelihood of ignition.

#### PURGING AND FLUSHING

Pipework can be flushed or purged using either steam, water or inert gas. For many applications, water is used as the primary cleaning method. However, steam cleaning is sometimes used but has a higher degree of safety implications.

Pipelines which carried wet oil or hydrocarbons will require flushing with sea water to obtain a satisfactory level of cleanliness, i.e., when the system is substantially hydrocarbon free. The pipeline will then be filled with sea water and sealed.

## REMOVAL AND DISPOSAL OF DECK AND JACKET STRUCTURES

**ANDREW S. CULWELL**  
Vice President, Special Projects  
American Pacific Marine, Inc.

### INTRODUCTION

The removal of deck and jacket structures is the core of the decommissioning of an offshore oil and gas facility. This paper discusses the objectives of the decommissioning process along with the methodologies used to meet those objectives. There are many challenges to the decommissioning process created by water depth and the associated large mass of the platform structure. There are also limitations of equipment and techniques which must be analyzed in order to choose the best combination of resources and technologies to best fulfill the operational and environmental criteria established for the decommissioning site. The removal of offshore oil and gas facilities in California will include a wide range of structures from man made islands constructed of concrete and rock fill, to wooden piers with concrete caissons, to steel platforms in water depths ranging from 45 feet to 1200 feet.

Disposal issues are complex and are tied to the industrial capacity, environmental factors, and political climate of the decommissioning area. These variables narrow the available choices for disposal of the deck and jacket materials. A number of decommissioning project case histories on the U.S. West Coast are illustrated and discussed in this paper, along with descriptions of the methodologies and equipment used. These examples of past projects reveal some advances in technology, increased regulation by governing agencies, and an ongoing focus on safety.

This document reviews the state of the art technologies available to remove these marine structures, and reviews the rationale for the selection of resources and methodologies with given variables in structure location, size and design.

### REMOVAL AND DISPOSAL GOALS

The removal of offshore oil facilities should be accomplished using methodologies which are efficient while offering the highest possible margin of safety for the workers and maintaining the smallest possible impact on the environment. Safety should always be the foremost consideration, with environmental impact and efficiency being weighed on a case by case basis.

Perhaps the most critical question is, how much of the structure should be removed? The presence of a structure over a number of years has created a marine ecosystem. This structure may be an obstacle to commercial fishing and a resource for sport fishing. Parts of the structure may be imbedded in the sea floor to the extent that total removal will create more disturbance to the environment than partial decommissioning in place. All of these factors must be considered in generating a removal plan (factors which dictate the limits of the removal).

The water depth may influence these options and impacts. A structure in shallow waters is likely to be easily accessible by the public, and public safety at the site following removal must be considered. A structure in deep waters may be partially decommissioned with all remaining materials far below the water surface. Further, the extreme mass of a deep water structure is a significant challenge, not only for the initial removal process, but for the disposal process as well. The scrapping and disposal capabilities on the U.S. West Coast are limited, and these limitations must be considered as a part of structure removal planning. The massive quantities of marine growth and the disposal of this material causes air quality issues at the disposal site due to the odor. Air emissions are also an important consideration in areas with air quality problems.

## CASE HISTORIES IN SHALLOW WATER AND DEEP WATER

The following case histories will illustrate and discuss some of the major offshore decommissioning projects completed to date (**Figure 1**). It should be noted that the largest crane barge used for these projects in California has been rated at a 500 ton capacity. Future decommissioning projects on larger platforms in California may require a barge crane capacity ten times greater to remove these massive structures.



**Figure 1.** Facilities Decommissioned on the West Coast.

### Aminoil Ellwood Pier

Ellwood Pier is located north of Goleta, California and is one of several oil production pier facilities still remaining in California. This pier is no longer a producing facility, and is now used for crew and material transfer. This facility had five concrete caissons with production wells positioned 700 feet beyond the terminus of the pier today. This section of pier and the caissons were decommissioned in 1979. The pier was made of steel H-pile columns supporting a timber deck, terminating at the five concrete caissons which were connected by steel trusses and covered with a continuous timber deck.

The timber deck was removed and the piles were cut off by divers below mudline. The concrete caissons were demolished using explosive shape charges. The 15 pound conical charges were positioned around the perimeter of the structures and detonated to reduce the caissons to pieces with maximum dimensions of approximately six feet. Reinforcing steel was cut by divers. The steel trusses were cut above water by rigging crews and below water by divers using arc-oxygen torches. The concrete rubble was reduced to a pile which did not extend above a water depth of -15 feet at low tide and was left in place. The steel was recovered and scrapped onshore. The use of explosives in open water, a common practice prior to 1980, has not been allowed in recent years for decommissioning work in California. Explosives continue to be used below mudline for pile and conductor severing.

### Texaco Helen and Herman Platforms

Platforms Helen and Herman, originally installed in the late 1950's in State Waters, were decommissioned in 1988 following production shutdown and well plugging in 1973. These structures were located offshore Gaviota, California in 100 feet of water and 85 feet of water respectively and represented the early design of offshore oil platforms with simple tubular construction and anchor piles driven down through the annuli of the platform legs. Both structures had been moved to the site for installation on cargo barges and placed in position on the sea floor with a barge mounted crane. The decommissioning of these platforms was the first large scale offshore oil platform decommissioning project performed in California, and therefore there were many unanswered questions regarding disposal options. An artificial reef construction from the jacket materials was proposed during the project permitting and planning phase, however political opposition to the proposed reef site in Santa Monica Bay killed the plan. Deep water dumping was also considered and discarded. The only remaining disposal option was onshore scrapping, and this methodology was carried out to dispose of the materials.

Platform Helen was a 20 leg structure and Herman was a 4 leg structure. The marine growth accumulated on the structures was over 15 inches thick near the surface with up to 12 inches of hard growth. The structures were in poor condition after 15 years exposure without cathodic protection. Platform Helen had a number of 2 inch diameter pipelines running to subsea completions with a 6 inch and 8 inch production pipeline to shore. Platform Herman also had a 6 inch and 8 inch production pipeline to shore. The pipelines for both platforms were decommissioned in place with a section through the surf zone removed completely. All onshore facilities and pipelines were removed. The deck packages and jacket structures were removed in sections weighing from 100 to 400 tons. The cuts below the water line were made by divers using arc-oxygen torches. The jackets were attached to the sea floor by piles inside the legs. The piles on Helen were severed 1 foot below natural mudline using a mechanical casing cutter. This method proved to be less than reliable, as most of the cuts were incomplete and had to be completed by divers deployed down the inside of the 33 inch piles. The slope or "batter" of the outside legs proved to be a problem for the casing cutter, even though a centralizer was used. The piles on Herman were cut from the outside by divers after excavating a foot below the natural mudline because the interior of the pile had been grouted, leaving it inaccessible for cutting tools.

The Helen and Herman platforms together had a steel weight of approximately 3000 tons. The marine growth probably added 1000 tons to this figure. Disposal was performed onshore in Long Beach at a private yard with waterfront access. The size of the jacket structures, soaring about 80 feet above the deck of the barge, presented a significant problem for dismantling. The 500 ton derrick barge "Wotan" used to remove the structures was required to offload the materials at the dock. This process was feasible because all of the materials were brought in together on 3 barges. The onshore dismantling required two large crawler cranes to safely take down the tall tubular structures.

## **Chevron Hope, Heidi, Hilda and Hazel Platforms**

The Chevron Hope, Heidi and Hilda platforms, located in State Waters off Carpinteria, California in water depths of 137', 126', 106', and 96' respectively, were decommissioned in 1996 immediately following well plugging (P & A) operations. The decommissioning project, sometimes called the 4-H Project, was postponed for one year due to air emission permitting delays, caused by strict limitations on air emissions imposed by the Environmental Protection Agency (EPA) on Santa Barbara County and the classification of decommissioning emissions by the Santa Barbara County Air Pollution Control District (APCD) as non-exempt. Emission offsets were required by the APCD to keep emission levels below target ceilings, and the time required to create those offsets resulted in the delay of the project. These platforms were installed between 1958 and 1965 and were in sound structural condition at the time of their decommissioning. Disposal options including onshore scrapping and artificial reef construction were weighed in the permitting and project planning phase. The artificial reef option was not selected because at the beginning of the permitting process in 1992, the State Lands Commission and the Coastal Commission were not favorably disposed toward this disposal method. Later, interest emerged in the artificial reef approach by the American Sport Fishing Association, and the concept was seriously analyzed for the 4-H Project; however, the late timing created permitting obstacles and there were questions as to the cost effectiveness of the method for this particular project. Therefore, onshore scrapping was used again as the disposal method of choice. Several potential sites in the Terminal Island area of the Port of Long Beach were selected for a dismantling and scrapping process similar to the one performed in 1988 for Platforms Helen and Herman. One of the lessons learned here was that future projects should include analysis of the artificial reef option for disposal from the outset of the permitting and planning phase.

Platforms Hope, Heidi and Hilda and Hazel were technically advanced designs at the time

of their installation (See **Figure 2**). The Hope, Heidi and Hilda jackets had two large diameter caisson legs which served as the flotation for the jackets during installation as they were towed to the site on their sides. This platform design concept was used as late as 1977 for the Thistle "A" platform installed in the North Sea. The Hope, Heidi and Hilda platforms were anchored to the sea floor by piles driven through sleeves in the large caisson legs and through sleeves in smaller caissons at the base of the opposing legs.

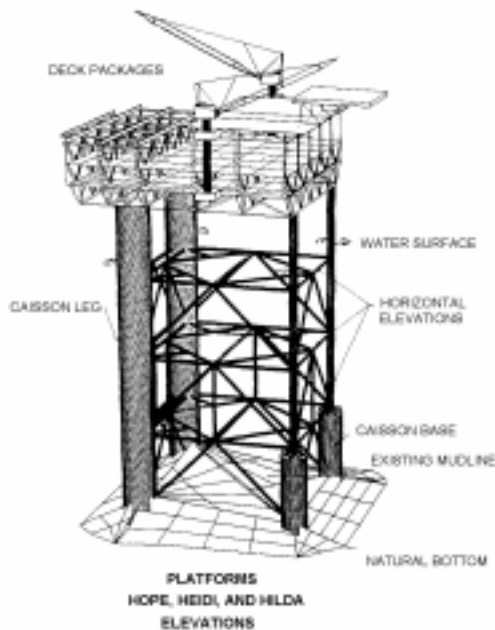

**Figure 2.** Platforms Hope, Heidi, and Hilda design. This illustration is typical of platform size in water depth ranges from 100 to 140 feet.

The Hazel jacket was a "gravity structure" design in which the platform was floated out on its buoyant caissons and ballasted on site by filling the caissons with sand and cement. A gravity structure by definition is secured to the sea floor by gravity alone and is not anchored by steel piles. Hazel was a typical tubular steel jacket structure sitting on large diameter caisson bases (See **Figure 3**). These caisson bases floated the structure to the site when empty, and became the anchor for the structure when jettied 18 feet into the sea floor and filled with ballast material. This gravity structure concept developed in the 1950's was later used for platform design in the treacherous Cook Inlet near Anchorage,

Alaska, and more recently has been used for concrete platform structures fabricated in Norwegian fjords and floated on the gravity bases which are later ballasted with sea water and/or crude oil storage.

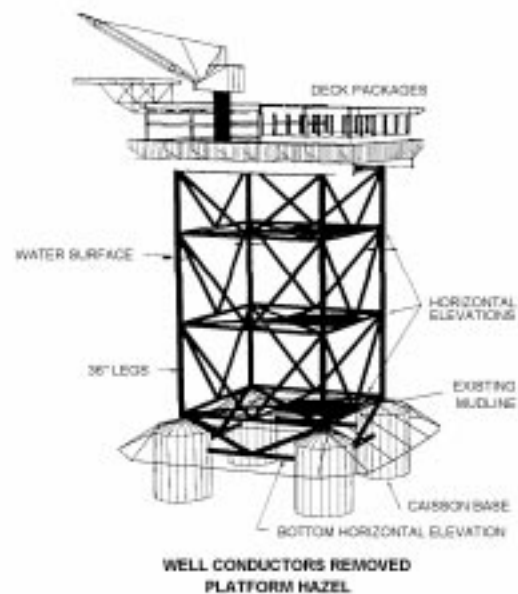

**Figure 3.** Platform Hazel design. This platform is a "gravity base" design and had no anchor piles.

The production well P&A process was completed during a two year period on the four platforms. The dismantling of production equipment followed, removing all production equipment and piping with hydrocarbon residue from the structure.

The removal of the 4-H platform structure decks was completed as the reverse of the installation process. This scenario is typical because the deck package lifts that were designed for installation are the safest and most practical configuration for removal. The marine equipment of the 1960's included derrick barges with capacities in the maximum range of 500 tons. Today we find derrick barges lifting more than 10 times that amount, but the package to be removed must be engineered for the lift, and many times, the package is removed in a configuration similar to its original installation. Equipment availability is also a factor to be considered. Construction barges are plentiful in California, but the largest barges, such as the D/B Wotan

used on this project, have a capacity of approximately 500 tons. If heavier equipment is needed, it must be imported from other areas at a significant cost. The 4-H decks were removed in sections weighing 100 to 350 tons and placed on cargo barges for transport and offloading at a dockside facility in Terminal Island. It must be noted that the air emission permit process was difficult due to the stringent requirements in Santa Barbara County. The option of importing larger equipment with significantly more capacity, greater horsepower, and higher fuel consumption would probably have been over the emission limitations imposed on the owner by the APCD.

The removal of the 4-H platform jackets offered many technical challenges in that the structures were designed to float on their own buoyant legs, and therefore there was no inherent design strength for lifting them. The large caisson legs, measuring up to 18 feet in diameter, had a mere ½ inch wall thickness and had been designed to withstand only the maximum pressures anticipated in the launch mode with partial flooding. Therefore dewatering the legs to lift the structure off bottom was risky at best with anticipated pressures meeting or exceeding design ratings, resulting in the requirement for another alternative to lift the structure. The answer for the recovery of the delicate but massive legs was the utilization of a pair of 250 ton capacity hydraulic gripping tools attached to 2 of the pile stubs on the legs. Further, it was necessary to cut the legs in up to 3 vertical sections to reduce the weight of the lifts to meet the capacity of the crane. The most effective cutting technique in depth ranges accessible to divers continues to be arc-oxygen torches, and this method was used for the majority of underwater structure cuts. This methodology is not as effective, however, when cutting through multiple well casing strings grouted together.

The severing of the legs in 3 sections as well as the pile and well conductor severing required below the bottom of the leg structure required methodology which would be efficient and reliable. The technology for abrasive water jet cutting has progressed to the point where it has been successfully used for many pile and conductor cutting operations on

decommissioning projects, however it has not yet achieved the reliability of explosive cutting.

The abrasive water jet methodology was used for intermediate cuts in the well casing strings inside the caisson legs for sectioning the legs in 3 parts; and it was also used for the removal of casing strings outside of the legs. However this methodology does not have guaranteed success and many cuts were repeated or completed by divers working inside the caisson legs after cuts proved to be incomplete. The piling and well casing cuts were performed far below the existing mudline to reach a depth below the bottom of the structure. It was crucial to the safety of the heavy lifts that these cuts be complete and reliable because they could not be examined for verification. Explosive cuts have been proven to be the most reliable cutting methodology in use, and 45 pound explosive charges were employed on each of the pile and well casing strings locations. These charges were effective in completely severing the piling and well conductors below mudline on 100% of the explosive cuts performed. A number of conductor cuts below mudline had to be made by divers due to access blockage of the casing annuli by grout. These cuts required divers to work inside the caisson legs, cutting the bottom of the structure clear as well as the conductors and casings.

The removal operation revealed another complication - the legs of Hope, Heidi, and Hilda were partially filled with grout or hardened drilling mud, increasing the leg weight beyond the capacity of the crane. Mud removal operations ensued, with divers pumping off the solid materials to storage tanks on the deck of a cargo barge. These tanks were offloaded in Terminal Island and the material was transported to an approved dump site.

The Hazel platform, a gravity structure, was partially decommissioned in place. The gravity base caissons were nearly covered with accumulated materials and shells in a mound under the structure. Because of the caissons' excessive weight and the disturbance to the sea floor which would be caused by their removal, this part of the structure was decommissioned in place.

The 4-H platforms had 20 intra field and field to shore pipelines and 9 power cables. Platform Hope was receiving and shipping production from platforms Grace and Gail, and these pipelines had to be rerouted around the Hope platform to facilitate the decommissioning of the structure (See **Figure 4**). Other pipelines were disconnected from the platforms, capped, and the ends were buried 3 feet below mudline. The pipeline and power cable decommissioning was performed by the 165 foot workboat M/V American Patriot. Most of these pipelines are buried where they reach shore, and those that sometimes become exposed are adjacent to pipelines still in production. Therefore, no landfall pipeline removals were performed; however, the decommissioned pipelines were grouted internally through the surf zone and decommissioned in place.

The steel mass of the 4-H platforms was in excess of 10,000 tons. The total weight of marine growth removed was in excess of 2700 tons. Disposal was performed onshore at a 20 acre dockside facility in Terminal Island. Steel scrap was reduced to marketable sizes and sold. The crane capacities onshore were very limited and it was necessary for the removal derrick barge to offload the structures at the dock. The package heights were designed to be limited to approximately 30 feet to avoid dismantling problems on the dock after offloading. The volume of the scrap required numerous trips to the dock to offload the cargo barges. Debris at the platform sites was removed by divers working aboard the 165 foot workboat M/V American Patriot and transported to Casitas Pier for land transport and disposal.

### Exxon SALM

The Exxon SALM or Single Anchor Leg Mooring, was installed in 1980 in Federal OCS waters using a combination of a drill ship and derrick barges to complete the construction. It was decommissioned in 1994 using a derrick barge. The SALM was positioned in 500 foot waters off Goleta, California and had a 750 foot long Offshore Storage and Treatment Vessel (OS&T) permanently moored to the mooring structure.

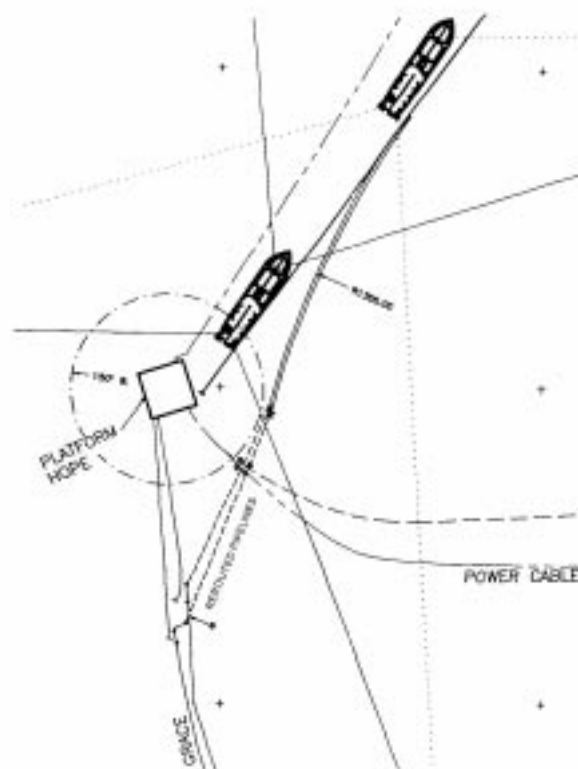

**Figure 4.** Pipeline Bypass at Platform Hope. The pipelines from Platform Grace originally terminated at Platform Hope, and production continued to shore in the Hope pipelines. A reroute of the pipelines around the platform kept the Hope pipelines in service for Platform Grace production.

The SALM was comprised of a base structure approximately 52 feet in diameter anchored by 6 piles. The riser and buoy structures connected by universal joints to each other and to the base plate resemble a large automotive drive shaft supporting a mooring yoke to the OS&T at the surface. Pipelines running from the Hondo platform sent crude oil and gas production up the riser and buoy structure, through swivel fittings at the universal joints and finally to the OS&T for treatment prior to offloading. The OS&T provided storage of the crude oil and deployed a mooring hawser to tankers for mooring during the offloading of produced oil emulsion. The OS&T facilities layout is shown in **Figure 5**.

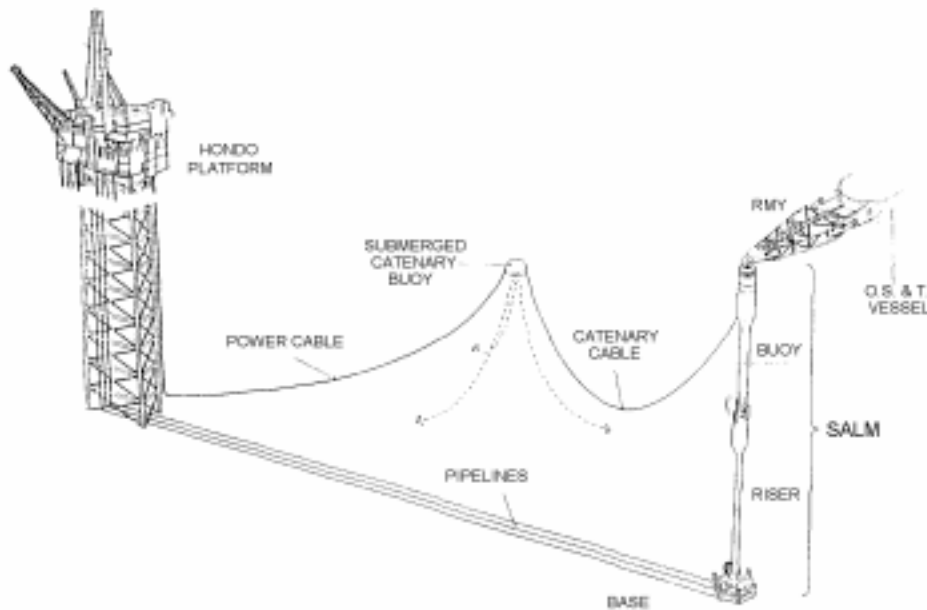

**Figure 5.** OS&T Abandonment Project Facilities Layout. Exxon OS&T Abandonment.

The removal of the SALM was the first deep water decommissioning project performed in California. The structure was 14 years old at the time of the removal operation, was in good condition and marketable for reuse in other areas. Therefore, the scrapping and artificial reef questions did not apply to this project.

The removal of the SALM system, like many decommissioning projects, was performed using many of the same techniques applied for the installation. In fact, the derrick barge used for the installation work, the D/B Long Beach (formerly D/B 300), was also used for the removal operation. The OS&T vessel was disconnected and towed to Ensenada, Mexico for temporary storage; however, in spite of established plans, the vessel was turned away by Mexican authorities, underscoring the potential uncertainties inherent in crossing international borders in the decommissioning process. The vessel was finally towed to a dock in the Port of Los Angeles for storage. The large yoke on the vessel's stern had to be supported by a large buoy which had been stored in the Port Hueneme area after the installation. The attachment of this buoy was accomplished by a delicate ballasting operation combined with the use of winches and a derrick barge.

The riser and buoy sections of the structure were removed using saturation divers. The hydraulically actuated pins which had secured the structure to the base during installation were found to be operational, replumbed and then retracted to disconnect the riser structure from the base structure. A ballasting operation on the buoyant riser and buoy structures (reducing the lift forces), combined with the attachment of a wire for controlled release at the base structure (reacting against the buoyancy), were used to recover the buoy and riser to the surface. The de-ballasting of the structure and attachment of transport buoyancy to the riser, further raised the SALM to a horizontal attitude for towing. The buoy was towed to the Port of Los Angeles for temporary storage.

The base structure was removed in a more typical fashion for decommissioning operations. Saturation divers disconnected the pipelines and capped and covered the ends with concrete mats to ensure the passage of trawl nets over the site in the future. The 6 anchor piles were severed 15 feet below the natural seafloor using abrasive water jet cutting technology operated remotely from the surface (see **Figure 6**). All of these cuts were successful. The base structure was cut into 7 sections by saturation divers using



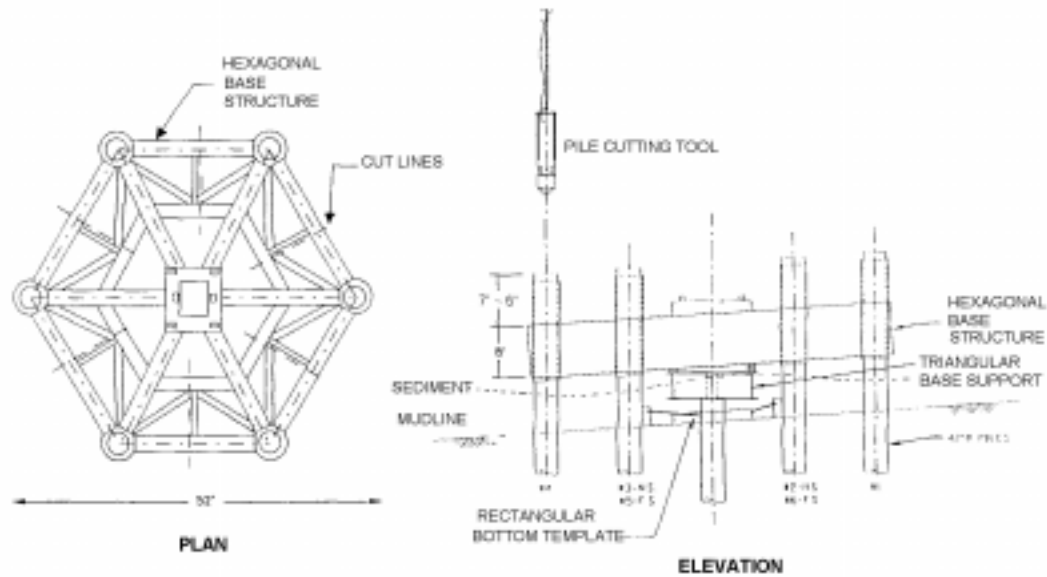

**Figure 6.** SALM Base Structure. Exxon OS&T Abandonment.

arc-oxygen torches and rigged for removal with the derrick barge.

The SALM and OS&T structure were resold and are now in operation overseas. The base structure was scrapped onshore.

### Global Perspective

The number of platforms decommissioned each year exceeds 100 structures, most of which are located in the U.S. Gulf of Mexico. Most of the structures decommissioned to date have been located in relatively shallow water. The Exxon SALM described above and the Brent Spar removed from the North Sea are two deep water examples which did not have the tremendous mass of the majority of deep water structures which will be decommissioned in the future.

The challenges for the future will center around the removal and disposal of these massive structures. The environmental impacts of onshore disposal of these structures will be much greater than the impacts seen in the disposal of smaller structures, while the alternatives for decommissioning in place and artificial reefs may see an increase in potential benefits.

The removal of massive deep water structures may come first to California waters. These decommissioning projects will require larger capacity and more capable heavy lift equipment, support tugs, and transport barges, with an associated increase in air emissions. The removal of the deck packages of these newer structures may provide opportunities for reuse in other areas of the world, reducing the disposal dilemmas which must be faced. The total removal of the jackets for onshore scrapping would create many impacts including air emissions, marine growth disposal issues, and the quandary of insufficient sites for such activities.

The removal of the shallow water structures continues each year and we see similar scenarios to those recent decommissioning projects in California described above. Reuse of oil production platforms is quite common in the Gulf of Mexico. A reuse scenario could see an entire structure removed in one piece, transported and placed back on the sea floor. Another scenario on a larger structure could be the removal of the decks and jackets in separate lifts with reassembly at another location. In a different scenario, jackets and deck packages are removed from the field and reconditioned and upgraded onshore in a fabrication yard, followed by reinstalled at a

new offshore location. The obstacles to the installation of new offshore oil production facilities in California, makes these reuse scenarios much less likely to occur here.

## ENGINEERING AND PLANNING

### Organize Logistics

The planning of a decommissioning project begins with the identification of the equipment necessary and available to do the work. The choice of derrick barges, tug boats, and cargo barges along with the disposal plan will be the basis for an analysis of environmental impact using this equipment (See **Figure 7**). The most efficient means of removing the structure must be developed with all of the potential variables in mind. The owner must not only choose the most effective equipment spread, but ensure that it is available and can be successful in completing the work outside of any potential environmental windows such as the whale migration periods. Air emissions limitations have been an issue in the past; however, new legislation may have exempted oil production facility decommissioning work from these limitations.

### Special Tool Design

The lifting of structures which have been in service for many years, and which may have been extensively modified since their installation, will probably require the design and fabrication of special tools and rigging to create lift points, and perhaps attachment tools to connect the rigging to those heavy lifts.

### Engineer Heavy Lifts

The heavy lifts must be engineered to ensure that the lift is made safely and within the capacity of the crane used (See **Figure 8**). The dynamic loading conditions offshore add additional risk to the heavy lift, making the engineering effort a central issue. A weight take-off for the package to be lifted must be generated to accurately calculate the mass of the lift. The rigging of a lift bridle of at least 4 parts, as well as the use of special tools or spreader bars, add complexity to the lift. The center of gravity (CG) must be identified, and the rigging centered on this location (See **Figure 9**). A package which is not lifted around the CG may have three of its four load slings taking all of the load, creating excessive loading on those parts. A more significant miscalculation could result in an unstable load which has the potential of hitting the crane boom or dropping portions of the lift. The

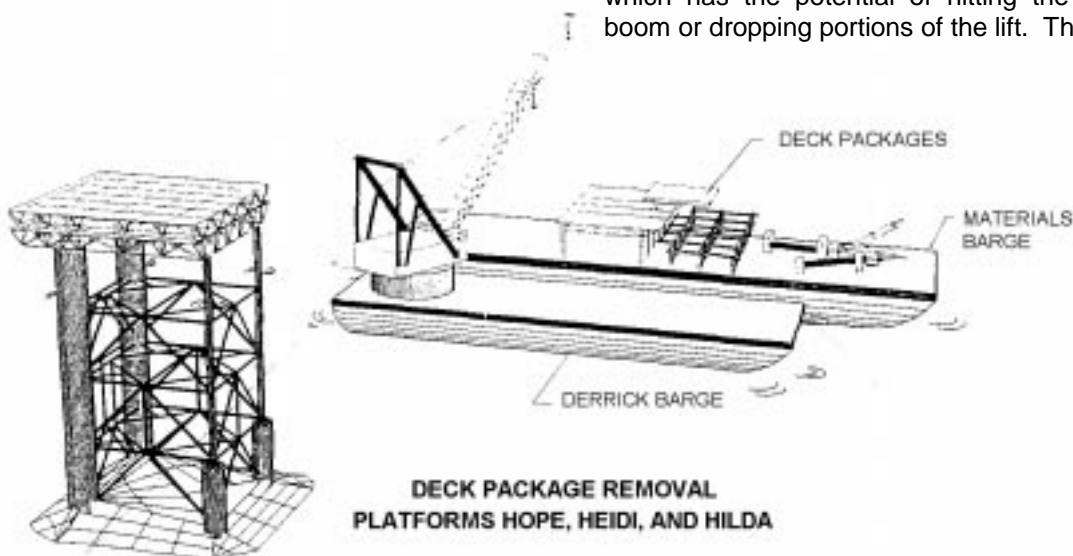

**Figure 7.** Equipment Spread – Shallow Water Decommissioning. This illustration compares the mass of the petroleum platform to the removal equipment. The platform is in 140 feet of water with a 500 ton crane barge (300 feet LOA) and cargo barge shown.

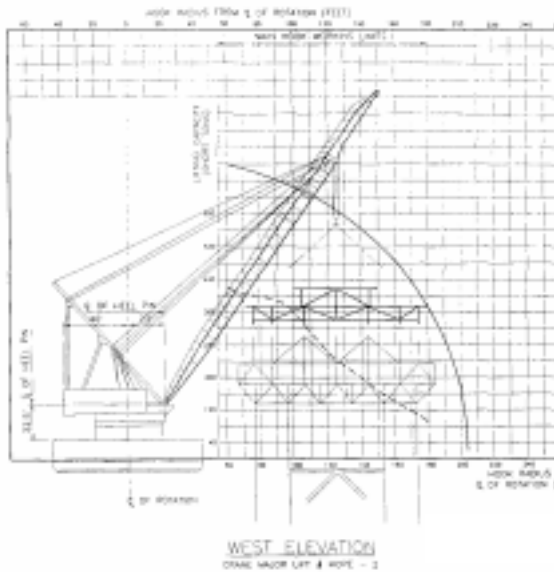

**Figure 8.** Lift Plan – Crane Chart. The heavy lifts are engineered with the load weight and dimensions, center of gravity, rigging, and crane capacity limits charted. This planning verifies that the crane can complete the lift without the boom touching the load, and that the working radius (capacity is sufficient to complete the lift).

engineered lift will specify specific rigging, crane radius to be used, weight take-offs for the lift which include the rigging weight, lift point location and type, plus a contingency factor.

Additional planning must be engineered to provide a means of aborting a lift after the load has been raised a few inches. A lift abort could be necessary due to mechanical malfunction on the crane, changing swell conditions, or a rigging failure. Tubular structures or any structure sitting on columns must have guides on the columns at the cut points which allow for approximately 1 foot of vertical travel before the load clears. This will enable the operator to lower the load within the guide if an abort is necessary.

### Engineer Materials Transport

The heavy lift barge which has just rotated a lift package away from the platform under dynamic load conditions must have a place to set that load without delay. Therefore, it is imperative that planning include the cargo barge load. Each large lift may be placed in a

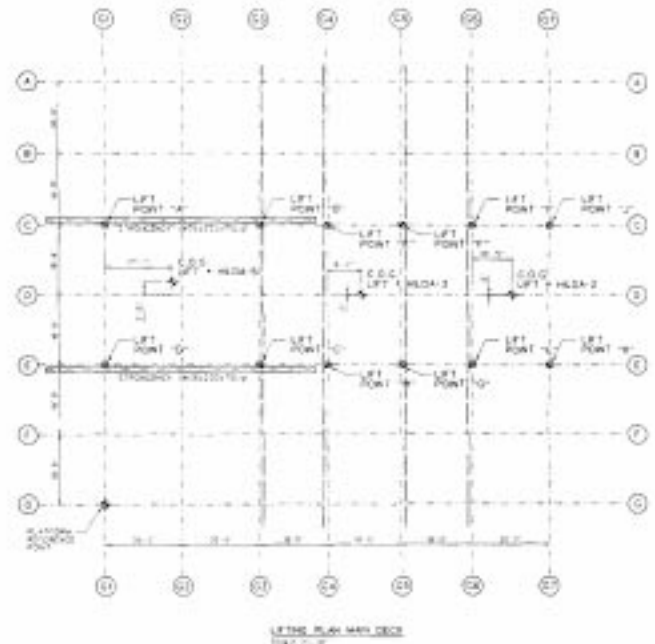

**Figure 9.** Lift Plan – Lift Points and CG Locations. The chart shows the center of gravity (CG) and lift points for the heavy lift preparations.

predesignated position on the barge, a position which has been verified relative to barge stability in the roughest seas anticipated (See **Figure 10**). Sea fastening is engineered to efficiently secure the load to the barge for transit.

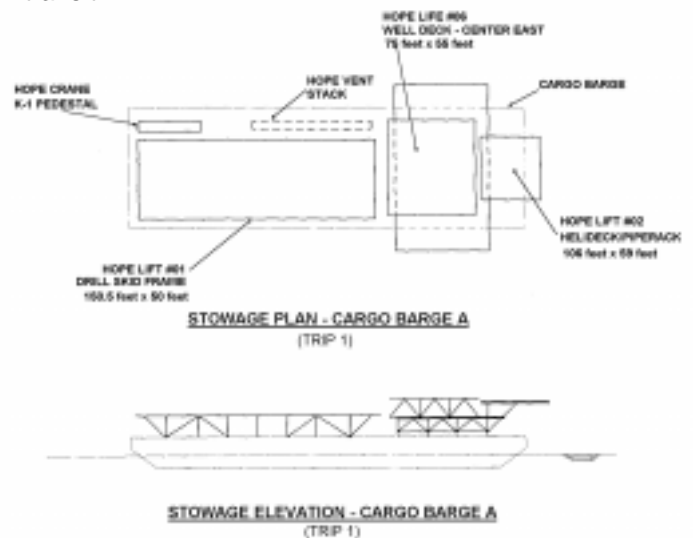

**Figure 10.** Materials Transport Planning. The sketch shows the plan for cargo barge loading. This planning also incorporates engineered sea fastening for each load and stability calculations.

## Plan / Engineer Disposal

Every package that is placed on a barge must be eventually offloaded. The method of complete onshore disposal will require a crane equal to the barge crane for offloading, or the package may be reduced in size while at the dock. This may be impractical as the size reduction ties up high cost marine equipment for extended periods, and the new reduced lifts must be engineered and rigged as well. Alternative disposal means such as artificial reefs will require extensive engineering and planning which is combined with biological and environmental data.

## PROJECT RESOURCES

### Heavy Lift Equipment vs. Depth Ranges

Structures located in less than 200 foot water depths, and located in moderate environments such as the U.S. West Coast are typically of a size which can be dismantled by a 500 ton crane with 160 to 200 feet of boom. The structure age can also be a critical factor as platforms installed within the past 15 years may have been assembled with larger deck packages requiring larger lifts for a stable removal sequence. Jackets may be sectioned at will to suit the capacity of the equipment.

### Support Vessels

Support vessels are the backbone of an offshore decommissioning project and the central vessel is the derrick barge. All derrick barges require tugs to maneuver them and sometimes place anchors. Some advanced derrick barges may be equipped with a dynamic positioning (DP) system which uses onboard computer controlled thrusters to accurately hold the vessel on station when integrated with a navigation system in lieu of anchors.

A 500 ton capacity derrick barge of approximately 300 foot length over all (LOA) and operating on the U.S. West Coast may require as much as a 3000 horsepower (hp) tug to provide towing and anchor handling. The anchors used may be 5 to 10 tons in weight

deployed on up to 2 inch wire rope anchor wires without chain, and can be expected to hold a tension of approximately 10 times their weight (Danforth Type) in sand. A 5000 ton capacity derrick barge of approximately 600 foot LOA may work with the assistance of up to a 25,000 hp tug set up to operate in more harsh environments such as the North Sea. Anchors used may be 15 tons or more in weight "piggybacked" with 2 anchors per mooring leg comprised of anchor chain.

Crew boats are commonly used in California because of the close proximity of the majority of platforms to land. Platforms which are in excess of 15 miles from a point of onshore crew transfer are typically out of practical range for daily shift changes by crewboat. Platforms which are out of range will require personnel accommodations during their operating life and the decommissioning equipment used to dismantle them will also need to accommodate the crews. Helicopter transport is an alternative to offshore accommodation, but is plagued in California by the coastal fog during the summer months and Santa Ana wind conditions in the winter months.

Tugs and cargo barges are needed to stage and transport removed materials and packages. Cargo barges which are available as a part of the typical marine transport market may range from 180 feet LOA to 400 feet LOA. These barges must be documented by the American Bureau of Shipping (ABS) with a Load Line Certificate to legally transport materials on the open sea in U.S. waters. Tugs in the range of 1500 hp for smaller barges and 3000 hp to 5000 hp for the larger barges are utilized for towing and maneuvering. The cargo barges must be moored on a remote mooring near the decommissioning site to receive multiple lifts from the derrick barge which may occur hours apart.

### Special Tools

Special tools may be required for certain lift applications or perhaps robotic cutting applications. For example, the recent decommissioning of Platforms Hope, Heidi, Hilda, and Hazel required a number of special tools. Hydraulic grippers were adapted to special buoyant lift rigging for 500 ton lifts.

The buoyant rigging allowed another special tool, an A-frame with a 38 part lift block assembly, to stab onto the established gripper tools underwater. The A-frame was used for the removal of leg sections which had to be extracted through up to 20 feet of bottom material. The loads to be encountered on these lifts could not be entirely engineered, and the A-frame provided a great margin of safety without risk to the crane boom. These are just a few samples of special tools provided on one project.

### **Personnel**

The platform decommissioning project will vary in personnel commitment by the size of the equipment used. The working window of opportunity due to equipment availability, or environmental restrictions may also affect the size of the decommissioning team. A small decommissioning project on a single platform in shallow waters may require only 40 to 50 personnel to operate the marine equipment spread. A moderately sized project with multiple platforms in shallow waters may require 75 to 100 personnel. A deep water decommissioning project with larger equipment may require in excess of 150 personnel.

## **DEMOLITION OF CONCRETE STRUCTURES**

Concrete structures offshore include caissons with piers and concrete and rock islands. These facilities are typically located in water depths of 45 feet or less. The concrete structure's extreme weight creates some challenges to reduce the structure into sections for removal and there are a number of demolition techniques available:

### **Diamond Wire Sawing**

A wire rope impregnated with industrial diamonds is fed through holes drilled into the concrete structure and the ends of the wire are connected together to form an endless loop. The loop is driven on the deck with a hydraulic powered sheave and pulling pressure is applied to force the wire loop to cut the concrete and reinforcing steel until the holes it has penetrated are connected by the

cut. This method typically requires access to both sides of the holes being drilled to facilitate feeding the wire through. The result is a clean and straight cut which is not limited by the thickness of the concrete.

### **Abrasive Water Jet**

A high pressure water jet is directed at the concrete with an abrasive garnet or copper slag mixture. The water jet bombards the structure at pressures of 10,000 to 50,000 psi and the abrasive multiplies the cutting forces. This tool typically is directed with a robotic feed assembly which controls the rate of travel for the cut and will sever the reinforcing steel along with the concrete. The method can be employed to cut concrete thickness up to several feet.

### **Expansive Grout**

A number of holes are drilled into the concrete structure and filled with an expansive grout. The grout expands as it hardens, cracking the surrounding concrete. This method reduces the concrete to rubble which must be hammered to expose reinforcing steel for final cuts with a torch.

### **Hydraulic Splitters**

A number of holes are drilled into the concrete structure and a hydraulic splitting tool is inserted. The tool expands hydraulically and cracks the surrounding concrete. This method reduces the concrete to rubble which must be hammered to expose reinforcing steel for final cuts with a torch.

### **Explosives**

Explosives may be used in small quantities in drilled holes through the concrete to reduce it to rubble.

### **Impact Demolition**

The oldest and most familiar method for reducing concrete is direct impact to the structure. A wide range of tools may be used including hydraulic powered impact hammers operated from excavators or special support machines, and wrecking balls or tools manipulated from cranes. Reinforcing steel is manually cut when using this method.

## REMOVAL PREPARATIONS TO DECK PACKAGES

### Installation of Remote Moorings for Cargo Barges

The cargo barges required to receive materials should have a means to moor temporarily in the field. This serves to reduce fuel consumption, and allows tug crews to rest. As a lift is being prepared, the tug can take the barge under tow and maneuver alongside the derrick barge to receive the package. The barge and tug will depart the field for the disposal site when the barge is fully loaded.

### Deck Package Lift Preparations

Deck package lifts will require lift point fabrication and installation prior to the arrival of the derrick barge. Crews will pre-rig as much as possible to reduce the duration of the derrick barge utilization. Preparatory cutting of decks may be performed in conjunction with engineering calculations for a modified structure analysis, to minimize the cutting time required to separate the packages for their lift (See **Figure 11**).

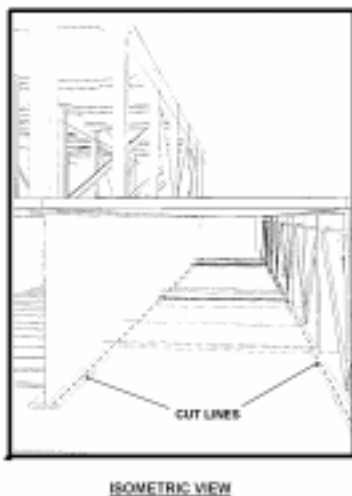

**Figure 11.** Preparations to Deck Packages. This isometric shows the cut lines for separation of two deck modules for lifting.

### Preparations for Alternate Use

Any alternate use or disposal option may require specific preparations (relative to that option). The re-use of a structure may require

many protective measures to preserve the equipment on board during the transfer.

## REMOVAL PREPARATIONS TO JACKETS

### Marine Growth Removal

Marine growth will be removed at the underwater cut points to facilitate diver cuts using arc oxygen torches. The removal of all marine growth prior to removal of the structure has not been economically feasible. The removal of marine growth is accomplished by the use of a 10,000 psi hydroblaster which is operated by divers. The seawater jet removes the marine growth to within millimeters of bare metal.

### Preliminary Cuts on Jackets

Preliminary cuts on a jacket in shallow waters may be made to prepare for removal, in conjunction with engineering calculations for a modified structure analysis. These may take place before or after deck package removals as dictated by engineering. Deeper water removals may also allow for preliminary cuts, as many of the members on the jacket were primarily for installation loads during a barge launch of the jacket.

Methodology for deep water cuts may include the use of saturation divers to depths of over 1000 feet; however saturation diving operations in excess of 600 - 700 feet are rare. The question of the use of divers for extreme depths depends on the projected safety of the operation and the cost of using divers versus remote intervention means. Cutting techniques using remote systems could include Atmospheric Diving Systems (ADS), a manned system which operates an abrasive water jet cutting tool or a mechanical equivalent. Other systems include heavy work Remotely Operated Vehicles (ROV) which carry similar tools in work packages on board. Remote applications have been cost effective in performing cuts in extreme depths, however heavy rigging is a tremendous challenge for remote intervention techniques. Therefore progressive lift methodology is a likely choice for the removal of jackets in deep water as discussed below. Deep water jacket removal

techniques have not been implemented to date, and specific methodologies must be developed and proven in the field.

## REMOVAL OF DECK PACKAGES

The strategy for the removal of deck packages centers on several factors. First, the capacity of the derrick barge combined with the available space on the cargo barge will determine the maximum lift size. Second, the capacity of the offloading crane chosen must also be within the limits of this package size. Third, it must be determined if the package and the remaining portions of the deck packages will support themselves when the specified load is cut free and removed. Finally, the package itself must have the integrity to be lifted, or additional measures such as the use of spreader bars or strongback members may be taken to reduce the loads on the package. The choice of reuse of the package or scrapping may have some bearing on the size and configuration of the package chosen.

The deck package will be transported to the offloading location. A decommissioning project in Southern California is likely to offload in the Port of Los Angeles or Long Beach. The only likely alternative to scrapping the deck packages is reuse. Packages destined for reuse may remain on the cargo barges for shipment to another location for refurbishment and sale. Other alternatives such as artificial reefs are typically not applied to the deck packages. Deck package configurations are the easiest to scrap because they are comprised mainly of flat plate and beams. Conversely, the hydrocarbon residue which may be present on portions of the deck package would make the cleaning requirements excessive in order to incorporate the package into an artificial reef.

## PILE AND CONDUCTOR SEVERING

The jacket is typically anchored to the sea floor by anchor piles. These piles may be driven over 200 feet into the sea floor and must be cut off at a specified distance below the mudline to remove the jacket. This distance has been 1 to 5 feet below mudline in

California state waters and 15 feet below mudline in Federal waters. Piles are grouted to the structure near the base, and may have well conductors inside. Most platforms do not have wells drilled through the anchor piles, but have a conductor bay in the center of the structure. Intermediate piling cuts may be required to separate the jacket into vertical sections, as the piling may extend well up into the jacket structure, particularly on the shallow water platforms.

Conductor severing and recovery will most likely be completed as a part of the well plugging process. The conductors may contain multiple strings of well casing, grouted together. Mechanical casing cutters are typically used in this application if a drill rig is available for deployment of the tools. Abrasive water jets may also be used to make these cuts at the designated elevation below mudline. The conductor may be lifted then with the drill rig through the structure and sectioned as it is lifted to facilitate offloading. The conductors, like the rest of the structure will be heavily fouled with marine growth. When the conductor is pulled up through the conductor guides located at each horizontal member elevation, the marine growth will be stripped as it passes through the guide. Jackets with excessive marine growth or jackets in poor condition may incur damage as the conductor is pulled up. Modification to the conductor guide or removal of the marine growth on the conductor may then be considered.

The mechanical casing cutter is perhaps the oldest method for cutting well conductors. The casing cutter is a drilling tool deployed on a drill pipe string. The cutting tool has 3 blades which fold up against the drill pipe. When hydraulic (drill water) pressure is applied to the tool, the blades are forced outward as the tool is rotated by the power swivel on the drill floor. The carbide tipped blades cut through the casing strings until penetration is complete through the outer conductor. Drillers can watch the back pressure on the drill water to determine when the cut is complete. The cut can be verified after the recovery of the tool, by the marks of penetration on the blades. This method is not 100% reliable, as the outer conductor will

deform significantly as the blade is forced through.

When final penetration is reached, the hydraulic back pressure will reduce, but the cut may not yet be complete. The final verification is the successful vertical movement of the conductor. The casing cutter methodology is problematic for conductor removals in which close tolerance conductor guides on the jacket are smaller than the deformed cut end of the conductor which must pass through the guide during recovery.

Abrasive water jet technology has been successfully used in recent years to cut multiple string well casings. The abrasive water jet leaves a clean, machine like cut in the casing strings. Several different systems are in use. The pressures range from 10,000 psi with a high volume output to 50,000 psi at a lower volume output. The abrasive is introduced at the cutting nozzle tip and may be sent down a hose dry by air pressure or in a water based solution. The abrasive is propelled by the water jet after being introduced into the cutting jet, and cuts the steel and grout as it hits the target. Casing strings with void areas rather than grouted annuli have been a problem for this methodology. The water gap between casing strings dampens the energy of the water jet and causes an incomplete cut. Inconsistent abrasive delivery can also be a problem. The systems which have an air delivery of the dry abrasive grit are limited to shallow water application. The systems using a fluid delivery of abrasive have been used in water depths exceeding 600 feet. The abrasives typically used are garnet and copper slag. Some operators have been reluctant to use copper slag because of the environmental implications of the copper content; however, the level of copper present in the slag material is relatively low, and there are no restrictions on its use. The most versatile aspect of this cutting technology is the relatively small tool size, and its potential and historic use by remote intervention systems such as ROVs and ADS to depths exceeding 1100 feet. The casing cuts which are completed below mudline cannot be verified visually. The tool operators have used microphones for audio

feedback and hydraulic back pressure readout to gauge whether the cut is being completed. The rotational cutting speed of the tool is set by the operator's "feel" for the cut and by the known capability of the tool. These methods are at best, only indications of cutting performance in progress, and there have been a significant percentage of incomplete cuts on previous decommissioning work in California and in the Gulf of Mexico. The abrasive water jet technology continues to develop and will be a popular technique for cutting applications in the future.

The use of explosives to cut conductors, well casings and piles has been the most reliable method in use for many years. The open water use of explosives has been restricted in recent times, but applications below mudline continue to be permitted with minimal impacts to marine life. The bottom cuts on anchor piles and conductors required for the removal of jacket structures must be clean to allow for a safe lift from the surface. A barge making such a lift in dynamic conditions at sea would certainly exceed its lift capacity if an incomplete cut left the load secured to the sea floor. This potentially dangerous condition dictates the use of the most reliable method for making these cuts, and explosives have proven to be nearly flawless in their reliability. An explosive cut is sized according to the diameter and wall thickness of the member to be cut, along with the number of strings. A typical charge for these cuts is a cylindrical explosive container which is lowered down the conductor or pile to the designated cut elevation and detonated from both ends to create a "collision charge". The force of the detonation at the ends moves toward the center of the cylinder and moves out horizontally when the two explosions collide. This horizontal force creates the directional cutting energy to sever the pile or conductor (See **Figure 12**). The methodology is extremely safe, as the explosive cannot be detonated without an explosive detonator. The detonator (blasting cap) is attached to a detonation cord which is secured to each end of the explosive. Modern blasting caps are detonated by high voltage and are not sensitive to radio waves as others have been in years past. Because the detonation cord may be several hundred feet long, the vessel



supporting the operation can move clear before a blasting cap is ever installed. The vessel continues to move away, paying out electrical wire to the blasting cap before detonation is applied to the wire with high voltage. The recent decommissioning of Platforms Hope, Heidi and Hilda employed the use of explosives for the majority of bottom cuts with a 100% success record. Spotting aircraft and boats were used to verify that there were no marine mammals in range of the blast area prior to each detonation. The charge size for the typical cuts on shallow water platforms is approximately 45 lbs.

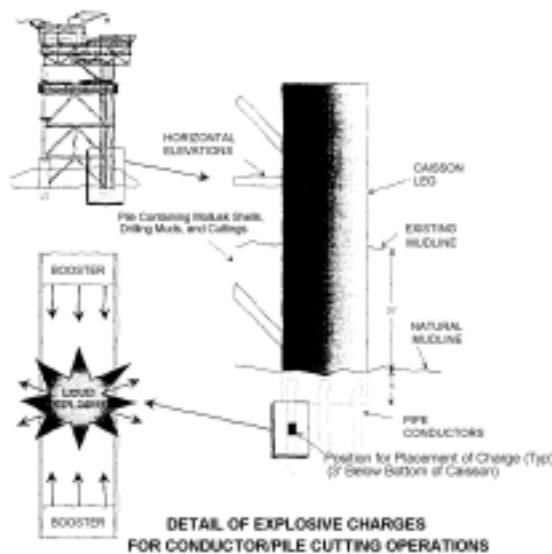

**Figure 12.** Pile and Conductor Severing Using Explosives. The used below mudline for conductor and pile cuts are typically bulk charge cylinders which are simultaneously detonated from top and bottom. The explosive force meets in the middle of the charge redirecting the cutting forces to the horizontal plane.

## JACKET REMOVAL

Jacket removal can be accomplished in various degrees and using a number of methodologies. All jacket removal operations will take place following the completion of pipeline decommissioning. The most common removal scenario for shallow water jackets is complete removal of the jacket. This method will leave nothing on the sea floor except the mound that accumulates under

each jacket during its operating life. This mound is comprised of drill cuttings, shells and other organic material from marine life on the structure, and collected sediments for structures in depositional areas. The jacket removal is completed after bottom cuts have been completed below mudline on the anchor piles. The entire jacket is removed in sections or as a single lift if possible.

Deep water structures present much greater challenges for complete removal. The immense weight of the structures as well as their extreme depth, places a one step removal outside the limits of existing technology. A method known as “progressive transport” reduces the structure to packages for shipment in a cost effective manner. The structure is rigged between two barges and lifted after the pile severing operation is complete. The jacket is winched vertically off the bottom and the barges are moved into towards shallow water until the jacket touches bottom again. The upper portions of the jacket can now be removed above the water surface and the rigging is reattached underwater for another lift. The remaining structure is vertically lifted again and transported to shallow water where it is again reduced and rigged. This process can be repeated as needed to completely recover the jacket.

Jackets can be partially removed with a portion decommissioned in place. This method would involve the removal of the upper portions of the jacket such that the remaining structure was well below the surface, and clear of concerns about navigation hazard. The remaining structure would be in effect an artificial reef.

Another approach to decommissioning in place is jacket “toppling”. The jacket is pulled by winches on anchored barges after pile severing, and the structure is toppled on its side. The jacket structure on it’s side will be well below the water surface.

The deep water platforms in water depths of more than 400 feet are candidates for progressive transport, partial removal in place and decommissioning by toppling. Shallow water platforms are more likely candidates for

complete removal at the site. California platforms Helen, Herman, Hope, Heidi, and Hilda have all been completely removed at the site, and were located in water depths from 85 feet to 139 feet. Platform Hazel was decommissioned using partial removal in place due to her extremely heavy gravity structure caisson bases below the mudline.

## **DEBRIS REMOVAL**

Debris removal is performed within a specified radius of the decommissioning site. The most recent California decommissioning projects have involved debris removal within a 1000 foot radius of the platform site. There are many ways to locate and remove debris; the choice may be affected by the equipment available in the area and the water depth. A preliminary survey of the site with side scan sonar can provide a target listing and location for existing debris.

A common method for debris removal in the U.S. Gulf of Mexico is the use of trawl nets to recover debris. Heavy nets called "gorilla nets" are used from trawl vessels to gather debris. Divers can assist in completing the debris recovery operation as required.

Diver recovery with ROV assistance is an effective technique when heavy trawl vessels and equipment are not available. This method has been successfully used on all California decommissioning projects to date. The ROV is deployed with color scanning sonar to locate debris items on the target list provided by the preliminary side scan data. Differential Global Positioning System (DGPS) satellite navigation is integrated with an acoustic tracking system to provide real time position data on the ROV during search and recovery operations. The ROV locates the debris and remains on location to guide the diver to the position with a recovery line. The support vessel recovers the debris and the diver as the ROV continues to the next debris target. This method is effective for debris recovery in less than 200 feet of water.

Deeper water recovery work may be more economically performed using remote intervention techniques. Well site clearance

has been performed in California in waters exceeding 300 foot depths using ROV's and manned submersibles for recovery of debris targets. The ROV recovery operations using light work ROV's are performed by attaching a recovery line from a spool on the ROV. The ROV is recovered with the line and the line is transferred to a winch for recovery of the debris target. Large work ROV's and manned submersibles have been used to attach recovery lines from the surface. The remote method is altered slightly with larger equipment in that the ROV or manned submersible remains on bottom during the debris target recovery and uses sonar to relocate the recovery wire for the next target.

## **MATERIAL TRANSPORT AND DISPOSAL**

Material transport is most commonly achieved on cargo barges. These barges are available in the existing marine transport market up to a length of 400 feet. Larger barges, if required, would not be commonly available and would carry a significant cost.

Onshore scrapping has been the method of choice in California to date. The distance to the scrapping facility is critical due to the high cost of marine equipment. If barges are to be shuttled from the decommissioning work in the field for offloading, the shorter the duration, the fewer cargo barges and tugs are required. The existing scrap facilities in California are not set up for scrap reduction of large packages. These facilities are fed by numerous small scrap companies which reduce small volumes of scrap into marketable sizes of approximately 3 feet square and less. Because of this existing market condition, a steel scrap reduction and processing operation must be created to reduce these large packages to marketable dimensions. The scrap reduction process is costly and waste products must be hauled to a dump site. Most of the existing scrap processed in the Los Angeles area is shipped in bulk carriers to the Far East for sale there.

The debate over where to put artificial reefs, and who might be responsible has left the steel scrap yards with the business of

reducing these structures. Still there is a high level of interest in creating these reefs. The construction of an artificial reef would require environmental study, an engineering plan for the layout of the reef, and a significant commitment of marine equipment to place the materials.

Relocation and reuse of platform structures is common in the U.S. Gulf of Mexico, and structures are commonly lifted and relocated within a few miles to be set up for production again. This scenario is unlikely in California; however packages with enough value to warrant transport to other areas may be transported from California decommissioning projects. This was the case for the Exxon SALM and OS&T decommissioning project completed in 1993.

## CONCLUSIONS

The removal and disposal of deck structures offers many options for reuse and recycling of materials. The deck structures may have viable equipment and components for use at another facility. A newer deck package may be transferred intact for installation on a new jacket. Older structures which are scrapped offer the type of configuration which is best for recycling (i.e., flat plate, beams, paint protected condition).

The removal and disposal of jacket structures presents many challenges. The extensive marine growth, deterioration of the materials, grouting of jacket piles and members, along with the size of the structure make offshore removal difficult. Reuse options are limited, especially on the U.S. West Coast. Onshore scrapping is very difficult with small structures, and may present tremendous challenges for larger structures. These obstacles make the search for alternatives worthwhile, and create a potential for the use of jacket structures as artificial reefs when relocated or partially decommissioned in place. These removal operations can be completed in an environmentally sound and safe manner with existing technology while creating jobs and increasing commerce. The disposal of the materials is a potential resource which can bring economic and/or environmental benefits.

## REFERENCE

Exxon Company U.S.A. August 1994. *Exxon OS&T Abandonment Final Report.*

## PIPELINE AND POWER CABLE DECOMMISSIONING

**ANDREW S. CULWELL**  
Vice President, Special Projects  
American Pacific Marine, Inc.

and

**JOHN C. McCARTHY**  
Engineering Geophysicist  
Minerals Management Service, Pacific OCS Region

### INTRODUCTION

Offshore California oil and gas platforms are typically served by one to three pipelines. These pipelines range from 4 to 20 inches in diameter and move production fluids to other platforms or to onshore processing and distribution facilities. Some pipelines are used to return treated produced water to a platform for offshore disposal or injection. The specific properties of the fluids transported in a pipeline may change during its service life of 30 or more years.

In addition, to reduce air emissions, California production platforms are designed for, or have been converted to, electrical power. This power is provided by the regional onshore electrical distribution network and reaches the offshore facility via power cables traversing the sea floor like oversized extension cords.

To a casual onshore observer, the ultimate consequence of terminating production from offshore oil and gas fields is the removal of associated offshore and onshore facilities. The presence or absence of pipelines and power cables related to these facilities is a less obvious, but still important, factor to consider in decommissioning.

### DETERMINING OBJECTIVES

It is difficult, if not impossible, to develop an adequate engineering plan for decommissioning pipelines or power cables until specific determinations are made regarding their disposition. Without question, decisions whether, or not, to remove or decommission in-place are a basic element in determining the scope of work. Federal regulations allow

decommissioned OCS pipelines to be left in-place when they do not constitute a hazard to navigation, commercial fishing, or unduly interfere with other uses of the OCS. California regulations are similar in allowing pipelines to be left in-place when they are not considered a hazard or obstruction, although California State Lands Commission policy requires removal, when feasible, of pipeline segments in the surf zone to a depth of -15 feet MLLW (mean low water). There are few examples where total removal or decommissioning in-place is the only preferred option because pipeline and power cable alignments typically traverse a range of environmental settings that require different solutions to address a variety of decommissioning objectives that are, at times, conflicting.

From an operator's perspective, highest priority is usually given to assuring worker safety in the context of pursuing regulatory compliance and minimizing the risk of future liability, at minimum expense. Regulatory agencies with primary oversight responsibility for pipeline and power cable decommissioning also tend to place emphasis on assuring worker safety, but cost is of less concern than the need to fulfill regulatory mandates to minimize adverse environmental impacts and user conflicts, such as preclusion of commercial trawling. The interests of other stakeholders usually focus on one or more of the issues already mentioned to the exclusion of all others.

One of the keys to optimizing decisions regarding pipeline and power cable disposition options is to find an acceptable balance between conflicting interests that is sufficiently flexible to address the variety of conditions that might be present along the alignment. The

other key is to have a clear and accurate understanding of existing conditions based on a pre-decommissioning survey of pipeline and power cable alignments.

Useful preliminary information regarding conditions along pipeline and power cable alignments can be obtained from a number of sources. Reviews of historical records, such as pre-installation surveys, as-built documentation, external pipeline surveys and records of fishing conflicts provide background information applicable to the design of an adequate pre-decommissioning survey.

Pre-decommissioning surveys are used to characterize conditions along pipeline and power cable alignments. Surveys on recent California projects have employed side-scan sonar to provide reconnaissance-level overviews and are usually supplemented with detailed video and sonar documentation, using an ROV (Remotely Operated Vehicle), in areas where significant conditions are suspected. The results of pre-decommissioning surveys should be evaluated in the context of available historical documentation to aid in determining whether specific segments of an alignment are subject to major changes over time. Burial conditions may change seasonally in shallow water, high energy environments and spans may migrate.

Careful documentation provides a basis for determining preferred disposition options by identifying conditions, like high spans, that have potential to interfere with other uses such as commercial trawling. Documentation can also provide insight into whether or not preclusion is even an issue because other factors, like high relief seafloor features, may preclude trawling. Pre-decommissioning surveys are also used to identify environmental and engineering conditions that might require special safety or environmental protection measures during the conduct of a decommissioning project.

## **ENGINEERING, PLANNING AND EXECUTION**

The majority of pipelines on the U.S. West Coast have been installed with a "bottom tow" technique, meaning that the pipes were welded

together at a staging area at the onshore landfall position and, with temporary buoyancy attached, were pulled offshore by an anchored barge. Many pipelines were pulled in bundles of two to three pipelines to an offshore facility. Upon completion of the tow, the buoyancy was Removed by divers, remotely operated vehicles (ROV's), or boats dragging sweep wires. The bottom tow method is significant for the decommissioning process because pull sleds were used on the leading end of the pipeline and are typically left in place near the platform. Connecting spools were installed by divers to complete the installation. The removal process must consider the disposition of these pull sleds and any remaining rigging left after the temporary flotation was removed from the pipeline. Most pipelines on the U.S. west coast have not been buried by the installation contractor. Some pipelines in depositional areas of sand transport have naturally become buried, and others remain uncovered for the majority of their length.

## **Engineering and Planning for Power Cable Removal**

The power cables which run from shore to the offshore facility are armored with one or two layers of steel armor wire, with internal high voltage wires which were typically designed to carry in excess of 30,000 volts. These cables are four to six inches in diameter and are quite heavy. Sub-sea power cables, when buried or lying flat on the sea floor, are not a hazard to trawl fishing and have typically been decommissioned and abandoned in place with the ends buried below mudline. The weight of the cables creates a challenge for recovery, because if they are to be recovered in one piece, a large powered reel as large as 35 feet in diameter would be needed along with linear cable engines (a hydraulic powered, rubber coated steel track assembly which captures the cable and pushes the cable through the tool). The potential reuse of these cables is questionable and therefore the cable may more simply be cut into pieces as it is recovered; however, the disposal of the cables is difficult because of the complexity of separating the armor, the insulation and the copper wire. It is most likely that an onshore dump site is the ultimate destination of a recovered power cable. All decommissioned power cables to-

date have been abandoned in place with the exception of the Hondo SALM described in **CASE HISTORIES.**

the planning for power cable removal would include the set up of a retrieval system and a rigging and cutting methodology to quickly sever the power cable. Burial issues are generally not critical, as the power cable can be recovered in spite of a burial condition due to the high strength and relatively small diameter. A disposal plan would be required if a power cable is removed.

### **Power Cable Removal**

Power cables are more typically abandoned in place than removed. The removal process would involve attaching the cable to a recovery winch by divers. The cable end can then be retrieved so that a linear cable engine can be set up to drive the cable up onto the recovery vessel and a hydraulic shear can be used to section the cable for stowage and transport.

### **Engineering and Planning for Pipeline Removal**

Pipeline removal operations require engineering pre-planning to determine the methodology for removal and the size and capacity of removal equipment. Historic documentation of the pipeline operation and conditions prior to final shutdown are necessary to identify residual fluids and gases in the pipeline. Shutdown documentation should reveal the methodology used for final cleaning and flushing of the pipeline, which will provide data for an estimate of the extent of additional cleaning required for decommissioning.

Determining the most appropriate removal techniques will require data from recent pipeline surveys or a dedicated pre-decommissioning survey. Data requirements include: pipeline burial locations, burial depth, water depth along the route, nearby pipeline or structure locations and environmental information such as the position of kelp beds and hard bottom habitats.

In addition, engineering planning requires knowledge of pipeline characteristics such as diameter, wall thickness, density and locations

of weight coat (if present), flanges, pull sleds, and pipeline crossings.

Assembled data are analyzed to determine how much of the pipeline will be removed. Survey data from the removal locations are used to determine the type of excavation equipment required as well as any environmental precautions which must be taken. For example, anchor plans must be developed around the kelp beds and hard bottom habitats.

The barge capacity, both for recovering the pipe and storing the pipe, must be evaluated along with auxiliary equipment such as cargo barges and tug boats. The methodology for cutting the pipe may be critical, especially if a long length of pipeline is to be recovered. The protective coatings and weight coat typical of most pipeline sections to be removed make pipeline severing difficult, because these coatings must be removed in order to cut the pipe with a torch.

Disposal is a critical issue for pipeline removal because reuse of the steel is not feasible due to the coatings on the pipeline. Typically, pipelines must be cut into lengths as short as 6 feet and hauled to an approved dump site on land. This process is costly and the methodology chosen to process the material for dumping is important, in order to achieve a cost effective result.

### **Pipeline Removal Preparations**

#### ***Survey***

The pipelines will be surveyed or existing data will be studied to determine the location of flanges, crossings, kelp, and hard bottom habitats.

#### ***Cleaning***

Pipelines are cleaned using a process called "progressive pigging". This process involves sending a series of polyethylene (poly) foam "pigs" and cleaning pigs through the pipeline with chemical agents and flush water to remove all hydrocarbons. The pig is a foam bullet shaped plug which is slightly larger in diameter than the inside diameter of the pipeline. The pig is introduced into the pipeline through a "pig launcher" (a pressure vessel connected to the end of the pipeline). The pig launcher has a diameter larger than the

pipeline to allow insertions of the pig by hand, and a hatch or flange which is closed behind. The pig is pushed from the launcher into the pipeline by pumping air, nitrogen, water or chemicals into the launcher behind the pig. A measured amount of fluid or gas is pumped before a second pig is inserted into the launcher. The progression continues until the required number of pigs with the corresponding amount of driving chemicals or flush water is sent through the line, removing all remaining hydrocarbons. The pigs are received in a "pig catcher". The pig catcher is similar to the pig launcher. The pig catcher, located at the opposite end of the pipeline, is plumbed to allow fluids or gas to flow through, pushing the pigs to the end of the catcher.

The types of pigs available that may be used is based upon the condition of the pipeline, previous cleaning history, and the expected buildup of wax, corrosion, or other residue from hydrocarbon production, as listed below:

1. *Low Density Poly Pig* - A low density pig can pass through partially blocked pipelines because it can radically deform as it is pushed through. This pig seals the push fluid or gas to ensure that all liquid in the pipeline is displaced by the fluid or gas behind the pig.
2. *Medium Density Poly Pig* - A medium density pig can pass through blockages with moderate force applied and can move some material collected on pipeline walls.
3. *High Density Poly Pig* - A high density pig passes through blockages with higher force applied and will move material collected on pipeline walls.
4. *Brush Pig* - This pig has wire brushes or other types of brushes to remove material residue left by previous pigs.
5. *Scraper Pig* - This pig has a number of hard scrapers built in to scrape the more resistant residue off pipeline walls.
6. *Poly Pig* - Final flushing is completed using a poly pig.

Progressive pigging is necessary to ensure that the pigs do not get stuck in the pipeline. The

use of a high density or scraper pig on the first run could scrape enough material to stop the pig and block the pipe. Pushing the first one or two pigs with several barrels of de-greaser or surfactant will soften and dissolve hydrocarbon residue in the pipeline, allowing the denser poly pigs to remove the majority of material before using a scraper pig. It should be noted that a pipeline which has been kept clean or was cleaned at the time of shutdown, may only require low density poly pigs and flush water for final cleaning. Verification of the pipeline cleaning is based upon flush water quality checks which may rely on visual verification that there is no hydrocarbon "sheen" or measurements by instrumentation.

Flush water is typically pumped down disposal wells, processed for disposal, or trucked to an approved dump site.

### Pipeline Removal Operations

Pipelines will generally be removed offshore through the surf zone and capped. The removal may be completed by an anchored barge or work boat with adequate winch and crane capacity to pull the pipe aboard and lift sections to a cargo barge or boat for transport to shore. The onshore pipeline may be removed completely, or some sections may be abandoned in place due to their transition through a sensitive environment such as a fragile beach bluff. The pipeline end seaward of the surf zone, typically in water depths exceeding 15 feet MLLW (mean lower low water), is capped with a steel cap and jetted down 3 feet below mudline by divers.

Divers will cut the pipeline with an arc oxygen torch at the platform and install a cap on the end. A tent may be used over the cut point to catch any residual hydrocarbons, however, the progressive pigging operation will usually clean the pipeline well enough to avoid any hydrocarbon releases. The pipeline end is buried below the mudline, typically by diver operated jetting. The pipeline end may alternatively be covered by a concrete mat as shown in **Figure 1**. The mat provides a cover for the pipeline end that will not hinder a trawl net. A pipeline pull sled at the platform may create an obstacle for fishing. The sled would need to be removed or buried with the pipeline

end to eliminate the potential snagging hazard for trawl nets.

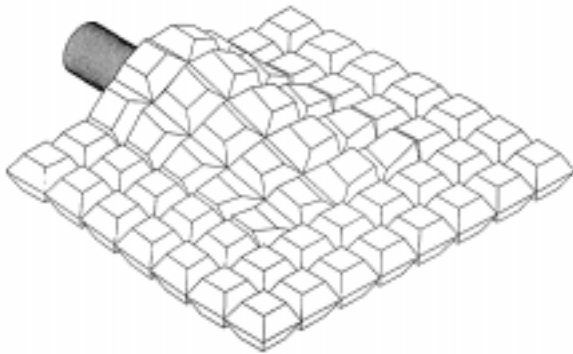

**Figure 1.** Flexible Concrete Mat Pipeline End Treatment. Exxon OS&T Abandonment Plan.

The recovery of removed pipeline sections is accomplished by rigging a winch wire to the pipeline and lifting it to the barge. A crane may be used in conjunction with the winch to hoist the pipeline onto the recovery vessel. The pipeline removal operation will typically create forces on the pipeline which result in buckling and bending. These structural failures have no impact on the removal process and allow for lower cost removal operations. Excavation may be required to remove the pipeline, or it may be recovered without excavation if enough lifting force can be applied.

Pipeline crossings may be an obstacle to decommissioning, particularly if the pipeline to be decommissioned crosses under a live production pipeline. A pipeline crossing is the intersection of two or more pipelines, generally at some location away from the platform site. The crossing of the newest pipeline is usually built up 1.5 to 2 feet above the older existing pipe with a steel frame bridge and/or cement bags. This crossing creates a mound which may be a trawling obstacle. The removal of one of the pipelines at a crossing creates an element of risk, and if the pipeline is to be removed entirely, the abandonment in place of several hundred feet of the pipe at the crossing may be advisable to avoid any possible disturbance of the pipeline in service.

### Pipeline Disposal

Pipeline materials must be transported by truck or barge to an approved dump site. The scrap

value of the steel in the pipelines is exceeded by the cost of removing the pipeline coatings; and therefore a scrapping disposal option is not viable. The pipeline materials must be reduced in length in accordance with the dimensions dictated by the selected dump site, and may be as short as 6 feet. A hydraulic shear may be used effectively to section the pipeline materials to meet these requirements.

### CASE HISTORIES

#### Exxon, Hondo-to-SALM Pipelines and Power Cable

The first deep water (approximately 500 feet ) pipeline and power cable decommissioning project off California was associated with the removal of Exxon's Single Anchor Leg Mooring (SALM) and Offshore Storage and Treatment vessel (OS&T) in 1994. The SALM/OS&T facility was installed in 1980 to transfer, process and store production from platform Hondo until the onshore Las Flores Canyon Processing Facility became fully operational.

This project included decommissioning three short (approximately 1.6 miles) pipelines and a power cable that connected the SALM to platform Hondo (**Figure 2**). A number of factors were considered in determining the scope of work to be performed. The critical factors that influenced the decision process in this case were:

- (1) The work area was situated adjacent to active, high volume pipelines, requiring careful planning and execution when establishing the derrick barge mooring.
- (2) Operations requiring saturation diving needed to be minimized to enhance safety.
- (3) The area was considered a productive trawling area by commercial fishing operators.

The condition of the pipelines and power cables were well documented along their alignments in a number of recent surveys. The most recent of these surveys showed 75% of the length of the two smaller (6 inch and 8 inch) and 56% of the larger (12 inch) pipelines were buried. After considering the options, it was determined that they could be abandoned



in place if adequate measures were taken to assure the severed ends would not significantly interfere with trawling.

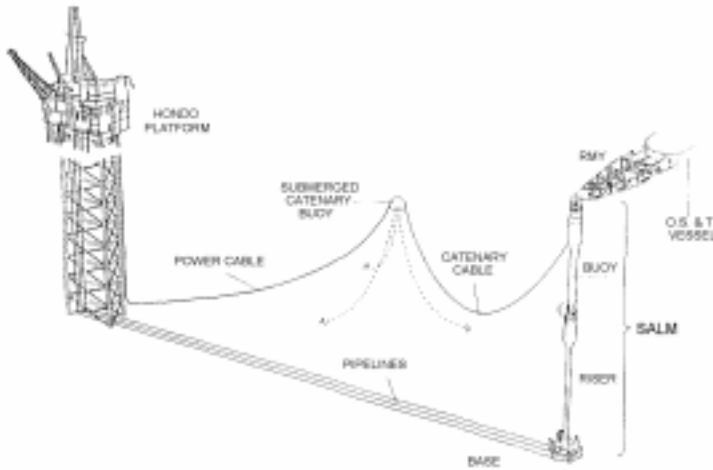

**Figure 2.** OS&T Abandonment Project Facilities Layout. Exxon OS&T Abandonment.

A total of eight primary work vessels were employed during the course of decommissioning the SALM/OS&T and associated pipelines and power cable. The project required that a four leg mooring system be established for the derrick barge. Precision mooring techniques were used to install and remove the four anchors without incident in spite of their close proximity to active pipelines in deep water (up to 650 feet).

Prior to disconnecting, the pipelines were progressively "pigged" using standard maintenance procedures and sequentially flushed with sea water to remove hydrocarbons. Each line was flushed until water samples passed static sheen tests on two consecutive flush cycles. The flushed pipelines were severed by divers about 100 feet from the SALM base and the spool pieces retrieved for onshore disposal. During pipeline cutting operations, underwater containment tents were used to collect any traces of residual oil that may have been trapped. The cut ends were sealed with mechanical plugs and each cut end was covered with an articulated concrete mattress (Figure 1), because it was not practical to bury the ends to the required three foot depth using divers.

The power cable system serving the SALM/OS&T facility was somewhat unusual

because the dynamic nature of the SALM system required a portion of the cable to be suspended above the sea floor using a three-point mooring buoy (Figure 2). Except for the suspended catenary portion, the 5 inch diameter power cable was buried along its alignment. The cable was cut by divers where the catenary contacted the sea floor and the severed end of the cable was buried to a depth of 3 feet. The balance of the cable and associated mooring system were retrieved for onshore disposal.

Subsequent trawl testing over the abandoned pipelines and power cable, especially over the severed ends, verified that the area could be trawled with conventional fishing gear. The lease is still an active component of the Santa Ynez production unit and, if it is later determined that the pipelines or power cable impede commercial trawling operations, appropriate remediation would be relatively easy to implement during platform decommissioning.

### Texaco, Helen and Herman

Platforms Helen and Herman were installed in the late 1950's in water depths of 100 feet and 85 feet, respectively, offshore Gaviota, California. They were decommissioned in 1988 after a 15 year shut down period. The pipelines' cathodic protection was not maintained during the long shut down.

Platform Helen had a 6 inch and 8 inch diameter production pipeline which came ashore under a train trestle. Platform Herman had a 6 inch and 8 inch diameter production pipeline which came ashore further north on the Hollister ranch. Both of these areas were environmentally sensitive and at each location the pipelines were visible on the beach. The Herman pipelines passed through a delicate beach bluff. The decommissioning plan required the removal of a minimum of 800 linear feet of pipeline through the surf zone, and the removal of all of the onshore pipe. The ends of the pipeline were to be capped and buried below mudline at the nearshore cut point and the offshore terminus.

A progressive pigging operation was initiated from a crane barge at the platform sites to

ensure that the pipelines were clean. The operation was started after the pipelines were disconnected from the platform. The pigging operation revealed leaks in the dormant pipelines, and repairs were made to provide the pipeline integrity necessary to run the pigs.

Following the installation of several Plidco clamps, the pigging operation was completed. A pig launcher was installed underwater at the platform site and the flush water was collected onshore in vacuum trucks and discharged at an approved dump site. A pig receiver installed at a valve box onshore collected the pigs at the end of the cleaning run.

The pipelines were then capped and buried below mudline at the platform sites and the crane barge was relocated to the landfall locations of the pipelines. The pipelines were cut on the beach by a rigging crew and approximately 1000 feet offshore by a diving crew. The crane barge pulled the cut segments offshore, through the surf zone, and recovered them for transfer to a cargo barge. The severed ends were capped and buried below the mudline and the remainder of the pipeline, outside the surf zone, was abandoned in place.

The rigging crew on the beach used a bull dozer, an excavator and a rubber tired loader to remove the onshore portion of the pipeline and valve boxes. The excavations were backfilled and shaped to natural contours.

Chevron Platforms Hope, Heidi, Hilda, and Hazel

Platforms Hope, Heidi, Hilda and Hazel were installed from the late 1950's to the early 1960's in water depths of up to 139 feet offshore Carpinteria, California. These platforms had a total of 14 pipelines ranging from 6 inches to 12 inches in diameter. Each of the pipelines was thoroughly cleaned and flushed using progressive pigging techniques prior to severing.

The pipelines from Hope to shore were also used for Platform Grace and Gail production. A 10 inch and 12 inch pipeline from Grace terminated at Platform Hope where production was transferred to the Hope to shore pipelines. Therefore the decommissioning of Platform

Hope required a reroute of the pipelines so that the Hope to shore lines could continue in production. The reroute added two bypass sections of pipeline to the existing lines, rerouting the Grace pipelines around Hope and connecting to two of the Hope to shore pipelines. Platform Heidi also had production pipelines terminating at Hope to share the pipelines to shore.

The landfall of the Hope to shore pipelines at Casitas Pier is typically buried. This burial condition, combined with the continued use of two of the three Hope to shore pipelines, made a surf zone abandonment of the unused pipeline unwise. Removal activities in close proximity to active pipelines would have created unnecessary hazards.

Similarly, the Hazel to shore pipelines are buried at a landfall near Casitas pier. Hilda production pipelines terminated at Platform Hazel to share the Hazel to shore pipelines. These pipelines were abandoned in place in the surf zone.

All of the pipelines abandoned in place in the surf zone were grouted out to a water depth of -15 feet at MLLW. The grouting operation serves to keep the pipeline weighted down to discourage any exposure in the future through the surf zone area.

Offshore at the platform sites, the cleaned pipelines were cut free of the platform risers, capped and buried three feet below mudline.

These platforms had approximately 8 power cables, although some of them were out of service. The power cables were approximately 4 inches in diameter with an armor jacket. These cables were abandoned in place by cutting the end free from the structure and burying the end three feet below mudline.

## **Ventura Tanker Berth Pipelines**

The Ventura Tanker Berth was installed in the late 1940's before the construction of the Ventura Harbor breakwater, and consisted of eight moorings surrounding a pipeline terminus with loading hoses to connect to tanker vessels. The tanker berth had one 20 inch diameter crude oil emulsion pipeline and one 8

inch diameter gasoline pipeline. Maintenance dredging of Ventura Harbor was eventually compromised by the presence of these pipelines, although the burial depth was significant.

The plan for decommissioning was designed around the removal of approximately 1500 feet of each pipeline where they crossed the harbor channel entrance and became a potential hazard to maintenance dredging operations. The entire pipeline was grouted internally prior to removal.

The grouting operation was preceded by a “hot tap” of the pipelines onshore, meaning that an access hole was drilled with a hot tap tool assembly, designed to contain any internal gases under pressure. Although the idle pipeline was depressurized when it was originally shutdown, a pressure buildup due to external heat or chemical reaction was possible during the period it was inactive. This precaution was taken due to the potential presence of explosive or poisonous gases remaining from the crude oil emulsion residue in the pipeline.

The hot tap gas samples from the 20 inch pipeline verified that there were no hazardous gases present. The pipeline was cold cut with a hydraulic powered reciprocating saw and terminated with a welded flange where a pig receiver was installed. A pig launcher was installed on the offshore end of the pipe by divers. Several pigs were introduced into the oil pipeline and the pipeline was cleaned and flushed. The flush water was processed from the pipe termination onshore through the remaining pipeline to the existing tank farm nearby. The water was transferred from the tank farm to a processing facility via connecting pipelines. The 8 inch pipeline had been severed by dredging and was not cleaned.

Grouting operations filled the 20 inch pipeline from the onshore access point to the offshore terminus. The 20 inch and 8 inch pipelines were then removed in the specified area near the breakwater. Divers cut the pipelines into sections and rigged them for recovery onto a work boat. This removal operation required extensive excavation to uncover the pipelines. Airlifting techniques were used by the divers to

uncover the pipe at burial coverage exceeding 15 feet.

## CONCLUSIONS

A clear and balanced understanding of decommissioning goals and accurate knowledge of conditions that characterize pipeline and power cable alignments are the necessary prerequisites for making reasonable decisions whether or not to remove or abandon in-place. Experience to-date indicates that removal will be the preferred disposition option for pipeline and power cable segments when:

- they have characteristics that might interfere with commercial trawling or other activities.
- they are located in water depths less than –15 feet (MLLW) or onshore (pipelines only) and not deeply buried.
- they are located in areas subject to maintenance dredging (navigation channels and designated anchorages).

Mitigation might also be considered as an alternative to removal when it can be demonstrated that it would be effective (e.g., shrouding severed ends or flanges with articulated concrete mattresses).

## SITE CLEARANCE AND VERIFICATION

**JOHN C. McCARTHY**  
**Engineering Geophysicist**  
**Minerals Management Service, Pacific OCS Region**

### INTRODUCTION

The last stage in decommissioning offshore facilities is site clearance. Site clearance is the process of eliminating or otherwise addressing potentially adverse impacts from debris and seafloor disturbances due to offshore oil and gas operations.

Though infrequent, the cumulative sum of materials lost overboard in the vicinity of an offshore facility can become significant over a time frame that may exceed 30 years. It should be understood that the debris associated with an offshore site is rarely a result of intentional dumping. Virtually all of it can be attributed to accidental losses associated with routine activities, some of which may not be directly related to activities on the facility. Vessels service platforms on a frequent basis to transfer supplies and personnel to and from shore bases. Tires, commonly used as fenders on service vessels and platforms, are occasionally lost during the inevitable contacts that occur. Less frequently, a load of supplies may be dropped overboard during transfer. Materials are also lost during construction and routine maintenance. Moorings for service vessels fail periodically, leaving anchors and associated ground tackle (i.e., chain, cable) on the seafloor.

Except for the unusual case where a loss is considered an operational or environmental risk, immediate recovery is not considered a practical or necessary option. Piecemeal salvage is not cost effective and usually addresses no functional objective as long as the structure remains on location and the lost material poses no risk. Some debris may even enhance the value of the artificial habitat associated with the structure. However, once the structure is removed, regulations and lease terms require that the location be left in a state that will not preclude or unduly interfere with other uses. Site clearance tends

to focus on eliminating debris that has potential to interfere with other activities.

Site clearance also attempts to address such issues as seafloor disturbances around the facility. Mounds of shell debris from repeated maintenance cleaning of biofouling from the structure can accumulate around its base. Such accumulations, combined with mud, cuttings and cement discharged during drilling operations, have been observed to reach a thickness of more than 20 feet above the original seafloor at shallow water locations where dispersion was minimal. At some sites, anchors from large construction vessels may scar the seafloor with deep furrows and mud mounds. Mitigation may be a more effective and environmentally preferable solution than "restoration" when dealing with fishing preclusion issues related to these types of site conditions.

The level of effort required to locate, assess and resolve potential problems associated with debris and seafloor disturbances depends on potential uses of the area, environmental setting, platform age and the frequency of certain activities associated with the operation of the facility being removed. Clearing the location around a typical offshore California production platform with 20 to 40, or more, wells and an operational history that may exceed 30 years, can be a major part of the total decommissioning effort.

### GOALS AND PLANNING

The primary goal of site clearance is to clear the location impacted by the facility and associated activities by removing all potentially hazardous materials and eliminating, or mitigating, conditions that might interfere with other uses. For all practical purposes, "other uses" tends to mean commercial trawling operations, as navigation or military use are usually not significant factors associated with offshore California facility sites. Secondary

goals include clearing the site cost effectively with minimum adverse impacts.

Clearing an offshore industrial site may appear to be a simple task but experience has shown it is not one to be taken lightly if a high standard is to be achieved. The strategy for clearing an offshore location must address conditions that tend to be very site-specific. An adequate strategy for one location may prove ineffective or unnecessary at another. The following factors should be considered when planning site clearance.

### **Determine Disposition Option**

To date, all site clearance operations off California have occurred at sites where total removal of facilities, except for pipelines and power cables, was the only disposition option approved. This may not always be the case, as consideration is being given to disposition alternatives that might include leaving part of a structure on location, especially in deep water. Obviously, the scope of site clearance work will be determined by the disposition option chosen.

### **Determine Alternative Uses**

As previously noted, one of the primary goals of site clearance is to condition a location so that it is available to commercial trawling operators; assuming, of course, the facility is to be completely removed. Consultation with representatives of the trawling industry and fisheries regulators should be the basis for determining a site's suitability for any contemplated use. Information from representatives of other fisheries (commercial and recreational) and fisheries researchers should also be considered. The environmental setting of the area to be cleared also needs to be considered. Some facilities may not be located in an environment suitable for trawling or any other use that requires special site conditioning. The effort and expense of site clearance, beyond removal of potentially hazardous materials, may not be beneficial in such cases.

### **Review Operational History**

Regulatory agencies and operators maintain records that are useful in estimating the scope of site clearance effort that may be required.

Examples include "lost item" and mooring maintenance records, surveys that document seafloor debris and documented user conflicts, such as Fisherman's Contingency Fund claims.

Usually, the lead regulatory agency for reviewing the decommissioning project is in the best position to comprehensively assess such records. The lead agency also reviews the operational history of the lease if it is being relinquished. These reviews determine, in part, the size of the area that may have been impacted by all oil and gas activities, from exploration through decommissioning. On some leases, there may be unresolved site clearance issues related to early exploration drilling in the 1950s and 1960s, that would not be addressed if the focus is only on the immediate area surrounding the facility being decommissioned. In such cases, site clearance may only clear a small area in a field of obstructions and the site may not be trawlable unless there is a plan to address conditions present in the surrounding area.

### **Conduct Pre-clearance Surveys**

The two most recent decommissioning projects off California employed "pre-clearance surveys to estimate the extent of the debris field (see **CASE HISTORIES**). The most effective pre-clearance surveys employ very high-resolution side scan sonar technique to efficiently and accurately locate potential debris and other features of interest over relatively large areas. Earlier California decommissioning projects relied more on diver observations and ROVs (Remotely Operated Vehicles) equipped with video cameras and sector scan sonar. These techniques are more suitable for locating, assessing and assisting in removal and remediation near a work site or at previously surveyed locations. They are less effective than side scan sonar as a primary tool for systematically searching and locating debris over large areas and should not be depended on for that purpose unless the area is smaller than a few hundred feet in diameter.

There are a number of advantages in conducting a pre-clearance survey using side scan sonar. The technique is effective for providing a comprehensive overview of the

distribution of debris over a large area, thus providing some degree of assurance that far-field debris are not missed. Side scan surveys also provide information useful in assessing the potential for alternative uses of the site because it can document seafloor conditions, such as high relief rocky habitat, that preclude trawling. Although pre-clearance side scan surveys have, until recently, been considered to be an extra decommissioning expense, experience indicates the information gained can result in significantly lower ROV and dive costs by allowing more efficient use of those more expensive and time consuming techniques. Information from surveys completed prior to beginning removal work on a facility can also be used as a planning tool for minimizing adverse impacts on any sensitive habitat that may be located near the work area. However, one should be aware that the quality of the side scan sonar surveys can vary. The effectiveness of side scan sonar surveys for site clearance applications is improved by optimizing target detection rather than seafloor mapping capability. Pre-clearance surveys conducted primarily to document sensitive habitat prior to facility removal may need to be followed by a second survey, optimized for target detection, after the structure is removed (see **CASE HISTORIES**).

## **CLEARANCE AND VERIFICATION STRATEGIES**

Equipped with a comprehensive understanding of the site, with an emphasis on applying the results of a thorough evaluation of a pre-clearance survey, one should have a clear idea of the distribution and types of conditions that will require attention to prepare the site for alternative uses. As previously noted, most of the effort spent actually clearing the site involves removing debris. However, there may be other conditions at a site that require alternative methods of remediation.

### **Debris Removal**

Debris removal within a fixed radius of an offshore structure is usually an element of the facility removal contract. Debris density is usually highest near the structure, thus much, if not most, of the debris associated with a

facility is salvaged during its removal using the same equipment.

The salvage methods used during the removal of a facility depend primarily on using the divers and ROVs already on location while they are working near the base of the structure. This is an ideal arrangement for removing large or awkward items, as heavy lift equipment is already on location. However, once the structure has been dismantled and removed, the use of divers to locate and remove relatively small items scattered over an extended area is not cost effective. Good planning, based on a high quality pre-clearance survey, assures that all items requiring large capacity lift capability will be removed before demobilizing the derrick barge. Usually, any heavy items that remain on the seafloor are within the capacity of a suitably rigged anchor handling vessel, although most debris are actually salvaged using the dive/ROV support vessel.

Following removal of the facility and associated near-field debris, the most common method in the Gulf of Mexico for removing items that might remain is to trawl the area with nets. Site clearance trawling in the Gulf has resulted in the development of specialized, heavy-duty trawling gear with reinforced mesh, commonly known as "Gorilla Nets". These nets are dragged across the seafloor, often using a saturation pattern of traverses designed to provide 100% coverage of the clearance area in four directions (i.e., headings at 90° intervals). This may be one of the most efficient and cost effective methods to assure significant debris is removed over large areas. However, to date, such methods have not been used to clear a west coast site because suitable vessels are not generally available and the need to clear sites has been too infrequent to justify mobilizing and maintaining such a capability locally. It should also be noted that most west coast platform sites are located in water depths greater than the 300 foot cut-off depth for site clearance in the Gulf of Mexico. Deploying this type of gear in water depths greater than 500 feet would require significantly larger winch capacity and greater horsepower. Either factor might make this method a less viable alternative to removal techniques currently in use off California.

Local trawling vessels, with few exceptions, employ very small nets for deep water trawling and most of their available power is used to handle the very long cables required. Local vessels also tend to be efficiently sized and, thus, would be difficult to retrofit with the significantly larger power plants and winches needed to operate larger, heavier gear suitable for removing debris. The narrow margin of reserve power available in the local trawl fleet is part of the reason seemingly minor seafloor debris can cause them major problems.

Recent site clearance operations off California have relied primarily on ROV and diver methods for debris removal, although some local trawlermen have unintentionally participated in such work. An ROV equipped with sector scan sonar, video camera and using acoustic tracking, integrated with the primary surface navigation system, is the principal method employed to relocate and assess sonar targets from pre-clearance surveys. The advantages of an ROV vs. a diver are safety, ability to function for extended periods at great water depth, and the ability of sonar to locate targets beyond the range of visibility. The principal disadvantage of an ROV is the limited range of manipulative functions it can perform compared to human hands, which is why divers are still used for salvage operations at water depths less than a few hundred feet. Even in shallow water, ROVs are used to minimize diver time during search and assessment operations.

At water depths beyond a few hundred feet, salvage contractors rely almost solely on ROV methods. The most common strategy is to fit an ROV manipulator arm with a tool, suitably customized so that it is capable of attaching a line to the object. The line is then run to a surface vessel equipped with an adequately sized winch and the item retrieved. This is a tedious but effective method for the majority of debris encountered, although other methods may be needed for unusually awkward or heavy items. In such cases a separate, dedicated salvage operation may be required.

The heaviest item that might be routinely encountered are abandoned work boat moorings. Salvage of existing and known abandoned moorings is usually part of the

facility removal operation. However, it would not be unusual for a platform to have 10 or more mooring failures during a functional life of 30 years. Records may be inadequate for assuring all lost moorings were recovered, which is a reason to conduct a careful search around all known mooring locations for evidence of orphaned moorings. Sonar will usually detect any orphan moorings capable of causing problems for trawlers.

## Other Remedial Methods

Some potential obstructions may be abandoned in place if adequate measures are taken to remediate the problem. Typical examples are the severed ends of pipelines and power cables. Regulatory requirements require cut ends to be buried or otherwise conditioned so that they will not interfere with trawling. Burial is usually accomplished by divers using hydraulic jetting equipment. However, bottom type, pipe diameter or water depth may preclude burial. In such cases, some other form of end treatment, like articulated concrete mats or shrouds, may suffice to assure trawlability. Similar treatments may also be suitable for remediating other potential snags, like pipeline flanges.

Another class of features that can cause problems to trawlers are major seafloor alterations such as deep scars and mud mounds caused by mooring large work vessels such as the derrick barges used for removing structures. The seafloor perturbations caused by anchoring usually heal with time, due to natural processes, but it might require years. Past attempts at remediating such features have shown mixed results and some alternative mitigation that is advantageous to the affected user may be a more practical and immediate solution.

A more difficult seafloor alteration to remediate are the mounds of shell debris, mixed with drill cuttings and cement, that can accumulate under shallow water facilities where dispersion is minimal. The recent platforms decommissioned by Chevron (see **CASE HISTORIES**) were characterized by 20+ foot high mounds that are untrawlable and some form of alternative mitigation for permanent preclusion may be the only

practical option. In deep water, such accumulations tend to be dispersed over a larger area, although cement accumulations around well risers may have potential for damaging trawl gear. If relief is not excessive, articulated concrete mats may be a possible solution for remediating some of these conditions.

## Verification

The best method to test the adequacy of site clearance operations, when conditioning for trawling is the objective, is to trawl the area with the type of gear that will be used. Trawling tests were used to verify the two most recent California decommissioning projects (see **CASE HISTORIES**). In both cases, local fishermen were contracted, but the projects were quite different in execution.

In the shallow water Chevron project, a very dense pattern of trawl passes was scheduled, covering an area within a 1000 feet radius of each platform site. GPS navigation was used to accurately locate the position of each snag encountered and documented snags were systematically remediated and retrawled. The shell mound features that remained after the structures were removed were found to be untrawable with conventional gear. The mounds were also trawled with roller gear but some snags were still experienced. Other snags were encountered outside the clearance area, while making turns to line up for the next traverse. Some of these snags were caused by obstructions remaining from early exploration drilling.

In the Exxon project, the clearance area was relatively large, about 2 square miles, and in water depths that ranged from 300 to 700 feet. Although thorough, the clearance effort was considered an interim measure as the lease is still active and may need to be cleared again when it is relinquished. In this instance, trawl testing objectives focused only on areas with potential to cause problems. Because of the deep water and the difficulty in positioning the small (approximately 40 foot opening) net, acoustic tracking was installed on the net to assure precise knowledge of its position relative to the targeted test areas. The only snag encountered during test trawling was attributed to natural features.

When a site is not being conditioned for trawling, the most appropriate verification method is to conduct a post-clearance side scan sonar survey with methods similar to those used in the pre-clearance survey. A comparison of data from both surveys provides a comprehensive picture of what was accomplished during clearance operations and is an excellent method for documenting the final condition of the site.

Off-the-shelf software/hardware systems are now available that facilitate the construction of mosaics from sonar data, making such projects less labor intensive and more precise for use in before and after comparisons. Some software allows side scan sonar data to be interfaced with sector scan sonar used in ROV operations. The data can also be manipulated to help locate and classify potential debris targets that are hidden in background clutter on conventional facsimile displays of sonar data. The use of these data enhancement and analysis techniques will allow more definitive verification of future offshore site clearance projects.

## CASE HISTORIES

### Exxon, Santa Ynez Unit, SALM and OS&T Site

The first and only major site clearance project related to decommissioning a federal oil and gas facility off California occurred in 1994 following the removal of Exxon's Single Anchor Leg Mooring (SALM) and Offshore Storage and Treatment Vessel (OS&T). The SALM/OS&T facility was situated in approximately 500 ft of water, about 3.5 miles south of Gaviota, CA and was used to transfer, process and store production from platform Hondo between 1980 and 1994. With the addition of output from two new oil and gas platforms, all Santa Ynez Unit production was pipelined onshore to the new Las Flores Canyon processing facility, making the SALM/OS&T facility redundant.

There were a number of precedent setting aspects to the SALM/OS&T site clearance project which made it a challenging exercise, including:



- Deepest water site cleared on the federal OCS (possibly the world?)
- Motion of the OS&T around its mooring had potential to distribute debris over a large area
- Trawlers wanted access to the area although it was still under lease and site clearance, arguably, could be delayed until production ceased, 10 to 20 years later.

Exxon had already arranged for a site clearance program as part of the removal contract for the SALM/OS&T facility. The area proposed for clearance included areas around the SALM base, derrick barge moorings used for decommissioning, and at a number of other specified locations with suspected potential to impede trawling. Exxon's initial proposal met or even exceeded precedent, given the water depth. However, the MMS determined that a much larger area needed to be documented and cleared, if necessary, to be confident that the area being reopened would be trawlable.

The principal factors considered in reviewing Exxon's site clearance program included:

- dispersed debris field
- potential for debris from other activities in the vicinity, especially pipeline construction
- presence of natural obstructions in the area had been documented on prior surveys (high relief rocks)
- three partially exposed pipelines and a power cable decommissioned in-place, including the articulated concrete mats used to cover severed ends of pipelines
- Seafloor scars caused by derrick barge moorings, power cable moorings, pipelay operations and removal of SALM base pilings
- Documented loss of a large anchor from a tanker

After re-evaluating all these factors, Exxon agreed to significantly expand the scope of site clearance. Site clearance was conducted in two phases. The removal contractor would still perform phase 1 - "Facility Removal Area Clearance" and the additional area specified would be included in phase 2 - "Outer

Operational Area Clearance." Both phases used a three stage approach to site clearance: (1) pre-clearance sonar search, (2) target evaluation and remediation, (3) trawl testing for verification.

Phase 1 - Exxon's facility removal contractor surveyed a 1500 ft radius area around the center of the SALM base using a 500 kHz side scan sonar. Side scan sonar was also used to relocate the lost tanker anchor. An ROV mounted sector scan sonar was used to survey a 200 ft radius around each of the four derrick barge moorings to document anchor impacts.

All unidentified sonar targets were assessed using ROV video and potential obstructions were salvaged using the removal equipment on site. The cleared areas were then test trawled by a licensed commercial trawler using standard trawling gear. No obstructions were reported.

Phase 2 - Following SALM/OS&T removal operations, a second side scan sonar reconnaissance was conducted over approximately 2 square miles of seafloor, between Platform Hondo and the OS&T site. The water depth ranged between 300 and 760 feet and the survey included the area cleared by the removal contractor in Phase 1. The 500 kHz side scan sonar system was equipped with acoustic tracking integrated with surface navigation to facilitate accurate sonar target location. Sonar range and transect spacing provided better than 200% coverage of the survey area.

The Phase 2 side scan sonar survey located 270 sonar targets (including seafloor features). All sonar targets were cataloged, mapped and their sonar images classified for follow-up evaluation using an ROV.

The second stage of phase 2 clearance operations included ROV target identification and salvage. Approximately 60% of the sonar targets were selected for evaluation with an ROV because they had sonar signatures that suggested potential debris or obstructions. The ROV was equipped with sector scanning sonar and acoustic tracking to relocate targets, and video for evaluation and documentation. Targets considered to be

potential trawling hazards, were salvaged using the ROV. This required equipping the ROV with an appropriately designed tool to enable a cable to be attached to the item for recovery. A total of 36 items of debris were ultimately recovered in phase 2. Tires were the most common type of debris recovered (50% of total). A number of items were recovered from the area cleared in phase 1. We assume this was a consequence of the phase 1 contractor knowing a more comprehensive, site clearance effort would follow.

The final stage in phase 2 site clearance was verification using conventional trawl gear. Trawl verification efforts focused on specific areas where residual conditions might pose some risk of "snags" or net damage. The size of area, water depth and small size of deep water trawl nets used in the local fisheries made a typical 200% to 400% trawl verification strategy impractical, and probably unnecessary, given the thorough clearance effort already implemented. Intensive trawl verification was also considered premature in this case because the area could be subject to additional clearance efforts when production ceased on the active lease at some, undetermined, future date. Although trawl verification concentrated on the highest risk areas, and employed acoustic tracking to assure the net passed over potential hazards, no obstructions were encountered. Net damage did occur on one pass; however, the trawl operator believed the damage was caused because he strayed into high relief rocks outside the designated test areas.

The clearance effort following removal of the SALM/OS&T facility appears to have been successful as there have been no reported gear damage or losses during the year it has been accessible to trawlers. At the time this is being written, the three step approach to site clearance used by Exxon (i.e., pre-clearance sonar reconnaissance, evaluation/remediation, verification) serves as a working model for evaluating future California OCS site clearance proposals.

### **Chevron, "4-H" Platform Sites**

The most recent offshore site clearance operations conducted off California occurred

in 1996 following Chevron's decommissioning and removal of four platforms on California state leases seaward of Santa Barbara County, between Carpinteria and Summerland. Platforms Hilda, Hazel, Hope and Heidi, commonly referred to as the "4-H" platforms, were installed between 1958 and 1965. A total of 134 wells were drilled from these four relatively shallow water facilities (depths ranged from 98 to 141 feet). The primary objective of site clearance operations at the "4-H" platforms was to condition the areas impacted by the facilities so that they could be trawled. The effort expended by Chevron and their contractors in trying to accomplish that objective may be one of the most intensive site clearance exercises related to offshore oil and gas decommissioning, to date.

Factors considered in developing a site clearance strategy included:

- older, debris potential uncertain
- shallow water, debris probably concentrated close to platform
- significant accumulations of shell debris, mixed with, cement and drill cuttings at the base of the platforms.

Prior to commencing removal of the structures, a side scan sonar and bathymetry survey of the seafloor within a 1400 foot radius of each platform was conducted. A 500 kHz sidescan sonar system was used with range and transect spacing adequate to achieve a theoretical 400% coverage of the seafloor around each platform structure. The pre-decommissioning survey was used to locate debris and confirm the locations of active pipelines, power cables and sensitive habitat that would need to be avoided during decommissioning operations.

During the course of structure removal operations, debris located in the pre-decommissioning side scan sonar survey was removed by divers with ROV assistance. Facility elements abandoned in-place, such as pipelines, were buried by divers using hydraulic jetting technique.

Following removal of the "4-H" platforms and debris, a second, post-decommissioning, side scan sonar survey was conducted over an area that encompassed a 1000 foot radius

around each platform site and the area around the two temporary moorings used during removal operations. The post-removal survey was used to verify debris removal by comparing results to the earlier survey and to locate any new or residual features that might be a potential problem for trawl verification. Swath bathymetry studies were also conducted to document the mounds of shell debris that characterized all four sites.

A licensed commercial fisherman, using conventional trawling gear, was contracted to determine if the sites were adequately conditioned to allow snag-free, trawling operations. Trawl testing was conducted on a very dense, saturation grid employing 102, 2000 ft long traverses at each platform location (i.e., the area covered by the second side scan sonar survey). Trawl passes were spaced 40 ft apart with one half the traverses oriented N-S and the other half, E-W. The initial trawling trials occurred over a four month period in late 1996 (total of 46 working days) and a total of 25 snags were documented. More than half (14 of 25) were believed to be associated with pipelines or power cables; another 5 were located on the shell mounds at the old platform sites. Actually, more snags would have been recorded if attempts to trawl across the mounds had not been suspended early in the trawl testing program. The remaining 6 snags that were documented were associated with undetermined or natural features, or were encountered adjacent to, but outside, the designated clearance areas. By the time trawling trials with conventional gear were suspended (12/96), about 80% of the planned trawling was complete.

Chevron responded to the results of the initial trawl testing with additional efforts focused on eliminating snags, including two associated with an old drilling site outside the designated clearance zone. Later, in mid-1997, further trawl testing was attempted over the shell mounds using roller gear of the type Chevron had previously supplied to Santa Barbara Channel trawl operators as mitigation for problems alleged to be associated with one of their OCS pipelines. Preliminary reports indicate the roller trawls were significantly more successful in traversing the mounds but snags were still experienced.

As this case history is being written (9/97), the shell mound issue remains unresolved. Commercial trawl fishermen want the mounds removed to clear the area for their activities. However, others consider these relief features to be potential habitat that may enhance hook and line fisheries (commercial and recreational) and diving opportunities.

SLC project conditions require Chevron to conduct a follow-up seafloor survey one year after project completion, if warranted. In the meantime, it is clear that the shell mounds are not trawlable. However, this may be a classic example of a site condition that cannot, or should not, be directly mitigated. The mounds are about 200 to 220 feet in diameter and their relief above the original seafloor ranges from 22 to 26 feet. The average volume of material contained in each mound is estimated to be in excess of 8,000 cubic yards. The environmental impacts, that would result from removing, transporting and disposing of more than 30,000 cubic yards of material, would be significant. In such instances, alternative mitigation that addresses the needs of the affected users should be considered.

## CONCLUSIONS

Site clearance activities associated with the most recent offshore California oil and gas decommissioning projects are among the most thorough and sophisticated ever performed by the industry. Sonar search and mapping technology is being used effectively to document site conditions and the industry has shown considerable diligence in addressing potential user problems. In spite of these unprecedented efforts, some of the effects of production activities may not be easy or practical, or even reasonable, to remediate. High relief shell mounds that remained at the sites of four recently removed shallow water platforms will locally preclude some activities of one user group, although they may well enhance opportunities for others. Experience, to date, does not provide much precedent for dealing with the conflicting interests in such cases but they are an opportunity for alternative mitigation which could be more advantageous than eliminating certain types of obstructions when all interests are taken into account.

## REFERENCES

### Case Histories

Fugro West, Inc. February 1997. *Chevron State Platform Abandonments, Post Abandonment Debris Surveys, Platforms Hope, Heidi, Hazel & Hilda, Santa Barbara Channel, California*. Report prepared for American Pacific Marine, Inc. by J. Babbitt and J. Carothers, (Fugro West WO #96-7722/8401).

Exxon Company, U.S.A. August 1994. *Exxon OS&T Abandonment, Final Report*. Prepared by Exxon staff and contractors.

Fugro West, Inc. March 1996. *Chevron State Platform Abandonments, Pre-Abandonment Debris Survey, Platforms Hope, Heidi, Hazel, Hilda, Santa Barbara Channel, California*. Report prepared for American Pacific Marine, Inc. by J. Babbitt, D. E. Stutts, J. Carothers, (Fugro West WO# 96-83-7721).

Fugro West. July 1994. *OS&T Location Clearance Inspection, Santa Barbara Channel, California*. Report prepared for OPI International, Inc., by J. Babbitt.

Pelagos Corporation. July 1995. *OS&T Location Clearance Survey, OS&T Facility Abandonment Project, Santa Barbara Channel, California*. Report prepared for Exxon Company, U.S.A.

State Lands Commission, State of California. 1997. *Project Completion Report, Chevron U.S.A. Production Company, "4-H" Platforms Abandonment at Carpinteria*. Prepared by A. J. Naughton, (SLC File #: W410654, PRC 1824, PRC 3150).

### Side Scan Sonar

EG&G (no date). *Side Scan Sonar, A Comprehensive Presentation*. Prepared by: EG&G Environmental Equipment Division, 151 Bear Hill Rd., Waltham, Massachusetts 02154 (most recent version of this manual may still be available from EG&G at the above address).

Klein Associates, Inc. 1985. *Side Scan Sonar Training Manual*. Prepared by Charles Mazel (this or more recent versions may still be available from: Klein Associates, Inc., Undersea Search and Survey; Klein Drive; Salem, New Hampshire 03079).

Trabant, Peter K. 1984. *Applied High-Resolution Geophysical Methods. Off-shore Geoengineering Hazards, Chapter 5 - Side Scan Sonar* (pp. 61-81). General reference on offshore geophysical survey methods, published by International Human Resources Development Corporation (IHRDC), Boston 265p., (ISBN 0-934634-85-8).

## DECOMMISSIONING OF ONSHORE FACILITIES: TECHNICAL ISSUES

**LUIS F. PEREZ**

**Santa Barbara County Energy Division  
Santa Barbara, CA**

Decommissioning and removal of offshore facilities in most cases have onshore components that need to be considered at the same time that any offshore project is considered. Although the goals of decommissioning projects, whether offshore or onshore, are substantially the same, decommissioning of onshore facilities presents a different set of technical challenges from those of offshore facilities. Decommissioning is also affected by the different types of existing oil and gas facilities that are auxiliary to offshore development. Those facilities may include oil and gas processing facilities, marine terminals, pipelines, and storage facilities among others. Generally, the goal of decommissioning is to restore the site to its original, prior to oil and gas development state, or for some other predetermined and approved land use. Onshore facilities are generally decommissioned by removing aboveground facilities, testing for contamination, remediating if necessary, recontouring, and revegetating the site.

### REMOVAL

Removal is defined as the proper decommissioning, dismantling and disposal of all above ground facilities, appurtenances and any other obstruction or structure constructed for the operation of the oil and gas facility. In addition, removal also refers to the proper unearthing and disposal of underground facilities such as underground tanks and pipelines if deemed environmentally preferred.

Removal is typically done as a series of steps that include draining, cleaning and flushing all vessels; removal of all vessels, above ground piping, and appurtenances; removal of all buildings and foundations; removal of underground sumps, cables and piping; and loading and transporting of materials or equipment by truck to be recycled, sold, sold for scrap or disposed at an appropriate landfill.

During the draining and cleaning of all vessels care is taken to ensure no materials are spilled. In the cleanup of tanks, tank bottoms and residuals are removed using vacuum trucks or sump pumps. Tank walls are washed to bare metal with diesel and water. Tank bottoms, residuals and cleaning wastes are treated and recycled where possible by utilizing a mobile treatment unit or at an approved treatment and recycling facility.

The removal of all vessels and above ground piping entails unbolting equipment and cutting equipment into sections (if the equipment is not reusable) that can be easily transported to an appropriate recycling or salvaging facility, or for disposal.

Underground components include sumps, foundations, piping, underground tanks, electrical cables and conduits, and cathodic protection cables. Underground components are removed using trenching equipment and then are cut into transportable pieces. Decommissioning of pipelines used to ship oil, gas, and sometimes produced water generally entails inspection of the pipelines concurrent with survey and preparation of the site, followed by purging and capping of the pipelines. Pipelines are left in place or removed depending on burial depth and location. Pipelines that are buried less than 3 feet in depth are usually excavated and removed. Typically, pipelines are removed in creek crossings and other exposed areas to prevent future erosion. In some cases, pipelines are slurried with cement to ensure that their integrity is preserved through time.

### CONTAMINATION TESTING

Prior to facilities being removed, a preliminary inventory of existing equipment and hazardous materials should be collected. In addition, historical information can be used to ascertain potential sources of contaminants and types of

contaminants that may be encountered within the facility to be decommissioned. Historical information is also useful for documentation of previous spills or other incidents. The next step would be to conduct a preliminary surface and subsurface investigation. Typically, the sampling program at this stage should include a soil gas survey, shallow soil borings, chemical analysis and the preparation of a preliminary assessment report.

The initial sampling should take place in areas suspected of having the greatest probability of subsurface contamination. Sampling locations can be determined based on visual inspections, review of the site history and site surveys and evaluation by a qualified contractor. Trenches are usually excavated and earth materials examined, specially in former treatment, storage and processing areas of the facility.

The results of the preliminary investigation are used to determine if significant contamination has occurred. If it has, then an Environmental Assessment may be necessary to define the extent of the contamination. The Environmental Assessment will consist of more extensive testing including: soil testing, soil vapor testing (if applicable), groundwater testing (if applicable), health risk and ecological risk assessments as needed or required.

There are a number of sources of contamination associated with onshore oil and gas facilities. **Table 1** provides a list of potential contaminants associated with different types of oil and gas operations. Existing governmental regulations require remediation or containment of oil spills as they occur; additionally, regulations specify measures to protect vulnerable areas such as creeks from spills. However, accidental releases occur irrespective of, or before such regulations were effective and enforced. In addition, other sources of contamination are minor spills of crude oil from aging infrastructure, and spills of imported products that may contain hazardous substances. The types and causes of contamination vary widely, depending on operating procedures and processes used in a specific activity and historic period. For example, some processing operations active during the 1960s used fluids as a heat transfer

medium that contained PCBs before they were classified as suspected human carcinogens. Spills of these fluids during handling, processing, and storage left soils contaminated. In most cases, chronic leaks from tanks and pipelines usually result in remedial efforts during decommissioning .

Regulatory agencies typically base characterization of crude oil releases and level of remedial action on concentrations of total petroleum hydrocarbons and, in some instances, concentrations of individual soluble constituents such as benzene, toluene, ethylbenzene, and xylenes (collectively referred to as BTEX) and certain polynuclear aromatic hydrocarbons that are toxic in certain dosages.

If hazardous wastes are discovered in groundwater, the Regional Water Quality Control Board (RWQCB) can require remediation, depending upon type(s) and extent of hazards. If hazardous wastes are discovered in soil, RWQCB will investigate type and potential to leach through to groundwater, and propose remedial actions based on their findings.

## REMEDICATION OF CONTAMINATED SITES

Remediation is defined as the removal and proper disposition of unauthorized or accidental releases and/or contamination pertinent to the oil and gas process or related operation. Remediation must include areas affected by the unauthorized disposition or accidental release when contamination occurs off the site, but where the contamination is generated by the facilities operations.

The primary goals of remediating contaminated soils are to protect public health, to protect groundwater in rural areas necessary to support the state's agricultural industry and to protect sensitive environmental resources. Basic issues that take shape around remediation of soils and groundwater generally focus on type of contaminant, extent, cleanup level, cleanup methods, and timing of remediation. The type of contamination also weighs heavily in defining potential issues.

**Table 1<sup>1</sup>**  
**Listing of Potential Contaminants Associated with Oil & Gas Operations**

Process-Specific Equipment, or Type of Area	Possible Contaminants
Contaminated Soil around Oil Field Facilities and Equipment	The soil may contain one or more of the following: asphalt, BTEX (benzene, toluene, ethyl benzene, xylene), chemical residues, paraffin, salt, tar, and/or weathered oil.  BTEX will only be associated with light oil fields (i.e., high gravity oil production).
Drilling Muds	Elevated concentrations of chromium may be found in drilling mud pits which contain ferrochromelignosulfonates in the disposed drilling mud.
Cut-Labs	Cut-labs may have associated solvent waste disposal into a pit/sump, or into a dry well located near the lab.
Electric Distribution Centers	Some distribution centers may have PCB contamination from leaking transformers and other oil-filled equipment.
Filters	Some diatomaceous earth filters contained a precoat of asbestos fiber, or cellulose fiber. Old installations will have a disposal pit that probably contains asbestos fibers mixed with diatomaceous earth, and the solids filtered from the water.
Flares	Ash from burning crude will contain heavy metals. Area around flare may be contaminated with heavy metal salts.
Storage Yards	PCBs, other chemicals.
Hydrogen Sulfide Gas Scrubbers	Iron sponge units would leave a residue of metallic iron, iron sulfide and iron oxide (rust). Spent iron sponge can be pyrophoric.  Scrubbers that use the amine reaction unit may have elemental sulfur as an end product, and probably have sulfur storage areas or potential for sulfur spills.
Loading Areas	Likely areas where hydrocarbon spills, leaks or drainage can occur.
Oil and Gas Wells	Must be properly abandoned to prevent flow of oil, gas, or water to surface and to prevent communication between salt water and fresh water zones.  Early produced water spills from vintage 1950s fields may contain arsenic due to use of sodium arsenite in producing oil wells for corrosion inhibition.
Pipelines	Any hazard associated with pipelines will be due to either contained fluids, or to areas where leaks have occurred and contaminated the soil.
Pump Stations	Hazards at pump stations would be due to associated sumps or contaminated soil. Besides hydrocarbon spills, spills or leakage of thinners or diluents may be a concern.  Old pump stations may have used mercury-containing flow meters. Some mercury leakage or disposal may have occurred on-site.
Steam Lines	Some of the early thermal lines may have been wrapped with an asbestos-containing insulation.
Sumps/Pits	Materials contained in sumps can include asphalt, chemical wastes, drilling mud, formation solids, salts, tar, trash, waste lubricating oil, waste water, water, and weathered oil.
Tanks	Potential problems with tank farms include: contained solids, contained fluids, contaminated soil around or underneath the tanks, and associated pits or sumps.  The following materials may be found inside old oil field tanks: asphalt, chemicals, chemical residues, corrosion products, crude oil, crude oil diluent, diesel oil, drilling mud, filter sand and gravel, foaming agents for fire control, gas oils in gas storage tanks, gasoline, glycol and/or glycol residues, green sand, ion exchange resins, iron sponge, lubricating oil, road oil, salt, sand, solidified oil, tar, water, and waste water.
Water Treating Facilities	Chemicals used include emulsion breakers, coagulants, polymers, biocides, scale inhibitors and corrosion inhibitors.

<sup>1</sup>Scott, J. 1994. Santa Barbara County Oil and Gas Facilities Inventory.

When oil and gas sites are discovered to be contaminated with well-known toxins such as polychlorinated biphenals (PCBs) or with hydrocarbon, levels of remediation are determined based on assumptions about the potential to reach groundwater sources, the potential for damage to environmentally sensitive areas, and the future use of the land. Uses such as residences, education, and recreation dictate a higher level of remediation due to higher potential exposure of humans to health risks. Certain jurisdictions require cleanup levels that are protective of environmental resources in addition to being protective of human health.

**Table 2** shows the different types of contaminants and the potential hazards of hydrocarbon compounds associated with crude oil, drilling muds, solvents and metals. The potential paths of exposure include inhalation (of fugitive dust or vapors emitted from soils and waters), ingestion (of groundwater, surface water, and soils; or of produce, fruits, poultry, and livestock raised in area; or of seafood harvested nearshore if contaminants runoff into ocean; or from infant exposure through breast milk), and dermal contact with soil or water.

Crude oil contains hydrocarbon compounds which can be divided into four major structural forms: (1) alkanes, more commonly called paraffins, (2) cycloalkanes, more commonly called naphthenes or cycloparaffins, (3) alkenes, more commonly called olefins, and (4) arenes, more commonly called aromatics. Soluble and potentially toxic constituents of crude oil are usually limited to benzene, toluene, ethylbenzene, and xylenes (BTEX) along with certain types of polynuclear aromatic hydrocarbons. Aromatics contain BTEX. Monoaromatics (single 6-member carbon ring with three double bonds) are very water soluble compared to their alkane and alkene counterparts, and move easily into groundwater; in comparison, polynuclear aromatics (multiple 6-member carbon rings with three double bonds) range from moderately water soluble to relatively insoluble. Moreover, crude oil found in contaminated soils may have already degraded through evaporation, dilution with surface or groundwater, and chemical and biological oxidation (although generally aromatics will take longer to biodegrade).

## Remediation Methods

Recently, there have been positive results in remediating sites contaminated with crude oil by methods other than the typical treatment methods of excavation and disposal offsite. As an example, there is much promise in new applications of specially bred microbes to safely and effectively bioremediate hydrocarbon contamination. Bioremediation occurs naturally in soils, whereupon carbon-bearing molecules such as hydrocarbons from petroleum provide a source of nutrients to microflora. The microorganisms create a biofilm around the hydrocarbon molecule and digest it, or decompose it into simpler compounds of carbon and oxygen. Bioremediation can be accomplished *in situ*, which is the least expensive method when conditions are optimal, or *ex situ* (land farming and biopiles) which requires excavation and transport of the contaminated soils (*ex situ* can occur onsite or offsite).

Limiting factors to bioremediation appear to be soil and weather conditions as well as the acreage of contamination that can be effectively remediated. On the positive side, bioremediation appears to work, at least in some cases, on contaminated soils under and around operating equipment and tanks. Consequently, some bioremediation may occur in advance of full decommissioning activities.

Basic issues with various potential methods revolve around the adequacy for cleanup level, timing, environmental impact, and cost of one method versus another. Options should be considered and their feasibility should be analyzed during the planning of decommissioning. Table 3 provides with a description of some of the most common methods of soil and groundwater remediation.



**Table 2<sup>2</sup>**  
**Potential Hazards of Hydrocarbons**

HAZARDS IDENTIFICATION		
CATEGORY	SUBCATEGORY	HAZARD
ALIPHATICS	n-hexane	Peripheral neuropathy in humans
	branched chained alkanes	Hydrocarbon neuropathy in male rats only
AROMATICS	benzene	Group A carcinogen - leukemia in humans
	toluene	Solvent neurotoxicity; Prop 65 reproductive toxicant
	xylene	Solvent neurotoxicity
	ethylbenzene	Solvent neurotoxicity
METALS	barium	Relatively non-toxic as sulfate; soluble salts are toxic
	lead	Impairs neurodevelopment (Prop 65 listed); B2 carcinogen
	cadmiun	Group A inhalant carcinogen
	chromiun	Group A carcinogen by inhalation; B2 oral
	nickel	Some exposures (by inhalation) are carcinogenic
POLYCYCLIC AROMATIC HYDROCARB	non-carcinogenic PAHs (naphthalene, etc)	Systemic toxicity
	carcinogenic PAHs (benzoapryne, chryzene, etc.)	Group B2 dermal, inhalant, oral carcinogen
SOLVENTS	carbon tetrachloride	Group B2 carcinogen
	tetrachloroethane	Group B2 carcinogen
	trichloroethane	Group D carcinogen
	trychloroehylene	Group B2 carcinogen
	methylene chloride	Group B2 carcinogen
	Mainly liver tumors and hepatotoxicity	

EPA Carcinogen Classification:

Group A: Human Carcinogen

Group B: Probable Human Carcinogen

Group C: Possible Human Carcinogen

Group D: Not Classifiable

Group E: Negative Evidence

<sup>2</sup>USEPA. 1989. United States Environmental Protection Agency. Health Effects Assessments Summary Tables and Users Guide. USEPA Office of Emergency and Remedial Response, USEPA, Washington, D.C.

**Table 3<sup>3</sup>**  
**Remediation Techniques**

TECHNIQUE	DESCRIPTION
Physical Barrier - Membrane Barriers and Sheetpile	<p>A synthetic membrane barrier such as High Density Polyethylene (HDPE) walls can be used as a short term measure to contain the lateral movement of separate-phase contaminants that float on the water table. Ground water does not penetrate the membrane barrier, but it does continue to flow under and around the barrier. A ground water extraction system may be installed on the upgradient side of the barrier to reduce hydraulic pressures and improve hydraulic control. The HDPE material is resistant to penetration by plant roots and burrowing animals, and inspection/maintenance related requirements should not be required.</p> <p>Due to the strength of the steel piles, sheetpiling can be used to retain soils during excavation and minimize the disturbed area. With this process option, interlocking steel sheets are vibrated or pounded through the soil to the required depth. The sheetpiling retards the lateral movement of separate-phase hydrocarbon, but less than the synthetic membrane option. This is an alternative to installation of HDPE barriers using excavation and trenching.</p>
Vacuum Enhanced Drop Tube	<p>Vacuum-enhanced drop tube recovery removes separate-phase contaminants from the subsurface, which reduces chemical volume. This technique consists of a small diameter drop tube placed at or below the liquid level in a vertical extraction well. A high vacuum would be applied to the drop tube which would quickly draw soil vapor through the drop tube. The vacuum also aids in oxygenation of the soil column above the water table (the vadose zone) which in turn aids in the biodegradation process. Ground water and separate-phase contaminant would also be drawn out of the well and mixed in the turbulent flow in the drop tube. The vapor would be separated from the mixed liquids and each would be disposed of using other options.</p>
Dual Pump Recovery	<p>Dual-pump recovery provides both containment of the separate-phase contaminant, which reduces mobility, and contaminant removal, which reduces chemical volume. This technique involves installing vertical extraction wells and pumping ground water with a submersible pump set at the bottom of the well and pumping separate-phase contaminants with a skimming pump set at the top of the liquid in the well. The extracted ground water and the separate-phase contaminant would be handled using other techniques. Wells should be installed along the downstream edge of the separate phase plumes with overlapping "cones of depression" to ensure that separate-phase contaminant would be captured along the entire edge of the plume.</p>
Excavation	<p>This technique consists of removing separate-phase contaminant from selected areas using a track-mounted excavator or other conventional excavation equipment. Once excavated, separate-phase contaminants and contaminated soil needs to be treated. It can be hauled to a bioremediation site for treatment. Clean overburden soil should be stockpiled and redistributed over the excavated area after the pit is backfilled with treated soils.</p>
Vertical or Horizontal Biosparging	<p>With this process, air is introduced to the subsurface below the water table to promote the growth of aerobic microorganisms which could degrade dissolved-phase contaminants. Biosparging can be accomplished continuously or in a pulsed fashion through vertical or horizontal wells. As the injected air sweeps upward through the contaminant-affected ground water and soil, it may also transfer volatile compounds from a liquid to a vapor phase.</p>
Ground Water Extraction	<p>This process consists of pumping dissolved-phase contaminant from ground water extraction wells. Ground water extraction can provide both hydraulic containment, which can prevent chemical migration, and dissolved-phase contaminant removal, which can reduce chemical volume. The extracted ground water would then be treated and discharged using other technologies.</p>

<sup>3</sup>Arthur D. Little. 1997. Guadalupe Oil Field Environmental Impact Report, Public Draft.

**Extracted Material Treatment**

TECHNIQUE	DESCRIPTION
Oil/Water Separation	With this process option, extracted ground water with entrained separate-phase contaminant would be pumped into a large holding tank where gravity would separate the immiscible hydrocarbon from the water. Baffles and separation plates are used to prevent short-circuiting and increase separation efficiency.
Liquid-Phase Carbon Adsorption	This process would treat extracted ground water, removing dissolved-phase contaminant from extracted ground water by pumping it through two or more vessels containing granular activated carbon (GAC) connected in series. As the water is passed through the carbon beds, the petroleum hydrocarbons would become adsorbed onto the GAC. After the GAC becomes saturated with hydrocarbons, it would be replaced with fresh GAC. The used GAC would be transported to an off-site facility for regeneration. This technology is proposed as a process to treat extracted dissolved-phase ground water or water taken from a separate-phase treatment technology.
Recycling	With this process option, recovered hydrocarbon would be transported to A nearby Refinery and reprocessed into other products.
Deep Well Injection	Under this disposal option, untreated or partially treated water generated by remediation activities would be pumped down unused oil wells into the oil-bearing formation thousands of feet underground. Liquids generated by pumping in the beach area and by various pilot tests have been injected under permit as Class I fluids in this manner.
Landfarm Bioremediation	Landfarm bioremediation utilizes naturally occurring micro-organisms for the degradation of the hydrocarbons. Exposing the affected soils to the air and adding moisture and other nutrients enhances the activity of the microorganism, resulting in increased rates of hydrocarbon degradation. During operations, soil will be periodically wetted down with water pumped from existing on-site wells to maintain an optimum moisture content for biodegradation. Nutrients may also be sprayed over the excavated soil, or nutrients could be introduced by tilling the affected soil with compost and other amendments. On a periodic basis, (e.g., every few weeks) soil should be tilled or disked with conventional earthworking equipment.
Air-Phase Carbon Adsorption	This process would treat extracted air from the vacuum drop tube systems, removing contaminant from the extracted air by routing it through vessels connected in series and containing GAC. As the air is passed through the carbon beds, the petroleum hydrocarbons would become adsorbed onto the GAC. After the GAC becomes saturated with hydrocarbons, it would be replaced with fresh GAC. The used GAC would be transported to an off-site facility for regeneration.

**Restoration**

Restoration and recontouring is defined as the process by which the land is returned to its original state. General procedures for restoration include minor recontouring and grading, including backfilling and ground leveling; preparing topsoil; drainage control; and installing slope stabilization measures, and other erosion control and soil stabilization measures as needed.

Recontouring and regrading may be necessary in areas where large pieces of equipment or foundations are excavated and removed. In general, sites should be returned to more natural contours depending on the subsequent land use. Backfilling and soil importation may be necessary in some areas, specially where facilities are excavated or where remediation measures require transport of soils offsite. Imported topsoil

must be fertile, friable topsoil of character and texture similar to the project site soil. In addition, the soil should be without a mixture of subsoil materials, obtained from a well drained arable site, reasonably free from clays, lumps, coarse sands, stones, plants, and other foreign materials. Finish grading should include provision of positive surface drainage of planted areas. Existing drainage flowlines should be utilized as much as possible. Erosion control measures include straw bails, silt fences, jute netting, water bars, diversion channels, etc., and should be used as needed depending on the site topography and final contours.

**Revegetation**

Revegetation is the replanting and re-establishment, where appropriate, of native

species previously removed during the construction of the facility or known to exist in the surrounding area of the facility to be decommissioned. Revegetation of a decommissioned site requires a number of steps that include site and seedbed preparation, seeding, mulching, fencing and irrigating.

Site preparation includes breaking up compacted soils by disking or other methods, and mixing imported soils with the existing material. Chiseling also restores soil permeability. Mulching with finely chipped vegetation or straw may be needed to improve the seedbed.

Only species and species varieties adaptable to local soil and climatic conditions should be used for seeding. Seeding techniques may include broadcasting, drilling, hydromulching or other appropriate techniques or combinations thereof. Fertilizers and soil amendments should be used as needed, to optimize revegetation success. Seeding should occur at a time of the year when seeds are most likely to receive moisture and germinate, generally in late fall.

Mulches are applied to seedbeds to retard soil erosion, moderate surface temperatures, retain moisture and provide shade for seedlings. Mulches are recommended for steep slopes and on rocky, shallow soils or exposed windy slopes. One of the most effective and universally available mulches is grain straw.

Trees and other planted vegetation may require irrigation after planting and then periodically thereafter to ensure revegetative success. In some areas fencing may be necessary to keep livestock from trampling new seedlings or predators from eating the seeds.

Inspection and monitoring of the revegetation effort should be conducted by a landscape contractor or revegetation expert to ensure that the prescribed maintenance procedures are being carried out and to determine that the revegetation is effective. Additional maintenance activities may include herbicide treatments and reseeding where necessary.

---

---

## **ENVIRONMENTAL SESSION**

---

### **Environmental and Socio-Economic Effects Occurring During the Decommissioning and Removal Process and Measures for Mitigating Impacts**

Air Quality, Peter Cattle .....	93
Platform Decommissioning: Commercial and Recreational Fisheries Effects, Dr. Craig Fusaro.....	95
The Commercial Fishing Industry in South/Central California, Dr. Craig Fusaro and John Richards .....	97
Fisheries Impacts of Explosives Used in Platform Salvage, Dr. Ann Scarborough Bull .....	104
Effects of Decommissioning Activities on Marine Benthos, Ray deWit.....	105



## AIR QUALITY

### PETER CANTLE

Santa Barbara County Air Pollution Control District

#### AIR QUALITY AND FACILITY ABANDONMENT

##### Air Quality Impacts and Issues

- Decommissioning and abandonment

##### Possible abandonment scenarios

- Full removal, onshore disposal
- Complete (or nearly so) abandonment in place

##### Abandonment process overview

- Apply past experience to future projects
- Scope of project – size and equipment array
- Timing and scheduling of project
- Regulatory setting
- Minimize air quality impacts considering other issues

##### Conclusions and Summary

#### AIR QUALITY ISSUES AND IMPACTS

These are Interesting Times!

##### Santa Barbara, Ventura Counties – 100+ years of oil development

- 1980's – massive OCS development, planning, environmental assessment, mitigation

**Challenge of past: develop and extract**

**Challenge of future: remove and minimize impacts, cost**

#### POSSIBLE ABANDONMENT SCENARIOS

Many combinations, including ...

- Full Onshore / Full Offshore
- Full Onshore / Partial Offshore
- Full Onshore / Non-Removal Offshore

**Each has different air quality (and other) impacts**

#### ABANDONMENT PROCESS AND EQUIPMENT

**Surveying (occurs throughout project)**

**Vessels: Side-scan sonar, marine mammals**

**Topsides preparation, removal**

- Cutting, welding, derrick and cargo barges
- Workboats, tugs, support vessels

**Jacket preparation, cutting and removal**

- Cleaning equipment, cutting, welding, diving support
- Derricks, hoisting equipment, cargo barges, workboats, tugs

**Transport**

- Tugs, workboats
- Derrick barge, cargo barges

#### ABANDONMENT EQUIPMENT

**Onshore...**

**Processes vary according to facility**

- Battles Gas Plant

**Equipment required includes:**

- Cranes, hoisting equipment, welding, cutting
- Haul trucks, dozers, scrapers, graders, backhoes
- Contaminated site clean-up equipment

**WILD CARD – SCOPE of Project**

## AIR QUALITY AND RELATED ISSUES

### Scope

- Deep water, massive structures
- Major equipment, major emissions anticipated
- Time required to complete abandonment (whatever project is approved)

### Project Timing

- Size and weather may dictate longer schedule
- Ozone season in Santa Barbara (May – October)
- Gray Whale migration (November – June)
- Potentially two or more years needed

### Staging of Project

- Scope may require “shuttling” of materials
- Staging areas (e.g., Coho Bay)
- Repetitious, high-emissions work
- Additional loading, unloading

### Interagency Coordination

- Many agencies, entities involved
- Jurisdictional concerns and questions likely
  - Safety
  - Marine mammals
  - Air quality
- Minimize air quality impacts in concert with other issue areas

## AIR QUALITY REGULATORY SETTING

### Permits required for abandonment, removal

### New Source Review triggered

### Best Available Control Technology required

- Reduce project emissions
- Typical engine controls
  - Timing retard

Turbocharging  
Intercooling

- Safety

### Offsets – state law prohibits offsets for abandonment

### State Portable Equipment Registration Program

- Applies to onshore portable equipment
- May apply offshore eventually

### Chevron / APCD agreement

- Shutdown credits to offset abandonment emissions only
- Go to “Clean Air Benefit” afterward
- Credits not banked for future use

## CONCLUSIONS

### “Continuum” of available options

### Air quality impacts are greater with...

- Longer projects
- Projects that occur in “ozone season”
- Larger equipment array
- More, and more frequent heavy lifts
- Positioning, shuttling, cycling of equipment

### Air quality impacts are lessened with...

- Shorter duration projects
- Projects that effectively avoid ozone season
- Less equipment and fewer operating hours
- Fewer heavy lifts
- Less positioning, shuttling, cycling of equipment

## CONCLUSION

### Best air quality option

- Topsides removal
- Partial removal of jacket
- Abandon the rest in place



## PLATFORM DECOMMISSIONING: COMMERCIAL AND RECREATIONAL FISHERIES EFFECTS

**DR. CRAIG FUSARO**

Director, Joint Oil Fisheries Liaison Office

### COMMERCIAL FISHERIES

- Trap for crab, lobster, shrimp
- Trawl for halibut, shrimp, cucumbers, sole, rockcod
- Drift gillnet for swordfish, shark, seabass
- Purse seine for squid, sardines
- Hook and line for rockcod
- Troll for salmon

### RECREATIONAL FISHERIES

- Commercial Sportfishing Charters for kelp bass, rockcod, seabass, halibut, bonito, barracuda, salmon, shark, warmwater exotics, etc.
- Private sport fishing boat fleet, similar target species
- Commercial Diveboat Charters for lobster, spearfishing or nonconsumptive uses
- Private sport dive boat fleet, similar purposes

### OPTION 1: FULL PLATFORM REMOVAL

- Areal preclusion -<sup>1</sup>
- Gear damage -
- Debris - or +
- Vessel traffic -
- Potential fish dispersal (noise) - or +

### OPTION 2: NON-REMOVAL, ALTERNATE USE

- No removal operations = no effects

### OPTION 3: PARTIAL JACKET REMOVAL, ARTIFICIAL REEF

- Areal preclusion -
- Gear damage -
- Debris - or +
- Vessel traffic -
- Potential fish dispersal (noise) - or +

### OPTION 4: MOVE JACKET TO ARTIFICIAL REEF SITE

- Areal preclusion, two sites -
- Gear damage -
- Debris - or +
- Vessel traffic -
- Potential fish dispersal (noise) - or +

### OPTION 5: DEEPWATER DISPOSAL OF JACKET

- Areal preclusion, possible two sites -
- Gear damage -
- Debris - or +
- Vessel traffic -
- Potential fish dispersal (noise) - or +

<sup>1</sup>- and + refer to the negative or positive impacts of the activity on fishers.

**OPTION 6: FULL PIPELINE REMOVAL**

- Areal preclusion along pipeline route –
- Gear damage –
- Debris – or +
- Vessel traffic –
- Potential fish dispersal (noise) – or +

**OPTION 7: PARTIAL PIPELINE REMOVAL**

- Areal preclusion, part of pipeline route –
- Gear damage –
- Debris – or +
- Vessel traffic –
- Potential fish dispersal (noise) – or +

**OPTION 8: ONSHORE FACILITY REMOVAL & RESTORATION**

- Not directly relevant to commercial or recreational fisheries

**SUMMARY OF POTENTIAL EFFECTS**

- Areal preclusion –
- Gear damage –
- Debris – or +
- Vessel traffic –
- Potential fish dispersal (noise) – or +

**OIL INDUSTRY / COMMERCIAL FISHERIES PROGRAMS FOR POTENTIAL IMPACTS**

- Debris: Site clearance work following all removal operations
- Gear Damage: Agreements to reimburse for damaged/lost gear
- Vessel Traffic: Oil Industry Service Vessel Traffic Corridor Program

**OUTSTANDING ISSUES**

- Areal preclusion during decommissioning operations
- Debris missed by site clearance procedures
- Vessel traffic to and from areas not covered by agreed-upon traffic corridors

## THE COMMERCIAL FISHING INDUSTRY IN SOUTH/CENTRAL CALIFORNIA

**DR. CRAIG FUSARO**

Director, Joint Oil Fisheries Liaison Office

and

**JOHN RICHARDS**

Sea Grant Extension Program

### INTRODUCTION

This section describes various commercial fishing activities currently operating along the south/central coast of California. This region roughly corresponds to Region II of the federal and California state geophysical permit programs. This region also corresponds with an area of high interest to the oil and geophysical industries.

Information presented here covers fishing seasons and areas for a number of active fishery types in the area, as well as descriptions of commercial fishing techniques, gear, and vessels to be found here. In addition, key fishing industry, government, and local contact information is provided to facilitate the dissemination of the information regarding geophysical programs. These contacts can often provide further and/or more recent information on commercial fishing activities.

Commercial fishing in the south/central region of California, ranging from the port of Morro Bay in San Luis Obispo County to Port Hueneme in Ventura County, is unique in at least two ways. First, the number and types of fishing gear used and species caught is quite varied, and over 20 species are harvested commercially. Second, much of the fish caught in the Santa Barbara Channel and Santa Maria Basin fishing grounds is marketed primarily as fresh fish to markets and restaurants, rather than reduced or frozen for sales to large distribution networks. Some fisheries are dependent on highly migratory or unpredictable stocks, and therefore may change radically in size from one year to the next.

Other sources for information on current fishing activity in any given area are (in no particular order) the Unit Managers of the California

Department of Fish and Game (Morro Bay and Santa Barbara Regional Units), the Santa Barbara Sea Grant Marine Advisory Office, and the Joint Oil/Fisheries Liaison Office. These offices will usually be aware of the most recent trends in fisheries activities for their respective areas.

This paper presents information on fishing seasons, and then provides aid to geophysical survey vessel operators on how to recognize fishing gear types from visible signs of fishing gear on the surface of the water. Each fishery is then discussed in turn, providing a brief description of fishing techniques, gear, and vessels. All information on a particular fishery is grouped together in this way for convenient reference.

### THE CRAB FISHERY

The commercial crab fishery in south/central California seeks two different groups of crabs. The largest crab fishery is for what is commonly called 'rock crab,' a composite of three species: red rock crab, yellow crab, and brown crab. The red rock crab is caught primarily around or on submerged rocky outcrop areas. The other types are caught in areas of low relief sand or sandy mud bottom. This fishery is active all year, and many of the fishermen who fish crab gear also fish lobster gear in lobster season (October-March).

Traps are basically wire, plastic coated wire, or plastic mesh boxes 2, 3, or 4 feet square which are weighted to stay in place on the seafloor (**Figure 1**). Braided polypropylene rope (usually 3/8 inch diameter) is used to deploy and retrieve traps, which are set in nearshore waters from shore to 40 or 50 fathoms deep.

**Figure 1.** Crab and Lobster Traps, as deployed.

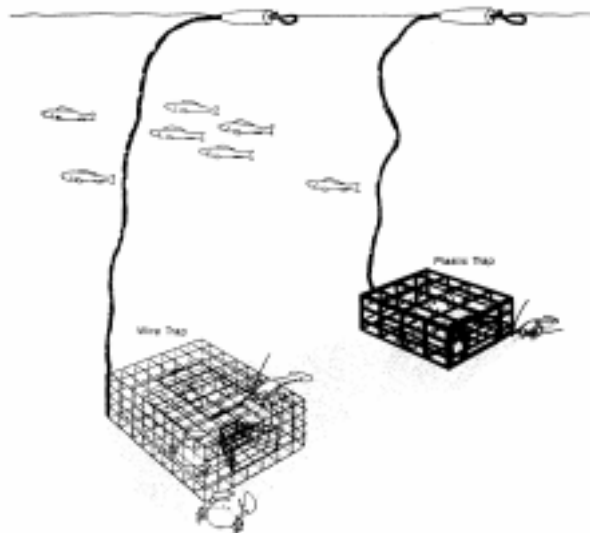

Crab traps (pots) are baited and deployed in fishing grounds. The pots are commonly left to fish ('soaking') for about 3 days, and are then retrieved. The crab fishing vessel pulls alongside the pot buoy(s), grapples the buoy on deck, feeds the line through a 'pinch-puller' winch of some kind, and raises the pot from the seafloor. The crabs are taken from the pot, it is rebaited, and redeployed. Normal fishing practice dictates the movements of trap locations: if the traps are fishing well, they are left where they are. If the traps are not catching much, they will usually be moved to try a new location. In practice this means that groups, or 'strings' of gear will be moving from one location to another on an unpredictable time schedule dictated by crab population movements. It is therefore difficult to predict the location of any particular string of gear at a given time. Most full-time crab fishermen have at least 50-70 pots, and many crab fishermen have upwards of several hundred pots arranged in 'strings' of from 5-25 individual traps set along particular depth contours.

The vessels used in the commercial rock crab fishery are most often smaller than their Alaskan counterparts, ranging from about 20 to 40 feet in length (**Figure 2**). Most often these smaller, faster boats are equipped with a small davit and winch, or crab pot-puller of some kind to haul in the gear from depth. Since these vessels are smaller, and since many crab fishermen have

upwards of several hundred pots, this means that pots are deployed over several trips to get full operational capacity (one such vessel may only safely carry 10 to 30 pots at a time), and relocating gear must also be done in increments allowed by deck space.

**Figure 2.** Crab or Lobster Vessel, Fore Deck.



The second crab fishery is a southern extension of a larger, northern California to Alaska fishery for Dungeness crab. Both the trap and buoy systems are somewhat different for this fishery, and the Dungeness crab fishery is highly variable in this area, depending on signs of stock early in the season. This fishery extends from northern California south through the Santa Maria Basin to Point Arguello in some years. Dungeness crab vessels tend to be larger (25-75 feet) than those fishing rock crab south of Point Conception.

From a practical standpoint in locating and assessing the deployment pattern of a string of pots, it is important to consider the effects of tide and current strength on the line and buoy, and windage on the buoy, in determining the actual location of the gear. During conditions of high tide, strong currents or high winds, buoys may be below sea surface and therefore not visible until conditions slacken. Rough seas may also make spotting buoys more difficult.

Most of the crab, rock or Dungeness, are marketed locally (within a 300 mile radius of the Region) to fresh fish wholesalers, markets, or restaurants, and marketing crab is highly competitive. If a particular crab fisherman cannot assure his market of a steady supply, he/she is not likely to continue to be able to sell to that market, since the market can seek product from other more steady producers of crab. Minimizing interactions with crab

fishermen and their gear therefore minimizes the potential for altering an individual's position in this highly competitive market.

## THE LOBSTER FISHERY

The lobster fishery is quite similar to the crab fishery. The pots used are of a similar size, with similar buoys marking their location, and are fished by similar size vessels. In fact, most crab fishermen also fish lobster, changing over some of their crab gear to lobster gear, or adding strings of lobster gear to their deployed crab gear in nearshore waters. Some fishermen target only on lobster and do not fish crab, thus adding to the total number of vessels, and pot gear, in nearshore waters during the season. One of the main differences between crab and lobster fishing is that lobster fishing is confined to a specific season; fall through winter. Opening day of lobster is the first Wednesday in October, and the season closes on the first Wednesday after the 15<sup>th</sup> of March. Another difference in lobster gear deployment patterns is that in addition to arranging pots along depth contours in 'strings,' lobster pots are also grouped in clusters which fringe rocky outcrops on the seafloor, since the lobster may sometimes be found in association with these outcrops.

Typically at the beginning of the season there is a certain amount of 'jockeying' for desirable positions along the coastline among lobster fishermen, as they establish their positions relative to one another along the coast and at the Channel Islands early in the season. The Department of Fish & Game allows fishermen to set out their gear a few days before the season actually starts, provided they are unbaited, with the doors open. It is therefore most usual to see a rapid buildup of large numbers of lobster pots in nearshore areas quickly in early October.

At the beginning of the season, most pots are set in shallow water, hugging the shoreline. As the season progresses, the gear is likely to be found further and further from shore, as fishermen follow the movements of the lobster population offshore into deeper water throughout the season. Toward the end of the season (March), it would not be unusual to find most of the gear in the 20-40 fathom range.

The gear is fished in exactly the same manner as crab pots: the fishing vessel pulls alongside the surface buoy, grapples it aboard, runs the line through a pinch-pulley of some kind, and hydraulically lifts the pot from the seafloor. Lobster are removed, the pot is rebaited, and redeployed. The pot is put in the same place it was taken from if it fished well, or moved to another location if it did not fish well.

The lobster catch is also marketed on a local basis, most of it going to wholesale or retail fresh markets or restaurants within a 300 mile radius of this region.

## THE GILLNET FISHERY

Two types of gillnets are in common use in the Santa Barbara Channel and Santa Maria Basin and they are very distinct in the way they are fished. The first type is the set gillnet, which is set in place with anchors on the seafloor and left unattended to fish ("soaking") for a period of 24 hours or so. The second is the drift gillnet, which is a floating net with a lighted buoy at one end, attached to the fishing vessel at the other end (**Figure 4**). Each of these types of gillnets will be considered separately.

### Set Gillnets

Since 1994, set gill nets have been banned for use within State waters, except in certain areas where deepwater rockfish nets are now being set. The species sought by these set nets are halibut, seabass, angel shark, other sharks, rockfish, queenfish and kingfish.

A set gillnet is attached to an anchor-and-buoy line at both ends (**Figure 3**). Commonly, gillnet buoys have flags marking the ends, for ease of visibility. Set gillnets range in length from a hundred yards to a half mile or so in length, depending on how many 'gangs' or pieces of net webbing are hung together between anchor lines. The net is set at some time of day, or night, and usually retrieved within 24 hours. Fish are taken from the net as it is pulled aboard, or worked over the deck and redeployed in place, depending on whether the net is to be relocated or not. As in the crab and lobster fishery, the decision to relocate gear is based on the catch rate of the net in the current location. Nets may be arranged so the net material itself

is close to the surface, at midwater, or near the bottom.

Figure 3. Set gillnet, deployed.

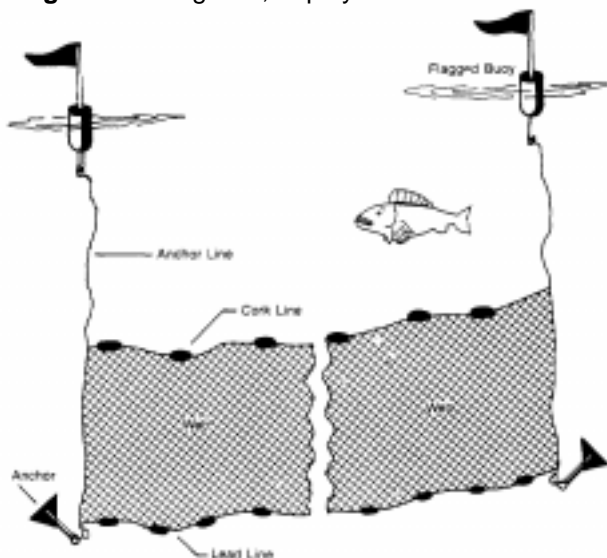

### Drift Gillnets

This type of gillnet is not left unattended, and most often, one end of the drift net is attached to the fishing vessel. The drift net fishery operates in a much different area of the Santa Barbara Channel and Santa Maria Basin regions than the set net fishery does. Fish species sought in this fishery are swordfish and thresher shark, but some incidental catch of other pelagic species like opah is also now common since a strong market is developing for such species.

Figure 4. Drift Gillnet – Structure of Gear.

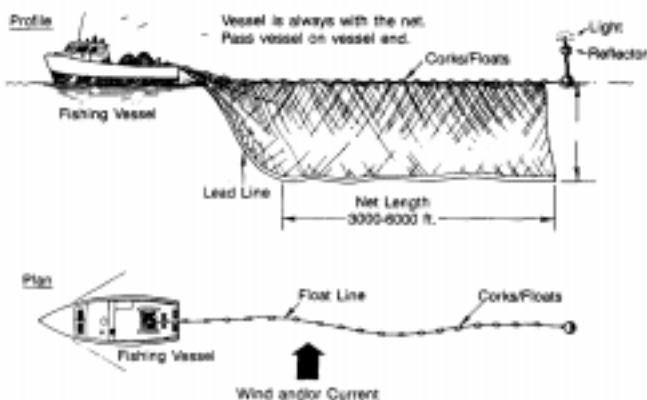

Drift nets are often much longer than set gillnets, and may be as long as a mile or mile and a half (Figure 4). This is significant from a gear interaction viewpoint because drift gillnet vessels

may have restricted ability to maneuver similar to geophysical survey vessels with a 1-2 mile long cable out. The end of the net not attached to the fishing vessel usually has a radar reflector/lighted buoy attached to it, but may not be immediately obvious because it is so far from the vessel. Since drift gillnetting is usually done at night, and often during the darker phases of the moon, this compounds the necessity to be aware of the configuration of drift gillnet operations. Normally the vessel will be at the leeward end of the drifting net equipment. A drift gillnet can be fished anywhere from right at the surface to 30 or 40 feet below the surface.

The vessels used in both the set and drift gillnet fisheries vary in size and shape, but might be classified into two categories: 1) smaller (28-40 feet), faster craft similar to the crab and lobster vessels commonly in use in the region, and 2) larger (40-60 feet), more traditional fishing hulls. In either of these cases, the gillnet boat is readily distinguishable from other vessels of similar design and size by the presence of a large (4 to 10 feet) reel on which the gillnet is spooled when not in use (Figure 5). This reel may be mounted on a fore deck, or aft deck.

Figure 5. Vessel- Gillnet.



### THE HOOK AND LINE FISHERY

This fishery primarily targets several species of rockfish, such as the red (vermillion), bocaccio, chili, and several others; incidental catch includes rocky reef associated fish such as lingcod and cabezon. The fishery has no seasonal restrictions, but is most active during the fall and winter months. This fishery as it exists in the Santa Barbara Channel and Santa Maria Basin is a "fallback" fishery for some of

the fishermen who enter it, since many of these fishermen also fish in other fisheries during other times of the year. Some boats however, operate hook & line gear as their primary and only fishery. As such, a variety of vessel types and sizes are involved in the fishery, ranging in size from weekend skiffs with rod and reel to larger commercial vessels from other fleet types, using buoyed, vertical longline techniques.

Most often, hook and line fishermen use their fathometers to seek out relatively deep water rocky outcrops having "stacks" of fish showing over them. A buoyed vertical longline with groups, or "gangions" of baited hooks on them is placed in the water where they find these "stacks" of fish (**Figure 6**). The lines are then retrieved, any fish hooked are removed, the hooks rebaited, and the process is repeated. Since it is not always possible to tell exactly where the gear is deployed near the boat, a 1/4 mile clearance around working hook and line vessels is advisable.

**Figure 6.** Hook and Line Gear, Deployed.

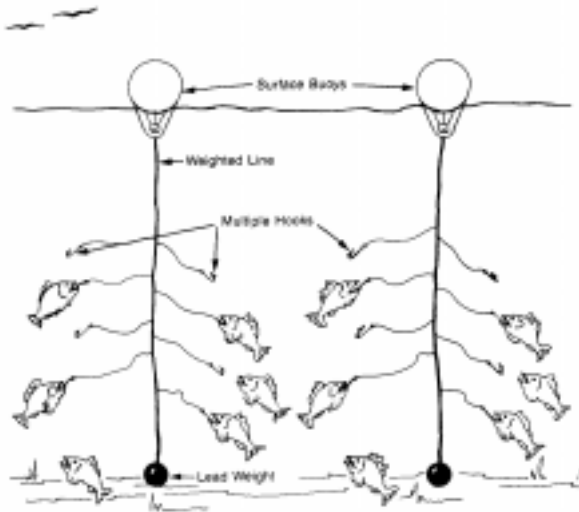

## THE TRAWL FISHERY

The trawl fishery, in distinct contrast to the crab, lobster, and set gillnet fisheries, is a mobile fishery in which a trawl net or double net rig is towed behind the fishing vessel at slow speed, either in midwater, or, more commonly in this region, along the bottom, giving the name "dragboat" to the trawl fishing vessels here (**Figure 7**). Most of the vessels are large for commercial fishing vessels of this area, ranging

from 40 to 80 feet in length. These vessels are readily identifiable when the net is not deployed because of the net 'otter boards' or 'doors' which are usually hung near the stern of the vessel, and the single boom and winch for net retrieval usually mounted forward on the open stern deck. Some draggers use a Gulf-style double net rig (twin trawlers) which is towed from the ends of two heavy outrigger poles readily visible extending laterally 20-30 feet from the beam of the boat. The species sought by trawlers or 'draggers' are ridgeback shrimp, spot prawns, pink shrimp, rockfish, various species of sole, and sea cucumbers. Seasonally, the trawlers are allowed to drag in shallower state waters for halibut, and incidental catch of shark and some other fish is also allowed.

**Figure 7.** Trawl.

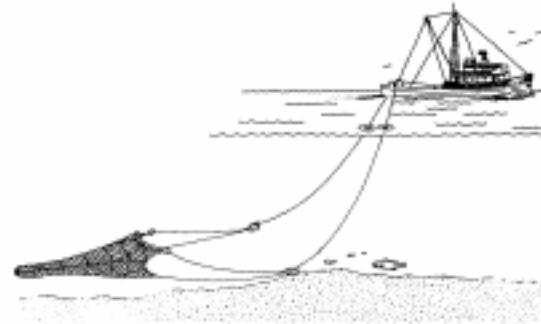

The trawler deploys the net in areas in which fish are noted on the fathometer, or where trawling has been successful before. Depending on the species sought, and season, this can be anywhere from the 50 to 150 fathom depth contour along the coastline, along the Channel Islands, and along topographic features of the seafloor in midchannel at appropriate depths. In the Santa Maria Basin, draggers may work out in waters as deep as 400 fathoms in their search for various species of sole. The net is slowly lowered to the bottom (or midwater), held open by two large 'otter boards' or doors attached to the leading edge of the net funnel. The vessel then navigates along a depth contour at a slow pace (a few knots) through the dragging grounds for several hours. The net is then picked up off the bottom and retrieved on deck with a hydraulic winch and boom. The fish are emptied from the cod (trailing) end of the net, sorted, and the process is repeated.

Trawlers are not readily maneuverable when the net is deployed for several reasons. First, the net is on the bottom in relatively deep water, and

can be up to a mile behind the vessel. Second, the trawlers often work on the top edges of steep drop-off slopes; to turn into deeper water would force the net to drop off these slopes. This causes loss of fishing time since the net has to be picked up and reset. Similarly, rocky outcrops, wrecks, and abandoned wellheads or other debris are located randomly with respect to the trawl grounds. These features are hazards to the dragger because of their potential to snag and hang up the net. Most of the trawlers are aware of most of the snags to avoid in their favored grounds, by trial and error. Knowledge of these snags also limits the potential maneuverability of the dragger when towing a net, because to turn in to such a snag may mean loss or damage to the net, and potential hazard to the vessel itself if the hang is significant and/or weather sea conditions are unfavorable. Since turning into such obstructions would be hazardous, most draggers would have to stop towing and pull gear in rather than turn.

## THE PURSE SEINE FISHERY

This fleet is based primarily in ports to the south of Santa Barbara; mainly in Ventura Harbor and San Pedro (Los Angeles Harbor). The species fished are primarily pelagic, such as anchovy, mackerel, and bonito. A major squid fishery has also developed in the past few years. Because purse seiners follow schools of these pelagic fish, it is difficult to predict where the fleet will be at a given time. Though the season is open all year, the Department of Fish & Game sets catch quotas. When these are filled, the fishery is over for that year unless an extended quota is subsequently issued.

The vessels, in the 35 to 70 foot size range, are distinguishable by the extra pursing skiff usually carried astern, and the tall boom and winch for pursing and hauling in the purse seine itself (**Figure 8**). A much larger "power block" will normally be at the top of a purse seiner boom than the block seen atop a trawler boom. When a school of anchovy, bonito, or mackerel is spotted, the vessel maneuvers into position near the school and launches the skiff, which drags the net around the school of fish and back to the mother vessel. The purse line of the net is rapidly winched in to close the bottom of the net (forming a "purse") to prevent the school of fish

from escaping downward (**Figure 9**). The entire net is then brought in with a power block and winch. A successful set and haul usually takes from 30 to 90 minutes, depending on the size of the fish school, weather, and other factors. During the pursing process, the purse seine vessel is not maneuverable and can be considered effectively dead in the water. It should therefore be given the appropriate clearance due a vessel in such circumstances.

**Figure 8.** Vessel – Purse Seine.



## THE DIVE FISHERIES

Commercial divers in the Santa Barbara Channel primarily seek sea urchins, although a small dive fishery has recently developed for sea cucumbers. Divers usually work rocky reef areas in waters no deeper than 20 fathoms, since the two primary species sought are distributed in that depth range. Historically the coast was dived extensively for abalone and urchins, but the primary grounds for sea urchins is now around all of the Channel Islands. Some urchin divers still do work the coastline, but the majority of the dive fishery grounds are currently at the islands.

**Figure 9.** Purse Seine.



Commercial dive boats are usually small, fast vessels from 22 to 32 feet in length. Normal operations can be either anchored or "live-boat". One to several divers may be in the water. A 'tender' or deck hand on deck operates the vessel and diver air compressor, and tends the divers air hose and game bags. These dive



vessels are clearly marked with Department of Fish & Game identification numbers. The prefix "SU" indicates a sea urchin permit.

Typically the diver will work a "bed" of urchins until his bottom time is exhausted or the bed is fished of all legal size urchins. Then the diver will decompress if necessary, surface and spend a period of time on deck, or move to another location. Clearance of at least 1/4 mile of a dive vessel in operation is advisable, because a diver can be in any direction relative to the dive vessel.

## MARICULTURE AND RESEARCH OPERATIONS

Along the coast of the Santa Barbara Channel near Santa Barbara, at least nine different mariculture leases are scattered within the three mile limit (state waters). Each of these operations has a slightly different purpose, such as the commercial growing of kelps, harvesting edible mussels, growing oysters, or abalone, and/or a number of other species. The one thing all of these leases have in common is a fixed marker buoy, or several fixed, permanent buoys or rafts which locate the lease for the operator and the permitting authority (the Department of Fish & Game). Likewise, there are fixed buoys in place for various research institutions throughout the west coast, gathering information on the oceanography or ecology of the Santa Barbara Channel.

## THE TROLL FISHERY

Trolling for salmon, albacore, and occasionally bonito is done primarily in the Santa Maria Basin, and to a lesser extent in the Santa Barbara Channel, depending on where these fish are from year to year. A troller is most often a relatively small vessel (from 20 to 40 feet long) equipped with at least two laterally deployed booms or arms of some kind to which are attached several trolling lines (**Figure 10**). A baited hook and flasher (or several hooks) is attached to the end of the trolling line, and a weight is attached ahead of the hook and flasher. Multiple sets of this gear trail 100 to 300 feet behind the active troll vessel. The troll lines are tended regularly to remove hooked fish from lines and the lines are reset. Trollers work in highly variable areas, since this fleet targets highly migratory and widely ranging fish. As in

the hook and line fishery, trollers often are in another fishery, and enter the troll fishery in the off-season of their principal fishery.

**Figure 10.** Troll.

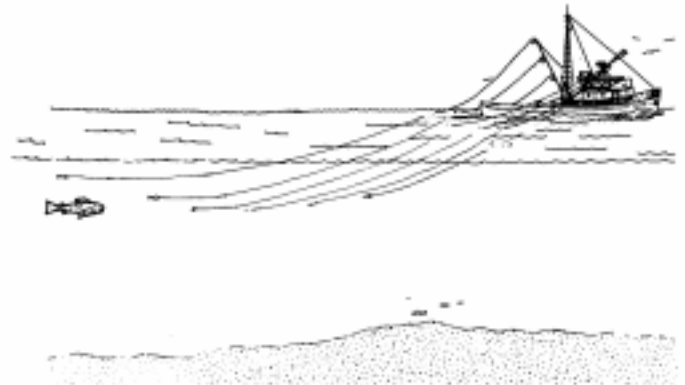

## **FISHERIES IMPACTS OF EXPLOSIVES USED IN PLATFORM SALVAGE**

**DR. ANN SCARBOROUGH BULL**

**Marine Biologist, Minerals Management Service, Gulf of Mexico OCS Region**

**VILLERE REGGIO, Presenter**

**Biologist, Minerals Management Service, Gulf of Mexico OCS Region**

There are upwards of 5000 oil and gas structures in the Federal and State waters of the Gulf of Mexico. A recent average showed more than 100 removals occur each year. Sixty-six percent of these structures are removed with explosives. Typically, the deck of the offshore platform is cut manually with torches and lifted onto a materials barge. Explosives are lowered down the hollow pilings and conductors to a minimum depth of 5 m (15 feet) below the mudline as required by Minerals Management Service. Explosives are detonated, thereby severing the pilings and conductors which, along with the jacket, are removed from the seabed.

One consequence of using underwater explosives is a negative impact on marine life at the platform, particularly fish. This report presented preliminary results from Dr. Bull's research assessing the fish mortality at six platform removals between August 1993 and September 1995. Computed results for red snapper reveal that less than 1% of the annual Gulfwide harvest of this species is due to explosive platform removals. Study sites spanned the Louisiana coast from the western border to the Mississippi Delta. Water depths ranged from 14 to 28 m (45-92 feet).

Mr. Reggio commented on the relationship of petroleum platforms with the evolution of offshore fishing over the past 50 years. Independent research, and over 20 years of personal investigations and observation, has indicated offshore petroleum structures have had a profound, pervasive and long-term impact on fish and fishing in the north-central and western Gulf of Mexico. Platform removals are now routinely considered for reuse as artificial reef developments in water depths from 15 to 106 m (50-350 feet). Through toppling, relocation, and partial removals 35 oil companies have cooperated with the Gulf States to create over 100 planned and permanent artificial reefs (Rigs to Reefs). Ongoing research supported by the MMS Environmental Studies Program, in cooperation with public universities and private contractors, is helping to define the ecological, social, and economic consequences of petroleum platforms on fish and fishing with special emphasis on their future use as dedicated artificial reefs.

## EFFECTS OF DECOMMISSIONING ACTIVITIES ON MARINE BENTHOS

LERAY A. DE WIT

Consultant in the Marine Environmental Sciences

Since the 1960s, when the first platforms went into the Santa Barbara Channel, marine scientists have been interested in the succession of biota on and around those structures. While the newer platforms are in water depths exceeding 400 feet, the older ones are in shallower water, so the entire structure was within the photic zone, generally defined as the upper 200 feet of water. These structures, comprising a series of steel legs and cross-members, provide attachment substrate; a study in the Gulf of Mexico estimated that 3-4 acres of hard surface was added for an oil and gas platform placed in 150 feet of water. Additional "hard substrate" is also realized on the seafloor below the platform where cuttings are discharged and where the shells from attached mollusks settle after they are dislodged from the structure.

Before the effects of decommissioning and removal of oil and gas structures can be discussed, it is important to remember that the platforms and pipelines are "artificial substrates" and the communities that develop on them are a direct result of the habitat being there. Therefore, consideration should be given to the question, "Is it better to leave a structure and the associated biota in-place or return the area to the way it was before placement?" It is not the intent or objective of this paper to answer that question but to provide an overview of the organisms associated with these structures and the potential effects of various decommissioning and removal options on them.

Studies on the Santa Barbara Channel platforms have shown that fairly distinct "zones" of epibiota (attached organisms) develop relatively quickly. An upper zone (to approximately – 20 feet ) normally supports substantial mussel and barnacle growth. That fouling community has been documented to be from 1 to 4 feet thick. An interesting sidelight is that mussels up to 1 foot long have been observed on Santa Barbara Channel platforms. Below that to at least the –120 foot depth, the jewel or strawberry anemone (*Corynactis californica*) generally dominates the attached community. Intermixed

with that anemone are soft corals, hydroids, and various mollusks. Few seastars are usually on platforms above the area where anemones are abundant. The consensus is that the stinging cells in the anemone's tentacles preclude seastars from moving over them. This may also partially explain the abundance and relatively large size of the mussels above the anemone band since seastars are the principal predator of mussels. Detailed studies have recorded over 200 species of epibiota on Santa Barbara platforms.

On the seafloor surrounding the platforms an equally dramatic biotic change occurs as a result of the presence of the platforms. As stated earlier, the drill cuttings that are discharged from the platform and the mussel shells that are removed during storms or due to their own weight are deposited on the seafloor below the platform. These "mounds" have been estimated to be almost 40 feet deep in some areas of the Channel with shell talus comprising almost half of that height. Studies by scientists in the 1970's estimate that 15,000 to 30,000 feet<sup>2</sup> of seafloor had been "enriched" around platforms Hilda and Hazel.

Irrespective of the actual area, it is clear that a new substrate, which supports a vastly different epibiota community than the surrounding sedimentary bottom, is created as a result of this deposition. Depending upon the depth of platform, that community consists of crabs, shrimp, seastars, sea cucumbers, anemones, and other organisms not usually found in the natural habitat. One study of platform Eva off Huntington Beach in the 1970's found that 36,850 pounds of seastars, comprising 19,000 individuals of at least four species, were within a 7,000 feet<sup>2</sup> area under the platform. An additional 5,000 sea cucumbers (2,400 pounds) were also documented within the same talus bed. Needless to say, the shell substrate and abundant organic material provides a good habitat for certain benthic organisms, some of which are of commercial interest.

The exposed portions of pipelines also provide solid substrate, albeit not the area provided by platforms, within the generally sedimentary seafloor of the Channel. While much of the deeper water pipelines bury themselves into the soft sediments, nearshore sediments are more compact and thus support the pipelines, allowing epibiota to attach to the exposed surfaces. In addition to the pipelines themselves, armor rock, usually placed over the pipelines from -25 feet to shore, also provide substrate for epibiota attachment. Within the nearshore areas, generally to about -60 feet, kelp and invertebrates similar to those found on natural rock reefs in these water depths, attach to the pipelines and rock cover. Scallops, mussels, and species of non-commercial interest are commonly found on the rocks.

The spaces between the armor rock also provide habitat for crabs, lobster, and several species of fish, some of which are also of interest to commercial and sport fishermen. My personal observations within the Channel have revealed aggregations of angel sharks along the pipeline oil from platform Helen to shore and I and several other observers have documented abundant growth on the pipelines and rock cover of other pipelines within the Channel. It is important to note that most pipelines are buried through the intertidal zone and therefore provide no longterm attachment substrate there. However, in subtidal areas where the pipelines and/or armor rock is exposed, biomass on the pipeline far exceeds that of the surrounding sedimentary bottom. In a study in which I was involved, it was found that the epibiota biomass of the submerged portions of the rocks on Rincon Island was 50 times that of the infauna in the sedimentary habitats around the island.

Before the effects of removal can be discussed, a brief description of the effects of the marine activities that occur prior to the actual removal is required. These include effects of vessel anchoring, divers, and the cutting of the structures. While each activity is likely to be fairly local in its effect on the benthos, that effect should be included when comparing disposal options.

Multiple anchors are usually used by vessels engaged in platform or pipeline removal. Anchoring does indeed result in the burial of organisms directly below the anchors as well as the resuspension of sediments when the anchor

contacts the seafloor and when it is removed. In addition, the lines or cables connecting the anchors to the vessels have been shown to sweep across the seafloor and damage the substrate and/or attached biota. The area of effect is usually limited to a triangular zone with the apex at the anchor, widening toward the vessel. Due to wave action in the shallower waters, nearshore anchoring normally requires that anchors be set at a distance 10 times the water depth of the vessel. Therefore, a boat working in 25 feet of water could be expected to place its anchors as much as 250 feet away. Deeper water areas usually require less "scope" and therefore the area of impact could be expected to be smaller.

Diver operations, including jetting of sediment from around pipelines, cutting pipelines and the smaller cross members of the platforms, and placing charges, can also result in impacts to the benthic community. In my experience, I have observed apparent diver-related impacts to include some damage to kelp plants near the pipeline cut points, removal of attached epibiota around cut points of platform cross members to access the jacket, and scraping of solid substrate habitats with equipment. My observations indicate that diver-related effects are very local and relatively insignificant.

Cutting of structures via mechanical or explosive methods also appears to have a relatively local effect on the benthos. The effects of cutting are usually limited to a relatively narrow band around the structure and if the piece is to be removed anyway, the loss of those organisms within the cut area is irrelevant.

No matter how much of the subsea portions of the structures is removed, the attached benthos will, of course, be removed also. Even if the structure is used to create an artificial reef, the attached community will change relative to water depth, available light, and suspended sediment at the new location. The orientation of the structure is also likely to change from upright to horizontal, thus organisms attached to the upper portions of the platform are likely to be exposed to greater water depths and decreased light. Again, depending upon the water depth, a platform laid on its side could be expected to develop a fouling community similar to that found at that water depth when it was upright, resulting in a net decrease in the number of habitats the structure supports but increasing

the arial cover of the habitat(s) at those depths. Also to be considered in partial removal is the fact that the near surface areas normally support the largest attached biomass per unit area and it is the mussel community that provides much of the organic material and substrate input to the talus bed beneath the platform. Removal of the upper portions of the structure would eliminate this important community.

I have found that pipelines laid across hard substrate, tend to wear a "groove" into the rock. It is this abrasive action that likely precludes epibiota from developing within the groove. On the other hand, the pipelines themselves provide a viable substrate and therefore it is likely that the removal of the pipeline should not result in a net loss of epibiota within rocky habitats. In sedimentary habitats the pipeline may provide the only solid substrate within the area and therefore the complete removal here would be expected to result in a net loss of organisms and biomass, even when the recolonization of the sediment under the pipeline occurs. In the sandy intertidal zone, assuming that the pipeline is exposed only during extreme erosion events, there is no substantial habitat value associated with the pipeline and therefore removal should result in no substantial long-term change in the biota.

In conclusion, the following summarizes the effects of each decommissioning / removal option identified in the agenda of this conference. Generally, removal of the upper portions of a platform results in the loss of the most productive area and could be expected to eliminate the source of talus formation around the platform. Pipeline removal effects are most detrimental in areas where the exposed portion represents the only solid substrate and has the least effect within the intertidal areas.

### **Full Removal Including Recontouring the Seafloor**

Loss of all biota and habitats that have established as a result of the structure's presence. This of course assumes onshore disposal and scrapping of the entire structure.

### **Non-Removal (Alternative Use)**

Assuming no changes in discharges from what had existed, the structure-associated biota and the epifauna on the talus mounds, could be

expected to continue to develop into a community that differs from the surrounding sedimentary bottom and open-water biota.

### **Partial Jacket Removal with Artificial Reef**

Since it has been shown that the greatest per unit biomass of epibiota is that in the upper portions of the platform, the loss of that portion would be expected to result in the reduction of talus-supplying organisms and the loss of the organisms associated with the portion removed. Placement of the removed structure into similar water depths would be expected to result in continuation of epibiota development and the possible increase in benthos around the area where the structure is placed. The probability is that no net gain or loss from current conditions would be realized.

### **Remove Jacket to Artificial Reef Site**

As in the partial removal option, the water depth and other conditions will dictate the development of the benthic community on and around the structure once it is placed at the artificial reef site. Highest epibiotic productivity could be expected when the artificial reef site is within the photic zone with some portions at or near the surface.

### **Deepwater Disposal of Jacket**

Deepwater has yet to be defined in the context of platform disposal, therefore, as previously discussed, the benefits or negative effects of this option will be driven by the depth of water and the amount of natural solid substrate within the region. Assuming that deeper water equates to softer sediments, less of the structure would be exposed than in shallower areas. Enhancement of benthic productivity of the area could be realized from the presence of the platform with losses of existing biota limited to that buried beneath the structure.

### **Full Pipeline Removal**

Removal of the entire pipeline will not only reduce available solid substrate, but will also result in impacts to the benthic community from removal-associated activities. Unless there is a safety issue, rock-covered pipelines should not be removed, however, removal of those pipelines that traverse natural rocky habitats is

likely to result in reestablishment of biota within the area immediately around the pipelines. Generally, it is expected that the impacts to benthic communities would be greater from complete removal of pipelines than those associated with allowing them to remain in-place.

### **Partial Pipeline Removal**

As previously stated, consideration should be given to the habitat through which the pipeline traverses and the potential long-term effects of removal vs. remaining in-place. Exposed pipelines in offshore sedimentary habitats should be allowed to remain in-place.

Some general conclusions that focus on the potential effects of various decommissioning options on the marine benthos of southern California are:

- 1) the habitats and associated biota present on and under the platforms and on pipelines are usually unique since the surrounding area is sedimentary;
- 2) removal of even part of the structures could be expected to alter the benthic and epibiota community in the area;
- 3) the effects of removal-associated activities must be considered in assessment of impacts of removal but are expected to be relatively local and short-term; and
- 4) creation of artificial reefs from the removed structures could be expected to enhance the benthic and epibiota communities of the reef site but removes those communities from there present, offshore locations.

Removal of oil and gas structures and identifying the best use of the material remains a controversial topic. The organisms that attach to the structure or benefit from its presence will suffer some impact with removal of any portion. Weighing the benefits and losses to the benthic and epibiota communities is only part of the overall consideration and, I might so boldly add, a relatively minor one when compared to the other technical and cost issues that must be included in the equation.

---

---

## DISPOSITION SESSION

---

### Long-term Environmental and Socio-Economic Effects Related to the Disposition of Oil and Gas Facilities

Commercial Fisheries: Long-term Effects of Offshore Oil and Gas Facilities Decommissioning, John Richards.....	111
Ecological Consequences of Alternative Decommissioning Strategies for POCS Offshore Facilities, Dr. Mark Carr, Dr. Graham Forrester and Dr. Michael McGinnis .....	116
Effect of Offshore Oil Platform Structures on the Distribution Pattern of Commercially Important Benthic Crustaceans, with Emphasis on the Rock Crab, Dr. Mark Page and Dr. Jenny Dugan.....	119
Enhancement of Platforms as Artificial Reefs, Dave Parker .....	122
Long-term Socioeconomic Effects of Onshore Facility Decommissioning, Dr. James Lima.....	124





# COMMERCIAL FISHERIES LONG-TERM EFFECTS OF OFFSHORE OIL AND GAS FACILITIES DECOMMISSIONING

**JOHN RICHARDS**

Sea Grant Extension Program, Marine Science Institute  
UC Santa Barbara

## INTRODUCTION

Decommissioning of offshore oil and gas facilities and the long-term effects of various disposition options have both direct and indirect impacts on nearly every commercial fishing fleet operating along the south-central and southern California coast. To gain an understanding of the disposition issues and concerns of the commercial fishing industry, interviews were conducted in seven ports with forty-three vessel owner/operators, each representing an individual fishing business. The fishing fleets represented included troll, hook and line, drift and set net, purse-seine, trawl, trap, and dive. The interviews were conducted either in person or by telephone during the summer of 1997 with captains from Morro Bay, Port San Luis, Santa Barbara, Ventura Harbor, Channel Islands Harbor, Port Hueneme, and San Pedro Harbor. Background information on current fishing operations and fleet characteristics was acquired through interviews with six fisheries resource managers and representatives of eight commercial fishing organizations (listed in Appendix A).

## THE OCEAN SETTING

The shift in the California coastline in the area of Point Conception, Santa Barbara County, from a north-south to an east-west orientation, has a significant influence on the weather, oceanography, and diversity of marine life in the Santa Maria Basin north of the Point and the Santa Barbara Channel to the south-east. Fish and shellfish species favoring both cold and temperate seas inhabit this productive marine transition zone. Further south, from the Los Angeles Bight to the Mexican border, the waters are typically warmer and, in years of El Niño events, there is often (depending on the strength of the event) a rise in ocean temperatures and movement of warmer-water marine species to the north. The changeable

nature of the ocean in this area, and the diversity of marine species have led to the development of a very dynamic and adaptable commercial fishing fleet.

## CHARACTERISTICS OF THE FISHING FLEETS AND FISHERMEN

The demand imposed on southern California fishermen to adapt to changing conditions along with the unique variety of fish in the area (over 20 commercially harvested species) have prompted many captains to utilize a combination of gear types and methods to maintain productive fishing enterprises. An excellent review of the region's fishing vessels, gear types, methods, and seasons is given in the Joint Oil/Fisheries Committee and Liaison Office (1986) publication, "A manual for geophysical operations in fishing areas of south/central California". As this publication is currently out of print, an abridged and updated segment of the publication describing the south coast fishing operations is reproduced in this volume (See p. 97 Fusaro & Richards).

Southern California commercial fishing vessel owners and operators are typically small independent businessmen with vessels ranging from 18 foot skiffs to 100 foot purse seiners and investments from \$10,000 to over 1 million dollars. In 1997, registered commercial fishing vessels from Santa Barbara to Orange County numbered approximately 1375. Over 1900 commercial fishing licenses (including both captains and crewmen) were issued in the same area (David Ono, CDF&G, pers. comm.).

Professional fishermen, those who derive the majority of their income from fishing, and dual career fishermen (who work at other jobs and fish seasonally) are estimated to number over 300 in the tri-county area (San Luis Obispo, Santa Barbara, and Ventura Counties). This number does not include "sport-commercial fishermen" (hobby fishermen or retired persons

fishing part-time) or commercial sea urchin divers, a large fleet generally working out of the area of decommissioning activities. (Dr. Craig Fusaro, pers. comm.).

## DECOMMISSIONING OPTIONS

Of the 43 commercial fishing vessel owner/operators interviewed, the vast majority (95%) expressed the following opinion:

**“The oil and gas industry should honor agreements made with state and federal government agencies and other marine resource users to remove all offshore structures and equipment from the abandoned leases and return the seafloor to it’s original state.”**

This opinion was expressed in many different forms and paraphrased by the author. It reflects the perception of many in the fishing industry that during the leasing process, agreements were made that would assure the removal of offshore structures and that the seafloor would be returned to the state it was found prior to offshore oil and gas development. This perception, is apparently incorrect in regard to the Minerals Management Service’s OCS Oil and Gas Regulations on decommissioning offshore facilities as they give the MMS Regional Director certain discretionary authority to “depart from the operating requirements of the regulations” and allow alternate uses of the offshore structures with the concurrence of other regulatory agencies (See Appendix I: Regulatory Framework..., page 197, this volume).

If the decision is made to allow all or portions of the offshore structures to remain in place or to be moved to another at-sea location, the fishermen interviewed provided the following comments and opinions on the various decommissioning options, starting with the least desirable and ending with the most tolerable:

### **Option #3: Partial Jacket Removal (Topping to 85 feet below the surface)**

This was considered the least desirable and most dangerous option by the majority of fishing captains interviewed in each of the different fleets. The following is a summary of

the comments and information provided on the impacts of this option on each type of fishing operation:

**Troll Fishery** - Salmon trollers tow several sets of lines with numerous lures or baited hooks weighted by large lead sinkers (“cannon balls”). These lines are often fished to depths of over 300 feet and fishermen try to avoid any submerged obstructions that would snag their gear. If existing platforms are cut to 85 feet below the surface, trollers would have to stay clear of the remaining structures. Troll fishermen expressed concern over loss of fishing area and potential gear loss if rigs were topped and the remaining structure left at 85 feet below the surface.

**Hook & Line** - Hook and line fishermen have similar concerns as a common technique is to deploy buoyed vertical longlines with groups or “gangions “ of baited hooks near an identified “stack” of fish. The lines are then retrieved and the fish removed. These lines are also weighted with 20 to 30 lb. weights and fished at depths of several hundred feet. The primary objections of hook and line fishermen to this option are the potential for gear loss and loss of fishing area.

**Set & Drift Gill Net** - Set gill nets are not used frequently in the area of offshore oil production, but drift gill nets are deployed during the thresher shark, swordfish, and white sea bass seasons. The drift net, which is attached to the fishing vessel at one end, may be up to a mile long and 200 feet deep, though the depth will vary according to the ocean conditions and areas fished. Captains of drift net vessels are particularly concerned about submerged obstructions, as they generally work at night and have restricted mobility when the net is out. The direction and speed of the drift is determined by the ocean currents and a boat may cover 10 or 15 miles in a night of fishing. The potential for major loss of gear and fishing time, the safety risk of being snagged and immobile at night, as well as loss of fishing areas are the primary reasons drift net fishermen feel this is an unacceptable and dangerous option.

**Trawl Fishery** - Trawl nets are fished either in mid-water or on the bottom with bottom trawling being the most commonly used in south-central and southern California. This fishery is particularly vulnerable to any type of bottom obstruction and fishermen may spend

years charting these obstructions or “hangs” to avoid damage or loss of gear. By cutting the rig down to 85 feet below the surface, trawlers lose the ability to see the exact location of the remaining structure. If the structure is marked with a surface buoy, they will still have to give the area a wide berth, thus losing considerably more fishing area than if the rig were left with at least part of the topside intact. Potential gear loss, becoming snagged and immobile (a major safety risk), and losing additional fishing areas are the main objections trawlers have with this option. Some trawlers have also noted that oil-field marker buoys themselves have become navigation hazards when maintenance is poor and they lose lights, radar reflectors, or become partially or fully submerged.

**Purse Seine** - Purse seiners, a highly mobile fleet traditionally seeking pelagic species (anchovies, sardines, mackerel, bonito, and tuna) have recently increased in number on the south coast due to several good seasons of squid availability and sound markets. Vessels from the central California and Washington have joined the San Pedro, Port Hueneme, and Ventura fleets to fish in the Santa Barbara Channel. Squid fishing is cyclic and the warmer waters anticipated this season (1997-98) may diminish squid production and prompt fishermen to put more effort in pursuing the pelagic species throughout the southern region. With nets that can be fished to depths of 360 feet and “pursed” (the bottom of the net closed) at a depth of 180 feet, seine captains have the same concerns about snagging bottom obstructions as the drift net and trawl fishermen: primarily damage and loss of gear, the safety risk of being immobilized, and the loss of fishing area.

**Trap Fisheries** - Lobster and crab trap fishermen often work near some of the shallower rigs and would probably be able to avoid problems if the underwater structures were carefully marked with buoys. Since traps may move or “walk” during storms or rough ocean conditions, more problems (such as snagging or loss of gear) might occur with the other options such as toppling or moving the jackets to inshore areas as artificial reefs. Increasing boat traffic to and from an artificial reef site could also adversely affect trap fishing operations.

#### **Option #4: Partial Jacket Removal (Toppling in place - artificial reef)**

A majority (over 90%) of the fishermen interviewed felt this was also an undesirable and risky option. They expressed the same concerns (gear loss/damage, safety risk of becoming snagged and immobilized, and loss of fishing area) as with topping to 85 feet. Toppling certain deeper water rigs may not be as much of a problem to the fleets that fish off the bottom, but many of the shallower platforms are in prime commercial fishing areas, particularly for trawling and purse seining. Several fishing industry representatives questioned the reasoning (and scientific basis) for toppling the platforms in place to be used as artificial reefs, rather than carefully selecting areas and reef materials that would provide beneficial habitat for enhancing fish production.

#### **Option #6: Deep Water Disposal of Jacket**

This option was unacceptable to all but a few (7%) of the fishermen interviewed. Most captains hold a strong bias against using the ocean as a dumping ground.

#### **Option #5: Move Jacket to Artificial Reef Site**

This was considered a possible option by most fishermen (though about 10% favored total removal). They would consider this option on a case-by-case basis with well defined goals for the project, careful study of potential reef sites, and development of site criteria considering both ecological and fisheries aspects. Area commercial fishermen would like to be fully involved in the planning process along with the other stakeholders. Again, many fishermen questioned whether the oil platform jackets are constructed with the proper materials to build viable, long-lasting reefs.

#### **Option #2: Non-Removal: Multiple Use**

This was considered the most tolerable option, especially if a portion of the platform topside remained above the water so it was easily seen by day and picked up by radar in the fog or at night. The platform lights at night also help fishermen and other mariners in navigating.

The following benefits to this option were expressed by 90% of the captains:

Shell mounds which remain on the seafloor after the removal of the "4H" platforms in state waters off Santa Barbara County have continued to be a problem to the commercial trawl fleet. By leaving the platform intact, with the topside visible, fishermen would have a better chance of navigating and fishing around the structures and would not have to be concerned about "hanging-up" on the shell mounds or losing additional fishing grounds.

Most of the other (non-trawl) fleets would also be able see and navigate around the rigs better if they were left intact and exposed above the surface rather than cut off or toppled. They would be significantly easier to see at night if the topsides remained lit.

Many of safety risks and potential gear damage mentioned above would be reduced if the platforms remained visible to fishermen.

Several commercial fishermen suggested that the fish populations now associated with the rigs might have better protection if the rigs remained standing rather than being cut off below the surface or toppled.

Non-removal, in fact, was preferred by nearly all of the fishermen interviewed if one or two platforms were carefully selected to serve as weather stations, especially at the west end of the Santa Barbara Channel or in the Santa Maria Basin. Other suggestions for multiple-use of the oil and gas rigs included: a Coast Guard rescue station; a fisheries and aquaculture experiment station, long-term ecological monitoring site, oceanographic research station, and a site for alternative energy production (utilizing wind, wave, and currents). A majority of those interviewed desired to be included in discussions of the costs and benefits of these potential uses. The question of liability continues to be a primary concern of the fishing industry members.

### **Pipelines**

Leaving pipelines in place after decommissioning the platforms would pose problems for certain commercial fishing operations depending on the areas and the condition of pipes. Those pipelines with snags (rough or exposed flange connections), areas of pipeline cross-overs, pipelines rising off the bottom, or disconnected ends sticking up can

cause gear damage and loss to most of net fishing and trapping operations in the areas of offshore oil and gas production. Properly maintained, smooth pipes usually cause no problem for trawlers, seiners, or trappers, though fishermen expressed concern about potential long-term deterioration of the pipelines and which agency would assume liability for those remaining after decommissioning.

### **SUMMARY OF COMMERCIAL FISHING REPRESENTATIVES' PREFERENCES:**

The majority of the 43 fishermen interviewed favored Option #1: Full removal of platforms and associated debris.

Alternatively, if regulatory agencies decide to allow the offshore structures to remain in place or to be moved to another at-sea location, then the majority favored Option #2: Leaving the structure in place with careful consideration of multiple uses, safety risks, ownership, and responsibility for liability.

In regard to pipelines, most fishermen would accept leaving them in place with assurances that they remain snag-free and compatible to the various fishing operations, though long-term maintenance responsibility and liability should be determined prior to abandonment.

**Appendix A.****Commercial Fishing Organizations****Contacted:**

Southern California Lobster Association  
 Pacific Coast Federation of Fishermen's Associations  
 Southern California Trawlers Association  
 Morro Bay Commercial Fishermen's Association  
 Commercial Fishermen of Santa Barbara, Inc.  
 Ventura County Commercial Fishermen's Association  
 Federation of Independent Seafood Harvesters  
 Sea Urchin Harvesters Association of California

**Resource Managers and Biologists****Contacted:**

Robert Hardy - California Department of Fish & Game, Morro Bay  
 Christine Pattison - California Department of Fish & Game, Morro Bay  
 Dan Dugan - California Department of Fish & Game, Morro Bay  
 Maria Voikovich - California Department of Fish & Game, Santa Barbara  
 Kristine Barsky - California Department of Fish & Game, Santa Barbara  
 David Ono - California Department of Fish & Game, Santa Barbara  
 Marylin Beeson - California Department of Fish & Game, San Diego

**Acknowledgements**

The author gratefully acknowledges the time and wealth of information provided by all of the captains, crew, vessel owners, and fishing organization representative who participated in the interviews. Also many thanks to the resource managers and biologists of the California Department of Fish and Game who provided current background information and data on the south-central and southern California fishing operations.

Special thanks to Vanessa Deluca, of State Fish Company, San Pedro, John Lane, Herb Leedy, and Dave Panzer of the Minerals Management Service, Camarillo who took time to answer questions and provide background materials.

Review of the manuscript by Dr. Christopher Dewees, Sea Grant Extension Program and Dr. Craig Fusaro, Oil/Fisheries Liaison Office is greatly appreciated.

Dr. Mark Carr, University of California Santa Cruz, served as the catalyst in initiating the project and Bonnie Williamson, University of California, Santa Barbara, has assisted tremendously with technical support.

Funding and travel support was provided by the U.S. Department of the Interior, Minerals Management Service; University of California Santa Barbara, Marine Science Institute; and the U.C. Sea Grant Extension Program.

## **ECOLOGICAL CONSEQUENCES OF ALTERNATIVE DECOMMISSIONING STRATEGIES FOR POCS OFFSHORE FACILITIES**

**DR. MARK H. CARR**

Department of Biology, University of California, Santa Cruz

**DR. GRAHAM E. FORRESTER**

Department of Biology, University of California, Los Angeles

**DR. MICHAEL V. MCGINNIS**

Ocean and Coastal Policy Center, Marine Science Institute, University of  
California, Santa Barbara

### **SIGNIFICANCE OF STUDY**

Critical to formulation of appropriate decommissioning policy is an understanding of the ecological, economic and social consequences of different decommissioning options and identification of the mechanisms by which such information is incorporated, or not, into legislation and public policy. Perhaps the most important ecological consequence of abandoning POCS facilities is a potential change in regional fish production (the biomass of fish accrued per year), which may in turn influence yields to fisheries. Hard substratum reefs represent a small fraction of the available offshore habitat in California, but are sites of high fish production. However, prior to this study, only one study provided quantitative estimates of species composition and abundance of fishes at a single platform off southern California.

### **STUDY OBJECTIVES**

1. Quantitative description and comparison of fish assemblages on natural reefs and offshore structures.

One objective of this study has been to quantify the species and sizes of fishes associated with platforms and natural reefs. Such information is required to determine what species and life stages might be influenced by the various decommissioning options. Do fish recruit to each habitat type from the plankton (as larvae) or migrate on to one habitat type from the other as older stages (benthic juveniles and adults)? Comparison of fishes between platforms and natural reefs provides information on what stages use the two habitat

types. Patterns of fish sizes over time can also provide information on how long fishes associate with each habitat type and how well they grow and survive. Such information is critical to understanding the relative value of natural reefs and platforms as fish habitat.

2. Quantitative description of the vertical distribution of fishes on platforms.

Several of the various options for platform decommissioning alter the vertical height of the remaining structure (e.g., "topping", "toppling", moving to different water depths). To estimate the potential consequences of these options, it is necessary to determine how species are distributed from the surface to the bottom of the platforms. Also, information on the sizes of fish at each depth can indicate patterns of recruitment and how the vertical distribution of fishes changes as they grow.

3. Quantify the net rate and direction of fish movement between platforms and natural reefs.

Fundamental to understanding the net contribution of local populations to regional production is information on the size-specific rate of migration of fishes among local, reef-associated populations. In the context of platform decommissioning, knowledge of the net direction and rate of transfer of biomass between platforms and natural reefs is crucial. For example if fish recruit to natural reefs and eventually migrate to platforms, accumulation of fish biomass on platforms would be incorrectly attributed to production at the platform habitat. Conversely, if platforms provide recruitment habitat for fish that eventually migrate to natural reefs, the

contribution of platforms to regional production may be grossly underestimated by simply measuring production in the two habitats. Movement information is also important to determine whether the loss of fish at a site is due to emigration rather than mortality. Therefore, we have conducted a tagging study to determine how much and what direction (from platforms to reefs or vice versa) fish move, the rate of that movement, and net direction of exchange.

### Study Area and Methods

1. Quantitative description and comparison of fish assemblages on natural reefs and offshore structures,

and

2. Quantitative description of the vertical distribution of fishes on platforms.

Over the past three summers (1995-1997), fish assemblages associated with shallow (< 33m) portions of six production platforms (Hogan, Houchin, Henry, A, B, and C) have been sampled monthly from May through October (peak periods of recruitment of most reef fishes) using diver surveys. Deeper (> 33m) portions of these platforms have been surveyed three times each year (June, August, October) with a remotely operated vehicle (ROV) outfitted with a video camera in cooperation with the Marine Technology Program at the Santa Barbara City College. Surveys conducted by divers on production platforms involve estimates of the density and size of individuals of each species along 2 m wide x 2 m tall belt transects at predetermined locations and depths. A second diver samples the same transects using an underwater video system. The video system (equipped with parallel lasers for estimating fish length) is used to increase the sample size of fish lengths and provide a standard for comparing samples with ROV video at greater depths. Belt transects of similar dimensions are sampled with the ROV while an observer logs the depth and location of transects, and identifies fish species.

Divers also locate and sample fish assemblages on the 3 shallow natural reefs closest to these production platforms during the same sampling period each month. Data collected on natural reefs are the same as that on production platforms, but surveys of natural reefs also include quantification of habitat

variables (e.g., substratum type and relief, epibenthic cover, density and size of macroalgae, temperature and visibility) that might explain patterns of species abundance. The ROV is used to sample one or two additional natural reefs in deeper water between the shallow natural reefs and the production platforms.

3. Quantify the net rate and direction of fish movement between platforms and natural reefs.

Over the past two years we have begun a tagging study to estimate rates of fish movement between production platforms and natural reefs. This work is being done in conjunction with the Channel Islands National Marine Sanctuary and volunteers from the University and the local sport fishing community. We have tagged fish at four natural reefs in the vicinity of the 6 study platforms off Summerland. Fish are caught by hook and line, identified, measured, tagged with standard Floy tags, and immediately released. When necessary, their swim bladders are vented to enable fish to return to the bottom. Floy tags are similar in design to garment tags, with a number, name and phone number. This allows fishers to call and inform us of where and when they caught each fish. Tags are color coded by the reef/platform on which they were tagged and released.

### Results and Implications

1. Quantitative description and comparison of fish assemblages on natural reefs and offshore structures

The species composition of fishes encountered on platforms and natural reefs differed both with respect to the presence/absence and relative abundances of some species in each habitat. Some species were only encountered on the natural reefs (listed in red color on the adjacent Table). Others were only observed on the platforms (listed in blue on the adjacent Table). However, most species occurred at both habitat types (listed in black). Particularly notable were the several species of surf perch and kelp-associated species only seen at the natural reefs, and the young recruits of many rockfish species that were only seen at platforms. Many of the species observed at both habitat types differed in their relative abundance on platforms and natural reefs (see Table below). Some of these

economically or recreationally important species were more abundant on natural reefs (e.g., barred sand bass, kelp rockfish), whereas others were more abundant on platforms. These results suggest that the removal of platforms will likely affect some species much more than others, and some species will likely be influenced little.

2. Quantitative description of the vertical distribution of fishes on platforms.

The abundance of many species varied markedly with depth along platforms. Often these depth-related differences were also related to the age/size of individuals. For example, the young of many shallow dwelling rockfish occurred only at the shallower depths sampled, whereas older stages (juveniles and adults) occurred more frequently at greater depths. These results suggest that removing the upper portion of platforms may reduce recruitment of some species to the platforms. In contrast, both the young and older stages of other species (many rockfishes including olives, widows, bocacios) occurred at depth, suggesting that recruitment and adult abundance of these species may not be

reduced by the removal of the upper portions of platforms.

3. Quantify the net rate and direction of fish movement between platforms and natural reefs.

To date, we have tagged 500 fish and recaptured 50. This high return rate (10%) is attributable to the excellent cooperation by sport fishers that have called us with information on the fish they caught. Of the fish recaptured, 75% were caught where they were tagged, suggesting that many of the species tagged (mostly rockfishes) remain on the reefs they were tagged. Of course, it is not clear how much movement occurs by the many fish that were not recaptured, but we hope to continue to collect information on those individuals in the future. Some species contributed highly to the individuals that do move; particularly barred sand bass and kelp/calico bass. That calico bass move more helps to explain why we see many adults on reefs, but no young recruits. These data strongly suggest that a species like this is attracted to platforms, having recruited as young elsewhere, rather than recruiting to and remaining on the platforms.



## EFFECT OF OFFSHORE OIL PLATFORM STRUCTURES ON THE DISTRIBUTION PATTERN OF COMMERCIALY IMPORTANT BENTHIC CRUSTACEANS, WITH EMPHASIS ON THE ROCK CRAB

DR. HENRY M. PAGE AND DR. JENIFER E. DUGAN  
Marine Science Institute, University of California, Santa Barbara

Offshore oil platforms act as artificial reefs by providing habitat for mussels, encrusting bivalves, sea anemones and other invertebrates. Studies of artificial reefs, in general, have centered on whether they simply attract or produce sport and commercially important fishes. We tested elements of a conceptual model describing possible interactions between offshore platforms and *Cancer* crab stocks based on ideas developed for fish populations and fishery refugia.

Using offshore platform "Holly" (Mobil) as a model system, we: 1) estimated fouling community thickness on platform conductor pipes and the rates and composition of faunal litterfall to the benthos that may provide food and/or habitat for rock crabs, 2) evaluated whether the platform is a site of rock crab production, and 3) determined if crabs aggregate beneath the structure relative to adjacent soft bottom.

The fouling community attached to Holly provides shelter and food for juvenile *Cancer antennarius*. This community of organisms, which varies in thickness with depth ( $P < 0.001$ , One-way ANOVA), reached a maximum mean thickness of ~18 cm at a depth of 12 m and decreased to a mean thickness of ~5 cm at a depth of 24 m. Mussels predominated at depths of 6 m and 12 m while barnacles (e.g., *Megabalanus californicus*, *Balanus aquila*), encrusting bivalves (e.g., *Chama* spp. *Crassadoma gigantea*), and anemones (*Metridium senile*), predominated deeper. The bay mussel, *Mytilus galloprovincialis*, comprised nearly 100% of the mussels at depths shallower than ~9 m while large clumps of the sea mussel, *M. californianus*, were present between 9 m and 15 m.

The fouling community is also a source of organic enrichment to the benthos through "faunal litterfall". Using 38 cm internal diameter plastic circular hoops with attached

fine mesh bags as faunal litterfall traps, we collected an average of from 0.08 to 2.6 kg wet weight of mussels  $\cdot \text{trap}^{-1} \cdot \text{week}^{-1}$  at a depth of 18 m. Dislodged clumps of *M. galloprovincialis* formed nearly 100% of this material. The topography of the bottom beneath Holly is altered by this litterfall and consists of a mound of mussel shells at least 1.5 m thick at the platform periphery. Rock crabs could be attracted to the area beneath or around Holly by increased food availability and/or habitat heterogeneity.

To identify rock crab species present and temporal patterns in crab abundance beneath Holly, standard crab traps (Fathoms Plus) were deployed monthly from the platform and every two to three months ~200 m east, south, and west of the platform. Three species of rock crab (brown rock crab-*Cancer antennarius*, yellow rock crab-*C. anthonyi*, red rock crab-*C. productus*) and the sheep crab, *Loxorhynchus grandis*, were found beneath Holly. *C. antennarius* ( $x=1.0$  to  $7.5$  crabs  $\cdot \text{trap}^{-1}$ ) and *C. anthonyi* (0 to  $16.7$  crabs  $\cdot \text{trap}^{-1}$ ) were most abundant followed by *C. productus* and *Loxorhynchus grandis* (usually  $< 1.5$  crabs  $\cdot \text{trap}^{-1}$ ).

*Cancer antennarius* and *C. anthonyi* were significantly more abundant beneath Holly than on surrounding soft bottom. There was no difference in abundance among locations for *C. productus* and *Loxorhynchus grandis*. Of interest, 87% ( $n=254$ ) of the *C. anthonyi* individuals trapped at the platform were females, compared with only 26% females ( $n=99$ ) at the soft bottom stations, suggesting that females may prefer more heterogenous habitats than males.

To quantify spatial and temporal patterns in the recruitment of rock crabs and in crab population structure on the platform, crabs were censused and fouling community

sampled on at least four vertical conductor pipes at three depths (12, 18, 24 m) using SCUBA every other month.

Only *Cancer antennarius* recruited to the platform. Smallest crabs (<40 mm carapace width, CW) were found within clumps of *Mytilus californianus* and were rarely seen in visual surveys or trapped. The smallest crabs remain hidden in mussel clumps and become more active at a size of >40 mm CW. Crabs of 40 to 80 mm CW were found in the open and enter traps. Larger crabs >80 mm CW were present, but were less abundant. The largest *C. antennarius* were trapped on the bottom beneath the platform. Larger crabs beneath the platform may have recruited into mussel clumps in shallow water and fallen or moved to the bottom.

Preliminary analysis of our data suggests that *Cancer antennarius*, *C. anthonyi*, *C. productus*, and *Loxorhynchus grandis*, respond differently to the presence of the platform (Figure 1). Recruitment of *C. antennarius* occurs onto the platform, but dispersal appears limited, leading to a resident population restricted to the vicinity of the structure. Recruitment of *C. anthonyi* does not occur at the platform, but members of this species (primarily females) aggregate beneath the structure. *C. productus* does not recruit at the platform and there were no

patterns in the distribution of adults relative to the platform. Finally, *L. grandis* was found seasonally at the platform and at soft bottom sites, indicating that this species moves between the platform and surrounding areas.

The implications of the available decommissioning options on crab populations will vary among crab species. *C. antennarius* and *C. anthonyi* are likely to be affected most by the various removal options. Complete removal (structure and mound) of the platform will result in a loss of litterfall and habitat that would directly reduce the production of *C. antennarius*. This option would also affect the distribution of female *C. anthonyi*. There would be relatively little effect on *C. productus* and *L. grandis*. Partial removal (cropping at a depth of 60 feet or toppling) would result in a loss of litterfall because much of the production of the fouling community occurs above 60 feet. Recruitment of *C. antennarius* may be reduced under this option. The aggregation of *C. antennarius* and *C. anthonyi* on the mussel mound may still occur, however, reduced food availability could affect growth rate of these species. Decommissioning of the platform in place or elsewhere, as an artificial reef, could result in a continuation of the patterns found at Platform Holly. However, these patterns may vary among platforms and reefs depending on depth and location.

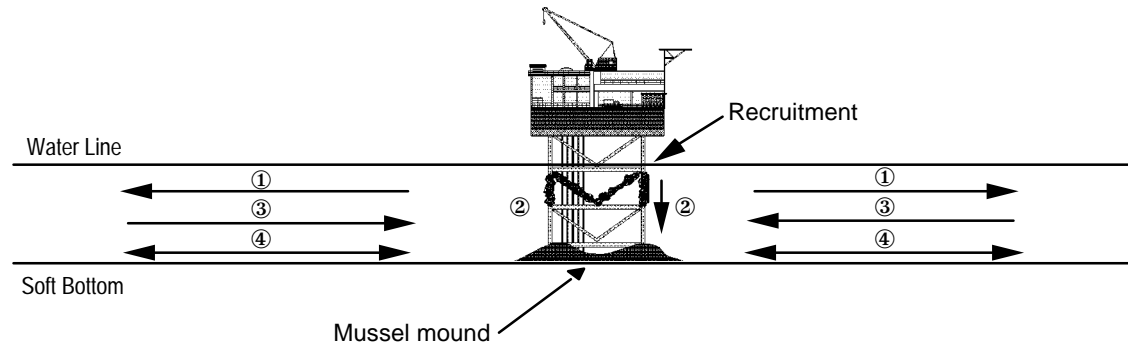

Distribution scenario	Crab species			
	<i>C. antennarius</i>	<i>C. anthonyi</i>	<i>C. productus</i>	<i>L. grandis</i>
① Recruitment to platform followed by movement away from platform	—	—	—	—
② Resident population; produced by recruitment onto platform supports	+	—	—	—
③ Attraction/Aggregation of individuals produced elsewhere	—	+	—	—
④ Movement of individuals between a platform and surrounding areas	— *	+	+ *	+

**Figure 1.** Summary of distribution and movement scenarios for the rock crab, *Cancer* spp., and the sheep crab, *Loxorhynchus grandis* in relation to offshore oil platform Holly. + = data consistent with scenario, - = data inconsistent with scenario, \*hypothesized, insufficient data.

## ENHANCEMENT OF PLATFORMS AS ARTIFICIAL REEFS

**DAVID O. PARKER**

**Senior Biologist**

**California Department of Fish and Game**

Enhancement refers to the addition of materials which can provide increased and/or improved substrate for development of reef-based communities. The resulting reef could have high and low relief components, crevices, ledges, edges, holes and other features which increase substrate complexity. Addition of such materials would also serve to provide some "replacement or compensation" for the upper water column platform structure which is would be removed to meet navigational, safety or other requirements. The size or footprint of the reef habitat area would also be increased through materials enhancement. A larger reef area could contribute to development of self-sustaining reef populations and serve to limit the "habitat island" effect of a small isolated reef.

Materials should have inherent stability once in place. Those with high specific gravities provide the greatest likelihood that the reef configuration will be stable and remain in place over time. Materials should have a very long or indefinite life in the marine environment. The physical and chemical composition, and shape should not degrade or change such that the substrate/habitat function is substantially impaired. Rock and concrete rubble have been used extensively and perform well for artificial reefs in California. Manufactured substrates have not been used extensively here, but could be appropriate to meet specific reef design criteria. Quarried rock is locally available in any quantity, size and in several densities. Shoreline quarries simplify transport and delivery by barge.

Concrete rubble, or scrap is a material of opportunity with uncertain availability, which may have to be stored while sufficient quantities are accumulated. Shapes and sizes are variable and depend on the source and it may be mixed with other undesirable materials. Transportation involves several stages, overland, loading facility, barge. Manufactured substrates can be developed for

a specific reef design and purpose with mass production and replication increasing cost effectiveness. These materials could be manufactured at or near barge loading sites to simplify transport.

In southern California, artificial reefs have only been constructed in nearshore areas at relatively shallow depths, there has not been any experience with reefs placed in depths similar to those of platforms planned for decommissioning. Reef materials interact quickly with the surrounding substrate after placement including localized scouring which stabilizes around some annual or seasonal variation. Other than the localized effects on the surrounding substrates, no large scale effects have been seen on natural sand or sediment movement patterns. These reefs also undergo a process of biological succession or development beginning with simple communities of opportunistic attached organisms and mobile species which are initially attracted to new relief forming substrate. Communities tend to become more complex with time, and reef-dependent mobile species form resident communities. Giant kelp and other algae may develop on reefs in appropriate depths and locations. Many mobile species may also use the reefs for a portion of their life history - spawning, juvenile habitat, feeding - or include the new reef as part of their larger range which might encompass existing nearby reef habitat. Specific patterns of the biological development process may vary with location, depth, surrounding substrate type and frequency of disturbances.

While enhancing platforms is meant to have beneficial effects on reef based biological communities and resource users, several uncertainties are present. Reefs in California have not been constructed in depths likely for platform-based reef sites. Design criteria for enhancement materials may have to be developed for deeper applications. Substrates

in those sites may have different characteristics (softer, more easily disturbed?) and responses to added materials than those at inshore reef sites. The amount and extent of material to be added to platform structures as reef enhancement has not been established. How large should such new reefs be? Is there an optimum mix of high and low relief components? What are the best substrate types and configurations for the species and communities which are likely to develop at specific locations? The rates of

biological development on the new reefs may be different than in nearshore applications.

Many of the components of deeper reef communities are very long lived and a "mature" reef may develop very slowly. Will harvesting pressure at these new sites affect the development process? Before serious consideration is given to constructing rig-based reef systems, general design and siting criteria should be developed and applied to each proposed site on a case-by-case basis.

#### **WHAT IS ENHANCEMENT?**

- Addition of other reef forming materials
- Increased diversity and complexity of substrate
- Replace "lost" upper water column substrate
- Increase foot print of the reef

#### **TYPES OF ENHANCEMENT MATERIALS**

- Quarried rock
- Concrete rubble and scrap
- Manufactured substrates

#### **CRITERIA FOR ENHANCEMENT MATERIALS**

- High density and stability
- Longevity and durability
- Substrate value

#### **PERFORMANCE OF REEFS AS POTENTIAL ENHANCEMENT MATERIALS**

- Experience in California limited to nearshore waters
- Physical interactions
- Biological development

#### **UNCERTAINTIES OF REEF ENHANCEMENT IN DEEPER WATER APPLICATIONS**

- Interactions with local substrate
- Magnitude of enhancement component needed
- Biological development process

#### **CHARACTERISTICS OF SOME MATERIALS**

- Quarried rock
- Locally available on order in desired amounts and sizes
- Concrete rubble and scrap
- Uncertain availability, variable size and shape
- Manufactured substrates
- Designed for specific application

#### **EFFECTS OF ENHANCEMENT AS ARTIFICIAL REEFS**

- Resources and habitat
- New or expanded reef communities
- Displacement of existing bottom communities
- Uses and activities
- Additional opportunities for reef-related uses
- Local limitations to uses of soft bottom habitats

## **LONG-TERM SOCIOECONOMIC EFFECTS OF ONSHORE FACILITY DECOMMISSIONING**

**JAMES T. LIMA, PH.D.**

**Sociologist, Minerals Management Service, Pacific OCS Region**

### **ABSTRACT**

The potential long-term social and economic effects attributable to the decommissioning of onshore oil and gas processing facilities and sites that support offshore energy development vary with the type of facility. Limited experience with decommissioning in California poses new challenges to federal, state, and local decision makers. The process of decommissioning facilities that support a single offshore field at the cessation of production is fairly straightforward. The long-term consequences of this action are generally negligible or beneficial. The process of decommissioning co-located and co-operated (consolidated) facilities is more complex. The long-term consequences of this action to land use, economic diversity, and government revenues may be quite sizeable. Furthermore, the potential cumulative impact of onshore disposal on landfill capacity needs to be examined as part of the decommissioning process.

### **INTRODUCTION**

The decommissioning of onshore facilities and sites that support offshore energy development in California State submerged lands and the Pacific Outer Continental Shelf is a relatively new phenomena. Depending on the type of onshore facility, decommissioning may have potentially sizeable, long-term cumulative consequences. This paper examines (1) the nature of decommissioning and the potential social and economic impacts, (2) the three types of onshore facilities--private system, location consolidation, and operation consolidation, (3) the likely long-term consequences from the decommissioning of each type, and (4) the components that make up decommissioning policy.

### **SOCIAL AND ECONOMIC CONSEQUENCES OF DECOMMISSIONING**

Most organized human activity generates any number of social and economic consequences. These impacts, which may be adverse or beneficial, encompass a number of areas including aesthetics, noise, infrastructure, land use policies, public finance and economics, and recreation. Furthermore, the magnitude of the impact varies within the context of where the activity takes place and where the effects are realized. Table 1 lists some of the general criteria for assessing social and economic impacts. While each area has unique criteria, for most social impacts when demand exceeds the supply of a service or capacity of the community to provide the service, a adverse or "negative" impact occurs. Furthermore, impacts may be incremental and project-specific, that is, attributable to a specific action or cumulative, the combined effect when the increment is added to past, present, and future actions. As such, the incremental impacts of a single action may seem inconsequential while the cumulative impacts are quite sizeable.

The life cycle of offshore energy projects progress through four phases — exploration, development, production and decommissioning. Social and economic impacts are usually most pronounced during the development phase when offshore and onshore facilities are sited and constructed. The increased level of activity with its attendant increase in employment and expenditures causes both short-term and long-term in-migration of people to the area creating demands for public services. After the production system (e.g., platforms, completions, pipelines, and the onshore processing and transportation facilities) is completed and operating, the breadth and magnitude of in-migration impacts dramatically decline. The social and economic impacts

caused by the onset of decommissioning, during which wells are plugged and production-related facilities close and are dismantled, will vary depending on the extent

to which the area is dependent on the oil and gas industry (Scheweithelm and McPhee, 1983, 175).

**Table 1.** Criteria for the Assessment of Social and Economic Impacts in Onshore Facility Decommissioning. (Area and Criteria for assessment adapted from California Comprehensive Offshore Resource Study, Volume 1. California State Lands Commission, 1994).

Area	Criteria for Assessment	Likely Long-Term Effect
Cultural Resources	<ol style="list-style-type: none"> <li>1. Effect on prehistoric or historic archeology site.</li> <li>2. Adversely affect a site or property of cultural significance to a community or ethnic group.</li> <li>3. Restrict existing uses which are religious or sacred to a recognized group.</li> </ol>	None. Most of the impacts result for on-site construction. Dismantling of facilities should avoid areas known or suspected to be culturally significant.
Aesthetic (Visual)	<p>Changes in view of</p> <ol style="list-style-type: none"> <li>1. primary travel routes and use areas.</li> <li>2. a component for which there is a public interest and concern.</li> <li>3. sensitive or unique natural community</li> <li>4. on the horizon.</li> </ol>	Beneficial from the removal of industrial facilities in primarily non-industrial area. Re-industrialization after decommissioning of consolidated facility could induce new impacts.
Infrastructure	<ol style="list-style-type: none"> <li>1. Increase level of traffic to degree that it reaches an unacceptable level of service.</li> <li>2. Substantially reduce available capacity of public water supply, sewage treatment, energy systems, schools, solid waste, toxic waste or public safety personnel and facilities.</li> </ol>	Few long-term impacts due to stable low level employment in post-development phases. Re-industrialization after decommissioning of consolidated could induce new impacts. Impact on solid waste disposal capacity is possible.
Land Use	<ol style="list-style-type: none"> <li>1. Inconsistency with local or state land use policies.</li> <li>2. Commitment of land, elimination of future land use options.</li> </ol>	Beneficial for private system facility. Potentially sizeable for location and processing consolidation.
Public Finance/Economics	<p>Does the action result in:</p> <ol style="list-style-type: none"> <li>1. Significant changes in public revenues.</li> <li>2. Significant changes in public agency expenditures.</li> <li>3. Changes in local property values.</li> <li>4. Nonconformance with local land use and coastal programs.</li> </ol>	Likely negligible effects for private system facilities. Potentially sizeable for location and processing consolidation depending on value of offshore industry to local economy and tax base and ability of government to replace lost revenue.

The prevalence of social and economic impacts during the development and production phases does not mean that a reduced level of activity during decommissioning is inconsequential. A National Research Council study (1992, 100) recognized that termination requires more and different labor than production. Beyond the short-term impacts, the study recognizes certain long term and cumulative impacts may result from termination, determined largely by "the extent that the economic and social characteristics of regions have been shaped by the petroleum industry." The cause of these impacts will not only be from the cessation of a primary economic activity, but that its disappearance has "also left in its wake conditions that may hinder alternative uses and repel those who might invest in their development." Investment in development of other activity is likely to be hindered, the report posited, because uncertainty will remain about the future of oil and gas resources of an area, which may be resumed under different economic conditions.

Rapid production declines and facility decommissioning in an area highly dependent on the offshore energy industry can have very pronounced social, financial, and organizational impacts and regionally important economic consequences, as seen in the "bust" in the Gulf offshore industry in the 1980s (See Gramling, 1996, 97-118; Seydlitz, *et al.*, 1995; Thayer and Hadley, 1990). For the most part, California communities affected by offshore energy development, which is a much smaller segment of the area's economy than in the Gulf of Mexico, have not experienced the severe economic dislocations induced by the decline of the oil prices in the 1980s. However, the economic impact of offshore energy development on Ventura and Santa Barbara County, as one recent study noted, does provide significant benefits to the area. The study surmises that the cumulative impacts of a gradual decline and cessation of the activity could be sizeable (UCSB Economic Forecast Project, 1997). Moreover, within this area, energy development activities have had different cumulative effects on the two counties and within the counties (Paulsen, *et al.*, 1996; Molotch and Freudenburg, 1996). Social scientists recognize that the limited experience with decommissioning of facilities in the Pacific means that the socioeconomic impacts

attributable to this final phase may be the least well understood of all the impacts (SCEI, 1991, B37).

Finally, understanding the impacts of decommissioning are important to the policies which govern the development of offshore energy resources in the future. Decommissioning may be seen as policy termination (SCEI, 1991). The policies that shape offshore energy activity at any given time are a combination of location, technology, economic, and political factors (Lima, 1994), and the effect of these factors will shape decommissioning policy. Offshore energy projects have very long life cycles. Decommissioning occurs within the context of the time and place. The policy that governs activity at the end of one era of development becomes the foundation for policy that will govern the next era of development. Yet, there is not a single "decommissioning policy." Rather, it is an amalgam of the policies of the government agencies at all three levels of government involved in the process.

## **CLASSIFICATION OF ONSHORE FACILITIES**

Different types of onshore facilities may require unique policies for decommissioning of facilities. Using the typology of onshore facilities developed by Willard Price (1987), onshore processing facilities in Ventura and Santa Barbara counties fall into two classes--the private (market) system and the private industrial development. Private system development is characterized by the "maximum private freedom to own land and develop facilities, within traditional local government land use, site development, and building controls." Private industrial development, of which consolidation is a variant, is characterized by "private ownership and development of facilities, involving public industrial development sites, within public plans and environmental regulations."

### **PRIVATE (MARKET) SYSTEM**

The private system onshore facility affords the developer maximum discretion and flexibility in the siting and the sizing of its onshore processing facility and describes the system that was prevalent in Ventura and Santa Barbara counties until the early 1970s.



Facilities were designed and sized for the particular characteristics of the product and the field. Facilities were usually sited as close as possible to the landfall of the offshore-to-onshore pipelines, in order to minimize transportation costs. If several operators developed the same field, each usually had its own processing facility. Shared facilities or the commingling of production from several fields at a single plant was not usually practiced and in some cases was prohibited. These separate onshore sites were relatively close together, reflecting the pattern of offshore leasing, land ownership and the previous oil field development. In combination with existing onshore production, private system development resulted in the industrialization of the coastline as each operator constructed a separate onshore plant. (For a detailed description of energy facility siting in general see New England River Basins Commission, 1976, and in the Santa Barbara Channel in particular see Centaur Associates, 1985 and Lima, 1994). Planning for these facilities was sequential and reactive, with each facility being considered individually when the operator requested initial or subsequent permits (Price, 1987).

## **PRIVATE SYSTEM DECOMMISSIONING**

Under the private system, onshore processing facilities, the processing site, and offshore production components (platforms, subsea completions, slant drilling from an onshore site) are physically and conceptually linked. When the decision is made by the company to terminate operations, decommissioning of the entire seaward and landward components may proceed simultaneously. In essence, the private decision renders the entire production/processing system redundant. (Government policies influence the economic attractiveness of continued production under prevalent market conditions. See, for example, California Oil Survival Team, 1993.) Each level of government is concerned with facilities within its jurisdiction. Private system decommissioning exhibits the least regulatory overlap. All onshore equipment can be removed and the site restored with little concern of the cumulative effect of these actions. Decommissioning is and was very much a case-by-case, facility-by-facility decision. As such, onshore decommissioning

activities are primarily concerned with issues proximate to the physical environment--facility removal, clean-up of on-site contaminated areas, site restoration, and revegetation.

Local governments have had limited experience with decommissioning private system onshore facilities. Facilities and sites that supported offshore production have only recently begun to be decommissioned. Formal decommissioning policy for the private system has been very ad-hoc, contained in a collection of land use plans and ordinances and in individual facility permits. Policy is very general, mandating removal and restoration. Details of decommissioning were very site specific and concentrated on the best way to achieve the removal and restoration objectives for each specific site. These detailed procedures are often contained in a regulation-mandated abandonment plan or by some other action by public authorities (SBC, 1990).

This "policy" has generally functioned adequately. However, one Santa Barbara County (1996) publication noted that while the regulatory framework appeared to be functional overall, some potential issues warrant attention. Particularly, variation was found to exist in "due diligence towards timely abandonment of an oil and gas operation, including the removal and restoration of the site"(SBC, 1996). In some cases, the "lag" between cessation of operations to commencement of removal has been unacceptably lengthy to local decision makers and other stakeholders.

Another concern regarding timeliness of action involves how to ensure industry bears the costs of decommissioning rather than the public, which could be exposed to potentially large risk if decommissioning is not accomplished as intended. This latter concern is the reason that permits require performance bonds or some other type of surety.

## **IMPACTS OF PRIVATE SYSTEM DECOMMISSIONING**

Decommissioning occurs in the context of the current time and place. This facet is seen in land use issues which are the primary social and economic impacts of private system decommissioning. Potential impacts include

the compatibility of the decommissioned site with adjacent land uses and ensuring the new land use designation is consistent with state land use policy, such as California Coastal Act policies. Given the long life cycles of energy projects and the changing pattern of land use, the current policies are likely to be much less tolerant of renewed use of the individual sites for processing. For example, the California Coastal Act requires consolidation of onshore energy facilities. In turn, this requirement is part of each county's local coastal land use plan.

The processing facilities that supported the "Mobil pier" state tideland leases were in part authorized by Ventura County via a conditional use permit (CUP) in 1948. When these facilities were recently decommissioned, the CUP required minor modification to address the dismantling of facilities. However, the CUP remained in effect because some facilities covered by the CUP were still in operation (Fugro West Inc., 1996). Underground pipelines were abandoned in place to minimize ground disturbance. Above ground pipelines were either removed or were to remain in place until the entire pipeline corridor which served more than the processing plant was abandoned. Zoning of the parcel remained Coastal Manufacturing, which limited uses of the parcel to petroleum related activity until the zoning designation is changed. The surrounding land use is zoned as coastal open space or industrial, uses that are compatible with petroleum related activities (Francis, 1997). However, since the site is within the area intended for onshore processing, the action is consistent with current policy.

Santa Barbara County chose to change land use designation of private system facilities in advance of decommissioning in part to ensure compliance with Coastal Act-mandated consolidation policies. The decision in 1990 to rezone seven existing onshore sites in the area adjacent to the Santa Barbara Channel was done at a time when many of the sites still supported offshore production. The rezoning action had the effect of rendering offshore energy processing at these sites a "legal non-conforming land use" which allowed the continued existing use that would otherwise not be permitted under the new designation. While non-conforming land uses may be

continued, the designation prevents the expansion or enlargement of that use (SBC, 1990). This action will cause future processing to occur at consolidated facilities in accordance with current policy.

The long-term social and economic effects of properly decommissioned onshore private system sites are few. Cultural resource impacts occur during the development phase from construction. Aesthetically, removal of industrial facilities in primarily non-industrial areas is viewed as a benefit, as is the restoration of the site to a land use and zoning designation that is compatible with the surrounding area. The economic consequences of decommissioning are ameliorated by the fact that for many years the facility most likely supported declining production from the associated field and operated with a relatively small and stable workforce. The public finance and service impacts are minimized because when production ceases the property tax value of the physical plant (i.e., improvements to the land) is minimized. In some cases, whatever use replaces the facility, such as conversion of the processing site to a recreational or residential development, may lead to greater assessed valuations in the long term.

## **PRIVATE INDUSTRIAL DEVELOPMENT (PID)**

Under the private industrial development concept, land and facilities are privately owned and developed within the framework of public plans and environmental regulation. An example of the PID is the establishment of consolidated processing sites and facilities in Santa Barbara County in the mid-1980s. Price (1987) notes that consolidation creates an onshore "oil industrial park" and represents a step toward comprehensive, proactive planning away from the sequential and reactionary planning that characterizes private system development. There are two types of consolidation--location consolidation and operational consolidation.

## **LOCATION CONSOLIDATION**

Location consolidation is structured so that separate processing facilities must be co-located in a designated geographic area or within a specific site. That is, land use plans

and ordinances designate the areas where these facilities are to be co-located. This policy attempts to reduce the cumulative impacts of individual facility construction by aggregating the impacts from many sites to a centralized location. However, location consolidation retains many of the characteristics of the private system described above wherein each operator is free to construct and operate facilities within this zone. Often, the extent of the area where facilities will be allowed is determined by the already existing concentration of facilities in an area from previous and current development. The strategy presently used by Ventura County approximates location consolidation.

In Santa Barbara County, location consolidation was a strategy first announced in 1967 in order to reduce industrialization of the coastline brought on by the projected number of onshore processing plants that would be needed to support expanded offshore leasing. The policy favored expansion of existing facilities onto lands adjacent to existing sites and consolidation of facilities on existing processing sites or the land adjacent to them as an alternative to new, separate sites (Lima, 1994). This policy marked the transition from the private system to the private industrial system since it controlled within public plans and policies where and under what circumstances that onshore facilities could be sited.

## LOCATION DECOMMISSIONING

Location consolidation decommissioning allows removal of facilities but retains the underlying land use designation which allows the continued use of the site for processing. If a single operator chooses to decommission facilities, the action might require removal of equipment and restoration of a portion of the site, but it does not require that the entire site and all facilities be decommissioned. An area may experience a “rolling decommissioning” of facilities over the life of the site. Indeed, the site could experience cycles of industrialization and decommissioning over time. However, the site would always be available to support onshore activities for offshore development. In fact, regulations could make provisions for redundant facilities to be mothballed for a specified period of time to avoid impacts from rebuilding on the site. However, in requiring all

onshore facilities to be sited within the zone, location consolidation prevents expanded industrialization into other coastal areas. The challenge to policymakers is to determine how large an area location consolidation needs in order to be successful and translating that area into reality, through land use plans and ordinances.

## OPERATION CONSOLIDATION

Operation consolidation is structured so that multiple operators commingle processing at a single facility or prescribed number of facilities at a designated site. In this respect, facilities are not only co-located (location consolidation), they are co-used. The process of siting and designating these sites is more complicated than for a single-operator facility (New England River Basin Commission, 1976).

In Santa Barbara County, when the policy regarding consolidated facilities and sites became fully developed by the mid-1980s, the objectives for this siting strategy went beyond the desire to reduce the number of facilities and locations and the future demand for the same. The objectives of operation consolidation are fairly straightforward. These policies seek to:

- reduce the number of facilities and the number of locations both in the present and in the future (Anthony, *et al.*, 1991);
- reduce or concentrate environmental impacts and reduce cumulative impacts (Callahan, *et al.*, 1987);
- help reduce residual risks to the coastal environment (Douros, *et al.*, 1991);
- provide all potential operators with an opportunity to develop resources by avoiding denial of “future development that has been precluded by projects that have occurred at a pace and manner that prematurely exhausts limited resources” (Callahan, *et al.*, 1987). (Broadly defined, resources includes land for processing sites.)

Consolidation strategies are not necessarily designed to limit offshore development activity by restricting onshore processing, although they could theoretically have that effect. Consolidated sites can be sized to allow room for additional facilities or expansion of existing facilities assuring land resources for future

processing if needed. Encroachment of consolidated sites by incompatible land uses can be minimized if a comprehensive planning process designates land uses for areas adjacent to the consolidated site.

Santa Barbara County policy regarding consolidation requires "new" production, to the extent technically and environmentally feasible, to be (1) processed at consolidated facilities to the maximum extent possible and (2) commingled, that is, production from several operators processed at a single facility, even if throughput has to be reduced proportionately to accommodate new operators. The policies further restrict the construction of additional facilities at consolidated sites in order to eliminate "redundant facilities." The authorized consolidated facility capacity was determined, in part, by considerations of a future potential level of development.

## **OPERATION CONSOLIDATION DECOMMISSIONING**

The process of decommissioning either type of consolidation will be comparatively more complicated than the private system. Similarly, the social and economic impacts from the decommissioning are likely to be more complex. The difference in potential impacts stems from the basic structure of the three. With consolidation, there is a conceptual if not real separation of "onshore" and "offshore" facility decommissioning and a separation of "facility" decommissioning from "site" decommissioning. Furthermore, a number of other considerations arise when comparing location consolidation to operation consolidation decommissioning.

For example, operation consolidation must consider the impact of multiple users. A single operator may decommission offshore structures, ceasing input into the onshore facility. This cessation of an operator's input may increase the marginal costs of the remaining users if they do not increase production to maintain a level of throughput. However, in a multiple-user facility it is unlikely that the loss of any single operator will raise marginal costs of processing to the point that continued production for remaining users becomes economically irrational, especially if the throughput was pro-rated among the

users. As such, decommissioning of offshore structures need not be causally linked to decommissioning of onshore structures. However, if the facility depends on the throughput of one dominant operator, decisions regarding decommissioning may indeed affect the future viability of continued use by the remaining operators.

The number of stakeholders potentially involved in consolidation complicates decommissioning decisions. The expectations of facility and site owners, the facility operator and the facility users (all of whom may be different) as well as the desires of different levels of government and the public must be taken into account when making decisions about the decommissioning of facilities and onshore sites. One of the long-term public policy questions for operation consolidation is "what is sufficient onshore processing capacity for current and future production?" With location consolidation the question becomes one of "what is the sufficient onshore area for current and future production?" Given the uncertainties involved in energy development the answer to the questions may be somewhat problematic.

## **LONG-TERM SOCIAL AND ECONOMIC CONSEQUENCES OF CONSOLIDATED DECOMMISSIONING**

The answer to the questions considered in decommissioning will be very important since it has the potential to affect the future economic diversity of an area. Onshore infrastructure imparts a economic and regulatory bias to the area in favor of additional development. The availability of infrastructure is a factor in a firm's decision to undertake new or expand existing operations in an area (Lima, 1994). Decommissioning expenditures have very little impact on future economy, that is, employment created by facility removal and restoration is a short-term benefit. Once the tasks are completed the economic benefits of increased employment cease. However, expenditures for maintaining capital infrastructure, such as consolidated facilities, provide a means of continued tax revenue, employment, and other potential economic gains. The attractiveness of maintaining this infrastructure is a decision that is made in the light of several factors,

including compatibility of offshore activity with other values and competing and possibly incompatible uses.

In an area where operation consolidation is in effect, careful thought must be given to the consequences of closure and dismantling of a consolidated facility prematurely--prior to the exhaustion of possible production in the area. This action may make follow-on production uneconomic if the remaining producers are unwilling to assume operation of an existing facility or undertake construction of a replacement facility. If construction of a replacement facility is undertaken, the area will experience some measure of social and economic impacts with the attendant increased demand for public services and infrastructure that characterize the development phase of offshore energy projects. In addition, the decision to decommission facilities and sites must be consistent with state coastal policies which seek to minimizing industrialization of the coastline.

If the purpose of operation consolidation was to achieve the objectives listed above, the success or failure policy must be evaluated in light of the extent that impacts from the re-industrialization of the area are prevented, avoided, or minimized. As such, facility decommissioning and retention of the consolidated site must be considered as an alternative. Conversely, premature decommissioning may hasten the end of extractive industry in the area in favor of other non-extractive uses. To the extent that these other uses can replace the contribution of energy activity and not cause greater cumulative development impacts, these may prove more valuable than continued encouragement of the offshore industry.

Premature cessation of production could have sizeable impacts on government revenues as valuable infrastructure is suddenly removed from the property tax base of a community. However, the local government revenue from offshore energy is more than just the sum of property and sales tax revenues and fees charged the operating companies. In Santa Barbara County, for example, approximately 9.7 million dollars has been provided to the Coastal Resources Enhancement Fund (CREF) since 1987 by various offshore energy

projects. These contributions represent an offset of residual coastal recreation, aesthetic, tourism and other impacts caused by offshore energy development that could not be mitigated using other strategies (McNeal-Pfeifer, 1997). In the decade since its inception, the fund has provided monies to local public and not-for-profit organizations for a variety of activities including coastal land acquisition, infrastructure capital and operating improvements and recreation programs. In some cases, The CREF fund provided the matching funds needed to "leverage" greater amounts. Whether or not these programs would have been or could have been funded in the absence of energy development is speculative. But, even a cursory examination of the projects funded through CREF reveals an improvement in the local quality of life that arguably may not have occurred in the absence of these offset funds. Furthermore, the synergistic effects of the "seed money" that CREF expenditures provided has not been thoroughly examined. When analyzing the long-term consequences of facility decommissioning, the value of the offshore industry must be made in light of the contributions and consequences of that activity and the impact it has on public finance and infrastructure.

The long-term effect of decommissioning may also be realized in government operations. The fundamental structure and practices of local government has had to change to accommodate offshore energy development (Lima and Woolley, 1990, 1991; Lima, 1994, 1995). Since location and operation consolidation are mandated by public policies, it stands to reason that decommissioning of these facilities will create new administrative challenges and there will be greater government involvement in the decommissioning. Also, since consolidation is essentially a government industrial development policy it is likely that more stakeholders will seek to have their concerns addressed through public administrative and political forums.

## THE DISPOSAL ISSUE

Experience with the deconstruction of facilities and disposal of the non-salvageable material in landfills has not indicated an impact to public services and infrastructure. However, there

may be cumulative effects from the onshore disposal of materials in light of existing landfill capacity. Whether or not onshore disposal constituted a substantial long-term effect would depend on the amount of material requiring disposal in a landfill and the impact that the disposal has on the remaining capacity of landfills. California has mandated that local governments reduce the amount of material deposited in landfills, but the potential contribution of decommissioning to the waste stream remains to be estimated.

Dismantling of the Mobil pier onshore processing facilities in Ventura County was projected to result in up to 60 truck trips, half to remove debris and scrap from the site and half to remove used and surplus material (Fugro-West, Inc., 1996). Local landfills capacity was adequate to handle the debris. Similarly, when the so-called "4-H" platforms (Hazel, Hope, Hilda, and Heidi) were recently decommissioned approximately 11,000 tons of steel were brought to shore at San Pedro, California, and sold as scrap for approximately 330,000 dollars. However, ultimate onshore disposal costs exceeded salvage revenue by approximately one million dollars. The contractor had to handle and dispose of 3,000 tons of marine growth, 1,000 tons of cement, and 300 tons of mud at an approximate cost of 850 thousand dollars, 275 thousand dollars, 275 thousand dollars, respectively (Bafalon, 1997). The California State Lands Commission (SLC, 1993) noted that disposal could constitute the "critical environmental issue." Disposal impacts are a factor of how much material has to be processed, length of time needed to break up and dispose of the facilities, the location of the disposal activity, and whether the disposed elements contained toxic materials.

The subsequent environmental assessment for the removal projected noted no short- or long-term effects from disposal (SLC, 1994).

## **CONCLUSION: FRAMEWORK FOR ONSHORE FACILITY DECOMMISSIONING POLICY**

Limited experience with decommissioning presents new challenges to decision makers. Presently, clear policy direction does not exist regarding the decommissioning of onshore sites. While it is beyond the scope of this paper to suggest a model policy, a framework for addressing decommissioning should, at a minimum, address the following items:

1. The point at which facility decommissioning is triggered (i.e., cessation of current production, cessation of anticipated production, decline of throughput below a specified threshold).
2. The process to be followed to initiate decommissioning, including provisions for stakeholder input.
3. The mandatory and alternative actions for decommissioned facilities and sites (e.g., complete removal and restoration, remediation of contamination, partial removal of unused equipment, temporary suspension in anticipation of future need, rezoning of land, abandoning pipelines in place, etc.).
4. The time frame in which on-site decommissioning actions must be completed.
5. Provisions to ensure financial resources are available to complete decommissioning.
6. The requirement for site-specific approval of actions (e.g., a decommission plan for each facility and site).
7. A process for considering of the long-term cumulative effects of decommissioning and strategies to reduce these effects.

## REFERENCES

- Anthony, Douglas, William Douros and John Zorovich. 1991. *Land Use Issues Raised by Offshore Oil and Gas Development*. Coastal Zone 91. Proceedings of the Seventh Symposium on Coastal and Ocean Management. American Society of Civil Engineers. New York.
- Bafalon, Lee. 1997. Personal Communication with James Lima, On file, Minerals Management Service, Pacific OCS Region, Camarillo, CA.
- California Oil Survival Team. 1993. *Environmental and Other Issues Confronting the California Petroleum Industry*. Workshop Proceedings. ICF Resources, Incorporated.
- Callahan, Catherine, Amy Margerum and Sharon Maves. 1987. *Innovative Approaches to Mitigating Cumulative Impacts*. Coastal Zone 87. Proceedings of the Fifth Symposium on Coastal and Ocean Management. American Society of Civil Engineers. New York, NY.
- Douros, William, Bruce Carter, and Douglas Anthony, 1991. *Risk of Transporting Petroleum and Other Materials from Offshore Oil and Gas Development*. Coastal Zone 91. Proceedings of the Seventh Symposium on Coastal and Ocean Management. American Society of Civil Engineers. New York, NY.
- Francis, Nancy. 1997. Personal Communication. Ventura County Resource Management Agency.
- Fugro-West, Inc. 1996. *Dismantling of Mobil Onshore Facilities. Production and Gathering Lines, Ferguson/Tomson Tank Battery, Produced Water Filtering System, West Coast Tank Farm*. Conditional Use Permit No. 48. Minor Modification, Execution Plan. On file. Ventura County Resource Management Department.
- Gramling, Robert. 1996. *Oil on the Edge: Offshore Development, Conflict, Gridlock*. State University of New York Press. Albany, NY.
- Lima, James and John Woolley. 1990. *Santa Barbara County Response to Offshore Oil Development*. Proceedings of the Annual Meeting of the American Political Science Association. The Association. Washington, D.C.
- Lima, James and John Woolley. 1991. *Santa Barbara County and Offshore Oil Development -- Applicability of the Lessons to Other Communities*. The California Coastal Zone Experience. American Society of Civil Engineers. New York, NY.
- Lima, James. 1994. *The Politics of Offshore Energy Development*. Doctoral Dissertation. Special Collections. Davidson Library. University of California, Santa Barbara, CA.
- Lima, James T. 1995. *Life Cycle of a Land Use Planning Agency in California: Santa Barbara County and Offshore Energy Development*. Annual Meeting of the Southern Political Science Association.
- McNeal-Pfiefer, Kathy. 1997. Personal Communication on Coastal Resource Enhancement Fund Expenditures. On file, Minerals Management Service, Pacific OCS Region, Camarillo, CA.
- Molotch, Harvey and William Freudenburg. 1996. *Santa Barbara County: Two Paths. OCS Study MMS 96-0036*. U.S. Department of the Interior, Minerals Management Service, Pacific OCS Region. Camarillo, CA.
- National Research Council. 1992. *Assessment of the U.S. Outer Continental Shelf Environmental Studies Program. Volume 3. Social and Economics Studies*. National Academy Press. Washington, D.C.
- New England River Basins Commission. 1976. *Onshore Facilities Related to Offshore Oil and Gas Facilities: Factbook*. The Commission. Boston, MA.

- Paulsen, Krista, Harvey Molotch, and William Freudenburg. 1996. *Ventura County: Oil, Fruit, Commune and Commute*. OCS Study MMS 96-0035. U.S. Department of the Interior, Minerals Management Service, Pacific OCS Region. Camarillo, CA.
- Price, Willard. 1987. *Offshore Oil in the Coastal Zone: A role for Seaports*. Coastal Management. 15 3:229-246.
- Santa Ynez Unit OS&T Abandonment*. U.S. Department of the Interior, Minerals Management Service, Pacific OCS Region. Camarillo, CA.
- SBC. 1987. *Exxon Santa Ynez Unit Final Development Plan, No. 87-DP-32cz, Conditions of Approval*. Santa Barbara County, California, Resource Management Department, Energy Division. Santa Barbara, CA.
- SBC. 1996. Santa Barbara County, California. *Oil and Gas Abandonment. Offshore Oil and Gas Status Report for September 1996*. Planning and Development Department, Energy Division. Santa Barbara, CA.
- SBC. 1990. Santa Barbara County, California. *Proposed Rezone of Oil and Gas Facility Sites, South Coast Consolidation Planning Area*. Resource Management Department, Energy Division. Santa Barbara, CA.
- SCEI. 1991. Southern California Educational Initiative. *Socioeconomics Workshop. Workshop Report. OCS Study MMS 91-0012*. U.S. Department of the Interior, Minerals Management Service. Pacific OCS Region. Camarillo, CA.
- Schweithelm, James and Michael McPhee. 1983. *Onshore Effects of Oil and Gas Development. Technical Environmental Guidelines for Offshore Oil and Gas Development*. Edited by John Gilbert. Pennwell Publishing Co. Oklahoma City, OK.
- Seydlitz, Ruth, John Sutherlin, and Samantha Smith. 1995. *Characteristics and Possible Impacts of a Restructured OCS Oil and Gas Industry in the Gulf of Mexico*. OCS Study MMS 95-0055. U.S. Department of the Interior, Minerals Management Service, Gulf of Mexico OCS Region, New Orleans, LA.
- SLC. 1993. California State Lands Commission. File Memo. File No. 40654. Chevron Carpinteria Platform Abandonment. Meeting to Discuss CEQA Application. August 13, 1993. The Commission. Sacramento, CA.
- SLC. 1994. California State Lands Commission. 1994. *California Comprehensive Offshore Resource Study. Volume 1*. The Commission. Sacramento, CA.
- SLC. 1994. California State Lands Commission. Notice of Public Review of a Proposed negative Declaration. File W40654 ND652. Removal of Offshore Oil Platforms Heidi, Hilda, Hope and Hazel. May 9, 1994. The Commission. Sacramento, CA.
- Thayer, Ralph and Charles Hadley. 1990. *The Impacts of the Recession in Outer Continental Shelf Activity on the Provision of Public Services by State and Local Government in Coastal Louisiana*. Proceedings of the Eleventh Annual Gulf of Mexico Information Transfer Meeting. OCS Study MMS 90-0040. U.S. Department of the Interior, Minerals Management Service, Gulf of Mexico OCS Region, New Orleans, LA.
- UCSB Economic Forecast Project. 1997. *The Economic Contribution of the Oil and Gas Industry in the Tri-Counties*. Western States Petroleum Association. Santa Barbara, CA.



---

---

## **SUMMARY AND RECOMMENDATIONS**

---

Technical Session .....	137
Environmental Session .....	140
Disposition Session.....	145



## TECHNICAL SESSION: SUMMARY AND RECOMMENDATIONS

### MARINA VOSKANIAN and DR. ROBERT BYRD Session Co-Chairs

**Russ Schmitt:** Now we will hear from Marina Voskanian. Marina will give an overview of the technical sessions work group report.

**Marina Voskanian:** Thank you Russ. Good Morning ladies and gentleman. I am so pleased to see such an overwhelming interest for this workshop over the last two days. We had a technical program with several people contributing to that session. I would like to thank every one of them. Thank you to the League of Women Voters, they had a great input in our session. We heard from Surfriders, the County of Santa Barbara. Of course the members from SLC and MMS, Department of Conservation, Division of Oil and Gas, American Pacific Marine, Twachtman, Snyder and Byrd who had a great role in organizing this session, Frugal and others.

During our technical session that was conducted Tuesday afternoon we received different options available and type of technology generally used to accomplish the decommissioning and removal of offshore facilities in environmentally safe and efficient manner. This session as you saw was oriented toward informing the public and non-technical personal on plugging the wells, the commissioning of topside, production equipment and debris jackets, pipelines and cables. The site clearings and verification, and onshore facilities clean up and removal were also discussed. There were two to three issues that arose during that technical session and I would like to invite my co-chairman Bob Byrd to address those issues. Thank you.

**Bob Byrd:** There were at least two issues and probably others, but there were two that jumped out at us, that we felt deserved some comment. The issue of structural longevity, or rather the prospect of leaving decommissioned structures in place was discussed on several occasions during the last day or so. We felt we needed to comment about the requirements for leaving a structure in place.

In particular the maintenance requirements of these structures. Offshore platforms are relatively high maintenance issues in terms of maintaining their structural integrity. Many of the platforms offshore California have impressed current cathodic protection systems which prevent corrosion and deterioration of the structural steel. Something to replace this would likely be required if the topside were removed and electrical power generation or attached power cables from other facilities were removed. There are possibilities of other passive forms of cathodic protection, but without some cathodic protection these platforms would deteriorate very rapidly. This issue needs to be considered in leaving these platforms in place.

The other comment that we want to make is that there is a fair amount of anecdotal evidence that structures which are submerged well below the splash zone or free surface would have a very long life. There are a number of places in the world where you can see ships that have existed for fifty to one hundred years and are still in relatively good condition. The offshore platforms which you are looking at out here have much heavier steel than a ship's so I think you can make a pretty strong argument that they would be around for a long time provided there was no contact with the air-water interface.

The other issue we want to comment about is that of the possibility of refloating jackets. We had made some comments responding to questions from the audience that it would be very difficult using conventional means to pick up one of the large structures here, move it into either a shallow water site or a deep water disposal site. Technically that is a very difficult thing to accomplish. Afterwards Bill Griffin reminded me of a presentation we both saw this last spring at Aberdeen at a decommissioning conference related to development of external buoyancy packages which can be attached to platforms. While this is something that is in an early state of

development, it turns out after putting a few numbers on paper that in fact it does appear that it is something that may be feasible with more development. This type of removal technique would have a very significant impact on the options available for the disposition of jackets. It would affect the feasibility of deep water disposal. It would affect the feasibility of shallow water reefing of an entire jacket. It would affect the feasibility of removing a jacket as a single unit to a distant disposal site of whatever type you choose.

Finally we were approached this morning with the comment that we really do not give a great deal of consideration in the technical session to the reuse of facilities offshore California. I think that is a fair comment. In looking at the prospect of reusing of the California facilities, it is a little problematic for us to generate a lot of enthusiasm for the possibility of reusing the facilities in a context of an environment where there is not a lot of ongoing development. If you look at the Gulf of Mexico market platform, jacket and facility reuse has gotten to be very popular. Probably 25% of the jackets or facilities historically have been reused. Today's market with increased activity that percentage is probably increasing. In the context of California decommissioning what is likely to happen would be that individual components from facilities would be reused. For example generators, production modules, or perhaps quarters packages. Today it would be likely that these would be reused in distant markets, perhaps in Southeast Asia, South America, or other areas. It seems unlikely that today there would be a great deal of opportunity to reuse these facilities in California. Although that situation may change. Thank you.

## **TECHNOLOGICAL SESSION SUMMARY & ISSUES**

### **1. Session Summary:**

The technical sessions reviewed options available and the type of technology generally used to accomplish the decommissioning and removal of offshore facilities in an environmentally safe and efficient manner. This session was oriented toward informing the public and non-technical personnel in general on the decommissioning process. Emphasis was on explaining the various steps and the

options available. Specific areas covered in the session were: plugging of wells and the cleanup and disposal of production equipment, related structures, pipelines and cables. Offshore site clearance and verification and onshore facility cleanup and removal were also discussed.

### **2. From this session's questions and the general discussion during the workshop, the following issues deserve comment from a technical perspective:**

- **Structure Longevity**

Structures left above the water line will require significant and continuous maintenance to insure their long term survival. The air/water interface creates a galvanic cell which accelerates corrosion unless cathodic protection is provided. Many California platforms have impressed current cathodic protection systems which require electrical power to operate. This would not be easy to provide on decommissioned platforms. Passive cathodic protection systems, which are found on some structures, generally have a life of approximately twenty years. These systems would require anode replacement on a continuing basis to survive, along with maintenance painting of exposed surfaces.

There is significant evidence that steel structures submerged well below the splash zone (water surface) would have very long life. Steel ship hulls have been found in relatively good condition after nearly one hundred years submergence. Offshore platforms have much thicker steel plate in their structures than do ships.

- **Jacket Removal**

There is ongoing development related to external buoyancy systems which may make it feasible to re-float jackets in a single piece. This will have significant impact on the options available for jacket disposal, such as deep water disposal, shallow water reefing and towing to distant disposal sites. It is reasonable to assume that this technology will be developed in the near future as the demand for its application dictates.

- **Facility Reuse**

Questions concerning the feasibility of reusing all or part of offshore facilities in other oil and gas industry applications arose in discussions. This issue was not addressed in any significant detail during the session, primarily due to time limitations. In closing we wish to make the following observations concerning this subject:

1. While reuse of oil and gas processing facilities is becoming very popular in some areas such as the Gulf of Mexico, it seems unlikely that there will be an opportunity to do much of this offshore California because of the limited amount of new development that is anticipated. Processing equipment that is brought to shore will be screened and the most valuable items will be transported to other areas for reuse. The remainder will be scrapped.
2. Complete process modules may be used in some cases where it is practical to remove them intact and transport them to the new application area for refurbishment and reinstallation.
3. In general it will not be feasible to reuse jacket structures because of the difficulty in picking them up and transporting them to a new site for reinstallation. However, new technology may make it possible to do this in specific cases if new developments occur offshore California where the transport distance is not great and the water depth is similar.
4. New technology may make it feasible in the future to remove an entire topsides (processing equipment and supporting structure) and transport it in a single piece to a new site. This has recently been demonstrated with a 1200 ton offshore facility topsides in the Gulf of Mexico. Most of the topsides offshore California are considerably larger than that, but the new technology is promising.

## ENVIRONMENTAL SESSION: SUMMARY AND RECOMMENDATIONS

### SIMON POULTER and BILL DOUROS Session Co-Chairs

**Russ Schmitt:** Now it is time for the Douros and Simon show. They will be talking about the environmental workgroup session and report.

**Simon Poulter:** Thank you. I would also like to just briefly thank everybody who participated in planning and participated in our session. There were a number of meetings that were held over almost a year period of time to pull together the panel as well as the user groups that expressed their insight on various technical issues. We have sat down and spent a lot of time and I really want to appreciate everyone that has participated in that process. I also found the experience that Bill and I had yesterday I think has been repeated throughout the conference. We were actually a little disappointed after our session that the questions seemed to jump to the afternoon session. A great deal of the comments were made in regard to that. We felt that we were not getting a lot of feedback. Bill and I stepped off to the side after the last session and were hoping to spend fifteen minutes summarizing the result of our session. We promptly got into a huge argument with each other about what the conclusions were really going to be. We realized that the session had touched on many of the issues that had been raised in previous environmental documents and reviews of works. I don't want to say that we got into a knock down drag out, but I think it was a very valuable experience. I know that I have had a number of conversations with other individuals during this conference about particulars on other individual's projects. I think that is the value of the session. It is that we have been able to touch on those issues.

The second kind of observation that has been made is that the communication has been very positive. We have seen in most of the sessions groups that don't talk to each other sit side by side after making some comments about each other. I think that is a very valuable experience. We really saw that as a positive exchange of open ideas and will

hopefully continue that dialogue after the session.

Going into it briefly, the overview of the discussions made by our speakers we summarized here in bullet format. I will touch briefly on some of the comments because some of you cannot see the overhead from the back. Peter Cantle discussed air quality. I think his major message was that air quality is a major changing issue for any decommissioning project, and that we are continuing to see a lot of dialogue going on among the state and federal agencies regarding what will be required for decommissioning projects and that the fact that the seasonal issues of ozone are going to have an impact on some of the larger projects that we see in the future. He concluded that fewer activities proposing to leave parts of the jacket in place will result in less emissions, but that was kind of a given in many of our discussions. I think less physical activity, less potential impacts. That does not address the potential disposition issues obviously and that was touched on. Commercial and recreational fishing preclusion is obviously the biggest issue in that regard and recognizing there are going to be seasonal constraints once operations occur, particularly if there are larger derrick barges that were going to go into that. Fisheries research indicates that there are effective methods to reduce potential impacts to fisheries resources during abandonment. We do recognize that there is some impact from especially explosive uses, but those uses have been identified as being less significant when you consider the overall commercial fisheries catches in both the Gulf and I think can be extrapolated out to the California coast.

Peter Howorth in discussing marine mammals identified that there are very effective mitigation measures in place that have been implemented on a number of projects that have resulted in effective reduction of impacts to marine mammals.

**Bill Douros:** As Simon mentioned, while it seemed that we were not in agreement on some aspects of all of the presentations when we met last night to talk about what we were going to summarize, that is the first disagreement we have had in our eight month relationship. What is often an air quality mitigation measure to prevent ozone is to schedule the project during seasons when you are less likely to, through the natural processes of the sun and temperature generate ozone by the emissions that occur. That means you do as much of the work you can in the winter time. The winter time is when gray whales migrate and so you can obviously see that there is immediately a conflict with two very important issues to abandonment. This is something that has come up on the construction end of the projects, and this is something that is going to come up on the major abandonment projects too. We are talking about a lot of emissions, a lot of facilities in an area that is very important to marine mammal migration routes, especially in the winter time. This is an issue that needs to be resolved as time goes on.

**Simon Poulter:** Ray deWit presented an overview of marine benthic organisms. In reference to Ray's talk, our conclusion was there was a short term loss of habitat when you remove a structure. Then the question was raised, is that significant? Is that going to result in a long-term loss of habitat for these organisms? I think there were still some questions in our minds at the end of his presentation that we could not resolve and I would be interested to hear how others interpreted some of the statements he made. The issue was that you will initially lose that habitat, the hard substrate that many individuals have indicated is a limited resource in the Santa Barbara Channel in particular, but that natural recovery will occur. Well how fast will it occur? Is that going to be a natural succession? Will it be the same species? All of those issues still are out there. We have seen in some of the flow line abandonments in particular that issues have been raised and are still being debated among the agencies.

Water quality, Pete Raimondi gave a very interesting presentation and I guess I was a little lulled by the second slide. This slide said less than significant and I wrote it off. That was one of our bigger discussions because the

rest of his presentation presented an overview of the potential issues that we need to consider. That we, well, don't see anything under certain parameters, but if we look at other parameters that we are maybe not looking at, such as biological communities there may be an impact, but we do not know. So....The warning went up. I admit I missed it.

Frank DeMarco got into clean up standards of onshore facilities. A new issue that has been raised is that an applicant does have the ability to identify a lead agency. In my brief presentation I showed you in a slide that there are potentially a lot of lead agencies issues regarding a project that has OCS state waters and onshore components that can result in significant problems. Future land use issues are going to drive risk-based assessment on whether we are going to remediate a site immediately and result in some excessive excavating of a site or bioremediation project. That may result in secondary impacts for future use.

Our last speaker I think brought up some very key issues tied back to that cleanup issue. Kim Schizas talked about future uses of the sites. In Santa Barbara County and south county you have two consolidated sites that have the potential of having multiple operators. We are seeing proposals for potentially shutting down one of those facilities. That may result in a need to look at whether it is appropriate to "moth ball" that facility and wait for the next operator to come in , or remove portions of it. Those issues do need to look at future land uses of do we restore a site to a natural condition, revegetate it? We also have to recognize that a lot of these facilities are located in areas which are very attractive for future development. The Arco Dos Pueblos golf course is such a situation where we are taking an oil field and moving it directly into a recreational facility instead of maybe back to a natural condition. Now I will turn it over to Bill to go into our recommendations.

**Bill Douros:** One thing I would like to point out before we move on is from the comments made by the ocean users groups. The folks who gave five minute presentations at the end. We would like to summarize that there are obviously competing uses and perspectives on whether or not there are environmental

impacts and the magnitude of the environmental impacts from the act of doing decommissioning. There was an interesting point brought up on air quality. On a recent project they finally had resolved through litigation the mitigation that was necessary. Rules changed after that through new legislation and it added a perspective for me that I had not quite seized prior to this presentation. The one common theme from all of them was communicate! I think all of the speakers mentioned that as something that is absolutely essential. One other point too was that, as I mentioned in the opening remarks on the first day, we try to present to you issue areas for environmental impacts that will result when you do a decommissioning project. That does not mean though that there are not other environmental impacts that typically result. Most of the environmental impact reports when these projects were built included perhaps no more than a page in the 300 to 400 pages of the environmental analysis that said the impacts for abandonments and decommissioning will be roughly the same as the impacts for construction. One of the issue areas that comes up often during construction is the change in the visual and aesthetic characteristics of typically a rural coastline, impacts to recreation and enjoyment of recreation, tourism opportunities, because of that perceived industrialization. While that will occur during abandonment and decommissioning, part of our view as to why we did not want to present that necessarily, it is often too difficult to quantify. An oil rig to some looks like many positive things and to others looks like many negative things. Decommissioning projects may look bad to those that like platforms and good to those who do not like platforms and it is very difficult to try and quantify. That is why we stayed away from it in this presentation/workshop. We wanted to make sure that people did not lose sight of the fact that those are still issues.

Okay, the recommendations then. There are at least five things that jumped out at us as either research tasks or think pieces. The first is regarding air quality. What are the offsets and other mitigation measures that might be viable as mitigation to air emission particularly if the legislation has changed that makes a certain class unacceptable.

Secondly, and this is what Simon touched on, what is the effectiveness and rate of natural recovery for marine benthic impacts? You certainly lose habitat. You have an impact to those organisms that grow on a platform when you take it out, but what does that matter? Is it 1/10th of 1% or 10% of an available habitat in an area? Also is it going to recover naturally? Anthropogenic restoration in 600 feet of water is, I am sure, more difficult than even getting the structure out in the first place. So a lot of the mitigation, the recovery of those impacts, is probably going to have to be natural. We need to know if that is really something that is effective and how fast can that come about.

This concept in water quality impacts that Pete Raimondi talked about, informed intuition. I think most people that study these sorts of things might agree, geez...ya know... a barrel of oil spilled during a clean up is kind of hard to consider that a significant impact to marine water quality. An interesting aspect of Pete Raimondi's talk was that for another project where they thought they were measuring the right physical characteristics they concluded that no significant impact would have occurred at ten meters when really there might have been an effect 1000 meters away. So there may be some additional assessment whether it is research or thinking that needs to be done there.

The fourth one did not necessarily come up in our presentation but became obvious when the fish folks talked in the afternoon. What happens to the fish when you take the platform away? Do they go back and populate existing reefs? Do they all get caught by fisherman? Do they all get eaten by sea lions? What happens to them?

Lastly the planning for the future land use for onshore facilities ought to start right away. That is based on what Kim Schizas had to talk about. Jim Lima, I think, emphasized that a bit in the afternoon, too.

The second recommendation is that existing mitigation measures that we know work ought to be required. There are a number of those for marine mammal impacts for instance. Yet we should continue to work to



improve those that we know work and those that we know do not work as well as we like too. There is always room for continuous improvement.

Lastly we recommend that when environmental impact reports for new development are prepared, should that ever come about in the future. Those environmental impact reports need to do a better job of evaluating the impacts of abandonment and decommissioning. Another question is how long are these facilities going to be out there? No one envisioned the Point Arguello project would be taken out within ten to eleven years, but that may be an important aspect of the decision-making in the future.

I think what we are also getting at here, is that when you write an EIR that is 400 pages long about the impacts of constructing and operating a project a couple of paragraphs that just sort of summarize that the impacts will be roughly the same probably is not doing justice to it, particularly when there are some technical limitations to even how you take some of these facilities out. We are seeing that now and that is twenty-twenty hindsight. Anything else to add?

**Simon Poulter:** I just want to point out that I am sorry we drifted into the disposition, but you all did so we had too. I think the question of what happens to the fish and the impacts associated with the construction of the facility does have to recognize that if we are talking about a structure becoming a reef now, not only do the engineers need to consider that structure in their design, but also we have to recognize that it may have a potential long-term beneficial impact if it is properly designed and sited for that purpose. That concludes for us. Thank you.

## SESSION REPORT

### Major Observations

1. Comments and questions from audience focused on disposition issues and it is hard to make conclusions with so little feedback. Observations and conclusions based on the speakers are provided

below.

2. Open communications were emphasized by the speakers, user groups and public.

### Speakers

#### Air Quality - Peter Cantle

- Air Regulations are continuing to change. Such changes will affect future projects.
- Fewer physical activities means fewer emissions and therefore less impacts.
- How to mitigate air emissions impacts is unclear.
- Seasonally scheduling (avoid Ozone period) may push project schedules when you factor in biological seasons (i.e., gray whale migration).

#### Commercial and Recreational Fisheries - Craig Fusaro

- Removal activities result in preclusion for both commercial and recreational fishing operations.
- Less removal activity means less impact.

#### Fisheries Research - Villere Reggio

- Explosives use does result in fish kills. In the Gulf of Mexico this represents less than 1% of the total commercial fish catch annually.

#### Marine Mammals - Peter Howorth

- Existing mitigation measures have been tested during actual projects and have been shown to effectively minimize impacts to marine mammals.

#### Marine Benthic Organism - Ray de Wit

- Removal of structures will result in short-term loss of habitat and associated organisms.
- Less removal will result in less impacts.
- Upper 200 feet are most productive.
- Natural recovery timeframe is not clear.

#### Water Quality - Peter Raimondi

- Impacts are less than significant if they follow established procedures.
- Results are based on literature and observations but not on field verification.
- Caution in his message.

Cleanup Standards - Frank DeMarco

- Applicant can pick lead agency for cleanup levels (not CEQA).
- Risk based clean up levels - tied to future land uses.
- No standard clean up levels have been established (case by case).
- Secondary impacts must be considered for cleanup activities.

Future Land Use - Kim Schizas

- Questions must be asked
  - ⇒ Can the site still be used by other operators (Consolidated sites need more review)?
  - ⇒ Is restoration/recontouring environmentally preferred?
  - ⇒ If not, what is the best reuse for the site?
- We must start planning now.

RECOMMENDATIONS

1. New research or "Think pieces" may be needed:
  - a. What are offsets or other mitigation for air emissions?
  - b. What is the effectiveness and rate of natural recovery for marine benthic impacts?
  - c. Is the "Informed Intuition" that decommissioning causes no significant marine water quality impacts accurate?
  - d. What is the fate of fish that lived at the platform once it is removed?
  - e. Planning for future land use (onshore) needs to begin immediately.
2. Existing mitigation measures that we know work must be required; continuous improvement for all mitigation must be sought.
3. Environmental Impact Reports for new development must do a better job of evaluating impacts of decommissioning, including assessing what is the "life of the project."

## DISPOSITION SESSION: SUMMARY AND RECOMMENDATIONS

### DR. MARK CARR and DR. JOHN STEPHENS Session Co-Chairs

**Russ Schmitt:** The last workgroup session was on disposition and Mark Carr will give the summary report from that session.

**Mark Carr:** Thanks Russ. There were many issues raised during the disposition session thanks to the excellent and greatly appreciated participation by a wide breadth of both stakeholders and agencies. We have tried to summarize these issues in the form of recommendations listed here on the overhead. If we have omitted any issues of particular concern please bring them up during the public response period. There were so many issues raised it was very likely we may have omitted some issues that some stakeholders are particularly concerned about.

The first one of these which in the past continued to rear its ugly head is the liability issue. Given that issue our first recommendation is to please try and resolve this liability issue. Critical to that is understanding or determining who is going to be responsible for these structures once they are decommissioned at sea. This is particularly complex off the coast of California because decommissioning is highly likely in either federal or state waters. Depending on where that decommissioning operation takes place may influence who will be liable for those structures. Important to the liability issue is identifying the risks that one might be liable for, and so a risk assessment would be very useful. That risk assessment needs to take into consideration all the various decommissioning options that have been identified during the workshop.

The second issue is to determine or at least clarify the lead agency in the disposition process at both the federal and state level. And to recommend further that this lead agency take a pro-active role in establishing a framework for this disposition process, rather than waiting for a request for a permit

before a framework is established. Particularly important is to define the objective of the decommissioned structure. For example whether it is going to be a fishing reef, a harvest refuge, a mariculture facility for fisheries enhancement in general. Clarification of these objectives will probably involve further development of the artificial reef programs both at the state and federal levels. That will determine the role of these structures in a state or federal wide artificial reef program. All of this is to hopefully avoid this idea of materials of opportunity wagging the tail at the disposition process. There is concern expressed that you do not decommission a structure simply because it is there, but so that it fulfills a particular predetermined objective such as fisheries enhancement. Another issue that kept coming up and was addressed by some individuals, but I think there is still some question. Is there a window or is there an option for deep water disposal of these structures?

The forth issue, and from a scientific and fisheries prospective....one future and critical research objective is to collect more information on the comparative performance of organisms of the platforms and on the natural reefs. This is particularly important to the fisheries enhancement objective which was frequently raised. Milton and I presented scientific information, but I hope we did not give anyone the impression that we know all the scientific answers to decommissioning options. Particularly important is understanding how well animals do on these artificial structures relative to how they do elsewhere in natural habitat.

The fifth issue is to investigate the ecological role of these shell mounds. Shell mounds continue to be a contentious issue in this process. We need to understand the dynamics and persistence of the habitat itself, the physical structure of these

mounds. How that will change in an absence of a continued fall of litter from the structure above? And also again to assess the performance of the biota on these mounds with a comparative regional approach. How well do these things do in these habitats relative to other habitats?

If these structures are to be decommissioned at sea certainly it was recommended and the scientific evidence supports the concern that they be done by a case by case process. The regional variability in environmental conditions and biotic communities suggests that each of these structures may play a very different role depending on the organisms associated with them and the surrounding environment. That suggests we cannot generalize any particular strategy for all the structures off the California coast, but rather we need to take those regional details into consideration.

It was also recommended, I think this was an excellent recommendation by the president of Get Oil Out, that we consider an experimental approach to this disposition process. As a scientist I think I have a different definition of "experimental" than most people in this room. I think an accurate way to consider this is as an adaptive management strategy. In other words let's not make the mistake that has been made in the past with other artificial reef programs and just put these things out. Let's learn something as we do it. As we put these things out let's do so in a manipulative manner. So we learn about the role of these structures as we do it. That needs to be designed well ahead of the artificial reef process. This would require a comparative regional approach and evaluation. I cannot stress the role of evaluation anymore! You simply do not conduct some kind of management strategy without assessing or evaluating the success or consequence of that strategy. If we are going to get involved in decommissioning let's make sure we incorporate a process for evaluating the effects of that process.

In the process of decommissioning a series of steps could be considered. First consider the likelihood of that structure meeting the predetermined objective where it currently stands. Will it meet the predetermined

objective and if not can that objective be met with some kind of augmentation of that habitat? Dave Parker spent quite a bit of time explaining what kind of augmentation mechanisms might be involved. If it cannot in place or with augmentation meet a given predetermined objective, can it be met elsewhere? If so then let's think about what we need to know in order to place these artificial reefs in a different environment or at a different location. Several stakeholder heads suggested that if these things are going to be left in place please leave the entire structure including some topsides in place. I think that needs to be considered more, and if not can they be buoyed to prevent commercial trawlers from hanging up on these things.

The seventh issue or recommendation is to identify those stakeholders that are impaired by each one of these options and for each case, and to consider collectively with the stakeholders, with the public, and among the agencies how we can compensate for those negative impacts.

The eighth issue is to decommission onshore facilities simultaneously. If it cannot be simultaneously at least do it in a timely manner so we do not have this lag response of decommissioning or restoring onshore facilities as we have seen in the past.

The final recommendation is greater cooperation between industry and research. I think all of us were impressed by Bill Griffin's presentation for the global importance of the activities that occur on our coast. We often heard frequently the importance of science-based decisions. If the global industry wants to further explore the concept of disposition at sea they need to impress upon the local industry the importance of this cooperation between researchers and industry in order to enhance the likelihood of science-based decisions. Having said that I should mention though in my own experience particularly with the companies we have worked with, Pacific Offshore Operators, Torch, and Unocal we have received outstanding cooperation. However I think that this needs to be impressed upon the local oil community as well. Thank you.

**DISPOSITION SESSION  
ISSUES & RECOMMENDATIONS**

- **Resolve liability issue**
  - who is responsible for structures decommissioned at sea?
  - State vs. Federal waters.
  - risk assessment (by option).
- **Determine lead agency at both Federal and State level**
- **Define objective of a decommissioned structure(s)**
  - e.g., fishing reef, harvest refuge, mariculture facility.
  - artificial reef program development at state and federal level.
  - avoid “materials of opportunity” wagging tail.
  - is deepwater disposal a viable option?
- **Collect more information on comparative performance of organisms on platforms and natural reefs (putative fisheries enhancement objective)**
- **Investigate ecological role of shell mounds**
  - dynamics and persistence of habitat characteristics.
  - assess performance of biota with comparative regional approach.
- **If decommissioned at sea...**
  - Case-by-case.
  - “Experimental” approach (Adaptive Management), i.e., LEARN as you DO.
  - comparative regional approach and evaluation.
  - consider likelihood of meeting objective in place.
  - can objective be met with augmentation?
  - is objective best met elsewhere?
  - Can entire structure (including some topside) remain?
  - If not, buoy?
- **Identify those stakeholders impaired by each case**
  - Collectively consider how to compensate for negative impacts.
- **Decommission onshore facilities simultaneously or timely**
- **Greater cooperation between industry and research**
  - Industry needs to “think globally, act locally.”



---

---

## **AGENCY PANEL DISCUSSION**

---





## AGENCY PANEL DISCUSSION TRANSCRIPT

This text was transcribed from audio tapes of the workshop. There are a few gaps in the transcript corresponding to times when the tapes ran out and new ones were inserted.

**Russ Schmitt:** Good Morning. Today we are going to begin with a summary of the session co-chairs' discussion yesterday. We will then turn to a panel discussion with representatives from federal, state, and local agencies. To begin the discussion agency representatives will start with a five minute reaction of what they have heard, both from the presentation of session chairs, as well as the rest of the meeting. This in turn will hopefully frame a discussion from the audience.

### Agency Representatives:

#### Federal Agency Representatives

- **Richard Schubel**, Chief, Regulatory Functions Branch, U.S. Army Corps of Engineers, Los Angeles District
- **Dr. Lisle Reed**, Regional Director, Minerals Management Service, Pacific OCS Region
- **Maureen Walker**, Deputy Director, Office of Ocean Affairs, U.S. Department of State

#### State Agency Representatives

- **Susan Hansch**, Deputy Director, Energy & Ocean Resource Unit, California Coastal Commission
- **Bob Hight**, Executive Officer, California State Lands Commission
- **Brian Baird**, Ocean Program Manager, California Resources Agency
- **Peter Bontadelli**, Administrator, Oil Spill Prevention and Response Office, California Dept. of Fish and Game

#### Local Agency Representatives

- **John Patton**, Director, Santa Barbara County, Dept. of Planning and Development
- **Nancy Settle**, Manager, Regional Programs Section, Ventura County, Planning Division, Resources Management Agency

**Russ Schmitt:** At this point I would like to ask each of the agencies to give a short reaction to the material they have heard, the recommendations, and the summary of the workgroup sessions. We will start with the federal agency representatives and in

particular Dr. Lisle Reed, the Regional Director of the Minerals Management Service of the Pacific OCS Region.

**Lisle Reed:** Thanks Russ. I would first of all like to say thanks to all the presenters. I was really impressed with the amount of information and the issues. I am always astounded by these workshops because the longer I sit there, and the more I hear, the more I realize how much I do not know. I feel that even by today we have only had chapter one. We have a lot more work to do, a lot more things to find out, and a lot more evaluation work ahead of us. I appreciate also that the speakers who have presented issues over the past couple of days have been very brief. We had to get a lot of information done and we had to get it done in a hurry. People therefore had to bottom line things and summarize. I appreciate the fact that issues like protecting marine mammals, air quality, water quality, those are doable things. We can protect those, but I do not want to pass over the fact. I want to acknowledge fully in front of everyone that there are a lot of details here that will have to be worked through. This will be very tedious and will take a lot of time, and involve most of us at this table and our staffs etc. If we do do something exotic like some type of attempt at a reef or something like that. The ocean users, I am talking mostly about commercial fisherman. They have the very right to expect at a minimum that we would take into consideration their concern for safety and their equipment, and insure fully that that is taken care of.

The public I think has the right to expect in the base case that these facilities out there in the water upon decommissioning could be removed and the site returned to whatever uses are appropriate. I think that in fact is the law and that in fact in the base case is what we would expect to achieve for the public. I think the public also has the right to expect that if there are some other things that could be done, if there are other good ideas, and it may result in significant or worthwhile enhancement of the resource or enhancement of the values

of the surrounding community and state, that we should take a look at it. We should review it. We should along with our state, federal, county, and government partners, along with the public, make decisions that are appropriate for the situation that arises. So we will do that! I will speak for Minerals Management Service, when we entered into this venture with State Lands to take a look at the decommissioning policy and procedures. It was our hope to jointly work up a set of protocols and standards and procedures that would be amenable to both the federal and state agency, and would give the people of the communities and the state the confidence that what goes on out in federal waters will be at least of the quality that goes on in state waters. It looks like that given the type of platforms we have out in the federal water that the substantial depth we are talking about here, again California is going to be on the cutting edge. We are going to be the trend setters and I guess we are dealing with some pretty unique stuff. Nevertheless we will continue to work hand in hand with State Lands as we do on many other projects. We will work towards a set of criteria and common goals that will be mutually shared. We will diligently work with the Coastal Commission, with Cal Fish and Game, which I think has a major say in this whole issue, and certainly the Counties of Ventura and Santa Barbara, and the ultimate decommissioning and disposal of these platforms. We will try to define a program that could involve some more research and evaluations. We will develop a process that will bring the public into it and we will march down that road together. That will eventually allow us to reach a decision that is to the best interest of the general public. That is where I am at this point, and I have no idea what the ultimate answer will be.

**Russ Schmitt:** Thank you Lisle. Richard Schubel will give us his reactions now. Richard represents an agency that will be another major player in this process, the Army Corps of Engineers.

**Richard Schubel:** We are sort of a different player. I apologize, I wanted to attend, but could not attend, we are facing the so called crisis of El Niño in the LA area. So that is where our energies have been directed. Basically our role, being a permitting agency, we have to comply with the Clean Waters Act Section 404 and the Rivers and Harbors Act

Section 10. What we attempt to do is take an impartial view. What drives our final decision or the direction of the permitting process is the project description. If you have shell mounds involved then it goes under Section 10. The true players are really the EPA. The final decision is really consensus building. We need to look at an array of alternatives. Generally we have to select the least damaging alternative. Now our role as far as NEPA. How we come into this document, is to determine if an EIS is required. We generally go through an Environmental Assessment. That is our first document and that will determine if an EIS is needed. From the project description we will also determine if we will be the lead agency, the co-lead, or a cooperating agency. If it is on other's land that we are not in charge of, then we would do our own Environmental Assessment or possibly adapt the document that is developed by the other agency. What I really want to emphasize is that the primary objective is to reach a conclusion for the public good. So that we do take a balanced view and that is what the permit will state. It will address all of the issues that have been addressed by you here.

**Russ Schmitt:** Thank you Richard. I am very pleased to introduce Maureen Walker from the U.S. Department of State, who will give her global perspective.

**Maureen Walker:** Thank you. I very much appreciate the opportunity to be here and to provide the global perspective. The first paper that I will comment on will be the environment section. I noticed the major observation or comment was on open communications. This is really vital and allows the United States to take a position of leadership overseas, because we draw that from you and from the discussions that you have. We have more transparency, more openness, and more public discussion in this country than any other place in the world. This gives us tremendous advantage in negotiations because we understand the perspective. Everything from your anglers, to your divers, to your environmental groups, all the way up till the industry. I want to really compliment all the organizers, participants, and all the questioners, because these are the questions they are asking at the international level and we are able, with your help, to provide those answers.

One thing that I would like to say in these opening remarks that as important as you plan how you are going to handle the decommissioning process out here in California, to be cognizant of the international instruments that are guiding U.S. decision making at the international level. The first, of course, is the 1982 United Nations convention on the Law of the Sea. It is very important to understand that as well as the convention on the Dumping of Wastes and Other Matters, which has recently been amended by a protocol, which the U.S. Department of State is presently preparing to send to the Senate for ratification. Specifically when we look at the environment recommendations regarding fish and marine mammals. I am reminded of an important article of the convention which you should become very familiar with and that is Article 60.3. There it says that removal should have due regard to fishing, the protection of the marine environment, and the rights and duties of other states. I think by taking a detailed look at the issues we actually are abiding by a very important part of the convention. Also you should become familiar with the international guidelines on removal, that were adopted by the International Maritime Organization in the late 1980s. You might wonder why would we have to pay attention to international issues, this is California. The reason is because of the fact your dealing in waters that are used for navigation by all countries. There is a concern by all those countries that there be unobstructed passage wherever possible.

Back to the issue of fish and marine mammals and some of the other questions that were raised and comments. I wanted to draw particular attention to those guidelines because they note that the determination of any potential effect on the marine environment should be based upon scientific evidence taking into account the effect on water quality, geological and hydrographic characteristics, the presence of endangered or threatened species, existing habitat types, local fishery resources, and the potential for pollution or contamination of the site by residual products from or deterioration of offshore installations or structures. The guidelines that guide governments in their decisions for removal say that the means of removal or partial removal should not cause a significant adverse effect on living resources of the marine environment,

especially threatened and endangered species. I thought that you should realize that.

With regard to the issue of marine benthic organisms and the fact that the upper 200 feet is most productive. This is very important when you decide on whether or not you want to have an artificial reef. There are specific provisions in the guidelines for when and how offshore installation should be removed. There is one particular point that I wanted to make reference to. That is if it is decided that one will be partially removed, that an unobstructed water column sufficient to insure safety of navigation, but not less than 55 meters, should be provided above any partially removed installation or structure which does not project above the surface of the sea. I had not heard that mentioned and I wanted to make a comment on that. I think I have completed my five minutes, but I am available for discussions on the disposition question which I understand you have a lot of concerns about as well as some of the issues raised on the technical session. I think I can get to those when we have the question and answer period. Thank you.

**Russ Schmitt:** We will now hear from our state agency representatives. Starting with Brian Baird who is the Ocean Program Manager from the California Resources Agency.

**Brian Baird:** Thank you. I am here today representing the Secretary for Resources who sits on the Governor's Cabinet. The Resources Agency has overview responsibility for sixteen to seventeen agencies that come under the purview of the Secretary. The authority under which I operate is the California Ocean Resources Management Act, which was authored by then assemblyman, now congressman Sam Farr. The bill that passed required us to do a comprehensive analysis of the needs of ocean management for the State of California. In March we released the document "California's Ocean Resources and Agenda for the Future." This looked at stewardship issues, economic sustainability issues, research education and technology development issues, and issues of jurisdiction. I am happy to say that there are a lot of people in this room here today who have participated in the development of that document in assisting us. We had a section in

that document dealing with decommissioning and requalification of existing structures. I think the fundamental finding was at that time and I think it was reaffirmed here today was currently we have no comprehensive evaluations of these alternatives. We have a lot to learn. We have a lot to do, and the work I think has just begun.

In terms of recommendations. In essence we state we need a procedure for evaluating the various subjects and various aspects that get into the issue of looking at artificial reefs. What are we really talking about here? I think what we are talking about is an enhancement, is a value added kind of equation. I think that is something we all need to keep in mind when discussing the possibility of doing artificial reefs. Looking at the alternatives of total removal, leaving all or some portions in place, or other possibilities. Regulatory issues and all of those sorts of things come into this equation, and some of those things will be discussed by the individual state agencies that follow me. I think again on this valued added issue, I think you should be assured that the kind of analysis that we are looking at and doing is going to be aimed at. Are we simply looking at an opportunity here or are we looking at something that is properly designed and is indeed a value added contribution to the marine environment. That is a key point I would like to make.

Secondly, I was vice-chair of California and the World Ocean. A conference that was held in San Diego in March. We also had a session on this subject of decommissioning there. Just a few comments, it was interesting. One of the things we talked about on the ocean agenda is that we have a great deal of fragmentation. We have many, many agencies who get involved in these things. I believe it was Chevron who made the statement that they have had to deal with twenty eight agencies investigating this issue. Which underscores the need for us to come up with a process to get everybody in the same room and begin to figure out what our objectives are and where we need to go. Not just the agencies, but obviously all the many, many stakeholders.

We have a very different experience here. Yes, we would be on the cutting edge if we are looking at these structures in deep waters. The Department of Fish and Game has a reef

program that has primarily been in shallow waters. So we are breaking new ground here. Also there is substantial difference between the Gulf Coast and the West Coast, and those differences are physical, they are cultural, and they are cost issues. They are all of those things.

When we do talk about science, one thing I have learned in my four to five year journey of looking at this comprehensive issue, is that we have to use science. We have to base this as much as possible on science. We also cannot have a naive faith in science solving all these problems within this time frame and do the best job possible. You have to do the best job you can to define your objectives and do the best job you can to determine whether this thing makes some sense or whether it does not make any sense. You will never have the scientific answers to give you the level of specificity that you desire. I think the State is continuing to do some ground work on this issue by looking at the liability issues, and looking at the biological issues, but clearly this cannot happen in a vacuum and we all need to sit down in a more focused form after this and begin to look at these issues. The Resources Agency in our role is happy to help facilitate this in any way we can. If there are issues or problems with bringing the state agencies together, we will help fulfill that role. On the other hand if we do not need to fulfill that role we will monitor what is going on. The last thing we want to do is be yet another participant in the room if we do not need to be. Clearly the key state agencies I think are the State Lands Commission, the Department of Fish and Game, and the Coastal Commission who are about to give their presentations. So I will let them proceed. Thank you.

**Russ Schmitt:** Thanks Brian. Bob Hight the executive officer of California State Lands Commission will now give his remarks. I also want to point out that Bob was here for the technical session and we appreciate that.

**Bob Hight:** I want to start by saying I am really very encouraged by the thoughtful dialogue that has occurred over the last two and a half days. I think the only way that we are going to be able to proceed is if we work together as a team. I think ultimately any resolution that comes out of that process is one that everybody can embrace. I really

applaud Lisle's efforts and cooperation in working with us and working with the other agencies to create a structure that is compatible for everybody to deal with.

Touching on a couple of subjects. Yesterday it appeared that there were two conflicts, one emotion and one science. People have some strong emotional feelings about are reefs good or are reefs bad? We need to bring science into the process to figure out really what the effect of the reef is on the environment and then make logical decisions from that. Any EIR or EIS that is done on this project or future projects will out of necessity, I think, require a myriad of state and local agencies. I think if they work together as a team in a joint EIR or EIS process it enables the public the opportunity to participate and everyone feels that they have had their fair share in the say. The Lands Commission's ultimate responsibility is to see that the public's trust is best preserved, and that can take into a lot of considerations, and I thank you very much for all of your participation. I look forward to answering any questions. Thank you.

**Russ Schmitt:** Next step is Susan Hansch who is Deputy Director of the California Coastal Commission.

**Susan Hansch:** Thank you. I am relieved that after two and half days the opening comments I made, I think, still stand. I think bringing all these people together reiterates the need to still communicate and the value of that. I am going to hit a few of those themes in my comments now.

One of those issues that I know we have not discussed in detail, is one of those issues that I brought up, is it really time to get rid of these facilities? Have we looked at all the opportunities and options? For the Coastal Commission that hits on some very important coastal policies, that is the concentration of development, minimizing impact while tapping the petroleum resources. The people of California and the resources of the state have already incurred impacts, and it is time to take those out? One of the important reasons to mention that issue now, is now is the time to look at the options. There are a couple of other themes of major issues that we need to get into immediately rather than waiting till we see an application in front of us or we start

looking at the environmental impact report. We need to look at the big picture and regional options and the details. I am concerned that we might break things up so we are looking at all the details and then not putting the pieces back together and looking at the big picture. You cannot piecemeal it into such small pieces that then you do not see the overall cumulative regional impact. You cannot look at the planning options, and for me it has been very enlightening looking at the international impact we could have. I think that is very, very important. So I think that speaks to look at the details, but put it all back together as well.

That also strikes the theme of scientific work and the independent analysis, as well as the ability to look at some of these questions without a preconceived notion of what the answer is going to be. That also hits the theme of we need to do it soon. So that we have enough time to analyze some of these questions in detail. Science is not quick and the communication that we need in order to resolve some of these issues takes time. That is why it is so important and I am very pleased that Minerals Management Service and the State Lands Commission pushed to do this now. All the agencies are in this together and the public, the environmental groups, the fisherman, all the stakeholders. The Coastal Commission though is likely to be the last regulatory stop. That is just the way the structure is. That does not mean our decision is any more important. We are all going to be in this together, but when it comes to the place that we have to prepare recommendation for our commission and have the last round of public hearings, we have a lot of the decisions already made. In order to do that we have to get into the issues now.

That gets to my fairly specific recommendation and that is before we leave here today is to have some sort of an action plan, or working groups. What are the next steps going to be? Who wants to be involved? That may mean taking the key agencies that are here and coming up with a working plan, notify people that are on the mailing list, let people know what we are going to be doing, and identify what those issues are. Some of those issues we can probably deal with later, that are easier to resolve. The difficult ones like the issue of the artificial reef, some of the liability issues, some of the mitigation issues. We have to

deal with them soon! I would like to make sure when we leave here we do have an action to take the next steps. That is all I have to say. If there are any questions at the end I will be happy to discuss things in detail with people.

**Russ Schmitt:** Peter Bontadelli is here to give the perspective of the California Department of Fish and Game.

**Peter Bontadelli:** Thank you very much for allowing me to come down and join you today. I would like to first extend the commitment of the Director who was scheduled to be here today, Ms. Jacqueline Schafer. A death in the family has prevented Jacky from attending this week. She did ask me to specifically convey one very strong message and that is that the Department is strongly committed and she has a direct personal interest in working with all the impacted stakeholders, as well as all of the other state and federal agencies in helping to address the issues that arise with the question of decommissioning. As Brian alluded to the Department of Fish and Game will be deeply involved in several potential aspects of decommissioning. I will stress the word potential since the final decisions on what will be done on part of the Decommissioning or not done in terms of leaving the structure in place, will be made on a case by case basis, which is something that has been emphasized both by the working groups in terms of the reports I have listened to this morning and also by several of the agencies.

The potential and involvement of the Department is several fold. I was delighted to hear the State Department mention the IMO issues and the Law of the Sea and some of those questions. Since the "hat" I currently wear is the administrator of OSPR, Oil Spill Prevention and Response, is directly involved in the issue of maritime safety and traffic control. I will note for example that the Coast Guard is in the process of preparing to implement an IMO extension of the vessel traffic separation scheme to an eighteen mile nautical distance further to the north. That is predicated upon the existing Raycon operations at platform Harvest and therefore is an item that must be addressed as part of the decommissioning process. Likewise the depth questions, these would be the IMO regulations though their guidelines are something I know both we and the Minerals Management

Service along with the Coast Guard will be looking at very closely as we look at any potential for having a partial removal question of any of the deeper platforms. I am totally confident that those issues can and will be addressed as part of the process as long as we plan for them and keep them in mind as we go.

In a different role you heard Brian talk about the fact that the Department is and has been involved in the issue of artificial reefs. In the event that the artificial reef option is chosen as a solution or a potential disposition option for any or all of the specific platforms that will be coming out, there are several things you need to be aware of. Our Department's involvement dates back to the 1950s and I am sure Dave Parker who made a presentation yesterday covered many of the technical aspects involved with that process. Specifically in 1985 the Fish and Game Code was amended and Sections 4620 - 4625 created the basis for our involvement in platform disposition vis-à-vis artificial reefs in state waters. The role and function of the Department in the exclusive economic zone of the United States beyond three nautical miles is not nearly as clear as either statutorily at the state or federal level and is directly related to the liability implications that come with that less than clear statutory authority. Perhaps amendments to one or both would be required if a complete artificial reef program with the Department in the lead is to be involved in that area. Other options in the event we are not the specific lead would include some form of operating as a permittee or in accordance as an agent, the federal government vis-à-vis MOU option, working with the Minerals Management Service, both of which have alternative points of view and liability implications and are ones that the Department is more than willing to explore, working directly with the Minerals Management Service and the Coastal Commission, and others, as we work our way through that process.

The third and most clear role that the Department would absolutely have is going to be that of a commentator in our public trustee role for the fish and wildlife resources of the State on any EIR or EIS that may be prepared. In that regard we will provide the best biological and scientific information we have, both as a protective agency for the State's

endangered species, as well as the other critters that we manage. We recognize clearly that we have some differing points of view even amongst our own stakeholders in terms of both the commercial industries and that there will probably be some form of joint discussions on an ongoing basis, both internally and externally as we proceed along the lines of addressing the issues of decommissioning, specifically if we get into the areas of reefs.

The Director specifically requested that I mention the fact that the Department is in the process of looking at a reorganization which is likely to create a new marine region with a very specific emphasis on the whole issue of what happens in terms of the overall coastal resources consistent with the directions outlined by Brian in the report that was submitted earlier this year. Specifically within that reorganization the artificial reef program which is already authorized by statute for the State will come into existence as a distinctive program and the interactions of that potential vis-à-vis decommissioning will therefore have a specific home within that Department's reorganized structure. That will not be our only point of contact as that we still have our ongoing environmental review and other items that will interface, but that will give you a single starting point for those discussions within the Department.

A couple of other quick issues to mention. The concept that engineering and augmentation of any discussion of reefs is an absolute critical point from the Department's perspective based on the research and past experience that we have had vis-à-vis reefs. Also I was delighted to hear the reference to both research and monitoring or evaluation, both of which are items that are currently addressed within the Department's guidelines relative to artificial reef programs that may or may not come into being as a result of decommissioning. The Department is fully committed to working jointly and cooperatively with not only the state agencies and federal agencies, but also with the local governments as well as all of our stakeholders and the other stakeholders involved in the process as we work our way through.

Lastly I would like to add the Director's thanks to both the State Lands Commission, Minerals

Management Service, and UC Santa Barbara, as well as all the stakeholders for their strong participation in this conference, and I can assure you that the reports we get from Dave Parker and others who have attended the conference will be useful to the Director in the decision-making that she and the Department will be going through relative to the issues in the next few years. Thank you very much.

**Russ Schmitt:** Thanks very much Peter. Thanks for filling in so admirably. Now we are moving to the local perspective to hear from our local agency representatives, starting with Nancy Settle, Manager of Ventura County's Planning Division Resource Management Agency.

**Nancy Settle:** Thank you. Now we are finally down to the locals. The magnitude of this issue does definitely impact the locals, especially when we get to the onshore facilities and for Ventura County we do have onshore processing facilities and we are also the host to the Port of Hueneme, which is a major deep water port that could also be included in some staging facilities for offshore decommissioning of platforms. My involvement and observations that I have seen as the years have gone by at looking at these workshops, I've always come away with greater and greater understanding, but one of my first experiences with offshore oil issues came from staff back in 1988, saying we really have to get a handle locally here on the timing and the process and phasing for facilities, not only the installation at that point but I think it is also important with decommissioning. As far as my own observations with the three groups that met, I know that Dr. Byrd mentioned that the issue of facility reuse is something that we have not fully looked at and that Susan mentioned that as well. Also Mark Carr mentioned we need to really look at the framework for the whole process. And if anything else, I think with the local government response the more that we can continue to look at all aspects of this and look at the whole range of the offshore development. One thing in particular is the COOGR Effort, the California Offshore Oils Gas Resources study, which even though we are talking about decommissioning facilities, this study is looking at the onshore impacts to local infrastructure for different levels of continuing to get the oil resources offshore. I think this will have, and

we will need to come back and take a look at that, and see how that fits into the picture when we are talking about facility reuse, and also trying to pressure the local jurisdiction for responding to the impacts on our infrastructure. I know one thing our Ventura County staff and Lynn Cota mentioned, is what about the solid waste issue with respect to decommissioning facilities, bringing them ashore. In looking at some of the recycling potential, I know here in Ventura County we have limited landfill capacity and also if one of the options is to try to dispose of portions of the rigs in local landfills or elsewhere then of course you have the secondary impacts of the air quality issues. I am sure we are going to garner a whole other level of environmental review as we look at impacts and the results of those impacts. The more that we locally can work within this process and be kept informed all along the way, although frequently we do not get to jump in, this is a wonderful opportunity here, until it really reaches our onshore facilities and infrastructure.

The other point I wanted to make is the public process. It frequently ends up being the local agency that carries out the California Environmental Quality Act as well as the public involvement and input. We have heard a lot here from the different public representatives from various groups, but I know if we really get down to looking at a specific project that may impact Ventura County you are probably going to see a lot more different representatives from different public interest groups including the Taxpayers Association or the Sierra Club, and you may get even a variety of different responses as far as what their interests may be. That is pretty much all I have to offer except I do agree with Bill Griffin's first opening remarks, that we are looking at a whole process here and as much as possible for the local government involvement that we can try to encompass the whole package and not just pieces of it. I also agree with Susan's comments on follow up workshops and follow up groups to see what we can do to further work the rest of these issues out. Thank you.

**Russ Schmitt:** Thanks Nancy. Last but not least is Santa Barbara County. John Patton will be giving the reaction of Santa Barbara County.

**John Patton:** Thanks Russ. I tried to take the Bill Griffin pledge and listen. What I heard continues to reinforce to me the position of being a science skeptic. It is clear that there are some serious scientific questions that bear on management issues but it is equally clear to me that they are not going to resolve the most interesting management questions in biology and in future land use intrinsically wrapped up with value questions that are ultimately going to lead to government's issues, and the biggest mess it seems to me we have in this area is not our lack of understanding of the processes but the lack of any clear pattern for how to make decisions. This situation is laced with value choices. Which fish are we going to prefer? Which fishermen? Are we going to take long term or short term views? On the land use side of things, the thing that bedevils those of us that are concerned about the longshore infrastructure, is the question of after this project goes away, does its cousin come back within ten years when there is a different price forecast for this sort of oil/gas in the market that suddenly enables an offshore project to clear an investment hurdle and we recreate the damn infrastructure, the ultimate nightmare. So as Nancy mentioned, I think those of us who have onshore interests are very concerned with how the planning for decommissioning relates to the implications that should have come out of the COOGR study. Which is how much more development is there likely to be and over what period of time, and what sort of infrastructure that presently exists can it plausibly use? Without having a pretty good understanding of that it is going to be very difficult to make good decisions about the fate of the onshore support facilities and perhaps as importantly, the pipeline connections between offshore platforms, which could, under one scenario be abandon, and in another scenario become another platform for some other development or through extended reach drilling actually the base for developing new places. I don't see how we are going to make good decisions without having what were intended to be the results of the COOGR study at the time that we make them, and yet we have in the case of the Chevron facilities apparently fairly imminent set of decisions to make on decommissioning. Brian talked about the lack of specificity as being a characteristic of the science problem. My theme is that it is not just a lack of specificity but the value of



governance component has a good deal to do with how we conduct ourselves in this area.

Those of us who have been in lead agencies certainly have learned something out of this. As Bill Douros mentioned there was about a paragraph in a large document on abandonment. It was defensible at the time because of the assumption that we were talking about thirty years from now. Who knew what the technology would be on heavy lift? It turns out of course, that it was not thirty years but ten, and it was not three hundred to five hundred million barrels it was one hundred million barrels. It is possible that we should take this lesson rather seriously if we are presented in the future about the installation of the facilities that indeed they have to be removed in relatively shorter order than people thought. That might require some analysis, for example ten years ago even as now, the question of whether it would be physically possible to do what the documents assumed, namely complete removal at least as a default solution to the platforms was even possible to accomplish. This brings to mind some rather sad other examples in resource management having to do with nuclear fuel rods. It is foreseeable you are going to have a problem if you do not have any idea how to solve it. What business do you have putting the facility in in the first place? We thought we had thirty years which made it seem reasonable to take that approach, but we did not. The larger question might be if there really is only one hundred million barrels and ten years of life in the project was it worth putting it in? Was it maybe not only a bad business decision but a bad regulatory decision to allow a project like that to go forward? All the construction related impacts occur and were presumed to be amortized over a larger amount of production and a longer period of time. Arguably, it should become the duty of the priority agencies who approve exploiting the resource to come to a conclusion of whether the resource is really there, before the society is invited to absorb the impacts that go with exploiting it. I urge Minerals Management Service and State Lands Commission should take on as part of their role evaluation of how reasonable is it to suppose that the amounts of the resource the companies think they are going to extract when they go into a project are really there to extract under various price forecasts which might be used. I don't mean they should

second guess the business decisions of the companies. Those are reasonable rational decisions, but there is a regulatory interest there that I think ought to be part of future considerations.

Further on the CEQA question, talk about the feasibility of removal makes me a little itchy. If it is true that decommissioning facilities is simply part of the life cycle of facilities and if it was feasible to put them in, and if the impacts of taking them out are more or less the same as the impacts of putting them in then surely it is feasible to take them out. It is logic chain, that when people say clearly it is not feasible to fully remove the facilities. I do not think that is a prior conclusion that we can accept. I think we clearly need to look at what does that mean? Why is it not feasible? What kind of costs are we really talking about? What type of alternatives are there really? Before any are pushed off the table with a messy dismissive label.

On the consolidation site question which I touched on briefly about COOGR which Jim Lima raised yesterday, I cannot resist one little dig. Something which seems pretty reasonable now from a land management standpoint was the occasion of a litigation by the oil industry against the County of Santa Barbara when the policy was imposed in federal court. I think we deserve a little credit for looking down the road a bit. As we talk about decommissioning I am sure we will be hearing a lot about "well you know there might be some future use for these onshore facilities and pipelines," coming from the same people who thought we should not have such a policy in the first place. We will not forgive that and move on.

It is worth noting that neither Gaviota or Los Flores Canyon have in fact functioned as consolidated facilities because no one else has come along to share them. There have been various permitting scenarios that have been played out but none of them have led to actual investments and projects. So we do not have actual functioning consolidated sites, but we do have the capacity for them.

At the local government level we look at the lessons of what happens when we allow removal to lag behind disinvestment which has been documented quite nicely for Santa

Barbara County in the past and we compare it against the uncertainty, both economically and technically, about how and whether additional offshore plays may come into production in the future, it puts us in a real dilemma. We don't want to cause needless disinvestment through decommissioning followed by reinvestment. We don't want the impacts of that either. On the other hand we do not want to get stuck holding the bag, with the rusty bucket facilities that turn out not to be anything anybody can use down the road. So it is a significant choice that requires some uncharacteristically open consultation with the industry about the future because these are business decisions that are going to drive this level of interest, not something the industry has been fond of talking about with local government or with each other for both legal reasons and competitive advantage reasons and yet I don't see how we can make much sense out of this without talking about those issues.

My last question is a very small one. On the rigs to reef issue, if in the fullness of time, if the present site of a jacket is going to be a pile of rust, and if as Dave Parker said it really does not have a whole lot of value unless you pile a bunch of augmentation materials around it anyway. Why do the present locations of the platforms make sense as a place to have artificial reefs. Does it not matter where they are? I think based on some things I have heard we are going to have to seriously look at the question of if artificial reefs, why at the present location of the existing platforms? I do recognize that this is an already identified issue, but it became clearer to me that in the long run the presence of the jacket does not have much to do with it. Thank you.

**Russ Schmitt:** Thank you very much. At this point I would like to open up to questions not only for the panel members but also address any issues you might have with any of the reports given by the session co-chairs. And please this is not a public hearing.

**Bill Stolp with Dames & Moore:** I have a question/comment. The last five years I have been in the UK and Norway working on platform decommissioning facing many of the similar issues and problems that you are facing now. I would like to agree with Lisle in that the more you assess the less you know. We have been applying science and analytical

techniques to the questions that come up and I would like to say however, that California is not on the cutting edge!! You guys have some unique issues, but you are not ahead of the game. You are a little behind it, I would say about five years. What I would like to do is reiterate that you do need to put a methodology in a process to assess and analyze the issues. It needs to be a methodological approach to assess the technical, environmental, safety risk, and cost issues. You have to be able to address what is a scientific issue and what is a perceived value issue. They do not always see eye to eye and you need to be able to differentiate between them and know how to assess and handle those. So down to the actual question which goes to Minerals Management Service. Is there going to be another workshop similar to this in the future? Could it be possible to include more of the technical and scientific methodological assessment process from the lessons we have learned in the North Sea in those presentations? If you do include that I will be willing to coordinate that effort.

**Minerals Management Service:** I do not know if we have talked about what the next step is. That is in fact one of the problems ahead of us is, to define a course of action for the next few months and ultimately the next year or two. I do not know if the next time would be a meeting of this nature or something specifically oriented towards a set of options. I think at this point it is wide open. I think we need to work with the others at the table.

**Linda Krop with the Environmental Defense Center:** I do want to point out one distinction of what happens in the Gulf of Mexico. There are a lot of good lessons to be learned there. Some things that we probably want to follow and some things we probably do not want to follow. The question of liability is one we do not want to follow in that first of all the states do assume the liability. They are supposed to receive half of the savings that the oil companies retain by not removing the structures completely, and apparently there is an issue as to whether they actually receive the full amount they are entitled to.

Second of all in terms of compensation to commercial fishers, the Gulf has a blackout policy. If a commercial fisher loses gear or equipment and is compensated, that area

becomes blacked out for future claims. So if another fisher enters that area and has loss as well, they cannot receive economic compensation. Well the entire Gulf is blacked out. So fishers are filing claims, but they are not being compensated. I think that is a lesson we need to learn and we do not want to have that kind of liability absolved here.

My comment was going to be that I am pleased to see so much support for pursuing these issues that were raised at the conference further and with the qualifications expressed by John Patton, that a lot of that effort should be focused on the science. I would like to make a suggestion. Many of us in this room and on the panels have been involved in a very indepth process dealing with high energy seismic surveys. It has been a cooperative effort of the federal, state, and local agencies, as well as the public industry, fishers, etc. One of the things we did in that process is we had a sub-component that looked at the science of the impacts of high energy seismic surveys primarily on marine mammals. The committee searched out experts in the field and developed questions for them. We had about twelve experts we brought into a room and we watched them debate the issues and discuss them for a day and a half, and it was fascinating. People who probably have never been in the same room before were. What was especially fascinating was the consensus that they achieved on virtually every question that we asked them. We are still getting some of those answers back in final form. We are finding out, number one, some very good answers to some of those technical questions. Number two, we are finding out where we need more information and what research should be conducted. I feel that we are in a very similar situation here. We have some information, and everyone seems to agree that we need more information. I would suggest that as a process to try and acquire that information in a collaborative effort.

**Lisle Reed:** It makes sense. I agree with Linda. It has been working very well with the high energy seismic theme effort. I think we may want to look at pursuing something similar to that. The success has been very good with the high energy seismic team. They put the science into a court all of its own and get the right people in to talk about it.

**Brian Baird:** In the ocean agenda, in our strategy we talked about, it is a different situation, but I think it is applicable. The joint review panel process for doing environmental impact reports, and quite frankly when I used to work at the Coastal Commission, I think I would characterize it as us sending a missile down to the Los Angeles office of the Minerals Management Service and them having to counterattack. We would go back and forth over these issues until one day somebody said, "why don't you all get into a room." We were in this room at times from 6:00am till late into the evening, going over all these issues, line by line. The one I was involved with came out with a document that we all agreed on. There was no litigation on the document. It is something that we think makes a great deal of sense, but it does need a structure in order to make it work.

**Linda Krop:** One quick comment on that. Lisle isn't that particular high energy seismic safety meeting, that is also facilitated? You just do not throw people into a room and ask them to solve a problem?

**Lisle Reed:** Yes it was well organized and well facilitated.

**Sue Benech, Marine Biologist:** I have a question for Mark Carr. I am posing it as a question, although it is a little bit of a comment too. We have talked a lot about marine mammals, fishes, and mobile invertebrates. I was shocked to hear of the removal of 3000 tons of attached invertebrates on these platforms. The question I would like to pose to Mark is since these platforms are not just reefs, but are actually islands because of their vertical zonation, has there been any discussion of what they may serve as seed communities for shallow sub-tidal and intertidal coastal area that are heavily impacted by anthropogenic influences? This may be an important issue to follow up in as far as science is concerned. I get knocked back and forth, Linda left me positive and Mr. Patton left me negative. It sounds like science is moot, and it is mostly impression.

**Mark Carr:** Thanks. That is a really good question. Unfortunately it is one of those that is very difficult to address, that is the problem with marine populations that exist on these structures. They are characterized by larval

dispersal that is the mechanism by which they may potentially replenish other populations and communities elsewhere. The problem is we do not know very much at all about those patterns of larval dispersal. This is an issue that raises its head in applied marine ecology constantly. I just spent last week at a National Marine Fisheries service workshop trying to design and consider the role of marine reserves as fisheries enhancement strategies. It is the same thing that keeps coming up, how do you design or locate reserves, or in this case artificial reefs, that might contribute to other populations? We just do not know those connections, but certainly that is a very viable possibility that the organisms that exist on these platforms act as a source of larval replenishment to other populations nearshore. On the other hand, just like marine reserves, we have to be cautious because they may also have absolutely no effect. It is all dependent on both the environmental conditions that influence the dispersal of organisms from that site and the characteristics of larvae that determine their pattern of larval dispersal. I wish I could be more positive, but it is one of those things that science needs to address.

**Tom Raftican from the United Anglers:** I want to pretty much follow up on what some people have already said. For example Susan Hansch said, "Let's get the next step planned before we leave." I think Mr. Baird was excellent in his comments too. Maybe instead of planning the next step let's try and get together. The only thing I would like to add to that is we have some outside stakeholders and the "big" boys. We both would like to be informed along the way and also as they are developing information in each area. We need some sort of access to that information across the board. So that instead of coming not knowing what is going on in different areas, if you come to a meeting, an association, or a group, with the information already available to you when you get there, we can come out with much better conclusions from that instead of discovering everybody else's information at that time. So just something to think about before we leave. Thank you.

**Connie Hannah from Santa Barbara League of Women Voters:** I just wanted to thank Maureen Walker for bringing up the vessel traffic problem. We had spent two days and we had never talked about the possible

impacts of intact platforms being a problem for vessel traffic. Barry Schuyler of UC Santa Barbara wrote his Ph.D. thesis on tanker traffic in the Santa Barbara Channel. He told the Santa Barbara audience that if you wanted to consider the ultimate disaster, you considered an ocean going tanker running into one of the oil platforms. I think that we must keep in mind the vessel traffic. We are delighted to hear that they are talking about a separation system finally for that traffic. As we talk about deep water platforms, we have to consider the vessels too.

**Maureen Walker:** I did want to state that in the Law of the Sea Convention, which I referred to quickly earlier, I did not quote one part of it which is very important, and that is from Article 60.3. That says that any installations or structures which are abandoned or disused shall be removed to insure safety of navigation. That is a number one issue. Then taking into regard what I mentioned before, the fishing and the marine environment, etc. I think a little history on this might be of some use to this audience. Back in the late forties when the industry was just getting off the ground, the United States Navy was quite suspicious of this activity because they thought the oceans belonged to the Navy. They did not want to see offshore oil and gas go in, but as it went forward their provisions put in an international convention, the 1958 Convention, that all structures would be removed, and the Navy had a lot to say about that particular provision. As the industry developed and went forward it became apparent, and mostly through some of the North Sea governments and also the United States, that there were going to be cases that not all the platforms could be removed. That is why the 1982 Convention on the Law of the Sea does have some flexibility here, but the guidelines that were drafted in the International Maritime Organization presumed that most platforms will be entirely removed. The exceptions are the exceptions to that rule. There are ways and means, and the guidelines go through them, but I just thought it is important for you to know some of that background and what was involved in developing those guidelines. Thank you.

**Lisle Reed:** I have one comment relative to the issue of tanker traffic inside the channel. I will observe that the state does definitely share

the concerns that were expressed in that. I believe today you will find that there is essentially no tanker traffic left inside the channel, particularly carrying crude. That is something that you will see even more strongly reinforced in the process of the Coastal Protection Review Document, which will be coming out shortly from our office. We anticipate nearterm publication of that. We also have a series of discussions underway on vessel routing issues, both in the Monterey Bay Sanctuary and also related to air quality issues coming out of Southern California. Those groups and operations are jointly being worked on by both the Coast Guard and NOAA as part of the issues in which the State is deeply involved. I think many of those issues that you raised will be resolved. There are however significant amounts of ongoing container traffic, which does have significant amounts of bunker, which does not completely eliminate the concerns that we have for any traffic that does remain in the channel.

**Maureen Walker:** Just one last thing. I have to put my hat on as the chair of the National Security Council Interagency Working Group, where we have to take into account the wide ranging views of our blue water interests; the Navy, the Coast Guard, as well as the coastal and marine interests of NOAA, EPA, etc. To say this issue of navigation is not one that is speculative, in the 1980s a German submarine did run into an offshore platform, and it is of safety concern. I just wanted to make that point. Thank you.

**Arvind Shah:** I am associated with the Gulf of Mexico office with Minerals Management Service in New Orleans. In the last ten years I have been involved with maybe more than 1000 applications, 70% of them with explosives, 30% of them with non-explosives. I have some experiences in these removals. I would like to make a few comments over here, about this rigs to reefs fund which was established by Louisiana and Texas. That fund is strictly dedicated to those rigs to reefs issues. For example they maintain the buoys out of that fund and they have not received any lawsuits yet so far. With 123 structures in this rigs to reefs area I am sure there is more than \$13 million in that fund. If you try to follow the same thing over here I would advise you adopt a similar fund that is dedicated to the rigs to reefs issues rather than that money going to

the state treasury and waiting for that money to come back to the agency. I think that it is very important because the states of Louisiana and Texas passed tough legislation and dedicated it to the rigs to reefs issues. In the Gulf of Mexico office all the removals we have done so far, we have not allowed this partial removal or totaling of the structure in place. The only time we have allowed this partial removal or totaling in place was in association with the rigs to reef structures. Minerals Management Service on their own in the Gulf of Mexico has not allowed any partial removal or totaling in place. Our regulations as they exist now require that all the platforms and all the structures, at the end of the expired lease, within one year be removed, regardless of water depth. Those are our regulations and that is what we try to follow. Regarding this rigs to reefs partial removal we do not have direct input, but most of these partial removals are done 85 feet below the waterline. In some cases they are removed less than 85 feet below water line. Minerals Management Service does not have an input in those partial removals from the waterline to the top of the removal. That issue is decided by the state through the Corps of Engineers and they consult the Coast Guard regarding the water level between top of the platform and sea level. They decide what type of buoys or aids to navigation should be placed on the structure if it is lower than 85 feet.

One last thing I would like to tell the audience here. We have a very good web page for those of you who like to "surf" the net. Our address is [www.mms.gov](http://www.mms.gov). We have a lot of information available. All our NTLs, all our LTLs, all the removal data on the platforms. We have about 1300 applications available on the internet. It is all on the internet. You can download it and it is free. Also we have public information available on the Gulf. We also have a toll free number that offers a lot of information and free hard copies from our offices. I am also willing to answer any questions while I am here. Thank you.

**James Wiseman, graduate student at UC Berkeley:** I was glad to hear about the web site. I have been talking to people about sharing information and we have talked about the need for sharing information. I would like to suggest, and people have agreed with me, that we host a public web site on a government

agency machine for information sharing. Here we could put together the proceedings of the conference, some conclusions, and pictures, etc. Thank you.

**Win Thorton, member of the Artificial Reef Advisory Board for the State of Texas:** I have a comment. I would like to say a couple of things about our program in Texas. It is a very comprehensive program. We started it back in 1980, and it is not just rigs to reefs. We have a lot of other materials and reef sites developed. We have liberty ships. We have purpose built reefs in nearshore areas. We do have rigs to reefs. We have concrete, rock, and fly ash blocks. We have a program that looks at a variety of materials and a variety of siting criteria. We also have an advisory board that is made up of the various stakeholders groups, be it oil and gas, be it recreational fisherman, commercial fisherman, divers, etc. So their input is developed and included in any of the siting or criteria that we do.

The fund that we have for the State of Texas is solely devoted to development of artificial reefs. The donations that are put there are used to maintain marker buoys as required to enhance those reef sites to cover any future liability should it occur. We have actually accepted donations from the oil and gas companies that have saved money. We have also paid money out to develop nearshore reefs that cost money. This was for recreational divers and recreational fishermen. We are actually funding the development of nearshore reef sites. We do deep water to a couple of hundred of feet, to shallow water reefs, to meet the needs of the multiple users in the state of Texas. Thank you.

**John Smith of Minerals Management Service:** Maureen is dying to get to this question, so I have to give her the opportunity to get into this issue. The issue of deep ocean disposal came up in several of the sessions. I would like to ask Maureen to address that for the benefit of the audience?

**Maureen Walker:** Thank you very much. By way of background it is important to know that what guides that particular issue is the London Convention. The London Convention is recognized as the source of the global rules and standards on dumping that are referred to only in a general way in the Law of the Sea

Convention. Today we have 76 parties to the London Convention, but what is not good is that a little over half of the oil-producer states are not members. We have been trying to encourage more participation by those governments. In 1996 the entire regime of the London Convention was re-worked through a protocol. This protocol will replace the convention. It is a free standing agreement to which both contracting and non-contracting parties may become party. This represents a culmination of a multi-year process of revising the Convention which began in 1992. The structural revision of the Convention is called the Reverse List. Basically what this does is contracting parties are obliged to prohibit the dumping of any waste and other matters unless they are listed on an annex. In the first annex there is allowance for the dumping of bulky items, vessels, offshore platforms, and other manmade structures. So there is an allowance to have these dumped at sea, but there is, as you can imagine, a rather involved process in order to accomplish it. What is occurring now within the scientific group of the London Convention are meetings of experts and scientific experts to try to come up with what is called the Waste Assessment Framework for the dumping of these particular items. That is an ongoing process and the next meeting will occur in the first week of April in South Africa. I have seen some of the early documents and they take into account many of the things you are raising here, because the disposal at sea option will be required to use best environmental practices. There are a number of considerations that every coastal state, and when I say coastal state here I mean nation, must take into account, including the issues I mentioned earlier; the fishing, the marine mammals, and the fact that the materials must be completely flushed out and cleaned, etc. before they are dumped.

There are provisions in this draft of this Waste Assessment Framework on site selection. What governments should look for; the physical and biological characteristics, the oceanographic characteristics, amenities, values, and other uses of the sea in that area, economies and operational feasibility. They have to look at geographical positioning and my understanding of U.S. Domestic Law is that this is regulated under Title One of the Marine Sanctuary Protection Act (MSPA), and that EPA, and the Corps of Engineers together

identify such areas. The answer to your question is yes, deep disposal will be allowed. It will be on a case by case basis. This is the considered opinion of the international governments that met in devising the protocol. In the face of the move by one government to actually have a moratorium on such disposal, but that government was not successful and we now have a situation where we hope by having the guidelines and standards there for nations, we may now be able to bring in some of the other oil-producing states. That is a big interest of the United States, although we have over half of the offshore oil platforms there are other platforms in other areas of the world where there is very little consideration as to the operation or decommissioning. As a result we are anticipating and co-sponsoring with the government of Indonesia, in April of this year, a conference on decommissioning to bring together economies in the Asia Pacific region to address this issue, which has economic importance as well as environmental concerns. It does again go to the issue that I raised when I began this morning which is the issue of the United States' leadership in this area. It is our companies and our environmental awareness and concerns that we bring to these countries and help them improve their standards in a way that really benefits the entire global environment. That is really our objective. Thank you very much.

**Melanie Stright with Minerals Management in Washington, D.C. :** I very much agreed with a comment made by a gentleman a few speakers earlier. It would have been very nice had participants been made available a lot of information up front so they could have digested it and brought that knowledge to the discussions ahead of time. Along that line I wanted to mention that several times this morning the IMO guidelines for platform removal for the purpose of navigation safety have been partially quoted and talked about. I do have copies of the IMO guidelines with me if anyone is interested and would like to see those. The only other comment I would like to make is over the last few days I have heard a couple of times it said that in terms of the artificial reef programs in the Gulf of Mexico that the oil companies and the states share the savings fifty-fifty. I wanted to point out it is my understanding that nowhere is it stated that this savings is 50% or that is what is donated

to the states. It simply says that the savings will be shared. Thank you.

**Russ Schmitt:** About the issue of having materials beforehand, we are still waiting for some of the position papers that were due a month ago.

**Tim Watson with Amoco:** Greetings Americans. How are you all? I have a question for Maureen, but first a short preamble. I think the international side of this is very vital and that is why I am glad to see Maureen here. You must be very careful in California not to take a "holier than thou" attitude on the sea. I come from a small island where it is only seventeen miles to the nearest beach. We have been there for 1000s of years and there are 55 mammals that live on it, so you must have your perspective of how you and the ocean can live side by side.

In terms of the impact of the world, I think that I am right in saying that 350 million Europeans will take much more notice of what happens out here in the Santa Barbara Channel than the rest of the United States. I think that is what Maureen is on about.

The U.S. Constitution I do not know much about, but I know it is based on common sense, give and take, and communication. It is probably the only legacy that the English left you, I hope. The communication must be with the North Sea. The Dames and Moore representative behind me was quite right that technically, even the Gulf of Mexico, is not up to speed. They have not had to be because they have shallow water platforms which is not what you have. So ignore them and come to the North Sea. We have already said we are here to help and pass on the technology. You cannot do science on this unless you know technically what you are going to do with the platforms. This technology needs importing. You cannot make a decision without it. You need to know what the regulations are. You need to know intimately what the IMO means to yourselves and to the rest of the world, because believe me the world does take notice of what the U.S. does.

We do not use the word feasible in taking platforms out anymore. We could put a platform on the back side of the moon if we wanted to. The oil industry is extremely clever.

Five years ago we said only when feasible and we got exactly the same kind of reaction, quite rightly from the mothers of the moon that you would expect. It is feasible, anything is feasible. The question you must ask yourselves is, is it worth it? Is it worth the journey?

Let me have a quick note on some of the other aspects of this. Environmental impacts, I am sorry to tell all the environmentalists here, but they are very, very small in global terms, but have fun in finding something that really has an impact. If you do find something that has an impact I am on the internet so please let me know.

Much more important is the communication which I will come on to, but common sense arguments and I stress the word that was in your U.S. Constitution, common sense. You have got to use common sense. You cannot have it all your own way, whether you are the oil company, or the man in the street, or the representatives of the man on the street. You have got to have common sense arguments. Believe me, I have been there. They have much more impacts than science. I am afraid that scientists and lawyers come at the bottom of my believability chart. I am just an engineer and I am much more believed by the housewife. We are talking to the housewife in the end, because they are the ones that vote in the politicians. They have the say in the end.

On reefs. In the U.K. or the North Sea we do not talk about artificial reefs. We acknowledge that they are a nuisance to the users of the sea. We come back to is it worth it? And we compensate the users of the sea. We do not hide behind anything like a reef. It may well be different here, but I can assure you the whole industry is not pushing off junk platforms and calling them reefs. That is not the case. We recognize they may be valued in some parts of the world not necessarily the North Sea, but they are an impediment to navigation. They are not an environmental problem. Impediments can be compensated for and that is the only way forward if it is worth it to leave it.

Deep sea ocean disposal has come up several times. Assuming if you can get beyond 200 miles from the U.S. Navy, you can dump whatever you would like. I imagine that is

probably the basis of the law. Whether it is worth it is another thing. Technology says you cannot actually do it. Amoco's point of view is if you have a jacket on a barge and you have gone to the trouble of lifting it onto the barge, then take it ashore. Do not dump it! It simply is the wrong thing to do. Take it ashore and recycle it, reuse it. Do not dump it just because you have it on a barge. You have to evaluate deep sea disposal. That does not get into the Brent Spar which is something different. The Brent Spar is not a rig, but a floating storage barrel.

Liability, we are very clear in the U.K. about this. The only people that are going to be around in fifty years is the government. They ultimately should take the liability, but you make the liability as small as possible. You clear up your debris, you compensate the fisherman, you give them buoys if that is what they want, you give them instrumentation if that is what they want, you give them new ships, if that is ultimately what the people want and is worth it. So you do bend over backwards for your customers and ultimately the people are your customers. As Shell found out when your customers get mad they fire bomb your gas stations. So look after your customers.

Finally it is common sense, do not forget that. Common sense is the only way forward. I do make a plea based on five years experience, that cut out the lawyers, cut out the scientists, and get down on your knees and start talking to the house wife, and start talking real impacts. Let the housewife know exactly what this is all about. First of all tell them what a platform is. Affably, smile on your face. Let's not have this aggravation that is apparent here. We have had that and it does not get anywhere. Let's have a smile on your face. Let's keep our feet on the ground. A lot of give and take.

The oil industry must go out and do its technical work. Then you can do the science. The oil industry must invest in the best things possible, it has to, not the contractors, they have no need to do it. The oil industry must do that and that is what they should be pledging.

Finally you must have patience. This is a long drawn out thing. We are in unknown territory. We all use gasoline. We are all responsible for



the platforms being out there. The oil industry can make a pledge to you right now that if you stop using automobiles we will stop drilling for oil. It is simple, but it is absolutely true.

Now my question, leadership, to Maureen. If you totally remove your platforms in the Gulf of Mexico because you get pushed into it, because it is not worth it, and it is not the common sense thing to do. Maureen what impact do you think that is going to have on the American oil companies in the North Sea and around the world, if they too get pushed into it? Thank you very much.

**Maureen Walker:** Could you just repeat. Did you say total removal in the Gulf of Mexico?

**Tim Watson:** Yes, if you go for total removal and it is not the best thing to do, and the Americans are showing leadership, and they opt out of a proper decision, what impact is that going to have on the North Sea? Where we have many more, and a lot of American oil companies own a lot of real estate.

**Maureen Walker:** One thing that your comment on, and asking me to comment on leadership, points up to me, and something I always say before we head off to a negotiation somewhere in the world, is that the most difficult negotiation always happens before we leave our shores. That is because we do have so many competing interests to take into account and the scenario you projected for the Gulf of Mexico would not be possible because of all those various interests that we have to take into account. In fact as I indicated earlier, when Denmark made the proposal for a moratorium we could not support it as an oil-producing state. That was unacceptable, and also because we do tend to take the common sense approach, looking at the science and taking all the views into account. That leads me to one other comment that I would like to make, that is an attempt within international organizations to try to regulate the oil and gas industry on an international basis. This is something that we oppose because the regions are different. The North Sea is very different from the Gulf of Mexico, which is very different from Southeast Asia, etc. It is these differences in regions that have scientific implications, legal implications, that we would take into account. For this reason we will continue to oppose what I consider a "head in

the sand" approach. We do have expertise here and we would never want to ignore it. Thank you very much for the opportunity to make that comment.

**Russ Schmitt:** More questions? Comments?

**Bill Stolp:** I would like to make just one final comment. I promise this is the last time I will comment. An interesting postmortem of the Brent Spar backs up exactly what Tim Watson was saying. The postmortem of the Brent Spar incident, it was done exactly by the regulatory regime. It was done with good science, good economics, and good technology. The point here that everyone needs to listen very carefully to, it was the German housewife that turned that around. They tried to prove a technical problem. They tried everything they could, but it was not until they got onto recycle of 14,000 tons of steel. Now the German housewife is the most efficient recycle entity in the world. Virtually everything that comes into her kitchen is recycled. When she found out that there was 14,000 tons of steel that was not going to be recycled, she did not care that it cost \$5,000 a ton to recycle it, when you can go out and buy new steel for \$200 a ton. I leave that with you as a point of what Tim Watson was trying to make. Somebody outside Ventura County, somebody outside California, somebody outside the continental United States of America, can have one hell of an impact on what happens offshore Ventura County.

**Susan Benech, Marine Biologist:** I just wanted to make one final comment. What I learned in the past three days, I brought back with me "3 C's." That is Common Sense, big underline under that, Communication, ten underlines under that, and Cost, both environmental and economic. That is what I have learned and I am glad I attended. Thank you.

**Russ Schmitt:** I would like to thank you all, the panel members, for both their insight as well as their willingness to listen and answer comments. I would like to give a very brief summary and closing remarks. This is clearly a case where less is more. It seems to me that there were lots of "letters," for example the "3 C's," common sense, communication, cost, "S & S," science and safety, "L & L," listen and learn. It is the "listen and learn" I think that we

all did. That is what Bill asked us to do early on, and I think we did it very well.

One of the purposes here was for us to find out more about what the issues are. To find out more about decommissioning, the process as a whole. I think we did that. We listened to each other. As a result we have a better appreciation, a better sense for where we all agree, where the common ground is. We have a better sense of what we do not agree on. We have a better sense of why there are those issues that we do not agree on. I think it was a very valuable exercise for us to come to that in these past couple of days. The big issue that confronts us is where do we go from here? That is one that we are not going to have a quick answer from. So it is something I want you all to think about. Quite clearly we are going to need to have more of these types of sessions, maybe not in this type of format. It is going to be very useful for all of you to give feedback to Minerals Management Service and the State Lands Commission on where we should go next. Those agencies are going to have to take a step back and digest what they have learned and heard too. Maybe the next time there will be more focus groups. We heard a lot for example from Rigs to Reefs, maybe we need more on Rigs to Reefs, but in a different kind of format. We do not want to beat it to death, but yet there are issues there that need to be resolved. We touched on them. They are still important, even if we do not agree on them. We still need to worry more on, for example liability issues, or the alternative use issues. Please let's walk away from here thinking more about these issues and how we are going to deal with it!

With that I want to thank all of you for participating. I especially want to thank the State Lands Commission again and Minerals Management Service for hosting this timely workshop. And a special thanks to just a few people; Frank Manago, John Smith, Minerals Management Service people who did a heroic job in helping organize this thing, and especially to my assistant, Bonnie Williamson, who actually did everything. Thank you very much.

---

---

## POSITION PAPERS

---

Environmental Defense Center, Linda Krop and Nichole Camozzi.....	172
Exxon Co., USA, Dave Tyler .....	177
Recreational Fishers, Merit McCrea .....	179
Santa Barbara Lobster Trappers, Chris Miller .....	181
Southern California Trawlers Association.....	182
United Anglers of Southern California / American Sportfishing Association, Daniel Frumkes .....	184



## POSITION PAPERS

Position Papers were solicited from over 100 ocean-user groups (oil and gas industry, environmental groups, commercial fishing and recreational fishing). These groups were asked to submit their positions on the various issues that would be discussed at the workshop. Each group was asked to submit up to one page on the 16 issues below that had been identified by the working groups. Ocean-user groups were asked to submit one set of position papers, reflecting the position/opinion of the group.

Following is the list of issues and list of disposition options which was distributed to the ocean-user group representatives.

**ENVIRONMENTAL ISSUES** [addressing the effects that occur *during* the actual removal process, or as a direct result of removal (e.g., anchor scarring)]:

- A. Air Quality
- B. Commercial/Recreational Fisheries (effects *during* removal - long-term effects addressed under Disposition Issues)
- C. Marine Mammals
- D. Marine Benthic Impacts
- E. Water Quality
- F. Contamination/Remediation of Onshore Sites
- G. Future Land Use

**DISPOSITION ISSUES** [addressing long-term effects of the decommissioning process]:

- H. Commercial Fishing
- I. Recreational Fishing
- J. Habitat Value
- K. Enhancement of Platform Structure
- L. Site Clearance
- M. Onshore Disposition (ultimate fate of materials - reuse, recycling, etc.)
- N. Social Impacts
- O. Economic Impacts
- P. Fate and Longevity of Materials

**DISPOSITION OPTIONS** (you may want to address issues in light of the various options listed)

- Non-Removal of Platform, Alternative Use
- Full Removal of Platform
- Remove Topsides, Partial Platform Jacket Removal, Topping (e.g., remove jacket to 85' depth, leave remainder in place)
- Remove Topsides, Partial Platform Jacket Removal, Topple (e.g., cut platform at sea-bottom, topple in place)
- Remove Topsides, Move Platform Jacket to alternate site as Artificial Reef
- Remove Topsides, Deepwater Disposal of Platform Jacket (e.g., cut platform at sea-bottom, transport to deep water)
- Full Pipeline Removal
- Partial Pipeline Removal
- Onshore Facility Removal, Restoration

## ENVIRONMENTAL USER GROUP REPRESENTATIVE, DISPOSITION PANEL

LINDA KROP

Environmental Defense Center, Santa Barbara

As stated in the EDC's position papers on platform abandonment and shell mound removal, environmentalists in the Tri-County Area (Ventura, Santa Barbara, and San Luis Obispo Counties) support complete removal of offshore oil and gas facilities upon project abandonment. Complete removal is necessary to avoid safety hazards and to ensure restoration of the natural environment. Removal is also consistent with existing state and federal laws and policies.

Contrary to these laws and policies, the oil industry desires to leave platforms in place, allegedly "converting" the platforms to "artificial reefs." However, there is no evidence that platforms function as reef habitat. Although fish may congregate at the platforms, there is no evidence that the fish would not exist without the platforms, either elsewhere in the ocean or at natural reefs.

Any decision to change existing laws, thereby allowing the oil companies to avoid their responsibility to remove the platforms, should be based upon an objective analysis. As many of the other workshop speakers pointed out, an artificial reef program must be based on science, not the economic whim of the oil companies. The most pertinent scientific paper on the subject is "Artificial Reefs: The Importance of Comparisons with Natural Reefs," by Mark H. Carr and Mark A. Hixon (*Fisheries, Special Issue on Artificial Reef Management* 22(4):28-33). As stated in that paper, research should be conducted to determine whether artificial reefs merely attract fish, or whether they provide a habitat for increased production that would otherwise

not be possible. Production is determined by examining how the reef affects fish reproduction, growth, emigration, and mortality on a regional basis. Studies conducted thus far indicate that artificial reefs may not be as productive as natural reefs because they lack the structural complexity and natural forage base. If recruitment to an artificial reef reduces recruitment to natural habitats where survival and growth are greater, the artificial reef may actually *reduce* the regional production of fish.

The industry's desire to leave deepwater platforms in place would set a significant precedent. Even in the Gulf of Mexico, where some platforms are disposed offshore, the platforms are first removed and the sites are completely cleared of debris. The platforms are then deposited in an approved area. Also, in the Gulf of Mexico, the states assume liability for the rigs once they are deposited offshore.

In conclusion, there is no evidence that offshore disposal will have any beneficial impact; whereas there is ample evidence that platform debris creates environmental degradation and safety hazards. Existing policy and permits should be enforced to require complete removal of offshore platforms. If it was feasible to put the platforms in, it must be feasible to take them out. The oil companies knew all along that the platforms would have to be removed and should not be relieved of their obligations now that their production operations have ceased.

## PLATFORM ABANDONMENT AND THE SANTA BARBARA CHANNEL

NICHOLE CAMOZZI

Intern, Environmental Defense Center, Santa Barbara

Between 1958 and the 1980s, thirty-one platforms have been installed in the Santa Barbara Channel. Production on some of these platforms is now complete and the platforms must be removed. The first four of these platforms were removed in 1996 from state waters off the coast of Santa Barbara County, raising the issues of platform abandonment options and impacts. When removing a platform, a myriad of options arise, raising the question of which is "best" for all parties involved. Environmental groups, commercial and recreational fishers, state and federal agencies, and the oil industry must choose the most feasible economic and environmental option while not violating any permit conditions or laws. Although current state and federal regulations require complete removal of the rigs, the full range of options are as follows:

- 1) Complete removal
- 2) Use of platform as scrap onshore
- 3) Rigs-to-Reefs program converting platform pieces to "artificial reefs"
- 4) Sell in place to other oil company
- 5) Relocate the platform for use elsewhere in the ocean
- 6) Store the platform onshore for possible reuse
- 7) Partially abandon the platform in place by either cutting it off below the water line ("topping") or tipping the platform over ("toppling")
- 8) Leave in place for research, recreational fishing, restaurants, etc.
- 9) Deepwater dumping

The current debate focuses on whether to completely remove the platforms or whether to convert them to "artificial reefs." The Environmental Defense Center, on behalf of local environmental organizations and commercial fishers, supports the option of **completely removing** the platforms in compliance with state and federal permit conditions. Another goal of the above parties is restoration of the marine environment to its natural state.

For 20 years, the Environmental Defense Center (EDC) has been working to protect the California coast from oil development, the catharsis of which comes in complete removal of the oil platforms. Additionally, 40% of fisheries in the Santa Barbara Channel have been lost to the oil industry and the commercial fishers feel it is only just for the oil companies to restore this region. The permitting state and federal agencies apparently agree. However, there is a current effort to modify government regulations to circumvent complete removal by focusing on a "rigs-to-reefs" option.

The scientific argument surrounding the issue of platform abandonment, namely "rigs-to-reefs," centers on the need to study each area around a platform to determine if an artificial reef is necessary and whether a platform is suitable to act as a reef. Additionally, the Department of Fish and Game (DFG) does not consider an area that fish use merely as a refuge to be an artificial reef. According to the DFG's "Guide to Artificial Reefs in Southern California," the primary factor of consideration for an artificial reef is the following:

"Reefs must provide adequate habitat for shelter, forage, growth, and reproduction, thereby increasing (regional) fish production. The goal of reefs is to increase species' carrying capacity." (p. 5)

Each artificial reef is unique; therefore to determine an artificial reef's effectiveness, each reef must be studied individually. More importantly, platforms are not the most desirable materials or design for artificial reefs, and natural reefs already exist in the area. According to an article by Marine Ecologists Dr. Mark Carr and Dr. Mark Hixon, titled "Artificial Reefs: The Importance of Comparisons with Natural Reefs," "... the greater vertical relief and shelter availability (number of holes) of artificial reefs did not

compensate for the great structural complexity (variety of hole sizes) and natural footage base provided by the corals and associated benthos of natural reefs.” (p. 3) There are both shallow- and deep-water natural reefs in the area of the Santa Barbara Channel, such as Carpinteria Reef, Horseshoe Kelp, Horseshoe Reef, and Four-Mile Reef. Therefore the urgency for artificial reefs in the Santa Barbara Channel is not imminent. In fact, artificial reefs may attract fish away from more effective natural reefs. Permit conditions for complete removal of the platforms should be enforced immediately.

The participating agencies on the state level are the State Lands Commission (SLC), California Coastal Commission (CCC), and the DFG. The SLC and CCC act as permitting agencies which both require the complete removal of platforms including removal of all debris on the seafloor (see, for example, SLC, Negative Declaration, Section 15073 CCR and Final Mitigation Monitoring Program; CCC Chevron 4-H Platform Abandonment, CDP No. E-94-6). The DFG acts as an advisory agency on issues such as whether the rigs should be used as possible artificial reefs.

On the federal level, the Army Corps of Engineers (Corps), Environmental Protection Agency (EPA), National Marine Fisheries Service (NMFS), and the Minerals Management Service (MMS) have jurisdiction over platform issues on the Outer-Continental Shelf (OCS). The Corps’ permitting power is granted under the River and Harbor Act, Section 10, which regulates work on structures in or affecting navigable waters of the United States. In accordance with the SLC and CCC, the Corps also requires removal of debris on the seafloor (see, Special Conditions for Chevron’s Platform Abandonment 94-50801-TAW). The EPA shares responsibility with many of these agencies in overseeing air and water quality issues, along with hazardous waste and toxic substance management. The NMFS has

jurisdiction under the Endangered Species Act to manage species and marine mammals. And the MMS oversees leases and approves all development of oil and gas on the OCS.

All of these federal agencies, under the lead of MMS, currently require complete removal of oil platforms. Politically though, the MMS appears willing to support rigs-to-reefs. The Environmental Defense Center, local environmental groups, and fishers would like to see state and federal agencies enforce their own permit requirements by expediting complete removal of platforms when production has ceased.

Complete removal of the oil platforms is also necessary for liability issues. Aside from the obvious polluting environmental impacts of dumping rig debris in the ocean, who is responsible when this material deteriorates? What happens when platform pieces become navigational hazards? Who pays for new fishing gear when commercial fishers snag their nets and possible capsize their boats, thus endangering lives? The safety precautions that must be taken if platforms are left in the ocean are numerous. Complete removal of the platforms is the only feasible option; it is cost effective, environmentally sound, and safe.

The State Lands Commission, the leading state agency on oil platform issues, allows construction of platforms on the condition that upon completion, the oil industry must “restore the marine environment to its natural state.” (SLC Negative Declaration, Chevron 4-H Platform Abandonment, Section 10573 CCR and Final Mitigation Monitoring Program, p. 5-107.) “Natural state” means absolutely no presence of a rig or rig debris. It is time to restore the Santa Barbara Channel to the pristine environmental conditions before 1958, when fishers and recreationalists could roam freely and our sea floor was clear.



## SHELL MOUNDS

### NICHOLE CAMOZZI

Intern, Environmental Defense Center, Santa Barbara

In 1996, Chevron removed oil platforms Heidi, Hilda, Hazel and Hope off the coast of Southern California near Summerland and Carpinteria, leaving behind massive mounds of mussel shells. The mounds, approximately 200 feet wide and 20-30 feet tall, have accumulated as a result of periodic scrapings of the initial platform legs. Although the platforms are now gone, the issues arises over what to do with these shell mounds. Who is responsible? Who enforces decisions? What are the options? Local fishers, community environmental groups, and state and federal agencies are currently trying to answer these questions. As a result, unenforced permit requirements, ambiguous guidelines, and confusion have surfaced.

The involved parties include both commercial and recreational fishers, the Environmental Coalition of Santa Barbara (Sierra Club, League of Women Voters of Santa Barbara, and Citizens Planning Association), The Environmental Defense Center (EDC), the State Lands Commission (SLC), the California Coastal Commission (CCC), the Army Corps of Engineers (Corps), the Department of Fish and Game (DFG), and of course, Chevron. The commercial fishers (mostly trawlers), along with the environmentalists, would like to see the shell mounds removed immediately due to the hazards the mounds pose to the livelihood of fishers. Fishers feel the threats of snagging gear and capsizing boats endanger not only their property, but their lives as well. Restoration of the marine environment to its natural pre-oil industry state is also a main concern of the trawlers and environmentalists. On the other hand, the recreational fishers and the mussel harvesters believe that the shell mounds act as artificial reefs which provide ideal fishing grounds. The conflicting agendas of the commercial trawlers and the Environmental Coalition, versus the recreational fishers and the mussel harvesters, cannot be resolved without guidance from both state and federal agencies.

The SLC and the CCC are the state agencies (Chevron's four platforms are in state waters within the three-mile jurisdiction) whose permits require the removal of all debris on the seafloor, as well as a trawl test and verification of site clearance (SLC, Negative Declaration, Section 15073 CCR and Final Mitigation Monitoring Program; CCC Chevron 4-H Platform Abandonment, CDP No. E-94-6). Chevron flunked both agencies' trawl tests. The Corps (the federal agency) also requires removal of debris within a 1,000 foot radius and "Preparation and execution of a 'trawl plan' providing the test trawls of the area, and survey of the project area with a ROV high resolution side-scan sonar to **verify that potential hazards to commercial fishing operations have been removed**" (Corps, Special Conditions for Chevron's Platform Abandonment 94-50801-TAW). Chevron did not pass this trawl test either.

The State Lands Commission and the California Coastal Commission are looking to the Department of Fish and Game for advice on this case, specifically to answer whether there shell mounds act as artificial reefs. According to the DFG's "Guide to Artificial Reefs in Southern California," the primary factor of consideration for an artificial reef is the following:

"Reefs must provide adequate habitat for shelter, forage, growth, and reproduction, thereby increasing (regional) fish production. The goal of reefs is to increase species' carrying capacity." (p. 5)

Two marine biologists at the University of California Santa Barbara's Marine Science Institute have recently studied artificial reefs and shell mounds. Dr. Milton Love, one of the scientists, has studied the mussel mounds surrounding platform Gina (east of the Santa Barbara Channel) and does feel that fish reside in the area. Although Milton Love was cited in the SLC's Negative Declaration on the Chevron Platform Abandonment Project as finding the area of the platforms "not suitable for many rockfish species" (p.5-55), he does

feel that even if fish just use an area for a refuge, that refuge can preserve the species' life, thus indirectly increasing carrying capacity.

Dr. Mark Carr, a former UCSB Marine Ecologist now working at UC Santa Cruz, has published journals on artificial reefs and feels that each artificial reef is unique. To determine a reef's effectiveness, Carr states the reefs must be studied individually. Because the mussel mounds being discussed have not yet been researched, Carr is hesitant to assert or deny the mounds' performance as an artificial reef.

This lack of information leads right back to the DFG investigation of the mussel mounds' role as possible artificial reefs. The DFG feels it is Chevron's responsibility to conduct video reconnaissance of the mounds for DFG to evaluate and determine the role of the mounds. If the DFG decides the mounds are artificial reefs, the SLC and CCC will most likely concur. This means if Chevron would like to leave the mounds in place, they will have to seek amendments to their permit requirements. In the process of seeking this amendment to forego the permit-required "trawl-test," Chevron will have to undergo supplemental environmental review which includes public review and comment. Additionally, the question remains regarding responsibility for damage incurred by trawlers' gear from the mounds. Will Chevron be liable and continue to pay for new gear or will the SLC take over responsibility if the permits are amended?

#### EDC Shell Mound Removal

In the meantime, the Army Corps of Engineers has decided that although Chevron flunked the Corps' trawl test, the shell mounds are not an issue because the Corps considers shell mounds "natural" and not "debris." This may lead one to inquire what exactly defines "debris," considering the mussel mounds resulted from the presence of the oil rigs. According to the Army Corps' Environmental Assessment of this project, "debris" is referred to as "... all man-made obstructions (e.g., pieces of the topsides, jacket and equipment used during the operation)..." (p. 12). This presents a problem for all parties involved if the Army Corps is not willing to recognize 200

feet wide, 12-30 feet tall mussel mounds which formed after being chipped off oil rigs as "debris." As far back as 1987, the Minerals Management Service (another federal oil permitting agency) clearly recognized the mussel mounds as "debris" in a study titled "Ecology of Oil/Gas Platforms Offshore California." Numerous times throughout the report the mussel mounds were mentioned as "debris" or "debris pile(s)" under the platforms (pp. ix, 17, 19-20). More importantly, the Army Corps' permit contains the additional requirement that all potential hazards to commercial fishers must be removed. These mounds **define** potential hazards to commercial fishers. The Corps may not ignore this fact, choosing to enforce only the portion of its permit requiring debris recovery of strictly man-made materials.

With the Corps neglecting the fact that mussel mounds interfere with commercial fishers and the DFG waiting for Chevron to eventually video the mounds for further study, the commercial fishers and the Environmental Coalition are disconcerted. Claims have already been filed by fishers for damaged nets, tensions are mounting due to the unenforced permit requirements, and almost a year has passed since the platforms have been removed, making the mussel mounds a pressing issue. The people with the most at stake, the trawlers and environmental groups, are tired of being in limbo.

The State Lands Commission's Negative Declaration seeks to "restore the marine environment to its natural state" (p. 5-107) and that is what the Environmental Defense Center is asking of Chevron. Although studies need to be done to determine whether these mounds do serve as artificial reefs, there already exist many natural reefs in the area. Removing the mounds will not be detrimental to the regional fish population considering the presence of many nearby natural reefs. Sending a message to oil companies that they must clean up our coast when they are done extracting their profits is the most vital issue in this case. Oil rigs were allowed on the condition that complete removal would follow the end of a rig's presence, in this case this shell mounds. It is time to force Chevron to promptly abide by its permit requirements.

## OIL AND GAS INDUSTRY PERSPECTIVE REGARDING ENVIRONMENTAL EFFECTS DURING DECOMMISSIONING

DAVID TYLER

Public Affairs Advisor, Exxon Co., USA

It's a distinct honor to address this workshop on oil and gas facility decommissioning. It is also a pleasure to be back in the Tri-county area and again renew long friendships with many of you.

Before I begin, I want to commend the Minerals Management Service, the State Lands Commission, and the other local agencies and interested parties for their proactive and continuing attention to the decommissioning issue. It's one of the important issues facing offshore and even onshore oil and gas production in California during the next decades.

While I am representing the oil and gas industry today, I will be referencing one recent decommissioning experience associated with Exxon's Santa Ynez Unit or SYU development. This experience was the successful, as it turned out, decommissioning of the Offshore Storage and Treatment facilities, or OS&T for short. And I say "successful" thanks in large part to the expertise and dedication of many individuals and organizations too numerous to name -- but well represented at this workshop -- including regulators, contractors, consultants, and fisheries reps. By the way, if you have not already visited Exxon's exhibit, I encourage you to take a look at the pictures of some other recent SYU decommissioning projects.

With that said, I have been asked to give an oil and gas company perspective regarding the environmental effects during decommissioning and removal operations. You have already heard what the effects might look like for air quality, fisheries, marine mammals, and other resources. I would like to talk about three ingredients that are absolutely essential, in our view, to a positive environmental outcome, and which apply regardless of the resource or disposition option.

The first ingredient is sound science. This applies as much to the prospective industry applicant wanting to decommission a facility as it does to the regulators. The analysis and resulting regulatory decision should be based on the best available science, taking into account human safety, technical feasibility, environmental benefits and risks, and cost-effectiveness principles. Consultants and marine contractors obviously play an important role here. For instance, their expertise was vital in helping Exxon generate accurate vessel emissions forecasts and project durations for the OS&T decommissioning project. This information was used by Exxon and the agencies to rationally compare abandonment alternatives during the NEPA permitting process.

The second ingredient is removal flexibility. Each offshore facility is site-specific and all disposition options need to be considered before making any decisions. This includes the ocean disposal option. Conversely, a rigid "one size fits all" regulatory policy sometimes results in greater environmental impacts, inefficient use of capital resources, and may even dampen technological innovation.

Flexibility is also important in how the job is performed. For example, Exxon was able to avoid explosives during OS&T pile removal operations because it had the flexibility to cut the support piles as shallow as two feet below mudline, if necessary. As it turned out, the abrasive cutting method worked fine and the piles were cut about 15 feet below mudline. The point is, the agencies built-in the flexibility up-front to respond to actual seafloor conditions so that we could pursue the optimum solution.

The last ingredient is open communications. I cannot emphasize enough the importance of open dialogue with all jurisdictional agencies and affected groups with legitimate concerns, including non-jurisdictional agencies and other ocean users like fisheries. Of course, this

dialogue needs a strong lead agency to keep the process moving forward efficiently. MMS, as the lead agency for the OS&T decommissioning project, did a superb job in getting all the agencies together with Exxon early and often to discuss issues and options.

Exxon also communicated openly and widely throughout the OS&T permitting process. We did not wait until the work barges were offshore to discover whether there were any potential conflicts. For example, Exxon consulted early in the process with the joint oil fisheries liaison office. Letters were also sent to potentially affected commercial fisheries soliciting their comments and suggestions. From this information, a plan acceptable to all

parties was worked out to minimize any impacts. Moreover, prior to and during the operation, notices to mariners were broadcast by Coast Guard radio and, just in case, notices were posted at harbor master offices to keep fisheries informed during decommissioning.

In summary, I believe these three ingredients--sound science, removal flexibility, and open communications--are essential to a positive environmental outcome for all concerned. That certainly was the case for Exxon's OS&T project.

## POSITION WITH RESPECT TO THE DECOMMISSIONING OF OFFSHORE OIL PLATFORMS

**MERIT McCREA**

**Owner/Operator of Seahawk LXV**

**Representative for Southern California Commercial Passenger Fishing  
Vessel Industry**

**Board Member of the Sport Fishing Association of California**

It is my feeling that platform jackets be left *in situ* in the fashion that meets the requirements for both safety and safe navigation. Of the options covered in the Workshop and in order of preference after considering the technical considerations involved and the points brought forward by other speakers at the Workshop these would be most suitable for my user group.

1. Alternate use in conjunction with "Moth Balling" where safe and practicable pending market shifts or technological advances that might make renewed oil and gas production efforts viable. It is interesting to note that some of the services to the navigational community in conjunction with the current operations may be worth while enough to justify the continued maintenance of a particular platform. e. g., Harvest Traffic Center's supervision and vigilance over the Western terminus of the Santa Barbara Channel Vessel Traffic Separation Scheme. Weather reports and observations on site provided to NWS and rebroadcast to the public.
2. Partial removal with a portion of the Jacket left above water to support lighting and sound equipment to make its position evident to mariners.
3. Topping the jacket below a level that assures safe navigation of vessels typical to the area and conceivable for the future.

Key to all of these options is that both part of the cost savings to be realized by these less than complete removals and the scrap materials being made available to be used toward environmental enhancement of the

local coastal area and continued maintenance of the remaining site.

It is the specific interest of my user group that the jacket structures continue to act as recruitment and/or production sites for the fishes that use them currently. These rig structures have historically been the site of good sport fishing opportunities for our clientele at times. We would hope that they would continue to be so. Enhancements of other nearby areas resulting from the deposition of scrap materials of the decommissioning process and made economically possible by cost savings in the decommissioning process would be an additional plus for us. If it is the position of the Ca. DFG that additional types of materials be used in conjunction with the scrap steel that too would be supported by us.

- I. Sport fishing is important**
- II. Reefs are important to sportfishing**
- III. Platform based reefs would be a good thing for sport fishermen**

### **I. Sport fishing is important**

- 1) Outdoor Life network mentioned that sport fishing was surveyed to be the second most popular sporting activity nation wide.
- 2) I spoke with Bob Fletcher and he noted that we had carried 550,000 ANGLERS industry wide last year.
- 3) There are over 300 CPFVs currently operating in California.
- 4) He also mentioned that Mr. Steve Crook of DFG had noted that as of 1995 there slightly more private boat anglers than CPFV anglers for the first time.

- 5) Sport Anglers do lots of stuff besides fish along the way...

- Eat at Restaurants
- Buy boats and tackle
- Incur travel expenses
- Stay in hotels
- Pay for fees and licenses

Are members of the public and have opinions...

- 6) Sport fishing is important.

## II. Reef structures are important to sport fishing

- 1) From a local party boat perspective much of our fishing occurs over hard substrate, reefs:

- Kelp bass
- rock fish
- much of yellow tail
- much of white seabass
- much of barracuda
- much of Sand Bass
- Sculpin & some tuna

- 2) I Spoke with Russ Izor about his reefs. He was instrumental in the construction of 17 artificial reefs in the Newport area. Apparently, there are times when these

reefs provide the best/only sportfishing opportunity for the **Newport ¾ and ½ day boats.**

- 3) They produce literally thousands of sculpin at times when water conditions are such that other fish aren't biting. **"The Newport boats have lived off it."**
- 4) He noted that key in reef productivity was the use of a dump barge where materials are dumped on top of one another instead of scattered thinly over a wider area. **(high relief).**

## III. Platforms make good sport fishing sites

- 1) The areas that the rigs are located even in the channel area lack high relief structure also. None greater than 4 m and mostly less.

\*= lost opportunity

- 2) In '87 and '88 Herman\* First desire to have left in place as reef.
- 3) In '89, '90, '91 and on Hazel,\* Hilda,\* Hope,\* Heidi,\* Houchin, and Hogan.
- 4) In the late 70's Widows on ABC Hillhouse.
- 5) Also Bocaccio on Holly.

## **SANTA BARBARA LOBSTER TRAPPERS PERSPECTIVE RIGS-TO-REEFS POSITION PAPER**

**CHRIS MILLER**  
**Santa Barbara Lobster Trappers**

We believe that the introduction of artificial reefs in our area should have well defined goals. Our goal for artificial reefs is that they are designed to promote the growth of the kelp forest ecosystem. We find that the current concept of rigs-to-reefs for decommissioned oil platforms is biased in its focus of providing sport fishing opportunities for one species, rock fish. We wish to promote a more holistic goal for artificial reefs.

As commercial fishermen we view the loss of our coastal kelp forests with the same alarm that land based environmentalists view deforestation. The kelp forests and bottom

growth of various marine algae provide habitat that plays a major role in the life cycles of the majority of our coastal marine life. We suggest that artificial reefs be composed of appropriate materials and placed inside sixty feet to promote kelp forest ecosystems. We also would like to see these artificial reefs placed in relationship to existing reef habitat to enhance and expand them.

The Santa Barbara Lobster Trappers oppose all artificial reef proposals that conflict with traditional fishing methods in historic fishing grounds of the Santa Barbara commercial fishing community.

## SOUTHERN CALIFORNIA TRAWLERS ASSOCIATION PERSPECTIVE

### 1) ENVIRONMENTAL ISSUES

#### A. Area Preclusion.

During rig removal, trawl fishermen lose additional fishing area due to the deployment of barges, moorings, support craft and related equipment. This causes an economic impact that should be mitigated.

#### B. Fishery Impacts.

Underwater abandonment activity – especially detonations that break up legs or oil rigs – scatter fish such as halibut, a primary species targeted by local trawlers. Not only does this decrease our ability to catch fish near the rigs, experiences in fisheries impacted by seismic blasting suggest that, depending on the species and duration of sonic disruptions, this phenomenon can last several weeks. In deep water, species affected could include commercially-harvested rockfish, sole and shrimp. Economic impacts could range from moderate to severe, and should be mitigated.

#### C. Recommendations.

Oil companies should communicate with fishermen prior to start-up of abandonment operations, in order to 1) schedule and undertake activities in a manner that creates the least amount of impact to trawlers; 2) deploy barges, moorings and other equipment in areas where trawlers would not fish anyway (such as hard bottom rocky areas), thus reducing the amount of area preclusion; 3) coordinate abandonment activities with seasonal or area fishing closures, in order to best accommodate commercial fishing activities; and 4) notify fishermen about the timing, progress and results of all abandonment activities, including detonations and seafloor cleanup. Oil companies should also develop a system for day-to-day communication with fishermen, in order to alert them to which areas are clear for trawling and which might present hazards, depending on abandonment operations. Mitigation for economic losses due to area preclusion and fish dispersal during abandonment should be implemented.

### 2) DISPOSITION ISSUES

#### A. General Comments: Removal vs. Non-Removal.

Based on permits issued by the Army Corps of Engineers, State Lands Commission, Minerals Management Service, California Coastal Commission and Santa Barbara County, fishermen have been led to believe oil rig “abandonment” would mean complete removal of the rigs and restoration of the ocean floor to pre-development conditions. Negotiations and mitigation measures have been undertaken based on that understanding. As the abandonment process draws closer, however, concepts such as “rigs-to-reefs,” which would preclude total abandonment, are receiving increased attention. The following comments are based, to a degree, on that perception or possibility.

#### B. Recommendations.

Oil rigs should be completely removed during the abandonment process, as required by permits the companies signed years ago. This perspective is shared by many other fishermen’s groups, including the California Lobster and Trap Fishermen’s Association and Pacific Coast Federation of Fishermen’s Associations, which are on record in that regard. Once rigs are removed, the seafloor should be restored to its natural state. That means removal of all debris, including shell mounds. If the mounds are left in place, trawlers lose an area even greater in size than the area lost when the rigs were operating. Without benefit of sophisticated Global Positioning Satellite (GPS) navigation and plotting devices (which most local trawlers do not have), they cannot risk fishing anywhere near the mounds, due to the possibility of damaging or losing gear, damaging their boats and endangering their crews. Recent data supports this perspective. In June 1997, for example, halibut trawlers from several ports – including Santa Barbara and Morro Bay – fishing near the abandoned “4-H” rigs repeatedly snagged and severely damaged their gear on shell mounds. They also caught tires, chains, steel pipes and chunks of cement in areas that were supposedly clean



and ready for fishing. Remaining pipelines do not pose a particular threat to trawling, as long as they are sufficiently buried. Pipeline connections, however, must be shrouded (covered), removed or well-buried to avoid snagging trawl nets. This has been a problem with abandoned rigs and pipelines in the past.

### C. Other Considerations.

If the rigs are not removed, SCTA would prefer that they be left in place with superstructure protruding above the waterline, so their exact location can be determined without GPS plotters. In addition, mitigation for the continued loss of fishing areas and the continued presence of subsea hazards (including commensurate economic impacts) should be considered. If the rigs are left in place, SCTA also has the following, specific concerns:

1) For environmental protection and protection of the boating public, some agency, private party or association must accept liability for corrosion of remaining rig materials and their dispersal through the water column of along the seabed. "Rot" and "reef" are two different concepts. In addition, some entity must accept liability for potential harm to commercial fishing boats, their gear and their crews, should fishermen snag rig structures or debris associated with the rigs, or be harmed by pieces of rigs that dislodge themselves and cause "offsite" impacts.

2) The superstructure of at least one rig should be modified to accommodate weather-sensing and weather-reporting equipment. This project would benefit all mariners, especially since individual offshore weather buoys are temporary. Offshore rigs dismantled in the southern Santa Maria Basin (western end of the Santa Barbara Channel) would be good candidates for this project. The rig chosen for a weather station should be selected by consensus among representatives of the fishing community, National Weather Service, and the Scripps Institution of Oceanography.

3) The location of any rigs dismantled below the waterline must be marked above the water line. In other locales, attempts to mark the location of artificial reefs with spar buoys have proven difficult, since, over time, the buoys grew heavy with marine growth and eventually sink. Thus, a maintenance

contract (with funding identified and secured beforehand) and a maintenance schedule should be completed before any rigs are turned into artificial reefs. The agreement should cover the reef itself, plus any apparatus used to mark the site for mariners and fishermen. To avoid posing hazards to navigation, buoys marking artificial reefs should include radar reflectors and strobe lights. If concern arises over the fact that a highly-visible, well-lit buoy will attract too many sportfishermen and result in the take of too many fish (possibly drawn to the area from nearby hard-bottom habitats), then the artificial reefs should not be established in the first place. Safety is a primary consideration of all options, should the rigs – in whatever form or at whatever depth – remain.

4) Full environmental review should be undertaken before rigs are turned into reefs. This study should review potential impacts to several commercial fisheries, including bottom trawlers, swordfish and shark drift-netters, salmon trollers and hook-and-line rockfish fishermen. Participants in these fisheries have anticipated full removal of offshore platforms, and all would be impacted in various manners and to various degrees, should a "rigs-to-reefs" plan be implemented.

## UNITED ANGLERS OF SOUTHERN CALIFORNIA / AMERICAN SPORTFISHING ASSOCIATION PERSPECTIVE

### DANIEL FRUMKES

Chairman, Habitat Research and Enhancement Committee, United  
Anglers of Southern California (UASC)  
Director, Conservation Network, American Sportfishing Association  
(ASA)

#### A. Air Quality

The less time that heavy equipment must be employed during decommissioning the less air quality will be negatively impacted. The cost of complete removal of the five platforms under discussion has been estimated to total several hundred million dollars. Partial removal will result in savings of millions of dollars. Chevron is willing to share savings derived from using the platform jackets as part of a Rigs To Reefs program. This provides an unprecedented opportunity for habitat enhancement. Environmental effects of decommissioning including air quality should receive primary attention. Next, we would like to see that maximum funding is made available for artificial reefs. This will be enabled by maximizing the shared savings, and will probably result from finding an alternative use for the platforms or "topping" them, i.e., removing the topsides and cutting the jackets at a safe depth.

The effect on air quality became a major issue in the recent decommissioning of the 4 H rigs near Carpinteria. Our solution involved topping the rigs and would have reduced the air pollution and enabled improved marine habitat. Unfortunately the minority position held by special interests prevailed and the environment suffered.

#### B. Commercial/Recreational Fisheries

Commercial and recreational stakeholders fish and dive close to the platforms and exposed pipelines because their productivity results in increased concentrations of marine life. The decommissioning process should be safe and take reasonable care to avoid harming mammals and causing chemical pollution. Otherwise it should proceed rapidly so as to minimize the disruption of fishing and diving. The appropriate regulatory agencies have expertise in these areas and we are available to support and assist them.

We would like to see both environmental protection and maximum funding made available for artificial reefs (see A. Air quality). This will be enabled by maximizing the shared savings and probably involve finding an alternative use for the platforms or topping them, i.e., removing the topsides and cutting the jackets at a safe depth. Since "time is money", solutions designed to safely maximize savings will probably tend to minimize the time that fishing activities are disrupted.

#### C. Marine Mammals

The less explosives and the less time that heavy equipment is employed during decommissioning, the less that marine mammals will be negatively impacted. The appropriate regulatory agencies have expertise in the appropriate measures to protect marine mammals and we are available to support and assist them. We would like to see both environmental protection and maximum funding made available for artificial reefs (see A. Air Quality). This will result from maximizing the shared savings, and will probably involve finding an alternative use for the platforms or topping them at a safe depth. These solutions are also in the interest of marine mammals.

#### D. Marine Benthic Impacts

Given proper attention to the environmental concerns discussed above, the disturbance of the benthos should be minimized. Since scientists believe that the productivity of the jacket remaining after decommissioning will be enhanced by the addition of non-toxic hard substrate. Leaving as much as possible of what is already there should be of benefit the marine environment.

Mounds of shells produced by invertebrates living on the jackets have accumulated at the base of rigs. Scientists believe that shell mounds provide productive nursery habitat. The ones at the base of the 4 H rigs measure

hundreds of feet across and up to 30 feet high. Although the trawlers are currently demanding that the remaining shell mounds be removed, the state and Chevron are planning to evaluate their habitat value. The trawlers have offered to contract to remove the mounds. They have also suggested that they might allow these productive reefs to remain, provided that the fishers are adequately compensated.

Clearly the mounds associated with the platforms currently being evaluated should not be removed if they are enhancing the productivity of the marine environment. Factors to consider include: (1) the productive value of the mounds, (2) potential habitat enhancement from redirected funds, and (3) the avoidance of negative environmental impacts associated with the removal of these large mounds.

See section K, (Enhancement of the Platform Structure) for a more complete discussion of the value of allowing hard substrate to remain and be enhanced.

#### **E. Water Quality**

Environmental effects of decommissioning including water quality should receive primary attention. Next, we would like to see that maximum funding is made available for artificial reefs. This will result from maximizing the shared savings, and will probably result from finding an alternative use for the platforms or topping the jackets at a safe depth.

Decommissioning solutions that require removal of the subterranean portion of the legs could increase the possibility of seepage. However, the plugging mechanisms we and the agencies support make this unlikely. The removal of pipelines poses risk of contamination and will have to be reviewed on a case by case basis. The appropriate regulatory agencies have expertise in the appropriate criteria and measures to protect the environment from adverse effects to water quality we are available to support and assist them.

#### **F. Contamination/Remediation of Onshore Sites**

Some of these sites may have potential value to recreational fishers (see **G. Future Land Use**). Also, some of the non-toxic materials to be removed may be better utilized as productive marine habitat than added to

already crowded landfills. We would like these issues considered when solutions are chosen.

#### **G. Future Land Use**

In 1992, recreational fishing contributed \$2.9 billion in sales to the California economy and generated a value added impact of nearly \$5 billion while supporting 153,849 jobs. For the same year, the value added impact of the commercial fishing industry was only 0.7 billion and supported 20,820 jobs. The federal government estimated marine anglers' expenditures in southern California to be \$536 million for 1989. Most of this was related to shore or near shore based angling. Marine anglers make a far greater contribution to the economy than do commercial fishers, yet do so while taking a much smaller proportion of the state's marine resources. The value of recreational fishing should be considered when determining the use of piers and other coastal sites.

#### **H. Commercial Fishing**

The halibut and other fisheries impacted by trawls would benefit, over time, if more of the sea floor was protected from these nets. State tidelands were closed to trawlers near the turn of the century to protect habitat and reduce over-exploitation and waste. Some of the waters were reopened in 1971 by the state Legislature in an effort to save the trawlers from the financial effects of depleted halibut stocks. The expansion of the trawling area had the potential of further depleting those stocks and was supposed to be temporary, pending an evaluation. The state's evaluation concluded that, given the dramatic increase in pressure on the halibut stocks, the expansion of the halibut trawl grounds further exacerbated the over-exploitation. The trawl fishery for the sea cucumber, a prized invertebrate in Asia, was initiated, in part, to compensate for reduced halibut stocks. Sea cucumbers are easily over-exploited, and they have been elsewhere. Local over-exploitation is also expected.

Trawlers fish near the rigs because fish congregate there. The least beneficial structure, from the trawler's viewpoint, include small unmarked pieces of debris. Although these act as mini-reefs, they do pose a problem for trawlers because trawls are not very selective. They catch debris in addition

to a large bycatch of unwanted marine life. It is precisely this characteristic of bottom trawls that causes them to damage natural habitat. Habitat damage is one of the reasons that trawls have been banned in state waters.

Trawlers who use other fishing gears have attempted to persuade other commercial fishers to oppose the Rigs to Reefs program despite the advantages provided by the reefs. As a result of conflict with the oil companies, the trawlers have demanded and received money and equipment. Fishers, other than trawlers, may support them based fear that they will be negatively impacted as the public reacts to local over-exploitation. Their insecurity has increased due to public awareness that most of the world's important fish stocks are depleted, and that over-exploitation driven by an exploding population is a primary cause. It is natural for them to feel a need to band together to protect their freedom. However, it is not in their interest to join the trawlers because most of the local fishers are not deserving of the criticism directed at the trawlers. We want to work with them to optimize the resource enhancement potential of Rigs to Reefs.

The influence of the trawlers is out of proportion to their small numbers. They have received millions of dollars in compensation from the energy industry by blaming the industry for diminished catches. The trawlers capitalized on the industries' unpopularity and the lack of public awareness that over-exploitation was the primary cause for reduced trawl landings. Recently, they were instrumental in defeating a plan to use of the 4 H rigs in a habitat improvement and research program. They not only demanded that the rigs be removed, but some also demanded to be reimbursed for lost fishing opportunity during removal. The trawlers currently are demanding that the remaining shell mounds be removed and have offered to contract to remove them. Scientists believe that shell mounds provide productive nursery habitat, therefore some trawlers have suggested that they might allow the mounds to remain provided that the fishers are adequately compensated.

The influence of the trawlers has been enhanced because they are represented by the Environmental Defense Center. We were told that this organization is supposed to work for the protection and enhancement of marine

resources. This goal is not furthered by supporting those who damage and over-exploit marine resources or by opposing resource enhancement programs.

### **I. Recreational Fishing**

We represent southern California's largest conservation organizations dedicated to increasing the value of marine resources to the citizens of California. Increased abundance of marine fishes and invertebrates is essential to achieve that end, and artificial reefs can be very beneficial. We believe that the design and management of reefs should be based on the best available science.

Our dedication to improving habitat has been established. We have provided most of the funding for California's artificial reef program since its inception in 1958. With the reduction in government funding, most recent construction has been accomplished due to our initiative and with donated funds. The cost of complete removal of the five platforms under discussion has been estimated to total several hundred million dollars. Partial removal will result in savings of millions of dollars. Chevron participates in the Rigs To Reefs programs in states bordering the Gulf of Mexico. There, 50 percent of the savings realized by using the rigs in the program are dedicated to marine habitat enhancement. We are committed to working with responsible agencies and industry to ensure that funding for the enhancement of nearshore coastal habitat is maximized as a result of an environmentally sound decommissioning process.

Reefs are beneficial to anglers and divers as well as to commercial fishers, because they produce and aggregate marine life. Fishers using stationary gear such as most anglers, commercial hook and line, and commercial trap fishers concentrate their efforts near reefs. Even mobile gear fishers such as halibut trawlers drag their nets close to reefs because halibut concentrate there. Tall complex structures such as the bottom of platform jackets are good to fish near but can entangle fishing gear which is dragged across them. This is one reason that scientists have suggested that the jackets be left in place as harvest refugia. Anglers would support harvest refugia as one of several alternative management concepts for artificial reefs.

Anglers are working to implement management that restores fish stocks to levels that produce the maximum sustainable surplus. We fund and provide volunteer staff in experimental mariculture facilities in an effort to rebuild depleted stocks and to learn more about our marine resources. Artificial reefs can function as habitat for mariculture. Indeed, platform jackets are presently so utilized. Mariculture offers the potential of enabling the over-capitalized segments of the commercial industry to move from **capture to culture** by raising marine life instead of further depleting existing stocks. We want to maximize the value of stocks to society while we work to maximize the quantity of important marine resources. Improved habitat and management are essential to attain these objectives.

We would like to see that the maximum funding is made available for artificial reefs. This will result from maximizing the savings shared as part of a rigs to reefs program and will probably involve finding an alternative use for the platforms or topping the jackets at a safe depth.

#### **J. Habitat Value**

Only 5 percent of southern California's shallow marine bottom is hard substrate. Scientists have established that the habitat value of hard substrate is between 6 and 15 times greater than that of soft substrate. In addition, the marine life associated with hard substrate are generally valued more highly than those associated with soft substrate. Even halibut, which are commonly associated with sand bottom, concentrate to feed near hard substrate.

The most productive hard substrate has high relief such as that found in reefs. Also, the diversity of marine life increases with reef height. Since productivity increases with available light, reefs should come as close to the ocean's surface as possible. Kelp enhances the productivity of hard substrate, but it is relatively unproductive in the absence of additional high substrate. Some scientists have hypothesized that an improperly located new reef could interfere with the productivity of nearby reefs. Others have observed that increasing the concentration of reefs can be beneficial by diluting the average rate of exploitation. The siting of new reefs should consider these potential effects.

Artificial reefs have been observed to contain higher concentrations of marine life than natural reefs. The consensus among marine scientists is that, in the absence of exploitation, properly sited artificial reefs increase the productivity and abundance of marine life in our coastal waters. However, both natural and artificial reefs have been over exploited in southern California.

Over-exploitation and effects of urbanization have reduced the abundance of marine life. It is clear that we can partially mitigate for these effects by creating reefs. It is characteristic of productive habitat to attract marine life and predators, including man. Therefore, there is a need to develop management solutions that appropriately balance productivity and exploitation. The issue is not **if** reefs should be constructed, but **how** they should be designed and managed, and **where** they should be sited.

There are many available management options. For example, if the reefs were topped in deep water, it might be best to make the remaining structure a harvest refugia for rockfish. Reefs built in shallow water could have more restrictive bag and size limits than are the current norm. The choice of restrictions will be dependent upon socio-economic as well as biological issues.

Pipelines provide hard substrate and, ideally, should be left in place. Reasonable precautions must be taken to protect the environment from toxins. Trawlers have been provided special gear to enable them to roll over the pipelines.

As a part of the decommissioning process, Chevron has indicated a willingness to fund the construction and monitoring of reefs in an effort to provide answers to the questions relevant to an expanded artificial reef program. We strongly support this approach. However, there is substantial funding currently dedicated to the construction of artificial reefs that could enable the process to begin this year. We urge industry and the regulatory agencies to begin relevant research soon to enable us to be better informed prior to the actual decommissioning. Lets enhance the resource while increasing knowledge about resource enhancement.

#### **K. Enhancement of Platform Structure**

The most productive hard substrate has high relief such as that found in reefs. Also, the

diversity of marine life increases with reef height. Since productivity increases with available light, reefs should come as close to the surface of the ocean as possible. Kelp enhances the productivity of hard substrate, but it is relatively unproductive in the absence of additional high substrate.

The consensus among scientists is that high relief increases the diversity of marine life. Biomass tends to increase with the complexity of the structure, while increased complexity of the surface of the structure benefits juvenile stages. Steel structures such as platform jackets colonized by invertebrates provide good surfaces. Scientists also believe that high relief should be supplemented by complex low relief such as that created from piles of recycled concrete. The habitat value of a topped structure would likely be enhanced by the nearby placement of the topped portion of the jacket.

Although we know enough to build reefs that are more productive than the soft structure upon which they are founded, we believe that we could improve our reef building ability given appropriate research. There are many questions concerning the optimal design of the complex low relief component. We believe that it should contain both low and high piles of concrete but we do not know how they should be configured to obtain optimal results. Similarly, we are unsure of the optimum combination of sizes of concrete components. We also need to know more about the movement of marine life between reefs and reef modules. These questions have been delineated in research proposals by leading ecologists and fisheries experts.

There is substantial funding currently dedicated to the construction of artificial reefs that could enable the process to begin this year. We urge industry and the regulatory agencies to expand on the research currently planned so that we will be better informed prior to the actual decommissioning. Lets enhance the resource while increasing knowledge about resource enhancement. Chevron has indicated a willingness to fund the construction and monitoring of reefs in conjunction with the decommissioning process. We strongly support this approach as part of a continuing effort to increase our knowledge in areas relevant to an expanded artificial reef program.

#### **L. Site Clearance**

We have established, in other sections, that the marine habitat value, marine life abundance and the society as a whole will receive maximum benefits by maximizing the savings that Chevron has agreed to use for marine resource enhancement. This will probably result from decommissioning program involving: (1) the removal of the superstructure, (2) topping the jacket at a safe depth, (3) locating the topped portion close to the remaining jacket, and (4) augmenting the base of the jacket with recycled concrete.

The site destined to become the low relief reef need only be cleared of toxic materials. Non toxic structures (debris) outside the new reef provide habitat value. These structures also can inconvenience trawlers.. Non toxic structures clearly need not be removed if they are in an area designated as a harvest refugia.

In determining which of the non toxic hard substrate (debris) to remove, the responsible agencies will have to balance public views, the views of scientific researchers, the desires of the trawlers (see **N. Social Impacts**), with the value to other stakeholders and to the marine environment. Fishers refer to these materials as "structure" and it has habitat value to some forms of marine life. The least beneficial structure, from the trawlers viewpoint, include small unmarked pieces of debris. Although these act as mini-reefs, they do pose a problem for trawlers because trawls are not very selective. They catch debris as part of a large bycatch of unwanted marine life. It is precisely this characteristic of bottom trawls that also causes them to damage natural habitat. How far should we go to facilitate the use of destructive fishing gear?

We do not believe that the habitat value of small debris is sufficient reason for it to remain. However, the cost of removal and the mitigation that could be accomplished with shared savings will also need to be considered. We look forward to assisting these agencies in their pursuit of solutions that maximize the benefits to the public.

#### **M. Onshore Disposition**

The regulatory agencies are experienced in this area and we are available to provide assistance if needed. We would like to help ensure that the public is well informed as to the environmental costs of alternatives.

Creating habitat for marine life is far preferable to adding to the waste in landfills. Moving less material also reduces air pollution. Creating reefs may increase air pollution from tugboats but it reduces air pollution from trucks. Unless the rig is left in place or removed intact, onshore impacts will probably be minimized by topping the rigs and allowing the appropriate part of the top of the jacket to be placed near the topped rig. If the rig is in an unproductive location, the top portion might be moved to a more productive location, such as the edge of a near shore canyon. All rig material could be augmented with recycled concrete to enhance the complexity of the benthic structure. We would like to see the superstructure recycled if at all possible.

Clearly, there are many disposition options that provide positive benefits to society and marine habitat. These should be fully explored prior to approval of options that further tax our landfills. The use of concrete as reef components has the added advantage of reducing the amount of material otherwise destined for landfills.

#### **N. Social Impacts**

The debate concerning artificial reefs in southern California has focused on biological questions. The most common issue being: do artificial reefs produce marine life or do they just attract it? There is little doubt in the scientific community that artificial reefs both produce *and* attract marine life. Production and attraction are a function of siting and design. However, artificial reefs can increase the availability of marine life to predators, including people. Had the reason for the debate been about maximizing the productivity of the most valued marine resources, we would have increased our efforts to: (1) learn how to design, site, and manage reefs to maximize the production of the most valued marine resources (see O. Economic Impacts) and (2) learn how to balance production and consumption. We have not taken advantage of major opportunities to do so. Some of the reasons for this are discussed below.

California pioneered artificial reef development in the 1950s. The program has been funded by millions of dollars, primarily from the recreational fishing community, and, until recently, was robust. The Department of Fish and Game approved the placement near

Palos Verdes of two jackets from oil platforms in 1988. Although the project was consistent with California policy and the National Artificial Reef Plan, the project was viewed as "ocean dumping" by some, and it was canceled with little public discussion.

There are many reasons for opposing the construction of artificial reefs. However they are often disguised and expressed in terms of doubts about reef productivity. The opinion that we should leave the coastal habitat in a natural state, even if altering it could increase productivity, should be expressed directly. Also, reefs concentrate marine life and make it more available to fishers and divers. This is an anathema to those who do not approve of injuring marine life. This opinion is often expressed in terms of reef productivity. Other opinions are related to the energy industries' poor reputation in southern California. There are those who do not like the idea of the industry profiting by participating in the construction of artificial reefs. There would be little acceptance of the position: "biological productivity be damned" if industry benefits. Therefore it is often expressed in terms of productivity. For example the use of platform jackets in reefs is precluded by the argument that "the only productive reefs are kelp reefs". This statement has no factual basis and is contradicted by available research. The bias is illustrated by the relative lack of opposition to the use of a large steel structure in a reef at about the same time that the use of platform jackets was being vigorously opposed..

Artificial reefs are disparaged by some who are concerned that acknowledging the productivity of artificial reefs would inhibit wetland restoration. The logic is that productive reefs might be approved as mitigation for habitat damaged during development, especially harbor development. Although wetlands are of little benefit to the most valued fisheries in southern California, they are valued by most of us. We do not feel that it is appropriate to disparage the productivity of reefs in order to protect wetlands. We prefer a balanced approach that supports both wetlands and reefs.

The **importance** of the attitude toward artificial reefs also varies widely among individuals. The views of stakeholders who frequently interact with coastal waters would be expected to be more strongly held than the views of people who have little contact with

the ocean. We are supporting research to evaluate public attitudes concerning artificial reefs. Such research can provide a framework in which to develop and manage coastal habitat to maximize the value to society.

#### **O. Economic Impacts**

In 1992, recreational fishing contributed \$2.9 billion in sales to the California economy and generated a value added impact of nearly \$5 billion while supporting 153,849 jobs. For the same year, the value added impact of the commercial fishing industry was 0.7 billion and supported 20,820 jobs. The most recent estimate available for annual expenditures by marine anglers in southern California was \$536 million during the 1989 calendar year. Most of this was related to shore or near shore based angling.

The value of edible fish and fish products imported into California in 1992 was almost eight times the value of exports. Most of the little remaining seafood caught in our waters is not consumed by Californians. Marine anglers make a far greater contribution to the economy than do commercial fishers, yet do so while taking a much smaller proportion of the state's marine resources. None the less, the value of the marine resources of California is usually expressed as a sum of the number of pounds of each species landed by commercial fishers times the price per pound. This number is doubled or tripled when expressed as the value to the economy.

The value of marine life to the stakeholders varies widely. A few fish are worth a great deal to the non-consumptive diver (snorkel or scuba diver), or catch and release angler. Each fish provides repeated pleasure over time. Even the consumptive recreational user values the activity involved in obtaining "dinner" much more highly than the market values the commercial landing. For example, a commercial fisher receives about \$2 per pound for salmon, while economists have determined that anglers spend over \$100 per pound for the experience of catching their own salmon. Sharks are being increasingly valued by our society, yet they are usually wasted as unwanted accidental bycatch of the nets of the commercial swordfish and tuna fishers, or they may be wasted in the process of taking the fins for sale.

The cost of complete removal of the five platforms under discussion has been estimated to total several hundred million dollars. Partial removal will result in savings of millions of dollars. Chevron is willing to share savings derived from using the platform jackets as part of a Rigs To Reefs program. This provides an unprecedented opportunity for habitat enhancement. Environmental effects of decommissioning should receive primary attention and we discuss our positions on some of these in other sections. Next, we would like to see maximum funding made available for artificial reefs. This will be enabled by maximizing the shared savings, and will probably result from finding an alternate use for the platforms or by topping them at a safe depth.

The California Rigs To Reefs program may differ from existing programs in other states because the newly constructed reefs may not contain material from rigs. Most of our reefs are likely to be constructed from recycled concrete. High relief may be created from concrete or other appropriate materials. Our program will have many benefits including increased knowledge of coastal marine life, habitat enhancement, cost effective recycling for those providing materials, and redirection of those materials otherwise destined for crowded landfills.

#### **P. Fate and Longevity of Materials**

The non-removal option would require protection of the platform from decay and its life span would be maximized. Coastal piers would require maintenance. Their value as habitat, for recreation, or other uses could compensate for the cost of upkeep. Concrete used to augment and enhance the benthic habitat lasts many decades and does not present a problem as it ages. Topped rigs may not be protected. However, the non toxic components of the rigs that have been approved under the National Artificial Reef Plan have life spans estimated to be from decades to hundreds of years. The value of the platform jackets as marine habitat will continue beyond the date that the structures begin to collapse.

Clearly, there are many disposition options that provide positive benefits to society and to marine habitat. These should be fully explored prior to the approval of options that further tax our landfills.



---

---

## **APPENDICES**

---

Appendix I: Regulatory Framework & Environmental Review Process for the Decommissioning of Oil and Gas Facilities.....	193
Appendix II: Platform Schematic, Locations of California Offshore Facilities, Decommissioning Decision Trees .....	221
Appendix III: Glossary.....	231
Appendix IV: Biographical Sketches .....	245
Appendix V: List of Attendees.....	257



**APPENDIX I:**

---

**Regulatory Framework and  
Environmental Review Process  
for the Decommissioning of Oil and Gas Facilities**

Prepared for:

**DECOMMISSIONING AND REMOVAL OF  
OIL AND GAS FACILITIES OFFSHORE CALIFORNIA:  
RECENT EXPERIENCES AND FUTURE DEEPWATER CHALLENGES**

Doubletree Hotel  
Ventura, California  
September 23 – 25, 1997

Sponsored by:  
Minerals Management Service  
and  
State Lands Commission

Hosted by:  
University of California, Santa Barbara  
and  
University of California, Berkeley

---

## TABLE OF CONTENTS

<b>Introduction</b> .....	195
<b>I. Federal Agencies</b>	
A. National Environmental Policy Act (NEPA) .....	198
B. Major Federal Agencies with Regulatory Authorities for Decommissioning of Offshore Oil and Gas Facilities	
• Minerals Management Service .....	200
• National Marine Fisheries Service .....	203
• U.S. Army Corps of Engineers .....	204
• U.S. Fish and Wildlife Service .....	205
• U.S. Environmental Protection Agency .....	206
• U.S. Coast Guard .....	207
• U.S. Department of Transportation, Office of Pipeline Safety .....	208
<b>II. State and Local Agencies</b>	
A. California Environmental Quality Act (CEQA) .....	210
B. Major State and Local Agencies with Regulatory Authorities for Decommissioning of Offshore Oil and Gas Facilities	
• California State Lands Commission .....	212
• California Coastal Commission .....	214
• California Department of Fish and Game .....	215
• California Division of Oil, Gas, and Geothermal Resources .....	216
• California State Fire Marshal, Hazardous Liquid Pipeline Safety Division .....	217
• Local Planning and Resource Management Departments .....	218
• Local Air Pollution Control Districts .....	219

## INTRODUCTION

This regulatory framework and environmental review process overview focuses on Federal, State, and local laws and regulations, as well as the National Environmental Policy Act (NEPA) and the California Environmental Quality Act (CEQA), with respect to applicable regulatory authorities for offshore oil and gas facility decommissioning. Some of the decommissioning activities would include the abandonment of oil and gas platforms, wells, pipelines, and onshore facilities.

Federal agencies are responsible for the environmental authorities under NEPA, while local and State of California agencies are responsible for the environmental authorities under CEQA. The Federal, local, and State of California agencies below are the major agencies having regulatory authorities for decommissioning activities offshore California.

### Federal Agencies

- Minerals Management Service
- National Marine Fisheries Service
- U.S. Army Corps of Engineers
- U.S. Fish and Wildlife Service
- U.S. Environmental Protection Agency
- U.S. Coast Guard
- U.S. Department of Transportation, Office of Pipeline Safety

### State and Local Agencies

- California State Lands Commission
- California Coastal Commission
- California Department of Fish and Game
- California Division of Oil, Gas, and Geothermal Resources
- California State Fire Marshal, Hazardous Liquid Pipeline Safety Division
- Local Planning and Resource Management Departments
- Local Air Pollution Control Districts

**Figure 1** provides a matrix of permitting responsibility for facilities in the Outer Continental Shelf, State Waters and onshore areas.

**PERMIT REQUIREMENTS BY FACILITY LOCATION**

Permit Requirement by Facility Location			
	Federal OCS	State Waters	Onshore – County/City
<b>Federal Agencies</b>			
Minerals Management Service			
- Lease Conditions/Stipulations	●		
- Development and Production Plan	●		
- Lease Term Pipeline Application	●		
- Pipeline Right-of-Way	●		
EPA – NPDES Permit	●		
ACOE – Section 10 Permit	●	●	●
USCG – Aids to Navigation	●	●	
<b>State Agencies</b>			
California Coastal Commission			
- Consistency Certification	●		
- Coastal Development Permit		●	
SLC – Lease Agreement/Permit		●	●
RWQCB – NPDES Permit		●	●
CDF&G – Section 1603			●
<b>City or County</b>			
Preliminary Development Plan			●
Conditional Use Permit			●
Final Development Plan			●
Coastal Development Plan			●
Misc. Permits			●
Air Pollution Control District			
- Authority to Construct	●	●	●
- Authority to Operate	●	●	●

Figure 1. Permit Requirements by Facility Location

**National Environmental Policy Act (NEPA)**

**and**

**Major Federal Agencies with Regulatory Authorities for  
Decommissioning of Offshore Oil and Gas Facilities**

## NATIONAL ENVIRONMENTAL POLICY ACT (NEPA)

NEPA (Public Law 91-190) was promulgated in 1970. It requires all administrative agencies of the Federal Government to consider the environmental impacts of their actions in the process of project development and decision-making. Further, NEPA allows other officials, Congress, and the public to independently evaluate the environmental consequences of government action. Finally, NEPA directs all Federal agencies to carry out their duties to the fullest extent possible in order to preserve and protect the environment and public health, safety, and productivity.

In many respects, the core requirement of NEPA is Section 102, under which environmental impact statements (EIS) are required for Federal actions that could significantly affect the environment. Under this provision, every recommendation or report on proposals for major Federal actions significantly affecting the quality of the human environment must include a detailed statement on: (1) the environmental impact of the proposed action; (2) any adverse environmental effects which cannot be avoided should the proposal be implemented; (3) alternatives to the proposal; (4) the relationship between local short-term uses of the environment and the maintenance and enhancement of long-term productivity; and (5) any irreversible and irretrievable commitments of resources involved in the proposal. According to the Council on Environmental Quality Guidelines, the primary purpose of the EIS is to ensure that the policies and goals of the Act are carried out. Federal agencies are to make their decisions based on the information contained in the EIS, as well as on other material.

The threshold question is whether an EIS is even required (See Figure 2). The answer depends on whether the proposal under consideration constitutes a "major Federal action significantly affecting the environment." "Federal Action" means both actions that a Federal agency undertakes and those the agency merely has the discretion to permit or approve. The "major action" provision allows agencies to avoid preparation of an EIS for minor matters with little potential for adverse impact. The standard "significantly affecting the quality of the human environment" means having an important or meaningful effect (direct or indirect) upon a broad range of aspects of the human environment. The cumulative impact with other projects must be considered.

An "Environmental Assessment (EA)" is prepared when a Federal agency determines an action may have no significant impact. The EA is a concise document briefly providing sufficient evidence and analysis for determining whether the proposal would have a significant impact and aiding the agency in determining when an EIS is necessary.

The basic rules for determining whether an EIS is adequate depends on: (1) whether the agency in good faith has taken an objective look at the environmental consequences of a proposed action and alternatives; (2) whether the EIS provides detail sufficient to allow those who did not participate in its preparation to understand and consider the pertinent environmental influences involved; and (3) whether the EIS explanation of alternatives is sufficient to permit a reasoned choice among different courses of action. Particular attention must be given to the analysis and comparison of alternatives to the proposed project. The details regarding EIS criteria may be found in the NEPA Regulations adopted by the Council on Environmental Quality. The Council was created under NEPA to assist with the implementation of the Act.



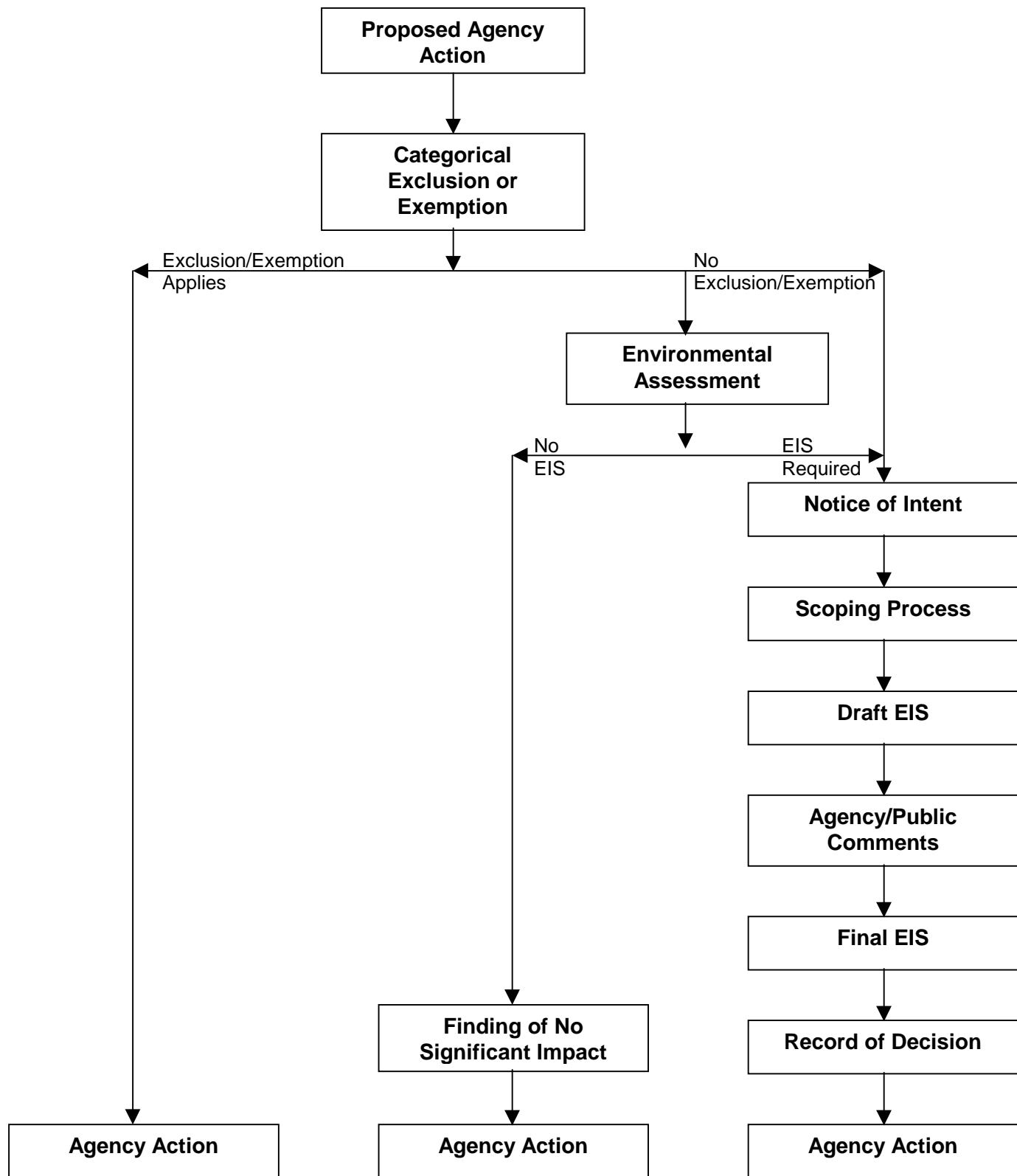

Figure 2  
NEPA Environmental Review Process: An Overview

## **MINERALS MANAGEMENT SERVICE (MMS)**

The MMS is responsible for regulating oil and gas exploration and development operations on the Federal Outer Continental Shelf (OCS) which offshore California are those submerged lands located seaward of the three-mile State lands boundary. Regulations for oil and gas operations on the OCS are found in 30 Code of Federal Regulations (CFR) Part 250. The following is a summary of the MMS regulatory requirements pertaining to the decommissioning of OCS oil and gas facilities that are included in CFR 250 and the OCS lease instrument. Interested parties should refer to the regulations for additional detail.

### **OCS OIL AND GAS REGULATIONS (CFR 30 - 250)**

#### **Platform Removal and Location Clearance (250.143)**

- Structures are to be removed in a manner approved by the Regional Supervisor (RS) that ensures the location has been cleared of all obstructions to other activities in the area.
- All platforms (including casing, wellhead equipment, templates, and piling) shall be removed to a depth of at least 15 feet below the ocean floor or to a depth approved by the RS based upon the type of structure or ocean bottom conditions.
- The lessee shall verify the location has been cleared of all obstructions.
- The results of a location clearance survey conducted by the company performing the work shall be submitted to the RS.
- The company performing the work shall submit a letter to the RS certifying the area was cleared of all obstructions, the date the work was performed, the extent of the area surveyed, and the survey method used.

#### **Permanent Abandonment of Wells (250.110, 250.111, 250.112, 250.114)**

- All well sites shall be cleared in a manner so as to avoid conflict with other uses of the OCS.
- The lessee shall not initiate abandonment operations without the prior approval of the District Supervisor (DS).
- The lessee must submit a request to abandon a well on Form MMS-124, Sundry Notices and Reports on Wells, to the DS for approval, and submit a subsequent report on abandonment describing procedures and results within 30 days of completion of the work.
- Form MMS-124 shall specify the date the work is to be performed, the extent of the area to be searched around the location, and the search method utilized.
- All wellheads, casings, pilings, and other obstructions shall be removed to a depth of at least 15 feet below the mud line or to a depth approved by the DS.
- The lessee shall verify that the location has been cleared of all obstructions.
- The requirements for removing subsea wellheads or obstructions or for verifying location clearance may be reduced or eliminated if the DS determines the wellheads or other obstructions do not constitute a hazard to other uses of the seafloor or other legitimate uses of the area.
- The lessee shall verify site clearance after abandonment by one or more of the following methods as approved by the DS:

- (1) Drag trawl in two directions across the location.
  - (2) Perform a diver search around the wellbore.
  - (3) Scan across the location with a side-scan or on-bottom scanning sonar, or
  - (4) Use other methods based on particular site conditions.
- The lessee shall submit certification the area was cleared of all obstructions, the date the work was performed, the extent of the area searched around the location, and the search method utilized on Form MMS-124.

#### **Temporary Abandonment of Wells (250.113)**

- Subsea wellheads, casing stubs, or other obstructions remaining after temporary abandonment above the seafloor shall be protected in such a manner as to allow commercial fisheries gear to pass over the structure without damage to the structure or fishing gear.
- Depending on water depth, nature and height of obstruction above the seafloor, and the types and periods of fishing activity in the area, the DS may waive this requirement.
- The lessee shall follow the requirements of the U.S. Coast Guard in identifying and reporting subsea well heads, casing stubs, or other obstructions extending above the mud line.

#### **Abandonment of DOI Pipelines (250.156)**

- A pipeline may be abandoned in place, if the RS determines it does not constitute a hazard to navigation, commercial fishing operations, or unduly interfere with other uses in the OCS.
- Pipelines abandoned in place shall be flushed, filled with seawater, cut, and plugged with the ends buried at least 3 feet

#### **General Requirements for a Pipeline Right-of-Way Grant (250.159 and 250.164)**

- The holder of a right-of-way grant shall submit an application for the relinquishment of the grant to the RS.
- A relinquishment shall be effective on the date it is filed subject to the satisfaction of all outstanding debts, fees, or fines and requirements
- Upon relinquishment, forfeiture, or cancellation of a right-of-way grant, the right-of-holder shall remove all platforms, structures, domes over valves, pipes, taps, and valves along the right-of-way.
- All of these improvements shall be removed by the holder within 1 year of the effective date of the relinquishment, forfeiture, or cancellation unless the requirement is waived in writing by the RS.
- All such improvements not removed within the time period provided herein shall become the property of the U.S., but that shall not relieve the holder of liability for the cost of their removal or for restoration of the site.

- The holder of the right-of-way grant is responsible for accidents or damages which might occur as a result of failure to remove improvements and equipment and restore a site.

### **Supplemental Regulations**

The requirements for specific offshore decommissioning activities, as outlined above, are supplemented by generic regulations of 30 CFR Part 250 that relate to the conduct of offshore decommissioning activities. These include:

- **250.3, Performance Requirements: Allows** the use of new or alternative techniques, procedures, equipment, or activities other than those prescribed if they afford a degree of protection, safety, or performance equal to or better than that intended to be achieved by the regulations.
- Also provides the MMS the flexibility to depart from the operating requirements of the regulations of this part when such departures are necessary for ..... The conservation of natural resources, or the protection of life (including fish and other aquatic life), property, or the marine coastal, or human environment.
- **250.20, Safe and Workmanlike Operations:** Requires that all offshore operations be conducted and facilities maintained in a safe and workmanlike manner to a level consistent with the regulatory objectives.
- **250.22, Best Available and Safest Technologies:** The MMS requires that the best available and safest technologies (BAST) be used when practicable.

### **OCS LEASE INSTRUMENT**

#### **Removal of Property on Termination of Lease**

- Within a period of 1 year after termination of this lease in whole or in part, the lessee shall remove all devices, works, and structures from the premises no longer subject to the lease in accordance with applicable regulations and orders of the Director.
- The lessee may, with the approval of the Director, continue to maintain devices, works, and structures on the leased area for drilling or producing on other leases.

## NATIONAL MARINE FISHERIES SERVICE (NMFS)

The Protected Species Management Division (PSMD) of the NMFS is responsible for the management of protected marine species (i.e., marine mammals, sea turtles and winter-run chinook salmon) in the Southwest Region, under the provisions of the Endangered Species Act (ESA) and the Marine Mammal Protection Act (MMPA). The PSMD reviews NEPA and CEQA environmental documents prepared for projects that are likely to affect protected marine species. If a determination is made that a non-Federal action "may affect" protected marine species, alternatives will be recommended in order to insure that these species are not affected by the proposed project. In contrast, all Federal agencies are required to consult with the Secretary of Commerce/Interior, under Section 7(a)(2) of the ESA, to insure that any action it authorizes, funds, or carries out will not jeopardize the continued existence of any listed species or result in the destruction or adverse modification of critical habitat.

Informal Section 7 Consultation is initiated when a Federal agency or designated non-Federal representative provides to the NMFS Regional Director (for most protected marine species): (1) written request for a list of any "listed species" (including any proposed species, designated critical habitat, or proposed critical habitat) that may be present in the project area; or (2) written notification of the listed species that may be present in the project area. Within 30 days of the notification receipt of or request for a species list, the Regional Director shall concur or revise the list or advise the Federal agency in writing whether any listed species may be present in the project area. The Federal agency prepares within 90 days of receipt of the species list: (a) a biological assessment (BA) or (b) equivalent environmental impact statement (EIS) or environmental assessment (EA) that evaluates the effects of the proposed action on any listed species. Subsequently, the Federal agency submits the BA or equivalent document to the Regional Director for review (at the option of the Federal agency, Formal Section 7 Consultation could be initiated at this point). If the BA or equivalent document concludes that no listed species are present that are likely to be adversely affected by the action and the Regional Director concurs with this finding, the Regional Director will respond in writing within 30 days and conclude the consultation process. However, the Regional Director may request the Federal agency to initiate formal consultation if the BA or equivalent document concludes that listed species are present that are likely to be adversely affected by the action.

Formal Section 7 Consultation is initiated when a written request to initiate formal consultation is submitted to the NMFS Regional Director by the Federal agency. The NMFS (in the case of most protected marine species) will formulate a biological opinion (within 90 days of receipt of the request) which will include the NMFS's finding on whether the action is likely to jeopardize the continued existence of listed species or result in the destruction or adverse modification of critical habitat. If a "no jeopardy" biological opinion is issued; conservation recommendations to assist the Federal agency in reducing or eliminating impacts may be included. If a "jeopardy" biological opinion is issued; it will include reasonable and prudent alternatives (if any). An Incidental Take Statement will be included in the biological opinion if the NMFS determines that a Federal action will "take" listed species.

In addition to Section 7 requirements of the ESA, Federal and non-Federal actions that are likely to "take" listed or non-listed marine mammals must receive authorization under Section 101(a)(5) of the MMPA- Section 101(a)(5) provides a mechanism for allowing (upon request) the incidental taking of small numbers of marine mammals by U.S. citizens who engage in a specified activity other than commercial fishing. Incidental taking may be authorized for a period of up to five years as long as the taking has only a negligible impact on the species or stock. Regulations must be promulgated that set forth permissible methods of taking, monitoring, and reporting.

## U.S. ARMY CORPS OF ENGINEERS (COE)

### 33 CFR Part 320 - General Regulatory Policies

The COE has regulated certain activities in the nation's waterways since 1899. The regulatory jurisdiction of the COE includes all ocean and coastal waters within a zone three geographic (nautical) miles seaward of the baseline (territorial seas). In addition, wider zones are recognized for navigable waters of the United States for special regulatory powers exercised over the Outer Continental Shelf (OCS).

**Section 10 of the River and Harbor Act of 1899** - prohibits the unauthorized obstruction or alteration of any navigable water of the United States. The construction of any structure in or over any navigable water of the United States, the excavating from or depositing of material in such waters, or the accomplishment of other work is unlawful unless the work has been specifically authorized by the Corps of Engineers. The authority to prevent obstructions to navigation in navigable waters of the United States was extended to artificial islands, installations, and other devices located on the seabed, to the seaward limit of the OCS, by Section 4(f) of the OCS Act of 1953, as amended.

**Section 404 of the Clean Water Act** - prohibits the unauthorized discharge of dredged or fill material into waters of the United States. The selection and use of dredged disposal sites will be in accordance with the guidelines developed by the Environmental Protection Agency (EPA) Administrator in conjunction with the Secretary of the Army. The EPA Administrator can deny, prohibit, restrict or withdraw the use of any defined area as a disposal site whenever, if it is determined, that after notice and opportunity for public hearing and after consultation with the Secretary of the Army, that the discharge of such materials into such areas will have an unacceptable adverse effect on municipal water supplies, shellfish beds and fishery areas, wildlife, or recreational areas.

### Permits Issued

1. Individual Permits (33 CFR Part 325) - are processed through the public interest review procedures, public notice publication, and receipt of comments.
2. Letters of Permission (33 CFR 325.2(e)(1)) - are issued through an abbreviated processing procedure which includes coordination with Federal and state fish and wildlife agencies, public interest evaluation, but without publishing a public notice.
3. Nationwide Permits (33 CFR Part 330) - are general permits issued by the Chief of Engineers and are designed to regulate with little, if any, delay or paperwork, certain activities having minimal impacts.

### **U.S. FISH AND WILDLIFE SERVICE (FWS)**

The primary concern of the FWS is the protection of public fish and wildlife resources and their habitats. The FWS mandates require that it provide comments on any public notice issued for a Federal permit or license affecting the nation's waterways, in particular, U.S. Army Corps of Engineers' permits pursuant to Section 404 of the Clean Water Act and Section 10 of the Rivers and Harbors Act of 1899.

In addition, the FWS administers certain portions of the Endangered Species Act (ESA) of 1973, as amended. Section 9 of the ESA prohibits any taking of a listed species. The definition of "take" includes to harass, harm, hunt, shoot, wound, kill, trap, capture, or collect, or attempt to engage in any such conduct. A notable component of this definition is the definition of "harm." "'Harm' in the definition of 'take' in the ESA means an act which actually kills or injures wildlife. Such act may include significant habitat modification or degradation where it actually kills or injures wildlife by significantly impairing essential behavior patterns, including breeding, feeding, or sheltering (50 CFR 17.3)." Anyone who engages in a take would be subject to prosecution under Section 9 of the ESA. Such taking may occur only under the authority of the FWS through a permit pursuant to Section 7 or Section 10, as mandated in the ESA.

Section 7(a)(1) of the ESA requires all Federal agencies to use their authorities in furtherance of the purposes of the Act by carrying out programs for the conservation of endangered and threatened species. Section 7(a)(2) requires Federal agencies to review their proposed activities and determine whether listed species will be affected. Section 7(a)(4) requires Federal agencies to confer with the FWS on any agency action that is likely to jeopardize the continued existence of a proposed species. Information consultation or conference may be used to exchange information and resolve conflicts with respect to listed or proposed species prior to a written request for formal consultation or conference.

It is important to note that the FWS will confer on actions affecting Federally listed endangered or threatened species. The National Marine Fisheries Service takes the lead on all marine mammals (except sea otters, walrus, manatees/dugongs, and polar bears), including those that are Federally listed as endangered or threatened species.

## U.S. ENVIRONMENTAL PROTECTION AGENCY (EPA)

The EPA's role in the Clean Water Act (CWA) Programs which may affect decommissioning of OCS platforms, pipelines, and onshore facilities include:

### National Pollution Discharge Elimination System (NPDES) Permit Program

Section 301 (a) of the CWA requires an NPDES permit for discharges of pollutants from point sources to surface waters. The following discharges could accompany the decommissioning of OCS platforms, pipelines, or onshore facilities and, thereby, require an NPDES permit:

1. Discharges associated with the flushing of pipelines prior to removal or decommissioning in place.

NPDES permits for these discharges would include technology-related effluent limitations and any additional limits necessary to ensure compliance with the Ocean Discharge Criteria regulations (40 CFR 125, Subpart M). Permits for these discharges would have to consider the nature of the discharges and the pollutants that might be present. Permits issued in Federal waters (3 miles from the coast and beyond) are issued by the EPA, while those in state waters or onshore are issued by the California Regional Water Quality Control Boards (RWQCBs).

- 2) Storm water runoff from onshore facilities during dismantling (if 5 or more acres would be disturbed).

The 1987 Water Quality Act requires that NPDES permits be issued for storm water discharges associated with industrial activity. On November 16, 1990, the EPA promulgated final regulations (55 Fed. Reg. 47990) which set forth permit application requirements and also define the coverage of the program. These regulations require permits for construction activity (including dismantling) where 5 or more acres are disturbed. As such, storm water runoff occurring during the dismantling of onshore facilities could be subject to NPDES permitting. On August 20, 1992, the State of California issued a general NPDES permit for construction site runoff that would cover most storm water discharges associated with decommissioning of onshore facilities.

- 3) Miscellaneous discharges such as sanitary and domestic wastes that may occur from the platform during part of the decommissioning phase.

EPA-Region 9 has issued a general permit and individual permits for some platforms that authorize and set forth effluent limitations and monitoring requirements for the above discharges in Federal waters. Similar permits have been issued by the California RWQCBs for the same discharges in state waters.

### Section 404 Permits

Section 404 of the CWA requires permits for discharges of dredged or fill material into waters of the United States (excluding discharges more than 3 miles from the coast). Although the U.S. Army Corps of Engineers issues Section 404 permits; the EPA has an oversight role regarding the implementation of this permit program. Various Memorandum of Agreements (MOAs) have been developed between the EPA and U.S. Army Corps of Engineers regarding Section 404 permit review procedures. Platform or pipeline removal could require a Section 404 permit for backfilling operations. On December 24, 1980, the EPA adopted guidelines that set forth the procedures for evaluating proposed discharges and determining when permits may be granted.



## U.S. COAST GUARD (CG)

### 33 CFR Part 62 - United States Aids to Navigation System

The CG administers the United States Aids to Navigation System. The system consists of Federal aids to navigation operated by the CG, aids to navigation operated by the other armed services, and private aids to navigation operated by other persons.

The CG maintains systems of marine aids to navigation consisting of visual, audible, and electronic signals that are designed to assist the prudent mariner in the process of navigation. The primary objective of the aids to navigation system is to mark navigable channels and waterways, and obstructions in areas of general navigation that may not be anticipated. Other waters, even if navigation, are generally not marked.

### 33 CFR Part 67 - Aids to Navigation on Artificial Islands and Fixed Structures

The regulations in this part prescribe the obstruction lights and fog signals to be operated as privately maintained maritime aids to navigation on artificial islands and structures which are erected on or over the seabed and subsoil of the Outer Continental Shelf and in the waters under the jurisdiction of the United States, for the purpose of exploring for, developing, removing and transporting resources therefrom.

"Structures" include all fixed structures, temporary or permanent, for which a Corps of Engineers' permit is issued. It shall include, but is not necessarily limited to, all drilling platforms, production platforms, quarters platforms, pipe line riser platforms, manifold platforms, loading platforms, boat landings, caissons, well protective structures, tank battery barges submerged on station, drilling barges submerged on location, artificial islands and all other piles, pile clusters, pipes, or structures erected in the waters.

### 33 CFR Part 153 - Control of Pollution by Oil and Hazardous Substances and Discharge Removal

This part concerns notification to the CG of the discharge of oil or hazardous substances as required by the Federal Water Pollution Control Act (FWPCA), as amended; the procedures for the removal of a discharge of oil; and the costs that may be imposed or reimbursed for the removal of a discharge of oil or hazardous substances under the FWPCA. Chief, Office of Marine Safety, Security and Environmental Protection is the CG Officer designated by the Commandant to assist and advise the Commandant on matters related to marine environmental response, port and environmental safety, and waterways management.

### Oil Pollution Act (OPA) of 1990

OPA has new provisions for oil liability; prevention; preparedness and cleanup pertaining to vessels, offshore oil and gas facilities, onshore terminals, and other petroleum industries. Major provisions of the law include: (1) oil pollution liability and compensation; (2) prevention and removal of oil pollution; (3) oil pollution research and development program; and (4) amendments to the oil spill liability trust fund. The U.S. USCG has greater responsibility to direct oil spill cleanups.

**U.S. DEPARTMENT OF TRANSPORTATION  
OFFICE OF PIPELINE SAFETY (OPS)**

OPS is a part of the Research and Special Programs Administration, U.S. Department of Transportation. OPS has regulatory authority over pipeline safety under the (1) Natural Gas Pipeline Safety Act of 1988, as amended; (2) the Hazardous Liquid Pipeline Safety Act of 1979; and (3) the Hazardous Materials Transportation Act, as amended, OPS regulations are in 49 of the Code of Federal Regulations (CFR). 49 CFR Part 192 - Transportation of Natural and Other Gas By Pipeline: Minimum Federal Standards and 49 CFR Part 195 Transportation of Hazardous Liquids By Pipeline are the two major sections governing pipeline safety.

**49 CFR 192.727 Abandonment or Inactivation of Facilities**

- a) Each operator will provide an operating and maintenance plan for abandonment or deactivation of pipelines.
- b) Each pipeline abandoned in place must be disconnected from all sources and supplies of gas; purged of gas; in the case of offshore pipelines; filled with water or inert materials; and sealed at the ends. The pipeline need not be purged when the volume of gas is so small that there is no potential hazard.
- c) Except for service lines, each inactive pipeline that is not maintained must be disconnected from all sources and supplies of gas; purged of gas; in the case of offshore pipelines; filled with water or inert materials; and sealed at the ends. The pipeline need not be purged when the volume of gas is so small that there is no potential hazard.

**California Environmental Quality Act (CEQA)**

**and**

**Major State and Local Agencies with Regulatory Authorities  
for Decommissioning of  
Offshore and Onshore Oil and Gas Facilities**

## **CALIFORNIA ENVIRONMENTAL QUALITY ACT (CEQA)**

CEQA was enacted in 1970 in response to growing concern over environmental protection and has four basic purposes: to inform the public and governmental decision-makers of potential environmental effects of proposed activities; to identify ways to reduce or avoid environmental damage; to prevent damage by requiring changes in projects through alternative projects and/or mitigation measures; and to make the public aware if an approved project will have significant environmental effects. CEQA regulations are found in the Public Resources Code, Section 21000, et seq.) and the CEQA Guidelines (California Code Regulations, Title 14, Section 15000, et seq.).

Any activity proposed, funded, or permitted by a state or local public agency which has the potential for resulting in a physical change in the environment, is considered a "project" by CEQA- Unless a project is statutorily or categorically exempt from CEQA review, either a Negative Declaration (ND) or Environmental Impact Report (EIR) must be prepared to assess potential impacts to the environment. Generally, an EIR is required if a project (individually or cumulatively) has a significant effect on the environment. If there is no substantial evidence that a project may cause a significant effect on the environment, then an ND may be prepared (See Figure 3).

Very clearly, CEQA has a profound effect on applications for all types of proposed activities. Most public agencies have devised internal policies, systems, and environmental management divisions to maintain responsibilities as required by CEQA.

CEQA is continuously modified and interpreted by legislation and court decisions that reflect environmental changes and concerns of public agencies, developers, special interest groups and the general public.

### **Mitigation Monitoring (Public Resources Code, Section 21081.6)**

Legislation adding this section to CEQA was enacted in 1988 to assure that mitigation measures imposed in an environmental document are monitored for proper compliance and to analyze the effectiveness of the measures. A public agency must adopt a reporting and monitoring program whenever it makes a finding relative to mitigating or avoiding significant environmental effects of a project. This program puts "teeth" in the CEQA process by causing public agencies to monitor projects they have approved so that specified mitigation measures are not ignored, avoided, or modified.

### **Phases in the CEQA Environmental Review Process**

Normally, the CEQA process entails three separate phases. The first phase consists of preliminary review of a project to determine whether it is subject to CEQA. The second phase involves preparation of an Initial Study to determine whether the project may have a significant environmental effect and the preparation of a ND if no significant effects will occur. The third phase is the preparation of an EIR if the project may have a significant environmental effect (CEQA Guidelines Sec. 15002(k)).

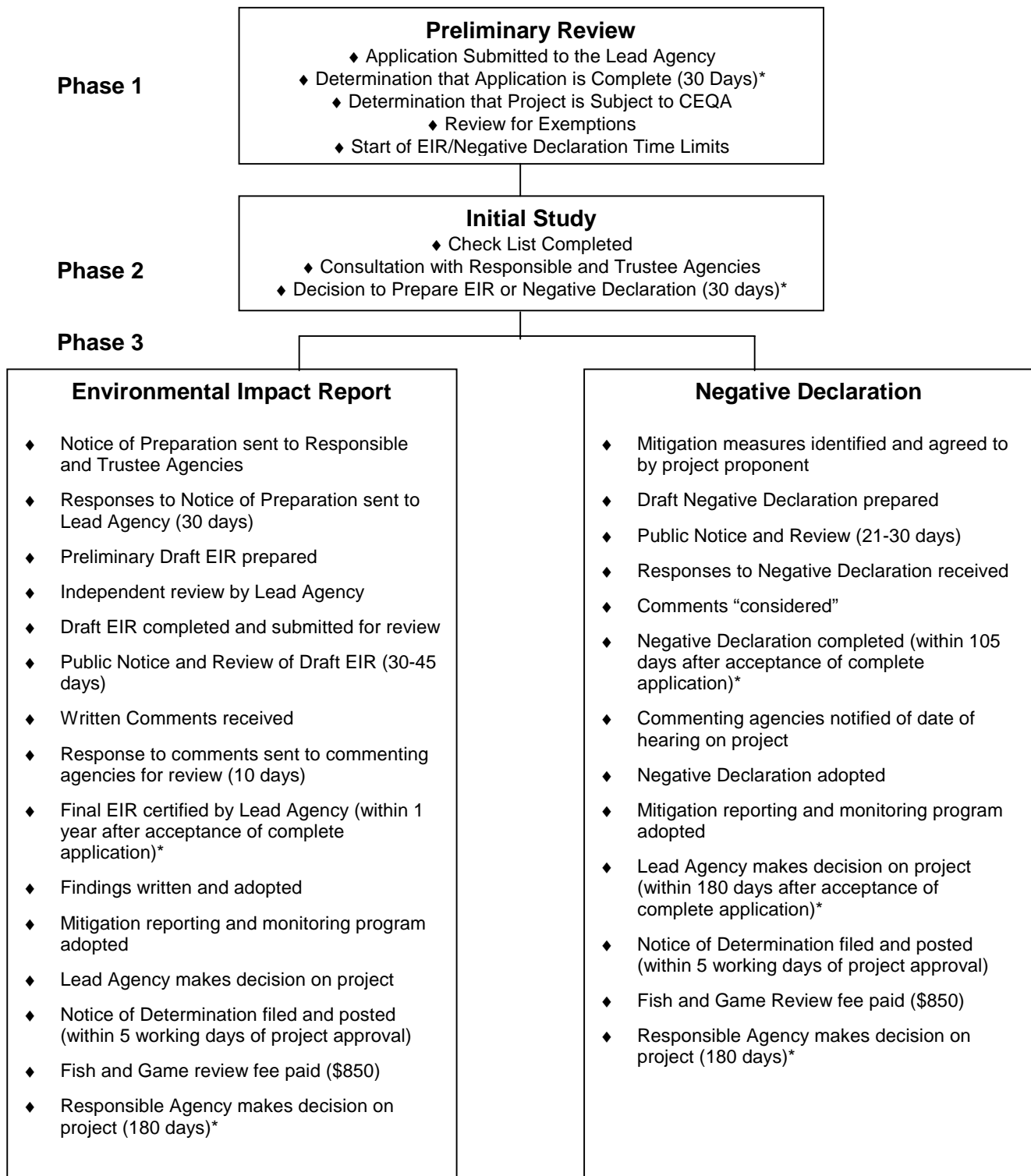

\*Applicable only to projects subject to the Permit Streamlining Act

**Figure 3. Steps in the Environmental Review Process under CEQA**

## CALIFORNIA STATE LANDS COMMISSION (SLC)

The SLC is responsible for the management of extractive development of mineral resources located on State lands. The public lands under the SLC's jurisdiction include sovereign and school lands. Oil and gas development has primarily been concentrated on those sovereign tide and submerged lands adjacent to the coast and out three nautical miles offshore southern California.

Division 6 of the Public Resources Code (PRC) provides the statutory framework for the Commission's responsibilities. The statutory requirements are implemented through Title 2 of the California Code of Regulations. To carry out these responsibilities, SLC staff provides land management, resource management, and engineering oversight services for all marine facilities in state waters pursuant to leases issued by the SLC. These activities include all oil and gas drilling and production facilities. The oversight responsibilities extend from the construction and development stages of a project, through its operational life and decommissioning and abandonment phases.

The following is a brief summary of the principal SLC statutory and regulatory requirements pertaining to decommissioning of offshore oil and gas facilities.

### General:

**Section 6216.1 (PRC)** authorizes the Commission to remove or cause to be removed any manmade structures or obstructions from ungranted lands under its jurisdiction if the Commission determines that such removal is appropriate and the Attorney General advises that there is no legal recourse to compel other responsible parties to effect such removal.

**Section 6819 (PRC)** directs the Commission to promulgate rules and regulations to require any person extracting oil or gas or other minerals from lands under the jurisdiction of the Commission to remove beach and underwater obstructions.

**Section 6829 (PRC)** requires every oil and gas lease executed by the Commission to contain provisions specifying methods of operation and standard requirements for carrying on operations in proper and workmanlike manner; the prevention of waste; the protection of safety and health of workmen; and the liability of the lessee for personal injuries and property damage.

**Section 8755 (PRC)** requires the Commission to adopt rules, regulations, and guidelines, and Commission leasing policies governing the operation of all marine terminals within the state, and all marine facilities under lease from the Commission to minimize the possibilities of a discharge of oil.

**Section 8756 (PRC)** requires periodic review of these regulations to ensure that all operators of marine terminals within the state and marine facilities under the Commission's jurisdiction always provide the best achievable protection of the public health and safety and the environment.

**Section 2125 et. Seq. (CCR)** provide specific requirements for oil and gas drilling, production, and pollution control, including the requirements that all operations be carried on in accordance with accepted good oilfield practice, that prevents and eliminates pollution and assures protection of human health and safety. In addition, the regulations require submission and Staff approval of Oil Spill Contingency Plans and Critical Operations and Curtailment Plans.

### Wells:

**Section 2128(q) (CCR)** provides for plugging and abandonment of wells. This section addresses the design, placement, and testing of cement plugs pumped into the wellbore to isolate hydrocarbon zones and prevent future leakage. Minimum requirements are specified for isolation of cased and uncased hole, plugging of perforated intervals, isolation of zones behind cemented

or uncemented casing, junk in hole or collapsed casing, plugging of casing stubs, plugging of annular spaces, surface plugs, and surface clearance. Written Staff approval of individual well abandonment programs is required prior to commencement of rig operations.

**Platforms and Pipelines:**

**Section 2122 (CCR)**, Lease Operations Offshore, requires timely removal of structures or facilities used for the drilling of wells that are no longer operative.

**Section 2123 (CCR)**, Lease Operations on Uplands, specifies similar requirements for onshore facilities used to drill offshore.

**Section 2124 (CCR)**, Surrender of Leased Premises, requires that upon expiration of a lease, the lessee must surrender the lease with permanent improvements in good order and condition or, at the option of the Commission, to remove all structures and facilities as specified by the Commission.

### CALIFORNIA COASTAL COMMISSION (CCC)

The California Coastal Act of 1976 (Public Resources Code Section 30000 et seq.), the foundation of the Federally approved California Coastal Management Plan (CCMP), was enacted by the State Legislature to provide for the conservation and development of the State's 1,100-mile coastline. Under the Coastal Act and the CCMP, the Commission must consider the impacts of removal and abandonment activities on resources and uses within the coastal zone. Although removal and abandonment projects generally have overall environmental benefits, specific activities including vessel operations and equipment use (e.g., the equipment proposed to cut a platform's legs prior to platform removal) can potentially cause adverse impacts to marine resources, sensitive species and habitats, water quality (both from project-related operations and upset events such as an oil spill), air quality, commercial and recreational fishing, other recreational opportunities such as surfing and boating, cultural resources, aesthetics, and access.<sup>1</sup>

With regard to the removal or decommissioning of offshore oil and gas structures, Coastal Act Section 30106 includes under the definition of "development" the following: "... on land, in or under water, the ... change in the [intensity of use of land and water, and]; ... demolition, or alteration of the size of any structure..... Section 30600(a) states in part: "... any person wishing to perform or undertake any development in the coastal zone ... shall obtain a coastal development permit." Consequently, most removal and decommissioning activities occurring within the coastal zone including state waters will require a coastal development permit (CDP).

In addition, the Federal Coastal Zone Management Act (CZMA) and the regulations of the Secretary of Commerce give the Commission authority to review Federally licensed or permitted activities "in or outside of the coastal zone affecting any land or water use or natural resource of the coastal zone" to assure that such activities are conducted in a manner consistent with the enforceable policies of the CCMP. (See CZMA Section 307(c)3(A) and (B); 15 CFR 930.50 and 930.70). The Commission may also review renewals and major amendments of Federally licensed or permitted activities (15 CFR 93051(b)). For example, the MMS requires in its leases and in an operator's Development and Production Plan (DPP) that the operator provide for the abandonment of wells, removal or decommissioning of platforms and pipelines, and clearance of the project site of all obstructions to other activities in the area (30 CFR Sections 250.100-4; 250-143; and 250-156.) Although an decommissioning plan may be included in a DPP, the DPP and Environmental Impact Report/Statement (EIR/S) may not address specific removal and decommissioning activities and associated environmental impacts in sufficient detail for the Commission to make a complete assessment of the impacts of these activities to the coastal zone. Therefore, the Commission typically reviews the abandonment phase of a project separately from the development phase.

---

<sup>1</sup> Coastal Act Chapter 3 policies that may be pertinent to the Commission's review of removal and decommissioning projects address marine resources and environmentally sensitive habitat areas (Section 30230, 30231 and 30240), oil spills (Section 30232), air quality (Section 30253(3)), commercial and recreational Fishing (Section 30234.5), recreation (Section 30220), cultural resources (Section 30244), visual quality (Section 30251), public access (Section 30211), and cumulative effects (Section 30250).



### **CALIFORNIA DEPARTMENT OF FISH AND GAME (CDF&G)**

The CDF&G's participation in offshore oil and gas development and decommissioning process is primarily as a review and commenting agency. The CDF&G reviews NEPA and CEQA documents with respect to fish and wildlife resource and habitat impacts resulting from project implementation. Specifically, the CDF&G reviews Federal permit actions under the authority of the Fish and Wildlife Coordination Act. These include permits from the U.S. Army Corps of Engineers, U.S. Coast Guard, and other Federal permits.

In addition, the CDF&G reviews proposed state permits issued by State Lands Commission and Regional Water Quality Control Board (NPDES permits) and provides comments and recommendations for project modification as well as mitigation measures and permit conditions to offset or eliminate resource and habitat losses which would result from project implementation.

A permit for the use of explosives in state waters is required pursuant to Fish and Game Code Section 5500.

### **CALIFORNIA DIVISION OF OIL, GAS, AND GEOTHERMAL RESOURCES (DOGGR)**

The California Department of Conservation's DOGGR is responsible for supervising the drilling, operation, maintenance, and abandonment of wells throughout the State, including those wells within the territorial seas. The Division enforces statutes in Division 3 of the Public Resources Code and regulations in Title 14 of the California Code of Regulations. Division staff in district offices evaluates operator well applications on engineering and geologic bases and issue permits to conduct well operations.

General plugging and abandonment regulations require the well bores to be plugged with cement across various intervals, including the oil- and gas-producing zones, casing stubs and shoes, and at the surface. Furthermore, any intervals not plugged with cement must be filled with drilling mud of sufficient density to control subsurface zone pressures. All operations must be carried out following good oil field practices and with appropriate safety equipment installed. In addition, Division inspectors conduct onsite verification of many of the operator's procedures to plug and abandon wells.

**CALIFORNIA STATE FIRE MARSHAL  
HAZARDOUS LIQUID PIPELINE SAFETY DIVISION**

The Hazardous Liquid Pipeline Safety Act of 1979 had vested upon the Federal Government jurisdiction over all hazardous liquid pipelines (both interstate and intrastate). However, the California State Fire Marshal entered into a certification agreement with the U.S. Department of Transportation (DOT) and was granted jurisdiction over intrastate hazardous liquid or carbon dioxide pipelines which it now exercises. Also, under the certification, the Hazardous Liquid Pipeline Safety Division of the California State Fire Marshal acts as an agent for the DOT as it relates to interstate pipelines.

The Division's mission is to ensure the safety of the citizens of California and to protect its environment as it relates to potential hazards created by jurisdictional hazardous liquid or carbon dioxide pipelines. The Division regulates all interstate and intrastate hazardous liquid pipelines in California, including, pipelines emanating from offshore oil and gas platforms that cross state boundaries. The Division inspects and evaluates pipeline operator's facilities, written procedures and records for compliance with Federal (49 CFR Part 195) and state (California Government Code/ Chapter 5.5 Sections 51010 through 51019) pipeline safety laws and regulations. All spills, ruptures, fires or similar incidents are responded to immediately and such accidents are investigated for cause. In addition, hazardous liquid pipelines are periodically tested for integrity using approved Division procedures.

## LOCAL PLANNING AND RESOURCE MANAGEMENT DEPARTMENTS

The County of Santa Barbara Planning and Development Department submitted the summary below. Other California counties would expect similar regulatory requirements for the decommissioning of oil and gas facilities in Federal and State waters.

Virtually all remaining offshore oil and gas development facilities in Southern California have onshore facility components associated with them. Federal and State environmental review and permitting laws consider decommissioning and removal activities to be “development” and when the potential environmental impacts of development are evaluated, these laws require that the “whole of the project” be considered. Therefore, the County believes that when offshore facilities are proposed for decommissioning, that the related onshore facilities must be considered as part of the environmental review process even if the operator is not immediately planning to abandon the facilities. An environmental analysis that only consider the offshore impacts of an offshore decommissioning project that also has onshore facilities does not meet the legal requirements of environmental review and permitting. (Conversely, the same would hold true for an onshore decommissioning proposal that has offshore components that aren’t analyzed).

On most occasions, offshore decommissioning projects also have onshore staging areas that are necessary to support the offshore activities. When pipelines are proposed to be removed from the shallow subtidal region, the proposed removal will include some onshore pieces of pipeline above the mean high tide line. In both cases, local agencies will typically have permits to issue and any environmental analyses must include the impacts from the onshore activities.

Even if there were no legal need to include the onshore impacts from offshore facilities decommissioning efforts, coordination with the County and other local governments ensures that the levels of review are consistent and that issues important to local governments are addressed. Local citizens and various businesses, such as tourism and commercial fishing, consider local governments responsible for preventing impacts to their businesses from offshore oil and gas activities, including facility decommissioning.

When an operator ultimately decides to decommission and abandon onshore facilities that supported offshore oil and gas development, the County has clear permit authority. Virtually any form of demolition of existing facilities requires a permit. For those facilities in the “Coastal Zone” of the County, local governments who have approved local coastal programs issue permits for abandonment. The locally approved coastal permits for decommissioning activities can, in most cases, be appealed to the California Coastal Commission for further review. Outside of the Coastal Zone, permits are approved solely by a local government and are not appealable to the Coastal Commission. Where an operator has an existing permit to operate that also includes a condition or other requirement to abandon the facility; the County may be able to amend the permit to allow the specific abandonment project. Otherwise, permits may range from ministerial permits approved by staff for simple abandonment efforts to more complex discretionary permits approved by the Planning Commission and/or Board of Supervisors. In all cases, permits require that adequate environmental review be completed. That can range from simple exemptions to more complex environmental impact reports.

## LOCAL AIR POLLUTION CONTROL DISTRICTS (APCDs)

The following overview was provided by Santa Barbara County APCD. Similar requirements are expected for other County's. Offshore decommissioning plans submitted to the appropriate regulatory agency (e.g., Minerals Management Service and California State Lands Commission) are reviewed by the local APCD for compliance with APCD rules and regulations and the applicant's existing permit requirements.

Permits or permit modifications are required in Santa Barbara County for decommissioning and abandonment project. Such permits are usually done as a consolidated Authority to Construct/Permit to Operate (ATC/PTO). CEQA review is also performed during the permit processing to assess the permit air quality impacts. Significant issues to be addressed for any decommissioning project during the environmental review phase includes the analysis of potential impacts to air quality and feasible measures that may be used to reduce and or eliminate any air quality impacts. The primary purpose of defining significant issues is to identify, document and plan for the environmental and safety requirements that will need to be addressed during the pre-abandonment, abandonment, and the post-abandonment phases of a project.

The criteria used to determine the significance of air quality impacts are based on federal, state, and local air pollution rules and regulations. Air quality impacts are normally determined by estimating the net change in ambient pollution concentrations caused by the project. Baseline air quality is established using existing data from state and local air monitoring (SLAM) stations and prevention of significant deterioration (PSD) stations. To evaluate the significance of impacts pursuant to CEQA, emission increases from the project are compared to specific emission thresholds that define the significance of potential air quality impacts. Major sources of air emissions from decommissioning projects include, but are not limited to, derrick barges, support vessels such as tug boats, crew and supply boats, multiple diesel powered internal combustion equipment, and chemical solvent usage.

Project information and emission calculations are used to determine the permit requirements, applicability and compliance status of the project.

The potentially applicable requirements include:

- The standards promulgated in the State and Federal Implementation Plans (SIP and FIP);
- The National and State Ambient Air Quality Standards (AAQS);
- New Source Review (NSR) and Prevention of Significant Deterioration (PSD) Rules;
- Other requirements of the 1990 Clean Air Act Amendments (CAAA);
- OCS Regulations;
- Air Quality Attainment Plans (AQAP), and;
- Local prohibitory rules.

Large scale projects often result in emissions that exceed established significance thresholds and therefore require mitigation measures that reduce these emission levels. Emissions associated with decommissioning activities have been mitigated on previous projects through the use of Best Available Control Technology (BACT) and emissions offsets.

Assembly Bill Number 3047 (Olberg Act, 1996) which has been recently enacted prohibits any air district from requiring emission offsets from abandonment activities. It should be noted that this Bill has yet to be tested. Furthermore, some recent development projects have existing agreements with the local APCD that offsets the entire project through abandonment. In some areas including Ventura County, there is a community bank of emissions offsets that may be available for decommissioning projects.

In order to reduce emissions during the abandonment, best available control technology (BACT) and/or reasonably available control technology (RACT) may be applied to emitting equipment to reduce air emissions. Currently, the thresholds for requiring controls are based on project daily emissions. Depending on the type of equipment, different control technologies can be applied. For internal combustion equipment, the most likely controls would consist of turbo charge units, inter/after cooling, timing retard, different injector types, low sulfur fuel, and reduced operations (equipment shutdown when not in use).

---

---

## APPENDIX II

---

Platform Schematic .....	223
California Offshore Oil & Gas Facilities .....	224
Onshore Decommissioning Decision Tree .....	228
Offshore Decommissioning Decision Tree .....	229





## PLATFORM SCHEMATIC

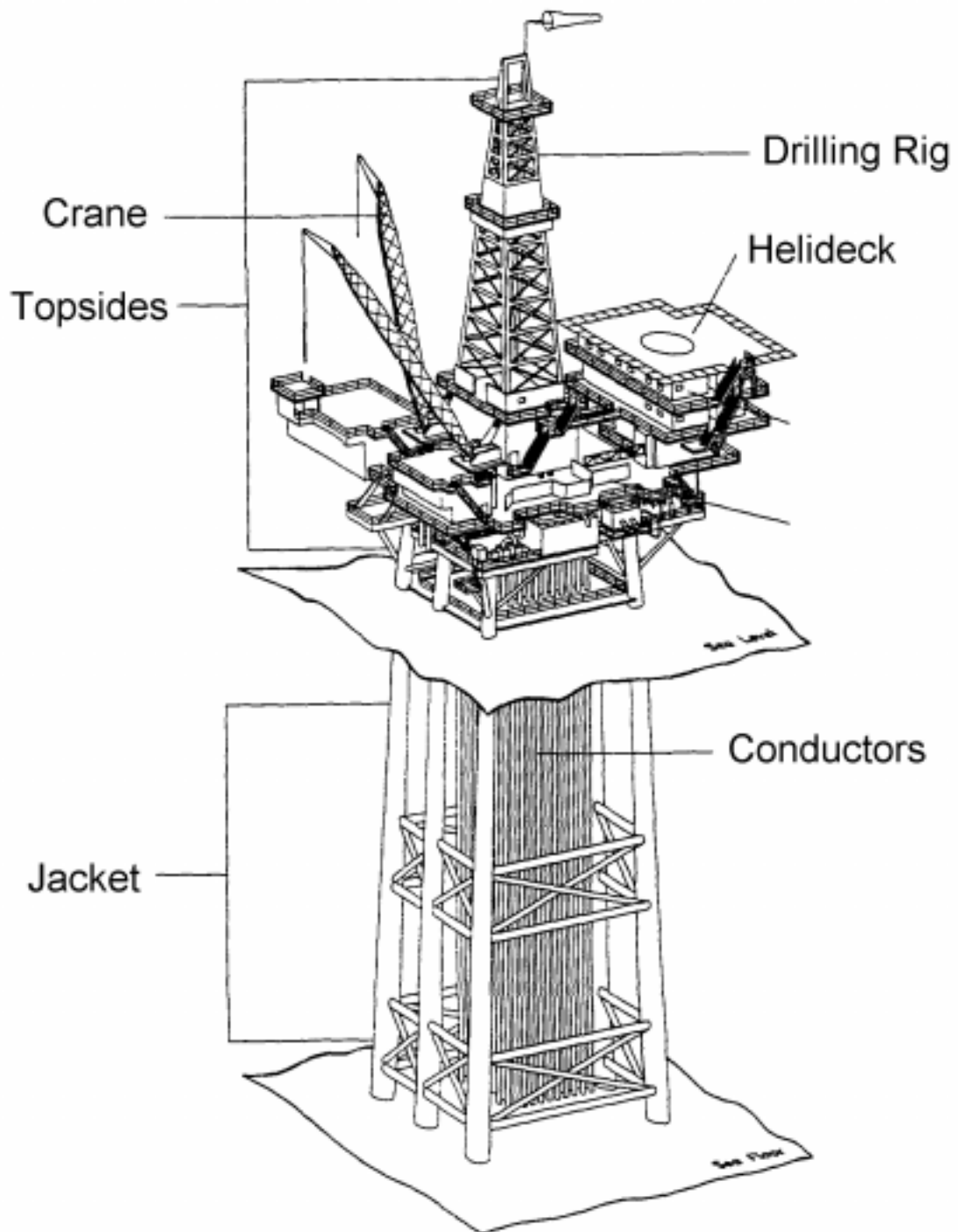

Source: MMS, Pacific OCS Region

## CALIFORNIA OFFSHORE OIL AND GAS FACILITIES PLATFORMS LOCATED IN FEDERAL WATERS, PACIFIC OCS REGION

Facility Name	Operator	Lease	Land distance miles	Water Depth (feet)	Installation Date	No. Slots	Initial Spud	First Production Date	Field/Unit	X	Y	Longitude W	Latitude N
Hogan	Pacific Operators	0166	3.7	154	09/01/67	66	04/29/68	06-10-68	Carpinteria	1,006,354	805,646	119 32 29.35	34 20 15.63
Houchin	Pacific Operators	0166	4.1	163	07/01/68	60	01/30/69	04/28/69	Carpinteria	1,003,115	804,772	119 33 7.62	34 20 5.97
Heritage	Exxon	0182	8.2	1075	10/07/89	60	09/03/93	12/18/93	Pescado/Santa Ynez	783,935	818,089	120 16 45.06	34 21 1.41
Hondo	Exxon	0188	5.1	842	06/23/76	28	09/15/77	04/02/81	Hondo/Santa Ynez	832,341	830,947	120 7 13.91	34 23 26.63
Harmony	Exxon	0190	6.4	1198	06/21/89	60	07/23/93	12/30/93	Hondo/Santa Ynez	817,978	826,364	120 10 3.09	34 22 36.03
Gina	Nuevo	0202	3.7	95	12/11/80	15	10/27/81	02/11/82	Hueneme/Pt. Hueneme	1,084,073	723,121	119 16 34.53	34 7 2.99
Gail	Chevron	0205	9.9	739	04/05/87	36	06/16/88	08/08/88	Sockeye/Santa Clara	1,046,650	726,990	119 24 0.78	34 7 30.29
Gilda	Nuevo	0216	8.8	205	10/08/81	96	10/20/81	12/19/81	Santa Clara/Santa Clara	1,041,733	747,989	119 25 6.83	34 10 56.43
Grace	Chevron	0217	10.5	318	07/30/79	48	01/19/80	07/25/80	Santa Clara/Santa Clara	1,026,807	747,437	119 28 4.18	34 10 46.46
Habitat	Nuevo	0234	7.8	290	100/8/81	24	01/16/82	12/15/83	Pitas Point/Pitas Point	991,694	787,520	119 35 17.14	34 17 11.82
Henry	Nuevo	0240	4.3	173	08/31/79	24	02/08/80	05/15/80	Carpinteria	1,000,596	804,219	119 33 37.43	34 19 59.72
Hillhouse	Nuevo	0240	5.5	190	11/26/69	60	05/25/70	07/21/70	Dos Cuadras	987,642	803,937	119 36 11.69	34 19 52.84
A	Nuevo	0241	5.8	188	09/14/68	57	11/19/68	03/03/69	Dos Cuadras	984,865	804,224	119 36 44.89	34 19 54.79
B	Nuevo	0241	5.7	190	11/08/68	63	06/23/69	07/19/69	Dos Cuadras	982,134	804,478	119 37 17.53	34 19 56.43
C	Nuevo	0241	5.7	192	02/28/77	60	07/09/77	08/01/77	Dos Cuadras	979,355	804,781	119 37 50.76	34 19 58.53
Edith	Nuevo	0296	8.5	161	01/12/83	72	11/05/83	01/21/84	Beta/Beta	1,424,274	525,198	118 8 26.47	33 35 44.83
Ellen	CalResources	0300	8.6	265	01/15/80	80	08/09/80	01/13/81	Beta/Beta	1,427,981	520,247	118 7 41.60	33 34 56.52
Elly	CalResources	0300	8.6	255	03/12/80	n/a	n/a	n/a	Beta/Beta	1,428,333	520,618	118 7 37.52	33 35 0.25
Eureka	CalResources	0301	9.0	700	07/08/84	60	12/29/84	03/17/85	Beta/Beta	1,431,431	513,421	118 6 59.38	33 33 49.61
Harvest	Chevron	0315	6.7	675	06/12/85	50	11/12/86	06/03/91	Pt. Arguello/Pt. Arguello	664,622	866,189	120 40 50.94	34 28 8.89
Hermosa	Chevron	0316	6.8	603	10/05/85	48	01/30/87	06/09/91	Pt. Arguello/Pt. Arguello	674,783	860,793	120 38 47.00	34 27 19.83
Irene*	Torch	0441	4.7	242	08/07/85	72	04/25/86	04/13/87	Pt. Pedernales/Pt. Ped.	708,195	3,831,989	120 43 45.94	34 36 37.51
Hidalgo*	Chevron	0450	5.9	430	07/02/86	56	11/27/87	05/27/91	Pt. Arguello/Pt. Arguello	710,975	3,819,245	120 42 8.24	34 29 42.05

\*Irene and Hidalgo are in UTM 10 (meters).

All others are Lambert Zone 6 (feet).

Source: MMS, Pacific OCS Region

## CALIFORNIA OFFSHORE OIL AND GAS FACILITIES STATE WATERS OFFSHORE FACILITIES

Facility Name	Operator	Location on State Lease #	Distance from Land (Nautical Miles)	Installation Date	Water Depth (feet)	Zone	Lamber Coordinate (feet)		Initial Spud	First Production Date	No. Slots	Present Status
							X	Y				
<b>Platform Emmy</b>	Aera Energy	PRC 425	1.2	1963	47	6	1,454,245E	548,870N	Mar-63	Apr-63	53	Producing
<b>Platform Eva</b>	Torch Operating	PRC3033	1.8	1964	57	6	1,448,916E	548,783N	Mar-64	Jan-66	39	Producing
<b>Platform Esther</b>	Torch Operating	PRC 3095	1.2	1985	35	6	1,433,450E	569,790N	n/a	Jul-95	64	Producing
<b>Platform Holly</b>	Venoco	PRC 3242	1.8	1966	211	5	897,722E	828,627N	Jul-65	Apr-66	30	Producing
<b>Belmont Island</b>	Exxon	PRC 186	1.3	1954	42	6	1,429,978E	570,927N	May-54	May-54	70	Process of Being Decommissioned
<b>Rincon Island</b>	Rincon Island Limited Partnership	PRC 1466	0.5	1958	45	6	1,035,710E	808,299N	Feb-60	Mar-60	68	Producing

Source: California State Lands Commission

Source: MMS, Pacific OCS Region

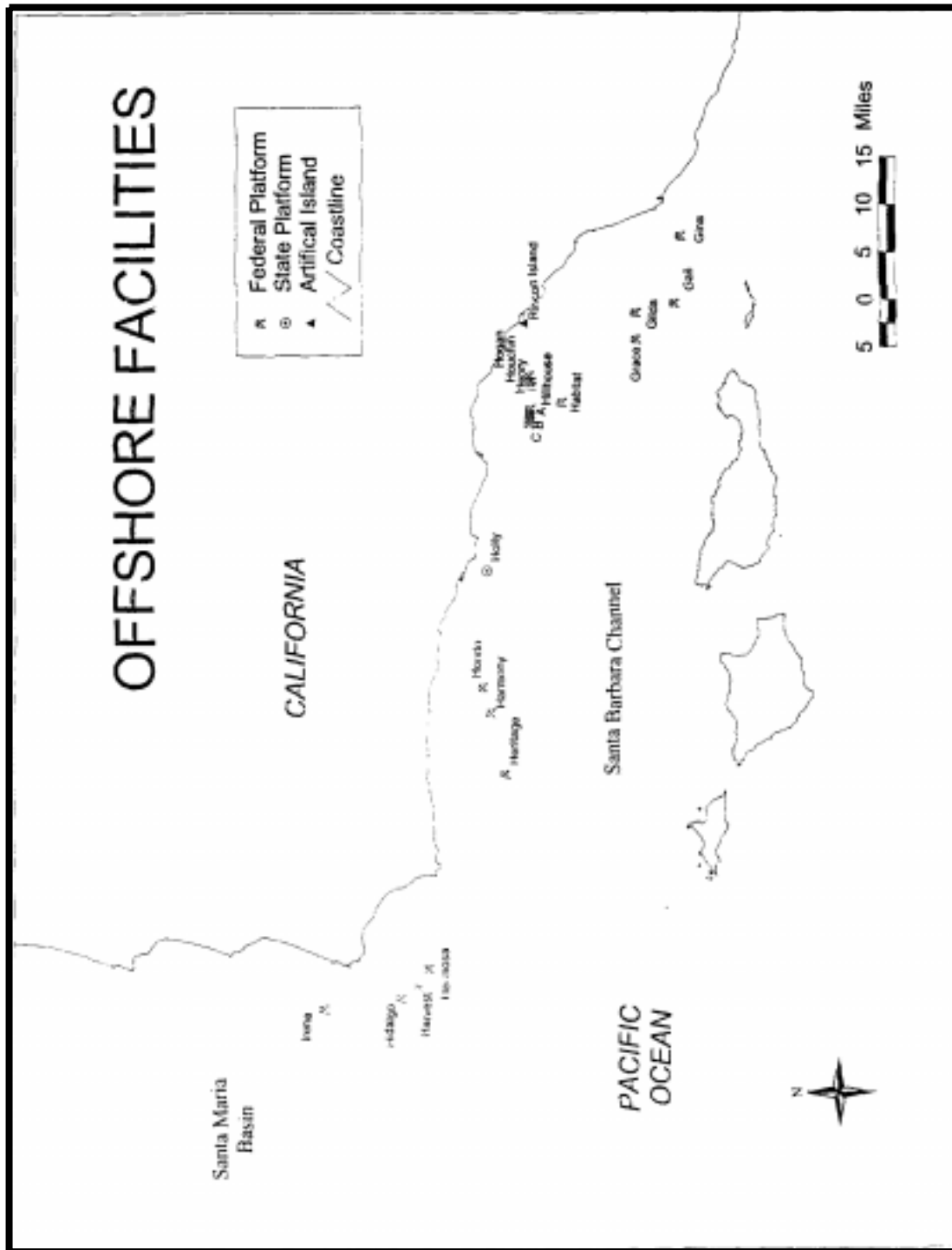

Source: MMS, Pacific OCS Region

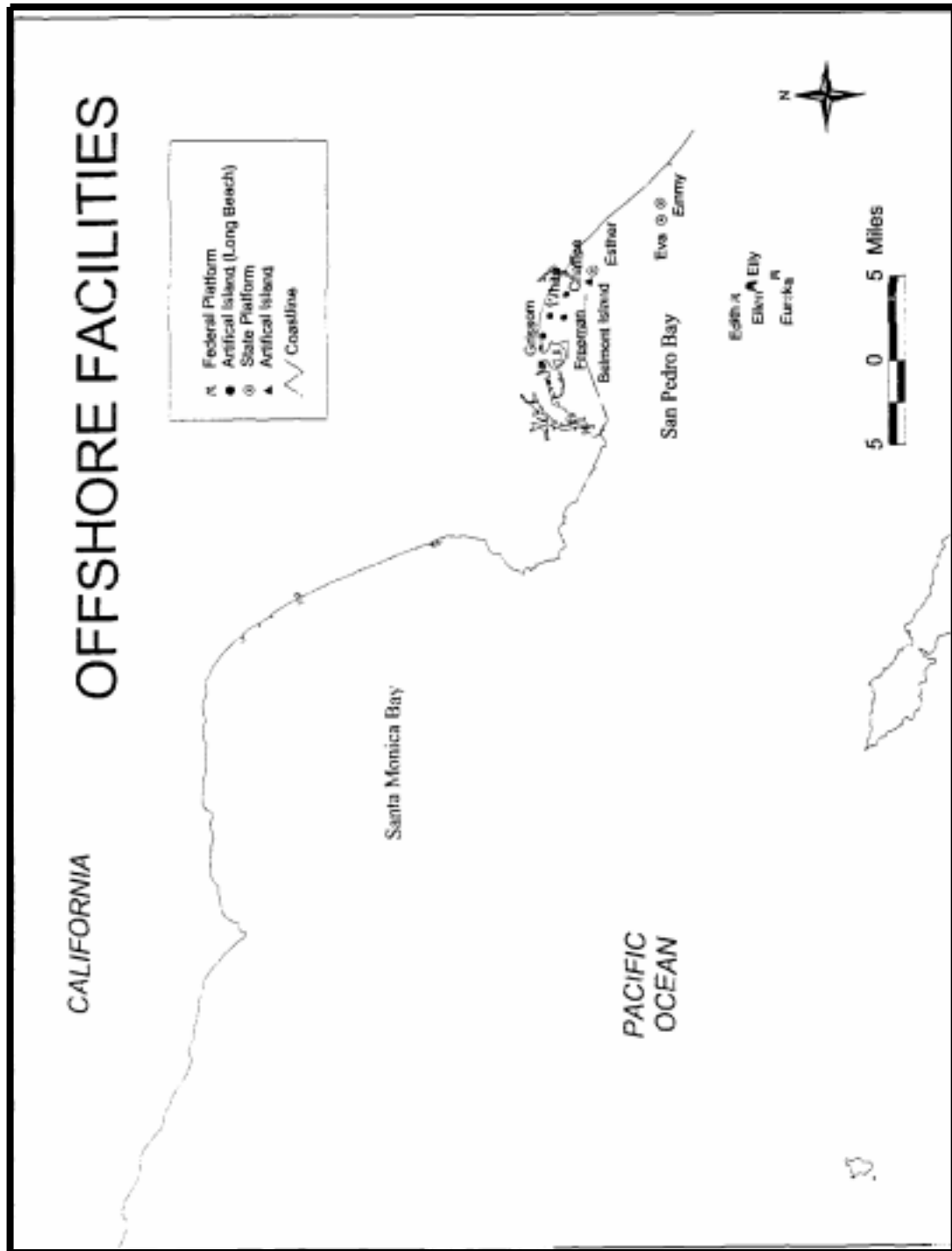

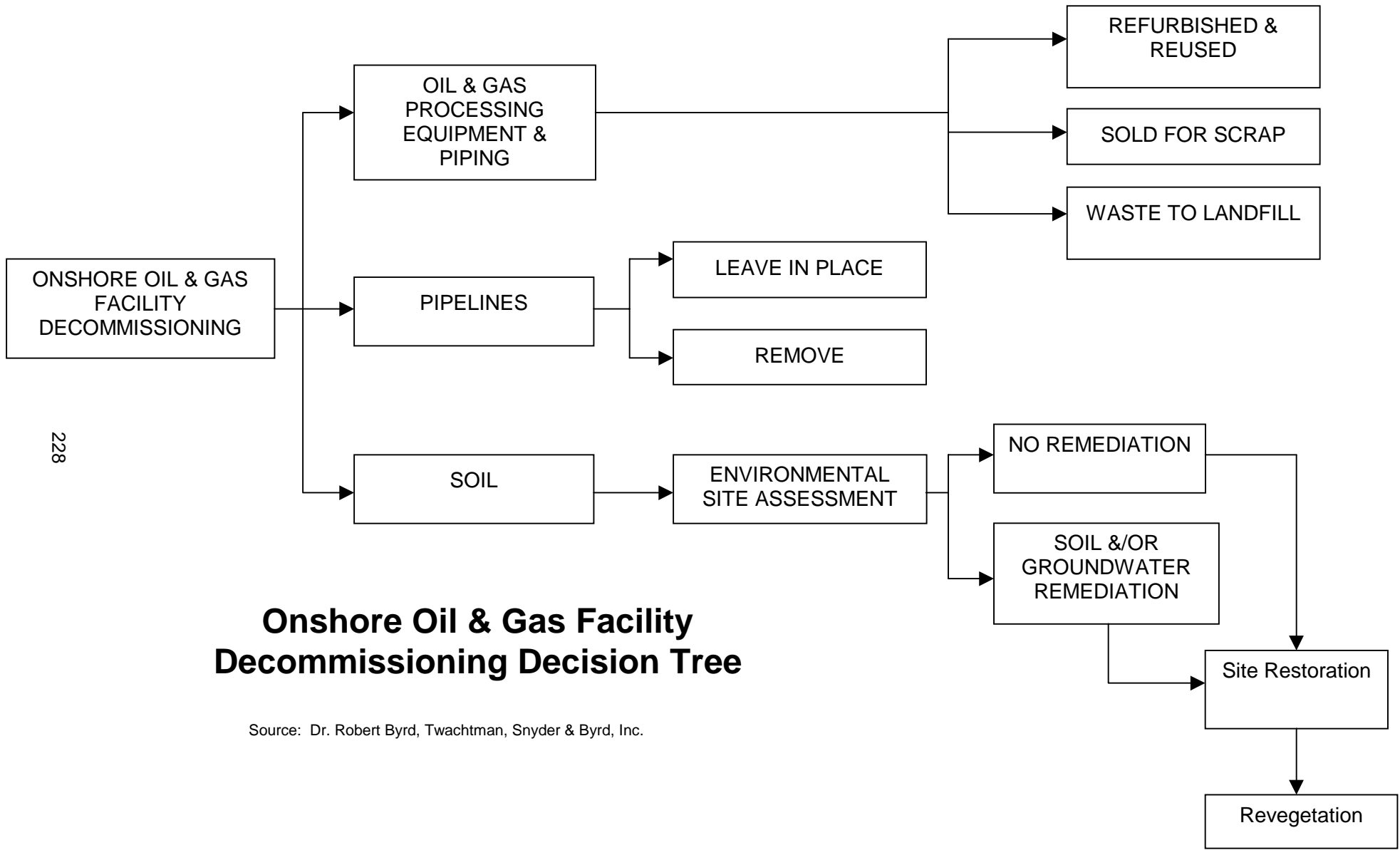

## Onshore Oil & Gas Facility Decommissioning Decision Tree

Source: Dr. Robert Byrd, Twachtman, Snyder & Byrd, Inc.

OFFSHORE OIL & GAS  
FACILITY  
DECOMMISSIONING

OIL & GAS  
PROCESSING  
EQUIPMENT & PIPING

SENT TO SHORE

REFURBISHED  
& REUSED

SOLD FOR SCRAP

WASTE TO LANDFILL

ONSHORE SCRAPING

RECYCLE STEEL

WASTE TO LANDFILL

MOVED TO NEW  
LOCATION &  
REINSTALLED

PARTIAL REMOVAL

TOPPLE IN PLACE

DISPOSED OF IN  
DEEP WATER

SINGLE PIECE  
PLACEMENT  
OFF-SITE

CONVERT TO AN  
ARTIFICIAL REEF

MULTI-PIECE  
PLACEMENT  
OFF-SITE

DECK & JACKET  
STRUCTURE

# Offshore Oil & Gas Facility Decommissioning Decision Tree

Source: Dr. Robert Byrd, Twachtman, Snyder & Byrd, Inc.





---

---

## **APPENDIX III**

---

Glossary .....	233
Abbreviations.....	244



## GLOSSARY OF TERMS

### **Abandonment**

A term generally used synonymously with decommissioning.

### **Anchor**

A heavy hooked instrument which, when lowered to the seabed, holds a vessel in place by its connecting cable.

### **Anchor Buoy**

A barrel shaped buoy through which the anchor pendant wire passes. The buoy holds the eye free end of the anchor pendant wire above the water surface. The pendant wire is used by the anchor handling tug to set and retrieve anchors.

### **Anchor Handling Tug (Resource)**

A tug equipped with a winch to lift a derrick barge's anchors. It is also used as the derrick barge's tow tug.

### **Anchor Pile**

A section (20 - 50 ft.) of large diameter (30 - 48 in.) pipe, with an anchor chain attached to it, driven below the seabed to a predetermined depth, usually 20 feet or more. Anchor piles are used to moor drilling rig tenders, other vessels or terminal mooring buoys. Anchor piles are normally installed in a pattern or system consisting of 6 to 8 anchor piles.

### **Annulus**

The space between the inside face of an outer casing string and the outside face of the next smaller casing string.

### **Arc Gouging**

The use of an electrical arc and compressed air to cut steel.

### **Artificial Reef**

A disused structure emplaced in a designated area either in situ or other designated site. Intended as an enhanced marine habitat for animals and plants.

### **Assimilation efficiency**

The percentage of energy ingested (swallowed) by an animal that is absorbed across the gut wall.

### **Assistant Derrick Barge Standby (Task)**

The standby or idle period between the assist derrick barge's arrival at the platform location and the commencement of its work.

### **Barge Damage Deductible (Resource)**

The deductible for a typical cargo barge hull insurance policy.

### **Bell Guides**

See "Conductor Guides".

### **Benthic**

Living on (or in) the bottom of the ocean and intertidal areas.

### **Biomass**

The weight of living material, often including the dead parts of living organisms (e.g., the shell of a snail). Measured as the amount of living material per unit area or volume. Also known as Standing Crop.

### **Blasting Cap**

See "Detonator".

### **Blasting Machine**

A mechanical or battery operated device used to electronically ignite a detonator.

### **Bottom Clean Up (Task)**

The removal of debris by divers from the sea floor.

**Bottom Time (B.T.)**

The amount of time during a dive that is spent working on bottom.

**Brent Spar**

A cylindrical oil storage and loading buoy operated by Shell UK Exploration and Production on behalf of Shell and Esso.

**Bring In Cargo Barge (Task)**

The process of maneuvering and securing the cargo barge along side the derrick barge.

**Buoy**

A float of any type used as a marker.

**Caisson**

A large diameter pipe driven into the seafloor through which well casings run. The purpose of the caisson is to protect and support the well casings. The caisson may have a small deck.

**Cargo Barge (Resource)**

A flat deck barge used to transport platform components, equipment modules and other cargo.

**Carrying Capacity**

The theoretical maximum number of individuals in a population that can be supported indefinitely by a given environment.

**Casing**

Steel pipe placed in an oil or gas well as drilling progresses to prevent the wall of the hole from caving in during drilling and to provide a means of extracting petroleum if the well is productive.

**Casing String**

Pipe inside an oil or gas well conductor installed during the drilling operations often cemented to the conductor.

**Closure Plates**

Plates welded into the tops of piles or jacket legs to seal them so that water can be evacuated using compressed air.

**Coil Tubing**

Rig like unit with continuous length of pipe on a big coil.

**Communication**

The movement of a substance (hydrocarbons, water, cement) from one position to another.

**Concrete Gravity Base Structure**

A concrete substructure which is not fixed into the seabed by piles but resists wind and wave force by its own bulk and weight.

**Conductor or Drive Pipe**

A large diameter pipe driven into the seafloor to protect the surface casing and to protect against a shallow gas blowout.

**Conductor Guides**

Guides built into the jacket and deck, during fabrication, used to install the conductors in their correct location.

**Consumable Items (Resource)**

Items used in the course of a typical project, the cost of which is not covered by the contract or the schedule of rates.

**Continental Shelf**

The seabed and subsoil beyond the territorial water over which a country has sovereign rights for the purpose of exploring for and exploiting natural resources.

**Crew Boat (Resource)**

A small fast boat used to transport personnel and supplies to and from the job site to shore.

**Critical Path**

The sequence of events that determine the duration of a project.

**Cut Deck Legs, Equipment and Miscellaneous (Task)**

The cutting of all equipment, miscellaneous piping and the deck leg to pile splices to allow lifting the equipment from the deck and the deck from the jacket.

**Cut Jacket**

The cutting of all braces necessary to remove the jacket in two or more sections. If a jacket is so large that its weight will exceed the capacity of the derrick barge, or if it is not structurally sound, it may have to be cut and removed in pieces. If this is required, the members to be cut above the surface would be cut by welders in the conventional manner and those members below water would be cut by divers using the Oxy-arc method.

**Deballast Piles (Task)**

The displacement of water inside the piles with compressed air to reduce the on-bottom weight of the jacket by causing it to be more buoyant.

**Deck**

The platform superstructure which supports drilling, wellhead, and/or production equipment.

**Decommissioning**

The process of deciding how best to shut down operations at the end of a field's life, then closing the wells, cleaning, making the installation safe, removing some or all of the facilities and disposing or reusing them.

**Decommission Pipeline (Task)**

The process of flushing a pipeline with water to purge it of hydrocarbons. After the pipeline is flushed, a pig is run using water and the pipeline is left filled with water.

**Decommission Platform (Task)**

A two phase operation, performed prior to the arrival of the derrick barge spread, to prepare the platform for salvage. The first phase is to make the environment safe for burning and welding. The second phase is to do any work which does not require, or will facilitate, the derrick barge operation.

**Deep Water Disposal**

Offshore disposal of a structure by emplacement at licensed, designated deep water sites.

**Demobilize Assist Derrick Barge (Task)**

The movement of the assist derrick barge from the platform location to its point of origin.

**Demobilize Cargo Barges (Task)**

The movement of a cargo barge and its tow tug from the platform location to the disposal contractor's yard.

**Demobilize Derrick Barge (Task)**

The movement of the derrick barge from the platform location to its point of origin.

**Depth Pay**

Premium paid to divers that dive below 50 feet, increasing at each 50 foot interval. Depth pay is paid once in 24 hours for the divers deepest dive.

**Derrick Barge (Resource)**

A barge (floating construction plant/camp) equipped with a revolving crane, a mooring system and crew quarters.

**Detonation**

The setting off of an explosive charge.

**Detonator**

A device or small quantity of explosives used for detonating high explosives.

**Disposal Contractor**

Contractor that will dispose of the platform components (scrap dealer).

**Diving Services (Resource)**

Services of a diving contractor used during a salvage or construction project.

**Dolphins**

A cluster of piling at the entrance to, or alongside, a dock or wharf for service as a fender, alongside of which boats may be moored.

**Drive Pipe or Conductor**

A large diameter pipe driven into the seafloor to protect the surface casing and to protect against a shallow gas blowout.

**Dumping**

A term sometimes used for offshore disposal.

**E&P Forum**

The Oil Industry International Exploration and Production Forum, a global association of the oil and natural gas exploration and production industry.

**Electric Line Unit**

A piece of equipment that allows work to be performed in an oil or gas well.

**Emplacement**

Regulated lowering of a platform in a designated disposal area, principally a designated artificial reef area.

**Epifauna**

The animals that live on the upper surface layers of ocean floor sediments. (Epiphytes are microalgal organisms that live on a surface.)

**Explosive Charges (Resource)**

High explosives and their sized containers used to sever conductors and piles.

**Explosive Magazine**

A portable container used to transport explosive charges and equipment from the explosive contractors facility to the job site.

**Fabricate Deck Padeyes (Task)**

Replacement deck lifting padeyes are fabricated for decks cut into sections and for decks whose padeyes are no longer safe for the lift. These padeyes are fabricated at the decommissioning contractors facility. The contractor would install these padeyes during its decommissioning.

**Fabricate Explosive Charges (Task)**

The assembly of high explosives in properly sized containers. The explosive charges container are sized to fit the internal diameter of either the pile or conductor pipe. The quantity of explosive material is determined based on the size and type of material to be severed (steel, cement, etc.). This work is performed at the explosive contractor's facility then packages for shipment.

**Fish Attraction Device (FAD)**

A manufactured object placed in ocean surface waters around which fish tend to aggregate.

**Flame Cutting**

The cutting of steel using a controlled flame and oxygen

**Flame Washing**

The use of a controlled flame and oxygen to remove metal.

**Flared Conductor**

See "Flared Pile".

**Flared Pile**

The outward spreading (mushrooming) of the metal above the area where the pile is explosive severed.

**Gang Way**

A portable access walkway used to span the gap between the platform and the derrick barge.

**Gas Free**

Free of explosive or poisonous gas. A safe working area.

**Grout**

Cement slurry used between concentric structural members. Grout was used to secure one member to another.

**Grouted Pile**

The annular region between the pile outside wall and the inside wall of a jacket leg or sleeve is filled with grout. The grout may be several feet deep or fill the length of the jacket leg.

**Grout Plug**

A plug of cement/water mix placed in a pile extending above and below the mudline to strengthen the platform, sometimes with reinforcing bar cages.

**Hand Jet**

High pressure water nozzle used by divers to move soil on the seabed.

**Helideck**

A pad to land helicopters on an offshore vessel or platform.

**Infauna**

The animals that live in the soft sediment layers of the ocean floor.

**In-Water Decompression (IWD)**

The time a diver must spend in the water decompressing at specific depths enroute to the surface.

**In-situ**

In the original position, on site.

**Injection Rate**

The rate fluids can be injected into the production formation and the pressure required to inject the fluids; example 10 barrels per minute at a pressure of 4200 pounds per square inch.

**Inspector (Resource)**

A representative of the oil company required to be present during all phases of the platform removal when work is being performed. His function is to observe the work and maintain a daily log of activities, to verify that the work is performed in accordance with the specifications and to verify extra contractual work.

**Installation**

A generic term for an offshore platform or drilling rig (but excluding pipelines).

**Install Closure Plates (Task)**

Placing and welding prefabricated steel plates in the tops of piles or jacket legs so that the water inside can be evacuated by compressed air.

**International Maritime Organization**

The United Nations body charged with shipping safety and navigation issues.

**Jacket**

The portion of a platform extending from the seabed to the surface used as a template for pile driving and as a lateral bracing for the pile.

**Jet/Airlift**

A device used to remove the pile mud plug. High pressure water breaks up the mud plug and expanding air lifts the particles to the surface.

**Jet/Airlift Mud Plugs (Task)**

The removal of the soil from inside the piles using a jet/airlift system.

**Lifting Block**

A block, containing one or more sheaves, connected to the crane boom by wire rope, that is used to lift and lower loads.

**Lifting Capacity**

The weight a crane can lift at a given boom radius or angle.

**Lifting Eyes**

See "Padeyes".

**Load Spreader**

A pad of wood, steel, etc. Normally placed on a cargo barge to distribute a concentrated load over a larger area.

**London Convention**

An international treaty signed by more than 70 nations governing disposal of substances at sea.

**Magnetometer**

An electrical device towed by a boat over a location to locate metal objects, i.e. pipelines, wellheads, wrecks, and similar ferrous objects.

**Marine Growth**

Sea life (e.g. barnacles) attached to hard objects submerged in the sea.

**Members**

The structural pieces or components that make up a jacket or deck structure.

**Mobilize Assist Derrick Barge (Task)**

The movement of the assist derrick and it's tow/anchor handling tug boat from its point of origin to the platform location.

**Mobilize Cargo Barge (Task)**

The movement of a cargo barge and it's tug boat from their point or origin to the platform location.

**Mobilize Derrick Barge (Task)**

The movement of a derrick barge and it's tow/anchor handling tug boat from its point or origin to the platform location.

**Mosaic**

Number of pictures making up a big picture.

**Mud Plug**

The soil (mud, clay, sand) inside an open ended pile that has been driven into the seabed.

**Mudline (M.L.)**

The elevation of the natural seabed.

**North East Atlantic**

The sea area to which OSPAR Conventions apply, This is defined as westwards to the east coast of Greenland, eastwards to the continental North Sea coast, south to the Straits of Gibraltar, and north to the North Pole. This maritime area does not include the Baltic or Mediterranean seas.

**North Sea**

The sea bounded primarily by the coasts of Great Britain, Norway, Denmark, Belgium, Germany, Sweden, France and the Netherlands.

**Off-Load Cargo Barge (Task)**

The removal of all sea fastening and the platform components from the cargo barge at the disposal contractor's yard.

**Offshore**

Operations carried out in the ocean as opposed to on land.

**Operator**

The company either solely or in a joint venture which manages the operation of oil and gas production for itself or on behalf of the partners.

**Oslo Commission**

See "Osparcom".

**Osparcom**

The Oslo and Paris Commission which regulates pollution from offshore and onshore sources in the North East Atlantic.



**Oxy Acetylene Torch**

A device using oxygen and acetylene to cut steel.

**Oxy-Arc Torch**

A device using oxygen and an electrical arc to cut metal, usually underwater.

**Padeye**

A plate with a hole cut in it that is attached to a structure which allows a shackle connection for lifting the structure.

**Paris Commission**

See "Osparcom".

**Pelagic**

Living in the water column offshore of the coastal zone (i.e., seaward of the downward break in the continental slope).

**Pendant Wire**

The cable connected to the head of an anchor used by the anchor handling tug to raise or lower the anchor. The free end is held at the water surface by a buoy.

**Pick Up Assist Derrick Barge Anchors (Task)**

The retrieval of the assist derrick barge's anchors at the end of its portion of the project.

**Pick Up Derrick Barge Anchors (Task)**

The retrieval of the derrick barge anchors at the end of the project.

**Pig**

A plug, forced through a pipeline by liquid or gas, used to clean the pipe's interior or separate different fluid mediums.

**Pile**

Steel pipe driven into the seabed to secure and support an offshore structure.

**Pile Driving Hammer**

A steam, diesel or hydraulically operated impact hammer used to drive piles into the seabed.

**Pipeline**

A conduit of steel pipe extending from platform to platform or platform to shore used to transport oil and/or gas.

**Pipeline Abandonment (Task)**

The cutting and plugging of a pipeline that is to be abandoned in place. Prior to the jacket removal and after the pipeline decommissioning is completed, the pipeline is cut and abandoned in place using a diving crew. The diving is performed from the derrick barge or a dive boat prior to the derrick barge arriving on location.

**Pipeline Surveying Services (Resource)**

The services of a surveying contractor and his equipment or mark pipelines and other submerged objects to avoid interference with derrick barge anchor placement.

**Plankton**

Organisms living suspended in the water column and incapable of moving against water currents.

**Platform**

A structure secured to the seabed and extending above water for the production of oil and gas.

**Population Dynamics**

The variations in time and space in the sizes (number of individuals) and densities (number of individuals per unit area or volume) of a population.

**Population**

A group of individuals of the same species in a defined area.

**Primary Productivity**

The rate at which biomass is produced per unit area by plants.

**Processing Facilities**

Part of the topsides that treat oil and gas, remove impurities and pump the product into pipelines to shore.

**Production Casing**

A pipe set in the well after it is drilled. The tubing is inside the production casing.

**Production Efficiency**

The percentage of energy assimilated by an organism that becomes incorporated into new biomass.

**Production Formation**

The sub strata in which hydrocarbons are present. Where the oil and gas enters the tubing to be transported to the surface.

**Productivity**

The rate at which biomass is produced per unit area by any class of organisms.

**Recruitment**

The addition of individuals of a specified size or age to a population. In a fisheries context, recruitment refers to the addition of individuals to the size (or age) groups that can legally be caught. Otherwise, recruitment typically refers to the known addition of 'newborns' (see Young of the Year) to a population (also see Settlement).

**Recycling**

Removal of an installation or parts of an installation to shore where they are separated into different materials and melted down or reprocessed to be reused.

**Remove Conductors(Task)**

The removal of the conductors from the jacket and placing them on a cargo barge. The conductor guides in the jacket cannot support the weight of the conductors, therefore they must be removed prior to the removal of the jacket.

**Remove Deck(Task)**

The lifting of the deck from the jacket and placement of it on a cargo barge.

**Remove Equipment (Task)**

The lifting, placing and seafastening on a cargo barge, of all equipment removed from the deck.

**Remove Jacket (Task)**

The lifting of the jacket from the seafloor and placement of it on a cargo barge for transport to shore.

**Remove Piles from Jacket Legs (Task)**

The removal of the piles from the jacket to reduce the jacket's lift weight.

**Rig**

The derrick or mast, drawworks, and attendant surface equipment of a drilling or work over unit.

**Rigless Abandonment**

P&A without a rig.

**Rig Up Cargo Barge (Resource)**

The installation of protective pads to prepare a cargo barge for receiving the salvaged platform components.

**Rigs to Reefs**

A national policy in the US enshrined in legislation, promoting the conversion of disused platforms into artificial reefs for marine life at designated sites.

**Riser**

The portion of a pipeline that rises from the seabed to the water surface, supported by the platform jacket.

**Riser Bend**

The section of the riser that turns the pipeline from horizontal to vertical.

**Salvage Contingency**

An allowance of 15% of the estimated on site derrick barge spread work time to account for unforeseen factors which will increase the time required to perform the work. Examples of items to be covered by this contingency are as follows:

1. Conductor flaring  
In the process of explosively severing the conductors, flaring of the cut ends occurs. This flaring will not allow the conductor to pass through the conductor bell guide framing in the jacket resulting in divers having to cut the flared end. This will require one hour of bottom time per conductor plus in water decompression time as determined by the dive tables for the applicable water depth.
2. Pile flaring  
As in the case of conductor flaring described above, flaring of the pile ends also occurs. Additional time is required to trim the pile ends, eliminating the flared obstruction.

**Sea Buoy**

The first buoy encountered when approaching the entrance of a river or port from sea.

**Seafasten**

The securing by welding of platform components or cargo to the cargo barge for transport at sea.

**Set Up Derrick Barge (Task)**

The placement of the derrick barge's mooring anchors on the seafloor around the platform location at pre-selected positions. The derrick barge will be positioned along side the platform using its mooring system. A walkway will be placed between the derrick barge and the platform.

**Settlement**

Many marine organisms that live on the bottom (see Benthic) have early developmental stages that grow in the water column (see Plankton and Pelagic). Settlement refers to the event when the young leave the water column permanently to take up life on the bottom. Recruitment typically refers to the first observation of young following settlement from the water.

**Sever Conductors (Task)**

Cutting the conductors using high explosives.

**Sever Piles (Task)**

Cutting the piles using high explosives.

**Shackle**

A "U" shaped device with a removable pin or bolt across the end used to connect a sling or cable to a padeye.

**Shaped Charge**

An explosive charge designed to focus its blast onto a very small area, used to cut very thick materials.

**Shim**

Curved steel plates wedged between and welded to the jacket leg and pile, used to tie the jacket and piles together at the top of the jacket leg.

**Shoe**

A piece of equipment installed on the end of the casing when it is run into the well bore (i.e. that point in which the casing ends).

**Side-scan Sonar**

Radar like device used to determine shapes in the water on the sea floor.

**Skirt Pile**

A steel pipe driven into the seafloor that passes through a sleeve attached to the jacket. The sleeve and skirt pile extend from the mudline up 50 to 100 feet along the jacket leg. The annular region between the pile and sleeve is filled with grout. The purpose of a skirt pile is to secure and support offshore structures.

**Slickline**

A machine with a hydraulically controlled spool of wire used for setting and retrieving safety valves, lugs, gas lift valves, and running bottom hole pressures. Slicklines are also used for a variety of other jobs such as recovering lost tools and swedging out tubing. Slickline wire generally ranges in size from .072 inches to .108 inches.

**Sling**

Usually a wire rope of a given length with a loop formed on each end, used for lifting loads.

**Spatial Distribution**

The pattern of placement of items (e.g., individuals) in space.

**Spreader Bar**

A pipe or beam arrangement used to spread the slings to keep them from damaging the load while lifting.

**Spreader Frame**

See "Spreader Bar".

**Spud Barge**

A derrick barge moored by dropping pipe or beam spuds into the seabed.

**Stakeholders**

All the parties having an interest in an issue, including among others corporate shareholders, regulators, employees, community groups, the public at large.

**Stiffleg Barge**

A derrick barge with a crane that does not revolve and which may or may not boom up and down.

**Stops**

Metal plates welded to the sides of a pile to hold the pile at a desired elevation in the jacket leg.

**Subsea Tie In**

Point where a branch pipeline ties into a main pipeline on the seabed.

**Survey Location for Pipelines (Task)**

The locating and buoying of pipelines around a platform. A survey boat and crew are mobilized to the location to locate and mark, with buoys, all pipelines within a 4000 foot radius of the platform to enable the derrick barge(s) to place its anchors safely.

**Temporal Pattern**

Variation in some attribute (e.g., number of individuals in a population) over time.

**Tension Leg Platform (TLP)**

A floating platform anchored to the sea bed by long steel pipes (tension legs). The tension legs keep the platform from moving up and down on the waves.

**Tonne**

1000 Kilograms - a common weight unit used in offshore structure design and construction; also used as a measure for oil (approx. 1200 liters).

**Toppling**

Controlled "tipping over" of the platform (generally but not always without topsides) from it's vertical position to resting horizontally on the seabed.

**Topsides**

The facilities which contain the plant for processing oil and gas and accommodations.

**Tow Tug (Resource)**

A tug boat used to tow a barge, either a cargo barge or derrick barge. It may also be used as an anchor handling tug by the derrick barge.

**Trophic Coupling**

A strong linkage among organisms on two or more different levels in the food chain (e.g., herbivores - carnivores).

**Tubing String**

The smallest diameter pipe suspended in a well. The hydrocarbon product flows to the surface inside the tubing.

**Trunk Line, Explosives**

A detonation cord that connects all the explosive charges so they may be detonated in a group.

**Walk Way**

See "Gang Way".

**Weather Contingency (Task)**

An allowance of 6% of the estimated onsite derrick barge spread work time to account for lost time due to weather.

**Well**

The holes drilled through the seabed into the reservoir where oil or gas is trapped, often two thousand or more meters below the seabed. The hole is lined with piping which extends up through conductors onto the platform deck.

**Well Head**

The well head sits on top of the drive pipe. Casing and tubing strings are suspended from the well head. Valves on the well head allow the entrance to the tubing and the casing annuli.

**Wire Rope**

Steel wire formed into a cable.

**Wood Piles**

Wooden (timber) piles driven into the seabed to support equipment offshore.

**Young of the Year (YOY)**

The young of a species that were born in this year; typically applied to fishes (also see Settlement and Recruitment).

## ABBREVIATIONS

API	American Petroleum Institute
BHT	bottom hole temperature
BOP	blow out preventer
CB	cargo barge
CEQA	California Environment Quality Assessment
CG	center of gravity
CIBP	cast iron bridge plug
CIRC.	circulate
DB	derrick barge
DEMOB	de-mobilize
DOT	Department of Transportation
DP	dynamic positioning
DPV	dynamic positioning vessel
HAZMAT	hazardous material
I. Csg.	intermediate casing
LAT	lowest atmospheric tide
LD	lay down
ML	mud line
MLW	mean low water
MMS	Minerals Management Service
MOB	mobilize
MT	metric ton
NDT	nondestructive testing
NDE	nondestructive examination
NEPA	National Environmental Protection Agency
NMFS	National Marine Fisheries Service
NORM	naturally occurring radioactive material
NOAA	National Oceanic and Atmospheric Administration
OCS	outer continental shelf
OD	outside diameter
P&A	plug and abandonment
PERF.	perforate
PL	pipeline
POOH	pull out of hole
PP	pump
RD	rig down
RETR.	retrieve
ROV	remote operated vessel
SAT	saturation diving
ST	short ton
SSCV	semi-submersible crane vessel
TBG	tubing
UT	ultra sonic testing
WL	wire line
WOC	wait on cement
WOR	work over rig
WT	weight
YOY	young-of-year

---

---

## APPENDIX IV

---

Biographical Sketches .....	247
-----------------------------	-----





## BIOGRAPHICAL INFORMATION ON SPEAKERS, PANEL MEMBERS, CHAIRPERSONS, AND ORGANIZERS

**Lee Bafalon:** Lee Bafalon is Senior Land Representative for Chevron U.S.A. Inc., based at Chevron's Ventura offices. He has been with Chevron for over 17 years, all of that time working on behalf of Chevron's offshore California operations. Lee is responsible for permitting and regulatory affairs for Chevron's Santa Barbara Channel assets, offshore and onshore. In that capacity, he was on the permitting team for the installation of the Point Arguello and Gaviota facilities in the 1980's, the permitting coordinator for Chevron's 4H State Platforms Project from 1992-1996, and is currently on the permitting team for Chevron's contemplated OCS Facilities Decommissioning Project.

**Ann Scarborough Bull:** Dr. Ann Scarborough Bull was born and raised in San Diego, California, and has worked as a marine biologist for the Minerals Management Service since 1988. She performed her graduate research at the Marine Biological Laboratory, Woods Hole, and her post doctoral work at Johns Hopkins in Maryland. Her research interests focus on the role of offshore platforms in the fisheries of the Gulf of Mexico.

**Robert C. Byrd:** Dr. Byrd is a Principal in Twachtman, Snyder & Byrd, Inc. (TSB), Houston, Texas, a project management and engineering firm which specializes in offshore oil and gas facility decommissioning. TSB has managed the decommissioning of over 200 facilities in the Gulf of Mexico and is active in planning the decommissioning of facilities offshore California and in Europe's North Sea. Dr. Byrd joined TSB in 1993. Prior to that he was President and Chief of Operations at IMODCO, Inc., Agoura Hills, California, for a period of seven years. IMODCO specializes in offshore oil and gas terminals and floating facilities worldwide. In total Dr. Byrd has over twenty years experience in a wide range of positions involving offshore facilities engineering, construction, and decommissioning. He is also a former U.S. Coast Guard officer. Dr. Byrd received his Ph.D. in Engineering from the University of California, Berkeley, where he was a Hans Albert Einstein Fellow in Ocean Engineering and was a recipient of the National Sea Grant Association Award for Applied Research. He holds a Masters in Ocean Engineering from the University of Alaska, Fairbanks, and a B.S. in Marine Engineering from the United States Coast

Guard Academy at New London, Connecticut. Dr. Byrd is a licensed Professional Engineer.

**Peter Cantle:** Peter Cantle has been employed with Santa Barbara County Air Pollution Control District since September 1988, providing engineering management, analysis and permitting services. Prior to Air Pollution Control District, he worked three years with the Energy Division (Planning and Development, Santa Barbara County), responsible for permitting and compliance of major energy projects (Exxon SYU, Chevron Point Arguello, Gaviota Marine Terminal, Celeron Pipeline, etc.) Prior to that, he worked five years with Shell as Environmental Specialist (Houston, TX). Prior to Shell, he worked two years with Hydril Co., manufacturing and marketing oilfield equipment. Peter earned a Bachelor and a Master of Science degree in Ecology from Texas A&M University. He is the father of two sons, and he is an avid enjoyer of the ocean and its related sports.

**Mark H. Carr:** Dr. Mark Carr is an Assistant Professor in the Department of Biology, at the University of California, Santa Cruz. He is also Deputy Program Director for the UC-MMS Coastal Marine Institute and the Southern California Educational Initiative. His current research involves experimental studies of recruitment and population dynamics of reef fishes in the Bahamas and the ecological role of oil/gas production facilities in the Santa Barbara Channel. He received his B.A. at the University of California, Santa Cruz, his M.S. from San Francisco State University and Moss Landing Marine Laboratories, and a Ph.D. from the University of California, Santa Barbara, all of which are in Biology with an emphasis on Aquatic Biology.

**Marc Chytilo:** Marc Chytilo is Chief Counsel of the Environmental Defense Center, a public interest law firm and advocacy organization with offices in Santa Barbara and Ventura, California. EDC has been attorneys in numerous air quality cases involving the oil industry and Outer Continental Shelf activities, including *Citizens to Preserve the Ojai v. Petrochem* (CEQA: Cumulative air quality impacts), *Citizens to Preserve the Ojai v. EPA* (federal implementation plant): *EDC v. EPA* (Clean Air Act § 328

regulation promulgation); and *Get Oil Out v. State Lands Commission* (subsea well abandonment project). Marc is a member of the Santa Barbara County Air Pollution Control District Community Advisory Council and an active outdoorsperson regularly enjoying the recreational opportunities provided in the Santa Barbara Channel.

**Gordon Cota:** Gordon Cota is a tenth-generation Santa Barbaran who is owner/operator of the F/V *Genoa*, a commercial fishing vessel home-ported in Santa Barbara. He has fished with tool and line, traps, and trawl nets for over 25 years in the Southern California Bight. Gordon has served on the Department of Interior, Mineral Management Service's Regional Technical Working Group, and is a former Santa Barbara Harbor Commissioner. He currently serves as a representative for the trawl fleet on the Joint Oil/Fisheries Committee, an ad-hoc group formed in 1983 to resolve interindustry concerns. He also serves as the Secretary of the Southern California Trawlers Association. Gordon has been very active in helping to solve at-sea interindustry problems, including serving as scout, chase, or pilot vessel for oil industry activities which might impact commercial fishing, and site clearance test-trawling after oil facility abandonments.

**Andrew S. Culwell:** Andy Culwell has been active in the decommissioning and removal of offshore oil and gas facilities for the past 24 years. As Vice President, Special Projects for American Pacific Marine, Inc. (his current affiliation), he planned and directed the removal of Chevron's Platforms Hope, Heidi, Hilda, and Hazel offshore Carpinteria in 1996. He also planned and directed the removal of Texaco's Helen and Herman Platforms offshore Gaviota in 1988 and supervised the removal of portions of Aminoil's Ellwood Pier off Goleta in 1979. Mr. Culwell has an extensive background in underwater construction and demolition, oil platform and pipeline installation and removal, and the use of remotely operated vehicles and manned submersibles in deep water construction applications, working in the U.S. Gulf of Mexico, the North Sea, South America and the U.S. West Coast.

**Elmer (Bud) P. Danenberger:** Mr. Danenberger earned a B.S. degree in petroleum and natural gas engineering and a Masters degree in environmental pollution control, both from Pennsylvania State University. He has been

employed as an engineer in the Department of Interior's offshore oil and gas program since 1971. He has served as District Supervisor for the Minerals Management Service (MMS) field offices in Santa Maria, California, and Hyannis, Massachusetts, as a staff engineer in the Gulf of Mexico regional office, and as chief of the Technical Advisory Section at headquarters office of the U.S. Geological Survey. He is currently the Chief of MMS's Engineering and Operations Division with responsibilities for safety and pollution-prevention research, engineering support, offshore operating regulations, and inspection programs.

**Frank DeMarco:** Frank DeMarco, Registered Civil Engineer in the State of California, is an Associate Water Resource Control Engineer for the Regional Water Quality Control Board, Central Coast Region. He has worked for the Regional Board for over sixteen years. Currently, he is working in the Board's "Spills, Leaks, Investigation and Cleanup" (SLIC) program and the "Underground Storage Tank" program. Projects Frank has worked on that might be of interest to those attending this workshop include: Unocal-Avila Beach, tank farm near the City of San Luis Obispo, pipelines, sumps/abandonment; Chevron-Estero Bay and Carpinteria marine terminals/facilities, Texaco-Estero Bay tank farm abandonment, San Ardo brine disposal; Shell-Hercules Gas Plant near Gaviota.

**Leray A. deWit:** Leray A. deWit is an independent environmental consultant, specializing in resource assessment and permitting for coastal and offshore developments. He has over 23 years of experience in environmental consulting, including management of multidisciplinary environmental documents for federal, state, and local agencies, marine and coastal surveys, permitting of port, harbor, marina, and oil and gas developments, and assessment of impacts of proposed projects on biological resources. In addition to his experience throughout California, Mr. de Wit has worked on several international projects including environmental analysis for proposed or existing marine and coastal developments in Iran, Qatar, Abu Dhabi, Cameroon, Curacao, Peru, the Bahamas, United Kingdom, Russia and Thailand. Mr. de Wit has developed and managed large field surveys and is an accomplished diver, having logged over 1,300 dives, including a one-week saturation dive in the Hydrolab Underwater Habitat as part of a study on the effects of oil on

coral reef communities. He has completed pre- and post-construction and abandonment marine biological surveys for oil and gas facilities throughout the Santa Barbara Channel.

**Robert B. Ditton:** Dr. Ditton received his B.S. from the State University of New York College at Cortland and his Masters and Ph.D. from the University of Illinois. He is a member of the faculty of the Department of Wildlife and Fisheries Sciences where he teaches graduate level courses in coastal zone management and the human dimensions of wildlife and fisheries. He is the only social scientist in this Department currently. Most of his current research focuses on the human dimensions aspects of recreational fisheries (fresh and saltwater). Ditton has written extensively on the need for integrated approaches to natural resources management. He served as a Senior Research Scientist on an IPA assignment with the Minerals Management Service, Gulf of Mexico Region, from 1981-83. Also, Ditton served as a member of the National Research Council Committee on the Disposition of Offshore Platforms in 1984-85. Later, he served as a member of the board of experts that developed the National Artificial Reef Plan pursuant to the National Fisheries Enhancement Act in 1985. He is currently completing the second year of a multi-year research project for the Texas Parks and Wildlife Department on better understanding stakeholder groups that currently use offshore reef systems in Texas including oil and gas platforms.

**Tom Dunaway:** Tom Dunaway works for the Minerals Management Service, a small Federal agency in the Department of the Interior. He is the Regional Supervisor for Development, Operations, and Safety for the Pacific OCS Region located in Camarillo, California. His office is responsible for all oil and gas operations in Federal waters off the west coast. He has held this position for the last fifteen years and started his government service twenty-seven years ago with the U.S. Geological Survey's Conservation Division the precursor of MMS. He graduated with a bachelor's degree in Chemical Engineering from the University of Kansas. Also, he graduated from the Tuck Executive Program, Dartmouth College. He successfully completed the Career Development Program to enter the Senior Executive Service of the Federal government. He has been awarded the Superior and Meritorious Service Honor Awards of the Department of the Interior.

**Steve Fields:** Steve Fields is an Operations Engineer in the Ventura Office for the State of California, Department of Conservation's Division of Oil, Gas, and Geothermal Resources (Division). He started with the Division in 1981 in the Santa Maria Office. While in Santa Maria, he was involved in the plugging and abandonment operations for the wells on Platform Helen and the subsea completions associated with Platform Hermit. In 1985, he transferred to the Long Beach office where he spent three years as an Enhanced Recovery Engineer. In 1988, he transferred to his current position in Ventura. While in Ventura, he has been the Lead engineer for the 4-H well abandonment, the well abandonment on the Rincon Piers, and for three of the subsea well abandonment.

**Daniel Frumkes:** Daniel Frumkes is a graduate of UCLA in Zoology in 1963. He was assistant to the Director of the UCLA Health Sciences Computing Facility through 1978, first in the UCLA Department of Biomathematics and later in directing the Brentwood Hospital Statistical Research Laboratory. He interfaced with a wide range of scientific research which provided the foundation for the development of new techniques for computer assisted data analysis. Dan was a commercial hook and line fisherman from 1959 through 1970. He began his career in marine conservation as a volunteer in 1983, first by evaluating the selectivity of near-shore gillnets and later by reviewing existing techniques for collecting and analyzing fisheries data. Dan describes his initial involvement with marine conservation as less *volunteerism* and more *falling* into the void between marine scientists who have valuable knowledge, and policy makers, who have little access to the best available information. Dan continues to function as an interface between scientists and both policy makers and the public. He is the Chairman of the Habitat Research and Enhancement Committee for United Anglers of Southern California, and is the Director of the Conservation Network for the American Sportfishing Association. The objective of both positions is to help develop synergistic solutions for fisheries enhancement through education.

**Craig Fusaro:** Dr. Craig Fusaro received his Doctorate in Biological Sciences from the University of California, Santa Barbara, in 1977, working on the population dynamics of intertidal crustaceans. From 1976 to 1983, he was an associate research biologist and co-principal

investigator with Ecomar, Inc., involved in a variety of applied research projects ranging from mussel mariculture to ocean outfall studies to the fate and effects of offshore oil drilling fluids in the marine environment. In 1983, he became the director of the Joint Oil/Fisheries Liaison Office, an inter-industry effort to improve communications and resolve conflicts between the two offshore industries in the Santa Barbara Channel and Santa Maria Basin. Working with the Mediation Institute, he continues that effort presently. Concurrent since 1981, he has also taught courses in Animal Diversity, Kelp Ecology, Environmental Biology and Environmental Field Studies at Santa Barbara City College. He also volunteers as the Central Coast Board Member for California Trout, a statewide trout and stream habitat conservation organization, and is working to restore anadromous steelhead to the Santa Ynez River.

**W. S. (Bill) Griffin:** Bill Griffin is Director of Special Projects for Worldwide Drilling and Production at Phillips Petroleum Company. He began his work for Phillips in 1961, after receiving a B.S. degree in Petroleum Engineering from the University of Oklahoma. His first assignment involving the decommissioning of offshore installations was in 1972. Bill was asked to determine the future financial liability involved in the removal of all offshore structures, on a worldwide basis, in which Phillips had an interest. He has subsequently held the position of Project Manager or Advisor on every decommissioning study carried out by Phillips. He has served on numerous industry committees related to decommissioning and has consulted with host governments. From 1987 until 1989 he was the industry Advisor for the U.S. Delegation during the IMO Guideline negotiations. Bill is currently working in London as the International Regulations Consultant for the industry's Offshore Decommissioning Communications Project.

**Carolita Kallaur:** Carolita Kallaur was named as the Associate Director for Offshore Minerals Management, Minerals Management Service, in January 1997. She is responsible for all phases of the Outer Continental Shelf (OCS) mineral resource management – from the initial offering of OCS lands for lease through the regulation of mineral development and lease abandonment activities. Ms. Kallaur had served as Acting Deputy Director from August 1994 until November 1995, when she became the Deputy Director. In that capacity, she assisted the

Director of MMS in running the day-to-day operations of the Agency. Ms. Kallaur also served as the Chief Financial Officer for the Bureau and served as Chair of its Information Resources Management Council. Ms. Kallaur has been with the Interior Department since 1968, when she began her federal career. She joined MMS in 1982. Ms. Kallaur has been honored with the U.S. Department of the Interior's Meritorious Service Award in 1985, the Distinguished Service Award in 1987, and the Presidential Meritorious Rank Award in 1987 and 1992. In 1995, she received the Presidential Distinguished Rank Award – the highest award bestowed a Senior Executive Service employee – for her exceptional contributions and leadership roles in the OCS oil, gas, mineral and international programs. Ms. Kallaur has a B.A. and an M.A. in economics from the University of Connecticut.

**Linda Krop:** Linda Krop is a Senior Staff Attorney with the Environmental Defense Center (EDC), non-profit public interest environmental law firm that represents community organizations in a wide variety of issues affecting our natural resources, air and water. Linda Krop currently represents the Environmental Coalition of Santa Barbara (comprised of the Sierra Club, League of Women Voters of Santa Barbara, and the Citizens Planning Association) and other community groups in matters relating to offshore oil and gas development. One of the issues the EDC is working on is the abandonment of facilities, both onshore and offshore. The EDC's clients (environmental groups and commercial fishing organizations) strongly prefer the complete removal of all facilities and a restoration of affected areas to pre-development natural conditions. EDC's clients also seek strict enforcement of approved abandonment plans and permit conditions.

**James Lima:** Dr. James Lima, formerly an Assistant Professor of Social Science at Troy State University, Alabama and adjunct professor at Dauphin Island Sea Lab, Alabama, is now a sociologist for the Minerals Management Service, Environmental Studies Section in Camarillo, California. Dr. Lima received his Ph.D. in Political Science in 1994 from the University of California, Santa Barbara. His area of expertise is in social and economic impacts of offshore energy development, coastal zone management, submerged cultural resources, environmental administration and policy analysis.

**Milton Love:** Dr. Milton Love is an Associate Research Biologist at the Marine Science Institute, University of California, Santa Barbara. For the past 25 years, his research interests have centered on Pacific Coast marine fishes of recreational and commercial importance. Currently, he is conducting research on the fish communities living around the oil platforms of the Santa Barbara Channel.

**Frank Manago:** Frank Manago is an Environmental Scientist with the Minerals Management Service (MMS), Pacific Outer Continental Shelf (OCS) Region in Camarillo, California. He joined MMS in 1984. In his present position, he is responsible for the development, procurement and contract management of environmental studies on the OCS in the areas of benthic, algal and fish ecology. He was one of the workshop coordinators for the 1994 MMS/CA State Lands Commission (SLC) workshop, *Abandonment and Removal of Offshore Oil and Gas Facilities: Education and Information Transfer*. Previously, Mr. Manago worked as an ecologist for the U.S. Army Corps of Engineers in Los Angeles, CA and was responsible for environmental planning and site assessment of military and civil work projects. Mr. Manago received his B.S. in Biology and Chemistry from North Carolina Central University and M.S. in Environmental Science from North Carolina State University.

**Jack McCarthy:** Jack McCarthy is currently employed as a geophysicist in the Pacific Region office of the Minerals Management Service. He has been involved with evaluating offshore leasing, drilling and development sites on the Atlantic, Gulf and Pacific OCS, using engineering geophysics and marine geotechnical methods, for more than twenty years. Site clearance operations depend on some of the same evaluation techniques. Given the anticipated increase in decommissioning activities in the near term off California, Jack's background in marine geology and oceanography and his experience in geoengineering survey technique, habitat mapping and commercial fishing makes him a logical candidate for assuming the functional role of MMS's "Marine Geobiologist" for the Santa Barbara Channel.

**Mike McCorkle:** Mike McCorkle has been a full-time commercial fisherman for 41 years, with experience in all types of commercial fishing. He has 23 years of experience trawling around oil

rigs, and extensive experience talking about the pros-cons of rig removal from trawlers' point of view.

**Merit McCrea:** Merit McCrea has worked within the maritime industry in the area of Commercial Passenger Fishing Vessels, (CPFV), since 1974. For the last 12 years he has owned and operated a CPFV from Santa Barbara harbor predominantly in the area of the Santa Barbara Channel and Channel Islands. He has personal experience in this region for 22 consecutive years. He also has some limited experience in both gill net and hook and line commercial fishing. In addition to fishing operations he has worked with Dr. Milton Love of UCSB in the area of data and specimen acquisition on several projects including *Life History Aspects of 19 Rockfish Species (Scorpaenidae:Sebastes) from the Southern California Bight*. He is currently an active board member of the Sport Fishing Association of California. He owns and operates the Vessel SEAHAWK LXV from Sea Landing in the Santa Barbara Harbor.

**Paul B. Mount II:** Mr. Mount is Chief of the Mineral Resources Management Division of the California State Lands Commission. Mr. Mount graduated from Ohio State University, in Chemical Engineering with a major in Petroleum Engineering in 1973. After his graduation, he began his career with Unocal working in Santa Maria and Coalinga, California. In 1978, he was transferred to the Unocal's Research and Technology Center and responsible for research in enhanced oil recovery. He was one of the leading experts in the world on using single well tracer tests to determine residual oil saturation in oil and gas reservoirs. In 1981, Mr. Mount worked for Aminoil in Huntington Beach, California. He was promoted to Engineering Manager in 1982 and continued with Aminoil until 1987 in that capacity. In 1987, he took a position as a Reservoir Engineer with the State Lands Commission, and was promoted to Chief of Research and Development in 1988. He was promoted to Chief Reservoir Engineer in 1989, Assistant Chief of the Mineral Resources Management Division in 1990 and became Chief of the Division in 1991. He organizes and directs the Commission's Mineral Resources Management Program, including all oil, gas and geothermal and mineral resources on State Lands in the State of California. Mr. Mount is a licensed Professional Petroleum Engineer and is a member of the Society of Petroleum Engineers.

Mr. Mount recently retired as a Colonel in the U.S. Army Reserves.

**Dave Parker:** Dave Parker is a Senior Biologist with the California Department of Fish and Game's Marine Resources Division in Long Beach. He currently supervises the Department's Artificial Reef Program and has been involved with southern California nearshore invertebrate and sportfish issues with the Department for over 20 years.

**John Patton:** John Patton is Director of Santa Barbara County, California's Planning and Development Department. Prior to becoming Director, Mr. Patton was in charge of the County's Energy Division. The Energy Division is responsible for County permitting necessary for the \$6 billion development of offshore oil and gas in the Santa Barbara Channel and Santa Maria Basin. Mr. Patton received the U.S. Department of Commerce National Oceanic and Atmospheric Administration's first annual Award for excellence in Coastal, Estuarine and Marine Management for P&D's role in developing mitigation measures that make the Exxon Santa Ynez project a model of environmentally-sensitive offshore oil development. Mr. Patton holds a Bachelors degree from Tufts University and a Master of Regional Planning degree from the University of North Carolina.

**Luis Perez:** Luis F. Perez is an energy specialist with the Energy Division of the Planning and Development Department for Santa Barbara County where he has worked for the past 6 years. During that time, Luis has been a planner or project manager for decommissioning projects including Calresources/SWEPI Molino Gas Plant, the Texaco Gaviota Gas Plant, the Exxon Offshore Storage and Treatment (OS & T) Facility and the Guadalupe oil spill cleanup. Prior to his work with the Energy Division, Luis had worked in the Caño Limon - Rio Zulia Pipeline in Columbia, South America for 3 years in sub-contract management, emergency response and revegetation. Luis holds B.A. and B.S. degrees in environmental science and public relations from Northern Arizona University.

**Simon Poulter:** Simon A. Poulter is a principal of Padre Associates, Inc., a Ventura California based environmental and engineering consultant firm. Mr. Poulter has 14 years of experience as a project manager and environmental scientist responsible for physical, biological, and cultural

resource assessments for inland, coastal, and outer continental shelf projects. This experience has included numerous environmental impact reports (EIA/EIR/EIS), resource assessment studies, oil spill contingency plans, and regulatory permitting and compliance programs for projects within the United States, as well as the Russian Federation and South America. Mr. Poulter has been the project manager for the permitting and environmental review for a number of recent oil and gas facility abandonment programs in California. These decommissioning projects have included: Chevron's four State Waters platforms located offshore of Carpinteria; 23 subsea wells and associated flowlines in the Santa Barbara Channel; Unocal's Ventura tanker berth; Mobil's Seacliff Pier complex and Exxon's Belmont Island. Mr. Poulter holds a Masters degree in Environmental Planning from the University of Pennsylvania and a B/A/ in Marine/Aquatic Biology and Physical Geography from Wittenburg University.

**Peter H. Prasthofer:** Dr. Pete Prasthofer received a B.S. and M.S. degrees in Engineering Mechanics from the Georgia Institute of Technology and a Ph.D. in Mechanical Engineering from the University of California at Davis. Currently he is seconded by Exxon Production Research Company to be Technical Manager of the Offshore Decommissioning Communications Project (PDCP), funded by some 70 companies in the Oil Industry International Exploration and Production Forum (E&P Forum), the UK Offshore Operators Association and the Norwegian Operators Association OLF. Pete Prasthofer has over 23 years experience in the oil and gas industry in various research, technical and operational assignments. He has had significant involvement in the area of offshore decommissioning for the last 12 years, focusing on technical, regulatory, and public policy and risk management issues in national, regional and international arenas. He has worked full time on this issue since early fall 1995. He served as chair of the E&P Forum's Engineering Committee from 1985-1997.

**J. Lisle Reed:** Dr. J. Lisle Reed was born and rear in Missouri. He attended the University of Missouri at Rolla (Missouri School of Mines), where he received his Bachelors, Masters of Science, and Doctorate degrees in Chemical Engineering. Following graduation, Dr. Reed worked for five years in the oil and petrochemical industry. Dr. Reed entered Federal Government

service in 1970, and during the 70's, he served in several management posts, including Director of Oil and Gas for both the Federal Energy Administration and the Department of Energy. After the oil crisis of 1979, Dr. Reed returned to the private sector, where he was involved in synthetic fuels projects. In 1983, Dr. Reed was asked to join the Department of the Interior, where he served as Deputy Under-Secretary and Science Advisor to the Secretary. Since 1988, he has served as the Director of the Pacific Outer Continental Shelf Region of the Minerals Management Service. His office is in Camarillo, California. Additionally, Dr. Reed was the Secretary's representative to the statutorily authorized Klamath Fishery Management Council from 1986 to 1995. The Council oversees the restoration of the Klamath river fishery resources and facilitates appropriate allocation for harvest.

**Villere C. Reggio, Jr.:** Villere Reggio is an Outdoor Recreation Planner with the Minerals Management Service, Gulf of Mexico OCS Region. His responsibilities include assessment, research, and reporting on the interrelationship of the OCS oil and gas program with the recreational elements of the marine and coastal environment throughout the Gulf region. For the past 21 years Mr. Reggio has had a special interest in evaluating the fisheries value and potential of oil and gas structures.

**John B. Richards:** John Richards is a marine advisor emeritus with the California Sea Grant Extension Program and a research biologist with the Marine Science Institute at the University of California, Santa Barbara. In 1976, he began development of marine extension and applied research program for the south-central coast of California and served as Area Marine Advisor for the counties of San Luis Obispo, Santa Barbara, and Ventura until 1992. During the 1980's, Richards helped initiate a communications and conflict resolution program, worked with an oil/fishing industry mediation team, and published the *Oil and Gas Project Newsletter for Fishermen and Offshore Operators*. John is now a member of a team conducting research in marine fisheries and shellfish aquaculture at the Marine Science Institute. He continues to work on statewide projects with the Sea Grant Extension Program. He has a B.A. in zoology from the University of California, Santa Barbara and an M.S. degree in fisheries biology from Oregon State University.

**Dwight Sanders:** Dwight Sanders joined the California State Lands Commission in 1975 following more than 8 years as staff to the California Legislature. Mr. Sanders is currently Chief of the Division of Environmental Planning and Management and in that capacity has been involved in proposed State and Federal offshore lease sales, and in the policy and environmental analyses of: 1) offshore seismic operations; 2) the installation and operation of onshore and offshore oil and gas related facilities; and 3) the decommissioning and removal of such facilities. Mr. Sanders also serves as one of the ex officio members of the California Coastal Commission, representing the Chair of the State Lands Commission, having received his appointment in 1982. Mr. Sanders is a UC Davis alumni, a graduate of the CORO Foundation, and also holds a Master of Public Administration.

**Russell J. Schmitt:** Dr. Russ Schmitt is a Professor in the Department of Ecology, Evolution and Marine Biology at UC Santa Barbara and Director of the Coastal Research Center of UCSB's Marine Science Institute. He received his Ph.D. from UCLA in 1979. Dr. Schmitt serves as Program Director for the Coastal Marine Institute and the Southern California Educational Initiative, which are cooperative research programs supported by the State of California, University of California and the Minerals Management Service. He is also Program Director of the UC Coastal Toxicology Training Program, a UC-wide component of the UC Toxics Substances Research and Teaching Program. Russ Schmitt's primary research programs address the abundance and dynamics of benthic marine animals. His interests in the application of basic ecology has led to his research on the design and implementation of environmental impact assessment studies.

**Nancy Settle:** Nancy Settle has managed the Regional Programs and Project Section for the Ventura County Planning Division over the past eight years. She oversees and supervises the County's involvement in Offshore and Onshore Oil Development and the California Offshore Oil and Gas Energy Resources (COOGR) study.

**John Smith:** John Smith is a Senior Environmental Coordinator with the Minerals Management Service's Office of Environmental Evaluation in Camarillo, California. He has a B.S. degree in geology and an M.S. degree in mineral economics from the Pennsylvania State

University. He joined the Department of the Interior in 1976 with the Bureau of Mines. In 1983 he joined the Minerals Management Service and since 1988 has been with the Pacific OCS Regional Office where he has served as senior environmental coordinator for major oil and gas development projects

**D. C. (Dave) Tyler:** Dave Tyler received his Bachelor of Science in Mechanical Engineering in 1981 from the University of California at Berkeley. In 1990, he received his Masters in Business Administration from the University of California at Los Angeles. He began his career with Exxon Company, U.S.A. in Los Angeles and worked in various engineering and regulatory positions associated with Exxon's offshore California and Alaska interests. Dave also led Exxon's permitting efforts for the Santa Ynez Unit Development during its 6-year construction phase, including removal of the Offshore Storage and Treatment Facility. In 1994, Dave moved to Midland, Texas, and became Regulatory Supervisor for production fields in the western U.S.. Dave moved to Houston in 1996 and was named to his current position as Public Affairs Advisor.

**Marina Voskanian:** Marina Voskanian is the Chief Reservoir Engineer with the California State Lands Commission (CSLC), supervising Reservoir Engineering and Geology section of the Mineral Resources Management Division located in Long Beach. Marina has been employed with the CSLC since 1987, and she has worked in private industry for eleven years prior to working for the State of California. During those years she held several engineering and supervisory positions with Exxon Oil Company, Southern California Gas Company, Aminoil and Phillips Petroleum company. Marina also serves on the Board of Directors of the Society of Petroleum Engineers, and is presently the Western Region Director representing California and Alaska. She has been recipient of several awards from professional organizations for her dedicated service to the industry. She received her graduate degrees in Petroleum Engineering from the University of Southern California (U.S.C.) in 1976. She has been part-time member of faculty, at the California Polytechnic University from 1984 through 1990, teaching petroleum engineering courses. Last few years, she has been part time lecturer at U.S.C. teaching graduate courses in Petroleum engineering.

**Maureen Walker:** Maureen Walker is the Deputy Director of the Office of Ocean Affairs, Bureau of Oceans and International Scientific and Environmental Affairs, U.S. Department of State. She joined the Department of State in 1983 as a Foreign Affairs Officer in the Division of Marine Law and Policy. She has been in her current position for the past 8 years.. She is the Chair of the U.S. delegations to international multilateral meetings on issues related to energy, natural resources and the environment. She has participated on the U.S. delegation to preparatory meetings to the United Nations Conference on Environment and Development (Rio Earth Summit) and negotiated key documents such as Agenda 21. She serves as Executive Secretariat to the National Security Council Interagency Working Group on Global Environmental Affairs Task Force on Law of the Sea, and also serves as U.S. lead negotiator within the Asia Pacific Economic Cooperation forum on marine conservation issues. Maureen Walker has a B.A. from Boston College, an M.A. from Georgetown University and a J.D. from the Catholic University of America.

**Bonnie Williamson:** Bonnie Williamson has been the Assistant to the Director of the Southern California Educational Initiative and the Coastal Marine Institute for the past 8 years. She is involved in the administrative and fiscal management of these and other research programs administered by the Coastal Research Center (CRC) at UC Santa Barbara. She serves as liaison between the faculty, staff, researchers, agency personnel, grant recipients and the Directors. Bonnie has served on the organizing committee for numerous conferences and workshops sponsored by the Coastal Research Center. Bonnie has a B.A. in Earth Sciences from SUNY Brockport and an M.A. in Geology from UC Santa Barbara.



---

---

## APPENDIX V

---

List of Attendees .....	257
-------------------------	-----



## LIST OF ATTENDEES

Over 370 people attended the Decommissioning Workshop. There were representatives from four Federal Departments and five Federal Agencies, six State Agencies, nine local and county agencies, ten academic institutions, seventeen citizen groups, and over sixty industry companies (oil producers, consultants and contractors), as well as several international representatives.

Barbara Abbriano (student)  
Santa Barbara City College  
Santa Barbara, CA

Allen Adams  
Minerals Management Service  
770 Paseo Camarillo  
Camarillo, CA 93010

Dolores Aguillar-Zepada  
Chevron USA, Inc.  
646 County Square Drive  
Ventura, CA 93003

Clement Alberts  
POOI  
2225 Sperry, Suite 1300  
Ventura, CA 93003

Jim Allen, President  
HydroDynamic Cutting  
Services  
P.O. Box 80843  
Lafayette, LA 70598

Richard Ambrose  
UC Los Angeles  
Envir. Sci. & Engineering Prog.  
Room 46-081 CHS Box  
951772  
Los Angeles, CA 90095-1772

Mike Ammann  
Chevron Research  
100 Chevron Way  
Richmond, CA 94802-0627

Doug Anthony  
Santa Barbara Co. Energy Div.  
1226 Anacapa Street, 2<sup>nd</sup> Floor  
Santa Barbara, CA 93101

Hector Hernandez Arana  
Instituto Nacional del la Pesca  
(Mexican Natl. Fisheries  
Institute)

Pitagoras 1320 Col. Sta. Cruz  
Atoyac  
D.F. 03310 Mexico

Roma Armbrust  
Coastal Issues Director  
League of Women Voters  
1151 Shelburn Lane  
Ventura, CA 93001

Ellen Aronson  
Minerals Management Service  
770 Paseo Camarillo, MS 7100  
Camarillo, CA 93010

Avis Austin  
League Of Women Voters  
1378 – 7<sup>th</sup> Street  
Los Osos, CA 93402-1223

Quang Bach  
Calif. State Lands Commission  
200 Oceangate, Ste 1200  
Long Beach, CA 90802

Lee Bafalon  
Chevron USA, Inc.  
646 County Square Drive  
Ventura, CA 93003

Brian Baird  
Ocean Program Manager  
The Resources Agency of  
Calif.

1416 9th Street, #1311  
Sacramento, CA 95814

Brian Balcom  
Regional Manager  
Continental Shelf Associates,  
Inc.  
310 3rd Avenue, N.E.  
Issaquah, WA 98027

Martha Barajas  
Minerals Management Service  
770 Paseo Camarillo  
Camarillo, CA 93010

Joan Barminski  
Minerals Management Service  
770 Paseo Camarillo  
Camarillo, CA 93010

Arthur Barnett  
MEC Analytical Systems, Inc.  
2433 Impala Drive  
Carlsbad, CA 92008

Kristine Barsky  
Calif. Dept. of Fish and Game  
530 E. Montecito Street, Rm.  
104  
Santa Barbara, CA 93103

R.C. (Rick) Barton  
New Ventures-Central Coast  
Aera Energy LLC  
P.O. Box 11164  
Bakersfield, CA 93389-1164

Chandra Basavalinganadoddi  
Calif. State Lands Commission  
200 Oceangate, Ste 1200  
Long Beach, CA 90802

John Baucke  
Bixby Ranch Company  
125 E. Victoria Street, Ste L  
Santa Barbara, CA 93101

Thomas Beamish  
Marine Science Institute  
University of California  
Santa Barbara, CA 93106

Dennis Bedford  
Calif. Dept. of Fish and Game  
330 Golden Shore, Ste 50  
Long Beach, CA 90802

Bill Beebe  
United Anglers of Southern  
Calif.  
Legislative Chair  
24958 Malibu Road  
Malibu, CA 90265

Theresa Bell  
Minerals Management Service  
770 Paseo Camarillo  
Camarillo, CA 93010

Jim Bellows  
Chevron Products Company  
575 Lennon Lane, Ste N2212  
Walnut Creek, CA 94598

Sue Benech  
Benech Biological Associates  
487 Lincoln Drive  
Ventura, CA 93001

Colleen Benner  
Minerals Management Service  
381 Elden St, MS 4041  
Herndon, VA 20170-4817

George Bennett  
UNOCAL  
2125 Knoll Drive, Ste 200  
Ventura, CA 93003

Terry Bertoline  
Calif. State Lands Commission  
P.O. Box 1237  
Goleta, CA 93116-1237

David "Chip" Blankenhorn  
Entrix, Inc.  
590 Ygnacia Valley Road,  
Ste 200  
Walnut Creek, CA 94596

Ken Blonden  
Commercial Fisherman  
321 Cahuenga Dr  
Oxnard, CA 93035

Tammy Blonden  
Light Boat Operator  
321 Cahuenga Dr  
Oxnard, CA 93035

Penny Bloodhart  
League of Women Voters  
1475 Theresa  
Carpenteria, CA 93103

Dave Blurton  
Calif. Dept. of Fish and Game  
P.O. Box 944209  
Sacramento, CA 94244

Arthur Boehm  
Nuevo Energy Company  
201 South Boadway  
Orcutt, CA 93455

Peter Bontadelli, Administrator  
Office of Oil Spill Prevention  
and Response  
Calif. Dept. of Fish and Game  
1416 9th Street  
Sacramento, CA 95814

Marianne Boucher  
Minerals Management Service  
770 Paseo Camarillo  
Camarillo, CA 93010

Major Paul Boughman  
U.S. Marine Corps  
Staff Judge Advocate  
1st MEF  
Camp Pendleton, CA 92055-  
5400

Edward Boyes  
Calif. Dept. of Fish and Game  
330 Golden Shore, Ste 50  
Long Beach, CA 90802

Paul Bradford  
2nd District Supervisor Staff  
SB County Board of  
Supervisors  
105 E. Anapuma Street  
Santa Barbara, CA 93101

John Brandon  
Oil States Micro Cutting  
Services  
18501 Aldin Westfield  
Houston, TX 77073

Jerry Brashier  
Minerals Management Service  
1201 Elmwood Park Blvd.,  
MS 5440  
New Orleans, LA 70123-2394

Julia Braun (student)  
Santa Barbara City College  
Santa Barbara, CA

Nancy E. Brodbeck  
Torch Operating Company  
500 N. Kraemer Blvd., Bldg B  
Brea, CA 92821

Dean Brown  
Brown & Root Energy Services  
110 Capital Drive, Ste 200  
Lafayette, LA 70508

David Browne  
Minerals Management Service  
770 Paseo Camarillo  
Camarillo, CA 93010

Sharon Buffington  
Minerals Management  
Services  
381 Elden MS 4021  
Herndon, VA 20170

Dianna Burce  
American Pacific Marine  
741 East Arcturus Ave.  
Oxnard, CA 93033

Steve Burke  
Torch Operating Company  
500 N. Kraemer Blvd., Bldg. B  
Brea, CA 92821

Todd Busch  
Crowley Marine  
P.O. Box 2287  
Seattle, WA 98111

Dr. Robert Byrd  
Twachtman, Snyder & Byrd,  
Inc.  
13105 Northwest Freeway, Ste  
700  
Houston, TX 77040

Tim Cagle Exxon P.O. Box 2180 Houston, TX 77252	Curtis Clark 31 Quinto Santa Barbara, CA 93105	Jeff Damron Padre Associates, Inc. 5450 Telegraph Road, Ste 101 Ventura, CA 93003
Bruce Campbell P. O. Box 761 Summerland, CA 93067-0761	Del Clement Chevron USA, Inc. 646 County Square Drive Ventura, CA 93003	Elmer "Bud" Danenberger Minerals Management Service 381 Elden Street, MS4020 Herndon, VA 20170-4817
Rob Campbell-Taylor Venoco P.O. Box 8540 Goleta, CA 93118	Richard Clingan Minerals Management Service Santa Maria District Office 222 W. Carmen Lane, Ste 201 Santa Maria, CA 93455	Mark Demeo Calif. State Lands Commission P.O. Box 1237 Goleta, CA 93116-1237
Peter Cantle Santa Barbara County APCD Air Pollution and Control District 26 Castilian Drive, B-23 Goleta, CA 93117	Brian Collins UC Berkeley 2324 Piedmont Ave. Berkeley, CA 94704	Kathy deWet-Oleson Sea Ventures Dive Boat 5286 Shiloh Way Ventura, CA 93003
Mark Carr Department of Biology UC Santa Cruz Santa Cruz, CA 95064	Steve Coombs Pacific Operators Offshore Inc. 205 E. Carrillo Street, Ste 200 Santa Barbara, CA 93101	Frank DeMarco Central Coast Regional Water Quality Control Board 81 Higuera Street, Ste 200 San Luis Obispo, CA 93401
Roger Carry Torch Operating Company Santa Maria, CA	Tim Cooper Chevron USA, Inc. 646 County Square Drive Ventura, CA 93003	Alison Dettmer California Coastal Commission 45 Fremont Street, Ste 2000 San Francisco, CA 94105- 2219
Mike Carter 556 Canyon Vista Drive Newbury Park, CA 91320	Patrick Corcoran Ogden Environmental 1 E. Anapamu Street Santa Barbara, CA 93101	Onno deWaard Heere Mac v.o.t P.O. Box 9321 2300 PH Leiden The Netherlands
Carlos Casrian State Lands Commission 200 Oceangate, 12 <sup>th</sup> Floor Long Beach, CA 90802	Gordon Cota Southern Calif. Trawlers Assoc. 706 Surfview Drive Santa Barbara, CA 93109	Leray DeWit L.A. deWit, Consultant 2054 Bluerock Circle Concord, CA 94521-1672
Arturo Castañon Instituto Nacional De La pesca Cirios No. 178 Fracc. Las Fincas Ensenada, B.C. 22810 Mexico	Adriana Crasnean Office of the State Fire Marshal 1501 W. Cameron, C-250 West Covina, CA 91790	Doug Diener MEC Analytical Systems, Inc. 2433 Impala Drive Carlsbad, CA 92008
Dee W. Chamberlain Arco 444 South Flower Street, ALF-3433 Los Angeles, CA 90071	Andrew Culwell V.P. Special Projects American Pacific Marine 741 East Arcturus Ave. Oxnard, CA 93033	Robert Dimitroff Chevron Facilities Engineering 1301 McKinney Houston, TX 77010
Marc Chytillo Environmental Defense Center 906 Garden Street, #2 Santa Barbara, CA 93101	Steve Curran Calif. State Lands Commission 200 Oceangate, 12 <sup>th</sup> Floor Long Beach, CA 90802	

Dr. Robert Ditton  
Dept. of Wildlife & Fisheries  
Sciences  
Texas A & M University  
College Station, TX 77840-  
2258

Frank Donahue  
Commercial Trawler, Owner-  
Operator  
P. O. Box 792  
Avila Beach, CA 93424

J. Donlon  
United Anglers of Southern  
Calif.  
716 Calle Palo Colorado  
Santa Barbara, CA 93105

William Douros  
Santa Barbara Co. Energy Div.  
1226 Anacapa Street  
Santa Barbara, CA 93101

Roderick Draughon  
International Flow Corp.  
23500 64th Avenue South  
Kent , WA 98032

Barbara Dugal  
Calif. State Lands Commission  
100 Howe Avenue, Ste 100  
South  
Sacramento, CA 95825

Barbie Dugan  
Cal Poly San Luis Obispo  
331 Oahu Street  
Morro Bay, CA

Candy Dugan  
Fugro West Inc.  
1421 State Street  
Santa Barbara, CA 93101

Dan Dugan  
Cal Poly San Luis Obispo  
331 Oahu Street  
Morro Bay, CA 93442

Dr. Jenifer Dugan  
Marine Science Institute  
University of California  
Santa Barbara, CA 93106

Mary Elaine Dunaway  
Minerals Management Service  
770 Paseo Camarillo  
Camarillo, CA 93010

Tom Dunaway  
Minerals Management Service  
770 Paseo Camarillo  
Camarillo, CA 93010

Chuck Ebner  
Oceaneering Intl., Inc.  
2055 N. Ventura Avenue  
Ventura, CA 93001

Hannah Eckberg  
Get Oil Out  
914 Anacapa St  
Santa Barbara, CA 93101

Mark Eckenrode  
Minerals Management Service  
770 Paseo Camarillo  
Camarillo, CA 93010

Stefanie Edmondson  
City of Carpinteria  
5775 Carpinteria Avenue  
Carpinteria, CA 93013

Deborah Eidson  
Minerals Management Service  
770 Paseo Camarillo  
Camarillo, CA 93010

Alan Emslie  
Padre Associates, Inc.  
5450 Telegraph Road, Ste 101  
Ventura, CA 93003

John Engle  
Marine Science Institute  
University of California  
Santa Barbara, CA 93106

Iraj Ershaghi  
Professor and Director  
University of Southern  
California  
Hedco 316, University Park  
Los Angeles, CA 90089-1211

Bryn Evans  
Marine Science Institute  
University of California  
Santa Barbara, CA 93106

Matt Evans  
Torch Operating Company  
500 N. Kraemer Blvd, Bldg. B  
Brea, CA 92821

Ellie Fairbairn (student)  
Santa Barbara City College  
Santa Barbara, CA

Maurya Falkner  
Calif. State Lands Commission  
Marine Facilities Division  
330 Golden shore, Ste 210  
Long Beach, CA 90802-4246

Rod Farrell  
Padre Associates, Inc.  
5450 Telegraph Road, Ste 101  
Ventura, CA 93003

A.J. Field  
Benech Biological Associates  
487 Lincoln Drive  
Ventura, CA 93001

Steve Fields  
Calif. Dept. of Conservation  
Div. Oil, Gas & Geothermal  
Res.  
1000 South Hill Road, Ste 16  
Ventura, CA 93003-4458

Jennifer Foster  
Santa Barbara Co. Energy Div.  
1226 Anacapa Street 2nd Floor  
Santa Barbara, CA 93101-  
2010

Nancy Francis  
Ventura County,  
Resource Mgmt. Agency /  
Planning Div.  
L-1740  
800 South Victoria Ave.  
Ventura, CA 93009

Darryl Francois  
Minerals Management Service  
1849 C. St., NW  
MS 0100  
Washington, DC 20240

Daniel Frumkes  
United Anglers of Southern  
Calif.  
24958 Malibu Road  
Malibu, CA 90265

Craig Fusaro  
Joint Oil/Fisheries Liaison  
Office  
121 Gray Avenue, Ste 205A  
Santa Barbara, CA 93101

Dave Gabauer  
Minerals Management Service  
770 Paseo Camarillo  
Camarillo, CA 93010

Peter Gamble  
ADL  
3916 State Street, Ste 2A  
Santa Barbara, CA 93105

Robert C. Gardner  
Fairweather E & P Services,  
Inc.  
241 Market Street, No. 3  
Port Hueneme, CA 93041-  
3218

Michelle Gasperini  
Santa Barbara Co. Energy Div.  
1226 Ancapa Street, 2<sup>nd</sup> Floor  
Santa Barbara, CA 93101

Michael Gialketsis  
Rincon Consultants  
790 E. Santa Clara Street  
Ventura, CA 93001

Marty Golden  
National Marine Fisheries  
Service  
501 W. Ocean Blvd., Ste 4200  
Long Beach, CA 90802

Daniel Gorfain  
Calif. State Lands Commission  
Div. of Envir. Planning & Mgmt.  
100 Howe Ave., 100-South  
Sacramento, CA 95825-8202

Bill Grady  
Exxon  
P. O. Box 5025  
Thousand Oaks, CA 91359

James Grant  
Minerals Management Service  
770 Paseo Camarillo  
Camarillo, CA 93010

Gary Gray  
Chevron USA, Inc.  
646 County Square Drive  
Ventura, CA 93003

Gary Gregory  
Calif. State Lands Commission  
200 Oceangate, 12<sup>th</sup> Floor  
Long Beach, CA

Steve Greig  
1014 Santa Barbara Street  
Santa Barbara, CA 93101

W.S. (Bill) Griffin  
Internat'l Regulation Consultant  
E & P Forum  
International Exploration &  
Production  
25/28 Old Burlington Street  
London, W1X 1LB  
England

Mark Griffith  
OST  
Ventura, CA

Robert Grove  
Southern California Edison  
2244 Walnut Grove Avenue  
Rosemead, CA 91770

Richard Habrat  
Minerals Management Service  
770 Paseo Camarillo  
Camarillo, CA 93010

M.L. Hagood  
Arco  
444 South Flower Street  
ALF-3433  
Los Angeles, CA 90071

Bobbie Hall  
Minerals Management Service  
770 Paseo Camarillo  
Camarillo, CA 93010

William Hamner  
Dept. of Biology  
University of California  
Los Angeles, CA

Connie Hannah  
SB League of Women Voters  
5194 Calle Asilo  
Santa Barbara, CA 93111

Susan Hansch, Deputy Director  
Energy & Ocean Resources  
Unit  
California Coastal Commission  
45 Fremont Street, Ste 2000  
San Francisco, CA 94105-  
2219

Dane Hardin  
Applied Marine Sciences, Inc.  
2155 Las Positas Court, Ste. S  
Livermore, CA 94550

Dean Hargis  
Dames & Moore  
5383 Hollister Avenue, Ste 120  
Santa Barbara, CA 93111

Marty Harter  
1039 South Seaward  
Ventura, CA 93001

Per Bull Haugsoen  
Offshore Shuttle AS  
Stranden 3A  
0250 Oslo  
Norway

Wendy Hawksworth (student)  
Santa Barbara City College  
Santa Barbara, CA

Donna Hebert  
Padre Associates, Inc.  
5450 Telegraph Road, Ste 101  
Ventura, CA 93003

Mark Helvey  
NOAA/National Marine  
Fisheries Service  
777 Sonoma Avenue, Rm 325  
Santa Rosa, CA

Steve Henry  
Fish & Wildlife Biologist  
2493 Portola Rd., Ste B  
Ventura, CA 93003

Jerry Hensley  
Chevron USA, Inc.  
646 County Square Drive  
Ventura, CA 93003

Joann Herrick  
Minerals Management Service  
770 Paseo Camarillo  
Camarillo, CA 93010

Michael Higgins  
Water Quality Control Board  
Central Coast Region  
81 Higuera St., Ste 200  
San Luis Obispo, CA 93401-  
5427

Robert Hight, Executive Officer  
Calif. State Lands Commission  
100 Howe Ave., Ste 100 South  
Sacramento, CA 95825

Maurice Hill  
Minerals Management Service  
770 Paseo Camarillo  
Camarillo, CA 93010

Cathy Hoffman  
Minerals Management Service  
770 Paseo Camarillo  
Camarillo, CA 93010

Arne Holhjem  
Phillips Petroleum  
6330 W. Loop South  
Bellaire, TX 77401

Frank Holmes  
Western States Petroleum  
Assoc.  
121 Gray Avenue, Ste 205  
Santa Barbara, CA 93101

Jean Holmes  
Santa Barbara League of  
Womens Voters  
3749 Brenner Drive  
Santa Barbara, CA 93105-  
2407

Tim Holmes  
U.S. Coast Guard  
BLDG 50-6  
Coast Guard Is  
Alameda, CA 94501-5100

Keith Howell  
Chevron USA, Inc.  
646 County Square Drive  
Ventura, CA 93006

Peter Howorth  
Marine Mammal Consulting  
Group  
389 West Hope Avenue  
Santa Barbara, CA 93110

Maher Ibrahim  
Minerals Management Service  
770 Paseo Camarillo  
Camarillo, CA 93010

Eiji Imamura  
Marine Research Specialists  
3639 E. Harbor Blvd., Ste 208  
Ventura, CA 93001

Merrill Jacobs  
Clean Seas  
1180 Eugenia Place, #204  
Carpinteria, CA 93013

James Johnson  
California Coastal Commission  
89 So. California St., 2nd Floor  
Ventura, CA 93001

James P. Johnson  
Phillips Petroleum  
6330 W. Loop South  
Bellaire, TX 77401

Jay A. Johnson  
Applied Marine Sciences, Inc.  
2155 Las Positas Court, Ste S  
Livermore, CA 94550

Pete Johnson  
Chief Petroleum Engineer  
Calif. State Lands Commission  
200 Oceangate, 12th Floor  
Long Beach, CA 90802-4331

John Jones  
Exxon  
P. O. Box 2189  
Houston, TX 77252

Lynne Kada  
Ventura County Resources  
Agency  
800 So. Victoria Ave.  
Ventura, CA 93009

Carolita Kallaur  
Minerals Management Service  
Offshore Minerals  
Management  
1849 C Street, NW, MS 4230  
Washington, DC 20240-0001

Lisa Kay  
MEC Analytical Systems, Inc.  
2433 Impala Drive  
Carlsbad, CA 92008-7227

Charles Kelm  
Halliburton Energy Services  
1450 Poydras Street, Ste 2170  
New Orleans, LA 70112

Jeff Kennedy  
Minerals Management Service  
770 Paseo Camarillo  
Camarillo, CA 93010

Stephen J. Kenney  
Bigge Crane & Rigging Co.  
10700 Bigge Street  
San Leandro, CA 94577

Pat Kinnear  
Calif. Dep.t of Conservation  
Div. of Oil, Gas & Geothermal  
Resources  
1000 S. Hill Road, Ste 16  
Ventura, CA 93003

Donna Kleeberg  
Port Hueneme Commercial  
Fisherman  
3900 San Simeon Ave  
Oxnard, CA 93033

Dan Knowlson  
Minerals Management Service  
222 W. Carmen Lane, Ste 201  
Santa Maria, CA 93458



Karin Koch  
M.F. Strange & Associates  
P. O. Box 1484  
Santa Barbara, CA 93102

Andrew Konczvald  
Minerals Management Service  
770 Paseo Camarillo  
Camarillo, CA 93010

Linda Krop  
Environmental Defense Center  
906 Garden Street, # 2  
Santa Barbara, CA 93101

A.W. Krueger  
Thyssen Steel  
P.O. Box 19686  
Houston, TX 7724-19686

John Lane  
Minerals Management Service  
770 Paseo Camarillo  
Camarillo, CA 93010

Herb Leedy  
Minerals Management Service  
770 Paseo Camarillo  
Camarillo, CA 93010

Peter Leigh  
National Marine Fisheries  
Service  
Building 3, Room 12607  
1315 East West Highway  
Silver Springs, MD 20910-  
3282

John Lien  
Calif. State Lands Commission  
100 Howe Avenue,  
Ste 100-South  
Sacramento, CA 95825-8202

Eddie Lee Lim  
Minerals Management Service  
770 Paseo Camarillo  
Camarillo, CA 93010

James Lima  
Minerals Management Service  
770 Paseo Camarillo  
Camarillo, CA 93010

Joseph Lima  
Goleta, CA

Andrew Lissner  
SAIC  
10260 Campus Point Dr., MS  
C-5  
San Diego, CA 92121-1578

Andrew Lord  
Marine Science Institute  
University of California  
Santa Barbara, CA 93106

Bob Love  
Love Fishing and Diving Co.  
139 Stanford Avenue  
Oxnard, CA 93030

Dr. Milton Love  
Marine Science Institute  
University of California  
Santa Barbara, CA 93106

Charles MacDonald  
Office of the State Fire Marshal  
Dept. of Forestry & Fire  
Protection  
1501 W. Cameron C-250  
West Covina, CA 91790

Michael Machuzak  
Aquatic Bioassay &  
Consulting Labs  
29 N. Olive Street  
Ventura, CA 93001

Tony Mackay  
Brown & Root Energy Services  
Wellhead Place  
Dyce, Aberdeen AB2 0GG  
SCOTLAND

Vance Mackey  
Chevron Petroleum Tech.  
Comp.  
6001 Bollinger Canyon Road  
P.O. Box 5045  
San Ramon, CA 94583-0945

Frank Manago  
Minerals Management Service  
770 Paseo Camarillo  
Camarillo, CA 93010

Michael Marks  
Mobil Exploration & Producing  
1250 Poydras, Ste 1436  
New Orleans, LA 70113

Phil Marquez  
Exxon Company, USA  
P.O. Box 4358  
Houston, TX 77210-4358

Gail Martin  
B & J Martin, Inc.  
P.O. Box 448  
Cut Off, LA 70345

Jimmie Martin  
B & J Martin, Inc.  
P.O. Box 448  
Cut Off, LA 70345

Sue Martin  
Santa Barbara Co. Planning  
Dept.  
1226 Anacapa Street  
Santa Barbara, CA 93101

Scott Martindale  
Chevron USA, Inc.  
646 County Square Drive  
Ventura, CA 93003

Jorge Escobar Martinez  
ECODES-SAI  
Ecologia y Desarrollos, S.P.  
Blvd. Teniente Azueta 130-1  
Recinto Portuario  
Ensenada, B.C. 22800  
Mexico

Nabil Masri  
Minerals Management Service  
770 Paseo Camarillo  
Camarillo, CA 93010

Tom Matteucci  
Rincon Consultants  
790 E. Santa Clara Street  
Ventura, CA 93001

Annisa Mayer  
Office of the Vice Chancellor –  
Research  
Chancellor's Office  
2234 Murphy Hall  
UC Los Angeles  
Los Angeles, CA 90095-1405

Randy Mayes  
Standard Ind.  
P.O. Box 23278  
Ventura, CA 93002

Jack McCarthy  
Minerals Management Service  
770 Paseo Camarillo  
Camarillo, CA 93010

Mike McCorkle  
Southern Calif. Trawlers  
Assoc.  
P.O. Box 713  
Summerland, CA 93067

Merit McCrea  
Captain McCrea's Sportfishing  
1762-1/2 Prospect Ave.  
Santa Barbara, CA 93103

Genie McGaugh  
Ventura County APCD  
669 County Square Dr  
2nd Floor  
Ventura, CA 93003

Cris McGuffee  
Exxon  
P.O. Box 22180  
Houston, TX 77252-2180

Melissa Meeker  
Marine Science Institute  
University of California  
Santa Barbara, CA 93106

Paul Mehta  
QST Environmental  
17390 Brookhurst Street  
Ste 110  
Fountain Valley, CA 92708

Bob Mense  
Minerals Management Service  
381 Elden St., MS 4050  
Herndon, VA 20170-4817

Jerry Menesez  
Mobil Oil  
P.O. Box 8540  
Goleta, CA 93118

Steve Merrit  
Chevron USA, Inc.  
646 County Square Dr  
Ventura, CA 93003

Robert Middleton  
Minerals Management Service  
1849 C. Street NW  
Washington, DC 20240

Tim Mikel  
Aquatic Bioassay &  
Consulting Labs  
29 N. Olive Street  
Ventura, CA 93001

Stuart Miller (student)  
Santa Barbara City College  
Santa Barbara, CA

Mary Ann Milosavich  
Minerals Management Service  
381 Elden Street, MS 4030  
Herndon, VA 20170-4817

Jeff Milton  
Staff Geological Engineer  
5060 California Avenue  
Bakersfield, CA 93389

Charles Mitchell  
MBC Applied Environmental  
Sciences  
3040 Redhill Ave  
Costa Mesa, CA 92626

Mike Mitchell  
Minerals Management Service  
Santa Maria District Office  
222 W. Carmen Lane, Ste 201  
Santa Maria, CA 93455

Tooraj Monsef  
Calif. State Lands Commission  
200 Oceangate, 12th Floor  
Long Beach, CA 90802

Mick Mora (student)  
Santa Barbara City College  
Santa Barbara, CA

Frank Morin  
Longitude 123  
1080 Stillwater Court  
Ventura, CA 93004

Mike Moropoulos  
Santa Barbara, CA

Paul Mount, II, Chief  
Minerals Resources Mgmt. Div.  
Calif. State Lands Commission  
200 Oceangate, 12th Floor  
Long Beach, CA 90802-4471

Andrew Moynagh  
Building and Construction  
Trades Council AFL-CIO  
415 Chapala Street  
Santa Barbara, CA 93101

Tim Murphy  
Morton Associates, Inc.  
5973 Encina Road, Ste 100  
Goleta, CA 93117-2273

Steven Murray  
Dept. of Biological Science  
MH 282 P.O. Box 6850  
CalState Fullerton  
Fullerton, CA 92834-9480

Aiden Naughton (retired)  
Calif. State Lands Commission  
200 Oceangate, Ste 200  
Long Beach, CA 90802

Geir Nilsen  
Commerical Fisherman  
P.O. Box 1376  
Summerland, CA 93067

Mary Nishimoto  
Marine Science Institute  
UC Santa Barbara  
Santa Barbara, CA 93106

Suzanne Noble  
WSPA,  
Coastal Environmental  
Coordinator  
121 Gray Avenue, Ste 205  
Santa Barbara, CA 93101

Craig Ogawa  
Minerals Management Service  
770 Paseo Camarillo  
Camarillo, CA 93010

Dave Ono  
Calif. Dept. of Fish and Game  
530 E. Montecito St., Rm 104  
Santa Barbara, CA 93103-  
1207

H. Mark Page Marine Science Institute University of California Santa Barbara, CA 93106	Greg Pelka Calif. State Lands Commission 200 Oceangate, 12th Floor Long Beach, CA 90802-4471	Patricia Port U.S. Dept. of the Interior Office of Environmental Policy & Compliance 600 Harrison Street, Ste 515 San Francisco, CA 94107- 1376
Christina Palmer (student) Santa Barbara City College Santa Barbara, CA	Jim Penny Crowley Marine Pier D, Berth 47 Long Beach, CA 90802	Simon Poulter Padre Associates, Inc. 5450 Telegraph Road, Ste 101 Ventura, CA 93003
Lisa Palmer Davies Communications 808 State Street Paseo Nuevo Santa Barbara, CA 93101	Luis Perez Santa Barbara Co. Energy Div. 1226 Anacapa Street Santa Barbara, CA 93101	Peter Prasthofer ODCP c/o E&P Forum 25/28 Old Burlington St London, W1X 1LB England
W.W. Palmquist United Anglers of Southern Calif. 716 Calle Palo Colorado Santa Barbara, CA 93105	Larry Perkins Chevron 575 Lennon Lane N2214 Walnut Creek, CA 94598	Barbara Price Phillips Petroleum Company 6330 W. Loop South, Rm 1473 Bellaire, TX 77401
Dave Panzer Minerals Management Service 770 Paseo Camarillo Camarillo, CA 93010	Vincent Peteque (student) Santa Barbara City College Santa Barbara, CA	Tom Raftican United Anglers of Southern Calif. 716 Calle Palo Colorado Santa Barbara, CA 93105
Dave Parker Senior Biologist Calif. Dept. of Fish and Game Marine Resources Division 330 Golden Shore, Ste 50 Long Beach, CA 90802	Larry Philip Calif. State Lands Commission P.O. Box 1237 Goleta, CA 93116-1237	Peter Raimondi Department of Biology UC Santa Cruz Santa Cruz, CA 95064
John Patton, Director Santa Barbara County Dept. of Planning & Development 123 East Anapamu Street Santa Barbara, CA 93101	Robert Phillips Minerals Management Service 770 Paseo Camarillo Camarillo, CA 93010	Hamid Rastegar Aspen Environmental Group 30423 Canwood Street, Ste 218 Agoura Hills, CA 91301
Eleanor Paulazzo Goleta, CA	Mark Pierson Minerals Management Service 770 Paseo Camarillo Camarillo, CA 93010	John Reed Heeremac Offshore Services 17154 Butte Creek, Ste 200 Houston, TX 77090
Margaret Peavey (student) Santa Barbara City College Santa Barbara, CA	Dr. Fred Piltz Minerals Management Service 770 Paseo Camarillo Camarillo, CA 93010	Dr. Lisle Reed Minerals Management Service 770 Paseo Camarillo Camarillo, CA 93010
Mike Peek Torch Operating Company 500 N Kraemer Blvd, Bldg B Brea, CA 92821	Ron Pitman Marine Sciences 900 Avenida Salvador San Clemente, CA 92672- 2323	
John Peirson Arthur D. Little 3916 State Street, Ste 2A Santa Barbara, CA 93109	Tobe Plough Consultant P.O. Box 5731 Santa Barbara, CA 93150	

Villere Reggio  
Minerals Management Service  
1201 Elmwood Park  
Boulevard, MS 5410  
New Orleans, LA 70123-2394

John Richards  
Marine Science Institute  
University of California  
Santa Barbara, CA 93106

G. Ed Richardson  
Minerals Management Service  
1201 Elmwood Park Blvd.,  
MS 5441  
New Orleans, LA 70123-2394

Peggy Rivas  
Minerals Management Service  
770 Paseo Camarillo  
Camarillo, CA 93010

David Robinson  
MEC Analytical Systems, Inc.  
2433 Impala Drive  
Carlsbad, CA 92008

J.B. Rodieck  
Twitchman, Snyder & Byrd,  
Inc.  
13105 Northwest Freeway, Ste  
700  
Houston, TX 77040

Maggie Roe  
J. Walter Thompson  
4 Embarcadero Center  
San Francisco, CA 94115

Eric Rogger  
United Anglers of Southern  
Calif.  
24958 Malibu Road  
Malibu, CA 90265

John Romero  
Minerals Management Service  
770 Paseo Camarillo  
Camarillo, CA 93010

Jacqueline Romo  
Minerals Management Service  
770 Paseo Camarillo  
Camarillo, CA 93010

Albert Ronyecz  
Advance Technical Services  
116 Lancaster Place  
Goleta, CA 93117

Chris Roper  
American Pacific Marine  
741 East Arcturus Ave.  
Oxnard, CA 93033

Brock Rosenthal  
Mecco California  
7709 Prospect Place  
La Jolla, CA 92037

David Rosenberg  
UC Berkeley  
P.O. Box 148  
Morgan City, LA 70381

Bob Rydgig  
P.O. Box 733  
Camarillo, CA 93011

Alicia Sabry  
Calif. State Lands Commission  
200 Oceangate, 12<sup>th</sup> Floor  
Long Beach, CA 90802

Manny Saenz  
Minerals Management Service  
770 Paseo Camarillo  
Camarillo, CA 93010

Dwight Sanders  
Chief, Div. of Envir. Plan. &  
Mgmt  
Calif. State Lands Commission  
100 Howe Avenue, 100-South  
Sacramento, CA 95825

Greg Sanders  
Calif. State Lands Commission  
200 Oceangate, 12<sup>th</sup> Floor  
Long Beach, CA 90802-4331

Dale Saunders  
Office of the State Fire Marshal  
Dept. of Forestry & Fire  
Protection  
1501 W. Cameron C-250  
West Covina, CA 91790

Jochen Schene  
Thyssen Steel  
Germany

Kim Schizas  
Wynmark Inc.  
6500 Hollister Avenue, Ste 100  
Goleta, CA 93117

Russell Schmitt  
Marine Science Institute  
University of California  
Santa Barbara, CA 93106

Jennifer Scholl  
Aspen Environmental Group  
30423 Canwood Street, Ste  
218  
Agoura Hills, CA 91301

Greg Schrage  
Unocal  
2323 Knool Drive  
Ventura, CA 93003

Phillip Schroeder,  
District Supervisor  
Minerals Management Service  
Santa Maria District Office  
222 W. Carmen Lane, Ste 201  
Santa Maria, CA 93455

Donna Schroeder  
Marine Science Institute  
University of California  
Santa Barbara, CA 93106

Richard Schubel  
U.S. Army Corps of Engineers  
911 Wilshire Blvd.  
Los Angeles, CA 90017

Alan Scott  
Calif. State Lands Commission  
100 Howe Avenue,  
Ste 100 South  
Sacramento, CA 95825

Steven Seat  
Phillips Petroleum Company  
6330 W. Loop South, Rm 1473  
Bellaire, TX 77401

Nancy Settle  
Ventura County Planning  
800 S. Victoria Avenue, L #  
1740  
Ventura, CA 93009

Keith Seydel  
Marine Science Institute  
University of California  
Santa Barbara, CA 93106

Glenn Shackell  
Minerals Management Service  
770 Paseo Camarillo  
Camarillo, CA 93010

Arvind Shah  
Minerals Management Service  
1201 Elmwood Park Blvd.  
New Orleans, LA 70123-2394

Allan Shareghi  
Minerals Management Service  
770 Paseo Camarillo  
Camarillo, CA 93010

Shannon Shaw  
Minerals Management Service  
770 Paseo Camarillo  
Camarillo, CA 93010

Gary Shepherd  
Pipeline Safety Engineer  
Office of the State Fire Marshal  
Dept. of Forestry & Fire  
Protection  
1501 W. Cameron C-250  
West Covina, CA 91790

Kelly Siddiqui  
Minerals Management Service  
770 Paseo Camarillo  
Camarillo, CA 93010

Paul Simon  
United Anglers of Southern  
Calif.  
24958 Malibu Road  
Malibu, CA 90265

Bob Smith  
Minerals Management Service  
381 Elden Street  
Herndon, VA 20170

Charles Smith  
Minerals Management Service  
381 Elden Street  
Herndon, VA 20170-4817

Eric Smith  
Dept. of Political Science  
University of California  
Santa Barbara, CA 93106

John Smith  
Minerals Management Service  
770 Paseo Camarillo  
Camarillo, CA 93010

Martyn Snape  
Oil States Micro-Cutting  
Services  
18501 Aldin Westfield  
Houston, TX 77073

Ralph Snyder  
Minerals Management Service  
770 Paseo Camarillo  
Camarillo, CA 93010

Rick Sorrell  
U.S. Coast Guard  
Marine Safety Detachment  
111 Harbor Way  
Santa Barbara, CA 93109

Ed Spaulding  
The Chevron Companies  
P.O. Box 1392  
Bakersfield, CA 93302

Mark Steffy  
Longitude 123  
1080 Stillwater Court  
Ventura, CA 93004

John Stephens  
Vantuna Research Group  
2550 Nightshade Place  
Arroyo Grande, CA 93420

Dr. Theresa Stevens  
U.S. Army Corps of Engineers  
2151 Alessandro Drive, Ste  
255  
Ventura, CA 93001

Alex Stiem  
Chevron USA, Inc.  
646 County Square Dr  
Ventura, CA 93003

Bill Stolp  
Dames & Moore  
2445 W. Shaw Avenue, Ste  
101  
Fresno, CA 93711

Marianne Strange  
M.F. Strange & Associates  
P.O. Box 1484  
Santa Barbara, CA 93102

Melanie Stright  
Minerals Management Service  
381 Elden Street  
Herndon, VA 20170

Mark Swearingen  
1015 Chino Street  
Santa Barbara, CA 93101

Win Swint  
Arroyo Burro Reef Company  
62 Canon View Road  
Montecito, CA 93108

Ron Tan  
Santa Barbara County APCD  
26 Castilian Dr B-23  
Goleta, CA 93117

Bill Thomas  
Squid Boat Operator  
Santa Barbara, CA

Randy Thompson  
Oceaneering Intl., Inc.  
2055 N. Ventura Avenue  
Ventura, CA 93001

Rosie Thompson  
SAIC  
816 State Street, Ste 500  
Santa Barbara, CA 93101

Bill Thompson  
Commercial Trawler, Owner-  
Operator  
Santa Barbara, CA

Win Thornton  
Winmar Consulting  
12020 West Little York, Ste  
200  
Houston, TX 77041

Lyman Thorsteinson  
U.S. Geological Survey  
Biological Resources Division  
909 First Avenue, Ste 800  
Seattle, WA 98104

Guillermo Torres  
Universidad Autonoma de Baja  
California  
Facultad de Ciencias Marinas  
KM 103 Carretera  
Tijuana-Ensenada  
Ensenada, Baja California,  
Mexico  
CP 22880

John L. Trahan  
Ventura County Fish and  
Game  
1078 Peninsula Street  
Ventura, CA 93001

Ron Tripe  
Calif. State Lands Commission  
P.O. Box 1237  
Goleta, CA 93116-1237

Rishi Tyagi  
Minerals Management Service  
770 Paseo Camarillo  
Camarillo, CA 93010

David C. Tyler  
Exxon Co., USA  
P.O. Box 2180  
Houston, TX 77252-2180

Tom Umenhofer  
Sierra Pacific Environmental  
5951 Encina Road, Ste 206  
Goleta, CA 93117

Duane VanderPlayen  
Rincon Consultants  
790 E. Santa Clara Street  
Ventura, CA 93001

Eugenie Van Schoten  
League of Women Voters  
2430 Bayside Pl.  
Arroyo Grande, CA 93420

Diane Vavrek  
Chevron  
1163 Main Street, Ste C  
Morro Bay, CA 93442

Lynnette Vesco  
Minerals Management Service  
770 Paseo Camarillo  
Camarillo, CA 93010

Marina Voskanian  
Calif. State Lands Commission  
200 Oceangate, 12<sup>th</sup> Floor  
Long Beach, CA 90802

Kirk Walker  
Calif. State Lands Commission  
100 Howe Avenue,  
Ste 100 South  
Sacramento, CA 95825

Maureen Walker  
Chief, Office of Ocean Affairs  
U.S. Department of State  
2201 C Street, NW., Rm 5805  
Washington, DC 20520

Sara Wan  
California Coastal Commission  
22350 Carbon Mesa  
Malibu, CA 90265

Libe Washburn  
Department of Geography  
UC Santa Barbara  
Santa Barbara, CA 93106

Tim Watson  
Amoco (U.K.) Exploration  
Amoco House  
Westgate  
London, W5 1XL  
United Kingdom

Chris Weakley  
Santa Barbara, CA

Matt Weidmann (student)  
Santa Barbara City College  
Santa Barbara, CA

Julie Welch  
Rincon Consultants  
790 E. Santa Clara Street  
Ventura, CA 93001

Tiffany Welch  
U.S. Army Corps of Engineers  
Ventura Reg. Field Office  
2151 Alessandro Drive., Ste  
255  
Ventura, CA 93001

Bill Welsh  
Dames & Moore  
5383 Hollister Ave #120  
Santa Barbara, CA 93111

Fred White  
Minerals Management Service  
770 Paseo Camarillo  
Camarillo, CA 93010

Nancy Wilhelmsen  
Camarillo, CA

Richard Wilhelmsen  
Minerals Management Service  
770 Paseo Camarillo  
Camarillo, CA 93010

Al Willard  
Supervising Engineer  
Calif. State Lands Commission  
Minerals Resources Mgmt. Div.  
200 Oceangate, 12th Floor  
Long Beach, CA 90802-4331

Richard Williams  
Save Our Shellfish  
c/o Bob Evans Designs  
715 Kimball  
Santa Barbara, CA 93103

Bonnie Williamson  
Marine Science Institute  
University of California  
Santa Barbara, CA 93106

Ken Wilson  
Calif. Dept. of Fish and Game  
Oil Spill Prevention &  
Response  
Santa Barbara, CA

James Wiseman  
UC Berkeley  
2119 Russell Street, Apt. A  
Berkeley, CA 94705-1048

Elverlene Wms-Flatts  
Minerals Management Service  
770 Paseo Camarillo  
Camarillo, CA 93010

Rochelle Wms-Hooks  
Minerals Management Service  
770 Paseo Camarillo  
Camarillo, CA 93010

Steve Wolfson  
Minerals Management Service  
770 Paseo Camarillo  
Camarillo, CA 93010

Issac Wood  
Santa Barbara City College  
(student)  
Santa Barbara, CA

Debbie Woods  
UC Berkeley  
Institute of Industrial Relations  
2521 Channing Way, #5555  
Berkeley, CA 94720-5555

Paul Z. Wright  
Get Oil Out  
914 Anacapa St  
Santa Barbara, CA 93101

Kristin Zabaronick  
Marine Science Institute  
University of California  
Santa Barbara, CA 93106

Kerby Zozula  
Ventura County APCD  
669 County Square Dr., 2nd  
Floor  
Ventura, CA 93003

Louis Zylstra  
American Pacific Marine  
14841 Yorba Street, Ste 101  
Tustin, CA 92780

