

APPENDIX 2. AIRPORT TECHNICAL ADVISORY.

Subject: Electromagnetic interference (EMI) induced by L-828, SCR Type, Constant Current Regulators (CCRs).

Some airports have experienced excessive levels of EMI which degrades the performance of some of the airport's air navigational systems, i.e. RVRs, glide slope localizers, ATCTS, etc., SCR type, L-828, CCRs, are the likely sources of EMI due to their inherent operating characteristics. The following are some of the cautionary steps that may help decrease EMI and/or its adverse effects in the airport environment.

1. Cables for airfield lighting circuits should not be installed in the same conduit, cable duct or duct bank as control and communication cables.
2. Cables for airfield lighting systems should not be installed such that they cross control and/or communications cables.
3. In some cases, harmonic filters may be installed at the regulator output to reduce the EMI emitted by the CCR. These filters are available from some CCR manufacturers.
4. Spare control and communications cables should be grounded.
5. Inform manufacturers, designers, engineers, etc., about the existing navigational equipment and the potential for interference.
6. Electromagnetic compatibility between new equipment and existing equipment should be a requirement in project contracts. Operational acceptance test(s) may be required to verify compliance.

For more information contact the FAA Office of Airport Safety and Standards, FAA Engineering, 800 Independence Avenue, SW, Washington, DC 20591.

Intentionally left blank.

APPENDIX 3. TERMS & ACRONYMS.

AC	Alternating Current
Accelerate-stop distance available	The runway plus stopway length declared available and suitable for the acceleration and deceleration of an airplane aborting a takeoff
AIP	Airport Improvement Program
ALD	Available Landing Distance
ALS	Approach Lighting System
ALSF	Approach Lighting System with Sequenced Flashing Lights
ANSI	American National Standards Institute
ASDA	Accelerated-stop distance available
ASTM	American Society for Testing and Materials
ATC	Air Traffic Control
ATCT	Air Traffic Control Tower
CAN/CSA	Canadian Standards Association
CAT I	Facility providing operation down to 200 feet (61 m) decision height and runway visual range not less than 2,400 feet (732 m)
CAT II	Facility providing operation down to 100 feet (30 m) decision height and runway visual range not less than 1,200 (366 m) feet
CAT III	Facility providing operation with no decision height limit and along the surface of the runway with external visual reference during final phase of landing and with a runway and runway visual range not less than 600 feet (183 m), down to 0.
CCR	Constant Current Regulator
Cd	Candela (a unit of luminous intensity)
CL	Center Line
CTAF	Common Traffic Advisory Frequency
DC	Direct Current
DEB	Direct Earth Burial
Declared Distances	The distances declared available and suitable for satisfying the airplane

takeoff run, takeoff distance, accelerate-stop distances, and landing distance requirements. The distances are ASDA, LDA, TORA and TODA.

Displaced Threshold	A threshold that is located at a point on the runway other than the designated beginning of the runway.
DWG	Drawing
E-982	Steady-burning Approach Lights
EMI	Electromagnetic Interference
EMT	Electro-Mechanical Tubing
FAA	Federal Aviation Administration
HIRL	High Intensity Runway Edge Lights
I/O	Input/Output
ICEA	Insulated Cable Engineers Association
IEEE	Institute of Electrical and Electronics Engineers
IFR	Instrument Flight Rules
ILS	Instrument Landing System
ISO	International Standards Organization
KV	Kilovolt
KVA	Kilovolt Ampere
KW	Kilowatt
L-850C	Style 3 Flush in-pavement light fixture
L-852D	Taxiway centerline for CAT III
L-852E, F	Runway Guard Light in-pavement
L-852G	Combination Runway Guard
L-852G/S	Combination Runway Guard/Stop Bar Light in-pavement
L-852S	Stop Bar Light in-pavement
L-853	Reflective Markers
L-854	Radio Controller (Pilot Controlled Lights)

L-858R, Y, L, B	Guidance Signs
L-860	Low-Intensity Elevated Light
L-861	Medium-Intensity Elevated Runway/Taxiway Light
L-862	High-Intensity Elevated Runway Edge Light
L-867	Non-load Bearing Base Cans
L-868	Load Bearing Base Cans
L-880/ L-881	Precision Approach Path Indicators (PAPI)
L-884	Land and Hold Short Operations (LAHSO) Power Control Unit (PCU)
LAHSO	Land and Hold Short Operations
Landing Distance Available	The runway length declared available and suitable for a landing aircraft.
LDA	Landing Distance Available
LDIN	Lead-In Lighting System
LHU	Light Housing Unit
LIRL	Low Intensity Runway Edge Lights
MALS	Medium-intensity Approach Lighting System
MALSF	Medium-intensity Approach Lighting System with Sequenced Flashers
MALSR	Medium-intensity Approach Lighting System with Runway Alignment Indicator Lights
MIRL	Medium Intensity Runway Edge Lights
MITL	Medium Intensity Taxiway Lights
MLS	Microwave Landing System
NAS	National Airspace System
NEC	National Electrical Code
NEMA	National Electrical Manufacturers Association
NFPA	National Fire Protection Association

Non-precision Approach Runway	Runway with only horizontal guidance available
Non-precision Instrument Runway	A runway having an existing instrument approach procedure utilizing air navigation facilities with only horizontal guidance for which a straight-in or side-step non-precision approach procedure has been approved.
NOTAM	Notice To Airmen
NRTL	Nationally Recognized Testing Laboratory
OCS	Obstacle Clear Surface
ODALS	Omnidirectional Approach Lighting System
OFZ	Obstacle Free Zone
OSHA	Occupational Safety and Health Administration
PAPI	Precision Approach Path Indicator
PAR	Precision Approach Radar
PC	Point of Curvature
PCU	Power and Control Unit
PLC	Programmable Logic Controller
POFZ	Precision Obstacle Free Zone
Precision Approach Runway	Full instrument approach procedure and equipment available (ILS or MLS)
Precision Instrument Runway	A runway having an existing instrument approach procedure utilizing air navigation facilities with both horizontal and vertical guidance for which a precision approach procedure has been approved.
PT	Point of Tangency
RCL	Runway Centerline Lighting
REIL	Runway End Identifier Lights
RGL	Runway Guard Lights
ROFA	Runway Object Free Area
RPZ	Runway Protection Zone
RSA	Runway Safety Area

RSAT	Runway Safety Action Team
Runway Environment	The physical runway and the areas surrounding the runway out to the holding position marking.
Runway Object Free Area	An area on the ground centered on a runway provided to enhance the safety of aircraft operations by having the area free of objects, except for objects that need to be located in the OFA for air navigation or aircraft ground maneuvering purposes.
Runway Protection Zone	An area off the runway end used to enhance the protection of people and property on the ground.
Runway Safety Area	A defined surface surrounding the runway prepared or suitable for reducing the risk of damage to airplanes in the event of an undershoot, overshoot, or threshold.
RVR	Runway Visual Range
SCR	Silicon Controlled Rectifier
SMGCS	Surface Movement Guidance and Control System
SPDT	Single Pole Double Throw
Takeoff distance available	The TORA plus the length of any remaining runway and/or clearway beyond the far end of the TORA.
Takeoff runway available	The runway length declared available and suitable for the ground run of an airplane taking off.
TDZ	Touchdown Zone
Threshold	A line perpendicular to the runway centerline marking the beginning of the runway surface available for a landing.
TODA	Takeoff distance available
TORA	Takeoff run available
UL	Underwriter's Laboratory
UPS	Uninterruptible Power Supply
VAC	Voltage Alternating Current
VDC	Voltage Direct Current
VFR	Visual Flight Rules
Visual Runway	Runway with no instrument approach procedure/equipment

Intentionally left blank.

APPENDIX 4. BIBLIOGRAPHY.

1. AC 00-2, Federal Register, Advisory Circular Checklist and Status of Federal Aviation Regulations, updated tri-annually, contains the listing of all current issuances of ACs and changes thereto. It explains the circular numbering system and gives instructions for ordering ACs that are for sale as well as those distributed free of charge. AC 00-2 also gives instructions for ordering the Federal Aviation Regulations.

- a. FAA ACs. Copies of the current edition of the AC may be obtained at no charge from the FAA Website at:

www.faa.gov/airports/airtraffic/airports/resources/advisory_circulars/

Or:

U.S. Department of Transportation
Subsequent Distribution Office
Ardmore East Business Center
3341 Q 75th Ave.
Landover, MD 20785
Telephone: (301) 322-4961
FAX: (301) 386-5394

- (1) AC 70/7460-1, *Obstruction Marking and Lighting*.
- (2) AC 120-28, *Criteria for Approval of Category III Landing Weather Minima for Takeoff, Landing, and Rollout*.
- (3) AC 120-29, *Criteria for Approval of Category I and Category II Landing Minima for Approach*.
- (4) AC 120-57, *Surface Movement Guidance and Control System (SMGCS)*.
- (5) AC 150/5000-3, *Address List for Regional Airports Divisions and Airports District Offices*.
- (6) AC 150/5000-13, *Announcement of Availability--RTCA Inc., Document RTCA-221*.
- (7) AC 150/5200-30, *Airport Winter Safety and Operations*.
- (8) AC 150/5300-13, *Airport Design*.
- (9) AC 150/5340-1, *Standards for Airport Markings*.
- (10) AC 150/5340-26, *Maintenance of Airport Visual Aid Facilities*.
- (11) AC 150/5345-3, *Specification for L-821 Panels for Control of Airport Lighting*.
- (12) AC 150/5345-5, *Circuit Selector Switch*.
- (13) AC 150/5345-7, *Specification for L-824 Underground Electrical Cable for Airport Lighting Circuits*.

- (14) AC 150/5345-10, *Specification for Constant Current Regulators and Regulator Monitors.*
 - (15) AC 150/5345-12, *Specification for Airport and Heliport Beacons.*
 - (16) AC 150/5345-13, *Specification for L-841 Auxiliary Relay Cabinet Assembly for Pilot Control of Airport Lighting Circuits.*
 - (17) AC 150/5345-26, *Specification for L-823 Plug and Receptacle, Cable Connectors.*
 - (18) AC 150/5345-27, *Specification for Wind Cone Assemblies.*
 - (19) AC 150/5345-28, *Precision Approach Path Indicator (PAPI) Systems.*
 - (20) AC 150/5345-39, *FAA Specification L-853, Runway and Taxiway Retroreflective Markers.*
 - (21) AC 150/5345-42, *FAA Specification L-867, L-868, Airport Light Bases, Transformer Housing, Junction Boxes, and Accessories.*
 - (22) AC 150/5345-43, *Specification for Obstruction Lighting Equipment.*
 - (23) AC 150/5345-46, *Specification for Runway and Taxiway Light Fixtures.*
 - (24) AC 150/5345-47, *Specification for Series to Series Isolation Transformers for Airport Lighting Systems.*
 - (25) AC 150/5345-49, *Specification L-854, Radio Control Equipment.*
 - (26) AC 150/5345-50, *Specification for Portable Runway Lights.*
 - (27) AC 150/5345-51, *Specification for Discharge-Type Flasher Equipment.*
 - (28) AC 150/5345-53, *Airport Lighting Equipment Certification Program.*
 - (29) AC 150/5345-54, *Specification for L-884 Power and Control Unit for Land and Hold Short Lighting Systems.*
 - (30) AC 150/5345-56, *Specification for L-890 Airport Lighting Control and Monitoring Systems (ALCMs).*
 - (31) AC 150/5370-2, *Operational Safety on Airports During Construction.*
 - (32) AC 150/5370-10, *Standards for Specifying Construction of Airports.*
- b. Electronic copies of FAA Standards may be obtained from: <https://dmrs.faa.gov> .
- (1) FAA Order 7110.118, *Land and Hold Short Operations (LAHSO).*
 - (2) FAA Order 6030.20A, *Electrical Power Policy.*
 - (3) FAA Order 6850.2, *Visual Guidance Lighting Systems.*

- (4) FAA Order 6950.11, *Reduced Electrical Power Interruptions at FAA Facilities*.
- (5) FAA Order 6950.27, *Short Circuit Analysis and Protective Device Case Study*.
- c. FAA drawings may be obtained from:
- FAA William J. Hughes Technical Center
NAS Documentation Facility, ACK-1
Atlantic City International Airport
New Jersey, 08405
- (1) FAA DWG C-6046, *Frangible Coupling Type I and Type IA, Details*.
- (2) Engineering Brief #61, *Installation Procedures for Adjustable Light Bases and Extensions*.
- (3) FAA-C-1391, *Installation and Splicing of Underground Cable*.
- (4) FAA-E-2083, *Bypass Switch, Engine Generator*.
- (5) FAA-E-2204, *Diesel Engine Generator Sets, 10kw to 750kw*.
- (6) FAA-E-2325, *Medium Intensity Approach Lighting System with Runway Alignment Indicator Lights*.
- (7) 14 CFR Part 77, *Objects Affecting Navigable Airspace*.
- (8) 14 CFR Part 139, *Certification of Airports*.
- d. Electronic copy of the Aeronautical Information Manual (AIM) may be obtained from: www.faa.gov.
2. **Federal Specifications.** Copies of Federal specifications may be obtained at no charge from: General Services Administration Offices in Washington, DC, and other cities. For access to Federal Specifications go to: <http://apps.fss.gsa.gov/pub/fedspecs>.
- U.S. General Services Administration
1800 F Street, NW
Washington, DC 20405
- a. Federal Specification J-C-145, *Cable, Power, Electrical and Wire, Electrical (Weather-Resistant)*.
- b. Federal Specification TT-P-28, *Paint, Aluminum, Heat Resisting (1200 Deg. F.)*.
- c. FED-STD-595, *Colors Used in Government Procurement*.
3. **American Society for Testing and Materials (ASTM) Specifications, Test Methods, Standard Practices, and Recommended Practices.** Copies of ASTM specifications, test methods, and recommended practices may be obtained from: American Society for Testing and Materials. Contact them at: www.astm.org

American Society for Testing and Materials
1916 Race Street
Philadelphia, PA 19103

- a. ASTM C-892, *Standard Specification for High Temperature Fiber Blanket Thermal Insulation.*
 - b. ASTM D-3407, *Standard Test Method for Joint Sealants, Hot Poured, for Concrete and Asphalt Pavements.*
 - c. ASTM A-53, *Standard Specification for Pipe, Steel, Black and Hot-Dipped, Zinc-coated, Welded and Seamless.*
 - d. ASTM-A184, *Standard Specification for Fabricated Deformed Steel Bar Mats for Concrete Reinforcement.*
 - e. ASTM-A704, *Standard Specification for Welded Steel Plain Bar or Rod Mats for Concrete Reinforcement.*
4. **National Fire Protection Association (NFPA):** Copies of the National Electrical Code (NEC) Handbook may be obtained at: www.nfpa.org.

NFPA
1 Batterymarch Park
Quincy, Massachusetts
USA 02169-7471

5. **American National Standards Institute (ANSI).** Copies of ANSI standards may be obtained from the National Standards Institute. Contact them at: www.ansi.org

ANSI
1819 L Street, NW, 6th floor
Washington, DC 20036

- a. ANSI/ICEA S-85-625, *Telecommunications Cable Air Core, Polyolefin Insulated, Copper Conductor, Technical Requirements*

6. **RTCA, Incorporated.** Copies of RTCA documents may be obtained from:

RTCA, Incorporated
1828 L Street, NW, suite 805
Washington, D.C. 20036

Contact the RTCA Online Store at: www.rtca.org/onlinecart/index.cfm

7. *The Design, Installation, and Maintenance of In-Pavement Airport Lighting*, by Arthur S. Schai, Library of Congress Catalog Card Number #86-81865.

This publication is available free of charge at the FAA AAS-100 website:

www.faa.gov/airports_airtraffic/airports/

**APPENDIX 5. TYPICAL INSTALLATION DRAWINGS FOR AIRPORT LIGHTING
EQUIPMENT.**

The following drawings depict typical installation methods for various types of airport lighting equipment and are acceptable for use on projects funded under the AIP. However, the drawings may need to be revised to accommodate local site conditions and/or special requirements.

Details of equipment and installation methods will be provided by manufacturers.

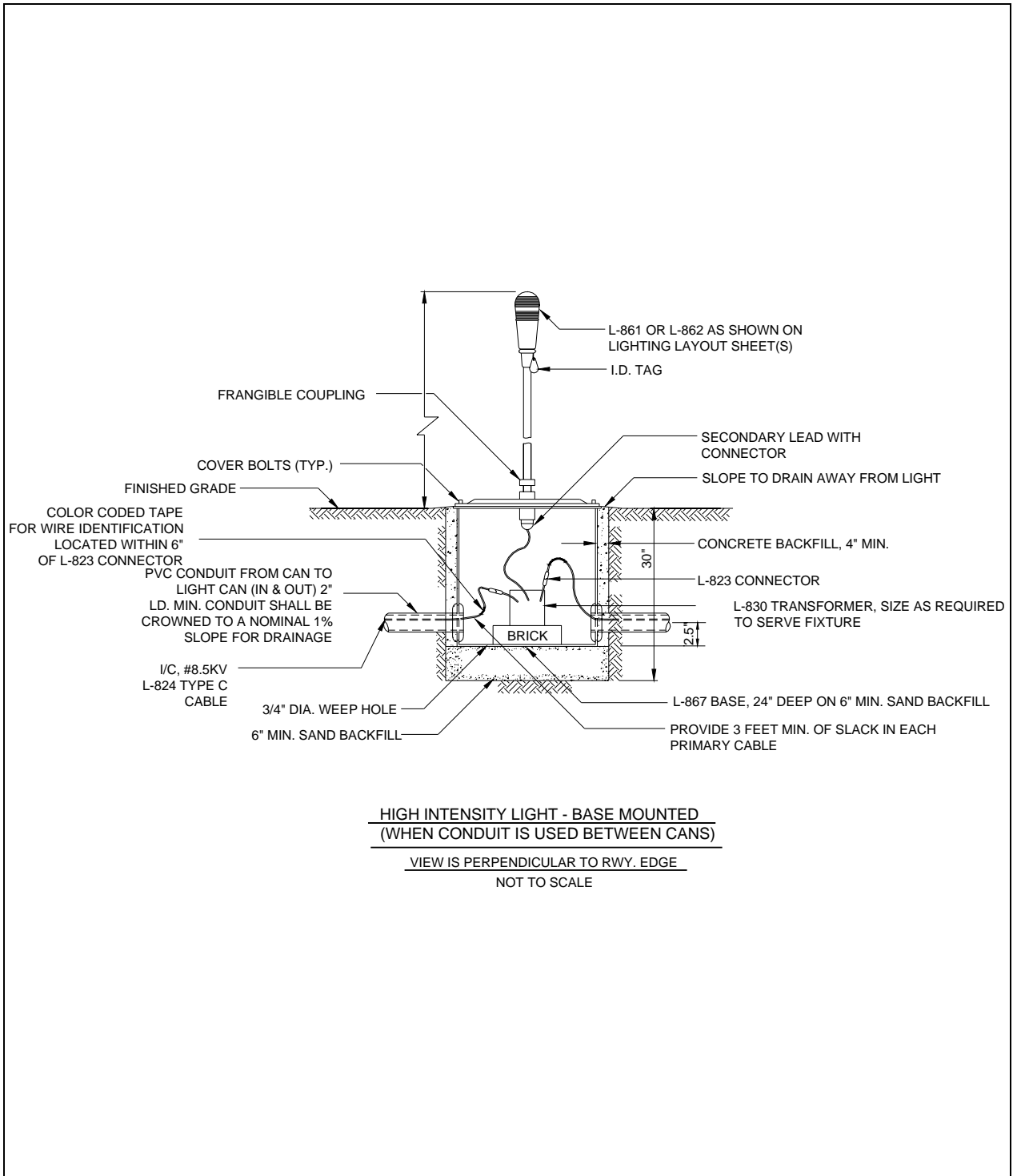

Figure 113. Typical Standard Details for Runway & Taxiway Edge Lights –High Intensity Light – Non-adjustable Base-mounted.

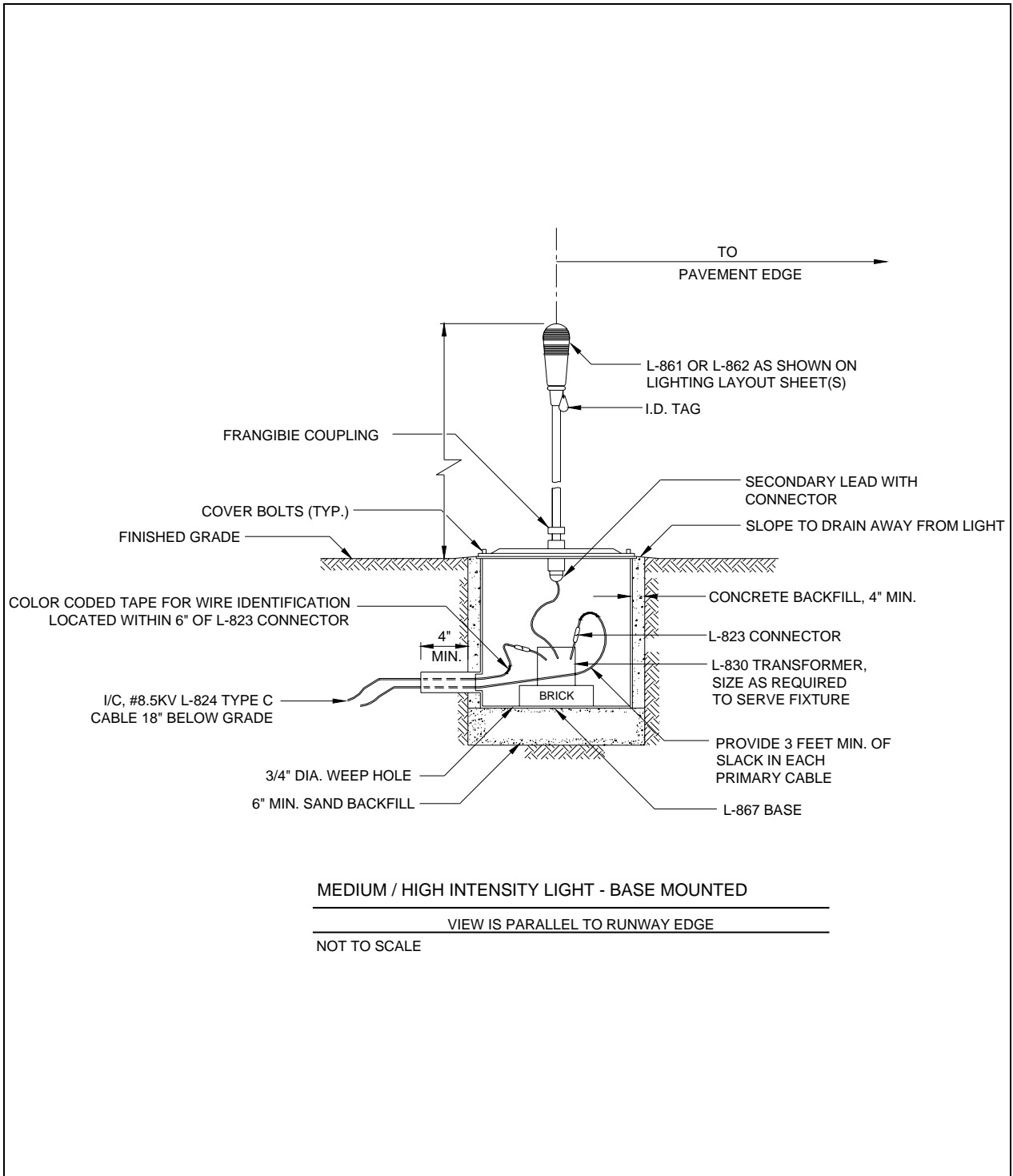
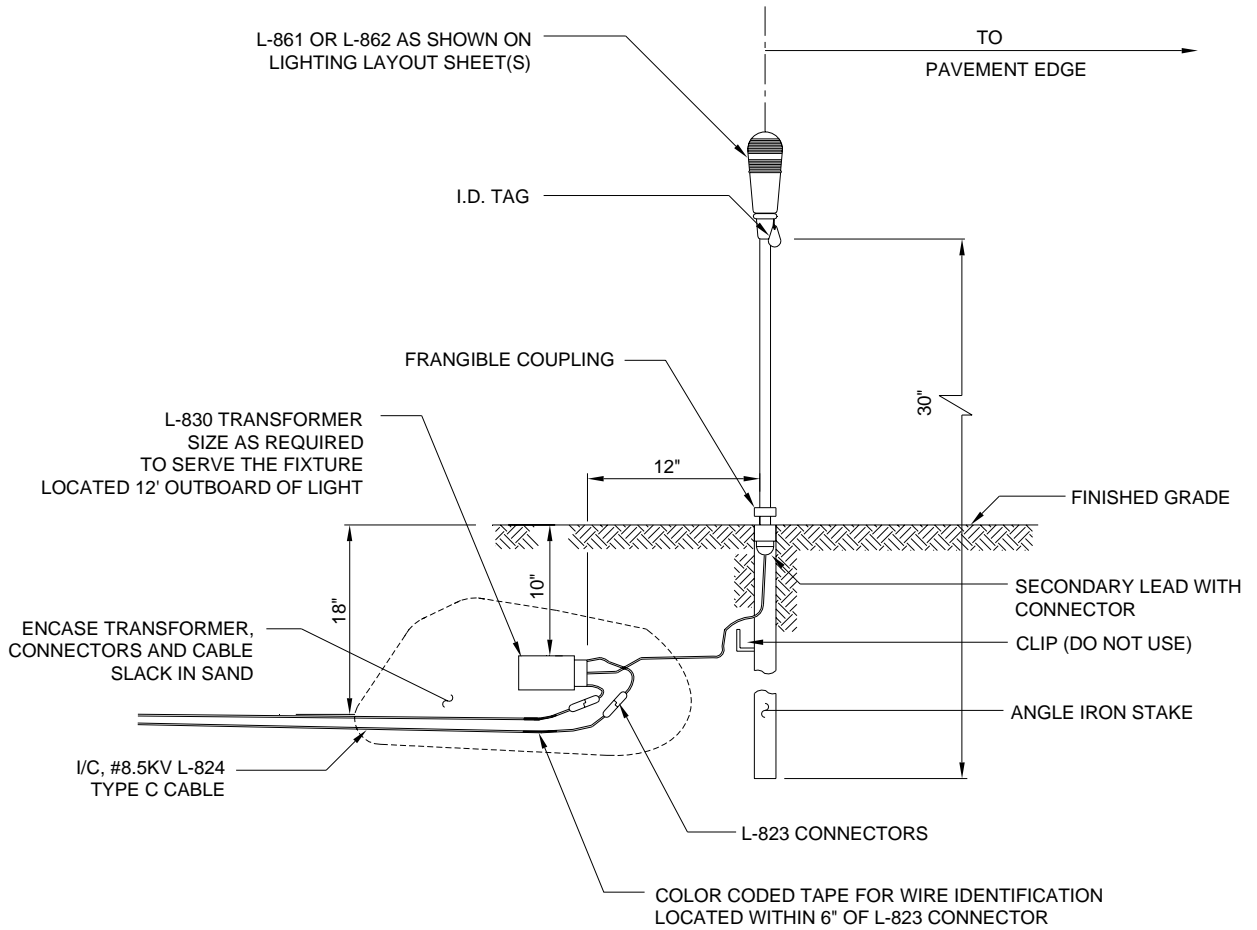

Figure 114. Typical Standard Details for Runway & Taxiway Edge Lights –Medium / High Intensity Light – Non-adjustable Base-mounted.



NOTE:
SEE FIGURE 107 FOR EDGE LIGHT ELEVATIONS.

MEDIUM INTENSITY LIGHT - STAKE MOUNTED
FRANGIBLE COUPLING

Figure 115. Typical Standard Details for Runway & Taxiway Edge Lights –Medium Intensity Light – Stake-mounted.

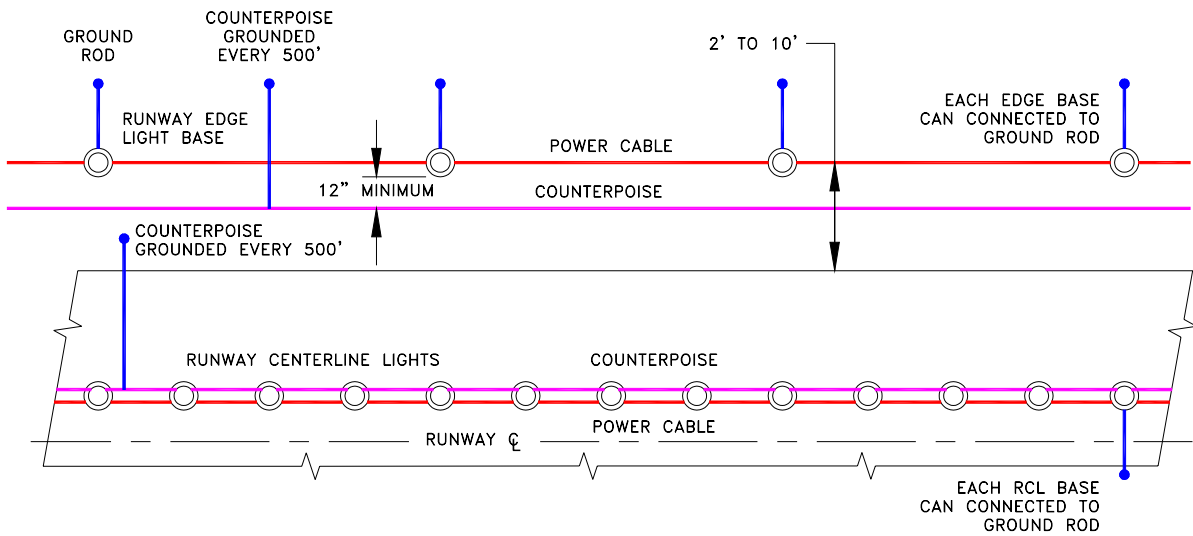

NOTE:

PROVIDE THE SECOND TRENCH FOR THE COUNTERPOISE. ROUTE THE COUNTERPOISE AROUND THE CAN A MINIMUM OF 12" TOWARDS THE RUNWAY PAVEMENT. TYPICALLY, ANY LIGHTING STRIKE WILL HIT THE CROWN OF THE PAVEMENT FIRST AND MIGRATE ACROSS THE PAVEMENT TOWARDS THE COUNTERPOISE.

COUNTERPOISE GUIDANCE
(BETWEEN POWER CABLE AND EDGE OF PAVEMENT)

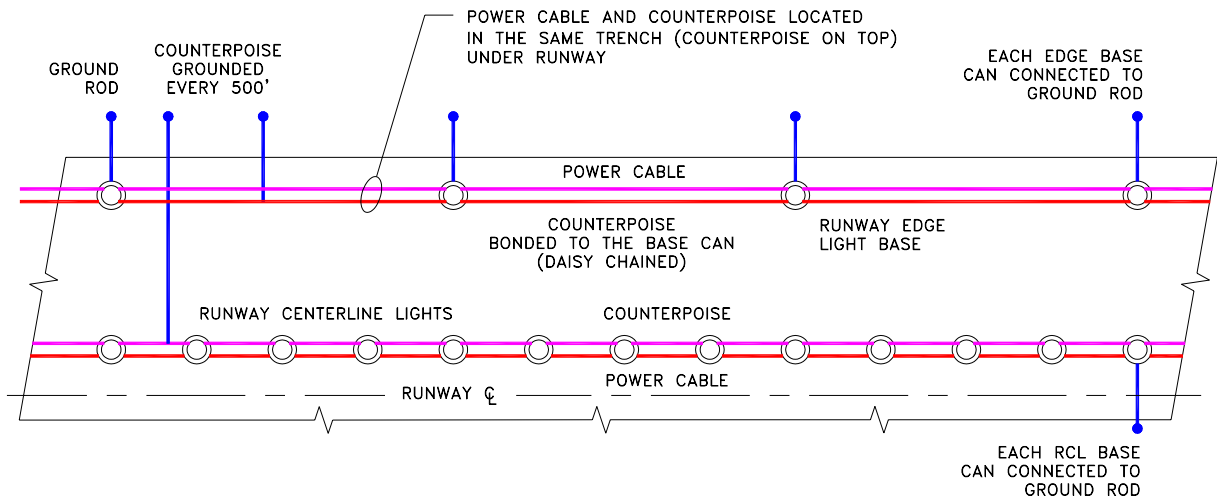

COUNTERPOISE GUIDANCE
(UNDER PAVEMENT)

Figure 116. Typical Counterpoise and Ground Rod Connections

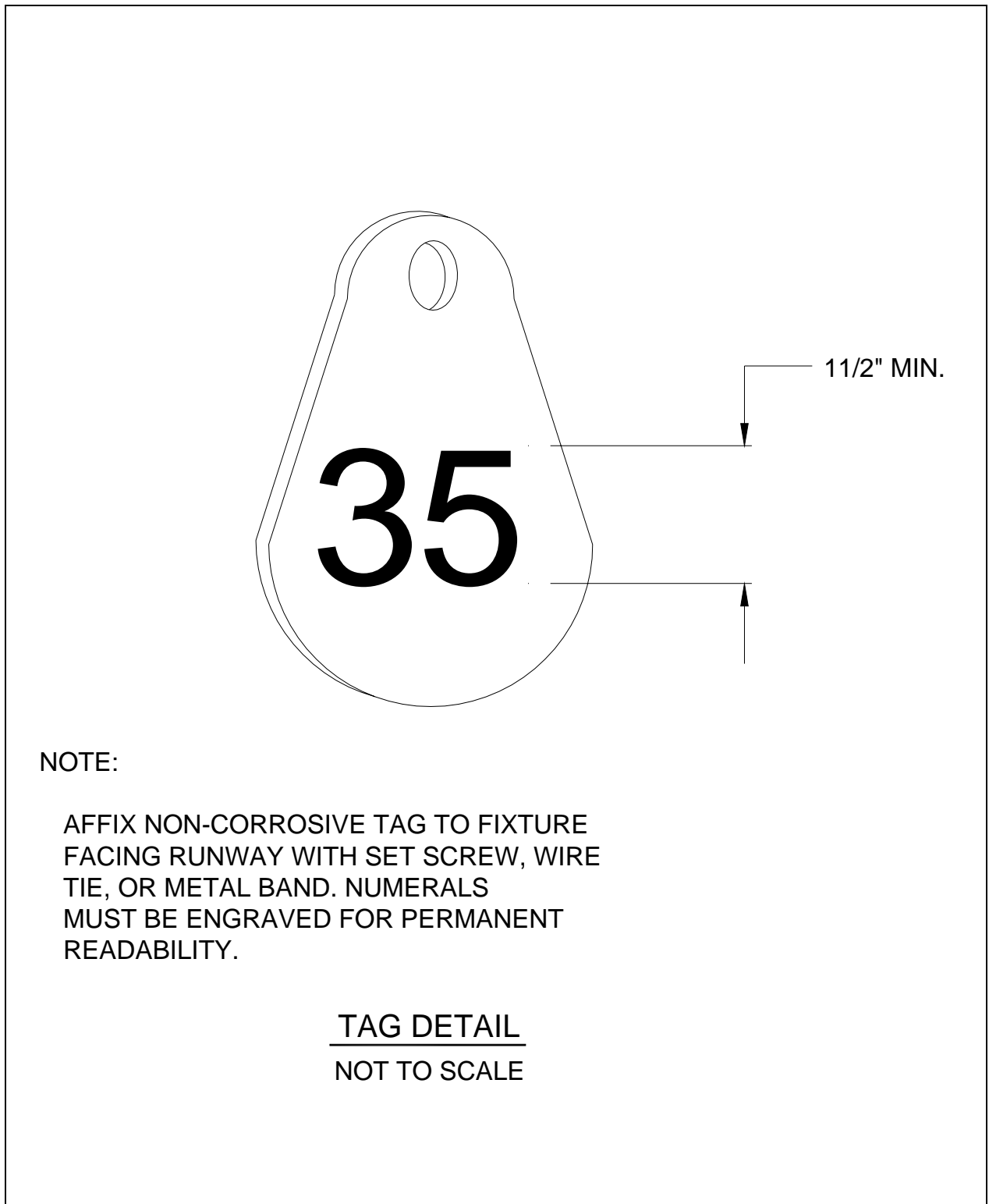

NOTE:

AFFIX NON-CORROSIVE TAG TO FIXTURE
FACING RUNWAY WITH SET SCREW, WIRE
TIE, OR METAL BAND. NUMERALS
MUST BE ENGRAVED FOR PERMANENT
READABILITY.

TAG DETAIL
NOT TO SCALE

Figure 117. Identification (ID) Tag Detail.

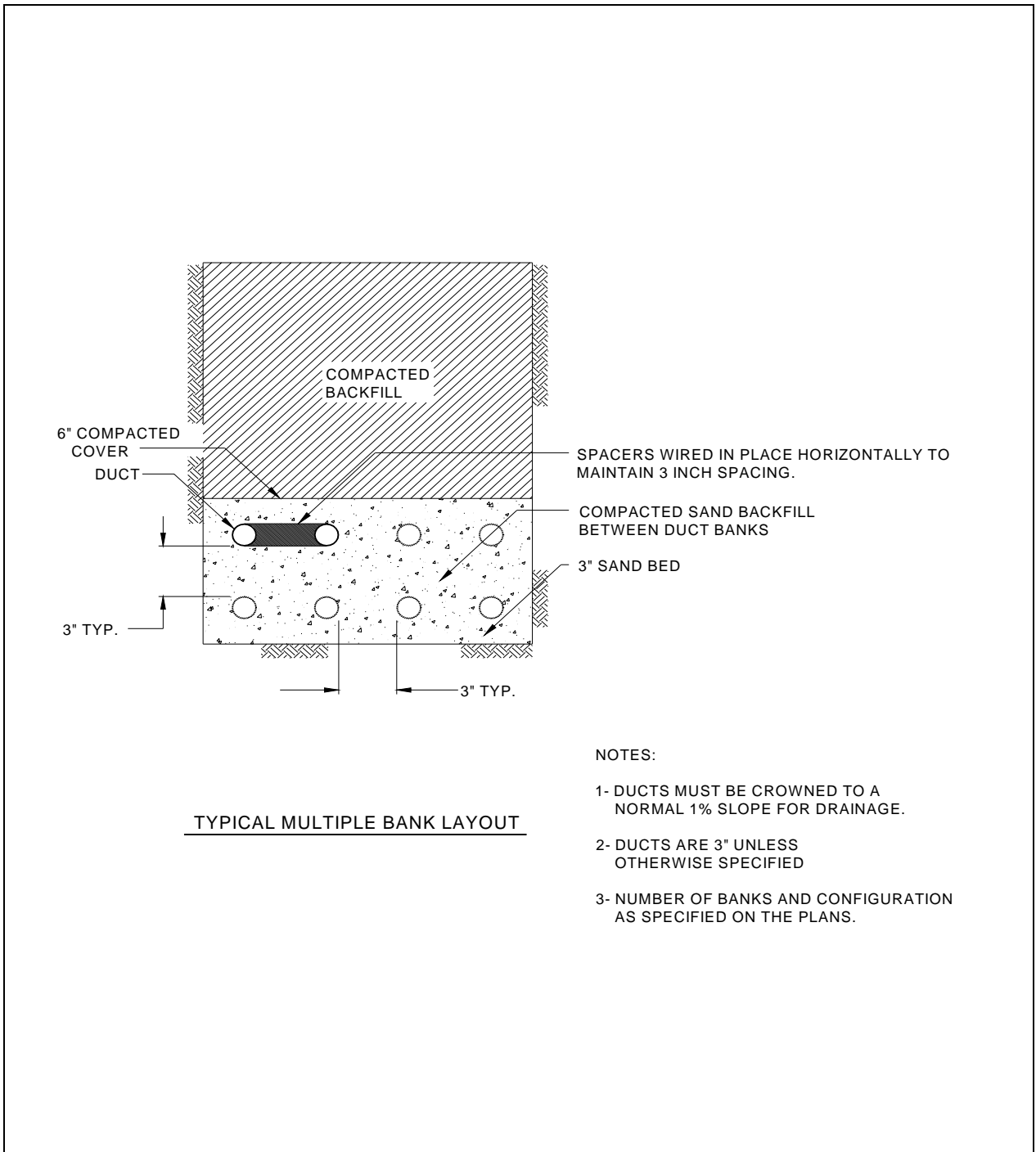
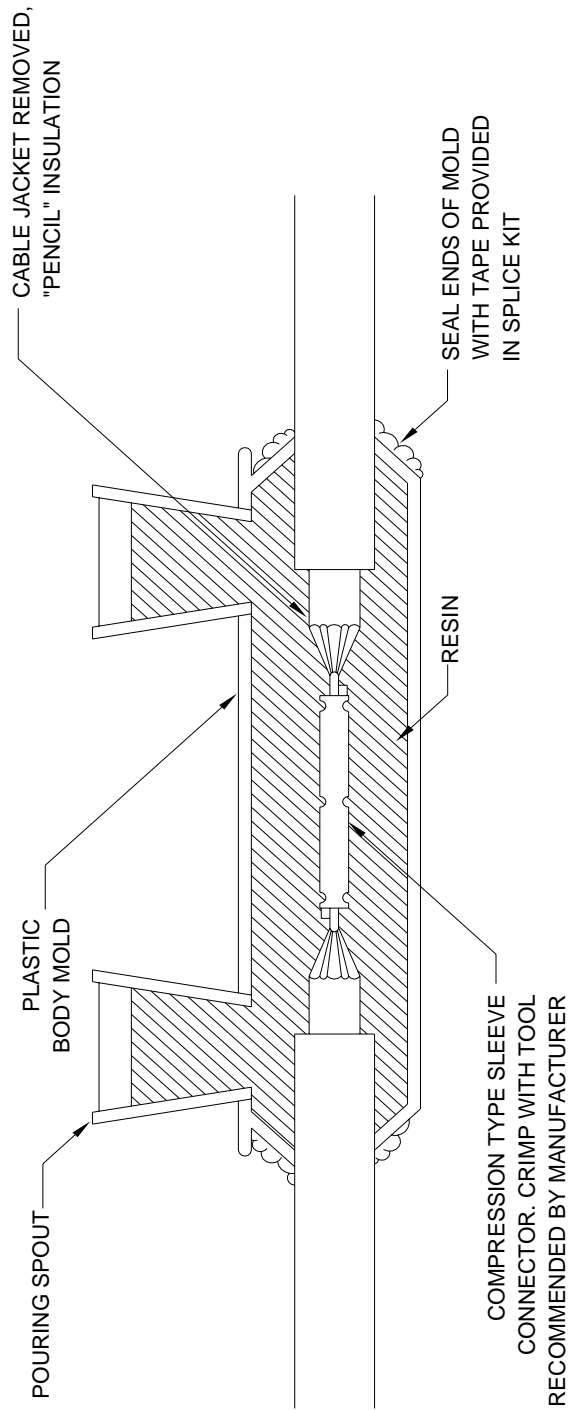

Figure 118. Standard Details for Underground Cable Installation – Typical Multiple Bank Layout.



NOTE:
CONNECTION OF CONDUCTORS MUST BE MADE BY USING CRIMP CONNECTORS AND A CRIMPING TOOL APPROVED BY THE CONNECTOR/LUG MANUFACTURER. THE TOOL MUST PRODUCE A COMPLETE CRIMP BEFORE IT CAN BE REMOVED. THE CRIMPING TOOL USED MUST BE LISTED BY THE L-823 KIT MANUFACTURER. MAKE THE NUMBER AND TYPE OF CRIMPS PER THE KIT MANUFACTURE'S INSTRUCTIONS.

TYPE A
FOR SPLICES IN HOMERUNS AND FOR EXTENSIONS
TO EXISTING CABLE ONLY

Figure 119. Standard Details for Underground Cable Installation – Type A.

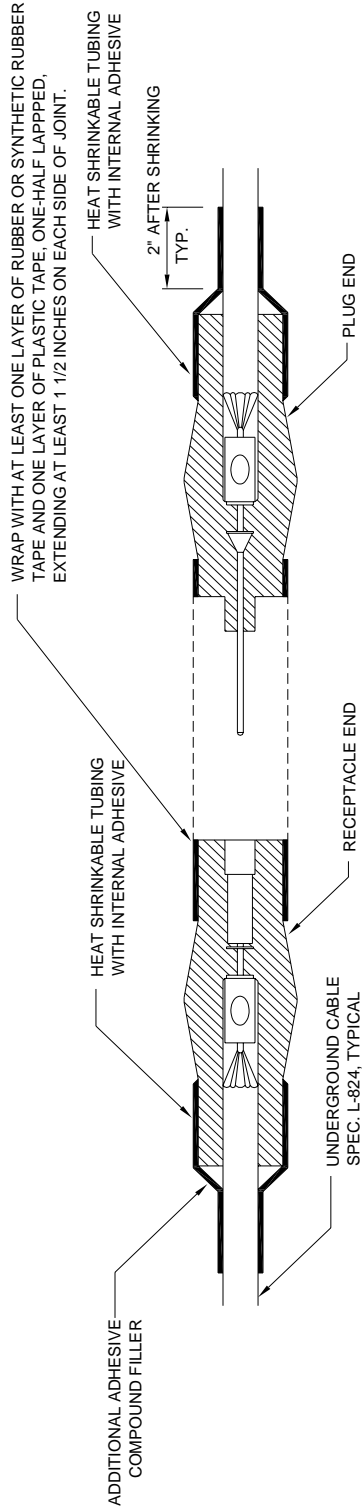

NOTE:
CONNECTION OF CONDUCTORS MUST BE MADE BY USING CRIMP CONNECTORS AND A CRIMPING TOOL APPROVED BY THE CONNECTOR/LUG MANUFACTURER. THE TOOL MUST PRODUCE A COMPLETE CRIMP BEFORE IT CAN BE REMOVED. THE CRIMPING TOOL USED MUST BE LISTED BY THE L-823 KIT MANUFACTURER. MAKE THE NUMBER AND TYPE OF CRIMPS PER THE KIT MANUFACTURE S INSTRUCTIONS.

TYPE B

FOR SPLICES FOR USE AT JUNCTION OF
HOMERUN WITH LOOP CIRCUIT

Figure 120. Standard Details for Underground Cable Installation – Type B.

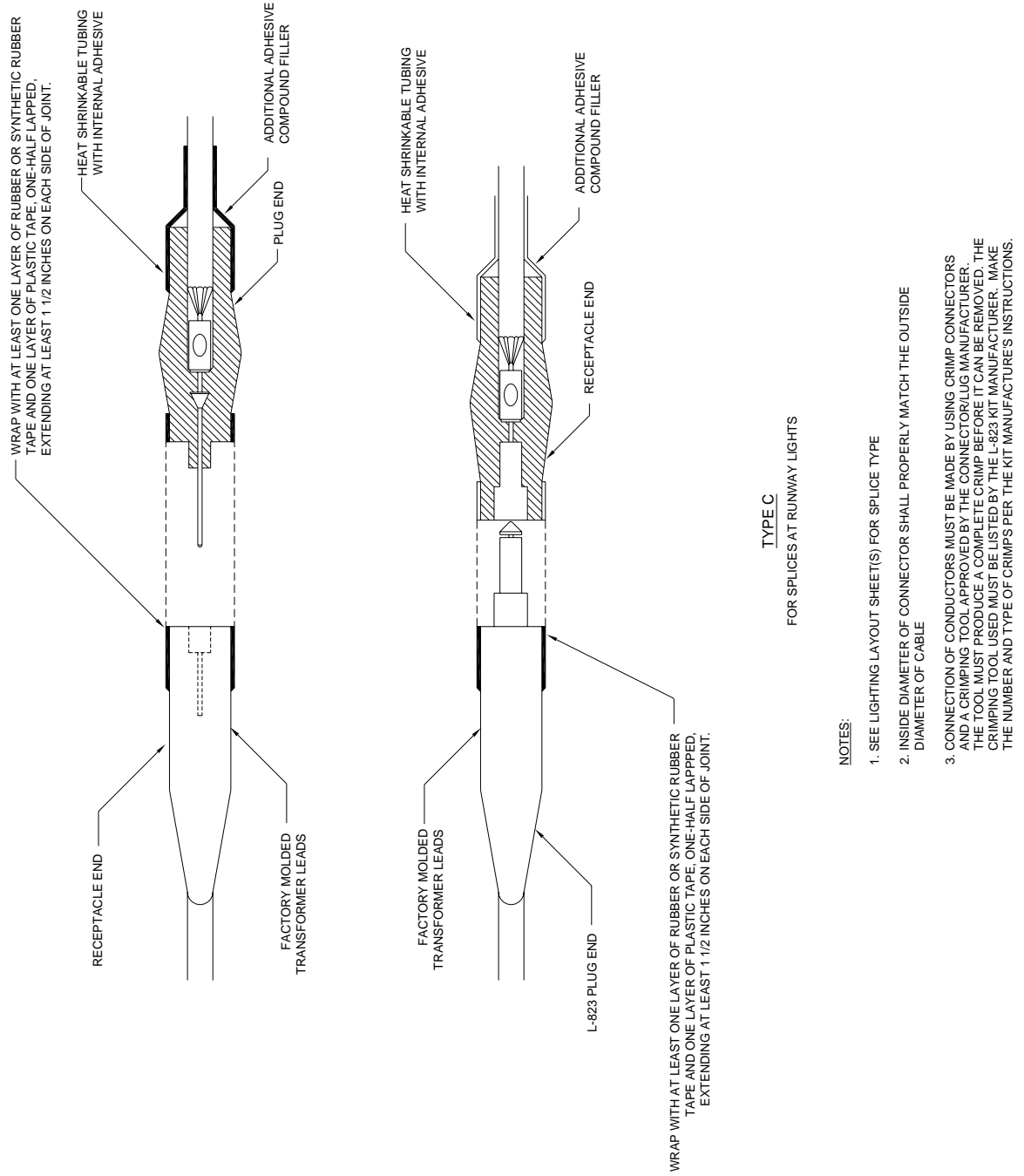

Figure 121. Standard Details for Underground Cable Installation – Type C.

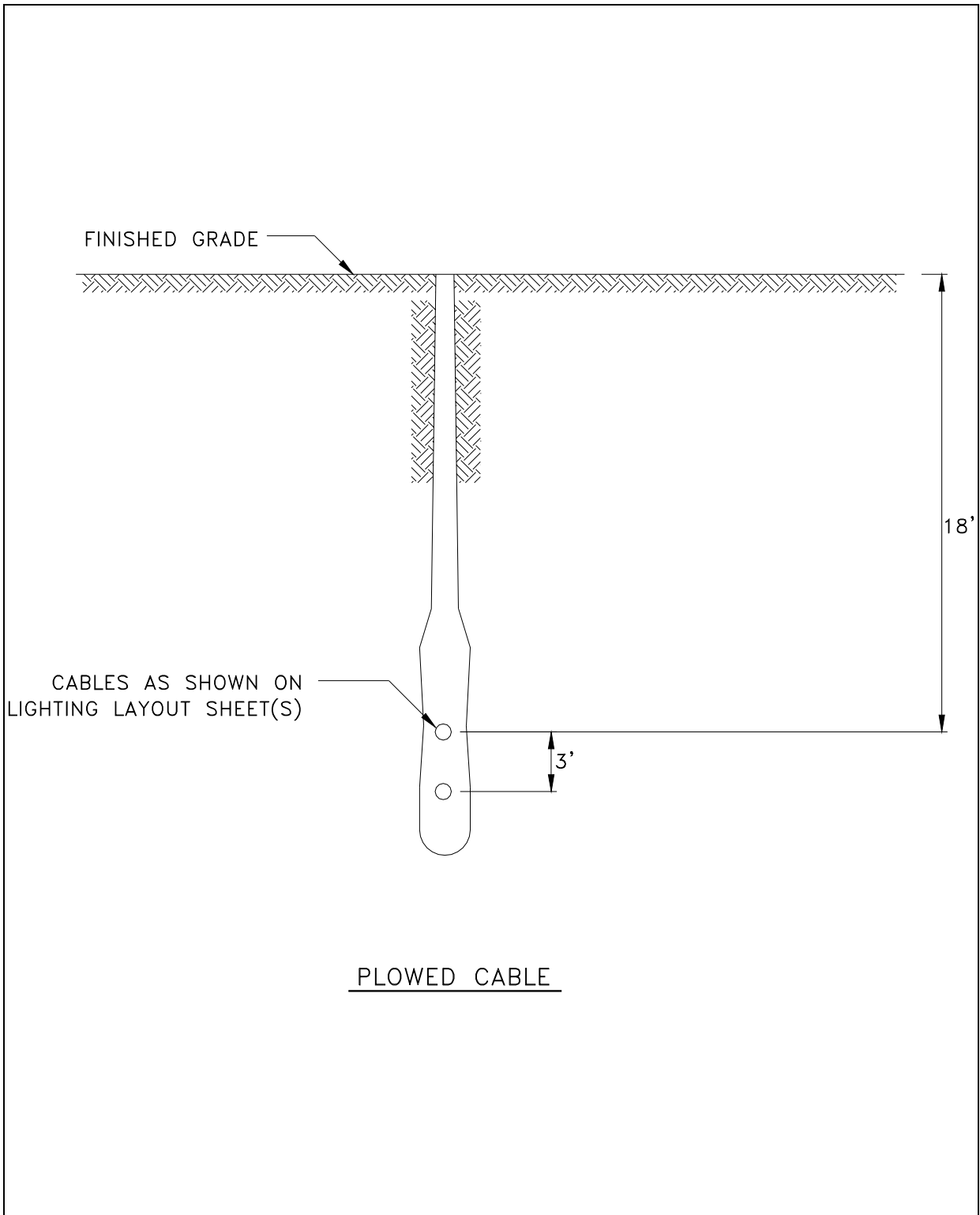

Figure 122. Standard Details for Underground Cable Installation – Plowed Cable.

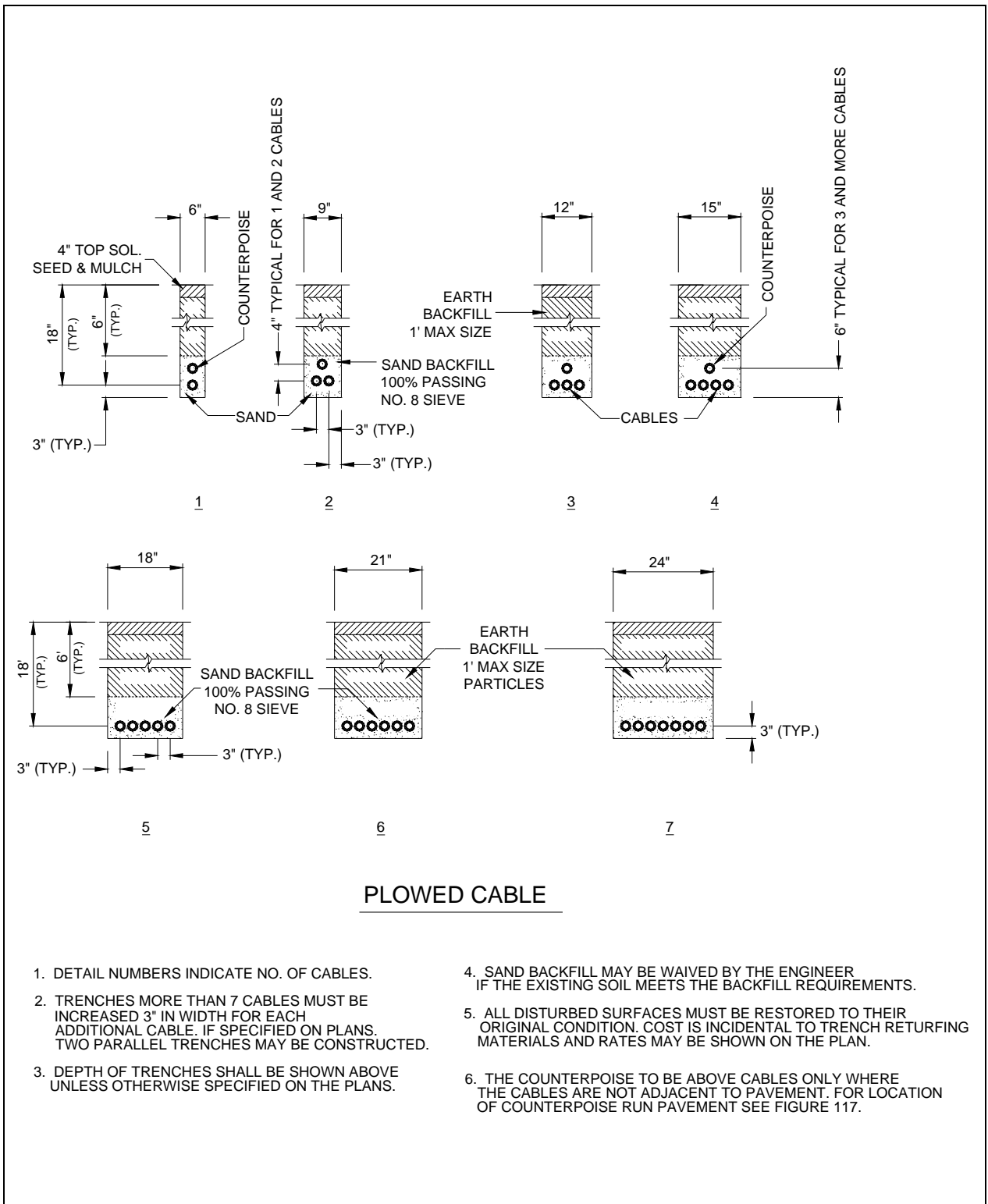

Figure 123. Standard Details for Underground Cable Installation – Plowed Cable.

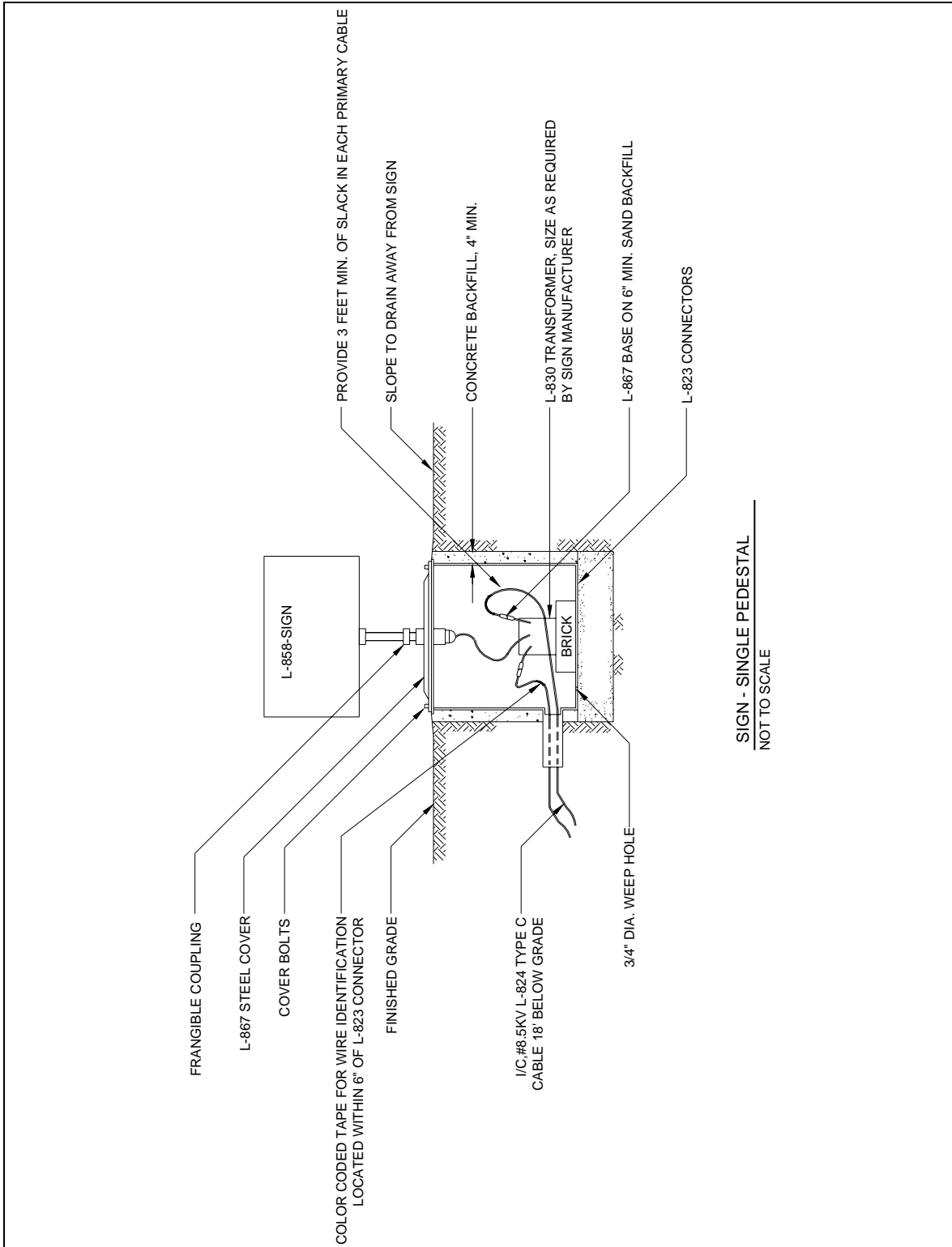

Figure 124. Standard Details for Taxiway Hold and Guidance Sign – Sign – Single Pedestal.

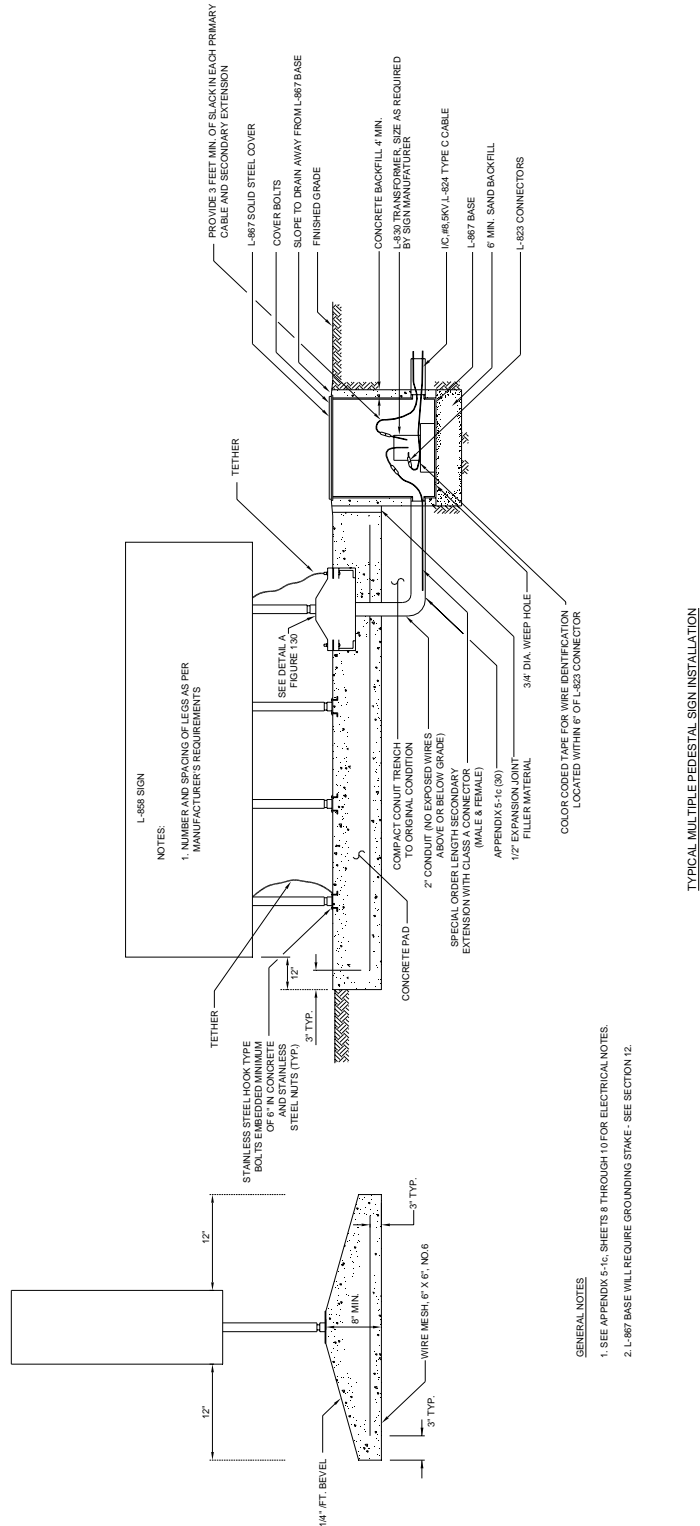

Figure 125. Standard Details for Taxiway Hold & Guidance Sign – Sign – Multiple Pedestal.

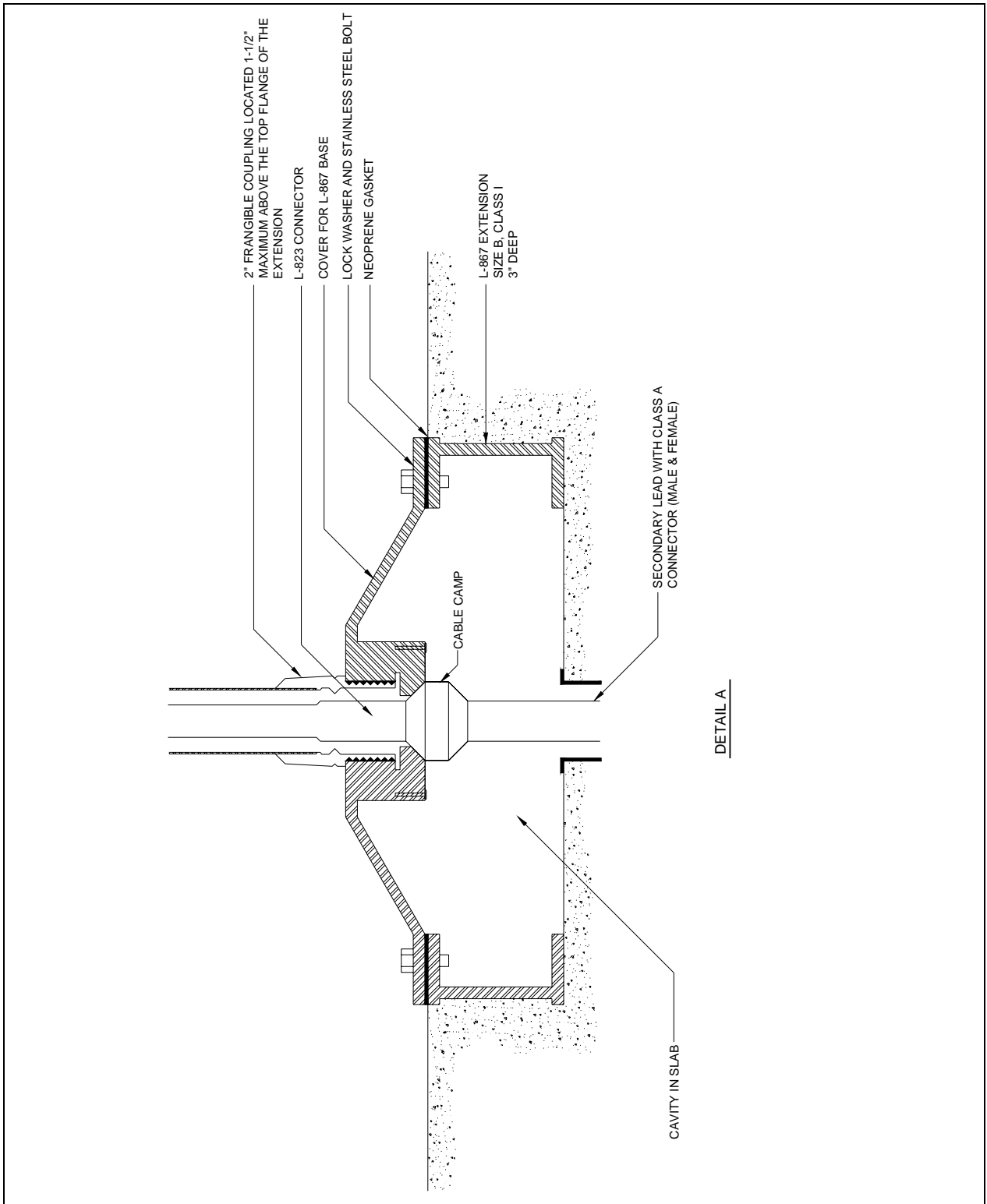

Figure 126. Standard Details for Taxiway Hold & Guidance Sign – Detail A.

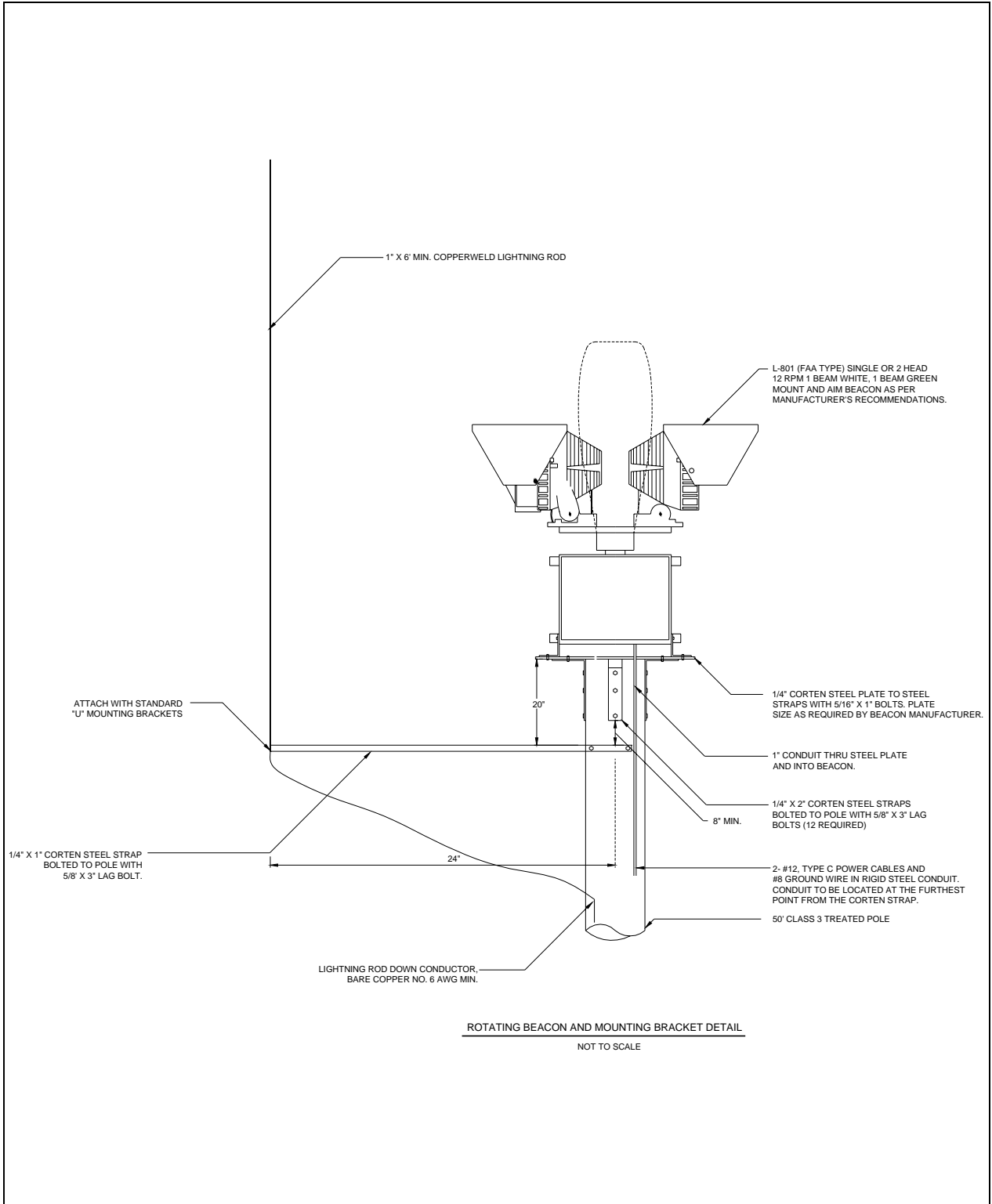

Figure 127. Standard Details for Pivoting Rotating Beacon Pole – Rotating Beacon & Mounting Bracket Detail.

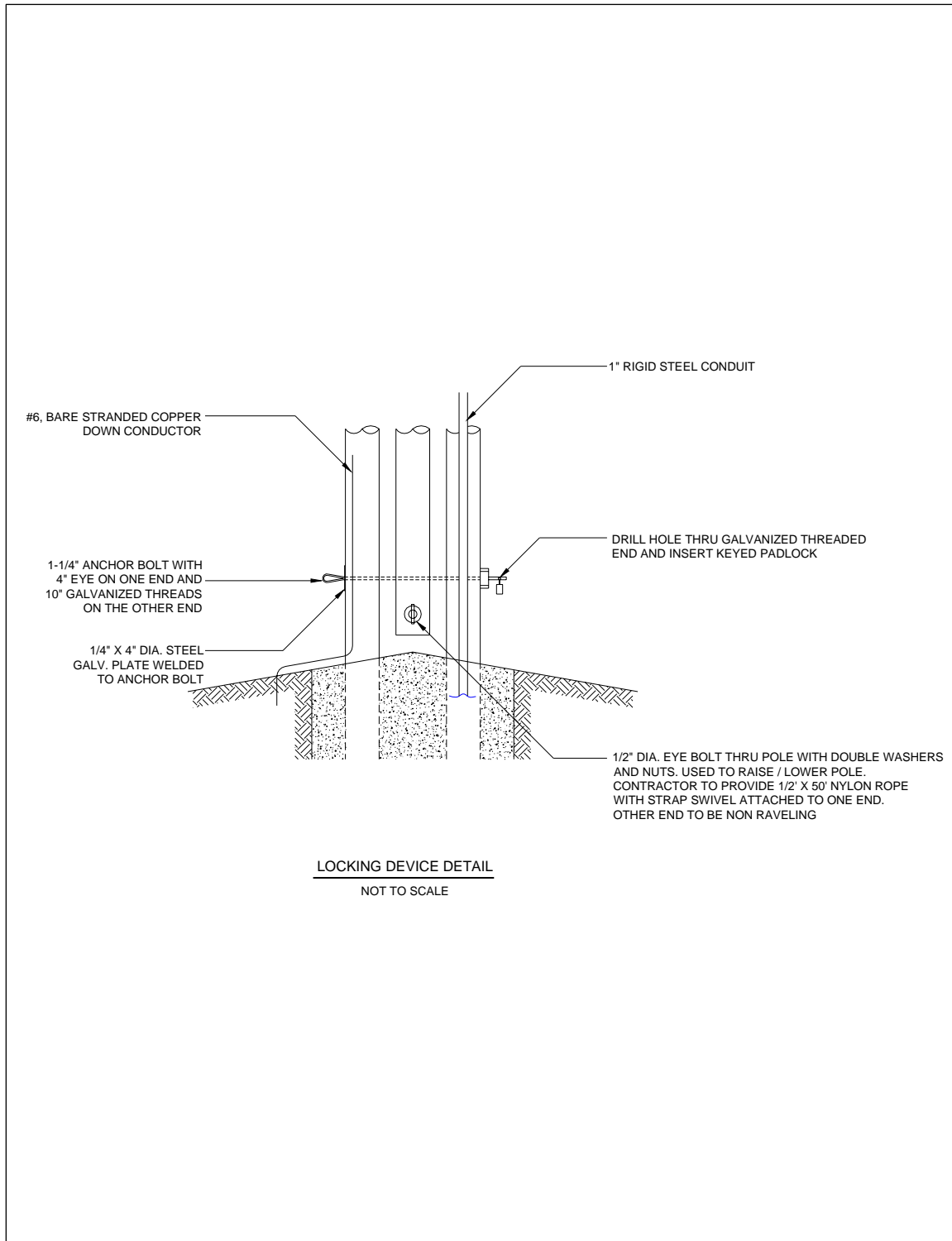

Figure 128. Standard Details for Pivoting Rotating Beacon Pole – Locking Device Detail.

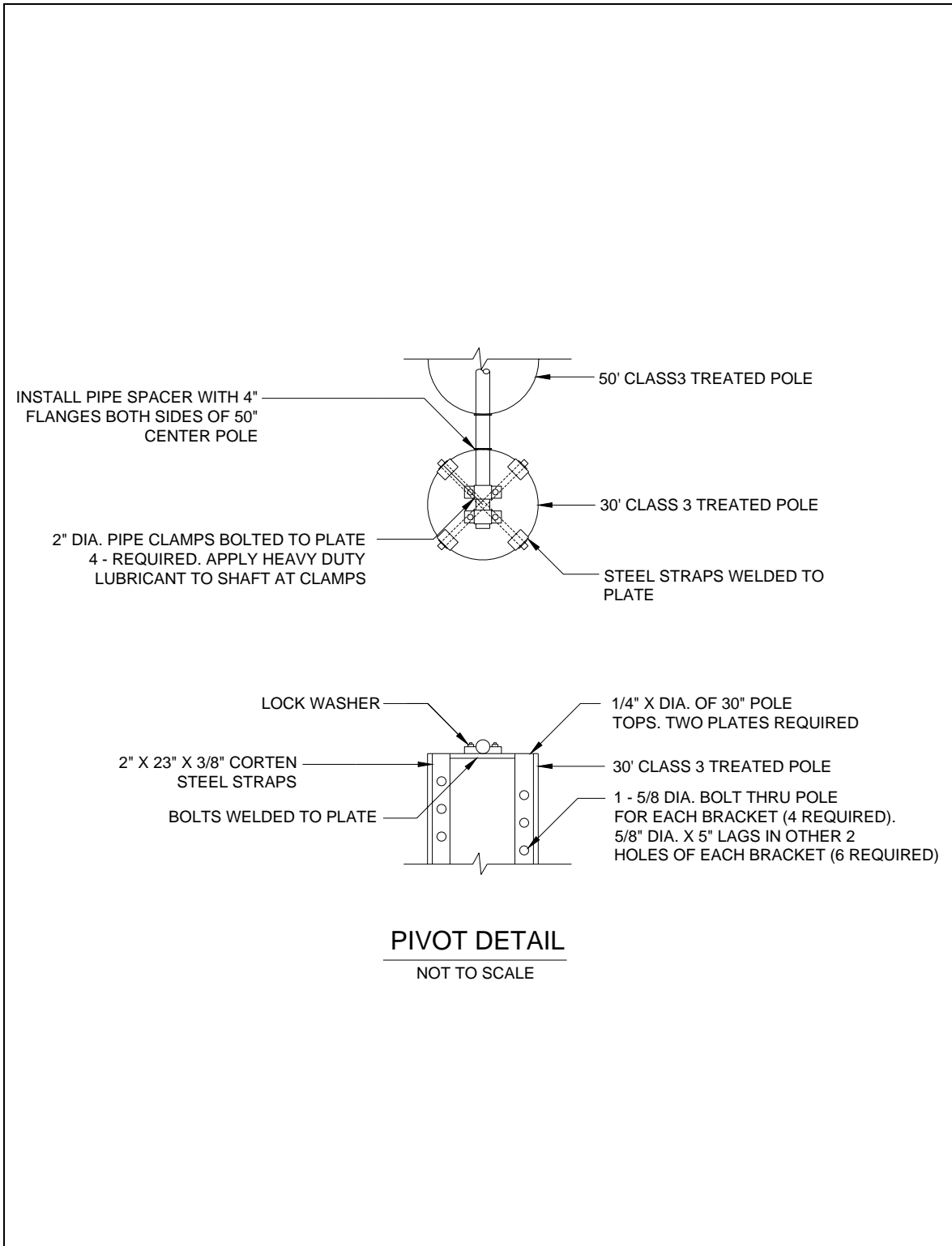

Figure 129. Standard Details for Pivoting Rotating Beacon Pole – Pivot Detail.

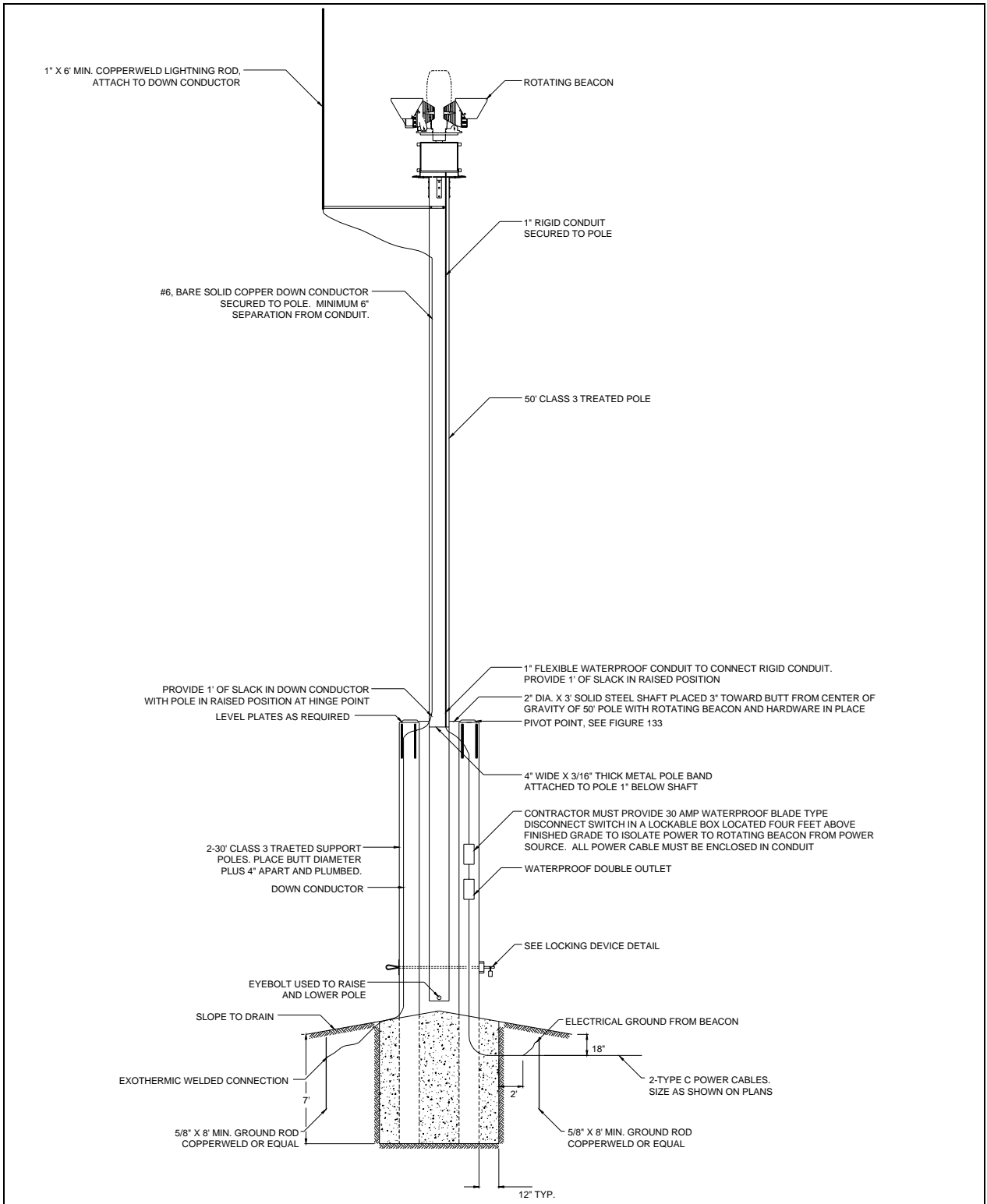

Figure 130. Standard Details for Pivoting Rotating Beacon Pole.

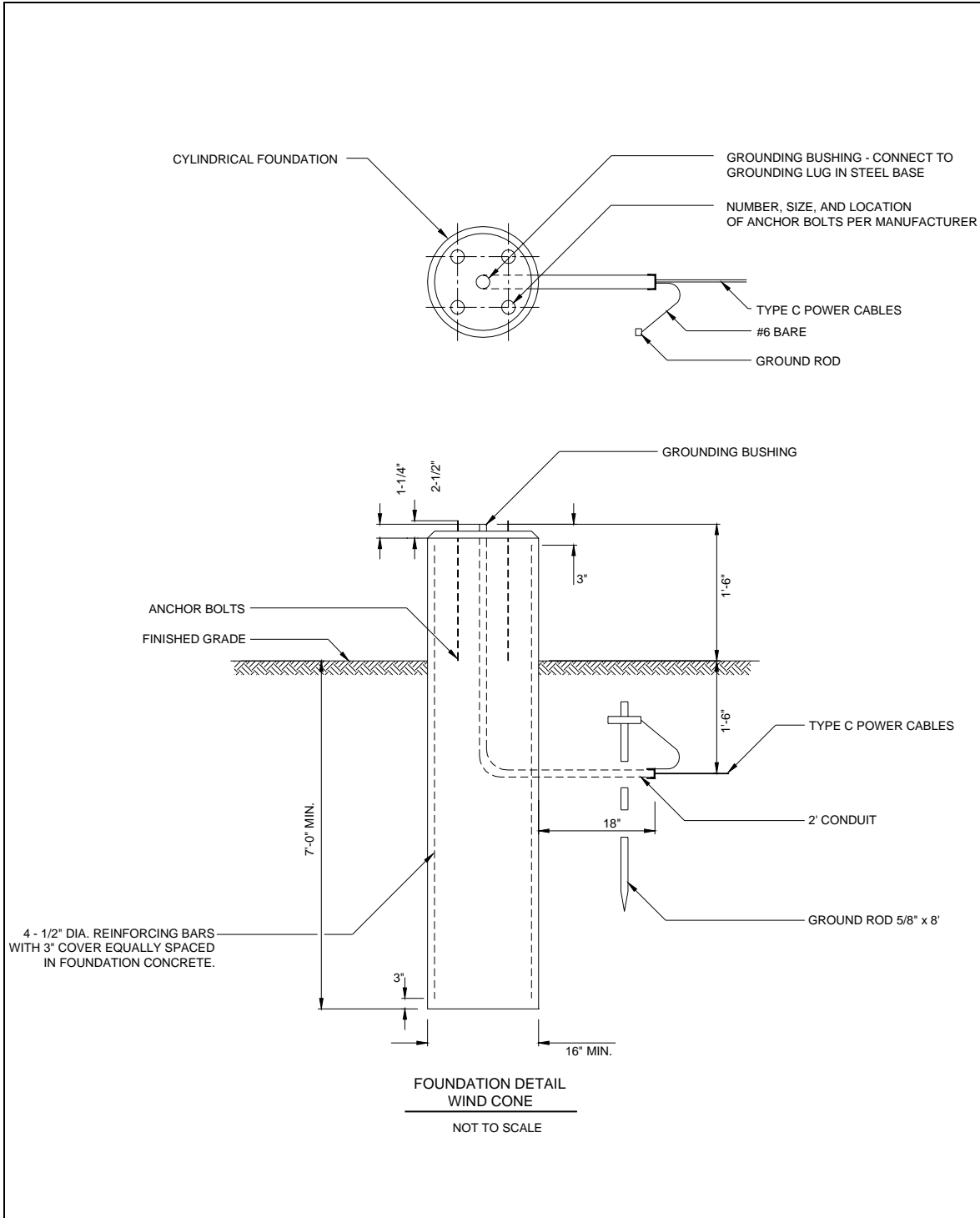

Figure 131. Standard Details for Wind Cone Foundation (L-807).

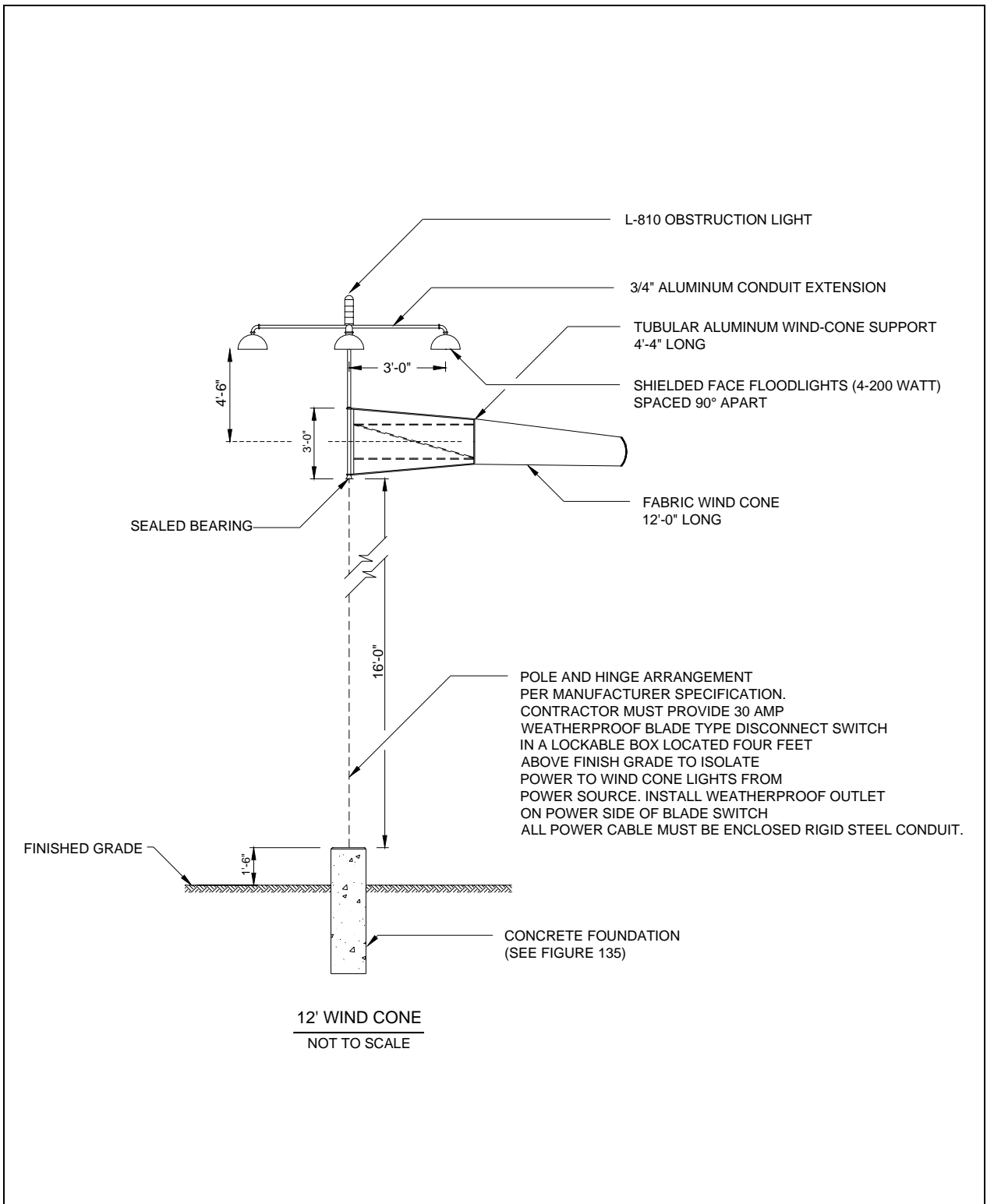

Figure 132. Standard Details for Wind Cone – 12 ft (3.7 m) Wind Cone.

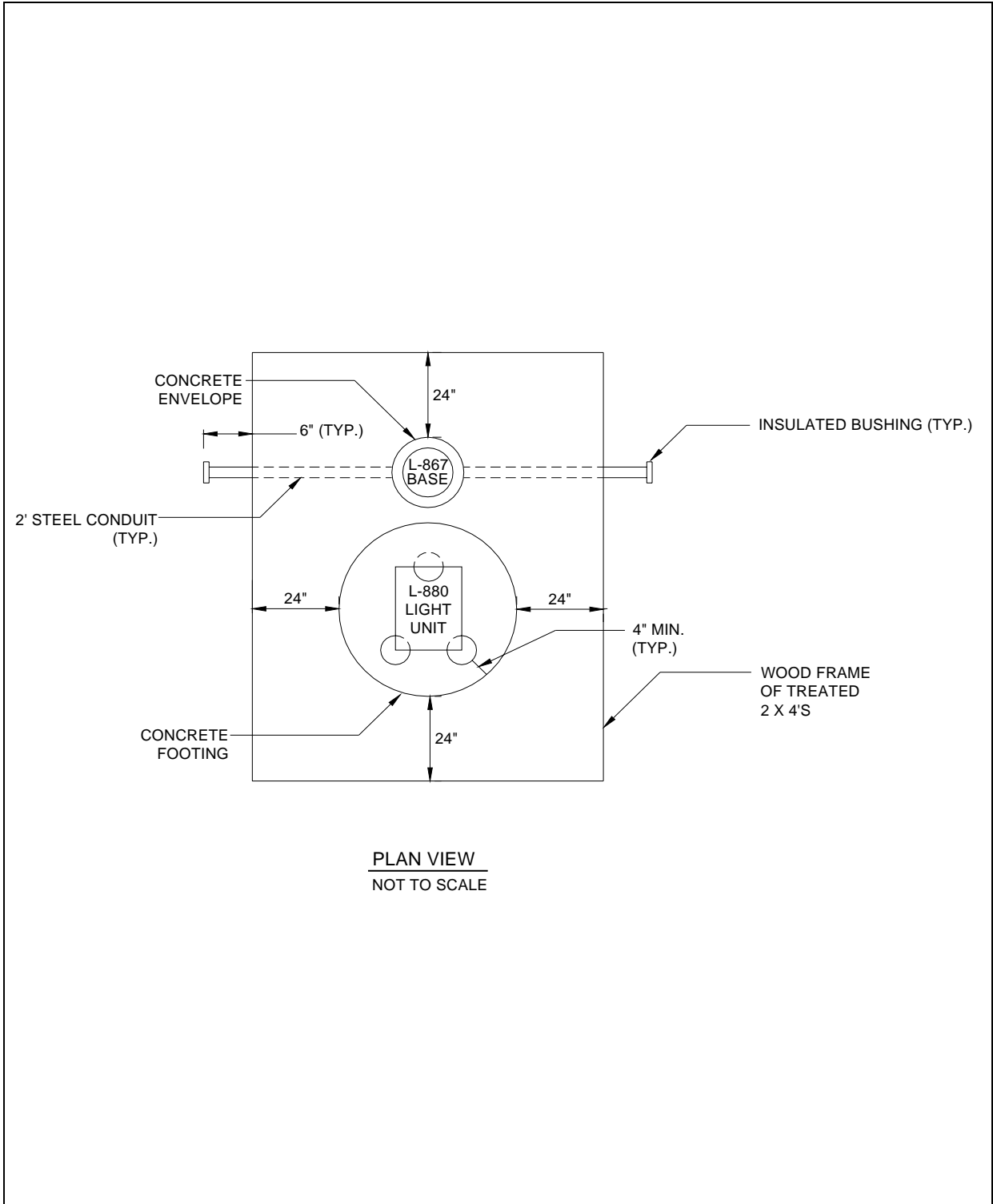

Figure 133. Standard Details for Precision Approach Path Indicators (PAPIs) – PAPI Light Unit Locations.

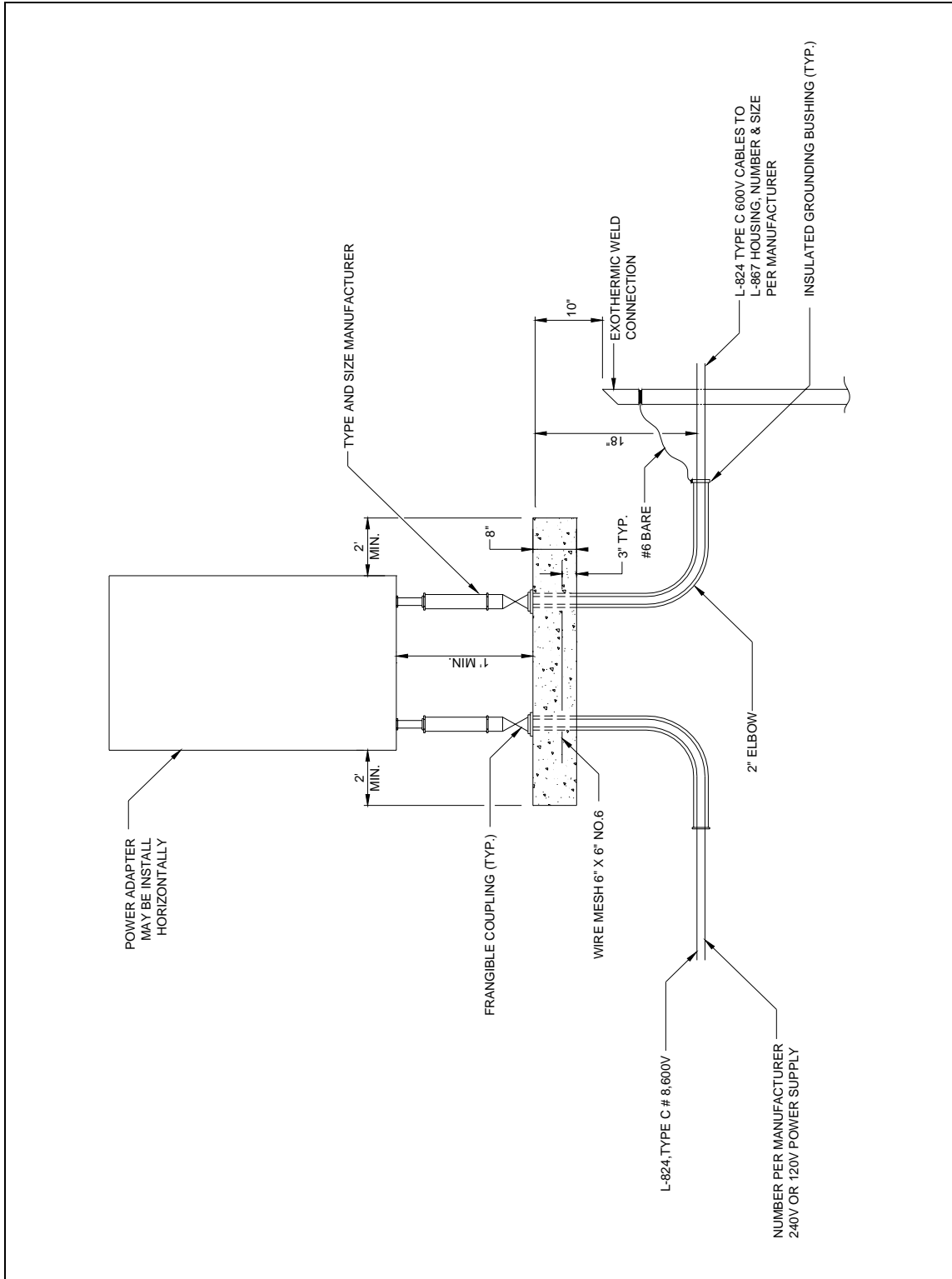

Figure 134. Standard Details for Precision Approach Path Indicators (PAPIs).

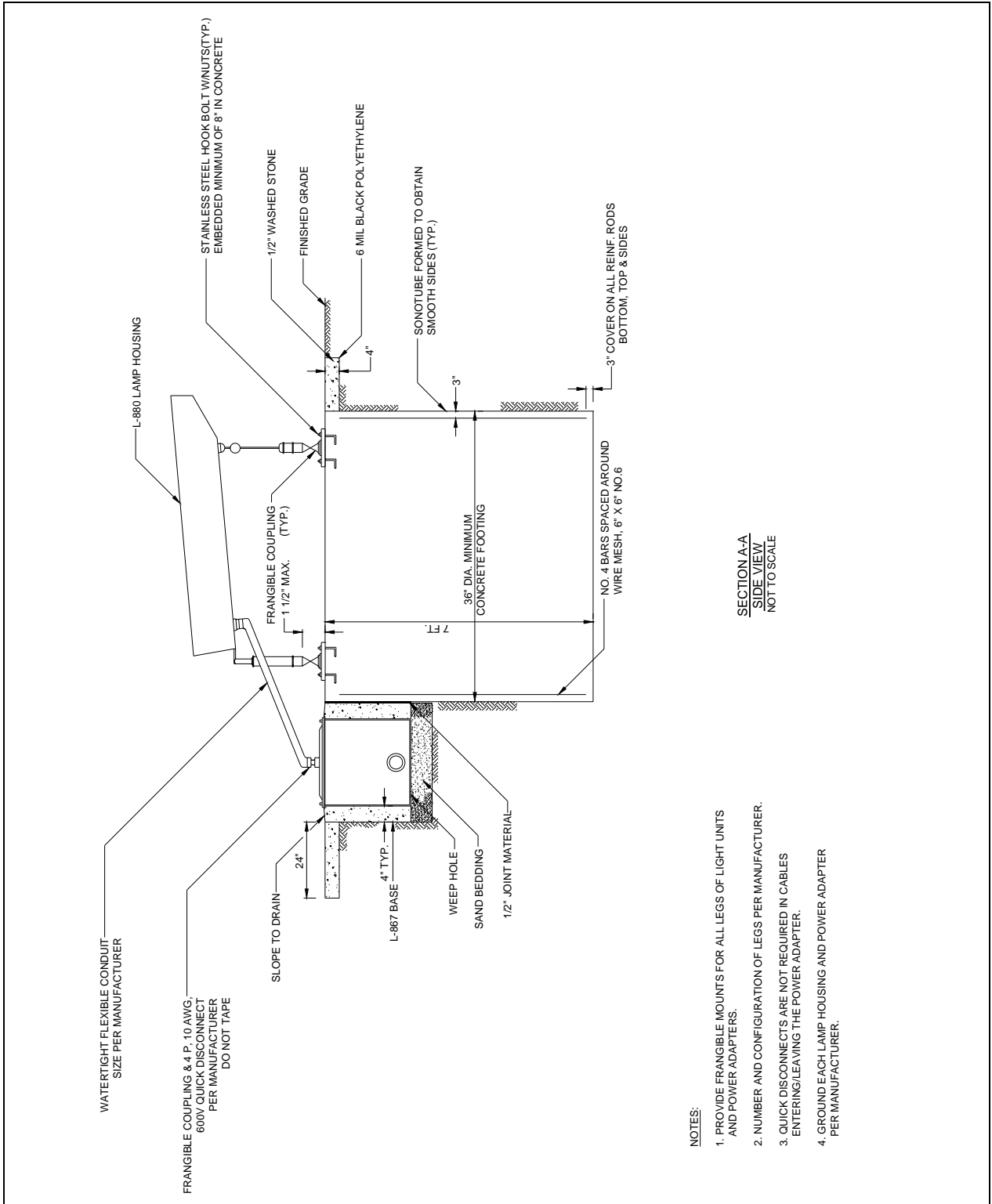

Figure 135. Standard Details for Precision Approach Path Indicators (PAPIs) – Section A-A.

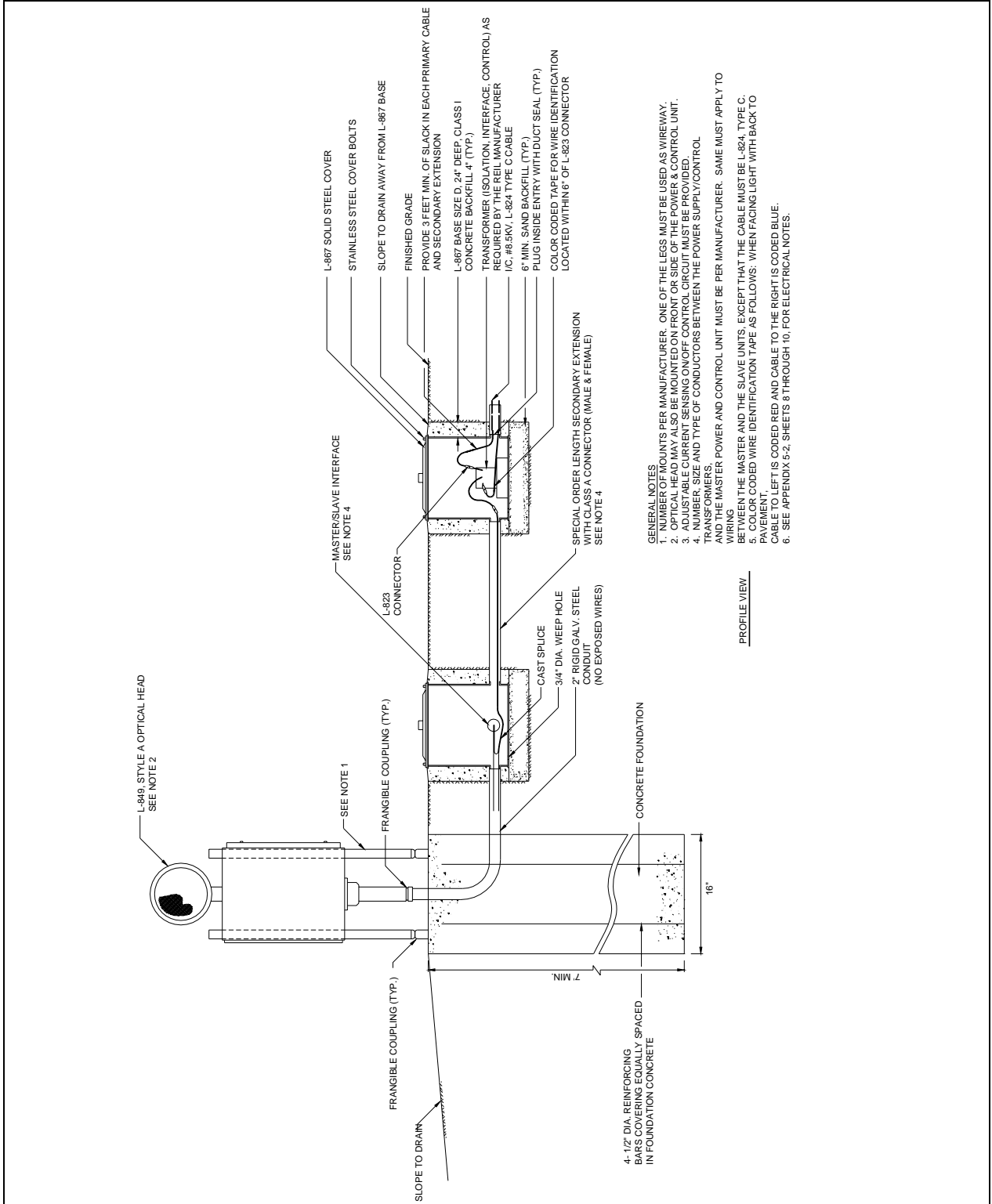

Figure 136. Standard Details for Runway End Identifier Light Power & Control Derived From Runway Circuit – Profile View.

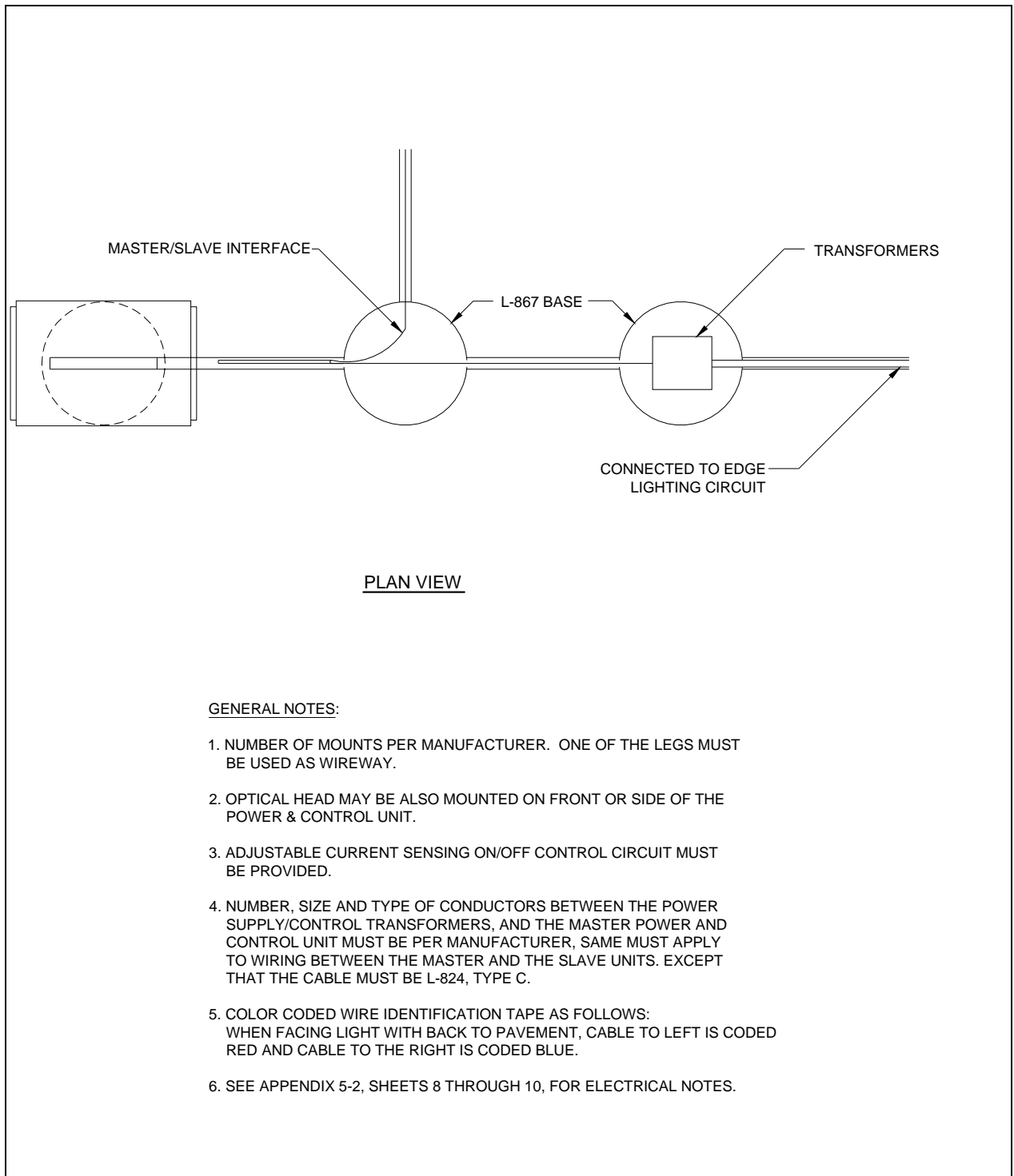

Figure 137. Standard Details for Runway End Identifier Light Power & Control Derived From Runway Circuit – Plan View.

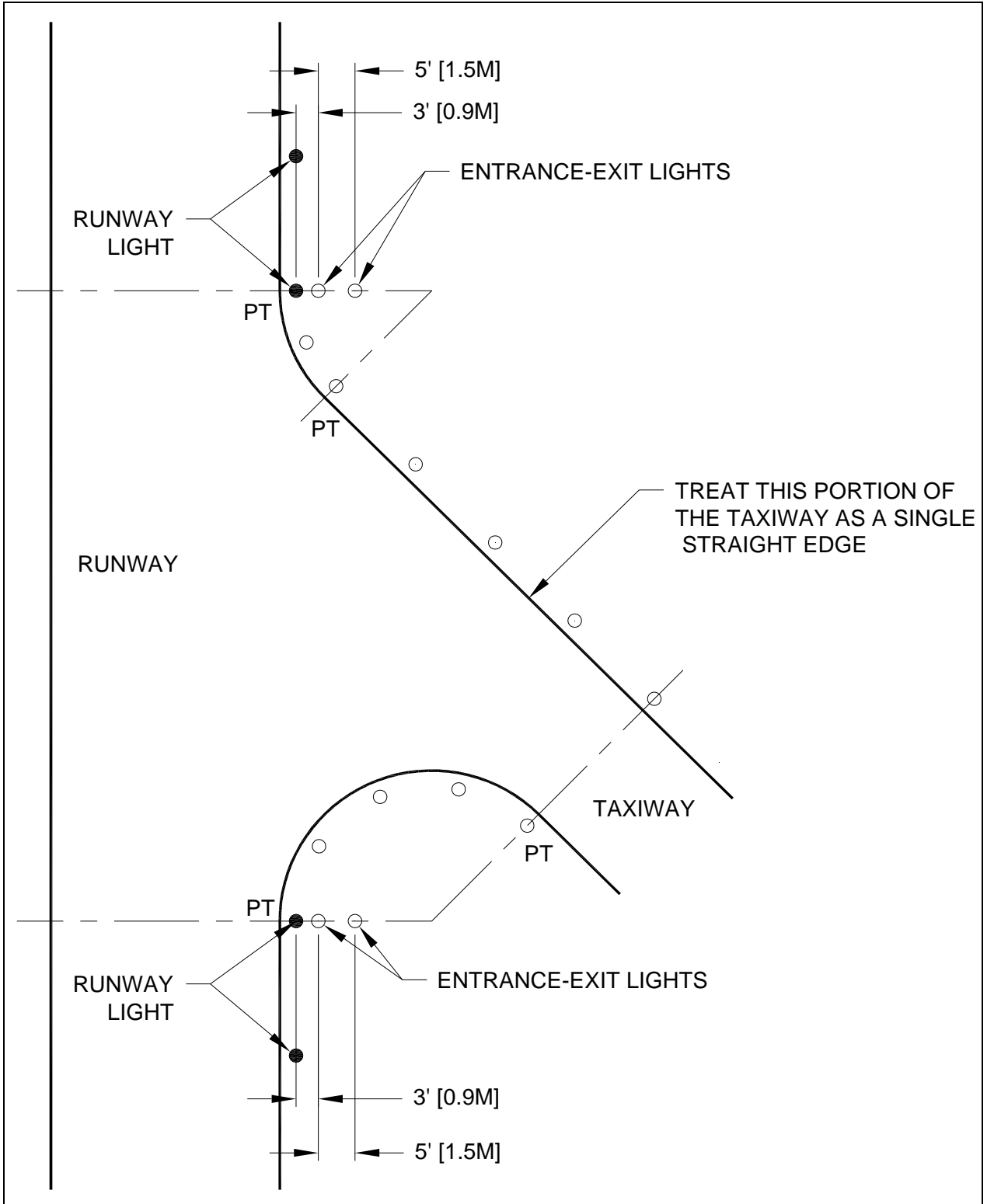

Figure 138. Location of Entrance-Exit Lights (in lieu of guidance signs)

A5-1. Electrical Notes

a. General

- (1) The electrical installation, at a minimum, must meet the NEC and local regulations.
- (2) The contractor must ascertain that all lighting system components furnished (including FAA approved equipment) are compatible in all respects with each other and the remainder of the new/existing system. Any non-compatible components furnished by the contractor must be replaced at no additional cost to the airport sponsor with a similar unit that is approved by the engineer and compatible with the remainder of the airport lighting system.
- (3) In case the contractor elects to furnish and install airport lighting equipment requiring additional wiring, transformers, adapters, mountings, etc., to those shown on the drawings and/or listed in the specifications, any cost for these items must be incidental to the equipment cost.
- (4) The contractor-installed equipment (including FAA approved) must not generate any EMI in the existing and/or new communications, weather, air navigation, and ATC equipment. Any equipment generating such interference must be replaced by the contractor at no additional cost with equipment meeting the applicable specifications.
- (5) When a specific type, style, class, etc., of FAA approved equipment is specified only that type, style, class, etc., will be acceptable, though equipment of other types, style, class, etc., may be FAA approved.
- (6) Any and all instructions from the engineer to the contractor regarding changes in, or deviations from, the plans and specifications must be in writing with copies sent to the airport sponsor and the FAA field office (ADO/AFO). The contractor must not accept any verbal instructions from the engineer regarding any changes from the plans and specifications.
- (7) A minimum of three copies of instruction books must be supplied with each type of equipment. For more sophisticated types of equipment, such as regulators, PAPI, REIL, etc., the instruction book must contain the following:
 - (a) A detailed description of the overall equipment and its individual components.
 - (b) Theory of operation including the function of each component.
 - (c) Installation instructions.
 - (d) Start-up instructions.
 - (e) Preventative maintenance requirements.
 - (f) Chart for troubleshooting.

- (g) Complete power and control detailed wiring diagram(s), showing each conductor/connection/component - "black" boxes are not acceptable. The diagram or the narrative must show voltages/currents/wave shapes at strategic locations to be used when checking and/or troubleshooting the equipment. When the equipment has several brightness steps, these parameters must be indicated for all the different modes.
- (h) Parts list will include all major and minor components, such as resistors, diodes, etc. It must include a complete nomenclature of each component and, if applicable, the name of its manufacturer and the catalog number.
- (i) Safety instructions.

b. Power and control

- (1) Stencil all electrical equipment to identify function, circuit voltage and phase. Where the equipment contains fuses, also stencil the fuse or fuse link ampere rating. Where the equipment does not have sufficient stenciling area, the stenciling must be done on the wall next to the unit. The letters must be one inch (25 mm) high and painted in white or black paint to provide the highest contrast with the background. Engraved plastic nameplates may also be used with one inch (25 mm) white (black background) or black (white background) characters. All markings must be of sufficient durability to withstand the environment.
- (2) Color code all phase wiring by the use of colored wire insulation and/or colored tape. Where tape is used, the wire insulation must be black. Black and red must be used for single-phase, three wire systems and black, red and blue must be used for three-phase systems. Neutral conductors, size No. 6 AWG or smaller, must be identified by a continuous white or natural outer finish. Conductors larger than No. 6 AWG must be identified either by a continuous white or natural gray outer finish along its entire length or by the use of white tape at its terminations and inside accessible wireways.
- (3) All branch circuit conductors connected to a particular phase must be identified with the same color. The color coding must extend to the point of utilization.
- (4) In control wiring, the same color must be used throughout the system for the same function, such as 10%, 30%, 100% brightness control, etc.
- (5) All power and control circuit conductors must be copper; aluminum must not be accepted. This includes wire, cable, busses, terminals, switch/panel components, etc.
- (6) Low voltage (600 V) and high voltage (5000 V) conductors must be installed in separate wireways.
- (7) Neatly lace wiring in distribution panels, wireways, switches and pull/junction boxes.
- (8) The minimum size of pull/junction boxes, regardless of the quantity and the size of the conductors shown, must be as follows:

- (a) In straight pulls, the length of the box must not be less than eight times the trade diameter of the larger conduit. The total area (including the conduit cross-sectional area) of a box end must be at least 3 times greater than the total trade cross-sectional area of the conduits terminating at the end.
 - (b) In angle or u-pulls, the distance between each conduit entry inside the box and the opposite wall of the box must not be less than six times the trade diameter of the largest conduit. This distance must be increased for additional entries by the amount of the sum of the diameters of all other conduit entries on the same wall of the box. The distance between conduit entries enclosing the same conductor must not be less than six times the trade diameter of the largest conduit.
- (9) A run of conduit between terminations at equipment enclosures, square ducts and pull/junction boxes, must not contain more than the equivalent of four quarter bends (360 degrees total), including bends located immediately at the terminations. Cast, conduit type outlets must not be treated as pull/junction boxes.
 - (10) Equipment cabinets must not be used as pull/junction boxes. Only wiring terminating at the equipment must be brought into these enclosures.
 - (11) Splices and junction points must be permitted only in junction boxes, ducts equipped with removable covers, and at easily accessible locations.
 - (12) Circuit breakers in power distribution panel(s) must be thermal-magnetic, molded case, permanent trip with 100-ampere, minimum, frame.
 - (13) Dual lugs must be used where two wires, size No. 6 or larger, are to be connected to the same terminal.
 - (14) All wall mounted equipment enclosures must be mounted on wooden mounting boards.
 - (15) Wooden equipment mounting boards must be plywood, exterior type, 3/4 inch (19 mm) minimum thickness, both sides painted with one coat of primer and two coats of gray, oil-based paint.
 - (16) Rigid steel conduit must be used throughout the installation unless otherwise specified. The minimum trade size must be 3/4 inch (19 mm).
 - (17) All rigid conduit must be terminated at CCRs with a section (10" (254 mm) minimum) of flexible conduit.
 - (18) Unless otherwise shown all exposed conduits must be run parallel to, or at right angles with, the lines of the structure.
 - (19) All steel conduits, fittings, nuts, bolts, etc., must be galvanized.

- (20) Use conduit bushings at each conduit termination. Where No. 4 AWG or larger ungrounded wire is installed, use insulated bushings.
- (21) Use double lock nuts at each conduit termination. Use weather tight hubs in damp and wet locations. Sealing locknuts must not be used.
- (22) Wrap all primary and secondary power transformer connections with sufficient layers of insulating tape and cover with insulating varnish for full value of cable insulation voltage.
- (23) Unless otherwise noted, all indoor single conductor control wiring must be No. 12 AWG.
- (24) Both ends of each control conductor must be terminated at a terminal block. The terminal block must be of proper rating and size for the function intended and must be located in equipment enclosures or special terminal cabinets.
- (25) All control conductor terminators must be of the open-eye connector/screw type. Soldered, closed-eyed terminators, or terminators without connectors are not acceptable.
- (26) In terminal block cabinets, the minimum spacing between parallel terminal blocks must be 6 inches (152 mm). The minimum spacing between terminal block sides/ends and cabinet sides/bottom/top must be 5 inches (127 mm). The minimum spacing will be increased as required by the number of conductors. Additional spacing must be provided at conductor entrances.
- (27) Both ends of all control conductors must be identified as to the circuit, terminal, block, and terminal number. Only stick-on labels must be used.
- (28) A separate and continuous neutral conductor must be installed and connected for each breaker circuit in the power panel(s) from the neutral bar to each power/control circuit.
- (29) The following must apply to relay/contactors panel/enclosures:
 - (a) All components must be mounted in dust proof enclosures with vertically hinged covers.
 - (b) The enclosures must have ample space for the circuit components, terminal blocks, and incoming internal wiring.
 - (c) All incoming/outgoing wiring must be terminated at terminal blocks.
 - (d) Each terminal on terminal blocks and on circuit components must be clearly identified.
 - (e) All control conductor terminations must be of the open-eye connector/screw type. Soldered, closed-eye connectors, or terminations without connectors are not acceptable.

- (f) When the enclosure cover is opened, all circuit components, wiring, and terminals must be exposed and accessible without any removal of any panels, covers, etc., except those covering high voltage components.
- (g) Access to, or removal of, a circuit component or terminal block will not require the removal of any other circuit component or terminal block.
- (h) Each circuit component must be clearly identified indicating its corresponding number shown on the drawing and its function.
- (i) A complete wiring diagram (not a block or schematic diagram) must be mounted on the inside of the cover. The diagram must represent each conductor by a separate line.
- (j) The diagram must identify each circuit component and the number and color of each internal conductor and terminal.
- (k) All wiring must be neatly trained and laced.
- (l) Minimum wire size must be No. 12 AWG.

c. Field lighting

- (1) Unless otherwise stated, all underground field power multiple and series circuit conductors (whether direct earth burial (DEB) or in duct/conduit) must be FAA approved Type L-824. Insulation voltage and size must be as specified.
- (2) No components of the primary circuit such as cable, connectors and transformers must be brought above ground at edge lights, signs, REIL, etc.
- (3) There must be no exposed power/control cables between the point where they leave the underground (DEB or L-867 bases) and where they enter the equipment (such as taxiway signs, PAPI, REIL, etc.). Enclosures. These cables must be enclosed in rigid conduit or in flexible water-tight conduit with frangible coupling(s) at the grade or the housing cover, as shown in applicable details.
- (4) The joints of the L-823 primary connectors must be wrapped with one layer of rubber or synthetic rubber tape and one layer of plastic tape, one half lapped, extending at least 1-1/2 inches (38 mm) on each side of the joint, as shown in Figure 121.
- (5) The cable entrance into the field attached L-823 connectors must be enclosed by a heat-shrinkable tubing with continuous internal adhesive as shown in Figure 121.
- (6) The ID of the primary L-823 field attached connectors must match the cable ID to provide a watertight cable entrance. The entrance must be encapsulated in a heat shrinkable tubing with continuous factory applied internal adhesive, as shown in Figure 121.

- (7) L-823 type 11, two-conductor secondary connector must be class "A" (factory molded).
- (8) There must be no splices in the secondary cable(s) within the stems of a runway/taxiway edge/threshold lighting fixtures and the wireways leading to taxiway signs and PAPI/REIL equipment.
- (9) Electrical insulating grease must be applied within the L-823, secondary, two conductor connectors to prevent water entrance. The connectors must not be taped.
- (10) DEB isolation transformers must be buried at a depth of 10 inches (254 mm) on a line crossing the light and perpendicular to the runway/taxiway centerline at a location 12 inches (305 mm) from the light opposite from the runway/taxiway.
- (11) DEB primary connectors must be buried at a depth of 10 inches (254 mm) near the isolation transformer. They must be orientated parallel with the runway/taxiway centerline. There must be no bends in the primary cable 6 inches (152 mm), minimum, from the entrance into the field-attached primary connection.
- (12) A slack of 3 feet (0.9 m), minimum, must be provided in the primary cable at each transformer/connector termination. At stake-mounted lights, the slack must be loosely coiled immediately below the isolation transformer.
- (13) Direction of primary cables must be identified by color coding as follows when facing light with back facing pavement: cable to the left is coded red and cable to the right is coded blue, this applies to the stake-mounted lights and base-mounted lights where the base has only one entrance.
- (14) L-867 bases must be size B, 24" (610 mm) deep class 1 unless otherwise noted.
- (15) Base-mounted frangible couplings must not have weep holes to the outside. Plugged holes are not acceptable. The coupling must have a 1/4" (6 mm) diameter minimum or equivalent opening for drainage from the space around the secondary connector into the L-867 base.
- (16) The elevation of the frangible coupling groove must not exceed 1-1/2" (38 mm) above the edge of the cover for base-mounted couplings or the top of the stake for stake-mounted couplings.
- (17) Where the frangible coupling is not an integral part of the light fixture stem or mounting leg, a bead of silicone rubber seal must be applied completely around the light stem or wireway at the frangible coupling to provide a watertight seal.
- (18) Tops of the stakes supporting light fixtures must be flush with the surrounding grade.
- (19) Plastic lighting fixture components, such as lamp heads, stems, frangible couplings, base covers, brackets, stakes, are not acceptable. L-867 plastic transformer housings are acceptable. A metal threaded fitting must be set in

flange during casting process. Base cover bolts must be fabricated from 18-8 stainless steel.

- (20) The tolerance for the height of runway/taxiway edge lights must be ± 1 inch (25 mm). For stake-mounted lights, the specified lighting fixture height must be measured between the top of the stake and the top of the lens. For base-mounted lights, the specified lighting fixture height must be measured between the top of the base flange and the top of the lens, and includes the base cover, the frangible coupling, the stem, the lamp housing and the lens.
- (21) The tolerance for the lateral spacing (light lane to runway/taxiway centerline) of runway/taxiway edge lights must be ± 1 inch (25 mm). This also applies at intersections to lateral spacing between lights of a runway/taxiway and the intersecting runway/taxiway.
- (22) L-867 bases may be precast. Entrances into L-867 bases must be plugged from the inside with duct seal.
- (23) Galvanized/painted equipment/component surfaces must not be damaged by drilling, filing, etc. – this includes drain holes in metal transformer housings.
- (24) Edge light numbering tags must be facing the pavement.
- (25) Cable/splice/duct markers must be pre-cast concrete of the size shown. Letters/numbers/arrows for the legend to be impressed into the tops of the markers must be pre-assembled and secured in the mold before the concrete is poured. Legends inscribed by hand in wet concrete are not acceptable.
- (26) All underground cable runs must be identified by cable markers at 200 feet (61 m) maximum spacing with an additional marker at each change of direction of the cable run. Cable markers must be installed above the cable.
- (27) Locations of all DEB underground cable splice/connections, except those at isolation transformers, must be identified by splice markers. Splice markers must be placed above the splice/connections.
- (28) The cable and splice markers must identify the circuits to which the cables belong. For example: RWY 4-22, PAPI-4, PAPI-22.
- (29) Locations of ends of all underground ducts must be identified by duct markers.
- (30) The preferred mounting method of runway and taxiway signs is by the use of single row of legs. However, two rows will be acceptable.
- (31) Reference Figure 125 and Figure 126 for an example of a lighted sign installation.
 - a. Power to the sign must be provided through breakaway cable connectors installed within the frangible point portion of the sign's mounting legs.

- b. There must be no above ground electrical connection between signs in a sign array.
- (32) Stencil horizontal and vertical aiming angles on each REIL flash head or equipment enclosure. The numerals must be black and one inch (25 mm) minimum height.
 - (33) Stencil vertical aiming angles on the outside of each PAPI lamp housing. The numerals must be black and one inch (25 mm) minimum height.
 - (34) All power and control cables in man/hand holes must be tagged. Use embossed stainless steel strips or tags attached at both ends to the cable by the use of UV resistant plastic straps. A minimum of two tags must be provided on each cable in a man/hand hole - one at the cable entrance, and one at the cable exit.
 - (35) Apply a corrosion inhibiting, anti-seize compound to all screws, nuts and frangible coupling threads.
 - (36) There must be no splices between the isolation transformers. L-823 connectors are allowed at transformer connections only, unless shown otherwise.
 - (37) DEB splices in home runs must be of the cast type, unless shown otherwise.
 - (38) Where a parallel, constant voltage PAPI system is provided, the "T" splices must be of the cast type.
 - (39) Concrete used for slabs, footing, backfill around transformer housings, markers, etc., must be 3000 PSI, min., air-entrained.
- d. Equipment Grounding
- (1) Ground all non-current-carrying metal parts of electrical equipment by using conductors sized and routed per NEC Handbook, Article 250.
 - (2) All ground connections to ground rods, busses, panels, etc., must be made with pressure type solderless lugs and ground clamps. Soldered or bolt and washer type connections are not acceptable. Clean all metal surfaces before making ground connections. Exothermic welds are the preferred method of connection to a ground rod
 - (3) Tops of ground rods must be 6 inches (152 mm) below grade.
 - (4) The resistance to ground of the vault grounding system with the commercial power line neutral disconnected must not exceed 10 ohms.
 - (5) The resistance to ground of the counterpoise system, or at isolation locations, such as airport beacon must not exceed 25 ohms.

Intentionally left blank.

APPENDIX 6. APPLICATION NOTES.**PURPOSE**

The purpose of these Application Notes is to provide additional information to better guide consultants and designers when developing airfield lighting designs.

A6-1. Signs with Internal Power Supplies (Style 2/3).

This section provides some application guidelines to be considered when designing airfield lighting systems that include certain types of style 2 and 3 signs. There are several manufacturers of these products and not all products will behave exactly as described in this Appendix. This information is intended to provide some general guidelines. The designer should always consult the manufacturer for characteristics and application information that is specific to each product.

The style 2 lighted sign is for circuits powered by a 3 step constant current regulator (CCR) where the sign input current ranges from 4.8 to 6.6 amps. The style 3 lighted sign is for circuits powered by a 5 step CCR where the sign input current ranges from 2.8 to 6.6 amps (or alternately from 8.5 to 20 amps).

For the discussion and description below, the examples used are the style 3, 2.8 to 6.6 amp sign. Most of this information applies to the style 2 signs however; the designer should consult the manufacturer for specific information.

A6-1.1. General Description.

Figure 1 shows a simplified block diagram of a controlled output sign. A power supply provides the lamps with a fixed or nearly fixed load current while its input is 2.8 to 6.6 amps current from the series circuit. In this application, the sign may be installed on a circuit that also has other lighting fixtures that must have their brightness controlled by selecting CCR current steps. The sign must maintain its brightness at the required level (10 to 30 foot lamberts – see AC 150/5345-44, *Specification for Runway and Taxiway Signs*) when any of the steps are selected on the circuit.

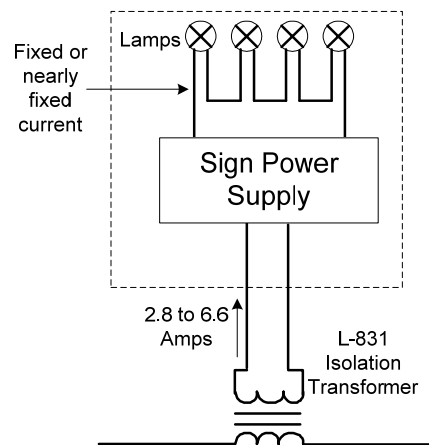

Figure 139. Controlled Output Sign Block Diagram

This is achieved by holding the current of the lamps to a constant level – the sign lamp intensity will remain nearly the same regardless of the CCR current setting. Since the circuit current operates within a range of 2.8 to 6.6 amps, the sign power supply must continue to provide the same wattage to the load when the CCR current is changed to a lower step. The sign power supply will require more input voltage from the circuit when the circuit current decreases to continue to supply the load with the same wattage.

A6-1.2. Circuit Loading Considerations.

To determine the load requirements and CCR sizing for these styles of signs, it would be incorrect to simply add the volt-amps (VA) required by the signs, the load of the remaining items on the circuit, and perform the normal calculations for cable losses, transformer efficiency, etc. This calculation would only be valid if the circuit was kept at the top step, 6.6 amps.

Consider a circuit with multiple signs that has a sign load of 10,000 VA with other lights and losses of 3,000 VA, for a total of 13,000 VA. A 15KVA CCR should be adequate for this load at the top step. A 15KVA CCR has a maximum nominal output voltage of 2,272 volts, at 6.6 amps. The 10,000VA of sign load requires about 1515 volts at 6.6 amps. If the CCR is set to a lower step, the sign components on the circuit will still require 10,000 VA to maintain their brightness. Considering only the sign load and excluding any losses or efficiency issues, the 10,000 VA at 2.8 amps is now a voltage of about 3,570 volts. The CCR however, can only supply 2,772 volts, and is now undersized.

To provide the proper power to the sign, the maximum voltage needed by the signs at the lowest circuit step to be used must be considered along with the VA of the remaining circuit components, cable losses, and series isolation transformer efficiency.

A6-1.3. Potential for Conducted Emissions.

Style 2 and 3 signs include a power supply that must maintain a constant brightness on the sign even if the series circuit current is set to any of the 3 or 5 steps from a CCR. To accomplish this, the sign power supply often includes high frequency switching components which have the potential for creating conducted emissions. These emissions can adversely affect devices on the circuit or other proximate circuits. If any remote switching devices that use power line carrier technology are installed at the airport for applications such as runway guard lights or stop bars, the designer should consider conducted emissions when sharing the circuit with style 2 or 3 signs. In addition, circuits that share a conduit with sign circuits may be subject to any sign emissions cross talk. The designer should consider the application design of these components and consult the manufacturer of these products to determine if a potential problem exists.

A6-1.4. Circuit stability on circuits including style 2 or 3 signs.

Some Style 2 or 3 signs may have large swings in the load they present to the series circuit during start up or after a lamp fails. This type of load may not be well tolerated by certain CCRs, resulting in instability or shutdown of the circuit. The designer should consult the manufacturer of both the sign and CCR to determine proper compatibility.

A6-2. Series Circuit Addressable Devices.

This section provides some application guidelines to be considered when designing airfield lighting systems that include addressable switching devices.

A6-2.1. Addressable Lights General Description.

Figure 2 shows a typical power line carrier arrangement for addressable switching devices. Each fixture is connected to an Addressable Control and Monitoring Unit (ACMU) on the secondary of an L-830/L-831 isolation transformer. There is an interface in the vault (Series Circuit Interface) that sends messages onto the series lighting circuit. The ACMUs in the field receive these signals and provide a response to the interface in the vault, providing control and monitoring functionality for the lights on the circuit. Each ACMU is programmed with unique configuration parameters that control its associated fixture.

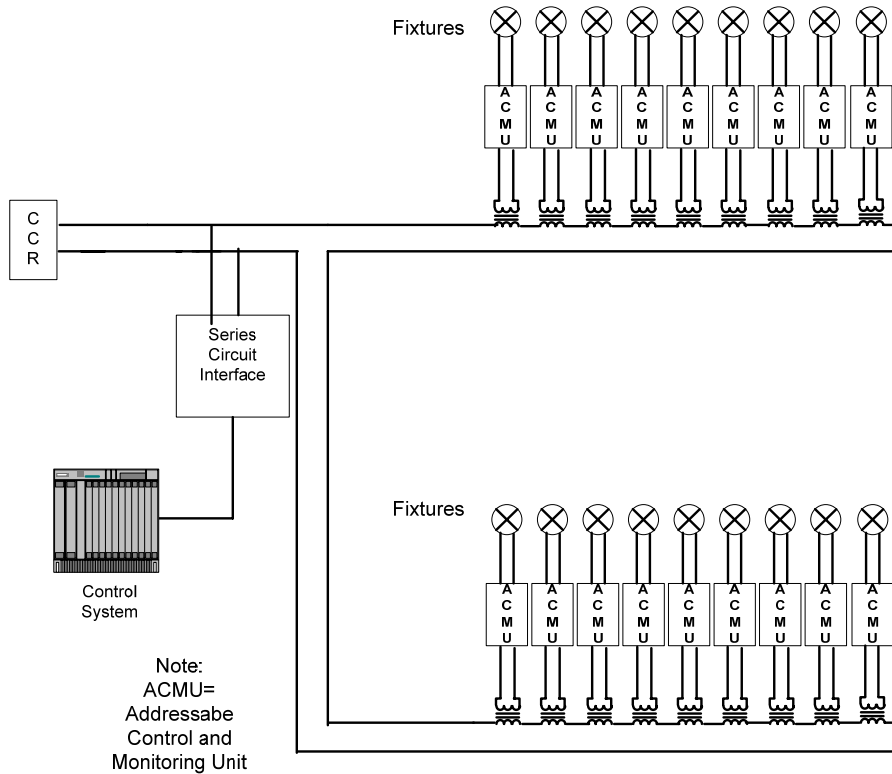

Figure 140. Typical Power Line Carrier System

The fixture is also monitored by the ACMU to detect a lamp failure.

Addressable switching systems are also available using fiber optic or twisted pair copper wire as a substitute for the power line carrier data communications on the series circuit. However, the designer must be aware that each type of data communications has its own set of design requirements. The majority of systems will use a power line carrier system since no additional cable is required. Consult with the system manufacturer for an optimal data communications design.

Some of the applications information may apply to these systems but due to their varied configurations are not covered here.

A6-2.2. Response Time Related Requirements.

There are several issues relating to the technology and electrical environment that impact the general response times of ACMU components. Depending on the application, the response time requirements may be significantly different.

A6-2.2.1. Time to change state example- Stop Bars.

In this example, a button is pressed in the tower to clear an aircraft onto or across a runway. A critical response time in this situation is the time required from the button being pushed until all of the lights on the stop bar are lit (otherwise known as change state). In some cases, the addressable system must send the messages to the addressable devices multiple times in the event that some of the devices do not properly receive and acknowledge the change state command - more time will be required to complete the execution of the command. If some of the lights in a stop bar change state while others do not (the initial command is not properly received by all of the devices in the group), all of the lights in the stop bar may not be lit at the same time. The designer must work closely with the manufacturer to ensure that response times are considered when addressable device systems are installed.

A6-2.2.2. Sensor Timing.

There are applications such as stop bars that require the use of sensors on the airfield to detect a vehicle or aircraft passage at a specific location. The sensor behavior, detection zones and response time is unique to the technology used (i.e., inductive loops, Doppler RADAR, etc.). Typically, a detection event is passed to a special addressable device that is designed to accept a logic state change or contact closure to report a detection event. The response time of an addressable system to report these detection events can vary greatly depending on how the system has been designed, the communications capabilities and performance margins, and other factors. For example, if the addressable system is polling the device that reports the status of a sensor, the time required to collect a valid status must be much shorter than the time the sensor event is present on the detection system or there is a risk of missing the detection. The sensor may be designed to retain the changed state of the sensor for a programmable time to ensure that the addressable system has reported the status. This holding time however, cannot be so long as to show the sensor in the “detect” state so that the detection of a closely following vehicle or aircraft may be missed. The addressable system support of sensor self-testing (if available) must also be considered as to how it is initiated and reported. Refer to RTCA DO-221, *Guidance and Recommended Requirements for Airport Surface Movement Sensor*, for additional information about airfield sensors. The designer should discuss the specific application with the manufacturer of the addressable control component to develop appropriate sensor performance for the application.

A6-2.2.3. Time to report status.

When the groups of lights in a stop bar change state, the next area to consider is the time required for the status of the lighting groups that have changed state to be presented on the air traffic control tower (ATCT) monitor. Generally, the tower monitor needs to display the status of lighting components as a group (i.e., stop bar, RGL bar, lead on lights, etc) and not individual fixtures unless there is a specific requirement. To display the status of lights in a group, it is necessary for the addressable lighting system to collect the status of all of the individual fixtures and determine the operational state of the group of lights. The time required to present the status will depend on the technology used and also if the messages involved in collecting the status have to be retransmitted multiple times in the event that there is a marginal communications condition.

A6-2.2.4. Failed Lamp Reporting.

Another consideration is the time required to report a failed lamp. This is typically a lower priority than the response time for commanding lighting groups. Individual lamps that have failed but have not caused the lighting group to be below its operational criteria (one lamp out or two non adjacent lamps out) is not as critical as two adjacent or any three lamps out, which causes the lighting group to not be operationally available. The designer should consider the application to determine the appropriate time the system requires when reporting a failed lamp or group of lamps.

A6-2.2.5. Incorrect status.

Poor data communications between the vault interface equipment and addressable field components may result in an incorrect status being reported with resulting nuisance alarms at the ATCT monitor. Consideration should be given to this potential issue when designing addressable lighting systems.

A6-2.3. Wattage capacity of the switching device.

In some cases, the switching capacity of the addressable switching device may depend on the CCR supplied waveform. High crest factor CCR current may not allow the use of the maximum rated load wattage. The designer should consider the application to ensure proper operation. The choice of CCR may impact the loading required. Consult with the manufacturer about potential CCR issues.

A6-2.4. Cabling issues**A6-2.4.1. Systems using power line carrier communications.**

The cable layout design for the series lighting circuit must be considered. The optimal layout of the cable can maximize communications performance and improve communications noise and interference operating margins. For new installations, separating the series circuit from other circuits on the airfield may improve communications reliability. The prevention of undesirable crosstalk arising from coupling from one cable to another is of importance. Electrical noise from other airfield components (i.e., CCRs, LED fixtures, certain types of signs or flashing lights) can also interfere with reliable communication. The designer should consult with the manufacturer to develop the best cable layout design.

A6-2.4.2. Systems Using Fiber Optic Communications.

Addressable devices may be available that use fiber optic cables connected to each device. Designers should evaluate the difficulty of installation and maintainability when considering these products. The routing of fiber in the proximity of series circuit cables may require separate conduits depending on the standards required by the airport. The fiber optic connector that is used to connect the addressable device to the communications system must be capable of withstanding the airfield environment in duct banks that are frequently or most always submerged in water that may have deicing chemicals present. The removal and replacement of a device with a fiber connector must be practical for airfield electrical maintenance personnel. This is particularly true for maintenance procedures that protect the fiber optics and connector from any damage or possible contamination.

A6-2.5.3. Systems using a separate cable for data communications.

Addressable devices may be available that use separate copper (hard-wired) cables connected to each device. These types of systems use a set of manufacturer defined conductors that may be daisy chained from one addressable device to the next and ultimately to the vault interface. Designers should evaluate the difficulty of installation and maintainability when considering these products. The hard-wired connector that is used to connect the addressable device to the communications system must be capable of withstanding the airfield environment in duct banks that are frequently or most always submerged in water or water that may have deicing chemicals present.

Since the data communication is on a low voltage cable, it must be separated from the series lighting circuit unless the twisted pair cable insulation rating is the same as the insulation rating on the series circuit cable (typically 5 kilovolts). In addition, an airport's restriction on allowed distance between splices should be considered as it may not be possible to get 5KV rated cable greater than the airport's maximum splice distance limitation.

The designer should consider system communication effects due to opens and/or shorts on the cable. A hard-wired system may require significant shielding to reduce the risk of interference. Any break in the shield due to poor installation or maintenance may cause the entire system to be more susceptible to noise.

A6-2.4.4. Existing cable.

Following optimal cable layout guidelines may not be possible for airports with existing series lighting circuits. An aging series lighting cable with multiple ground faults or arcing splices may prevent the proper operation of an addressable lighting system and may significantly impact the quality and performance of the data communications.

A6-2.5. Transformer age and selection.

Old isolation transformers with poor insulation or connectors also impact the addressable lighting system. The designer should be aware of the current airfield electrical system condition to determine if the existing transformers can be used or must be replaced. Generally, the smallest transformer capacity that will meet the fixture load requirements should be used. In some cases, larger capacity transformers can cause more loss in any data communications methodology. Consult the manufacturer of the power line carrier product when selecting isolation transformers.

A6-2.6. Load calculation.

Each addressable device will consume power on the secondary of the isolation transformer. When calculating the load, consider the peak power consumption of the device and add the loss in the additional secondary cable, particularly if there is a secondary extension cable.

A6-2.7. Load characteristics.

Most addressable devices are designed to handle incandescent loads. Generally, circuit current is checked to the load. If other types of loads (for example, LED or flashing) are to be used, consult the manufacturer to determine compatibility.

A6-2.8. Potential susceptibility to conducted emissions from other airfield devices.

LED fixtures and certain types of signs may cause conducted emissions that can propagate on the series circuit. These emissions are also able to couple from one circuit to another potentially interfering with data communications on power line carrier systems.

A6-2.9. Choice of CCR.

The selection of a particular CCR on a power line carrier circuit can improve the overall system performance. CCRs with high levels of harmonics can reduce operating performance margins. This may be true for CCRs that reconstruct the sinusoidal waveform via high frequency switching and produce output current that contain artifacts of the switching frequency. Consult the manufacturer to ensure compatibility if these types of CCRs are known to be in use.

A6-2.10. Maintainability.**A6-2.10.1. Reporting of failed components.**

In the event of a lamp failure or any component of the addressable system, the capability to convey the information to maintenance personnel should be considered. The failure reporting capability of the addressable system must be consistent with the maintenance philosophy at the airport. The reporting and locating of a failed component must be readily recognized and understood by those responsible for system maintenance.

A6-2.10.2. Programming of spares.

In the event that a failed addressable device needs replacement, the spare component will have to be configured. Some systems support in-circuit replacement while others provide a programming tool. These features should be considered as to how they impact the airport maintenance capabilities.

A6-3. Constant Current Regulators.

This section provides some application guidelines to be considered when designing airfield lighting systems with relevance to the electrical characteristics of CCRs. It should be noted that there are several manufacturers of these products and not all products will operate exactly as described in this Appendix. This information is intended to provide some general guidelines on selected topics. The designer should always consult the manufacturer for characteristics and application information that is specific to each product.

A6-3.1. Circuit Loading Considerations

Some lighting circuits on the airfield include components that load the CCR with a varying current. Examples of these loads are segmented circuits that are switched by selector switches, stop bar components, or all types of runway guard lights with flashing loads. Calculations that involve efficiency or power factors can vary greatly depending on the circuit load at a particular time. The designer should consider the extremes of the loading to ensure that the calculations include the lowest and highest possible loads.

A6-3.2. Extended load range issues.

Regulator efficiency can be significantly reduced if its load is reduced to a low level. The combination of a light load (less than 50% of CCR capacity) and many open secondary isolation transformers can cause some CCRs to become unstable.

A6-3.3. Synchronously flashing loads.

The in-pavement runway guard light (IPRGL) circuit is an example of a potentially large load swing on a circuit in the range of 30 to 32 flash cycles per minute. If all of the IPRGL fixtures on the circuit are exactly synchronized, half of the fixtures are on and off at any point in time. But as the lamps change state, the lamps that have just been turned off provide almost no load, and the lamps that have just been turned on provide about half of their load, since the filaments are still warm. As the filaments warm to full output, the “on” lamps then provide their full load. A graph that illustrates the circuit loading is shown in Figure 4.

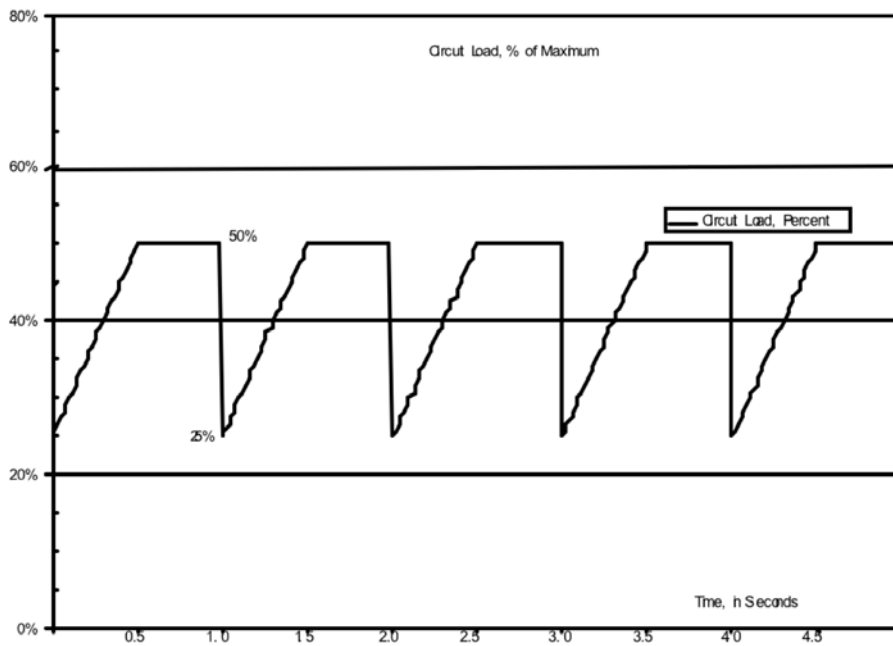

Figure 141. Load Example for In Pavement RGL Circuit

In Figure 4, it is assumed that a 100% load is with all IPRGL fixtures energized. The selection of the CCR should include consideration for this type of loading. The designer must ensure that the calculations with regard to efficiency and loading are correct. The CCR manufacturer should also be consulted as to the suitability of a given CCR to this application. The available IPRGL systems may include a built-in functionality to distribute the loading to somewhat reduce the dynamics for the circuit. In addition, the timing of the IPRGLs may be critical to avoid the case where both even and odd lights are off at the same time, resulting in very low loading by the IPRGLs. There may be a small amount of acceptable, normal CCR output current variation as the load is changing. For monitored series circuits, it is acceptable to slightly widen CCR output current monitoring alarm levels to eliminate unnecessary nuisance alarms. There may be a small

amount of acceptable, normal CCR output current variation as the load is changing. For monitored series circuits, it is acceptable to slightly widen CCR output current monitoring alarm levels to eliminate unnecessary nuisance alarms. The designer should consult the manufacturer of the CCR and IPRGL controls about the compatibility and application of these components.

A6-3.4. Asynchronously flashing loads.

An example of an asynchronously flashing load is the elevated runway guard light flashing in the range of 45 to 50 flash cycles per minute. Typically, the timing of each flashing device is unsynchronized and the series lighting circuit loading at any given moment may drift. The average loading tends to normalize over larger circuits over time, but there can be periods of time where loading is quite variable. There may be a small amount of acceptable, normal CCR output current variation as the load is changing. For monitored series circuits, it is acceptable to slightly widen CCR output current monitoring alarm levels to eliminate unnecessary nuisance alarms. The designer should consult the manufacturer of the CCR and elevated RGLs as to the compatibility and application of these components.

A6-3.5. Non-Linear or Reactive Loads.

Electronic devices such as LED fixtures, style 2 and 3 signs, and addressable components, can provide a non-linear or reactive load on the circuit. These devices can include switching power supplies which may impart a capacitive characteristic to the circuit load. In addition, when the circuit is energized, these devices can initially appear to provide a relatively high voltage drop and suddenly change to a lower drop. The designer should consult with the CCR and electronic component manufacturer to determine if there are compatibility issues to consider.

A6-3.6. CCR related emissions.

AC 150/5345-10, *Specification for Constant Current Regulators and Regulator Monitors*, includes requirements for EMI in this excerpt:

3.3.12 Electromagnetic Interference.

The regulator must cause the minimum possible radiated or conducted electromagnetic interference (EMI) to airport and FAA equipment (e.g., computers, radars, instrument landing systems, radio receivers, VHF Omni-directional Range, etc.) that may be located on or near an airport.

There is also the potential for conducted emissions from a CCR to couple to other circuits, particularly if the circuit cable is in the same conduit for long distances on the airfield. CCRs that use thyristors to control the conduction duty cycle may cause significant harmonic distortion. On the field circuit, the fast “turn on” of the thyristor can contain high order harmonics of sufficient energy to couple to other circuits through cross talk to the field cable. Another source of conducted emissions may be from CCRs that use high frequency switching to approximate a sinusoidal current waveform. This waveform can include high frequency artifacts, which can couple to other circuits on the airfield if any cables are in proximity. These circuits can be lighting or other control circuits. The emissions can adversely affect the proper operation of devices on the circuit or other proximate circuits. If any remote switching devices that use power line carrier technology are used at the airport, the designer should include considerations for the CCR selection. If any remote switching devices that use hard-wired or power line carrier technology are used at the airport, the designer should include considerations for the CCR

selection. The designer should consider the application design of these components, and consult the manufacturer of the products to determine if a potential problem exists.

A6-4. Airfield Lighting Control and Monitoring Systems (ALCMS)

This section provides some application guidelines to be considered when specifying an ALCMS or items that interface to it.

A6-4.1. Response Times.

In the specification for the L-890 ALCMS defined in AC 150/5345-56, *Specification for L-890 Airport Lighting Control and Monitoring (ALCMS)*, response times are described only in the certification testing process. The following provides instructions to test the ALCMS within a lab certification environment. Generally the system is connected with a relatively small complement of components to be controlled and monitored by the ALCMS. The response times required in 150/5345-56 and referred to this AC are, for the most part, included in Table 13-1.

Table 13-1. AGL Control System Response Times.

Time Characteristic	Response Time (seconds)
From command input until acceptance or rejection	< 0.5
From command input until control signal output to regulator or other controlled unit	< 1.0
For system to indicate that a control device has received the control signal	< 2.0
Back indication to tower display of regulator initiation	< 1.0
Switch-over time to redundant components in event of system faults (no command execution during this time)	< 0.5
Automatic detection of failed units and communication lines of the monitoring system	< 10

It must be noted that the response times shown refer only to the ALCMS. Equipment that is controlled is not part of this table. The designer must consider this and in particular, establish response times at the system level that includes the response times of components that are controlled by the ALCMS. Establish timing budgets at each interface to ensure that each product specified has its response time budget included so it can be verified on site in the event the system level response time is not acceptable.

In addition, since the response times are listed in the context of a certification test (the system is loaded with relatively few components), the designer should also address all response times in the ALCMS and connected components in the specifications when it is installed on site with all systems operational. After installation, there will be many more regulators, possibly multiple vaults, remote locations for maintenance, and some number of ATCT Human Machine Interfaces (HMI). Each of these items can change the system response time.

A6-4.2. Failover and recovery.

Depending on the level of redundancy in the ALCMS, the failover and recovery functions can have wide spread implications. The most common redundancy is in the network that connects different locations in the ALCMS (i.e., ATCT, vault(s) maintenance terminals, etc.). Redundancy protects the system from a network fault and prevents a loss of system control if a network connection fails. A more sophisticated design includes most critical components being redundant with two network connections. Each location would have two network switches and be independently powered. Within each location there would be an internal redundant network so that each component to be controlled or monitored connects to both local networks. The example from AC 150/5345-56 is shown below:

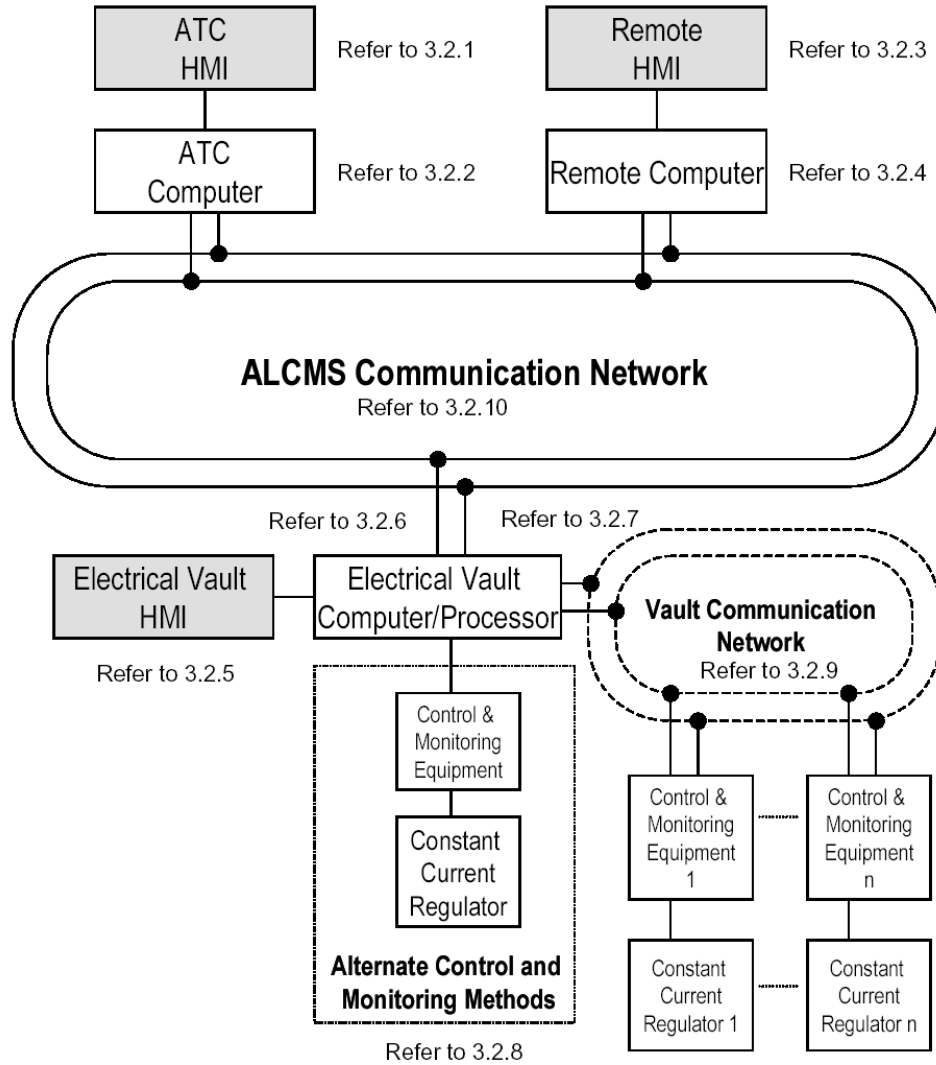

Figure 142. ALCMS Block Diagram

The issue for the designer is to consider how each failure is processed by the system. If a component on the vault communications network loses its connection on one of its networks but not the other, different system designs will imply different failover mechanisms. A simplistic design might switch all networks on the ALCMS to the backup network. This would probably take longer to complete since all components must detect and act on a network changeover. The

more likely switchover is either the vault network switching over or just the data between a failed vault component and the system is supported on the operating network segment.

Some designs may actively use both networks and fully load one network in the event the other fails. The failover design must be able to detect the loss of a component. The system must then determine the alternate means to be used as a backup and then communicate with any system components that must take some kind of action to switch over. The system must retain the status and locations of all of the components. In the event of a failure, the current system status must continue to be maintained on the backup computer or server. During the failover process, no data can be lost and the critical element is the time the ATCT HMI may be without any method of control – this is a critical system parameter. The system must also detect that a failure (component or network) has been repaired and returned to normal operation (the recovery mechanism also includes the same timing issues as fault detection).

There are many scenarios of failed components where each may cause different failover behavior with different timing. The designer must consult the manufacturer to determine the appropriate failover architecture for the airport and establish the details of the failover/recovery functionality.

A6-4.3. Site acceptance test (SAT).

AC 150/5345-56 only refers to a site acceptance test (SAT) in general terms. The designer should review (consulting the manufacturer when necessary) what critical parameters are to be considered during an SAT. For example checking the system functionality, system and component response times, loss of power, network failure, and labeling. The AC leaves it up to the supplier to develop a test plan with the designer providing approval. However, the designer can include a more detailed set of guidelines regarding site acceptance testing. This would ensure that the test is of more value to the airport owner and addresses any exceptional conditions that are likely to arise during operation.

A6-4.4. Interfaces.

If there is equipment to be connected to the ALCMS that is from different suppliers, the designer should develop a complete understanding of how each component will interact. If the control and monitoring functions are discrete wiring and contact closures, or simple analog voltages to be measured, these are more common and will be less of a problem. In the case that the interface is a more complex communication interface, the designer should ensure that these interfaces are supported by both systems and in particular that the functions defined for the application are fully supported. This should be part of the factory and site acceptance tests. If the interface is to be developed by two parties, an interface control document (ICD) should be developed.

APPENDIX 7. RUNWAY STATUS LIGHT (RWSL) SYSTEM

A7-1. Purpose

This Appendix describes the installation requirements for RWSL. While RWSL may be an FAA owned and operated system, the designer and airport authorities must be aware of how the installation of the system may impact airport operations. The RWSL system will require the installation of in-pavement lighting fixtures (consisting of Runway Entrance Lights (RELs) and Takeoff Hold Lights (THLs)), associated installation hardware that includes conduit, high voltage cable, equipment vault(s), and data links from the air traffic control tower to the electrical vault(s). Airport Authorities should be prepared to participate in meetings with the FAA to establish consensus and approve installation plans/schedules, any airport related operational impacts/associated costs, and optimal equipment and light locations. Additionally, RWSL construction activities may affect multiple taxiway and runway operations. Therefore, airport authorities should be prepared to fully assess and agree to any prolonged operational impacts and unique airport specific requirements.

A7-1.1. System Description.

The purpose of the RWSL System is to reduce the number of runway incursions without interfering with normal airport operations. Runway status lights display critical, time-sensitive safety status information directly to pilots and vehicle operators via in-pavement lights giving them an immediate indication of potentially unsafe situations. Runway status lights indicate runway status only; they do not indicate clearance.

The RWSL System uses computer processing of integrated surface and terminal surveillance information to establish the presence and motion of aircraft and surface vehicles on or near the runways. The system illuminates red runway-entrance lights (RELs) if the runway is unsafe for entry or crossing, and illuminates red takeoff-hold lights (THLs) if the runway is unsafe for departure. The system extinguishes the lights automatically as appropriate when the runway is no longer unsafe.

The RWSL System consists of an RWSL processor and a Field Lighting System (FLS). The RWSL processor receives surveillance data of aircraft and vehicles on or near the airport surface from the ground surface surveillance system. The RWSL processor uses this surveillance data to determine when to activate and deactivate the RELs and THLs. These light commands are sent to the RWSL FLS. The FLS includes a Light Computer (LC), in pavement light fixtures, and all light system circuitry. The FLS receives the light commands and illuminates and extinguishes the lights as commanded by the RWSL processor. The system will automatically determine runway configurations and will adjust the activation and deactivation of RELs and THLs accordingly. The system will automatically adjust light intensity according to time of day.

Air Traffic supervisors control the system using a cab control panel. Control functions will include light intensity control (override of automatic intensity adjustment) separately by RELs and THLs. Status indicators will be provided such as system online/offline and if maintenance is required. A separate kill switch will be provided to deactivate all RWSL fixtures in the event of a system malfunction.

The RWSL System includes a maintenance terminal for Technical Operations personnel to control the RWSL System and to assist with identification of failed line replaceable units (LRUs).

The maintenance terminal also provides all tools and controls necessary to configure and optimize the system.

A7-2. Installation.

A7-2.1 Runway Entrance Lights (REL)

RELs are installed at taxiway/runway intersections and advise aircrews or vehicle operators when it unsafe to cross or enter a runway. The airport authority should ensure that RELs are certified to AC 150/5345-46, *Specification for Runway and Taxiway Light Fixtures*, Type L-852S, Class 2 (base mounted), Mode 1 (constant current fixture – 6.6A), Style 3 (total height above finished grade is less than or equal to ¼ inch (6.35 millimeters)).

A7-2.2 REL Light Base.

Light mounting bases should be Type L-868, Class IA or IB, Size B per AC 150/5345-42. Ensure that all light bases are installed per Sections 11 and 12 of AC 150/5345-30.

A7-2.3 REL Configurations.

The following standards apply for the most common REL configurations:

- Basic Configuration (straight taxiway perpendicular to the runway)
- Angled Configuration (straight taxiway not perpendicular to the runway)
- Curved Configuration (curved taxiway at a varying angle to the runway)

A7-2.3.1 Basic (90-degree) Configuration.

This is the most common intersection. See Figure 143. Because the taxiway centerline is perpendicular to the runway centerline, the longitudinal line of RELs is also perpendicular to the runway, and all the lights are aimed along the taxiway path, that is perpendicular to the runway centerline.

RELs are installed parallel to the taxiway centerline and spaced laterally two (2) feet from the taxiway centerline on the opposite side of taxiway centerline lights (if installed). A REL array will consist of a minimum of six (6) lights and may include more, depending on the distance between the runway centerline and the holding position. The first light in the taxiway segment is installed two (2) feet prior to the runway holding position marking. The next to last light is installed two (2) feet prior to the runway edge stripe. The last light in the array is installed two (2) feet to the side of the runway centerline lights toward the intersecting taxiway (See Section 4, Table 4.1 of AC 150/5340-30 for longitudinal spacing standards.) The REL light base installation must be no closer than 2 feet (0.6 m) (measured to the edge of the fixture base) to any pavement joints.

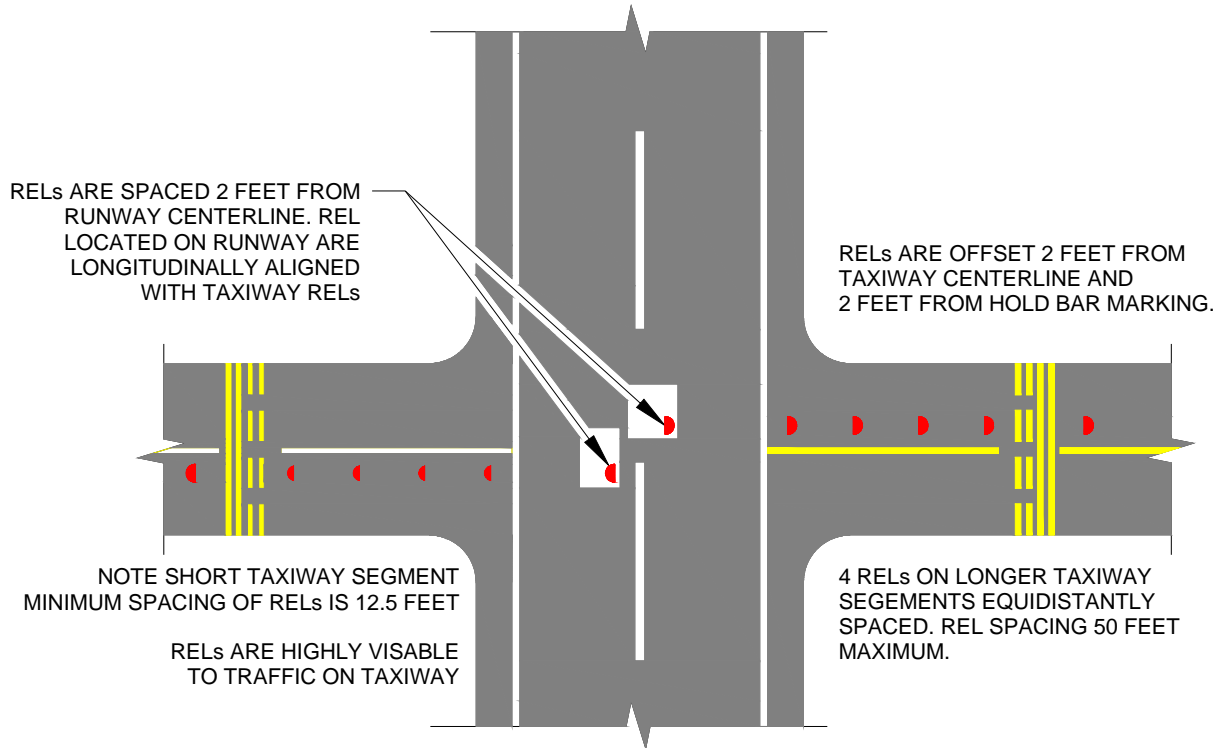

NOTE: REL (TYPE L-852S FIXTURE) BEAM COVERAGE IS DESCRIBED IN AC 150/5345-46B, SPECIFICATION FOR RUNWAY AND TAXIWAY LIGHT FIXTURES, TABLE 1. PHOTOMETRIC REQUIREMENTS FOR IN-PAVEMENT LIGHTS.

PROPOSED REL INSTALLATION AT 90° TAXIWAY/RUNWAY INTERSECTIONS

Figure 143. REL Configuration for Taxiways at 90 Degrees

A7-2.3.2 Angled Configuration.

See Figure 144. This configuration is used where the intersecting taxiway is not perpendicular to the runway centerline but not less than 60 degrees from the runway centerline. The location and spacing of the REL lights along the taxiway centerline is identical to the one used on perpendicular intersections. Ensure that RELs cannot be seen by traffic on the runway. For highly angled taxiways (e.g. less than 60 degrees from the runway centerline heading), the fixtures used and aiming will be determined on a case by case basis.

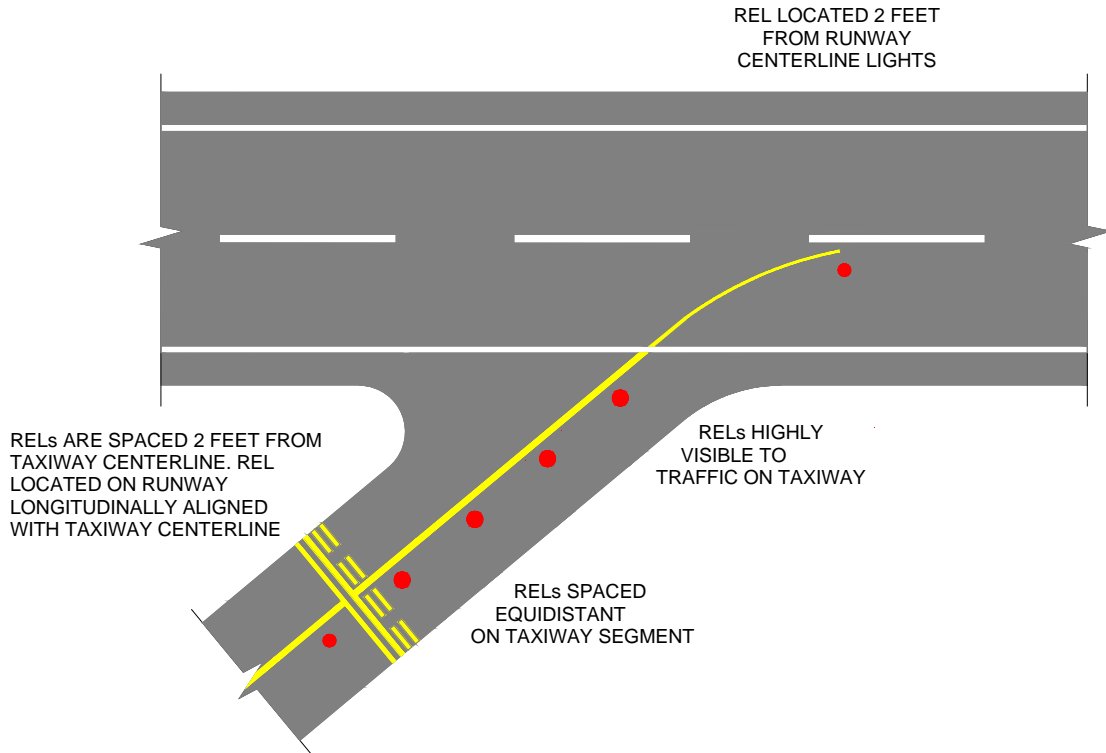

Figure 144. Angled Configuration

A7-2.3.3 Curved Configuration.

The airport authority should be prepared to closely coordinate with the FAA for the placement and aiming of REL fixtures to be installed on taxiways when the taxiway centerline marking is curved between the runway holding position marking and the runway. The longitudinal dimensions in Section 4, Table 4-1, of this AC should be used to initially establish spacing requirements in the planning stage.

A7-2.4 Takeoff Hold Lights (THL).

THLs are used at the runway departure area to warn aircrews and vehicle operators that the runway is unsafe for takeoff. See Figure 145. THLs are a double row of unidirectional in-pavement red lights aligned with the runway centerline lights (centerline of light fixture) aimed toward the approach path to the runway. They begin at a point that is 375 feet from the runway threshold and are displaced 6 feet on either side of the runway centerline lights. THLs are placed every 100 feet for 50 foot spaced centerline lights (between the centerline lights in every other space). There will be 1500 feet of lights (32 lights) in the array.

A7-2.4.1 THL Fixtures

THLs are based upon a Type L-850A, Class 2, Mode 1, Style 3 fixture modified with a 105 watt lamp and ITE Red filter or certified LED equivalent. The airport authority should ensure that all installation guidelines in Sections and 11 and 12 of AC 150/5345-30 are followed.

A7-2.4.2 THL Mounting Base.

THL mounting bases are identical to those used for RELs.

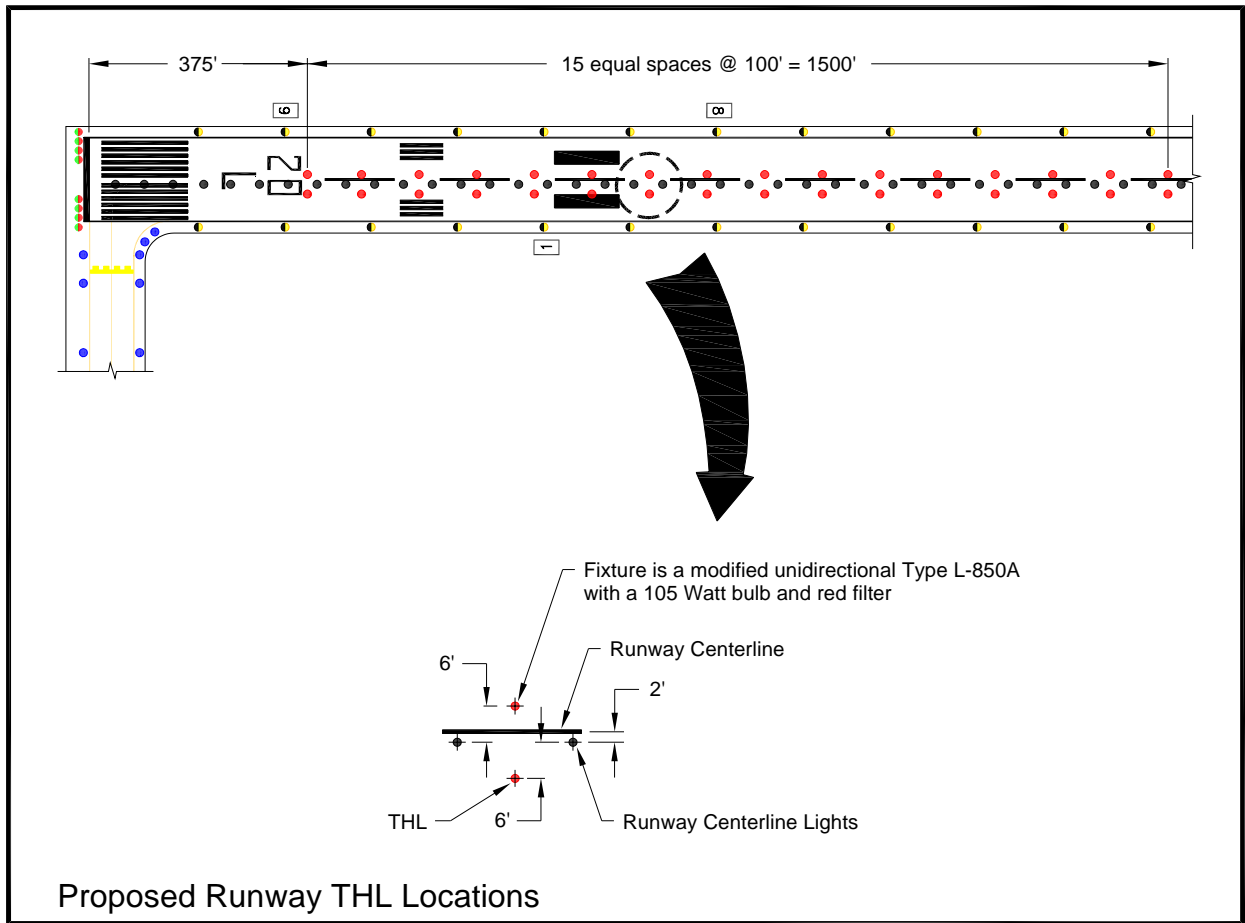

Figure 145. Takeoff/Hold Lights

A7-2.5 Constant Current Regulator (CCR) Power Supply.

This unit provides constant current power (via series lighting circuit high voltage cable) to all RWSL THL/REL lamps. The CCR is an FAA Type L-828 (no monitoring) Class 1 (6.6 Amps) per AC 150/5345-10, *Specification for Constant Current Regulators/Regulator Monitors*. The lighting vault housing the CCRs and other commercial AC Power equipment will be located in an area mutually acceptable to the FAA and the Airport Authority.

A7-2.6 Isolation Transformer.

The RWSL isolation transformers will be Type L-830-18 (for both THLs and RELs) per AC-150/5345-47, *Isolation Transformers for Airport Lighting Systems*. All connectors used should be per AC 150/5345-26.

A7-2.7 Individual Light Controller (ILC).

The ILC input connects to the secondary side of the isolation transformer and enables computer control of the THL or REL lamp via power line carrier based data communications. The ILC provides monitoring of lamp current, voltage, and load status, including a lamp out detection when it is not processing commands. If a lamp fails, the ILC places a short across the secondary side of the isolation transformer to maintain light system loading.

A7-3 DESIGN.

A7-3.1 General Guidelines.

The RWSL will be installed using new conduit where possible for existing runways/taxiways. Future installations of in-pavement L-868 light bases and conduit should be done, if possible, while the pavement is under construction or when an overlay is made. Installation of conduit and light bases after paving is very costly and requires a lengthy shutdown of the taxiway or runway. The airport authority should ensure that all installation guidelines, methods and techniques (Sections 10, 11, and 12) guidelines in this AC are followed when an RWSL installation is scheduled.

A7-3.2 Layout.

A design drawing must be developed prior to construction (coordinated with and approved by the airport authority) showing the dimensional layout of each RWSL lighting system to be installed.

A7-3.3 Overlay Rigid and Flexible Pavements.

See Section 10 of this AC for installation guidance and information.

A7-3.4 Existing Pavements.

See Section 10 of this AC for installation guidance. Su

A7-4 SURFACE MOVEMENT GUIDANCE CONTROL SYSTEM (SMGCS)

Any potential impacts of the RWSL system on airport SMGCS operation must be evaluated and resolved with the local Airport Authority and Airports District Office prior to commencing any installation activities.

A7-5 EQUIPMENT AND MATERIAL.

All equipment and material will be supplied by the sponsoring activity.

A7-5.1 Lighting Vault.

The vault location is subject to the approval of the local Airport Authority before installation begins.

A7-6 OPERATIONAL TESTING.

The airport authority should be prepared to coordinate with the FAA to minimize potential impacts to airport operations.