

**STATUS OF THE BLACK ROCKFISH RESOURCE NORTH OF CAPE
FALCON, OREGON TO THE U.S.-CANADIAN BORDER
IN 2006**



Farron R. Wallace¹, Yuk Wing Cheng², and Tien-Shui Tsou²

¹ Washington Department of Fish and Wildlife
48 Devonshire Road
Montesano, Washington 98563

² Washington Department of Fish and Wildlife
600 Capitol Way NE
Olympia, Washington 98501

August 2007

Executive Summary

In this document, we included model results from the STAR base model and results based on the “STAT best fit” model, where natural mortality for “old” females is assumed to be 0.24 compared to the assumption of 0.2 in the STAR base model. All other parameter settings remain the same in both models. The “STAT best fit” model is based largely on new and expanded analyses following the conclusion of the STAR Panel. We ran a grid search of natural mortality between 0.1 and 0.3 for “old” females and found that model with natural mortality of 0.24 for “old” females resulted in a better fit to the data with the largest negative change in log likelihood. The mortality of 0.24 agreed with a direct estimate of female natural mortality at 0.27 (SE = 0.26) from historical catch, effort, and length frequency data. We felt compelled to integrate these results because the “Low Natural Mortality” model selected by the STAR panel to bracket model uncertainty does not appear plausible. Further, we believe that management should be based on the “STAT best fit” model because it represents the best fit to data, and the STAR base and “High Natural Mortality” models be used to bracket the uncertainty.

Stock

This assessment applies to the Northern portion of the black rockfish (*Sebastes melanops*) stock found between Cape Falcon, Oregon and the U.S. border with Canada. This assessment treats these fish as a separate unit stock. The stock found South of Cape Falcon, Oregon is treated as another unit stock in a different assessment document. Black rockfish are not subjected to a targeted fishery in Canadian coastal waters and are not assessed.

Catches

Little information exists on the historical landings of black rockfish prior to the early 1960's. Landings of “rockfish” peaked at nearly 25,000 mt in 1945 in support of the war effort; however, there is no known species composition estimates for these catches. Due to the nearshore habitat of this species it is likely that very little of this catch was black rockfish. Predominate harvesters of black rockfish between 1963 and 1983 were commercial line and trawl fishers. Black rockfish trawl landings typically came from directed tows on nearshore rocky reefs and shipwrecks with few landings incidental to other targeted fisheries. Peak landings in the trawl fishery reached 350 mt in 1976 and declined to less than 10 mt in recent years. Black rockfish comprised less than 1% of total rockfish landings by the trawl fishery during this period.

The “non-trawl” fishery is composed of three distinct line fisheries, and each differs in target species. Oregon and Washington fish receiving tickets show nominal rockfish catches as early as 1970 in the salmon troll fishery, during 1973 in the jig fishery, and during 1979 in the bottomfish troll fishery. Black rockfish are generally caught as bycatch in the commercial salmon troll fishery; landings peaked in the late 70's (151 mt) and steadily decreased coincident with losses in fishing opportunities for coastal salmon. The bottomfish troll fishery generally targeted lingcod; rockfish landings were small and estimated black rockfish catch never exceeded 2 mt. The jig fishery is primarily composed of small vessels less than 26 feet in length that generally fish near their port of

access. Black rockfish were targeted in nearshore areas and were a significant fraction of the nominal rockfish landings in the jig fishery. Black rockfish catch in the jig fishery was inconsequential prior to 1980, and peaked in 1982 at 272 mt. Since 1996, nominal rockfish landings have contained no black rockfish due to area restrictions that have forced jig fishers to target other rockfish species found farther offshore.

Black rockfish are the primary target of the coastal groundfish sport fishery, with small catches first reported in the late 1970's that steadily increased to over 300 ton per year by the mid 1990's. Due to the implementation of a 10 fish bag limit in 1995 (Figure 7), and longer salmon seasons, annual catches of black rock declined to 188 mt in 2001. In recent years, sport catches increased to more than 300 mt. The coastal recreational rockfish fishery generally competed with sport salmon, halibut and tuna fisheries, and this is reflected in year-to-year variability in black rockfish catch.

Discard of black rockfish in Washington waters in either the commercial or recreational fisheries is likely very small. "Sebastes complex" trip limits in the line fishery were non-restrictive prior to 1999 since few landings ever achieved the trip limit, and there was no incentive to discard catch. Furthermore, Washington State waters (inside 3 miles) have been closed to directed non-trawl commercial fishing since 1996 and directed trawl fishing since 1999. Black rockfish represented only a small fraction of the nominal rockfish catch in the trawl fishery and it is unlikely they were discarded. Discard in the sport fishery is also insignificant since the vast majority of recreational fishers do not high-grade their rockfish catch. This is supported by recent sport fishery information that indicates discard is less than 16 mt on an annual basis.

Recent Black Rockfish Landings From Waters North of Cape Falcon, Oregon to the US-Canadian Border by Gear and Area

	Trawl Gear				Non-Trawl Gear			Recreational		
	3A	3B	3CS	Total	3A	3B	Total	3A	3B	Total
1995	2.9	0.1	0.3	3.3	2.7	63.1	65.8	209.3	55.5	264.8
1996	0.0	0.0	0.0	0.0	4.8	3.8	8.6	199.7	64.6	264.2
1997	0.7	8.2	0.1	9.0	14.5	0.5	15.0	179.7	54.4	234.1
1998	72.5	0.3	0.3	73.1	0.4	4.5	4.8	195.2	64.2	259.4
1999	0.0	0.0	0.0	0.0	3.4	0.9	4.3	166.0	55.6	221.6
2000	0.0	0.0	0.0	0.0	0.5	0.7	1.2	157.6	67.2	224.8
2001	0.0	0.0	0.0	0.0	0.6	0.5	1.1	133.7	55.0	188.7
2002	0.1	0.1	0.0	0.2	0.4	1.0	1.5	173.0	66.0	238.9
2003	0.1	0.0	0.0	0.1	0.0	0.2	0.2	166.7	70.4	237.1
2004	0.6	0.0	0.0	0.6	0.4	0.3	0.7	173.4	94.6	268.0
2005	0.0	0.0	0.0	0.0	0.3	0.6	0.9	217.5	114.2	331.7
2006	1.2	0.2	0.0	1.4	0.8	0.4	1.2	246.7	74.9	321.5
Total	78	9	1	88	29	77	105	2,218	837	3,055

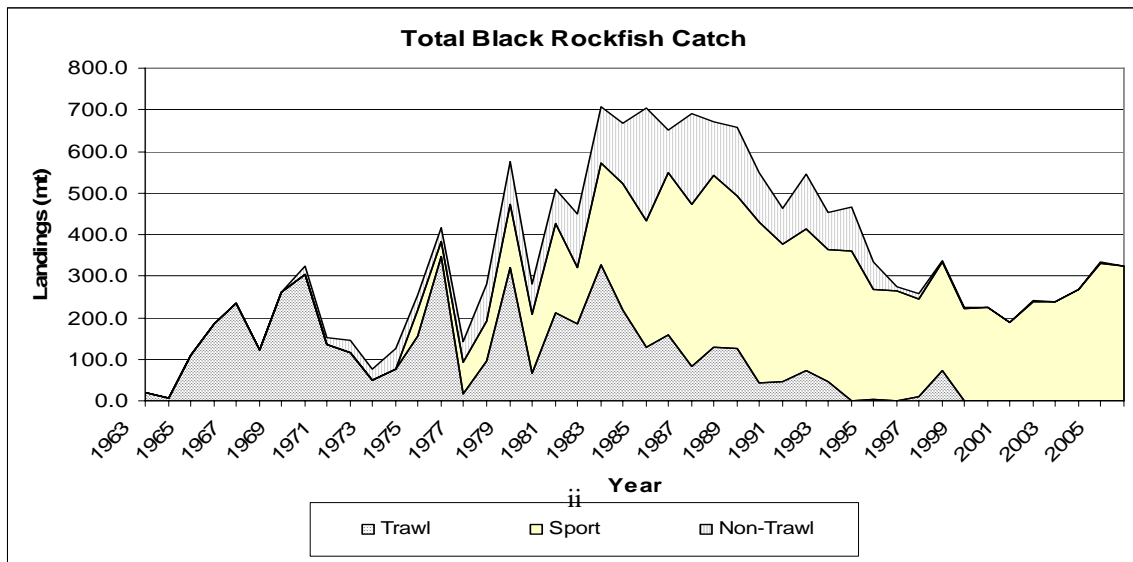

Data and Assessment

This portion of the U.S. black rockfish stock was last assessed in 1999 (Wallace et al. 1999) with a population dynamics model constructed with AD model builder software (Fournier1997).

The current assessment employed Stock synthesis 2 (SS2V2.00c, compiled 3/27/2006) to model the dynamics of the black rockfish population found between Cape Falcon, Oregon and North to the U.S./Canadian border in Coastal Waters. The model was specified to begin in 1915 to ensure population equilibrium at the start of the modeling time period. Catch data were decayed from the last reliable catch estimates (1965) to 0 by 1940. Fisheries catch, size and age compositions were pooled into three fishery types including trawl, sport and non-trawl. The first size-age compositions were collected in the mid 1970's from the trawl fishery, but samples were not collected on a systematic basis until 1985. Growth (L_{min} , L_{max} and k) was estimated within the model to account for fishery selection of the larger individual fish at age. The population model was tuned to two fisheries-independent indices that include a tagging CPUE (1986-2007) and a tag abundance biomass index (2000-2007), both derived from WDFW black rockfish tagging information. Both STAT and STAR Panel members agreed that the available fishery dependent indices should not be incorporated due to potential bias resulting from bag limit changes and undocumented measures of fishing effort resulting from changes in search time across the time series.

Unresolved Problems and Major Uncertainties

Natural mortality is confounded with fishing mortality and is therefore one of the most challenging biological parameters to estimate. It is also one of the most important parameters due to its affects on population dynamics, including stock rebuild time and the estimation of virgin fishery biomass. In this assessment, we explored direct methods to estimate natural mortality and compared it to estimates derived from indirect methods (from other biological parameters, e.g., the growth constant and fecundity) in previous assessments. The estimated \hat{M} derived from direct methods was 0.223 (SE= 0.0071) and 0.272 (SE= 0.061) for males and females, respectively. Given the uncertainties, these estimates compared well with other existing indirect methods. The current base model assumes a female natural mortality rate to be age-specific for females using age at first and full maturity for inflections (10 and 15). A constant natural mortality rate of 0.16 was assumed for males and young females (< 10 years of age), and a rate of 0.2 was assumed for old females (≥ 15 years of age). This is higher than that used in the 2003 black rockfish assessment off Oregon and California (Ralston and Dick 2003) which used a natural mortality of 0.1 and 0.2 for males and old females, respectively. It is apparent from our analysis using both direct and indirect methods that our current assumptions on natural mortality in the base model are within our limits to estimate this parameter and that the low natural mortality rate model is likely too low. Model sensitivity analysis showed that model configurations using higher natural mortality for older females provided better overall fits to the data than the STAR base model.

Changes in total log likelihood relative to Base model

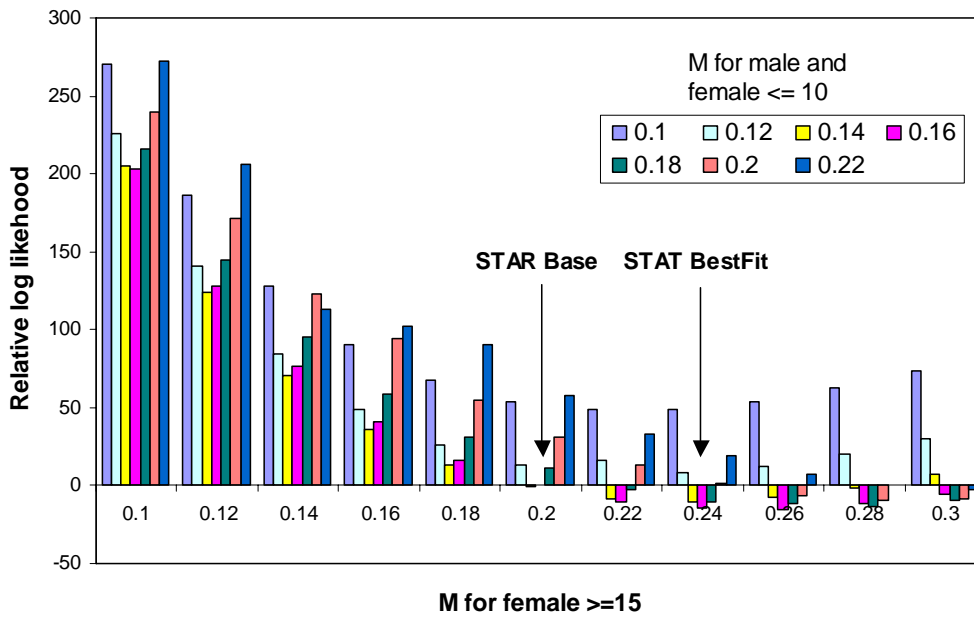

Tagging is not incorporated in the model as a tagging experiment, which is not possible within the current SS2 modeling framework. The index for tagging abundance is not fit well, and the model estimated effective q for the tagging index was 0.83. This is likely double what it should be based on STAT knowledge of available habitat off the Washington coast. Further, the north central Washington coast, where most of the nearshore rocky habitat exists, is inaccessible to most recreational fishers and is not part of the current tagging program. However, the estimation of q is complicated by the fact that the SS2 value of q is a function of selectivity that is strongly dome shaped for the fishery. Increasing the weighting on survey abundance shows that a better fit to the survey abundance index significantly improves our view of the current population status.

Base Model Sensitivity to Relative Weighting on Tagging Abundance

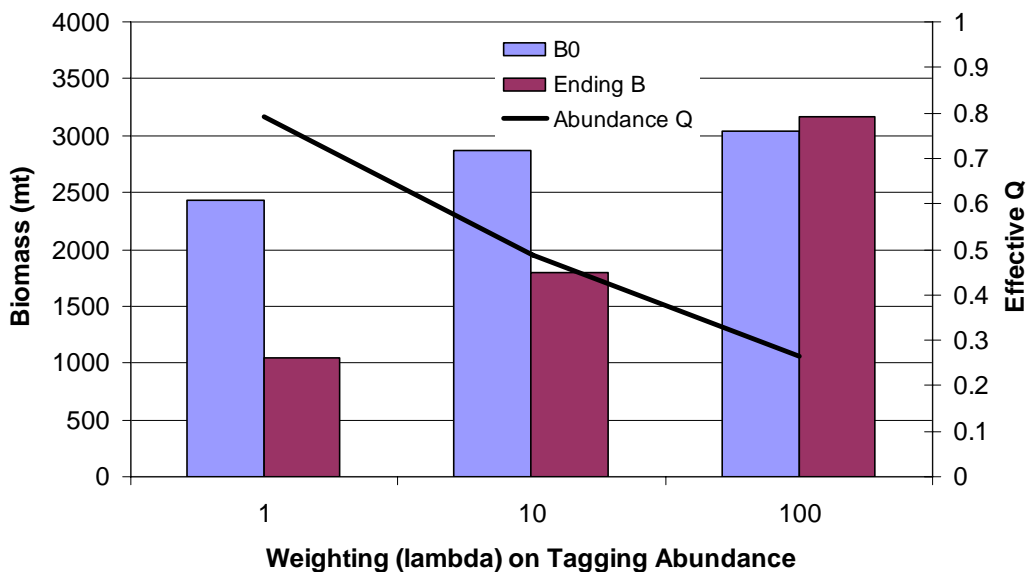

Without an objective evaluation of an informed prior on q , it is difficult to compare a prior conception of q based on tagging and the one estimated by SS2. Other issues include the non-independence of the length/age compositions and non-independence of the tagging abundance and CPUE series.

Reference Points

The Pacific Fisheries Management Council recommends that a default target fishing mortality rate of $F_{SPR}=0.5$ be used for Council managed rockfish species. The current assessment uses this default for harvest projections for black rockfish and based on the Councils control rule for groundfish would not be considered overfished. The “STAR base” represents results from the STAR base model and the “best fit” model represents results from the best fit model incorporated by the STAT in the decision matrix post-STAR.

STAR Base Model Reference Points

Unfished Stock		Value		
Age 3+ Biomass (B_0) (mt)		10,813		
Spawning Biomass SB_0 (mt)		2,429		
SPBio/Recruit (kg/fish)		0.780		
Age1 Recruitment (R_0) (1,000's)		3,113		
Steepness R_0_{S0}		0.6		

Exploited Stock	Reference points based on		
	Estimated MSY	$SB_{40\%}$	SPR ($SB_{0.5}$)
SPR (Spawning Biomass/Recruit)	0.413	0.400	0.400
F (Fishing Mortality Rate)	0.132	0.101	0.101
Exploitation Rate (Yield/Bsmry)	0.076	0.060	0.060
MSY (mt) or MSY proxy (mt)	377	361	361
Yield (mt)	718	972	972
SPBIO/ SB_0	29.6%	40.0%	40.0%
Age 3+ Biomass	4,947	6,012	6,012

STAT Best Fit Model Reference Points

Unfished Stock		Value		
Age 3+ Biomass (B_0) (mt)		11,390		
Spawning Biomass SB_0 (mt)		2,321		
SPBio/Recruit (kg/fish)		0.687		
Age1 Recruitment (R_0) (1,000's)		3,377		
Steepness R_0_{S0}		0.6		

Exploited Stock	Reference points based on		
	Estimated MSY	$SB_{40\%}$	SPR ($SB_{0.5}$)
SPR (Spawning Biomass/Recruit)	0.418	0.400	0.40
F (Fishing Mortality Rate)	0.141	0.110	0.110
Exploitation Rate (Yield/Bsmry)	0.081	0.065	0.065
MSY (mt) or MSY proxy (mt)	423	408	408
Yield (mt)	700	928	928
SPBIO/ SB_0	30.1%	40.0%	40.0%
Age 3+ Biomass	5,218	6,264	6,264

Stock Biomass

The estimated current spawning biomass resulting from the STAR base model was 1,034 mt and unexploited spawning biomass is 2,429 mt, resulting in a current stock level that is 42.6% of the unfished. The STAT best fit model estimates current spawning biomass as being 1,239 mt and unexploited spawning biomass at 2,321 mt, resulting in a current stock level that is 53.4% of the unfished. In both models spawning biomass and age 3+ biomass reached the lowest levels in 1995, following poor recruitment and intense fishing in the late 1980's.

STAR Base Model Results

Year	1997	1998	1999	2000	2001	2002	2003	2004	2005	2006
Spawning Biomass	612	652	701	754	809	880	938	985	1016	1034
% of Virgin	0.252	0.268	0.289	0.310	0.333	0.362	0.386	0.405	0.418	0.426
Age 3+ Biomass	5069	5107	5146	5433	5594	6133	6178	6143	6204	6180

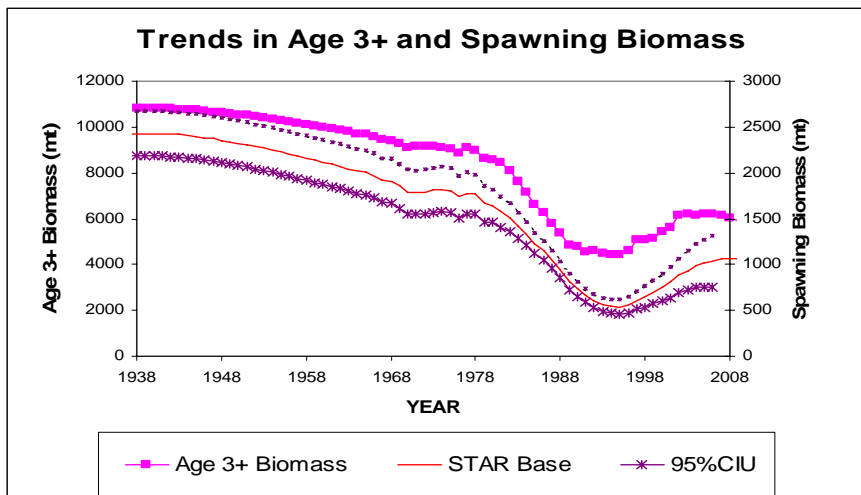

STAT "Best Fit" Model Results

Year	1997	1998	1999	2000	2001	2002	2003	2004	2005	2006
Spawning Biomass	707	762	826	891	959	1043	1114	1171	1211	1239
% of Virgin	0.304	0.328	0.356	0.384	0.413	0.449	0.480	0.505	0.522	0.534
Age 3+ Biomass	5977	6066	6147	6516	6739	7405	7485	7470	7564	7558

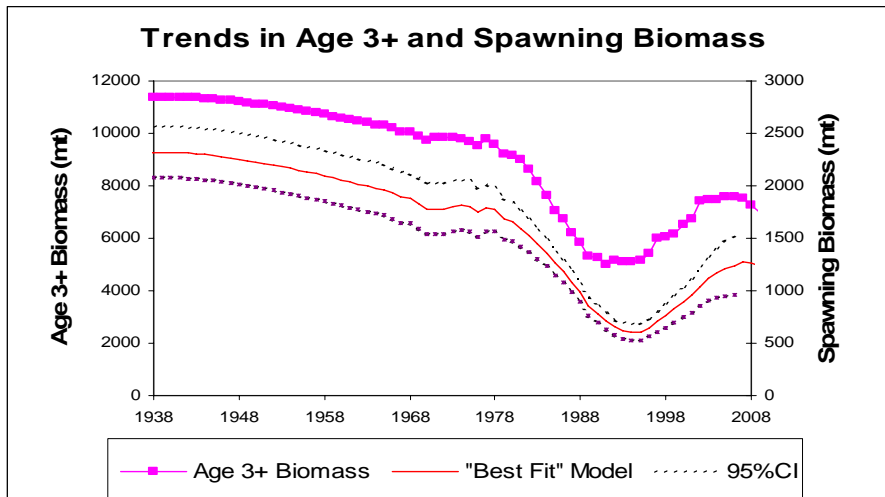

Recruitment

Recent increases in biomass are the result of two prominent year classes in 1994 and in 1999. The 1999-year class is estimated to be the largest year class since the beginning of the estimation phase.

STAR Base Model Results

Year	1997	1998	1999	2000	2001	2002	2003	2004	2005	2006
Age 1 Recruits (1,000's)	2,614	2,239	4,478	1,997	1,696	2,414	2,468	2,509	2,535	2,550

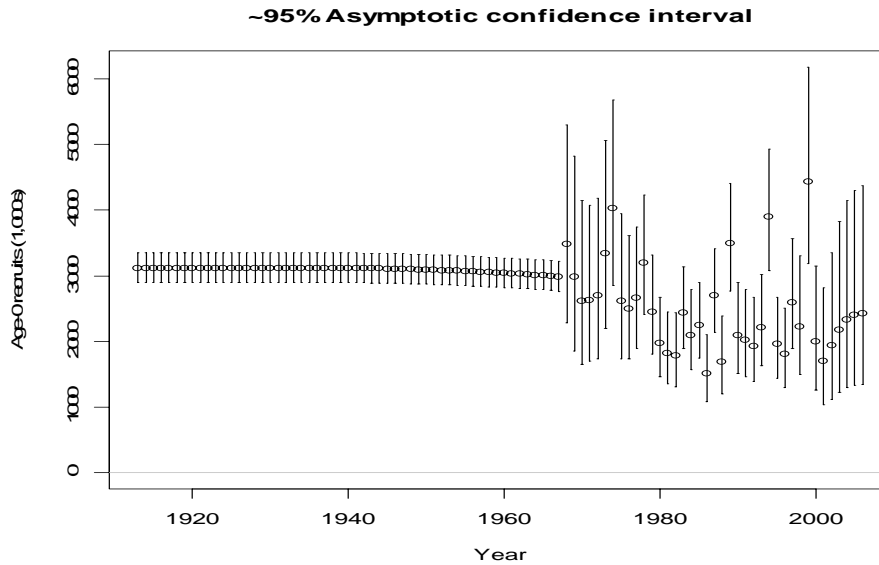

STAT "Best Fit" Model Results

Year	1997	1998	1999	2000	2001	2002	2003	2004	2005	2006
Age 1 Recruits (1,000's)	3,129	2,732	5,410	2,444	2,075	2,826	2,882	2,924	2,951	2,970

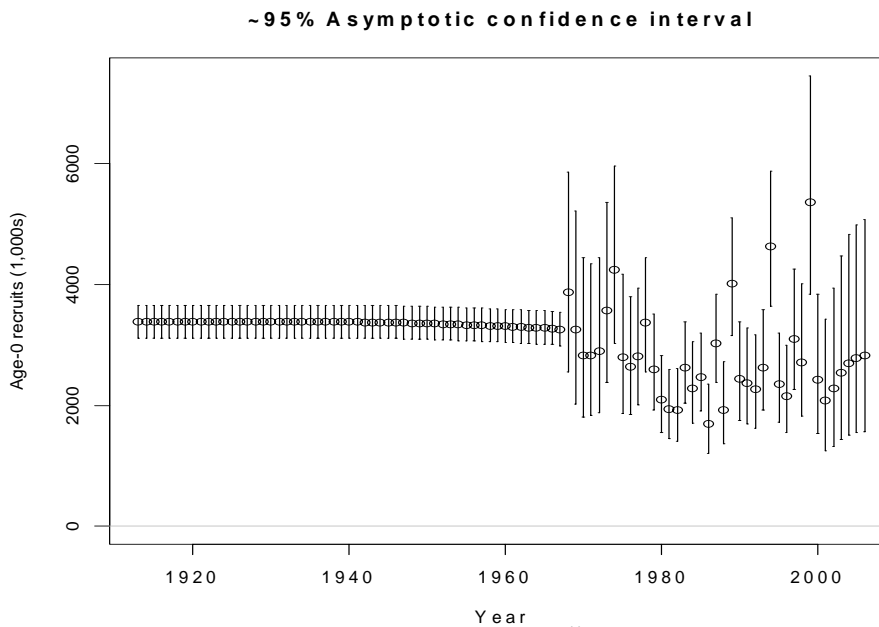

Exploitation Status

Exploitation of black rockfish reached a peak in 1988 of 13% of the Age 3+ biomass and remained near that level for 7 years, dropping precipitously between 1995 and 2000. In recent years exploitation has been relatively low (4-6%).

STAR Base Model Results

Recent trends in black rockfish exploitation

Year	1997	1998	1999	2000	2001	2002	2003	2004	2005	2006
Total Exploitation Rate	0.0501	0.0418	0.0326	0.0323	0.027	0.0334	0.033	0.0368	0.0448	0.0432

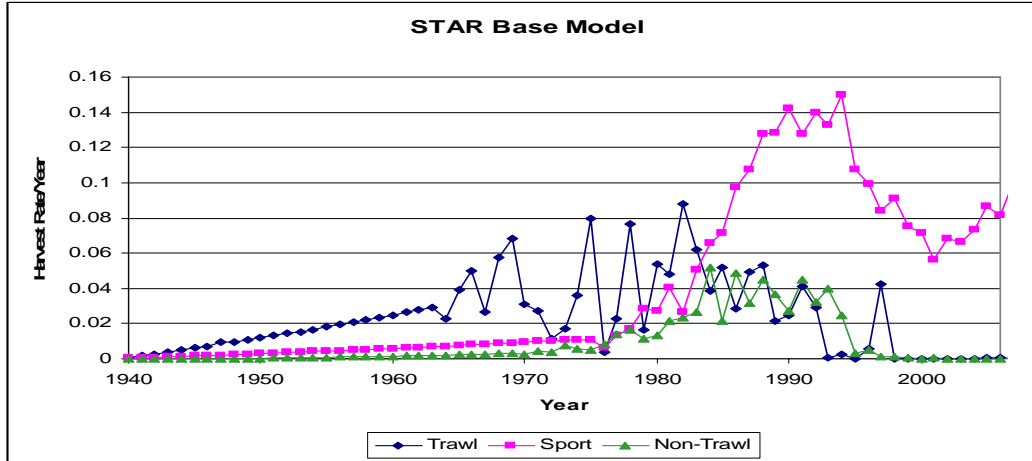

STAT "Best Fit" Model Results

Recent Trends in black rockfish exploitation

Year	1997	1998	1999	2000	2001	2002	2003	2004	2005	2006
Total Exploitation Rate	0.042	0.035	0.027	0.027	0.022	0.028	0.027	0.030	0.037	0.036

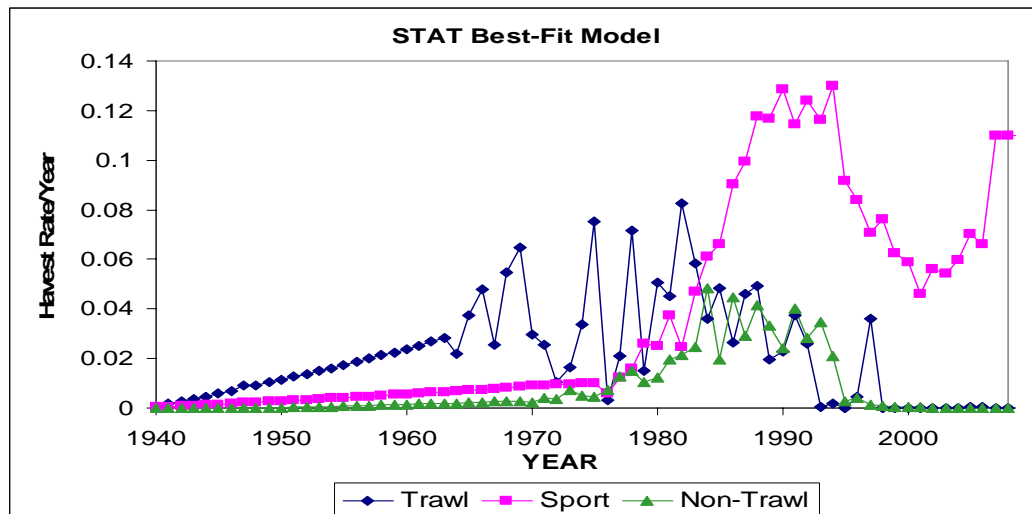

Black rockfish stock abundance has been below the Councils' management target and results from the STAR base model indicates that it has dipped below the Councils' minimum stock size threshold in the last decade. The stock is currently above the management target of B40% in both the STAR base and STAT best fit models.

STAR Base Model

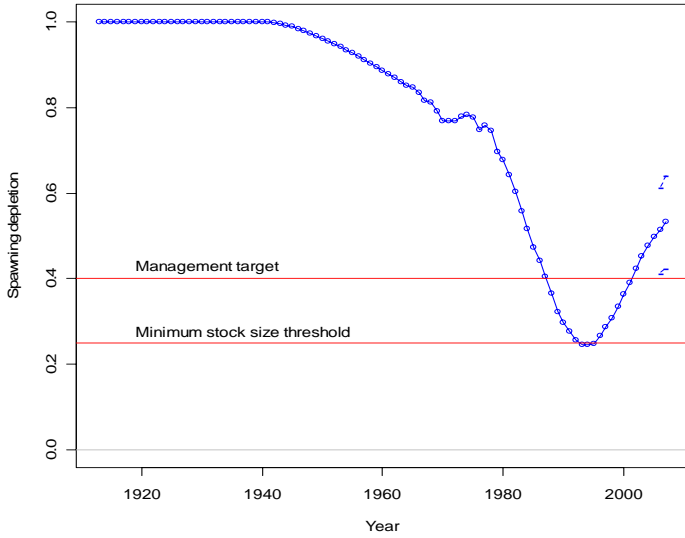

STAT "Best Fit" Model

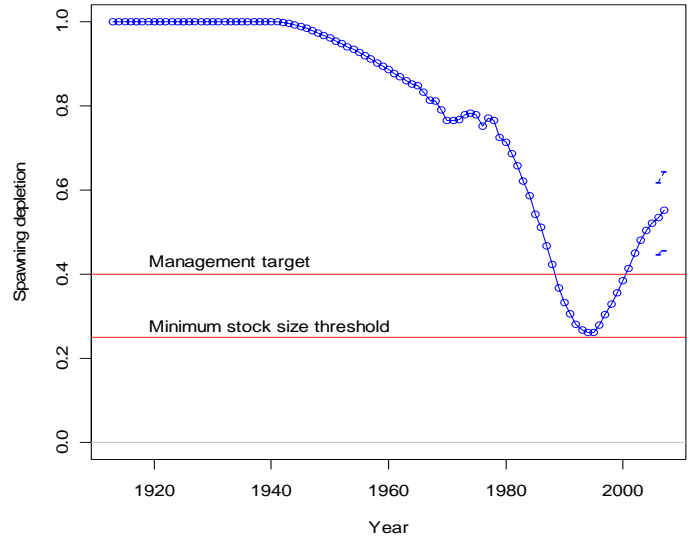

Exploitation rate relative to spawning biomass indicate that harvest rates exceeded management targets between the mid 1980's through the mid 1990's. The STAT best fit model indicates a slightly improved exploitation time series.

STAR Base Model

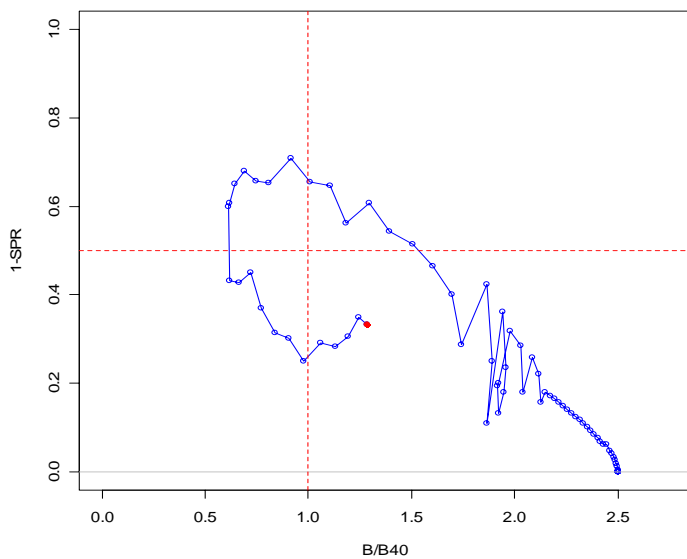

STAT "Best Fit" Model

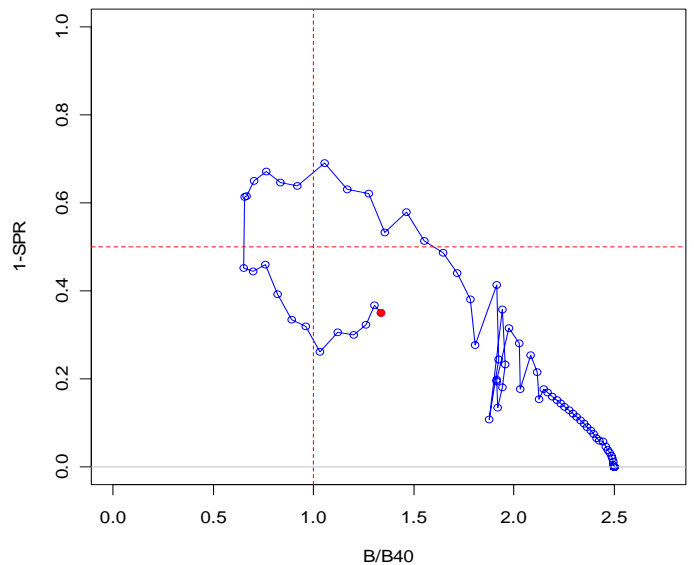

Management Performance

Harvest has remained well below the harvest guideline of 517 mt (1997-1999) and the 577 mt (+- 2CV's 523-632 mt's) equilibrium catch following the 1994 (Wallace et al., 1994) and the 1999 assessment (Wallace et al., 1999), respectively. The 1999 assessment estimated the 2001 spawning biomass of 646 mt (+- 2CV's 601-687 mt's) with an equilibrium spawning biomass of 451 mt (+- 2CV's 401-501 mt's) equating to a 2001 SB_{2001}/SB_{Equil} of 143%. The catch time series includes discard when existing, ABC is constant and changes in spawning biomass across the time series is not available.

There were no explicit ABC's for the northern area until 2004. Prior this time (for the period 2000 –2003), yield from the northern assessment was added to catches from the southern, unassessed area to produce a coastwide ABC of 1,115 mt (615 mt from the N. assessment plus 500 mt of catch from the south). In 2004, a management line was implemented at the Columbia River, separating Washington and Oregon. Since the assessment extended to Cape Falcon, the GMT transferred a portion of the yield from the northern assessed area to the south to account for the portion of the stock (yield) from the Columbia River to Cape Falcon, 88% to the north, 12% to the south. This resulted in an ABC for Washington (Columbia River to the Canadian Border) of 540 mt. This has been (will be) constant from 2004 through 2008. With regard to management performance, catches have remained below both the northern portion of the coastwide ABC assumed from the assessment as well as the explicit northern ABC beginning in 2004

Total black rockfish catch by all fisheries

Year	1997	1998	1999	2000	2001	2002	2003	2004	2005	2006
Total Catch (mt)	258.1	337.3	225.9	226	189.8	240.6	237.4	269.3	332.6	324.1

Forecasts

Projections of future catches were based on a $F_{SPR 50\%}$ rate of fishing mortality. We also assumed that the sport fishery would account for 100% of the catch and that selectivity would remain unchanged from that estimated within the model in the final year. For the STAR Base model only, beginning in 2013, there is a slight downward adjustment in ABC of ~ 1% to account for 40:10 harvest Control rule adjustments.

STAR Base Model

Year	2007	2008	2009	2010	2011	2012	2013	2014	2015	2016
ABC (mt)	394	377	361	350	345	344	346	350	354	357
Spawning Biomass (mt)	1064	1071	1060	1036	1005	977	956	944	940	943
% of Virgin	0.438	0.441	0.436	0.426	0.414	0.402	0.394	0.389	0.387	0.388

STAT "Best Fit" Model

Year	2007	2008	2009	2010	2011	2012	2013	2014	2015	2016
ABC (mt)	535	503	474	453	440	433	431	432	434	436
Spawning Biomass (mt)	1281	1267	1233	1182	1126	1074	1033	1005	989	984
% of Virgin	0.552	0.546	0.531	0.509	0.485	0.463	0.445	0.433	0.426	0.424

Decision Table

The decision table matrix was developed through STAR Panel and STAT discussions. Three states of nature were defined in terms of natural mortality: 1) M equals to 0.12 for all males and females ≤ 10 years of age, and M linearly increases from 0.12 to 0.16 for females age 11 to 15 then remains constant at 0.12 after age 15; 2) M equals to 0.16 for males and females ≤ 10 years of age, and M linearly increases from 0.16 to 0.20 for females age 11 to 15 then remains constant at 0.20 after age 15; and 3) M=0.19 for males and females ≤ 10 years of age, and M linearly increases from 0.19 to 0.23 for females age 11 to age 15, then remains constant at 0.23 after age 15. To assess the affect of alternative management actions, harvest was forecast with alternative catch levels derived from each state of nature.

In addition to the above three states of nature, we included model results in the decision matrix that are based on the “best fit” model where M=0.16 for males and females ≤ 10 years of age, and M for females linearly increasing from age 11 to age 15 to 0.24, and then constant. The STAT feels compelled to integrate these results into the decision matrix (post STAR) because the “Low Natural Mortality” model does not appear plausible. Further, we consider the STAR base model as a very conservative representation of the current population. The STAT recommends that the “Best Fit” model be used for management recommendations and the “STAR Base Model” and the “High Natural Mortality Model” be used to bracket the uncertainty. Our evaluation is based on sensitivity analysis, comparison of model results to the tagging study, and general observations we have made in the fishery that include:

- 1) the assumed rate of natural mortality in the “Low Natural Mortality” state of nature is lower than any previous assessment for the “Northern” population, and is lower than any external estimation by direct and indirect methods,
- 2) biomass results from the “Low Natural Mortality” indicate that the population declined to less than 13% of the unfished population in the mid-1990’s yet we have no indication from the fishery or from our tagging study that there was localized depletion during this time period,
- 3) sensitivity analyses indicate “Low Natural Mortality” model fit to the data is very poor relative to other model results that assume a higher rates of natural mortality,
- 4) the estimated q for the survey is likely double what it should be based on STAT knowledge of available habitat off the Washington coast,
- 5) tagging data are not fit well and tagging estimates external to the model indicate that the population is larger and fishing mortality is lower compared to STAR base model run results,
- 6) other model runs with higher steepness and Sigma R fit the data better and improved our view of the current population status above both the STAR base and “Best Fit” model runs and finally,
- 7) compared to the STAT best fit model, a model with high natural mortality for females (where M=0.16 for males and females ≤ 10 years of age and M for females linearly increasing from age 11 to age 15 to 0.26) fit the data equally well. This model resulted in an improved view of current population status above both the STAR base and “Best Fit” model runs. However, results from this model

were not incorporated in the decision table because the higher natural mortality on females (0.26) fell outside the range considered at the STAR Panel.

STAR and STAT decision matrix based on a range of natural mortality rates where rows represent results from the assumed natural mortality model given catch rates that resulted from alternative states of nature (columns).

Decision Table - 2007 Northern Black Rockfish Assessment

State of Nature	Year	ABC	<i>M=0.12 Males M= 0.16 Females</i>		<i>M= 0.16 Males M= 0.20 Females</i>		<i>M= 0.16 Males M= 0.24 Females</i>		<i>M= 0.19 Males M= 0.23 Females</i>	
			Low Natural Mortality SpawnBio Depletion	STAR Base Model SpawnBio Depletion	Best Fit SpawnBio Depletion	High Natural Mortality SpawnBio Depletion				
Low Natural Mortality	2007	108	320	14.1%	320	14.1%	320	14.1%	320	14.1%
	2008	96	287	12.6%	287	12.6%	287	12.6%	287	12.6%
	2009	86	246	10.8%	246	10.8%	246	10.8%	246	10.8%
	2010	100	279	12.3%	194	8.5%	163	7.1%	99	4.4%
	2011	115	316	13.9%	152	6.7%	96	4.2%	26	1.1%
	2012	129	359	15.8%	120	5.3%	48	2.1%	13	0.6%
	2013	140	403	17.7%	96	4.2%	18	0.8%	10	0.4%
	2014	148	447	19.6%	77	3.4%	11	0.5%	9	0.4%
	2015	153	486	21.4%	58	2.6%	9	0.4%	9	0.4%
2016	156	518	22.8%	39	1.7%	8	0.4%	8	0.4%	
STAR Base Model	2007	394	1064	43.8%	1064	43.8%	1064	43.8%	1064	43.8%
	2008	382	1088	44.8%	1088	44.8%	1088	44.8%	1088	44.8%
	2009	370	1092	44.9%	1092	44.9%	1092	44.9%	1092	44.9%
	2010	358	1139	46.9%	1065	43.8%	1030	42.4%	959	39.5%
	2011	351	1175	48.4%	1032	42.5%	965	39.7%	833	34.3%
	2012	349	1204	49.6%	1000	41.2%	906	37.3%	724	29.8%
	2013	350	1232	50.7%	976	40.2%	860	35.4%	637	26.2%
	2014	352	1260	51.8%	959	39.5%	825	34.0%	571	23.5%
	2015	356	1289	53.1%	952	39.2%	803	33.0%	524	21.6%
2016	360	1321	54.4%	952	39.2%	790	32.5%	490	20.2%	
Best Fit	2007	535	1281	55.2%	1281	55.2%	1281	55.2%	1281	55.2%
	2008	521	1317	56.7%	1317	56.7%	1317	56.7%	1317	56.7%
	2009	505	1328	57.2%	1328	57.2%	1328	57.2%	1328	57.2%
	2010	478	1376	59.3%	1304	56.2%	1270	54.7%	1202	51.8%
	2011	459	1406	60.6%	1268	54.6%	1204	51.9%	1076	46.4%
	2012	448	1425	61.4%	1230	53.0%	1140	49.1%	964	41.5%
	2013	443	1440	62.0%	1198	51.6%	1087	46.8%	873	37.6%
	2014	441	1456	62.7%	1174	50.6%	1048	45.2%	805	34.7%
	2015	442	1474	63.5%	1162	50.1%	1023	44.1%	756	32.6%
2016	443	1498	64.6%	1159	49.9%	1010	43.5%	725	31.2%	
High Natural Mortality	2007	827	2075	71.8%	2075	71.8%	2075	71.8%	2075	71.8%
	2008	804	2137	73.9%	2137	73.9%	2137	73.9%	2137	73.9%
	2009	775	2161	74.8%	2161	74.8%	2161	74.8%	2161	74.8%
	2010	714	2206	76.3%	2132	73.8%	2096	72.5%	2025	70.1%
	2011	671	2221	76.8%	2079	71.9%	2012	69.6%	1880	65.1%
	2012	642	2219	76.8%	2019	69.9%	1926	66.7%	1744	60.4%
	2013	624	2210	76.5%	1963	67.9%	1850	64.0%	1629	56.4%
	2014	615	2204	76.3%	1919	66.4%	1790	61.9%	1539	53.3%
	2015	610	2204	76.3%	1889	65.4%	1747	60.5%	1474	51.0%
2016	607	2212	76.5%	1872	64.8%	1721	59.6%	1431	49.5%	

Note:

1. The natural mortality rate of "young" females <= 10 years of age and males are equal. The natural mortality rate for "old" females between the ages of 11 and 15 is linearly increasing and then remains at the constant rate listed above. Assumed catch of 325 mt in 2007 and 2008.

2. ABC for 2007 and 2008 in the current annual management specifications is 540 mt for the area north of the Columbia River. Since the assessment extends south to Cape Falcon, Oregon, the ABC in regulation is a result of apportioning the 615 mt ABC from the previous assessment north and south of the Columbia River.

Research and Data Needs

In order to objectively evaluate a prior on q for the tagging, information on habitat distribution within the stock boundary is necessary. A nearshore assessment should be completed using side-scan, backscatter and multi beam methods. This has already been completed for some portions of the coast and new information can be integrated.

Rebuilding Projections

None required.

Regional Management Concerns

Black rockfish is highly resident to specific reefs and are therefore susceptible to localized depletion especially during times of population decline. Because of this, relatively higher levels of abundance may be needed to meet recreational fishery objectives. For example, the recreational fishery industries need to maintain a sufficient success rate to be economically feasible.

1.0 INTRODUCTION

The status of stocks for the “Northern” black rockfish stock found between Cape Falcon, Oregon and the U.S. Canadian border was last determined in 1999 (Wallace et al, 1999). The population was assessed using an AD model configuration where tag recovery was modeled explicitly. The population was regarded as healthy, stock abundance was estimated to be slightly increasing after passing through a low in the late 1980’s and early 1990’s. The recommended allowable annual yield was 577 mt based on an F45% exploitation strategy and a tag recovery rate of 50%. The estimated stock biomass ranged between 9,500-10,100 mt, depending on assumptions on tag reporting rates. The current analysis reprises estimates based on the 1999 model that uses an improved stock synthesis program (SS2) (Methot, 2006) and presents a completely new model specification. This assessment is distinguished from other more southerly black rockfish population assessment(s) by identifying it as the “northern” stock. However, we have no indication that there is any stock divide at the U.S.-Canadian border just that this assessment includes information only as far north as the U.S.-Canadian border.

Throughout the document we include model results that are based on both the “STAT best fit” model and the STAR base model. STAT best fit model natural mortality for “old” females is assumed to be 0.24 versus 0.20 in the STAR base model and all other parameter settings remain the same. Results in the STAT best fit model are based largely on new and expanded analyses following conclusion of the STAR Panel. We felt compelled to integrate these results because the “Low Natural Mortality” model used to bracket model uncertainty does not appear plausible and the STAT best fit model provided a better fit to the tagging and age composition data.

1.1 Species Distribution, Stock Structure, and Management Units

Black rockfish (*Sebastes melanops*) are widely distributed along the Pacific coast from central California to the Gulf of Alaska inhabiting nearshore areas at bottom depths of less than 50 fathoms (Miller and Lea, 1972). Adults are schooling and associated with irregular, rocky bottom or underwater structures, though at times may be found actively feeding on the surface.

Washington tagging data suggest that Cape Flattery and Cape Falcon may represent area bounds for a coastal Washington-northern Oregon black rockfish stock. From over 54,000 tag releases in this area, no fish were recovered north of the Strait of Juan de Fuca and only 6 were recovered south of Cape Falcon in the 15-year study (Figure 1). To corroborate these results, a genetic stock identification study of coastal black rockfish populations was conducted from 1995-1997 (WDFW report in progress). Horizontal starch-gel electrophoresis was used to examine 10 black rockfish collections from northern California, Oregon, Washington and southern British Columbia. Significant heterogeneity occurred among Oregon collections, while less heterogeneity was found among Washington collections. Dendrogram and multidimensional scaling (MDS) analysis of genetic distances (Nei, 1978) revealed three major geographical groupings (Figure 2). The groups include samples from: 1) north of Cape Falcon, 2) south of Cape

Falcon off the Oregon coast, and 3) a single collection from northern California (Port Albion). The study concluded that there is an apparent large-scale geographical clustering of coastal black rockfish populations and there does not appear to be any geographical pattern to clustering of populations within each group. For this assessment, we assume that black rockfish distributed between Cape Falcon, Oregon and Cape Flattery, Washington represent a unit stock. All biological parameters, data analysis and yield projections presented in this assessment are intended to describe this portion of black rockfish coast-wide distribution.

It is interesting to note that although no black rockfish tags were recovered from southern British Columbia during the 15 year tagging study, fish collected just 20 km north of Cape Flattery in Barkley Sound, B.C. were genetically similar to the coastal Washington collections. The lack of recoveries from across the Strait of Juan de Fuca is likely due to a lack of any target fisheries in coastal B.C. waters or may indicate that the Strait provides an effective physical boundary, which few if any adult black rockfish will cross. Nearshore and oceanic drift likely influence gene flow during the three to four month planktonic stages. Survival during the early life stages is strongly influenced by oceanic processes and recruitment may be dependent upon the health of black rockfish populations both north and south of the Strait of Juan de Fuca.

1.2 Life History Overview

Like many rockfish species, black rockfish are slow growing, long lived and mature late in life. Black rockfish are recruited into the commercial and sport fishery at 4 years of age; age composition of the catch can span three decades. Early recruitment, delayed maturity and schooling behavior make black rockfish susceptible to over-exploitation. Furthermore, WDFW found evidence that, in at least one year, a number (approximately 10%) of mature females examined during parturition did not spawn during year of collection. Ovarian characteristics derived from histological preparations on these specimens indicated that although they had spawned in prior seasons, they had not advanced beyond the early yolk accumulation stage and were re-absorbing their oocytes. Thus, some fraction of the mature population may not spawn annually. If this behavior were common from year to year production would be accordingly reduced.

Another important aspect of black rockfish life history is differences in growth and apparent natural mortality rates between sexes. Composition sampling data show that the sex ratio before age 10 is nearly equal and then the percent female declines sharply thereafter (Figure 3). For the purposes of this assessment we interpret the loss of females due to increased natural mortality at age, which coincides with female transition into sexual maturity.

1.3 Review of Fishery

Recreational and commercial fishers have harvested black rockfish in nearshore areas off the Washington coast since the early 1960's. Commercial fisheries include salmon and bottomfish troll, jig and groundfish trawl. The recreational fishery is divided between

charter and private boat operations. Due to restrictive regulations black rockfish landings have steadily declined for commercial fisheries since the mid 1980's. Recreational landings peaked in the late 1980's and declined slightly in the 1990's and have increased slightly in the most recent years (Table 1 and Figure 4).

1.3.1 Catch

Little information exists on the historical landings of black rockfish prior to the early 1960's. The first black rockfish catch of 151.5 mt was recorded in 1952 for trawl gear. Landings of rockfish peaked at nearly 25,000 mt in 1945 in support of the war effort, however, there is no known species composition estimates for these catches (Table 2). Due to the nearshore habitat of this species it is likely that very little of this catch was black rockfish. Catches prior to known estimates were decayed to zero back to 1940 within the model and these catches are presented in Table 3.

Predominate harvesters of black rockfish between 1963 and 1983 were commercial line and trawl fishers. Black rockfish trawl landings typically came from directed tows on nearshore rocky reefs and shipwrecks with few landings incidental to other targeted fisheries. Catch information has been updated since the 1999 assessment to reflect changes in species composition estimates derived from port sampling. These changes resulted in a slightly lower catch during the early part of the time series (Figure 5). Peak landings in the trawl fishery reached 350 mt in 1976 and declined to less than 10 mt in recent years due to area and catch restrictions (Figures 6-8).

The "non-trawl" fishery is composed of three distinct line fisheries and each differs in target species. Oregon and Washington fish receiving tickets show nominal rockfish catch as early as 1970 in the salmon troll fishery, during 1973 in the jig fishery and during 1979 in the bottomfish troll fishery. Black rockfish are generally caught as bycatch in the commercial salmon troll fishery; landings peaked in the late 70's (151 mt) and steadily decreased coincident with losses in fishing opportunities for coastal salmon. The bottomfish troll fishery generally targeted lingcod; rockfish landings are small and estimated black rockfish catch never exceeded 2 mt. The jig fishery is primarily composed of small vessels less than 26 feet in length that generally fish near their port of access. Black rockfish were targeted in nearshore areas and are a significant fraction of the nominal rockfish landings in the jig fishery. Black rockfish catch in the jig fishery was inconsequential prior to 1980 and peaked in 1982 at 272 mt. Since 1996 nominal rockfish landings contain no black rockfish due to area restrictions that have forced jig fishers to target other rockfish species found farther offshore.

Black rockfish have become the primary target of the coastal groundfish sport fishery since the mid 1980's (Table 1 and Figure 4). Small black rockfish catches were reported in the late 1970's and steadily increased to over 300 ton per year in the mid 1990's. Due to the implementation of a 10 fish bag limit in 1995 (Figure 7) and longer salmon seasons, annual catch of black rock declined to 188 mt in 2001. In recent years, sport catches increased to more than 300 mt. The coastal recreational rockfish fishery generally competed with sport salmon, halibut and tuna fisheries, and this is reflected in year-to-year variability in black rockfish catch.

1.3.2 Discard

Discard of black rockfish in Washington waters in either the commercial or recreational fisheries is likely very small. “*Sebastes complex*” trip limits in the line fishery were non-restrictive prior to 1999 since few landings ever achieved the trip limit, and there was no incentive to discard catch. Furthermore, Washington State waters (inside 3 miles) have been closed to directed commercial fishing since 1995. Black rockfish represented only a small fraction of the nominal rockfish catch in the trawl fishery and it is unlikely they were discarded. Discard in the sport fishery is also insignificant since the vast majority of recreational fishers do not high-grade their rockfish catch. This is supported by recent sport fishery information that indicates discard is less than 16 mt on an annual basis (Table 4).

1.3.3 Effort

Coastal Washington recreational effort has steadily increased since the early 1980’s with some declines in the late 1990’s (Table 5). Increase in the popularity of bottomfish fishing has been coincident with loss of salmon fishing opportunities and a genuine increase in public interest in recreational groundfish fishing. Though a multiple target strategy may be used by sport fishermen, the bottomfish-only trips consisted about 15%-20% of the total activities in the Washington recreational fisheries.

1.4 Fishery Management

1.4.1 ABC/HG and Management Performance

The black rockfish resource was first assessed in 1994 (Wallace and Tagart, 1994). Estimated biomass declined to 60% and female egg production decreased to 43% of the unfished level. The 1995 forecasted yield ($F_{45\%}$) and harvest guideline (HG) for combined fisheries was 517 mt. Black rockfish harvest has remained below the HG at 298, 244, 242 and 309 mt for 1995, 1996 1997 and 1998, respectively. Harvest has also remained well below the harvest guideline of 577 mt that was established by the Council following the 1999 assessment (Wallace et al., 1999).

1.4.2 Review of Regulatory Changes

In recognition of the recreational fishery dependence on black rockfish and to address concerns over localized declines in availability, state and federal regulations have significantly restricted commercial and recreational harvest over the last decade (Figures 5-7). In 1992, the recreational bag limit was reduced from 15 to 12 rockfish off most of Washington, and commercial line fisheries were limited to 100 lbs of black rockfish or 30% of total catch on board except when fishing in the area between Destruction Island and Cape Alava or south of Leadbetter Point. The area restrictions were intended to reduce commercial harvest of black rockfish in areas heavily utilized by recreational fishers. WDFW imposed further restrictions in 1995 that prohibit commercial line harvest (except for bycatch in the salmon troll fishery) inside state waters, imposed trawl gear restrictions and reduced the recreational bag limit to 10 fish. These regulations are still in effect today.

1.5 Sampling Regime

Oregon and Washington routinely collect commercial and sport groundfish biological samples at various ports of landing (Tables 6 and 7). ODFW sampling is stratified by port complex, gear, market category, and quarter and generally follow methodology describe by Sen (1984). Oregon samples of interest for this assessment include only those samples collected from the sport fishery fishing north of Cape Falcon and landing into Garibaldi. WDFW black rockfish age composition sampling is stratified by time (year) and area (3B and 3A). Washington samples are collected from the trawl fishery throughout the year, and between March and October for the sport and commercial line fisheries concurring with the spring to fall fishing season.

Both Oregon and Washington regularly collect species composition samples for mixed rockfish market categories in the trawl fishery. Samples are used to derive catch estimates for various species including black rockfish and are available from PacFIN. WDFW periodically collected species composition samples from nominal rockfish landings in the commercial line fishery and these were used to estimate black rockfish catch in mixed rockfish categories.

2.0 Data

2.1 Catch

Black rockfish catch data are compiled from a variety of sources including PacFIN, agency reports, fish ticket information and communication with agency personnel. Rockfish landings from the domestic trawl fishery are routinely sampled for species composition by coastal port samplers. Revised estimates of catch for Washington and Oregon were obtained from PacFIN, fish tickets, and species composition sampling in coastal ports in Oregon and Washington (Tables 1-2). Revised catch estimates were slightly smaller in most years prior to 1983 (Figure 8).

Estimates of Washington coastal sport catch and effort is produced from creel and exit count data collected by WDFW's Ocean Sampling Program (OSP). WDFW instituted the OSP in the 70's to estimate catch. The program was later refined to provide necessary information to meet the goals of the Magnuson Fishery Conservation and Management Act of 1976. Estimation procedures for sport groundfish landings are not well documented in earlier years, but species-specific catches were reported in a series of WDFW technical publications since the 1970's. Lai, et al. (1991) describes estimation methodologies beginning in the late 1980's. Variance estimates for catch are available since 1990. Black rockfish discard data in sport fisheries are available since 2002 (Table 3). Proportion-at-size and proportion-at-age by sex and fisheries were derived from biological samples collected from coastal Washington and Oregon landings north of Cape Falcon (Figures 9 and 10).

2.2 Biology

2.2.1 Sampling

Biological sampling of fisheries for black rockfish age and length compositions goes back as far as 1976 in the trawl fishery. Coverage of the commercial fisheries in the last 10 years is nil due to restrictive management. The sport fishery has been relatively well sampled over the last two decades (Tables 6 and 7).

2.2.2 Length weight relationship

Random samples were collected in 1984 (1,157 fish) and from 1988-2001 (1,397 fish), with fork length (cm) and weight (kg) measurements. We modeled the length weight relationship as $W = aL^b + \varepsilon$, where W and L were the weight and fork length, $\varepsilon \sim N(0, \sigma^2)$ and the parameters a and b were to be determined. For male black rockfish, \hat{a} and \hat{b} were $3.796 \times 10^{-5} \text{ kg cm}^{-2.782}$ ($3.303 \times 10^{-6} \text{ kg cm}^{-2.782}$) and 2.782 (SE=0.02309), respectively (Figure 11). For female black rockfish, \hat{a} and \hat{b} were $4.030 \times 10^{-5} \text{ kg cm}^{-2.768}$ (3.334×10^{-6}) and 2.768 (SE=0.02188), respectively (Figure 9). There was no statistical difference ($P > 0.05$) between the male and female length weight relationships.

2.2.2 Growth

Random samples of black rockfish (14,919 male, 12,304 female, and 213 of unknown sex) were collected in 1984 and from 1988-2006 with age and fork length measurements. Most of the fish with unknown sex were juveniles with the smallest age equal to one. The Schnute (1981) three-parameter von Bertalanffy growth model was used to model growth, with the assumption of no variation in growth among years. The growth equation is

$$l_t = L_\infty + (L_1 - L_\infty)(1 - e^{-K(t-1)}) + \varepsilon,$$

where l_t is the fork length at age t , L_1 , L_∞ and K are unknown to be determined,

$\varepsilon \sim N(0, \sigma^2)$. L_1 is the length at age one; L_∞ and K are von Bertalanffy growth parameters, limited size and growth constant.

Due to the restriction of L_1 , which was assumed to be the same in male and female fish, we proposed the use of a dummy variable in the Schnute three parameters growth model. The use of dummy variable was to test the growth difference between male and female fish. The proposed model was

$$l_t = L_\infty + D_L z + (L_1 - L_\infty - D_L z)(1 - e^{-(K+D_k z)(t-1)}) + \varepsilon,$$

where z was a dummy variable (male = 0, female = 1), D_L and D_k were two additional unknown variables to be determined. In this model, males and females have the same growth curves before age 1.

The parameters \hat{L}_∞ , \hat{K} , \hat{L}_1 , \hat{D}_L and \hat{D}_k were 46.370 cm (SE=0.215 cm), 0.194/yr (SE=0.00628/yr), 20.123 cm (SE=0.583 cm), 3.903 cm (SE=0.347 cm) and -0.0299/yr (SE=0.00472/yr), respectively. In Figure 12, there are plots of the expected age fork

length relationships of male and female black rockfish. Both \hat{D}_L and \hat{D}_K were highly significant ($P < 0.001$); this implied the expected \hat{L}_∞ and \hat{K} were different between the sexes. The expected limited size of male rockfish and the growth constant were 46.370 cm and 0.194/yr. The expected limited size of female rockfish and the growth constant were 50.273 cm and 0.164/year. The estimated expected limited sizes of male and female black rockfish were similar to the expected limited sizes of male (46.611 cm) and female (51.225 cm) estimated by the capture-recapture data with time at large and size measurements but not the growth constants. The difference in the growth constants estimation might be due to the assumption of age at zero and the aging of fish with an integer scale.

2.2.3 Aging error

Since 1992, 3,147 black rockfish were sequentially selected and aged with two age readers independently. We modeled the aging error with a simple regression with no intercept. The estimated slope was 0.9977 (s.e.=0.001858). The CV of the aging error was small (0.18%). Figure 13, shows a scatter plot of the age data from the two readers. Figure 14 shows the between reader age specific variation that was used for data input in the SS2 stock assessment.

2.2.4 Age weight conversion errors

There were aging errors, age to length conversion errors, and length weight conversion errors in age to weight conversion:

$$W = a[(L_\infty + D_L z + (L_1 - L_\infty - D_L z)(1 - e^{-(K+D_k z)(t+1)})]^b.$$

We assumed all these errors were independently normally distributed. The Delta method was employed to estimate the overall standard errors. The estimated male and female black rockfish age to weight and standard errors are presented in Table 8.

2.2.5 Age-length relationship and maturity

A random sample of 352 female black rockfish captured in 1998 was selected for the estimation of black rockfish maturity (Table 9). A generalized linear model with a binomial (logit link) was used to model the age of 50% maturity. Bootstrapping was used to estimate the 95% confidence intervals of the age of 50% maturity. The estimated age of 50% maturity was 10.31 year and the 95% confidence intervals by bootstrapping was (9.72 year, 11.24 year). The estimated probability of maturity with age was

$$\hat{\pi} = \frac{e^{-7.13+0.69t}}{1 + e^{-7.13+0.69t}}.$$

The estimated probability of sex maturity curve with age for females is plotted in Figure. 15. Females with fork length (l) 25-49 cm captured in 1998 (391 fish) were randomly selected for the estimation of maturity of rockfish (Table 10). The estimated length of 50% was 42.15 cm and the 95% confidence intervals by bootstrapping was (41.49 cm, 42.87 cm). The estimated probability of maturity with fork length was

$$\hat{\pi} = \frac{e^{-17.05+0.40l}}{1 + e^{-17.05+0.40l}}.$$

The estimated probability of sex maturity curve with fork length is plotted in Figure. 16.

Fecundity estimates are based on 47 mature black rockfish ovaries collected during parturition between 1989 and 1991 off the central Washington coast. Estimated fecundity ranged from 117,550 eggs for a 37 mm fish to 1.2 million eggs for a 490 mm fish. Fecundity at a mean size of 41 cm is 544,528. There is a significant relationship between fecundity and length ($M, E+6\text{larvae/cm} = 0.0634L-2.0586$ and fecundity and weight ($M, E+6\text{larvae/kg} = 0.7674W-0.3657$) (Figure 17). Fecundity at weight parameters are provided as data input to synthesis and since larval output are in $1.0E+6$ units, spawning biomass from the model should be multiplied by 106 to obtain the absolute spawning output. An increasing larval output by older, larger fish has a significant impact on the population dynamics such that a lightly exploited population with and age structure shifted towards older fish, would have greater spawning potential than a population shifted towards younger fish even if the biomass of spawning females were the same. This effect is significantly amplified in the black rockfish populations because it appears that larvae from larger, older black rockfish appear to be more viable than those from younger fish (Berkeley, 2004). This further implies that maintaining a black rockfish population that preserves the older segment of the population may be very important for reproductive success of this species.

2.2.6 Total mortality

The mortality model we used assumes direct density dependence. If the population at time t is $N(t)$, then

$$\frac{dN(t)}{dt} = -ZN(t),$$

where M is the termed the instantaneous coefficient of total mortality. This model is popular for fish stock assessment because it is simple, because data are usually not available to support more complex representations, and because it often makes reasonable assumptions for the exploited age classes. The population size at time t is

$$N(t) = N(0)e^{-Zt}.$$

We assume that fishing mortality (F) and natural mortality (M) sum to total mortality (Z), where $Z = F + M$.

Taking the log of both sides of the equation, we get

$$\log(N(t)) = \log(N(0)) - Zt.$$

For the rockfish length frequency composition data, we need to convert the fork length into age. The inverse von Bertalanffy growth equation is

$t(L) = t_0 - \frac{\log(1 - \frac{L}{L_\infty})}{K}$. We set $t_0 = 0$ for simplicity. Now,

$$\log\left(\frac{N(t)}{t(L + \Delta L) - t(L - \Delta L)}\right) = \log\left(\frac{N(0)}{2(t(L + \Delta L) - t(L))}\right) - Zt(L).$$

The length interval for the frequency data is 3 cm. Assuming errors in the data, we can fit a regression line with

$$y = \log\left(\frac{N(t)}{t(L + \Delta L) - t(L - \Delta L)}\right) \text{ and } x = t(L) \text{ with } \Delta L = 1.5 \text{ cm.}$$

The above method is equivalent to the method of Pauly (1983).. who derived it by using the Baranov catch equation,

$$C(t_1, t_2) = N(t_1) \frac{F}{Z} \{1 - \exp[-Z(t_2 - t_1)]\},$$

where $C(t_1, t_2)$ is the total between age class t_1 and t_2 . He approximated part of the catch equation

$$\log C(t_1, t_2) = d - Zt_1 + \log\{1 - \exp[-Z(t_2 - t_1)]\}$$

with $\log(1 - \exp(-\Delta t)) \approx \log(\Delta t) - \frac{\Delta t}{2}$. Both results are similar.

Black rockfish length frequency data have been collected from port sampling and recreational surveys since 1984. Both male and female black rockfish length frequency data show peaks near 36 cm, presumably due to fishery selectivity. Thus, for the purposes of this analysis, black rockfish with size greater than 36 cm were used to estimate the total mortality. We estimated the total mortalities of black rockfish by sex. The estimated male and female total mortality coefficients from 1984 to 2006 and number of samples are listed in Table 11. Plot of expected male and female estimated total mortality coefficients against total fishing effort are shown in Figure 18. The estimated intercept (~0.2 for males and ~0.26 for females) in each sub graph is the estimated natural mortality (where effort=0) using the mortality model described above and assuming direct density dependence. The estimated female total mortality coefficients were greater than the estimated male total mortality coefficients from 1984 to 2006 and beginning in 2000 there was a decreasing trend observed in both male and female black rockfish total mortality (Figure 19).

2.2.7 Natural mortality

Fish natural mortality is confounded with fishing mortality, so it is one of the most challenging fish biological parameters to be estimated. It significantly affects the stock rebuild time and the estimation of virgin fishery biomass. There are both direct and

indirect methods to estimate the natural mortality of fish species. Indirect methods are derived from other biological parameters, e.g., the growth constant and fecundity (Wallace et al., 1994 and Wallace et al., 1999). It is difficult to estimate the uncertainties from indirect methods.

In this assessment, we attempted to estimate the natural mortality of black rockfish with a direct method. We assumed $F = qE$, where q was catchability coefficient and E was fishing effort. Natural mortality could be estimated with the relationship

$$Z = F + M .$$

After 1995, the bag limit for recreational catch dropped to 10; thus, we only included the recreational rockfish trip effort (fish/angler) and the total catch in this analysis. We assumed constant M with annual variation and the total fishing effort at year t would result in the total mortality in year $t + 1$. The proposed model was

$$Z_{t+1} = qE_t + M + \varepsilon_t ,$$

where $\varepsilon_t \sim \text{NID}(0, \sigma^2)$, q and M were the unknown to be determined.

Plot of expected male and female estimated total mortality coefficients against total fishing effort where the intercept was the estimated natural mortality is shown in Figure 18. The estimated linear relationship between male and female black rockfish is shown in Figure 19 and a time series plot of the estimated male and female black rockfish total mortalities is shown in Figure 20. The estimated \hat{M} of male and female black rockfish were 0.223 (SE= 0.0071) and 0.272 (SE= 0.061). The relationship of $\hat{M} \approx \hat{K}$ was observed in male black rockfish, while $M = 1.6\hat{K}$ was observed in female black rockfish. All these values agreed with other existing indirect methods.

2.3 Abundance Indices

2.3.1 Bottom trawl surveys

The NMFS has conducted the West Coast triennial bottom trawl survey of groundfish resources since 1977. Survey depth range in most years has been from 30-200 fm (Wilkins et al., 1995). This is outside the normal depth range of black rockfish and only 233 fish in 27 tows have been captured to date. Therefore, we incorporated no triennial trawl survey data into this assessment.

2.3.2 Recreational CPUE

Abundance indices are assumed to be proportional to population abundance. The catchability coefficient (Q) is the factor that relates the units of the index to the abundance of the population. Random variability in the coefficient may occur, but if there is a trend over time or if the coefficient varies with population abundance, then the assessment may be biased. Sport fishery catch rates will be influenced by undocumented search time at sea, and the observed decline in CPUE indices would be underestimated. There is no information to evaluate annual differences in effort for specific individual target species such as black rockfish. April-September estimates of catch and effort (by trip type) for the sport fishery from coastal Washington ports are available from the WDFW Ocean Sampling Program since 1990. Black rockfish abundance trends were

explored using methods described below, but not used in the current assessment due to 1) changes in bag limits, 2) a switch to bait in the early –mid 1990’s, and 3) a bag limit that may have capped the trend since the mid-late 1990’s that may have biased the population trend.

Delta lognormal model

A delta lognormal model (Lo et al. 1992) has been commonly used for modeling the abundance of marine species from trawling data. It uses generalized linear models GLMs in both stages, where P_{ij} is the probability of abundance of observation j in year i and C_{ij} is the catch per unit effort (CPUE). CPUE can be catch per angler hr, catch per trip, or catch per angler. The distribution of $C_{ij} > 0$ usually follows a lognormal distribution. The distribution of P_i follows a binomial distribution. The modeling of P_{ij} and C_{ij} through a two stage process with other predictor variables is commonly called delta lognormal model (Lo et al., 1992). This approach affords the opportunity to investigate the probability of abundance on a spatial scale with other predictor variables, which include both geographical information and environmental variables. Problems associated with zero values in catch data can be avoided by using the delta lognormal model, which only fits the positive catch data. There is, however, a possible bias induced by using a two stage model process. Lo et. al. (1992) and Syrjala (2000) attempted to estimate the bias of the estimated variance in this model using both simulation and approximation techniques. Both P_{ij} and C_{ij} do not assume normally distributed (binomial, lognormal) in the two stages model process and there is possible correlation between them. Also, the use of the delta lognormal method to estimate the variance of the final estimate is questionable. This can be overcome by non-parametric bootstrapping.

First stage model

The response variable P_{ij} is a Bernoulli component (presence-absence) of CPUE j in year i . The choice of the logit link function is standard (McCullagh and Nelder, 1989; Cheng and Gallinat, 2004). The link function is

$$g(P_{ij}) = \log\left(\frac{P_{ij}}{1 - P_{ij}}\right) = x_i,$$

where x_i is a factor variable (annual effect).

Second stage model

We model $C_{ij} > 0$ in terms of the covariates x_{ij} . It is a truncated Poisson distribution.

Bootstrapping method and non-parametric coefficient of variation

The nonparametric bootstrap method (Efron 1982; Hall 1992; Jackson and Cheng 2001) was used to estimate the 95% confidence intervals for the mean CPUE estimates obtained from average CPUE and from the delta lognormal model. Due to the computational intensity required when applying GLMs and a large data set, $K = 200$ to 1000 samples

have been used. We have rerun the bootstrapping three times and compared the precision of the estimates of the 2.5%, 15.87%, 84.13%, and 97.5% quantiles. The estimates of the quantiles are correct to the first 3 significant places due to the very large dataset. The coefficient of variation of a data X ,

$$CV_X = \frac{\sigma_X}{\mu_X} \approx \frac{\hat{\sigma}_X}{\bar{X}},$$

is commonly used to describe the variation (one standard deviation) of the data compared with the mean of the data. The parameters σ_X and $\hat{\sigma}_X$ are population X standard deviation and estimate population X standard deviation. Letting $q_{X,0.025}$ be the 2.5% quantile of data X , we define the ad hoc CV for the non-normal distribution as

$$CV_X = \frac{q_{X,0.8413} - q_{X,0.1587}}{2\mu_X} \approx \frac{\hat{q}_{X,0.8413} - \hat{q}_{X,0.1587}}{2\bar{X}}.$$

For the sample mean, we use

$$CV_{\bar{X}} = \frac{q_{X,0.8413} - q_{X,0.1587}}{2\sqrt{n}\mu_X} \approx \frac{\hat{q}_{X,0.8413} - \hat{q}_{X,0.1587}}{2\sqrt{n}\bar{X}},$$

where n is the sample mean.

The sample mean of the CPUE in each year was compared with delta lognormal model results. Black rockfish length frequency data have been collected since 1990 in both recreational and commercial fisheries. Plots of the estimated recreational fishery CPUEs from mean estimators and the delta lognormal model for all areas combined is shown in Figure 21 and Figure 22 shows results from Area 2 only. A summary of the number of recreational data recorded in all areas (Areas 1, 2, 3, 74 and 84) and the proportion of these from 1990 to 2006 is given in Table 12. Area 2 was the major fishing area and the fishing effort was roughly proportional to the catch. Area 2 was the major rockfish area. Tables 13 and 14 provide summaries of the estimated CPUEs from the mean estimator and the delta lognormal model for all areas combined and area 2, respectively. Undoubtedly, Area 2 had a higher CPUEs compared with the other areas. Although the bag limit changed from 15, to 12 to 10 during 1990 to 1995, the estimated CPUEs reflected the changes from 1990 to 1993. From 1995 onwards, there was an increasing trend in CPUEs with a constant bag limit (Figures 19-20).

2.3.3 Tagging CPUE

Since the start of the coastal Washington black rockfish tagging program in 1981 information on catch and rod hours have been recorded. These data represent the total number of fish caught and angler hours at each specific fishing location during a trip. The number of fish tagged (and released) was typically less because of mortality from hooking or barotraumas. The tag CPUE in the current assessment represents the mean annual CPUE across all trips (by year) for the Central Washington Coast between Grays Harbor and Sea Lion Rock since 1985 (Table 15 and Figure 24).

2.3.4 Mark-recapture tagging study

From 1981 to 1990 and resuming again in 1998, black rockfish has been the subject of multiple tagging experiments along the coast of Northern Oregon and Washington. Since

1998, internally implanted coded wire tags (CWT) were employed to ensure that tag recovery was not dependent upon tag reporting by fishers. Information from the first two years of recovery was suspect and was dropped from the tag abundance index.

2.3.5 CWT tag loss rate

Double CWT tagging experiments were conducted between 1998 and 2006 to estimate the tag loss rates. The estimated tag loss rates were used to adjust the number of tag returns. In 1998, 2262 black rockfish were released with double CWT tags on both the left and right sides of the fish in order to estimate the instant CWT tag loss rate per year. In total, there were 2209 fish returned with double CWT tags, 58 fish returned with left CWT tag loss and 66 fish returned with right CWT tag loss (Table 16 and Figure 23). The estimate the instant rate of tag loss per year was -0.0017 (st. err= 0.0003 , $P=0.0035$).

2.3.6 Population estimate

Petersen's method (Chapman, 1951) was used to estimate the population size from capture and recapture data. The method requires only two survey periods; the first survey involves the initial marking of n_1 fish, of which m tagged fish are recovered from n_2 fish sampled in the second survey. The estimated population size is

$$\hat{N} = \frac{(n_1+1)(n_2+1)}{m+1} - 1$$

and

$$\text{Var}(\hat{N}) = \frac{(n_1+1)(n_2+1)(n_1-m)(n_2-m)}{(m+1)^2(m+2)}.$$

The assumptions are

- i) The tags are not lost and always identified on recapture.
- ii) The population is closed.
- iii) Every individual has the same probability of recapture.

When the tag loss rate is known, the new estimate is $\hat{m} = \frac{m}{1 + \hat{\beta}}$.

The estimated population sizes for years 2000 to 2006 are given in Table 17.

3.0 Modeling History

In the 1994 stock synthesis model configuration, two auxiliary data sets were used as black rockfish abundance indicators: tagging CPUE, and coastal recreational bottomfish directed effort (Wallace and Tagart, 1994).

In 1999 we constructed an assessment model by using the AD model builder software (Fournier 1997) to assess black rockfish abundance (Wallace et al 1999). The three key features of the 1999 model were (1) the parameterization of the expected catches at age, (2) the definitions of the sampling unit for the different types of data input, and (3) the integration of tagging data explicitly. The parameterization chosen mostly affected parameter bias whereas the sampling unit designation mostly affected estimator variance.

Both bias and variance were components of overall parameter uncertainty. The parameterization and the sampling unit definitions were both designed to conform to the actual sampling protocol used, thereby propagating sampling uncertainty through to the final biomass estimates.

4.0 Current Model Description

The current assessment employed Stock synthesis 2 (SS2V2.00c, compiled 3/27/2006) to model the dynamics of black rockfish population found between Cape Falcon, Oregon and North to the U.S./Canadian border in Coastal Waters. This model is a forward projecting, separable, age-structured model developed by Methot (2006). The convergence criterion for maximum gradient was set to $1.0e-5$. The model was specified to begin in 1915 to ensure population equilibrium at the start of the modeling time period. Catch data were decayed from the last reliable catch estimates (1965) to 0 by 1940. Fisheries catch, size and age compositions were pooled into three fishery types including trawl, sport and non-trawl. The first size-age compositions were collected in the mid 1970's from the trawl fishery, but samples were not collected on a systematic basis until 1985. Growth (L_{min} , L_{max} and k) was estimated within the model to account for fishery selection of the larger individual fish at age. The population model was tuned to two fisheries-independent indices that include a tagging CPUE (1986-2007) and a tag abundance biomass index (2000-2007) both derived from WDFW black rockfish tagging information. Both STAT and STAR Panel members agreed that the available fishery dependent indices should not be incorporated due to potential bias resulting from bag limit changes and undocumented measures of fishing effort resulting from changes in search time across the time series. The black rockfish STAR base and STAT best fit models down-weights size composition for all fisheries (emphasis=0.1) to improve model fit to the age composition and indices rather than length. Given that length compositions are from all samples including aged samples, down weighting mitigates effects that may be contributed to the model by "double-counting" composition sampling.

There are 10 likelihood components for data including: 1) tag abundance, 2) tag CPUE, 3) trawl size compositions, 4) sport size compositions, 5) non-trawl size compositions, 6) tag survey size compositions, 7) trawl age compositions, 8) sport age compositions, 9) non-trawl age compositions and 10) mean size at age (Table 18).

There are a total of 76 parameters estimated within the base model and assumptions on priors are listed in Table 19. We modeled the black rockfish spawner-recruit relationship using the Beverton-Holt curve. The key steepness parameter (h), which determines overall productivity of a stock, is fixed at 0.6 and the prior on h is set to 0.35 in the STAR base model and in the STAT best fit model. Based on Dorn's (personal communication) Bayesian meta-analysis of productivity for west coast rockfish stocks, steepness parameter (h) for black rockfish should be in the 0.6-0.7 range and variation about the stock-recruit curve (ΣR) would be near 0.57. The natural mortality for females is assumed to be constant (0.16) for ages ≤ 10 and then increasing to 0.2 by age 15, and males were assumed to have a constant natural mortality of 0.16 for all ages in the STAR base model. The natural mortality for females is assumed to be constant (0.16) for ages

≤ 10 and then increasing to 0.24 by age 15, and males were assumed to have a constant natural mortality of 0.16 for all ages in the STAT best fit model.

Sample size and effective sample size

Initial sample size inputs were based upon methods presented at the NMFS 2006 Stock Assessment Data and Modeling workshop that incorporates objective weighting for length- and age-frequency data for West coast groundfish fisheries where:

Fishery data:

$$\text{Effective N} = ((0.138 * \text{FPS}) + 1) * \text{NS} \quad \text{where: FPS} < 44$$

$$\text{Effective N} = 7.06 * \text{NS} \quad \text{where: FPS} > 44$$

Survey data:

$$\text{Effective N} = ((0.070 * \text{FPS}) + 1) * \text{NS} \quad \text{where: FPS} < 55$$

$$\text{Effective N} = 4.89 * \text{NS} \quad \text{where: FPS} > 55$$

NS = Number of samples

FPS = Average number of fish per sample

Comparison of input sample size and the effective sample sizes estimated by the STAR base model are provided in Tables 20 and 21.

5.0 Model Selection and Evaluation

A large number of model structures were initially explored prior to establishing a base black rockfish model. Our primary goal in model selection was to ensure fit to the tag abundance index and age composition data while minimizing the overall likelihood. This is because we have confidence in the study design and methodology of our current tagging program and the resulting abundance estimates. In addition, we have collected numerous age samples from the fisheries during the last two decades that likely represents the underlying age structure of the population.

Natural mortality for mature females (> 10 years of age) was assumed to be 0.20 (STAR base) and 0.24 (STAT best fit) and constant 0.16 for males and females < 11 . These rates are within the range of natural mortality rates estimated external to synthesis. Both male and female natural mortality rates are lower than that estimated in the 1999 assessment (Figure 25) and somewhat lower than the 1982 catch curve estimate of 0.265 (Wallace et al., 1994). The natural mortality in the current assessment is higher than that used in the 2003 assessment for black rockfish populations off Oregon and California (Ralston and E.J. Dick, 2003), which used a natural mortality of 0.1 and 0.2 for males and females, respectively.

Results of the model sensitivity analysis on natural mortality (Table 24) indicate that the STAT best fit model provided a better overall fit to the data compared to the STAR base model and estimates of fishing mortality is closer to tagging study results (Figure 26). We conclude that the STAR base model should be used to base management decisions and set allowable harvest. A list of supporting information include: 1) the assumed rate of natural mortality in the “Low Natural Mortality” state of nature is lower than any previous assessment for the “Northern” population, is lower than any external estimation

by direct and indirect methods, 2) biomass results from the “Low Natural Mortality” indicate that the population declined to less than 13% of the unfished population in the mid-1990’s yet we have no indication from the fishery or from our tagging study that there was localized depletion during this time period, 3) sensitivity analyses indicate “Low Natural Mortality” model fit to the data is very poor relative to other model results that assume a higher rates of natural mortality, 4) the estimated q for the survey is likely double what it should be based on STAT knowledge of available habitat off the Washington coast, 5) tagging data are not fit well and tagging estimates external to the model indicate that the population is larger and fishing mortality is lower compared to STAR base model run results, 6) other model runs with higher steepness and Sigma R fit the data better and improved our view of the current population status above both the STAR base and “Best Fit” model runs and finally, 7) compared to the STAT best fit model a model with high natural mortality for females (where $M=0.16$ for males and females ≤ 10 years of age and M for females linearly increasing from age 11 to age 15 to 0.26) fit the data equally well. This model resulted in an improved view of current population status above both the STAR base and STAT best-fit model runs. However, results from this model were not incorporated in the decision table because the higher natural mortality on females (0.26) fell outside the range considered at the STAR Panel.

Convergence properties using a parameter jitter of 0.001 was also explored in the base model and results indicate no other local minima (Figure 27). Growth was assumed linear to age 5 where variation in fork-length at age was stabilized across ages (Figure 28). Growth was fully (L_{min} , L_{max} and k) estimated within the model to account for fishery selection that favors the largest individuals at age. Model estimates of growth compared reasonably to external estimates and there were no apparent differences in estimates of growth between STAR and STAT models (Figure 29).

Both the STAR and STAT models underestimated the increasing trend in tag abundance and tag CPUE indices in most recent years (Figure 30). We believe this is due to several factors including that tagging is not incorporated in the model as a tagging experiment, which is not possible within the current SS2 modeling framework. Further, the model estimated effective q for the tagging index was 0.83 and this is likely double what it should be based on STAT knowledge of available habitat off the Washington coast. The north central Washington coast, where most of the nearshore rocky habitat exists, is inaccessible to most recreational fishers and is not part of the current tagging program. However, the estimation of q is complicated by the fact that the SS2 value of q is a function of selectivity that is strongly dome shaped for the fishery. Increasing the weighting on survey abundance demonstrates that a better fit to the survey abundance index significantly improves our view of the current population status (Figure 31). Additionally, a retrospective analysis of the STAR base and STAT best-fit models shows that the indices strongly influence population trends and that the population trajectory in most recent years was highly influenced by the large (estimated) 1999 year-class (Figure 32).

Without an objective evaluation of an informed prior on q it is difficult to compare a prior conception of q based on tagging and the one estimated by SS2. Other issues include the

non-independence of the length/age compositions and non-independence of the tagging abundance and CPUE series. However, both STAR and STAT conclude the current model configuration(s) represented the “best available” scientific information and should be used for management.

There appears to be some pattern in the size composition residuals such that model estimates for small fish were much higher than that observed in the trawl fishery fit. However, forcing the model to fit the size compositions degraded the fit to the age composition. Fit to size compositions in the sport, non-trawl and survey showed little trend. Overall, fit (or lack of) to the size composition data did not draw significant debate at the STAR panel and model fit to size compositions is likely within the uncertainty (Figures 33-36). Model fit to the age composition data showed relatively inconsistent patterns and was considered to be within model uncertainty (Figures 37-39). There was an obvious trade off where forcing the model to fit the age data degraded the fit to the size composition data. This was not fully resolved and is discussed below in the uncertainty section.

6.0 Base-run Results

Comparison of STAR base model recruitment estimates to the previous assessments and the STAT best fit model indicates similar estimated recruitment patterns (Figure 40). It is apparent that the large estimated recruitment in 1994 and 1999 is highly influential in determining current stock status. Due to lack of good recruitments and intense fishing by multiple fisheries, highest fishing mortality rates occurred in the late 1980's (Figure 41). Selectivity was domed-shaped (STAR and STAT models) in both the tagging survey and sport fishery and asymptotic in the trawl and non-trawl commercial fisheries (Figure 42). Comparison of STAR base model spawning biomass estimates to the previous assessments indicate a similar declining trend through the mid 1990's and then sharply increasing to 43% of the unfished biomass by 2006, though the trend is lower in the current model (Figure 43). The STAT best fit model resulted in a slightly smaller unfished biomass and a larger ending biomass compared to the STAR base model, biomass estimates show little difference in population trend (Figure 44).

Black rockfish stock abundance was below the Councils' management target a number of years and also dipped below the Councils' minimum stock size threshold in the STAR base model. The STAT best fit model population trajectory remained just above minimum stock size threshold. Both models indicate that the stock is currently well above the management target of B40% (Figure 45). The corresponding exploitation rate relative to spawning biomass shows similar trend and harvest rates have exceeded management targets between the mid 1980's through the mid 1990's (Figure 46).

7.0 Uncertainty and Sensitivity

Natural mortality is confounded with fishing mortality making it one of the most difficult biological parameters to estimate. In this assessment we explored direct methods to

estimate natural mortality and compared to estimates derived from indirect methods (from other biological parameters, e.g., the growth constant and fecundity) in previous assessments. It is apparent from our analysis using both direct and indirect methods that our current assumptions on natural mortality in the STAR base model are within our limits to estimate this parameter and that the “low natural mortality rate” model used to bracket uncertainty is likely too low. Model sensitivity analysis show that other model configurations using higher natural mortality assumptions such as the STAT best fit model provides a better overall fit to the data (Figure 47).

Tagging is not incorporated in the model as a tagging experiment, which is not possible within the current SS2 modeling framework. The index for tagging abundance is not fit well and the model estimated effective q for the tagging index was 0.83. This is likely double what it should be based on STAT knowledge of available habitat off the Washington coast. Further, the north central Washington coast, where most of the nearshore rocky habitat exists, is inaccessible to most recreational fishers and is not part of the current tagging program. However, the estimation of q is complicated by the fact that the SS2 value of q is a function of selectivity that is strongly dome shaped for the fishery. Increasing the weighting on survey abundance shows that a better fit to the survey abundance index significantly improves our view of the current population status (Figure 31). Without an objective evaluation of an informed prior on q it is difficult to compare a prior conception of q based on tagging and the one estimated by SS2. Other issues include the non-independence of the length/age compositions and non-independence of the tagging abundance and CPUE series.

Likelihood profile of the STAR base assessment model for different fixed values of the Beverton-Holt steepness parameter (h) and Sigma R show that higher values (STAR base and STAT best-fit model had the steepness fixed at 0.6 and Sigma R tuned to 0.35) of both parameters improved the overall fit to the data (Figure 48). Our assumption on h is well within the uncertainties based on the Dorn meta-analysis, but assumptions on Sigma R may be too low (Dorn personal communication).

Changes in likelihood profile for various components of the base assessment model following changes in the emphasis (weight) of the recruitment Dev and Dev time series indicate very modest changes in fit for weighting between 0.1 to 100 with fit improving to age compositions and declining fit to size compositions with increasing emphasis (Figure 49).

Likelihood profile for various components of the base assessment model following changes in the emphasis (weight) on the abundance and tag CPUE indices indicate a slight improvement in fit by increasing emphasis to 10 on most components with the exception to the fit to sport size and age that declined (Figure 50). Increasing emphasis on the age composition for all fisheries above 1 improves fit to the abundance indices but increased likelihood for the fishery size components (Figure 51). The model was very sensitive to increasing emphasis on the size compositions and declined fit to all age and index components substantially (Figure 52).

8.0 Reference Points and Forecast

The Pacific Fisheries Management Council recommends that a default target fishing mortality rate of $F_{SPR}=0.5$ be used for Council managed rockfish species. The current assessment uses this default for harvest projections and based on the Council's control rule for groundfish would not be considered overfished. Reference points and benchmark fishing mortality rates are shown in Table 23. Forecast ABC's, Spawning biomass and depletion is shown for both the "STAR base" and STAR base model and the STAT best fit model in Table 24.

9.0 ACKNOWLEDGEMENTS

We would like to acknowledge the dedication of numerous volunteers who donated their time to the tagging survey and technicians who spent countless hours collecting fishery and biological information making this assessment possible. We would also like to thank Rick Methot (NWFSC) and Ian Stewart (NWFFSC) for their advice in model structuring and for providing parsing programs that aided immensely in analyzing results. Meetings with Industry and Managers also provided greatly to our understanding of the fishery and perceived stock condition. In great admiration, we would especially like to thank WDFW manager Brian Culver for his unyielding conservation ethic and his contributions to wise management of a valuable public resource for future generations.

10.0 LITERATURE CITED

Berkeley, S.A., Chapman, C., and Sogard, S.M. 2004. Maternal age as a determinant of larval growth and survival in a marine fish, *Sebastes melanops*. *Ecology* 85(5):1258-1264.

Bobko, S.J. and Berkeley, S.A. 2004. Maturity, ovarian, cycle, fecundity, and age-specific parturition of black rockfish (*Sebastes melanops*). *Fisheries Bulletin* 102:418-429.

Chapman, D. 1951. Some Properties of the Hypergeometric Distribution with Applications to Zoological Sample Censuses. *University of California Publications on Statistics*, 1:131-160.

Cheng, Y.W. and Gallinat, M. 2004 Statistical analysis of the relationship among environmental variables, inter-annual variability and smolt trap efficiency of salmonids in the Tucannon River, *Fisheries Research*, 70, 229-238.

Dorn 2002. Advice on west coast rockfish harvest rates from Bayesian meta-analysis of stock-recruit relationships. *North American Journal of Fisheries Management* 22:280-300.

Efron, B. 1982. *The Jackknife, the Bootstrap and Other Resampling Plans*. SIAM (Regional Conference Series in Applied Mathematics, 38). Philadelphia.

Fournier, D. 1997. An Introduction to AD Model Builder for use in non-linear Modeling and statistics. Otter Research Ltd.

Hall P. 1992. The Bootstrap and Edgeworth Expansion, Springer, New York.

Lo, N.C.H, L.D. Jacobson and J.L. Squire 1992. Indices of relative abundance from fish spotter data based on delta-lognormal models. *Canadian Journal of Fisheries and Aquatic Sciences* 49: 2515-2526.

Jackson, J. and Y.W. Cheng. 2001. Improving parameter estimation for daily egg production method of stock assessment of pink snapper in Shark Bay, Western Australia. *Journal of Agricultural, Biological and Environmental Statistics* 6: 243-257.

Lai H, R. Moore, and J.V. Tagart. 1991. Methodologies for estimating catch and effort statistics of ocean sport fishery off the Washington coast with users. Guide for the program "OSP.FOR". *Wash. Dept. Fish. Prog. Rept.* No. 289: 35p.

Lo, N.C., Jacobson, L.D. and Squire, J.L. 1992. Indices of relative abundance from fish spotter data based on delta-lognormal models. *Canadian Journal of Fisheries and Aquatic Sciences* 49:2515-2526.

Miller, D.J. and R.N. Lea. 1972. Guide to the coastal marine fishes of California. *Calif. Dept. Fish. Game Fish Bull.* 157:1-249.

McCullagh, P. and J. A. Nelder. 1989. *Generalized Linear Models*. Second ed. London: Chapman and Hall.

Methot R. 2006. User Manual for the Integrated Analysis Programm Stock Synthesis 2 (SS2).

Pauly, D., 1983. Length-converted catch curves. A powerful tool for fisheries research in the tropics. (Part I). *ICLARM Fishbyte*, 1(2):9-13

Ralston S. and E.J. Dick 2003. The status of black rockfish (*Sebastes melanops*) off Oregon and northern California in 2003. Pacific Fisheries Management Council, Portland Oregon.

Sen, A.R. 1984. Sampling commercial rockfish landings in California. NOAA Tech. Memo. NMFS-SWFC-45, 95p.

Schnute, J., 1981. A versatile growth model with statistically stable parameters. *Can. J. Aquat. Sci.* 38: 1128-1140.

Syrjala, S.E. 2000. Critique on the use of the delta distribution for the analysis of trawl survey data. *ICES Journal of Marine Science* 57: 831-842.

Wallace, F.R. and J.V. Tagart, 1994. Status of the coastal black rockfish stocks in Washington and northern Oregon in 1994. *In* Pacific Fisheries Management Council. 1994. Appendix F: Status of the Pacific Coast Groundfish Fishery Through 1994 and Recommended Acceptable Biological Catches for 1995: Stock Assessment and Fishery Evaluation. Pacific Fisheries Management Council, Portland Oregon.

Wallace, F.R., Hoffmann, A., and Tagart, J.V. Status of the Black Rockfish Resource in 1999. *In* Pacific Fishery Management Council. 1999. Appendix: Status of the Pacific Coast Groundfish Fishery Through 1999 and Recommended Biological Catches for 2000: Stock Assessment and Fishery Evaluation. Pacific Fishery Management Council, Portland, Oregon.

Wilkins, M.E., M. Zimmermann, and K.L. Weinberg. 1995. The 1995 Pacific coast bottom trawl survey of groundfish resources: Estimates of distribution, abundance, and length and age composition. U.S. Dep. Commer., NOAA Tech. Memo. NMFS-AFSC-89, 138 p. plus Appendices.

Tables

Table 1. Black rockfish catch North of Cape Falcon, Oregon by gear and year 1963-2006
(blanks indicate no data).

Coastal black rockfish catch North of Cape Falcon, Oregon							
Year	Catch by Gear			Catch by PMFC Area			
	Trawl	Sport	Ion-Trawl	3A	3B	3C-S	TOTAL
1963	19.0			19.0	0.0	0.0	19.0
1964	8.0			8.0	0.0	0.0	8.0
1965	108.0			108.0	0.0	0.0	108.0
1966	186.0			186.0	0.0	0.0	186.0
1967	234.0			234.0	0.0	0.0	234.0
1968	122.0			122.0	0.0	0.0	122.0
1969	261.0			261.0	0.0	0.0	261.0
1970	303.0		20.5	320.4	3.1	0.0	323.5
1971	134.1		17.5	147.6	4.0	0.0	151.6
1972	116.0		29.3	137.7	7.5	0.0	145.3
1973	48.0		26.8	63.7	11.1	0.0	74.8
1974	75.0		51.2	106.8	19.4	0.0	126.2
1975	156.0	62.3	36.9	216.7	38.5	0.0	255.2
1976	347.2	36.8	32.7	384.5	32.3	0.0	416.7
1977	15.0	76.0	52.2	96.1	47.2	0.0	143.2
1978	96.0	94.2	89.8	185.2	94.8	0.0	280.1
1979	321.3	150.7	104.0	500.5	75.5	0.0	576.0
1980	64.6	144.8	70.5	228.9	51.0	0.0	279.9
1981	213.0	213.8	81.8	436.6	72.0	0.0	508.6
1982	185.1	135.7	128.9	364.8	84.9	0.0	449.7
1983	327.5	244.3	134.1	458.2	247.7	0.0	705.9
1984	218.9	302.2	145.8	513.2	153.8	0.0	666.9
1985	127.3	305.3	272.0	407.8	296.8	0.0	704.6
1986	158.6	391.1	103.0	534.0	118.8	0.0	652.8
1987	82.0	389.3	220.1	494.3	197.0	0.0	691.3
1988	129.0	414.2	129.3	521.1	151.5	0.0	672.5
1989	124.4	369.6	165.3	469.3	188.0	2.0	659.3
1990	43.3	387.2	119.4	386.9	163.0	0.0	549.9
1991	46.2	332.3	83.4	320.3	139.6	1.9	461.9
1992	71.4	342.9	132.3	327.2	219.3	0.0	546.5
1993	46.8	316.9	88.4	298.3	152.9	1.0	452.2
1994	1.0	358.6	106.3	323.9	141.6	0.4	465.9
1995	3.3	264.8	65.8	214.9	118.7	0.3	333.9
1996	0.0	264.2	8.6	204.4	68.4	0.0	272.8
1997	9.0	234.1	15.0	194.8	63.2	0.1	258.1
1998	73.1	259.4	4.8	268.1	69.0	0.3	337.4
1999	0.0	221.6	4.3	169.4	56.5	0.0	225.9
2000	0.0	224.8	1.2	158.2	67.9	0.0	226.1
2001	0.0	188.7	1.1	134.3	55.5	0.0	189.8
2002	0.2	238.9	1.5	173.5	67.1	0.0	240.6
2003	0.1	237.1	0.2	166.8	70.6	0.0	237.4
2004	0.6	268.0	0.7	174.4	94.9	0.0	269.3
2005	0.0	331.7	0.9	217.8	114.7	0.0	332.5
2006	1.4	321.5	1.2	248.7	75.4	0.0	324.1
Mean	101.7	253.8	68.8	261.5	82.6	0.1	344.2
Last 10 y	8.4	252.6	3.1	190.6	73.5	0.0	264.1
Last 5 y	0.5	279.4	0.9	196.2	84.5	0.0	280.8

Table 2. Historical catch of rockfish by known rockfish catch categories between 1936 and 1969.

Historical catch of rockfish by rockfish catch categories for coastal Washington Waters		
Year	Black Rockfish	Rockfish
1936	-	0.1
1937	-	219.0
1938	-	273.7
1939	-	290.8
1940	-	330.2
1941	-	554.7
1942	-	1,925.0
1943	-	5,811.7
1944	-	9,084.7
1945	-	25,969.7
1946	-	11,322.2
1947	-	2,970.8
1948	-	5,192.1
1949	-	5,943.5
1950	-	151.1
1951	-	6,777.8
1952	151.5	-
1953	8.0	153.1
1954	16.1	2.8
1955	5.0	76.5
1956	7.8	-
1957	19.1	76.5
1958	71.8	33.1
1959	26.6	36.2
1960	96.2	32.7
1961	40.7	40.5
1962	12.5	22.5
1963	-	279.9
1964	3.4	38.7
1965	-	347.8
1966	1.0	36.6
1967	-	167.7
1968	-	130.9
1969	-	151.4

Note: Data from WDFW annual catch reports.

Table 3. Assumed catch and data input of black rockfish between 1940 and 1975. Bold italics represents catch assumptions and normal italics indicate the actual catch estimate based on fish ticket and species composition data.

Year	<i>Catch by Gear</i>		
	Trawl	Sport	Non-Trawl
Initial	<i>2.0</i>	<i>2.0</i>	<i>1.0</i>
1940	<i>3.2</i>	<i>2.8</i>	<i>0.0</i>
1941	<i>9.2</i>	<i>4.6</i>	<i>0.0</i>
1942	<i>15.2</i>	<i>6.3</i>	<i>0.0</i>
1943	<i>21.2</i>	<i>8.1</i>	<i>0.0</i>
1944	<i>27.2</i>	<i>9.8</i>	<i>0.0</i>
1945	<i>33.2</i>	<i>11.6</i>	<i>0.0</i>
1946	<i>39.2</i>	<i>13.3</i>	<i>0.0</i>
1947	<i>52.0</i>	<i>15.1</i>	<i>0.0</i>
1948	<i>51.2</i>	<i>16.8</i>	<i>0.0</i>
1949	<i>57.2</i>	<i>18.6</i>	<i>0.0</i>
1950	<i>63.2</i>	<i>20.3</i>	<i>1.5</i>
1951	<i>69.2</i>	<i>22.1</i>	<i>2.5</i>
1952	<i>75.2</i>	<i>23.8</i>	<i>3.5</i>
1953	<i>81.2</i>	<i>25.6</i>	<i>4.5</i>
1954	<i>87.2</i>	<i>27.3</i>	<i>5.5</i>
1955	<i>93.2</i>	<i>29.1</i>	<i>6.5</i>
1956	<i>99.2</i>	<i>30.8</i>	<i>7.5</i>
1957	<i>105.2</i>	<i>32.6</i>	<i>8.5</i>
1958	<i>111.2</i>	<i>34.3</i>	<i>9.5</i>
1959	<i>117.2</i>	<i>36.1</i>	<i>10.5</i>
1960	<i>123.2</i>	<i>37.8</i>	<i>11.5</i>
1961	<i>129.2</i>	<i>39.6</i>	<i>12.5</i>
1962	<i>135.2</i>	<i>41.3</i>	<i>13.5</i>
1963	<i>141.2</i>	<i>43.1</i>	<i>14.5</i>
1964	108.0	<i>44.8</i>	<i>15.5</i>
1965	186.0	<i>46.6</i>	<i>16.5</i>
1966	234.0	<i>48.3</i>	<i>17.5</i>
1967	122.0	<i>50.1</i>	<i>18.5</i>
1968	261.0	<i>51.8</i>	<i>19.5</i>
1969	303.0	<i>53.6</i>	20.5
1970	134.1	<i>55.3</i>	17.5
1971	116.0	<i>57.1</i>	29.3
1972	48.0	<i>58.8</i>	26.8
1973	75.0	<i>60.6</i>	51.2
1974	156.0	62.3	36.9
1975	347.2	62.3	32.7

Presumed Catch SS2 input in bold italics.

Table 4. Estimated black rockfish discard in the Washington recreational sport fishery.

Black Rockfish Discard in the Washington Sport Fishery

Year	# of Fish	Mean Weight (kg)	Assumed Mortality	Catch Weight (mt)
2002	5,719	1.17	90%	6.0
2003	4,554	1.21	90%	5.0
2004	9,764	1.18	90%	10.4
2005	15,085	1.19	90%	16.2
2006	8,733	1.22	90%	9.6

Note: Discard not available prior to 2002

Table 5. Total effort (expanded) in Washington sport fisheries.

	All Trip Types		Bottom-Fish-Only Trips	
	ANGLERS	BOAT TRIPS	ANGLERS	BOAT TRIPS
1985	177,305	36,486	31,200	5,984
1986	213,459	47,941	36,223	6,536
1987	245,293	60,622	45,115	9,268
1988	254,412	67,793	47,793	9,299
1989	301,922	80,913	32,506	6,217
1990	198,095	50,245	36,572	7,109
1991	216,554	60,133	37,416	7,437
1992	174,219	48,476	40,248	8,960
1993	230,890	68,690	42,022	9,446
1994	55,288	12,039	40,005	8,009
1995	115,954	28,775	36,120	8,425
1996	144,324	39,575	32,950	6,822
1997	111,714	32,792	29,937	6,593
1998	81,429	22,740	29,818	6,012
1999	81,182	21,764	24,269	4,737
2000	113,869	31,976	22,563	4,169
2001	208,076	59,325	20,385	4,068
2002	153,200	40,120	20,394	3,817
2003	180,360	48,437	18,453	3,548
2004	184,615	51,119	22,188	4,733
2005	150,017	39,433	28,645	6,451
2006	122,067	31,743	30,138	6,321

Table 6. Summary of size composition data collected from commercial and recreational fisheries during 1976 – 2006.

Year	Number of field samples			Number of length measurements			Mean size (cm)		
	Sport	Trawl	Non-Trawl	Sport	Trawl	Non-Trawl	Sport	Trawl	Non-Trawl
1976		4			782			47.5	
1977									
1978									
1979	7			508			46.4		
1980	8	2	2	703	206	96	45.4	46.1	45.9
1981	23	4		1468	400		43.3	46.8	
1982	9	4	1	263	400	29	40.7	44.5	40.1
1983	1	8	2	10	800	124	36.9	45.3	41.2
1984	21	3	1	835	300	100	40.4	44.7	40.9
1985	2			160			43.1		
1986	21	13	27	512	322	527	41.8	45.5	44.4
1987	23	16	25	645	401	722	43.3	47.3	43.2
1988	18	4	17	451	100	424	41.9	47.3	43.8
1989	16	9	12	397	225	299	42.2	49.1	44.7
1990	11	10	4	290	249	125	41.6	47.1	36.7
1991	22	12	19	720	302	500	40.8	47.1	40.2
1992	34	8	11	890	200	275	41.3	46.3	40.0
1993	35	5	13	866	125	325	40.6	46.9	40.4
1994	35	2	9	868	49	250	40.9	46.2	38.1
1995	32	2	9	814	50	225	40.5	45.7	39.6
1996	33			834			39.5		
1997	36	2		900	31		40.5	46.6	
1998	37	2		1327	85		39.8	43.6	
1999	34			1673			39.5		
2000	33	1		1650	3		40.0	47.3	
2001	36	1		1777	1		40.2	53.0	
2002	56	1		2629	50		40.9	47.8	
2003	58	1		2323	3		41.4	45.7	
2004	44	2		2002	15		41.0	51.7	
2005	61		1	2228		1	41.2		43.0
2006	152		2	2854		20	41.1		48.1

Table 7. Summary of age composition data collected from commercial and recreational fisheries during 1976 – 2006.

Year	Number of field samples			Number of age			Mean age		
	Sport	Trawl	Non-Trawl	Sport	Trawl	Non-Trawl	Sport	Trawl	Non-Trawl
1976		2			238			11.3	
1977									
1978									
1979									
1980	4	2		364	195		14.3	13.0	
1981	2	4		71	394		10.6	11.8	
1982		3			295			10.2	
1983		8	1		794	100		10.2	11.8
1984	20	3	1	828	298	99	9.7	12.6	11.3
1985	2			160			10.8		
1986	21	13	27	506	321	525	9.3	10.1	11.9
1987	23	16	25	642	401	720	11.5	11.3	10.9
1988	18	4	17	448	99	416	10.0	12.1	10.8
1989	16	9	12	395	224	297	9.3	10.5	10.8
1990	11	10	4	289	249	125	9.4	11.2	7.3
1991	22	12	19	717	301	500	9.2	12.2	8.7
1992	34	8	11	889	200	275	9.7	10.1	9.0
1993	35	5	13	863	125	324	9.0	10.9	8.5
1994	35	2	9	866	48	250	9.6	13.4	7.7
1995	32	2	9	813	49	225	8.6	12.0	7.7
1996	33			829			8.5		
1997	36			893			9.6		
1998	37			1323			9.4		
1999	34			1655			9.1		
2000	33			1644			9.6		
2001	36			1773			9.7		
2002	38			1894			9.8		
2003	37			1841			9.6		
2004	33			1645			9.4		
2005	33			1603			9.6		
2006	30		1	1484		19	9.5		14.3

Table 8. Summary of male and female black rockfish age to weight data with estimated errors in each conversion.

Age \hat{t} (st. err.)	Male		Female	
	\hat{L} (st.err.)	\hat{W} (st.err.)	\hat{L} (st.err.)	\hat{W} (st.err.)
1(0.002)	20.123(0.583)	0.161(0.019)	20.123(0.583)	0.163(0.019)
2(0.004)	24.754(0.406)	0.286(0.029)	24.689(0.396)	0.288(0.028)
3(0.006)	28.568(0.281)	0.426(0.040)	28.564(0.262)	0.431(0.039)
4(0.007)	31.709(0.195)	0.569(0.052)	31.851(0.170)	0.583(0.051)
5(0.009)	34.296(0.138)	0.708(0.064)	34.641(0.113)	0.735(0.063)
6(0.011)	36.427(0.105)	0.838(0.076)	37.008(0.083)	0.883(0.076)
7(0.013)	38.181(0.092)	0.955(0.086)	39.017(0.070)	1.022(0.088)
8(0.015)	39.626(0.094)	1.059(0.096)	40.722(0.064)	1.150(0.099)
9(0.017)	40.816(0.106)	1.149(0.104)	42.168(0.062)	1.267(0.109)
10(0.019)	41.796(0.122)	1.228(0.111)	43.396(0.063)	1.371(0.118)
11(0.020)	42.603(0.140)	1.295(0.117)	44.437(0.068)	1.465(0.126)
12(0.022)	43.268(0.159)	1.352(0.123)	45.321(0.077)	1.547(0.133)
13(0.024)	43.815(0.177)	1.400(0.127)	46.071(0.090)	1.618(0.139)
14(0.026)	44.266(0.195)	1.441(0.131)	46.707(0.106)	1.681(0.144)
15(0.028)	44.637(0.211)	1.474(0.134)	47.247(0.123)	1.735(0.149)
16(0.030)	44.943(0.227)	1.503(0.137)	47.706(0.141)	1.782(0.153)
17(0.032)	45.195(0.241)	1.526(0.139)	48.095(0.158)	1.823(0.157)
18(0.033)	45.402(0.253)	1.546(0.141)	48.425(0.175)	1.858(0.160)
19(0.035)	45.573(0.265)	1.562(0.143)	48.705(0.192)	1.888(0.163)
20(0.037)	45.714(0.275)	1.576(0.144)	48.942(0.207)	1.913(0.165)
21(0.039)	45.829(0.284)	1.587(0.146)	49.144(0.221)	1.935(0.167)
22(0.041)	45.925(0.292)	1.596(0.147)	49.315(0.234)	1.954(0.169)
23(0.043)	46.003(0.299)	1.603(0.147)	49.460(0.246)	1.970(0.171)
24(0.045)	46.068(0.306)	1.610(0.148)	49.583(0.257)	1.983(0.172)
25(0.046)	46.121(0.311)	1.615(0.149)	49.688(0.267)	1.995(0.173)
26(0.048)	46.165(0.316)	1.619(0.149)	49.776(0.275)	2.005(0.174)
27(0.050)	46.201(0.320)	1.623(0.150)	49.852(0.283)	2.013(0.175)
28(0.052)	46.231(0.323)	1.626(0.150)	49.916(0.291)	2.020(0.176)
29(0.054)	46.256(0.326)	1.628(0.150)	49.970(0.297)	2.026(0.177)
30(0.056)	46.276(0.329)	1.630(0.150)	50.016(0.303)	2.032(0.177)
31(0.058)	46.293(0.331)	1.632(0.151)	50.055(0.308)	2.036(0.178)
32(0.059)	46.306(0.333)	1.633(0.151)	50.088(0.312)	2.040(0.178)
33(0.061)	46.318(0.335)	1.634(0.151)	50.116(0.316)	2.043(0.179)
34(0.063)	46.327(0.336)	1.635(0.151)	50.140(0.320)	2.046(0.179)
35(0.065)	46.334(0.338)	1.636(0.151)	50.160(0.323)	2.048(0.179)
36(0.067)	46.341(0.339)	1.636(0.151)	50.177(0.325)	2.050(0.179)
37(0.069)	46.346(0.339)	1.637(0.151)	50.192(0.328)	2.051(0.180)
38(0.071)	46.350(0.340)	1.637(0.151)	50.204(0.330)	2.053(0.180)
39(0.072)	46.354(0.341)	1.638(0.151)	50.215(0.332)	2.054(0.180)
40(0.074)	46.357(0.341)	1.638(0.151)	50.224(0.333)	2.055(0.180)
41(0.076)	46.359(0.342)	1.638(0.151)	50.231(0.335)	2.056(0.180)
42(0.078)	46.361(0.342)	1.638(0.152)	50.238(0.336)	2.057(0.180)
43(0.080)	46.363(0.343)	1.639(0.152)	50.243(0.337)	2.057(0.180)
44(0.082)	46.364(0.343)	1.639(0.152)	50.248(0.338)	2.058(0.180)
45(0.084)	46.365(0.343)	1.639(0.152)	50.252(0.339)	2.058(0.180)
46(0.085)	46.366(0.343)	1.639(0.152)	50.255(0.340)	2.059(0.180)
47(0.087)	46.367(0.343)	1.639(0.152)	50.258(0.340)	2.059(0.181)

48(0.089)	46.367(0.344)	1.639(0.152)	50.260(0.341)	2.059(0.181)
49(0.091)	46.368(0.344)	1.639(0.152)	50.262(0.341)	2.059(0.181)
50(0.093)	46.368(0.344)	1.639(0.152)	50.264(0.342)	2.060(0.181)
51(0.095)	46.369(0.344)	1.639(0.152)	50.265(0.342)	2.060(0.181)
52(0.097)	46.369(0.344)	1.639(0.152)	50.267(0.342)	2.060(0.181)
53(0.098)	46.369(0.344)	1.639(0.152)	50.268(0.343)	2.060(0.181)
54(0.100)	46.369(0.344)	1.639(0.152)	50.269(0.343)	2.060(0.181)
55(0.102)	46.369(0.344)	1.639(0.152)	50.269(0.343)	2.060(0.181)
56(0.104)	46.370(0.344)	1.639(0.152)	50.270(0.343)	2.060(0.181)
57(0.106)	46.370(0.344)	1.639(0.152)	50.270(0.343)	2.060(0.181)
58(0.108)	46.370(0.344)	1.639(0.152)	50.271(0.343)	2.060(0.181)
59(0.110)	46.370(0.344)	1.639(0.152)	50.271(0.344)	2.060(0.181)
60(0.112)	46.370(0.344)	1.639(0.152)	50.272(0.344)	2.061(0.181)

Table 9. Summary of the number of black rockfish fish sampled with age in maturity study and the expected probability of maturity with age.

Age	No. of immature fish	No. of mature fish	Expected probability of maturity
4	1	0	0.01
5	12	0	0.02
6	50	1	0.05
7	73	7	0.09
8	65	13	0.17
9	38	22	0.29
10	22	12	0.45
11	6	15	0.62
12	2	5	0.76
13	2	2	0.87
14	0	2	0.93
15	0	0	0.96
16	0	0	0.98
17	0	0	0.99
18	0	0	1.00
19	0	0	1.00
20	0	2	1.00

Table 10. Summary of the number of black rockfish fish sampled with fork length in maturity study and the expected probability of maturity with fork length.

Fork length (cm)	No. of immature fish	No. of mature fish	Expected probability of maturity
25	1	0	0
26	1	0	0
27	1	0	0
28	2	0	0
29	3	0	0
30	7	0	0.01
31	3	1	0.01
32	5	0	0.02
33	13	0	0.02
34	18	0	0.03
35	30	0	0.05
36	32	3	0.07
37	37	4	0.11
38	30	8	0.15
39	35	10	0.22
40	27	12	0.29
41	20	13	0.38
42	14	9	0.48
43	8	10	0.59
44	4	11	0.68
45	2	2	0.76
46	0	7	0.83
47	1	3	0.88
48	0	2	0.92
49	0	2	0.94

Table 11. Summary of the estimated total mortality coefficients of male and female black rockfish from 1984 to 2006.

Year	Male		Female	
	N	\hat{Z} (st. err.)	n	\hat{Z} (st. err.)
1984	267	0.162(0.068)	429	0.267(0.005)
1988	128	0.169(0.098)	148	0.341(0.207)
1989	180	0.256(0.112)	217	0.205(0.071)
1990	132	0.200(0.044)	158	0.407(0.129)
1991	326	0.213(0.050)	394	0.259(0.031)
1992	424	0.187(0.080)	457	0.325(0.011)
1993	364	0.270(0.048)	495	0.277(0.028)
1994	399	0.244(0.013)	465	0.348(0.016)
1995	372	0.304(0.009)	440	0.370(0.039)
1996	399	0.394(0.080)	432	0.387(0.014)
1997	437	0.298(0.079)	438	0.361(0.031)
1998	947	0.315(0.043)	874	0.400(0.013)
1999	851	0.320(0.034)	822	0.353(0.013)
2000	741	0.316(0.071)	909	0.406(0.056)
2001	800	0.353(0.026)	974	0.427(0.053)
2002	783	0.324(0.064)	1066	0.298(0.057)
2003	793	0.290(0.055)	1009	0.327(0.069)
2004	731	0.254(0.066)	922	0.297(0.032)
2005	681	0.238(0.092)	982	0.339(0.069)
2006	806	0.220(0.074)	802	0.323(0.035)

Table 12. Summary of the proportion by area and the number of recreational observations taken from 1990 to 2006.

Year	Area				
	1	2	3	74	84
1990	5102(2.87%)	159462(89.83%)	2202(1.24%)	5601(3.16%)	5144(2.90%)
1991	2156(1.43%)	138150(91.69%)	2602(1.73%)	3122(2.07%)	4643(3.08%)
1992	3422(2.82%)	97598(80.29%)	4159(3.42%)	10128(8.33%)	6252(5.14%)
1993	5636(5.13%)	88923(81.01%)	3153(2.87%)	6115(5.57%)	5942(5.41%)
1994	7754(4.37%)	148419(83.69%)	7552(4.26%)	7275(4.10%)	6340(3.58%)
1995	3442(2.42%)	112959(79.57%)	5118(3.61%)	10172(7.17%)	10271(7.24%)
1996	5018(3.02%)	133094(80.22%)	4179(2.52%)	8263(4.98%)	15349(9.25%)
1997	5771(4.67%)	100816(81.61%)	1729(1.40%)	5814(4.71%)	9400(7.61%)
1998	8048(5.79%)	110960(79.78%)	2711(1.95%)	4645(3.34%)	12720(9.15%)
1999	1951(1.77%)	93642(84.92%)	2801(2.54%)	4412(4.00%)	7470(6.77%)
2000	3524(3.09%)	93927(82.31%)	3125(2.74%)	6625(5.81%)	6918(6.06%)
2001	3814(4.01%)	77415(81.37%)	2232(2.35%)	5322(5.59%)	6355(6.68%)
2002	4610(4.54%)	79168(77.89%)	2823(2.78%)	8967(8.82%)	6079(5.98%)
2003	6589(7.25%)	68067(74.87%)	2735(3.01%)	6757(7.43%)	6766(7.44%)
2004	4599(4.66%)	74905(75.93%)	3706(3.76%)	6047(6.13%)	9399(9.53%)
2005	4136(3.43%)	84719(70.28%)	7052(5.85%)	9351(7.76%)	15280(12.68%)
2006	5769(4.31%)	106803(79.75%)	4558(3.40%)	6307(4.71%)	10492(7.83%)

Table 13. Summary of the recreational fishery CPUEs estimated from mean estimator and delta lognormal model for all areas.

Year	Total catch/total anglers				Delta lognormal model			
	Estimates	$q_{\bar{X},2.5\%}$	$q_{\bar{X},97.5\%}$	$CV_{\bar{X}}$	Estimates	$q_{\bar{X},2.5\%}$	$q_{\bar{X},97.5\%}$	$CV_{\bar{X}}$
1990	8.58	8.33	8.85	0.02	5.73	5.52	5.92	0.02
1991	7.37	7.18	7.60	0.02	5.43	5.24	5.61	0.02
1992	6.14	5.92	6.37	0.02	4.77	4.63	4.92	0.02
1993	5.83	5.61	6.11	0.02	4.24	4.13	4.42	0.02
1994	6.87	6.70	7.04	0.01	4.43	4.29	4.56	0.01
1995	5.94	5.75	6.10	0.01	4.07	3.94	4.18	0.02
1996	6.37	6.22	6.53	0.01	4.57	4.45	4.69	0.01
1997	5.78	5.64	5.94	0.02	3.93	3.81	4.05	0.02
1998	6.35	6.17	6.50	0.01	4.80	4.66	4.91	0.01
1999	6.93	6.73	7.07	0.01	4.86	4.70	4.99	0.02
2000	6.83	6.63	6.98	0.01	5.03	4.87	5.18	0.02
2001	6.46	6.25	6.66	0.01	4.29	4.13	4.44	0.02
2002	7.03	6.86	7.20	0.01	5.01	4.86	5.17	0.02
2003	6.93	6.75	7.12	0.01	4.95	4.75	5.14	0.02
2004	7.14	6.94	7.33	0.01	5.57	5.41	5.73	0.02
2005	6.98	6.80	7.13	0.01	5.36	5.21	5.48	0.01
2006	7.29	7.15	7.42	0.01	5.20	5.06	5.33	0.01

Table 14. Summary of the recreational sport CPUEs estimated from mean estimator and delta lognormal model for Area 2.

Year	Total catch/total anglers				Delta lognormal model			
	Estimates	$q_{\bar{X},2.5\%}$	$q_{\bar{X},97.5\%}$	$CV_{\bar{X}}$	Estimates	$q_{\bar{X},2.5\%}$	$q_{\bar{X},97.5\%}$	$CV_{\bar{X}}$
1990	10.98	10.66	11.29	0.02	10.84	10.51	11.18	0.01
1991	8.75	8.54	8.96	0.01	8.35	8.11	8.56	0.01
1992	7.35	7.01	7.63	0.02	6.85	6.53	7.11	0.02
1993	7.52	7.24	7.85	0.02	7.16	6.92	7.48	0.02
1994	9.64	9.43	9.86	0.01	9.33	9.13	9.55	0.01
1995	8.31	8.16	8.46	0.01	7.81	7.64	8.01	0.01
1996	8.03	7.83	8.23	0.01	7.63	7.45	7.81	0.01
1997	7.23	7.01	7.44	0.01	6.37	6.12	6.59	0.02
1998	7.44	7.20	7.63	0.01	6.76	6.57	6.95	0.01
1999	8.54	8.35	8.72	0.01	7.70	7.46	7.91	0.02
2000	8.36	8.18	8.58	0.01	7.80	7.60	7.99	0.01
2001	8.25	8.03	8.47	0.01	7.08	6.81	7.35	0.02
2002	8.85	8.63	9.05	0.01	7.95	7.68	8.24	0.02
2003	8.46	8.24	8.68	0.01	6.83	6.51	7.11	0.02
2004	8.10	7.86	8.31	0.01	6.86	6.58	7.12	0.02
2005	8.77	8.60	8.93	0.01	7.80	7.60	8.03	0.02
2006	8.92	8.78	9.05	0.01	8.16	7.96	8.33	0.01

Table 15. Central Washington coastal tagging mean catch per trip (catch/hours fished).

Central Washington Coast Tagging CPUE
Mean Catch Per Hour

Year	Across All Trips	$\ln(1+cv)$
1981	4.8	0.666
1986	2.3	0.5993
1987	1.2	0.6344
1988	0.8	0.5539
1989	1.2	0.9771
1990	1.0	0.8439
1998	2.5	0.813
1999	3.1	0.7407
2000	2.2	0.5684
2001	4.7	0.6076
2002	5.5	0.5034
2003	6.2	0.5913
2004	9.4	0.5149
2005	10.2	0.7579
2006	10.5	0.4205

Table 16. Summary of the return of tagged fish from the CWT double tags experiment.

Year	i	No. of one tag return (r_{si})		No. of two tags return (r_{di})
		left	right	
1998	0	8	17	691
1999	1	14	11	542
2000	2	14	18	433
2001	3	14	8	276
2002	4	6	8	160
2003	5	2	2	73
2004	6	0	2	34

Table 17. Summary of the year, the no. of fish tagged, no. of fish sampled, the numbers of fish return with tags, tag on the right, tag on the left, double tag, the estimated population size and variance, the adjusted no. of tag return with tag loss, the estimated population size with tag loss adjustment and variance.

Year	n_1	n_2	m	m_r	m_l	m_d	\hat{N}	$\text{Var}(\hat{N})$	\hat{m}	\hat{N}	$\text{Var}(\hat{N})$
1998	2456	46951	14	1	1	12	7.69E+06	3.67E+12	14.08	7.65E+06	4.53E+12
1999	3479	66253	43	1	0	42	5.24E+06	6.02E+11	43.01	5.24E+06	6.46E+11
2000	2789	65276	130	3	5	122	1.39E+06	1.39E+10	130.13	1.39E+06	1.53E+10
2001	3210	64440	68	2	1	65	3.00E+06	1.26E+11	68.03	3.00E+06	1.35E+11
2002	4089	68475	143	1	1	141	1.94E+06	2.51E+10	143.01	1.94E+06	2.66E+10
2003	6747	77622	246	1	8	237	2.12E+06	1.74E+10	246.09	2.12E+06	1.86E+10
2004	4209	53385	74	1	1	72	3.00E+06	1.16E+11	74.01	3.00E+06	1.23E+11
2005	3913	70482	54	0	0	54	5.02E+06	4.43E+11	54.00	5.02E+06	4.66E+11

Table 18. Likelihood components from the STAR base (top) and STAT best-fit (bottom) northern black rockfish models.

STAR Base Model		
Likelihood Components	Emphasis	Likelihood
indices		
Tag Abundance	1.0	43.4
Tag CPUE	1.0	11.7
discard	0.0	0.0
length_comps		
Trawl	0.1	67.6
Sport	0.1	32.3
Non-Trawl	0.1	38.1
Tag	0.1	18.3
age_comps		
Trawl	1.0	187.2
Sport	1.0	395.3
Non-Trawl	1.0	187.0
size-at-age	0.0	105.9
mean_body_wt	0.0	0.0
Equil_catch	1.0	0.0
Recruitment	0.1	14.5
Parm_priors	1.0	0.0
Parm_devs	0.1	0.0
penalties	0.0	0.0
Forecast_Recruitment	0.0	0.2
		1101.6

STAT Best Fit Model		
Likelihood Components	Emphasis	Likelihood
indices		
Tag Abundance	1.0	41.5
Tag CPUE	1.0	10.4
discard	0.0	0.0
length_comps		
Trawl	0.1	69.2
Sport	0.1	32.5
Non-Trawl	0.1	39.4
Tag	0.1	19.0
age_comps		
Trawl	1.0	180.6
Sport	1.0	386.8
Non-Trawl	1.0	185.7
size-at-age	0.0	106.5
mean_body_wt	0.0	0.0
Equil_catch	1.0	0.0
Recruitment	0.1	15.4
Parm_priors	1.0	0.0
Parm_devs	0.1	0.0
penalties	0.0	0.0
Forecast_Recruitment	0.0	0.2
		1087.15

Table 19. Assumptions and Priors used in the Northern black rockfish STAR base model. The only change in the STAT Best Fit model is an increase in the “old” female natural mortality rate from 0.20 to 0.24.

#_growth_parms						
#_LO	HI	INIT	PRIOR	PR_type	SD_Prior	PHASE
#Females						
0.1	0.2	0.16	0.3	-1	0.9	-2 #_Gpattern:_1_Gender:_Female_M1_natM_young
-3	3	0.2	0.3	-1	0.9	-2 #M1_natM_old_4_intermediateages_do_a_linear_interpolation_of_NM_on_age
10	40	34.4	13.5	-1	10	2 #M1_Lmin_Body_length_at_Amin_(units_in_cm)
30	70	50.37	49.3	-1	10	2 #M1_Lmax_Body_length_at_Amax_(units_in_cm)
0.01	0.4	0.181	0.1745	-1	0.9	3 #M1_VBK
-3	3	0.08	0.0622	-1	0.9	-2 #M1_CV-young_Variability_for_size-at-age_at-age<=AFIX_(units_are_fraction)Units_CV_or
-3	3	0.08	0.0721	-1	0.9	-3 #M1_CV-old_Variability_for_size-at-age_at-age>=AFIX2_do_a_linear_interpolation_of_CV_
#Males						
0.1	0.2	0.16	0.1	-1	0.9	-2 #_Gpattern:_1_Gender:_Male__M1_natM_young
0.1	0.2	0.16	0.1	-1	0.9	-2 #M1_natM_old_4_intermediateages_do_a_linear_interpolation_of_NM_on_age
10	40	34.2	15	-1	0.9	2 #M1_Lmin
30	70	47.3	46.6	-1	0.9	2 #M1_Lmax
0.1	0.3	0.191	0.1982	-1	0.9	3 #M1_VBK
0.05	0.25	0.07	0.06	-1	0.9	-3 #M1_CV-young
-3	3	0.07	0.0567	-1	0.9	-3 #M1_CV-old
#Females_wtln_Maturity_fec						
-3	3	4.03E-05	4.03E-05	-1	99	-3 #Female wt-len-1_coefficient_to_convert_L_in_cm_to_Wt_in_kg
-3	3	2.768	2.768	-1	0.9	-3 #Female wt-len-2_Exponent_in_female_L-W_conversion
-3	3	42.6	42.6	-1	0.9	-3 #Female_Maturity_logistic_inflection
-3	3	-0.4	-0.4	-1	0.9	-3 #Female_Logistic_slope
-3	3	-0.3657	-0.3657	-1	0.9	-3 #-0.3657Female_eggs/gm_intercept
-3	3	0.7674	0.7674	-1	0.9	-3 #0.7674Female_eggs/gm_slope
#Male_wtln						
-3	3	3.80E-05	3.80E-05	-1	99	-3 #Male wt-len-1_coefficient_to_convert_L_in_cm_to_Wt_in_kg
-3	3	2.782	2.782	-1	0.9	-3 #Male wt-len-2_Exponent_in_female_L-W_conversion
-4	4	0	1	-1	0.9	-3 #_recrdistribution_by_growth_pattern
-4	4	0	1	-1	0.9	-3 #_recrdistribution_by_area_1
-4	4	0	1	-1	0.9	-3 #_recrdistribution_by_season_1
-1	1	1	1	-1	0.9	-3 #_cohort_growth_deviation
0 #_custom_MG-env_setup						
0 #_custom_MG-block_setup						
#_Spawner-Recruitment						
3 #_SR_function						
#_LO	HI	INIT	PRIOR	PR_type	SD	PHASE
1	15	12	6.7	0	10	1 #log(R0)
0.2	1	0.6	0.566	2	0.181	-5 #steepness
0	2	0.3	0.65	0	0.4	-4 #sigma-r
-5	5	0	0	0	1	-3 #env-linkrecruitment-environmental_linkage_coefficient
-5	5	0	0	0	1	-1 #log(R1)offsetfor_initial_equil_recruitment_relative_to_virgin_recruitment_(usually0)
0	0	0	0	-1	0	-99 #autocorrelation_parameter_for_S-R
0 #_SR_env_link						
1 #_SR_env_target_1=devs;_2=R0;_3=steepness						
1 #do_recr_c0=none; 1=devvector;_2=simple_deviations						
1968 #Begin RecDevs						
2001 #End_recr_Dev						
-15 #Min_Value4Rec_Dev						
15 #Max_Value4RecDev						
3 #Phaseto begin_Estimation						
1492 #_first_yr_fullbias_adj_in_MPD						
#_initial_F_parms						
#_LO	HI	INIT	PRIOR	PR_type	SD	PHASE
0	0.6	0	0.0001	-1	99	-1
0	0.6	0	0.0001	-1	99	-1
0	0.6	0	0.0001	-1	99	-1
#_Q_setup						
#	A=do	power,	B=env-var,	C=extra	SD,	D=devtype 0/1=none, 2=cons, 3=rand, 4=randwalk E=0=num/ F=err_type
#_A	B	C	D	E	F	
0	0	0	0	1	0	
0	0	0	0	1	0	
0	0	0	0	1	0	
0	0	0	0	0	0	
0	0	0	0	0	0	
0	0	0	0	0	0	
#_Q_parms(if_any)						

Table 19. Continued.

#_selex_parms	#_LO	HI	INIT	PRIOR	PR_type	SD	PHASE
#_size_sel: Trawl							
	30	60	46	51.2	-1	0.05	2
	-6	4	1.6	-2.6	-1	0.05	3
	-1	9	4	5.2	-1	0.05	-3
	-1	9	2.2	6	-1	0.05	-3
	-8	9	-4	-3.7	-1	0.05	2
	-5	9	-1	0.1	-1	0.05	2
#_size_sel: Sport							
	20	60	41.5	41.2	-1	0.05	2
	-6	4	-4	-2.6	-1	0.05	3
	-1	9	3.5	5.2	-1	0.05	-3
	-1	9	3	6	-1	0.05	-3
	-8	9	-3.7	-3.7	-1	0.05	2
	-5	9	-1	0.1	-1	0.05	2
#_size_sel: Non-trawl							
	30	60	46	41.2	-1	0.05	2
	-6	4	-0.747	-2.6	-1	0.05	3
	-1	9	4.83454	5.2	-1	0.05	3
	-1	9	4	6	-1	0.05	3
	-8	9	-4	-3.7	-1	0.05	2
	-5	9	2	0.1	-1	0.05	2
#_size_sel: OSP CPUE mirror sport							
	1	19	1	5	-1	0.05	-2
	1	19	19	5	-1	0.05	-3
#_size_sel: Tagging abundance mirrow tagging CPUE							
	1	19	1	5	-1	0.05	-2
	1	19	19	5	-1	0.05	-3
#_size_sel: Tagging CPUE							
	20	60	39.513	41.2	-1	0.05	2
	-6	4	-3.41	-2.6	-1	0.05	3
	-1	9	3.7	5.2	-1	0.05	3
	-1	9	3.5	6	-1	0.05	3
	-8	9	-4.69	-3.7	-1	0.05	2
	-5	9	-3.95	0.1	-1	0.05	2
#_lambdas_(columns_for_phases)							
	1 #_Fishery:_1						
	1 #_Fishery:_2						
	1 #_Fishery:_3						
	0 #_OSP_CPUE:_4						
	1 #_TagAbundance:_5						
	1 #_TagCPUE:_6						
	0 #_discard:_1						
	0 #_discard:_2						
	0 #_discard:_3						
	0 #_discard:_4						
	0 #_discard:_5						
	0 #_discard:_6						
	0 #_meanbodyweight						
	0.1 #_lencomp:_1						
	0.1 #_lencomp:_2						
	0.1 #_lencomp:_3						
	0 #_lencomp:_4						
	0 #_lencomp:_5						
	0.1 #_lencomp:_6						
	1 #_agecomp:_1						
	1 #_agecomp:_2						
	1 #_agecomp:_3						
	0 #_agecomp:_4						
	0 #_agecomp:_5						
	0 #_agecomp:_6						
	1 #_size-age:_1						
	1 #_size-age:_2						
	0 #_size-age:_3						
	0 #_size-age:_4						
	0 #_size-age:_5						
	0 #_size-age:_6						
	1 #_init_equ_catch						
	1 #_recruitm:Deveations						
	1 #_parameter-priors						
	1 #_parameter-dev-vectors						
	1000 #_crashPenLambda						
	0.99 #_maximum_allowed_harvest_rate						

Table 20. Average Pearson residual by fishery (Trawl=1, Sport=2, Non-Trawl=3) by likelihood component.

Used	1
year	(All)

kind	fleet	season	mkt	Data						For Age & Len: effN/inputN
				Average of	Average of effN	Average ρ	Min of Pe	Max of Pε	StdDev of Pearson	
AGE	1	1	0	66	103	-0.026	-2.39	4.86	0.823880087	1.57
	2	1	0	312	343	0.027	-2.67	3.84	0.885559936	1.10
	3	1	0	116	157	0.004	-2.44	8.05	0.988462445	1.35
LEN	1	1	0	110	44	0.785	-3.78	14.38	2.878351254	0.40
	2	1	0	135	340	0.161	-3.08	7.96	1.137126017	2.52
	3	1	0	199	139	0.430	-3.72	9.64	2.065073952	0.70
	6	1	0	217	204	0.001	-2.71	4.79	1.166505276	0.94
L@A	2	1	0	42	1.2326	-0.454	-4.37	3.95	1.501360074	0.03

Table 21. Average Pearson residual by fishery (Trawl=Top 2 rows, Sport=Middle 2 rows, Non-Trawl Bottom 2 rows) , age and sex.

Average of Pearson		bin																												Grand Total
fleet	gender	3	4	5	6	7	8	9	10	11	12	13	14	15	16	17	18	19	20	21	22	23	24	25	30					
1	1	0.33	-0.35	-0.22	-0.38	-0.06	-0.02	0.29	-0.10	0.11	0.20	0.08	-0.30	-0.35	-0.40	-0.24	-0.45	-0.56	-0.44	-0.49	-0.62	-0.31	-0.29	-0.63	-0.16	-0.20				
	2	1.95	-0.19	0.00	0.21	0.64	1.01	0.82	0.43	-0.20	0.24	0.24	-0.13	-0.04	-0.08	-0.20	-0.26	-0.27	-0.19	0.23	0.00	-0.13	-0.03	-0.04	0.03	0.12				
2	1	-0.22	0.00	0.17	0.05	0.16	0.59	0.46	0.56	0.53	0.46	0.32	0.10	0.26	-0.01	-0.08	-0.05	-0.18	-0.27	-0.25	-0.43	-0.29	-0.42	-0.33	0.60	0.10				
	2	-0.63	-0.25	0.04	-0.02	-0.09	-0.09	-0.68	-0.90	-0.64	-0.81	-0.43	-0.28	0.02	-0.05	0.26	0.23	0.25	0.58	0.45	0.25	0.36	0.40	0.47	0.47	-0.04				
3	1	-0.15	0.73	0.80	0.24	0.25	0.09	0.22	-0.36	-0.09	0.21	0.48	0.03	0.30	0.28	-0.10	0.00	-0.29	-0.32	-0.56	0.09	-0.57	-0.40	-0.47	1.25	0.10				
	2	0.00	-0.24	0.58	-0.05	-0.31	-0.29	-0.58	-0.25	-0.68	-0.24	-0.05	-0.10	-0.10	-0.30	0.05	-0.16	-0.02	0.19	0.11	0.02	0.15	-0.01	0.05	0.82	-0.07				
Grand Total		-0.20	-0.02	0.24	0.00	0.09	0.25	0.08	-0.10	-0.13	-0.02	0.07	-0.12	0.02	-0.09	-0.03	-0.08	-0.12	0.01	0.02	-0.08	-0.02	0.00	0.06	0.47	0.01				

Table 22. Model sensitivity by likelihood component to rates of natural mortality relative to that assumed in the STAR base model. Values represent the change in likelihood relative to the base models such that negative values indicate a better fit. Female natural mortality rates for ages less than 11 are assumed to be equal to that assumed for males.

Total Likelihood		Female Natural Mortality Rate										
		0.1	0.12	0.14	0.16	0.18	0.2	0.22	0.24	0.26	0.28	0.3
Male Natural Mortality Rate	0.1	270.0	186.0	128.4	90.6	67.2	54.2	48.8	49.2	54.1	62.4	73.6
	0.12	226.1	140.6	84.5	48.5	26.2	13.6	16.4	8.1	12.4	20.0	30.5
	0.14	205.1	124.0	70.6	35.7	13.0	-0.9	-8.1	-10.0	-7.5	-1.6	7.1
	0.16	203.4	127.5	76.5	41.1	16.5	0.0	-10.0	-14.7	-15.0	-11.6	-5.1
	0.18	216.3	144.4	95.1	58.6	31.3	11.4	-2.2	-10.3	-12	-13.5	-9.9
	0.2	240.0	171.6	122.8	89	54.6	30.9	13.4	1.3	-6.0	-9.2	-8.7
	0.22	272.4	206.4	112.8	102.7	90.0	57.4	33	19.2	7.8	0.7	-2.4
Fit to Tag Abundance		0.1	0.12	0.14	0.16	0.18	0.2	0.22	0.24	0.26	0.28	0.3
Male Natural Mortality Rate	0.1	127.1	95.1	71.4	54.9	43.7	35.9	30.5	26.6	23.7	21.5	19.8
	0.12	97.1	62.1	40.2	26.9	18.9	13.8	7.4	8.3	6.8	5.7	4.9
	0.14	72.1	39.9	21.8	12.2	7.0	3.9	2.1	0.9	0.1	-0.3	-0.7
	0.16	54.1	26.3	11.9	5.2	1.8	0.0	-1.0	-1.5	-1.8	-1.9	-2.0
	0.18	41.7	18.1	6.8	2.0	0.0	-0.9	-1.3	-1.4	-1	-1.2	-1.1
	0.2	33.1	13.5	4.3	2.1	-0.1	-0.3	-0.1	0.2	0.5	0.8	1.1
	0.22	27.5	10.9	2.5	2.8	3.2	1.5	2	2.7	3.3	3.8	4.2
Fit to Tag CPUE		0.1	0.12	0.14	0.16	0.18	0.2	0.22	0.24	0.26	0.28	0.3
Male Natural Mortality Rate	0.1	26.4	22.6	19.3	16.7	14.6	13.0	11.8	10.8	10.0	9.4	9.0
	0.12	22.9	17.9	13.8	10.8	8.6	7.0	5.8	4.9	4.3	3.8	3.4
	0.14	19.4	13.7	9.3	6.2	4.2	2.7	1.7	1.0	0.5	0.1	-0.1
	0.16	16.3	10.5	6.0	3.0	1.2	0.0	-0.8	-1.3	-1.7	-2.0	-2.2
	0.18	13.6	7.9	3.6	1.0	-0.7	-1.6	-2.3	-2.7	-3	-3.2	-3.3
	0.2	11.5	5.9	2.2	0	-1.8	-2.5	-3.0	-3.3	-3.5	-3.6	-3.7
	0.22	9.8	4.6	-3.7	-3.6	-3.5	-2.9	-3	-3.4	-3.5	-3.6	-3.6
Fit to all Indices		0.1	0.12	0.14	0.16	0.18	0.2	0.22	0.24	0.26	0.28	0.3
Male Natural Mortality Rate	0.1	153.4	117.7	90.7	71.6	58.3	48.9	42.2	37.4	33.7	30.9	28.8
	0.12	120.0	80.0	54.0	37.7	27.5	20.8	13.1	13.3	11.1	9.5	8.3
	0.14	91.6	53.7	31.0	18.5	11.1	6.6	3.8	1.9	0.7	-0.2	-0.8
	0.16	70.4	36.8	17.9	8.2	3.0	0.0	-1.8	-2.8	-3.5	-3.9	-4.2
	0.18	55.4	26.0	10.5	3.0	-0.7	-2.6	-3.6	-4.1	-4	-4.4	-4.4
	0.2	44.6	19.5	6.5	2.3	-1.8	-2.8	-3.1	-3.1	-3.0	-2.8	-2.6
	0.22	37.3	15.5	-1.2	-0.8	-0.3	-1.5	-1	-0.7	-0.2	0.2	0.6

Note: Square indicates the Base Model and bold font indicates best fit.

Table 22. Continued.

Fit to Length Composition		Female Natural Mortality Rate										
		0.1	0.12	0.14	0.16	0.18	0.2	0.22	0.24	0.26	0.28	0.3
Male Natural Mortality Rate	0.1	2.0	-1.6	-3.1	-3.2	-2.4	-1.1	0.5	2.4	4.3	6.3	8.3
	0.12	5.6	0.8	-1.5	-2.3	-2.0	-0.9	17.1	2.3	4.2	6.2	8.1
	0.14	8.0	4.6	1.0	-0.7	-1.1	-0.5	0.7	2.2	4.0	5.9	7.9
	0.16	8.2	9.4	4.1	1.2	0.0	0.0	0.8	2.0	3.6	5.4	7.3
	0.18	9.1	10.7	7.5	3.3	1.1	0.4	0.7	1.7	-8.4	4.7	6.6
	0.2	10.7	11.5	11.6	5.5	2.2	0.7	0.5	1.1	2.2	3.7	5.5
	0.22	12.7	13.0	10.3	8.3	4.8	0.8	-18.4	0.2	1.1	2.4	4.1
Fit to Age Composition		0.1	0.12	0.14	0.16	0.18	0.2	0.22	0.24	0.26	0.28	0.3
Male Natural Mortality Rate	0.1	89.8	58.9	35.4	19.4	9.6	5.0	4.7	8.0	14.3	23.1	34.1
	0.12	91.0	57.5	32.4	14.4	2.2	-5.0	-18.6	-7.0	-2.9	3.9	13.1
	0.14	102.8	66.8	40.8	20.2	4.7	-6.0	-12.2	-14.4	-13.1	-8.9	-2.0
	0.16	126.3	83.4	57.1	33.7	14.5	0.0	-10.0	-15.8	-17.8	-16.5	-12.3
	0.18	155.7	111.2	79.6	53.8	30.9	12.4	-1.7	-11.3	46.3	-19.1	-17.9
	0.2	190.0	145.1	106.8	57.4	53.7	31.0	12.7	-1.2	-10.9	-16.7	-19.0
	0.22	228.5	183.0	59.1	55.7	54.0	55.8	114.8	14.6	0.7	-9.2	-15.3
Depletion Level		0.10	0.12	0.14	0.16	0.18	0.20	0.22	0.24	0.26	0.28	0.3
Male Natural Mortality Rate	0.1	0.05	0.06	0.08	0.11	0.13	0.15	0.17	0.19	0.21	0.23	0.300
	0.12	0.05	0.08	0.12	0.15	0.19	0.23	0.25	0.29	0.32	0.34	0.24
	0.14	0.07	0.11	0.16	0.22	0.27	0.32	0.37	0.41	0.45	0.48	0.37
	0.16	0.08	0.13	0.21	0.29	0.36	0.43	0.49	0.54	0.58	0.62	0.51
	0.18	0.10	0.17	0.26	0.35	0.45	0.53	0.60	0.67	0.72	0.76	0.65
	0.2	0.12	0.20	0.29	0.46	0.53	0.63	0.72	0.79	0.85	0.90	0.80
	0.22	0.14	0.23	0.84	0.86	0.87	0.73	1.27	0.90	0.97	1.02	0.94
Note: Square indicates the Base Model and bold font indicates best fit.												
B0		0.10	0.12	0.14	0.16	0.18	0.20	0.22	0.24	0.26	0.28	0.3
Male Natural Mortality Rate	0.1	2620	2458	2301	2159	2034	1923	1825	1738	1661	1592	1531
	0.12	2700	2548	2404	2281	2171	2071	1986	1901	1827	1761	1701
	0.14	2741	2579	2486	2396	2315	2238	2164	2096	2031	1971	1915
	0.16	2780	2577	2540	2513	2474	2433	2389	2344	2298	2253	2207
	0.18	2809	2615	2583	2620	2656	2674	2683	2685	2676	2670	2652
	0.2	2836	2652	2574	2725	2875	2992	3102	3205	3297	3378	3443
	0.22	2856	2684	13213	10728	8357	3460	3792	4124	4496	4887	5283
Note: Square indicates the Base Model and bold font indicates best fit.												

Table 23. Comparison of Councils' default target fishing mortality rates and reference points between the STAR base model and STAT best fit model. The default target fishing mortality rate of FSPR=0.5 is used in this assessment for both models and that used for other Council managed rockfish species.

STAR Base Model Results

Unfished Stock	Value		
Age 3+ Biomass (B_0) (mt)	10,813		
Spawning Biomass SB_0 (mt)	2,429		
SPBio/Recruit (kg/fish)	0.780		
Age1 Recruitment (R_0) (1,000's)	3,113		
Steepness R_0_{S0}	0.6		

Exploited Stock	Reference points based on		
	Estimated MSY	SB_{40%}	SPR (SB_{0.5})
SPR (Spawning Biomass/Recruit)	0.413	0.400	0.400
F (Fishing Mortality Rate)	0.132	0.101	0.101
Exploitation Rate (Yield/Bsmry)	0.076	0.060	0.060
MSY (mt) or MSY proxy (mt)	377	361	361
Yield (mt)	718	972	972
SPBIO/SB(0)	29.6%	40.0%	40.0%
Age 3+ Biomass	4,947	6,012	6,012

STAT Best Fit Model Results

Unfished Stock	Value		
Age 3+ Biomass (B_0) (mt)	11,390		
Spawning Biomass SB_0 (mt)	2,321		
SPBio/Recruit (kg/fish)	0.687		
Age1 Recruitment (R_0) (1,000's)	3,377		
Steepness R_0_{S0}	0.6		

Exploited Stock	Reference points based on		
	Estimated MSY	SB_{40%}	SPR (SB_{0.5})
SPR (Spawning Biomass/Recruit)	0.418	0.400	0.40
F (Fishing Mortality Rate)	0.141	0.110	0.110
Exploitation Rate (Yield/Bsmry)	0.081	0.065	0.065
MSY (mt) or MSY proxy (mt)	423	408	408
Yield (mt)	700	928	928
SPBIO/SB(0)	30.1%	40.0%	40.0%
Age 3+ Biomass	5,218	6,264	6,264

Table 24. Comparison of ABC's, Spawning biomass and depletion between the STAR base (top) and STAT best fit model (bottom).

STAR Base Model

Year	2007	2008	2009	2010	2011	2012	2013	2014	2015	2016
ABC (mt)	394	377	361	350	345	344	346	350	354	357
Spawning Biomass (mt)	1064	1071	1060	1036	1005	977	956	944	940	943
% of Virgin	0.438	0.441	0.436	0.426	0.414	0.402	0.394	0.389	0.387	0.388

STAT "Best Fit" Model

Year	2007	2008	2009	2010	2011	2012	2013	2014	2015	2016
ABC (mt)	535	503	474	453	440	433	431	432	434	436
Spawning Biomass (mt)	1281	1267	1233	1182	1126	1074	1033	1005	989	984
% of Virgin	0.552	0.546	0.531	0.509	0.485	0.463	0.445	0.433	0.426	0.424

Figures

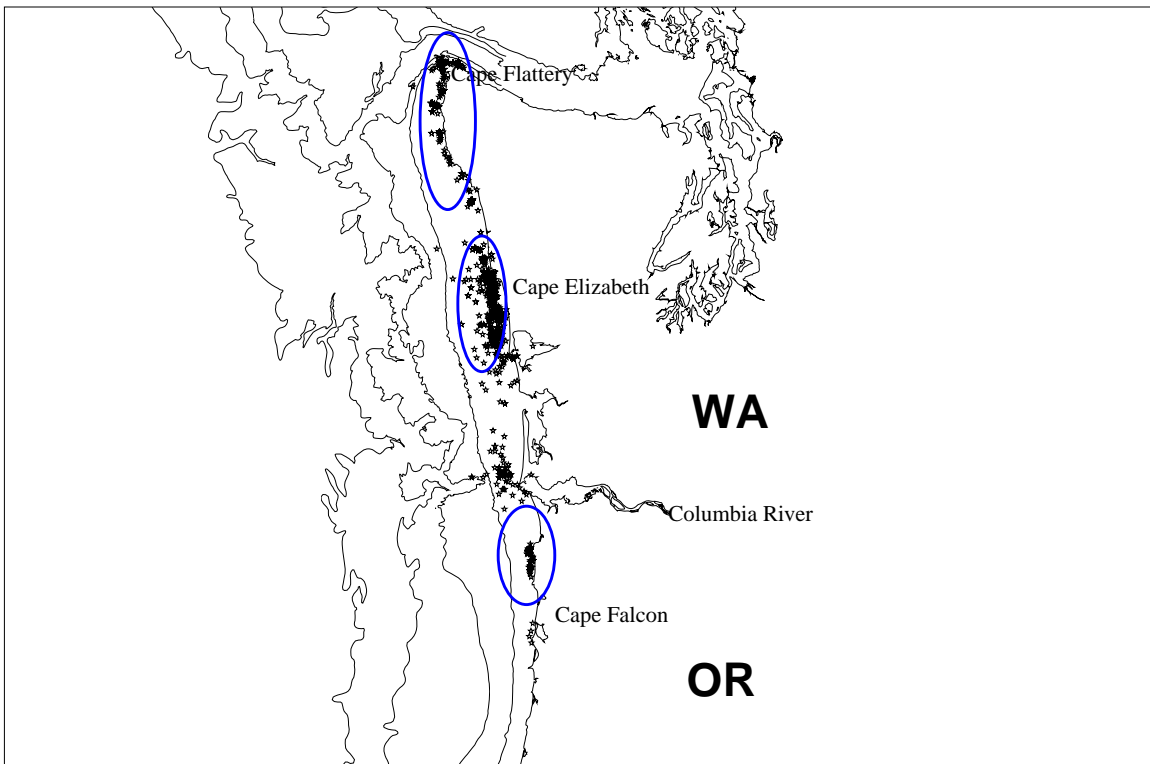
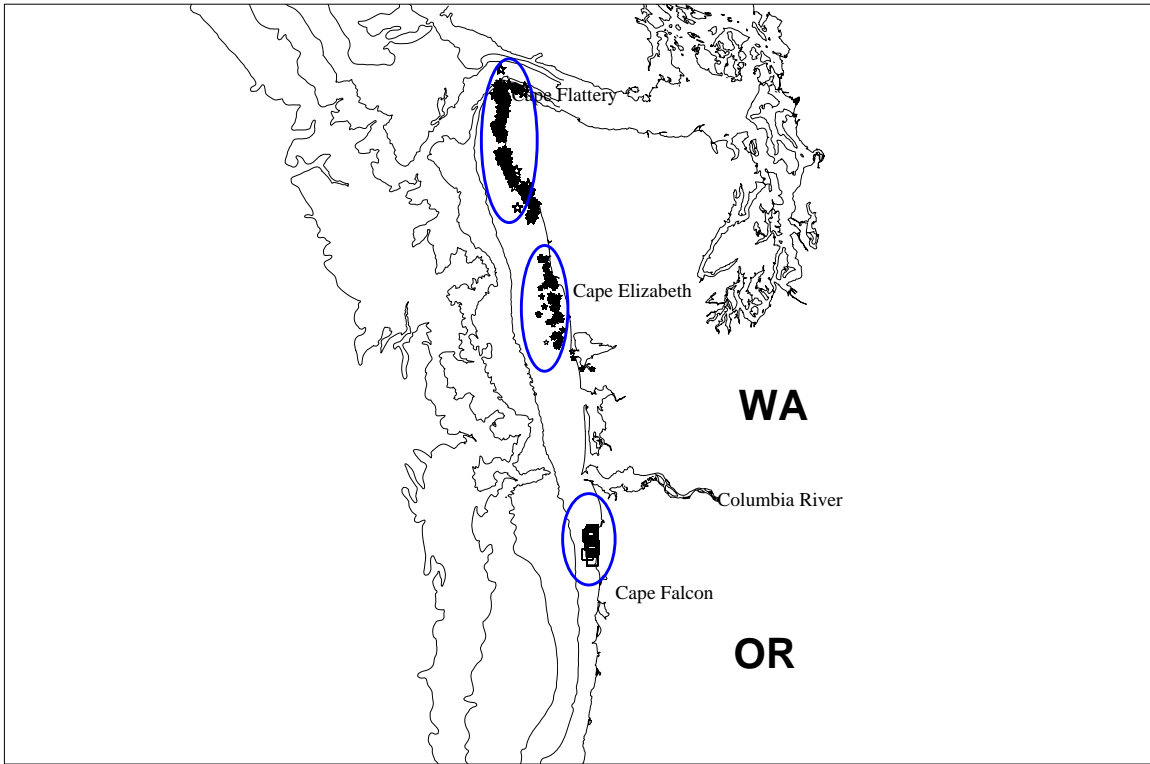

Figure 1. Location of black rockfish tag release area (top) and tag recovery locations (bottom).

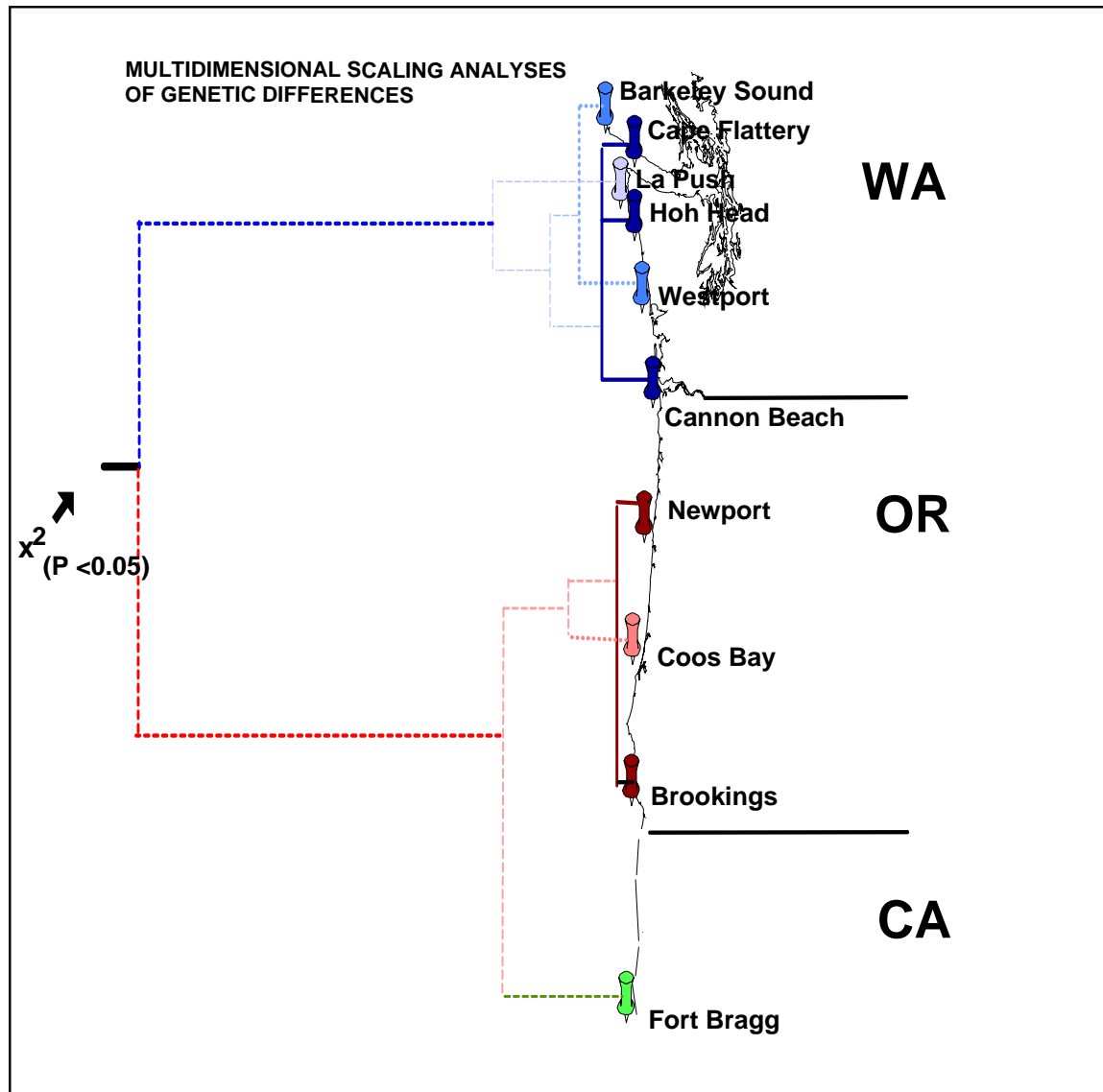

Figure 2. Dendrogram showing results of cluster analysis of ten black rockfish collections using Nei's (1978) unbiased genetic distance at 20 polymorphic loci.

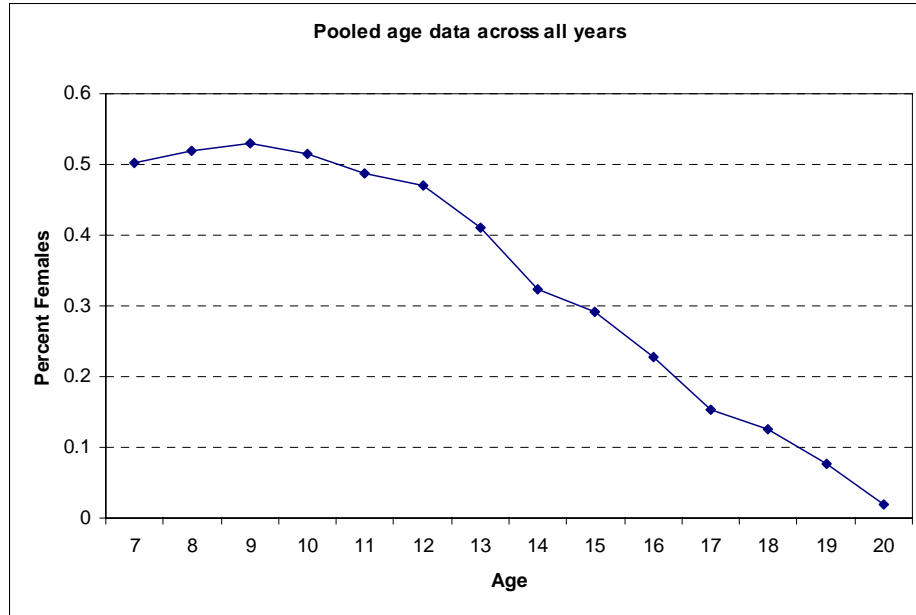

Figure 3. Relative abundance of females with age in pooled age data for Washington fisheries.

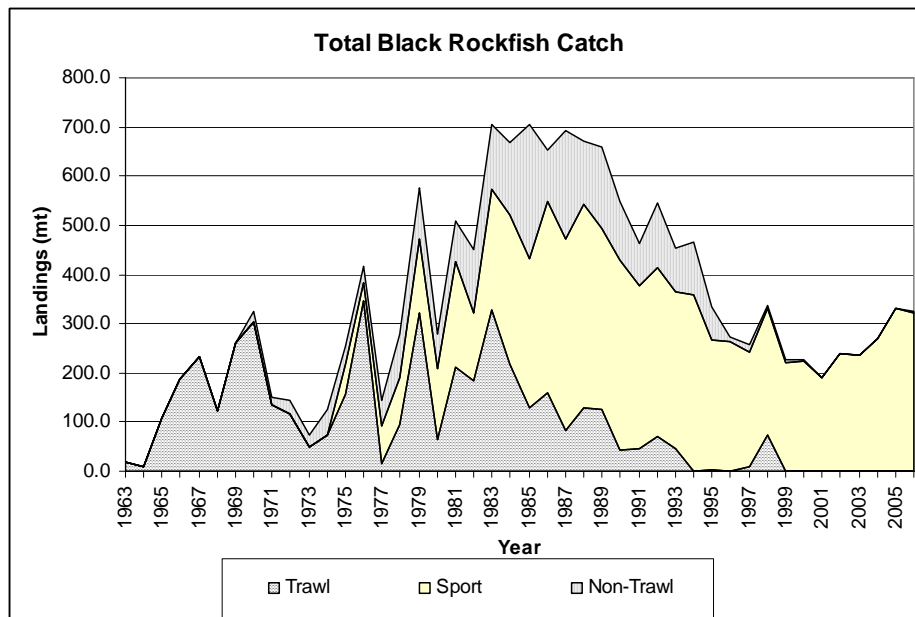

Figure 4. Total black rockfish catch by gear and year for areas North of Cape Falcon to the U.S. Canadian border.

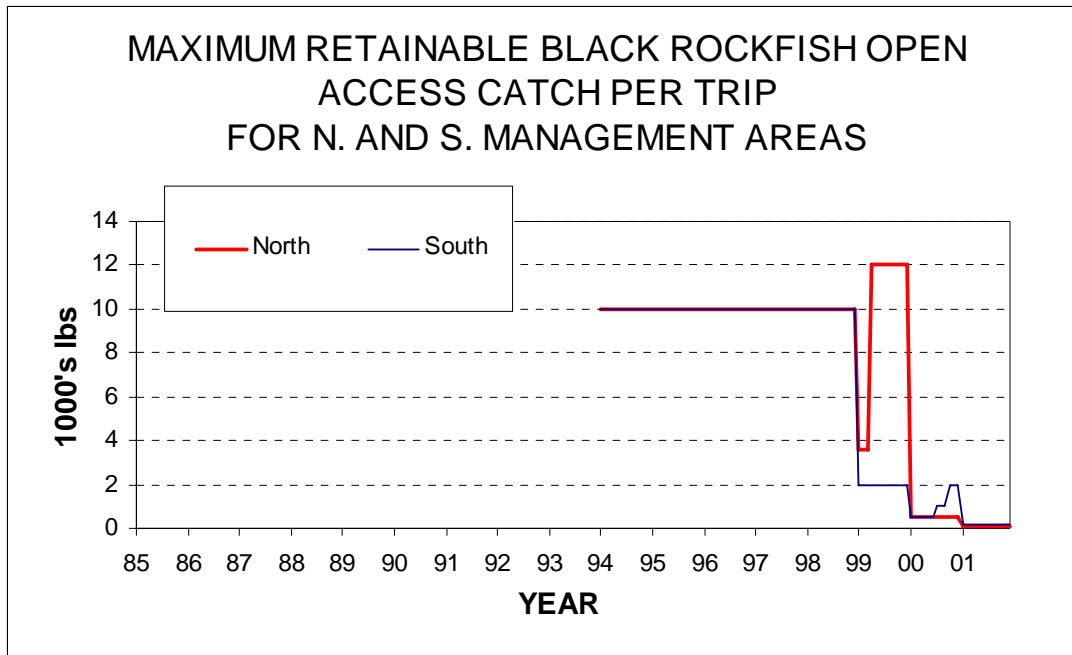

Figure 5. Regulation changes in commercial fisheries

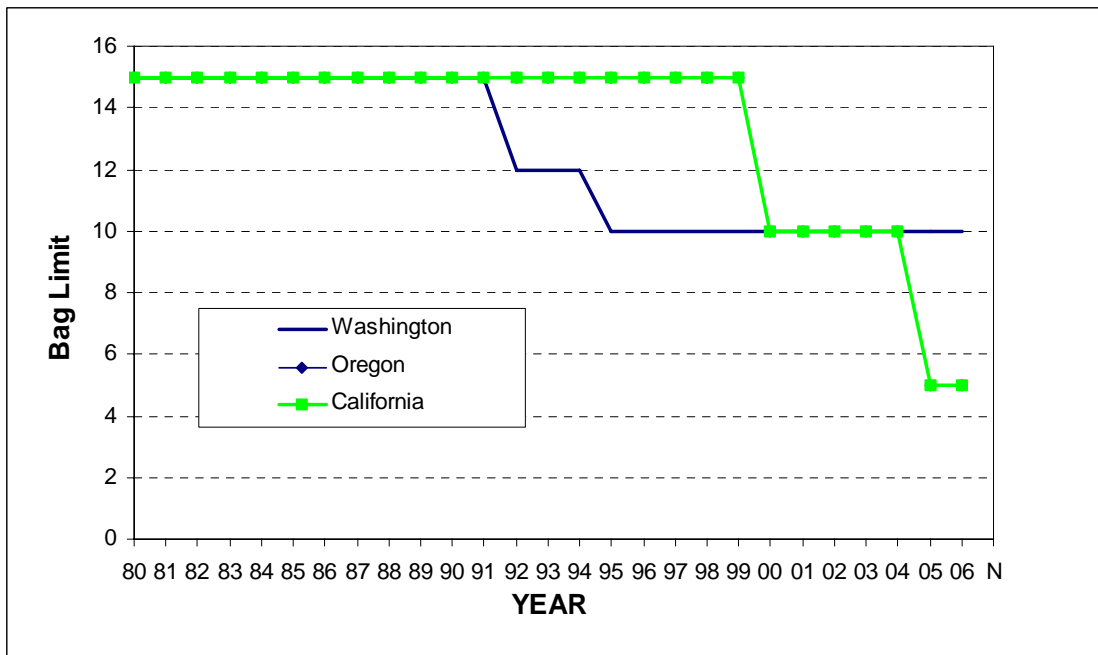

Figure 6. Maximum retainable rockfish catch per trip for the sport fisheries.

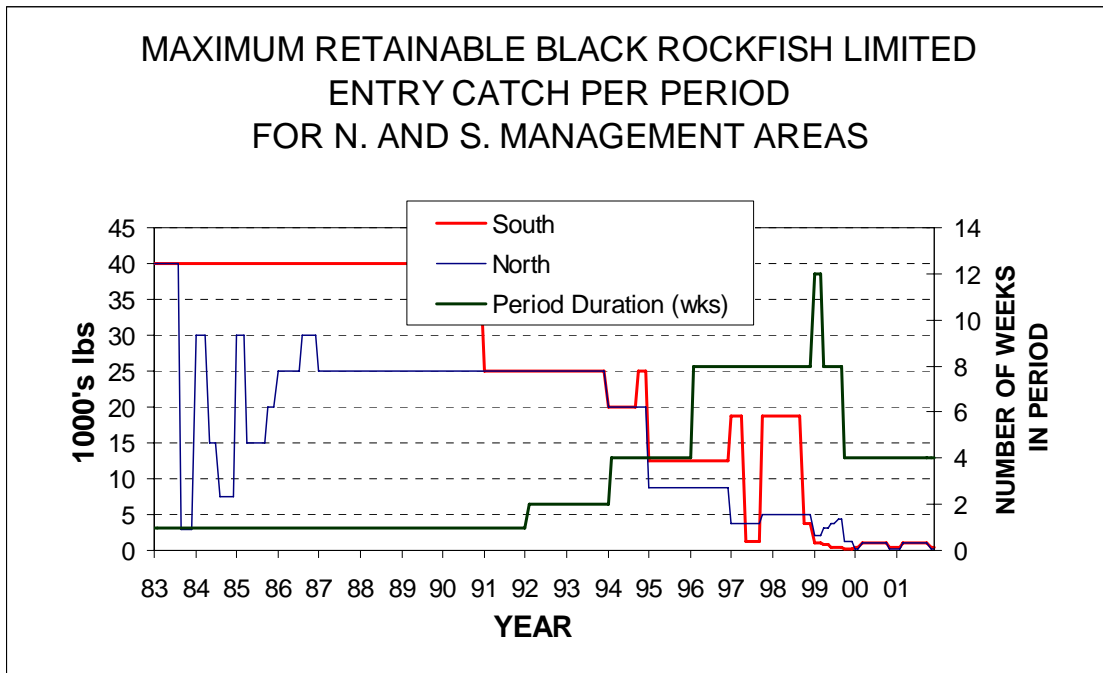

Figure 7. Maximum retainable black for the limited entry commercial fisheries.

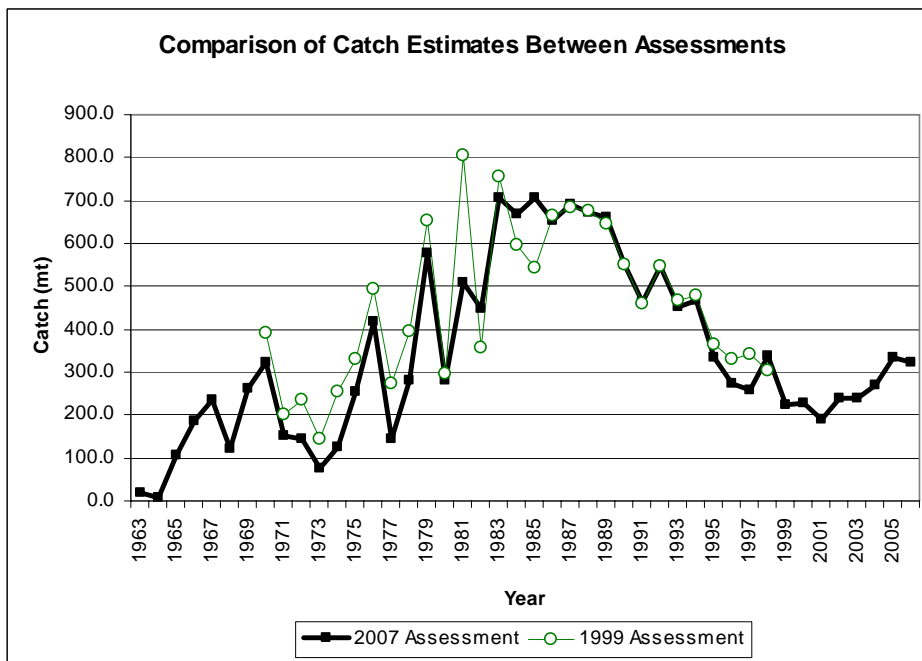

Figure 8. Comparison of catch estimates between the 1999 and the current assessment.

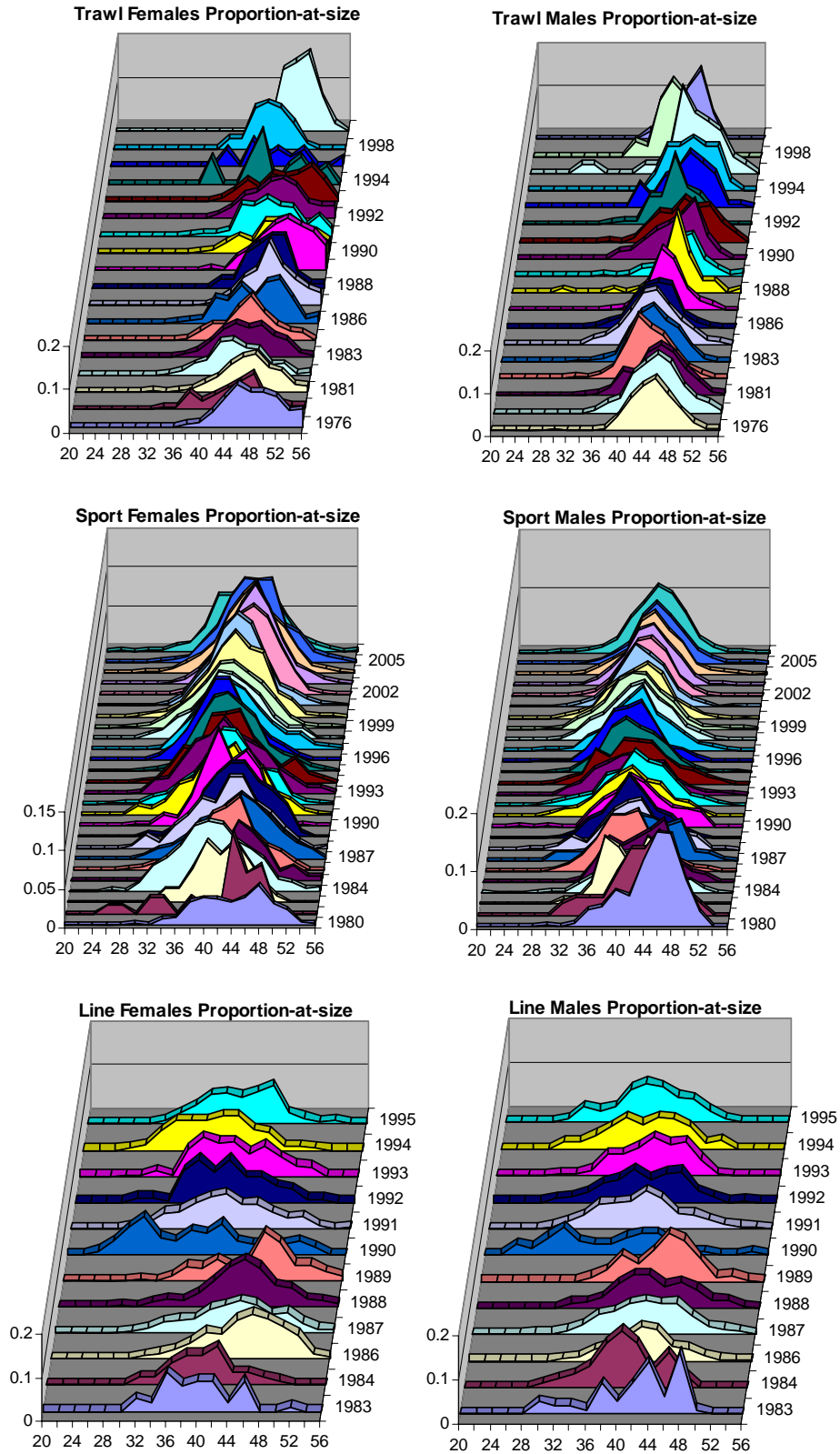

Figure 9. Proportion at size by sex and fisheries from 1984 to 2006.

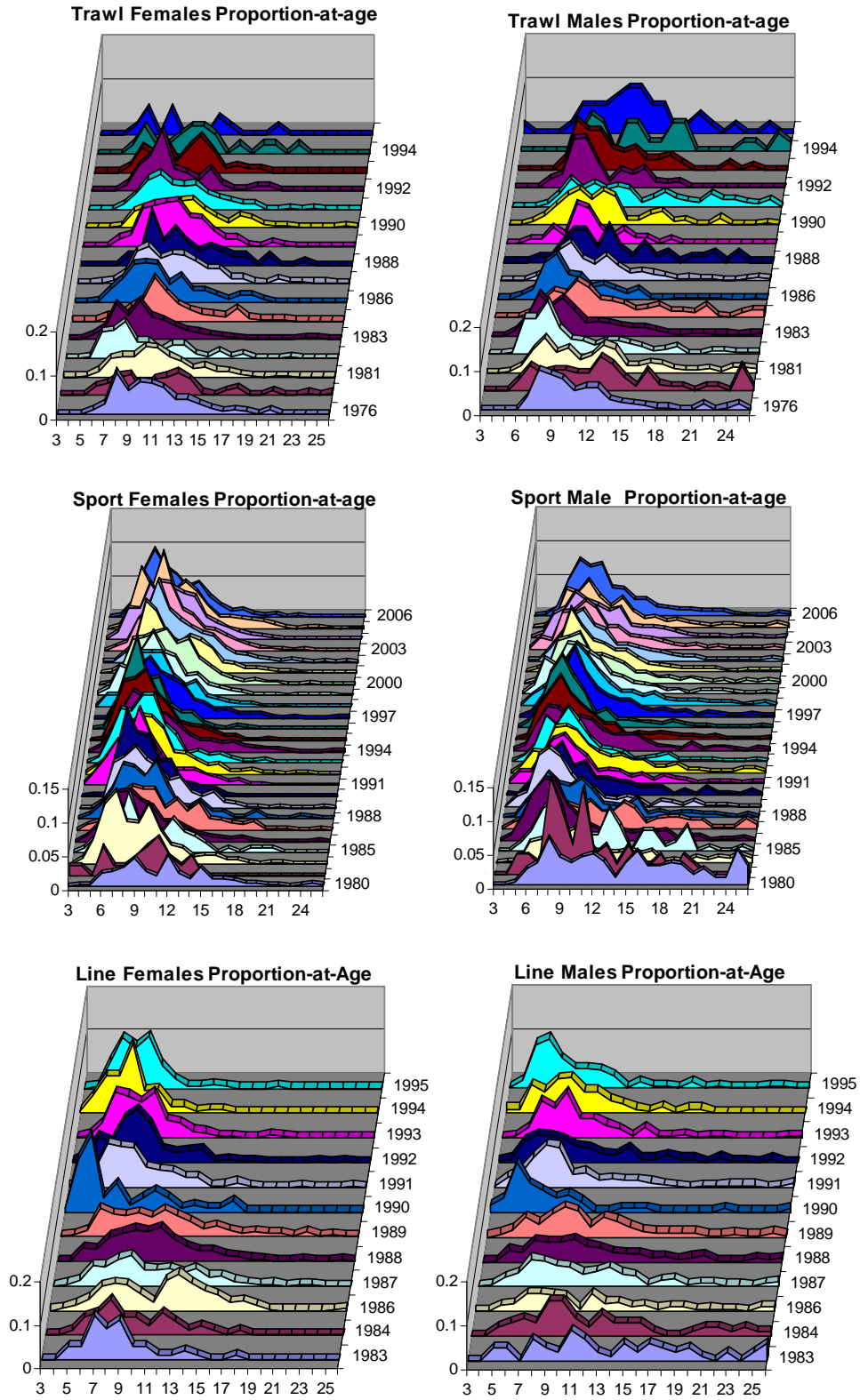

Figure 10. Proportion at age by sex and fisheries from 1984 to 2006.

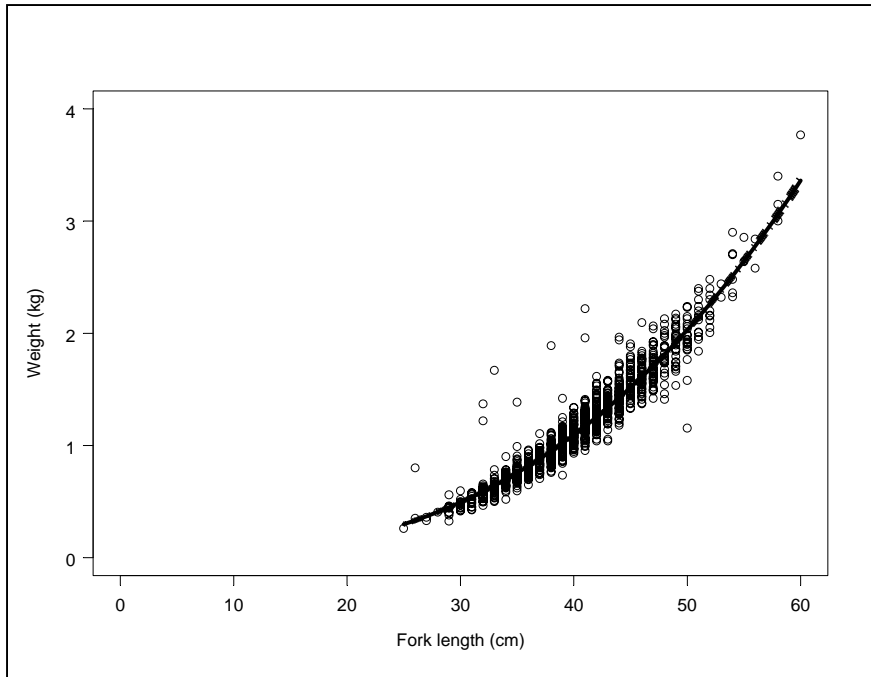
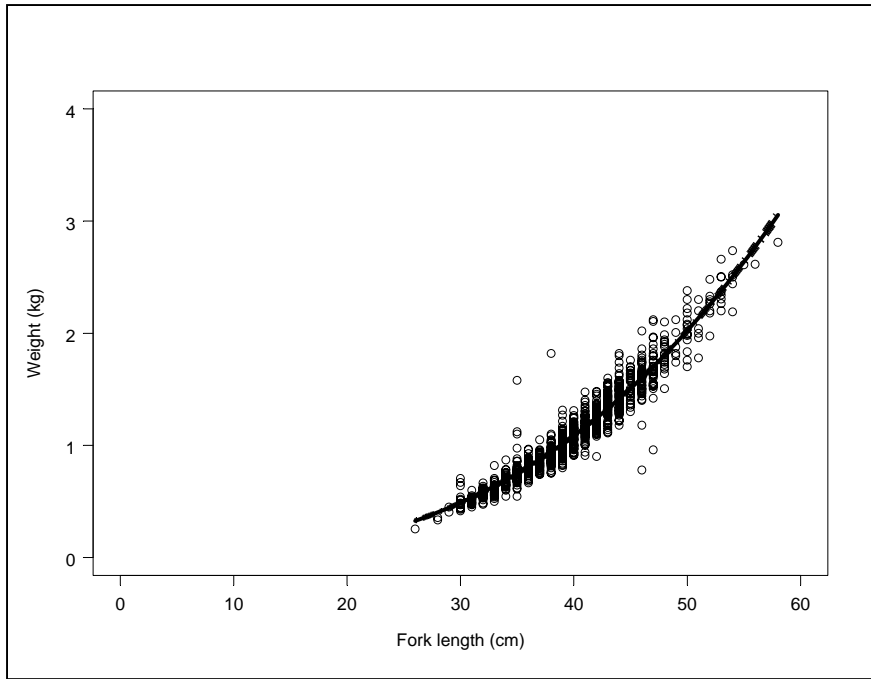

Figure 11. Scatter plot of fork length and weight of male (top panel) and female (bottom panel) black rockfish and the expected length weight relationship.

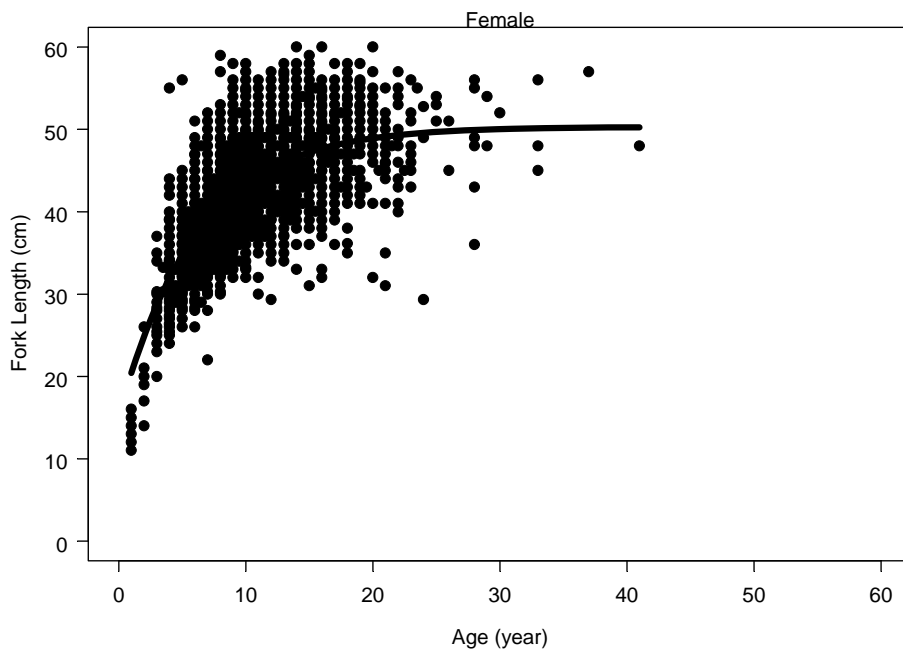
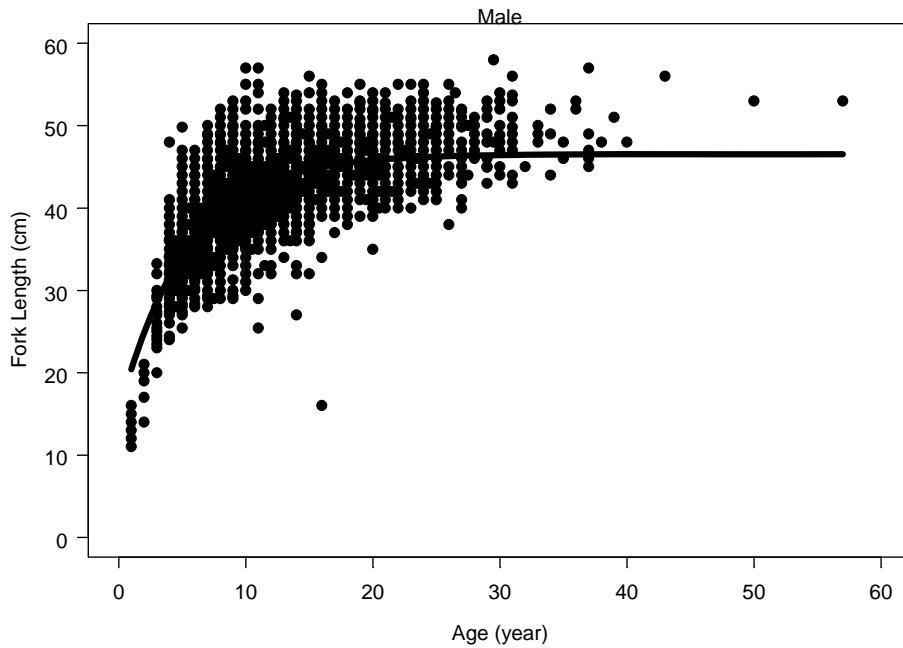

Figure 12. Scatter plots of male (top panel) and female (bottom panel) age and fork length data and the estimated growth curves.

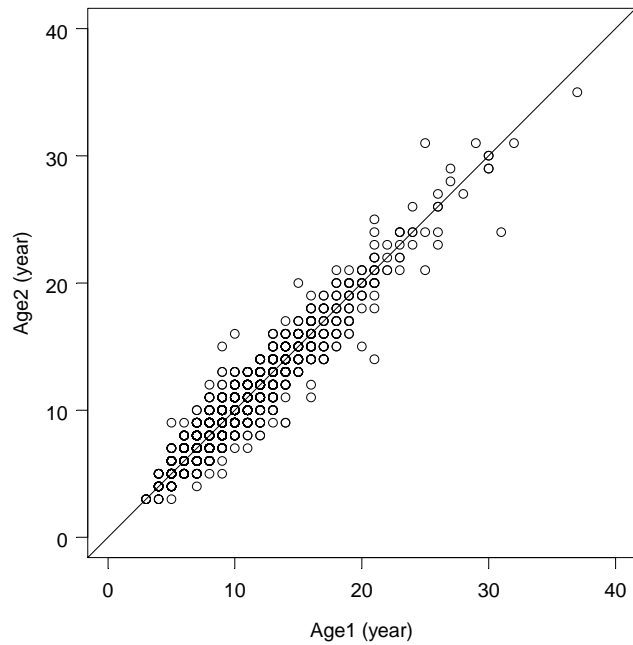

Figure 13. Scatter plot of age reading from two independent age readers and the expected relationship of age reading between the two age readers.

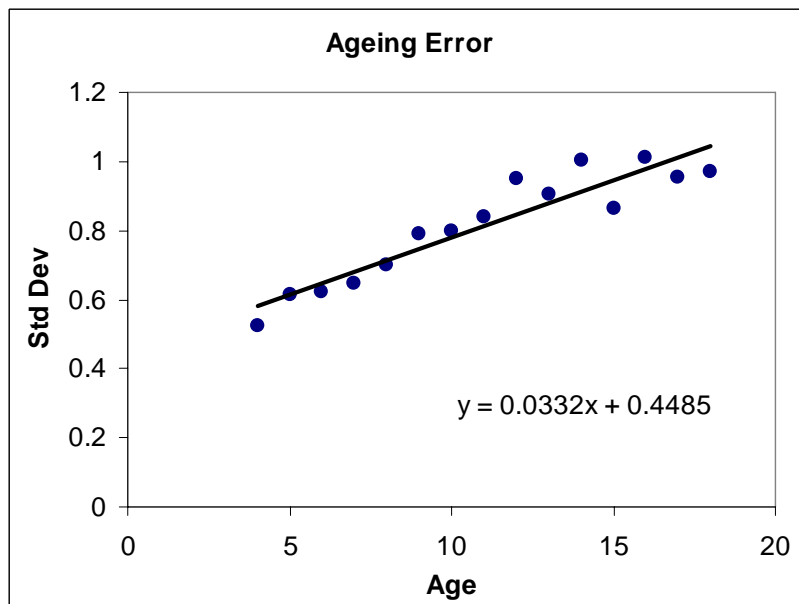

Figure 14. Standard deviation of ageing error.

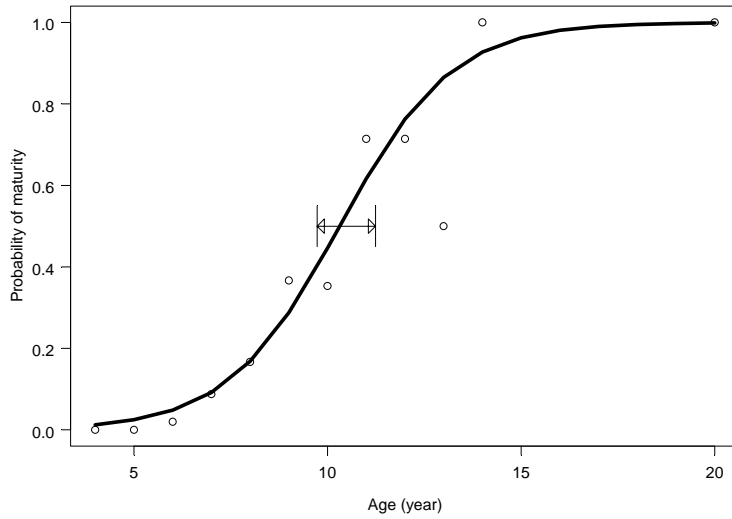

Figure 15. Plot of the estimated probability of maturity against the estimated age of female black rockfish. The intervals are the 95% confidence intervals estimated by bootstrapping.

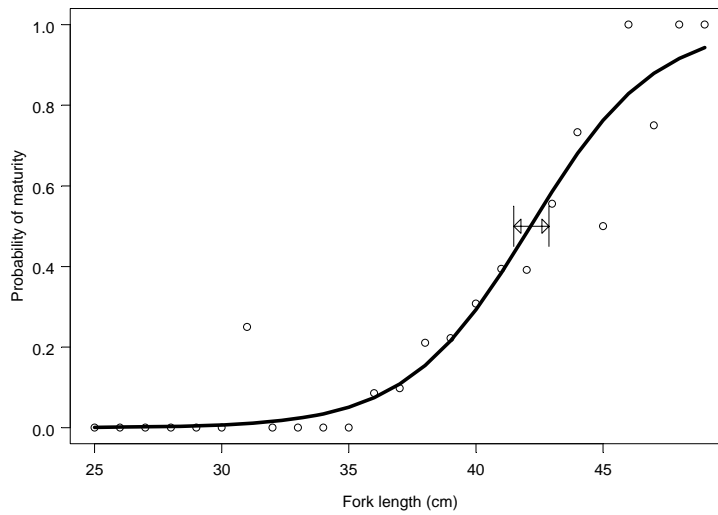

Figure 16. Plot of the estimated probability of maturity against the fork length of female black rockfish. The intervals are the 95% confidence intervals estimated by bootstrapping.

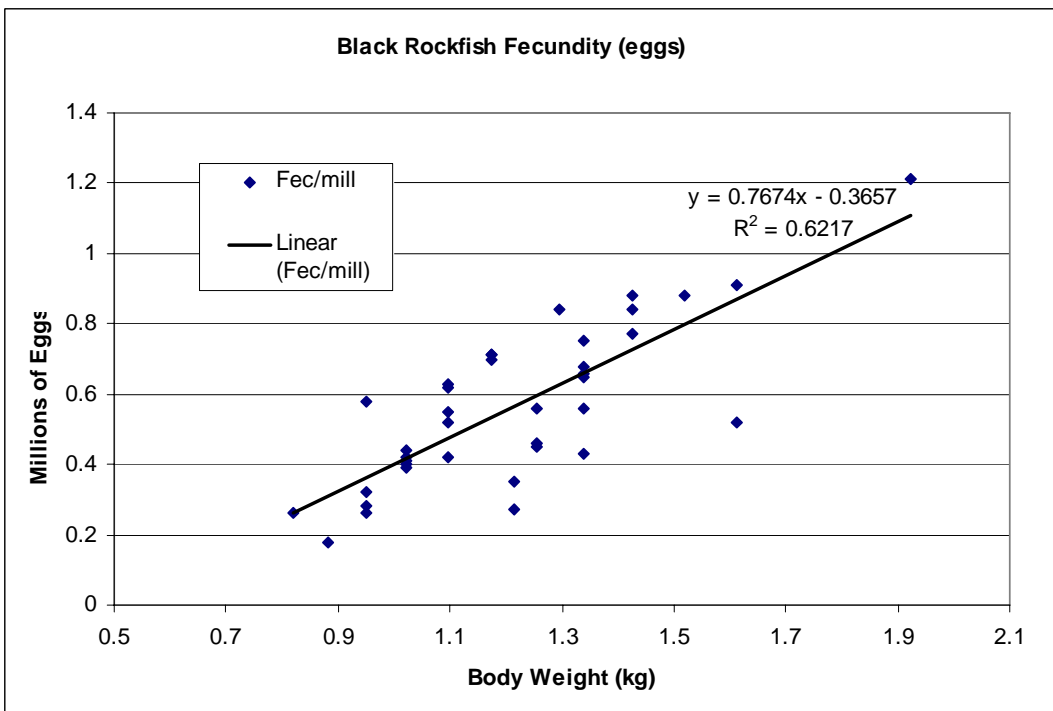
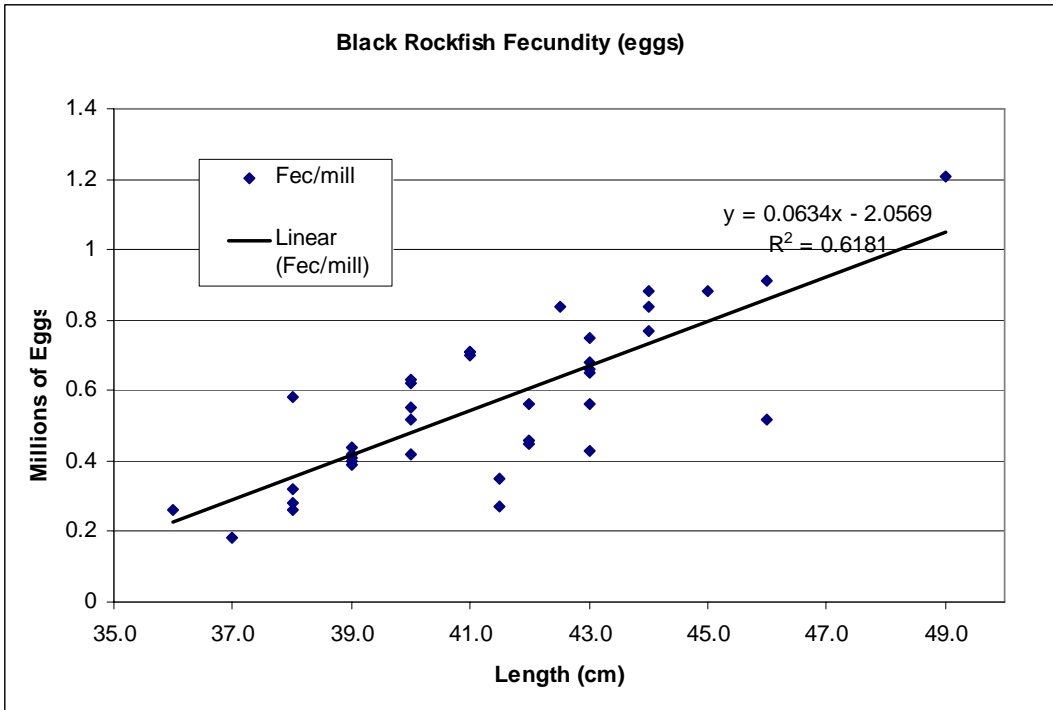

Figure 17. Relationship between fecundity and size (top panel) and fecundity and body weight (bottom panel).

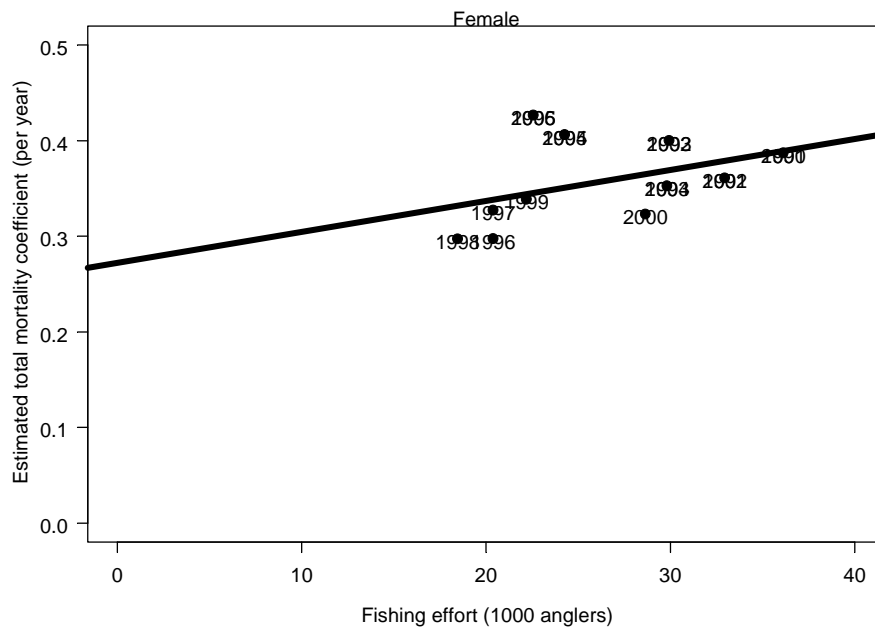
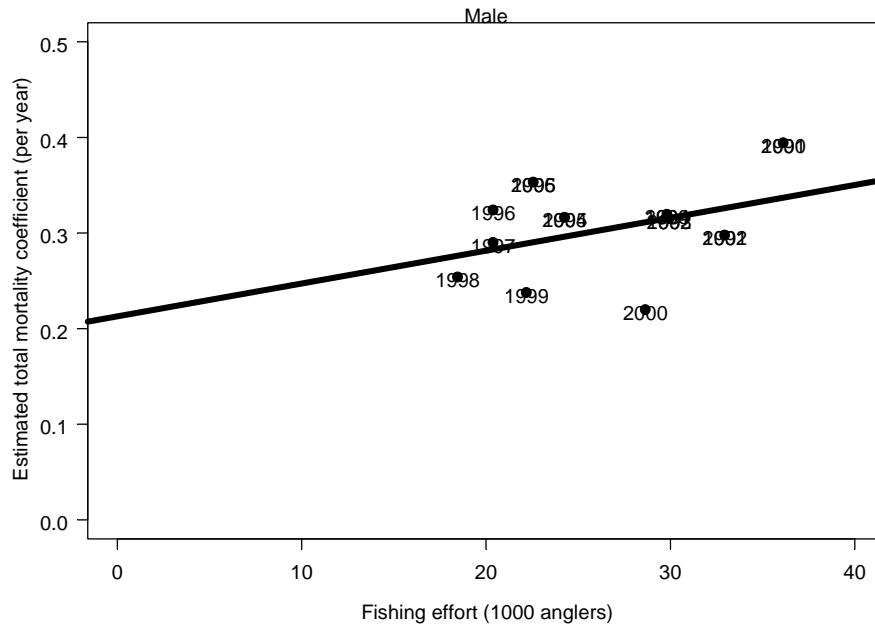

Figure 18. Plot of expected male (top panel) and female (bottom panel) estimated total mortality coefficients against total fishing effort. The estimated intercept in each sub graph was the estimated natural mortality.

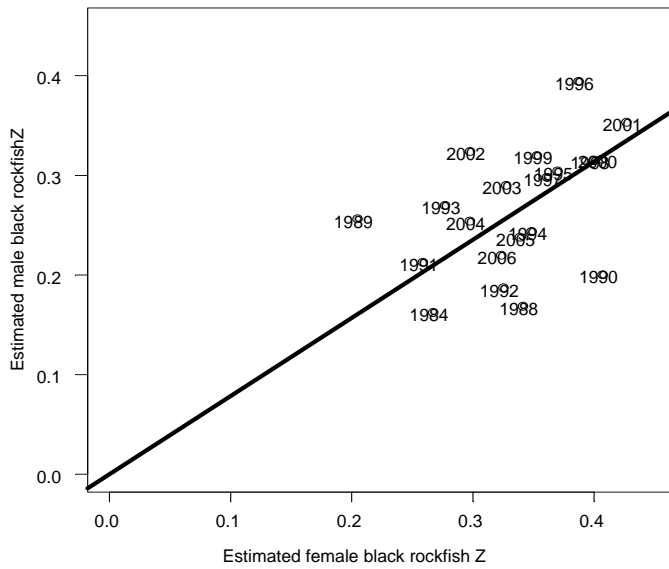

Figure 19. Scatter plot of estimated female black rockfish mortality coefficients versus estimated male black rockfish mortality coefficients, and the estimated linear relationship.



Figure 20. Time series plot of the estimated male and female black rockfish total mortalities.

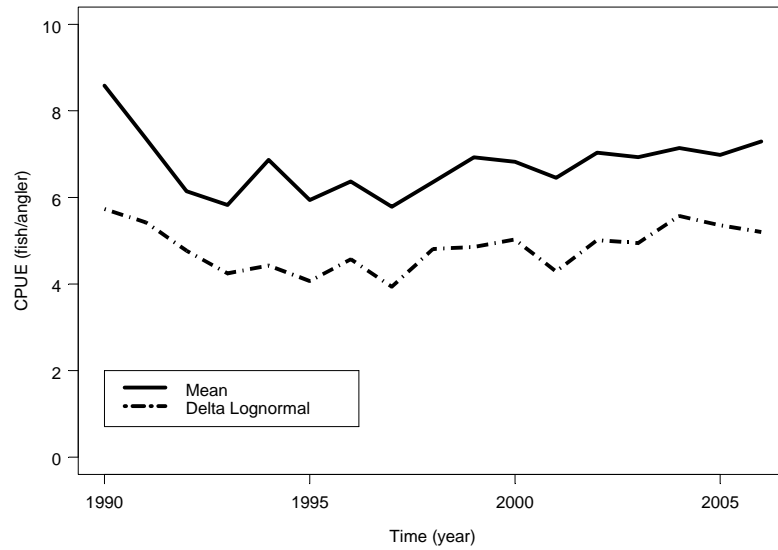

Figure 21. Time series plot of the estimated CPUEs of recreational survey data in all areas from 1990 to 2006. The estimated CPUEs were done by mean estimator and delta lognormal model.

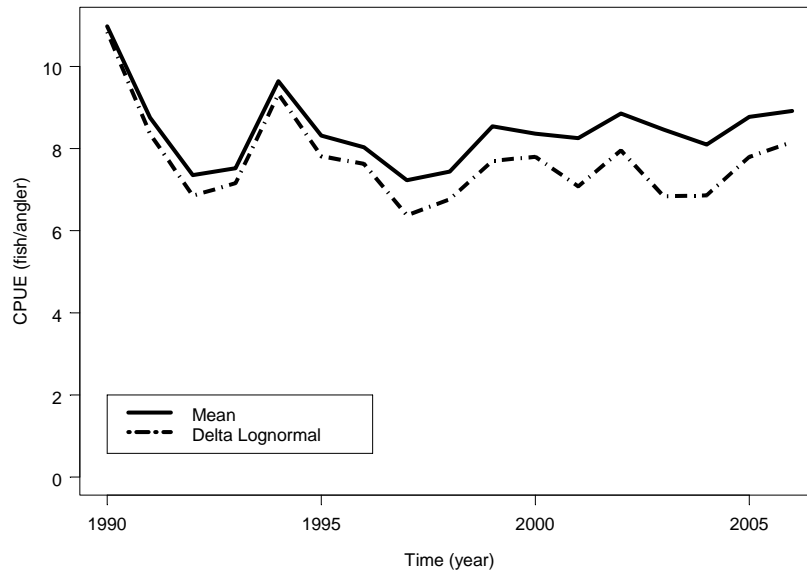

Figure 22. Time series plot of the estimated CPUEs of recreational survey data in Area 2 from 1990 to 2006. The estimated CPUEs were done by mean estimator and delta lognormal model.

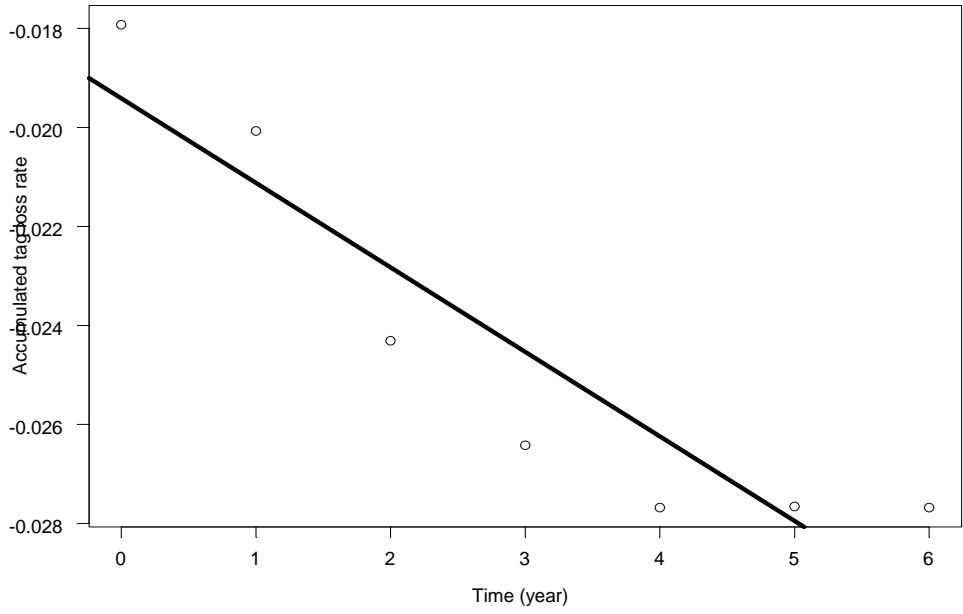

Figure 23. Plot of accumulated CWT tag lost rate with time.

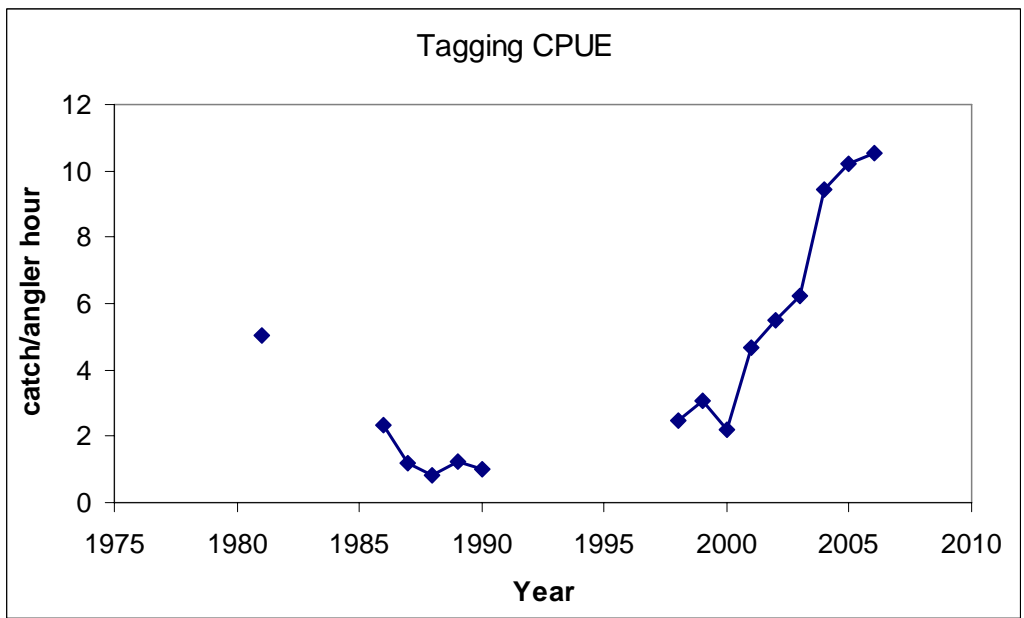

Figure 24. Time series of the tagging CPUE of the central Washington coast.

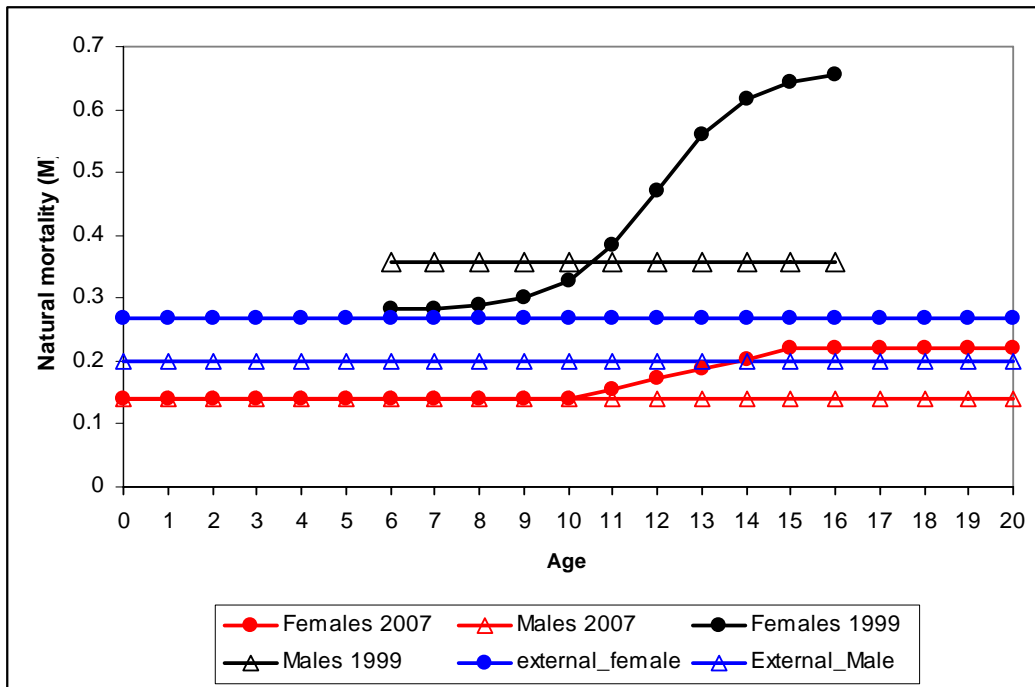

Figure 25. Comparison of natural mortality rates between males and females as defined in the STAT Best Fit Model. In the STAR base model Female natural mortality asymptotes at 0.20 at age 15 instead of 0.24 in the STAT Best Fit model.

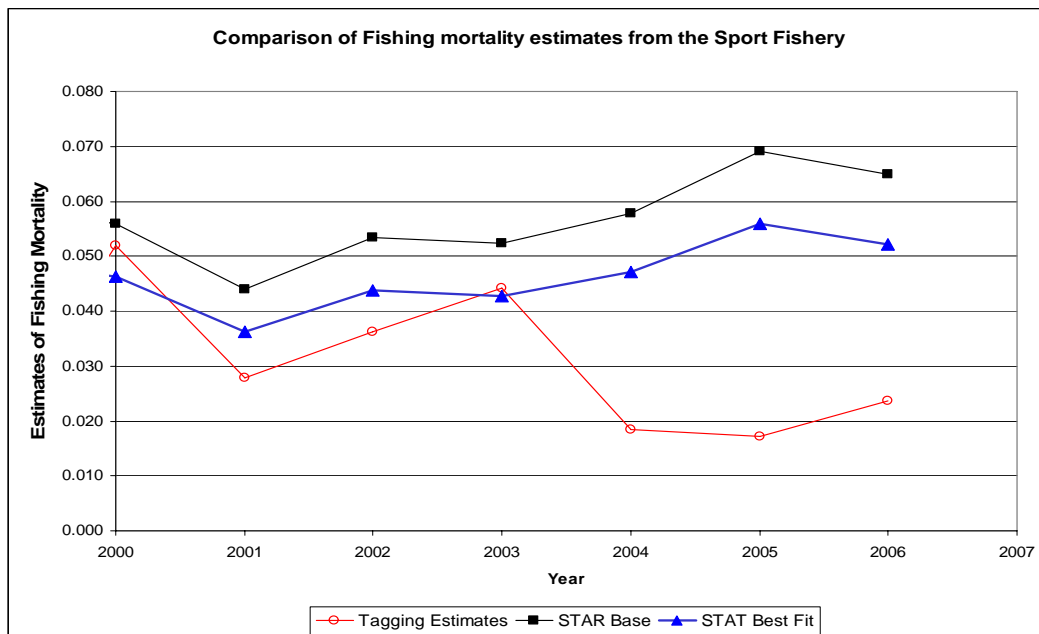

Figure 26. Comparison of fishing mortality rates estimated from STAR Base, STAT Best Fit model and the tagging model (assuming $M=0.2$ for both sexes).

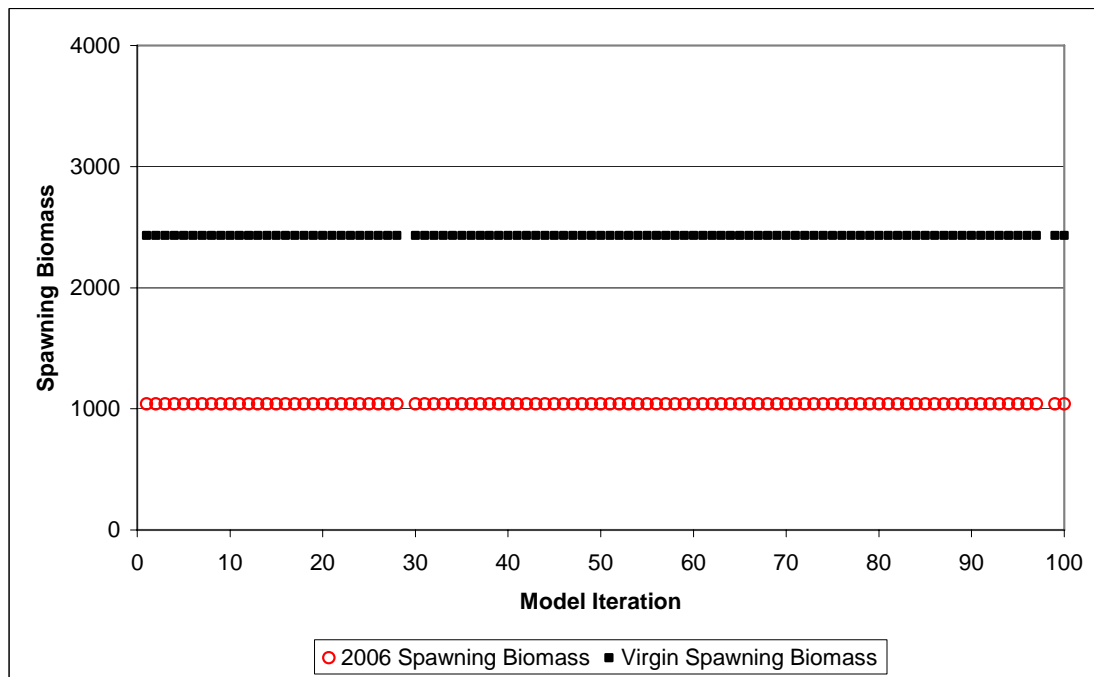
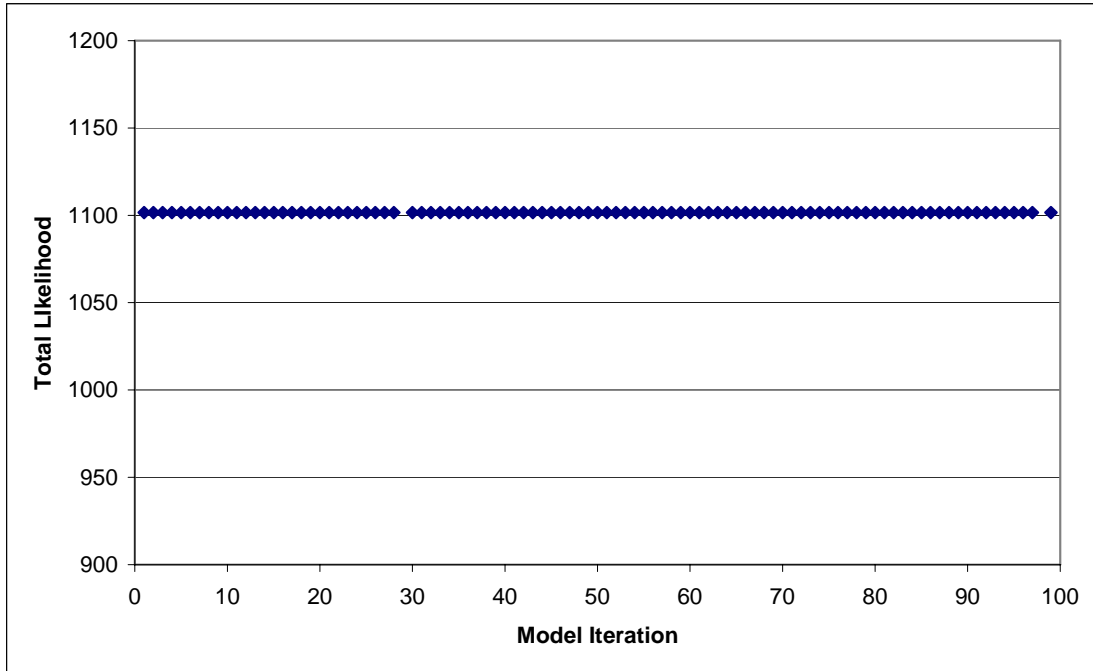

Figure 27. Convergence properties of the STAR base model.

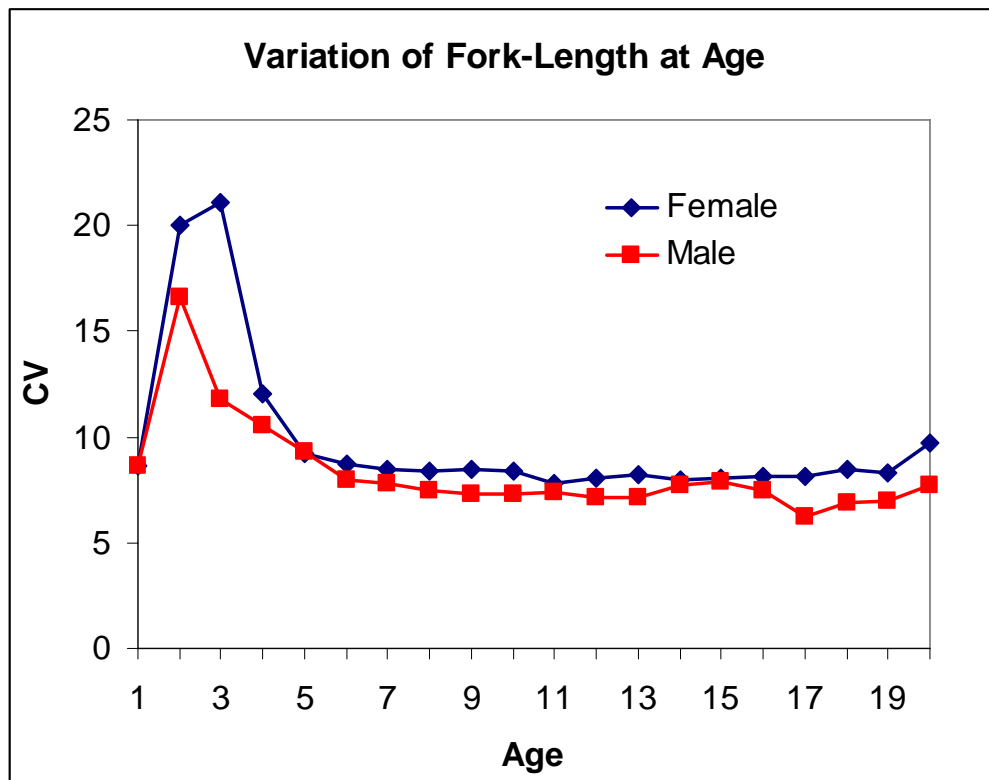

Figure 28. Variation in fork-length at age by sex.

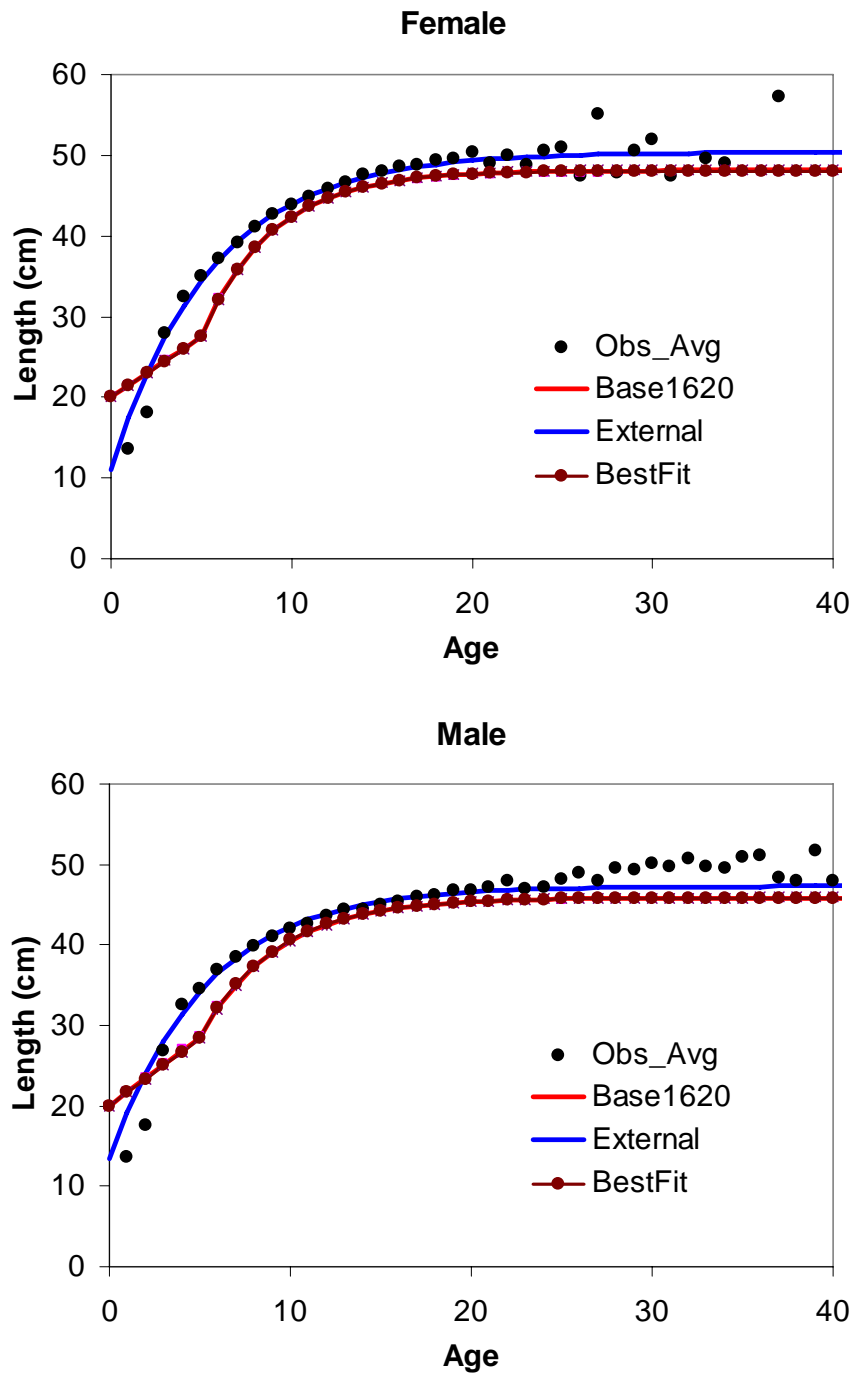

Figure 29. Comparison of growth curves estimated from STAR base, STAT best-fit model and external estimates to the mean size at observed age.

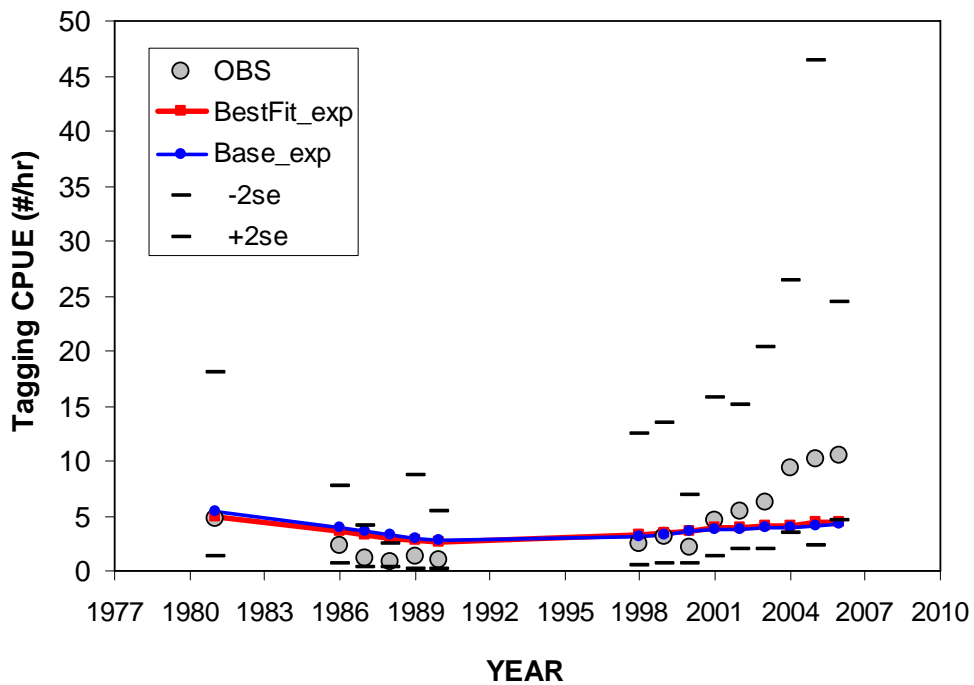
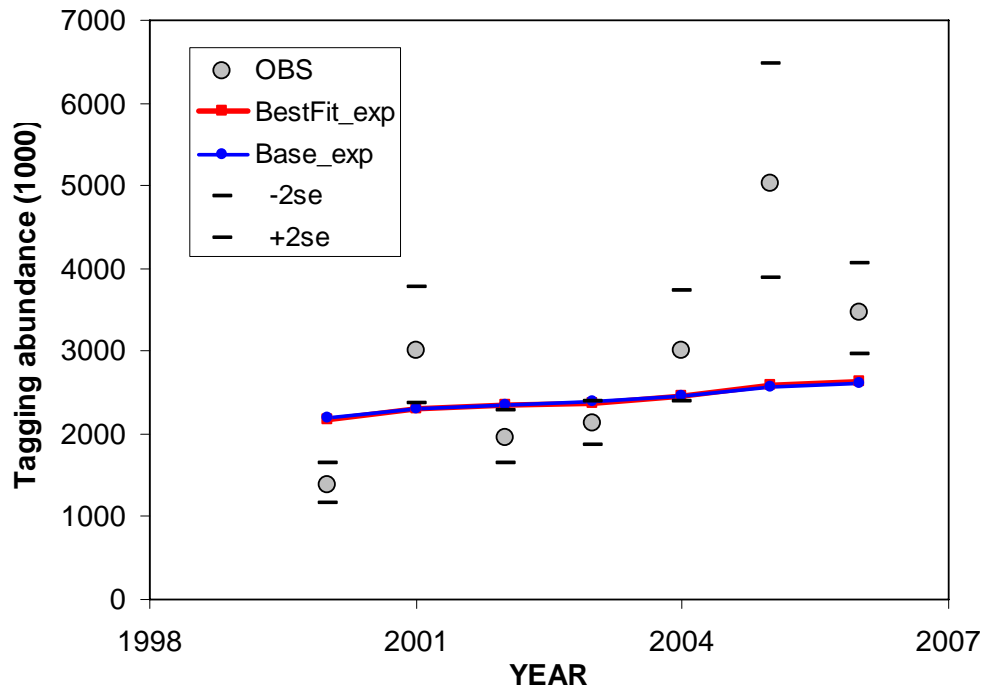

Figure 30. STAR base and STAT “best fit” model fit to tagging abundance (top panel) and tagging CPUE (bottom panel) data by fishery.

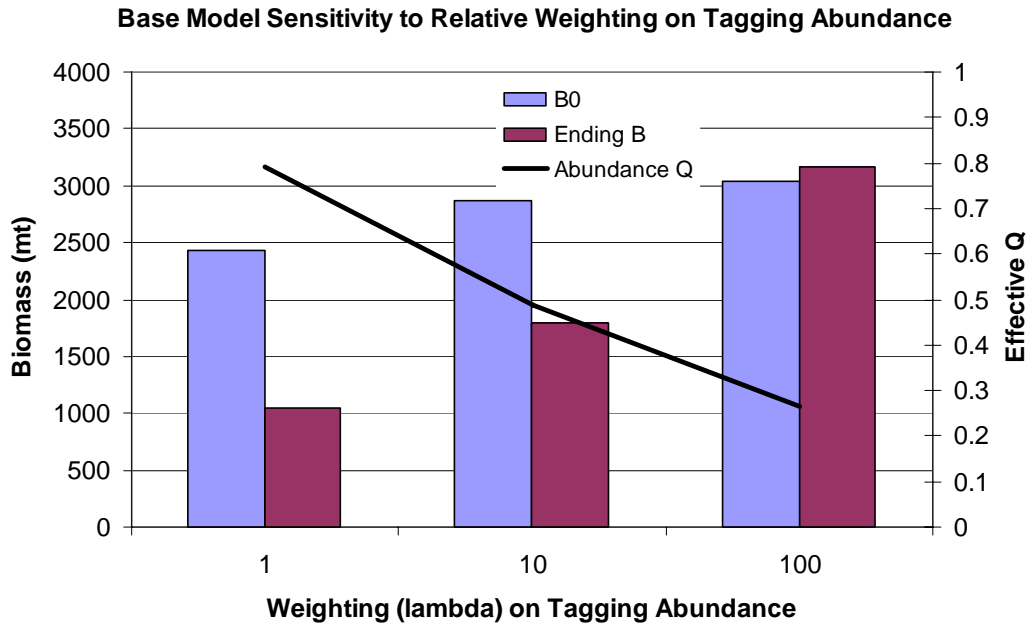

Figure 31. STAR base model sensitivity to increased weight on the tagging CPUE and tagging population estimates of abundance.

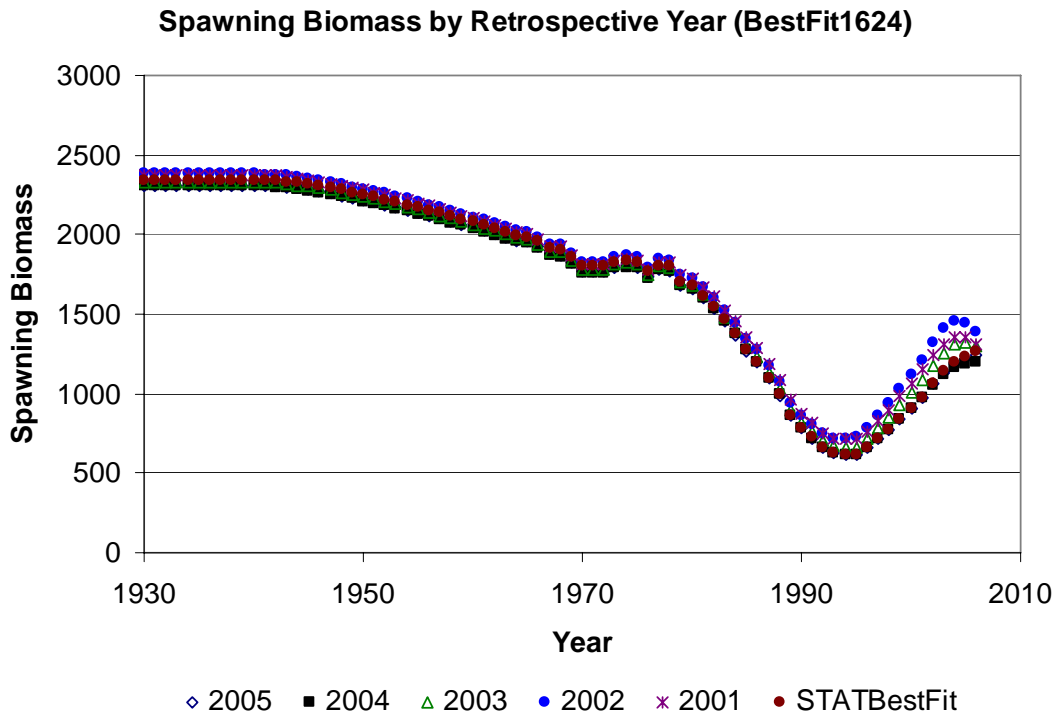
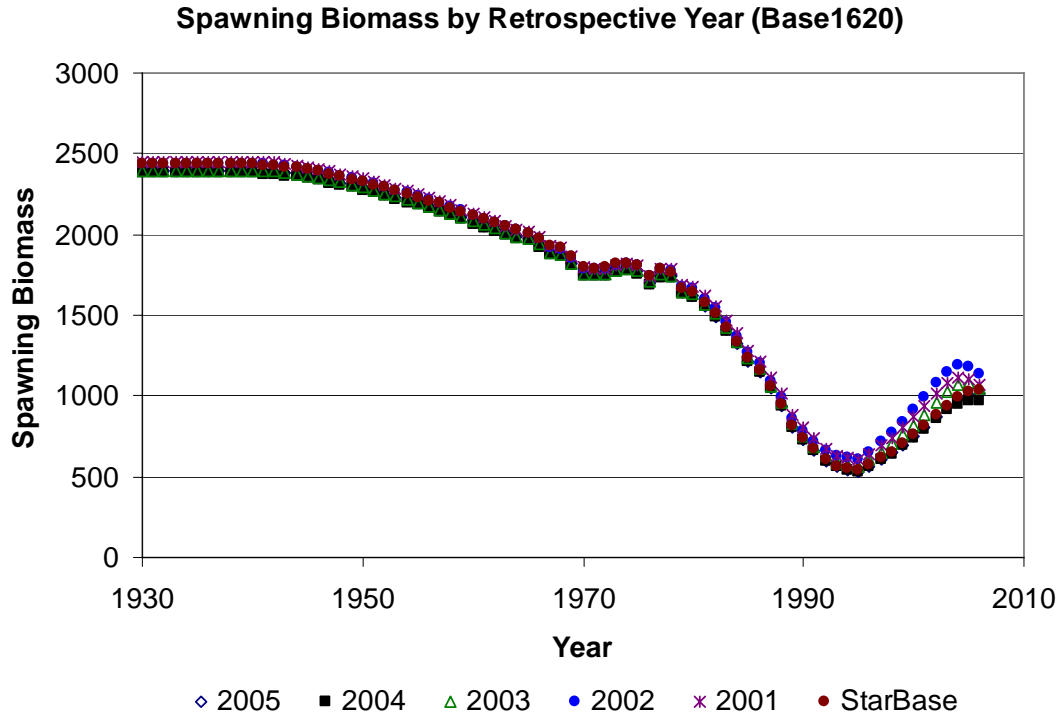
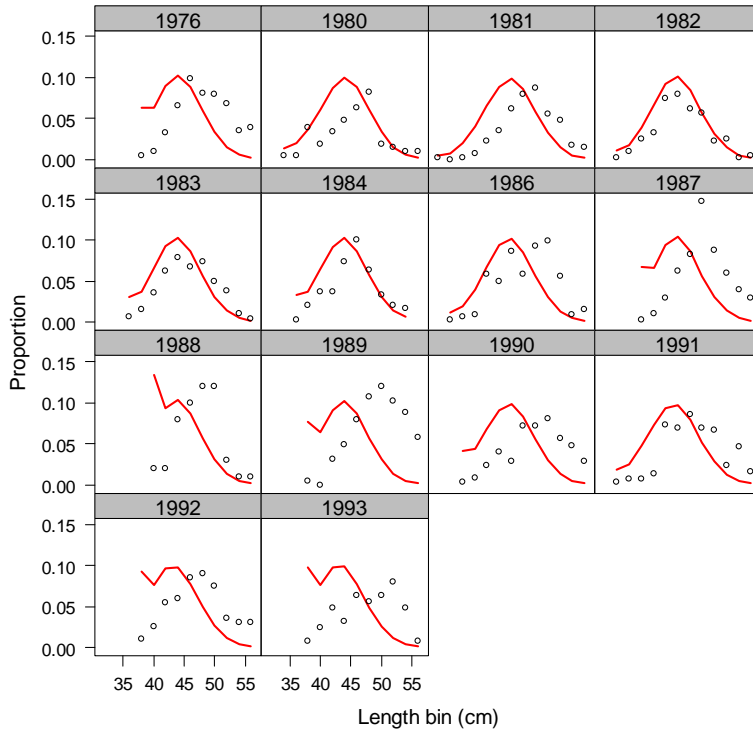

Figure 32. Retrospective analysis of the northern black rockfish STAR base (top panel) and STAT best-fit (bottom panel) models. Observation data are ignored and there is no recruitment deviations estimated beyond retrospective year

Female whole catch length fits for fleet 1



Male whole catch length fits for fleet 1

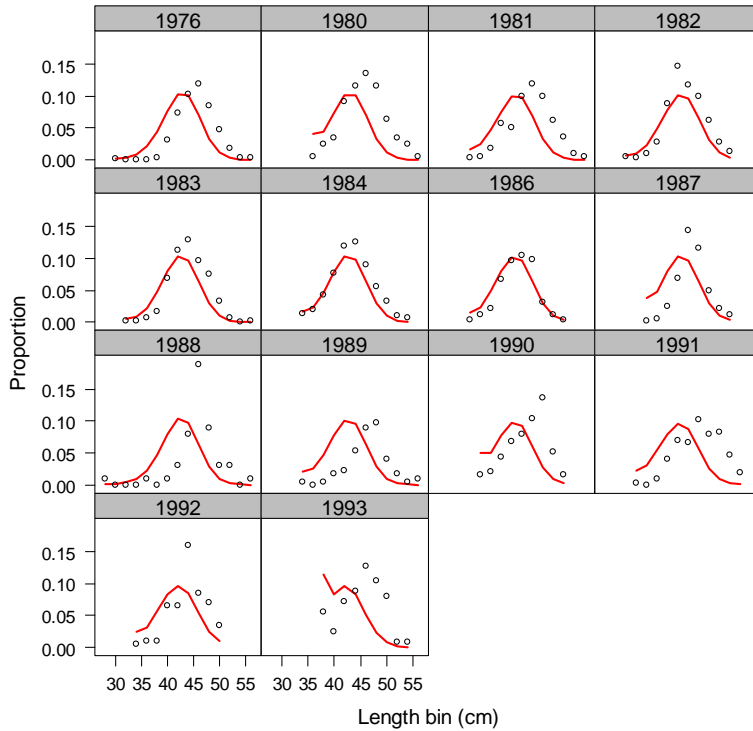
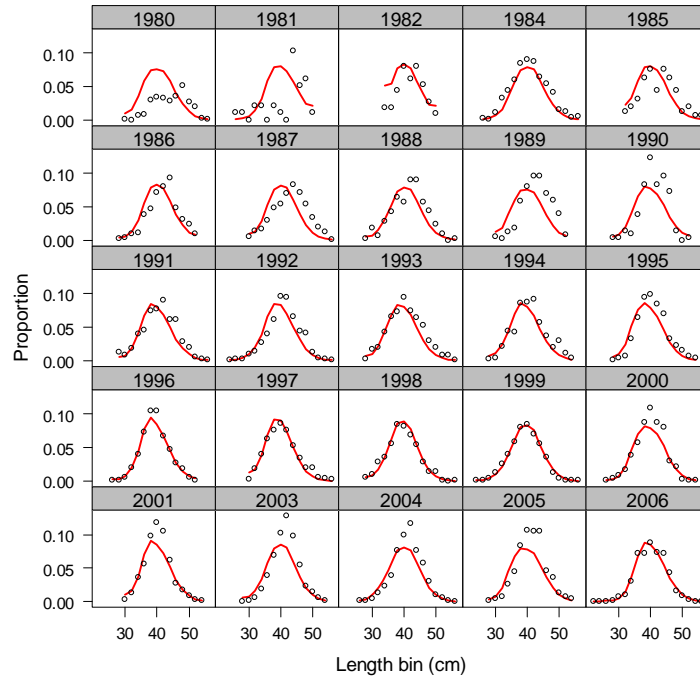

Figure 33. STAR base model fit to female (top) and male (bottom) length composition samples collected from the trawl fishery.

Female whole catch length fits for fleet 2



Male whole catch length fits for fleet 2

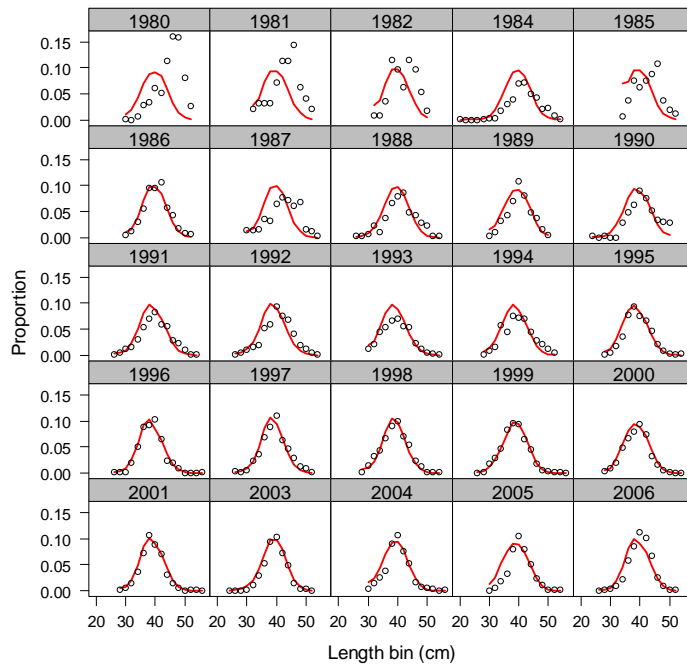
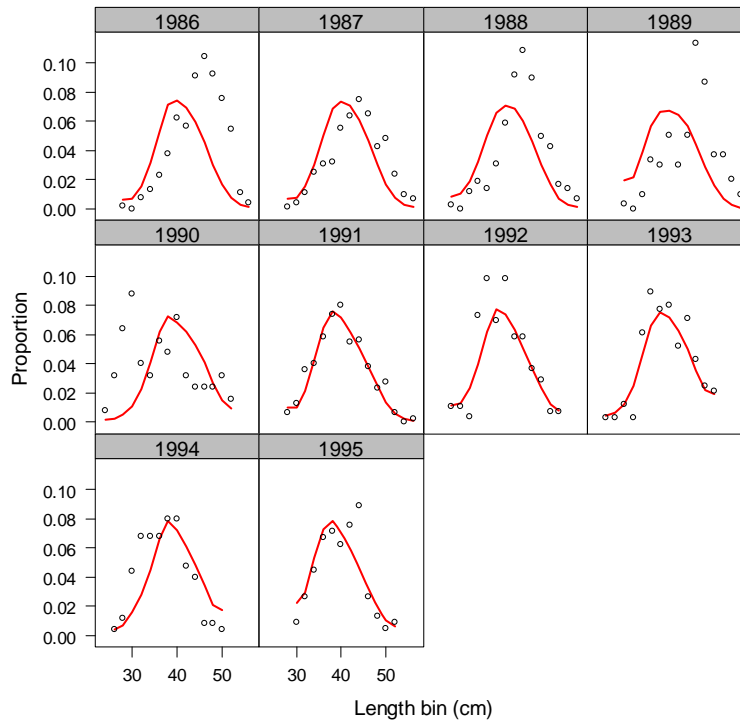

Figure 34. STAR base model fit to female (top) and male (bottom) length composition samples collected from the sport fishery.

Female whole catch length fits for fleet 3



Male whole catch length fits for fleet 3

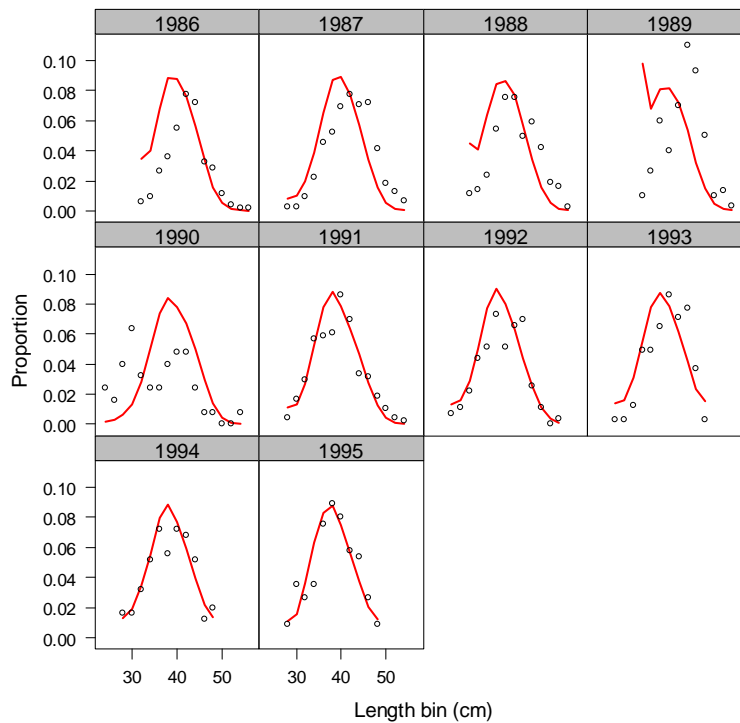

Figure 35. STAR base model fit to female (top panel) and male (bottom panel) length composition samples collected from the non-trawl fishery.

Combined sex whole catch length fits for fleet 6

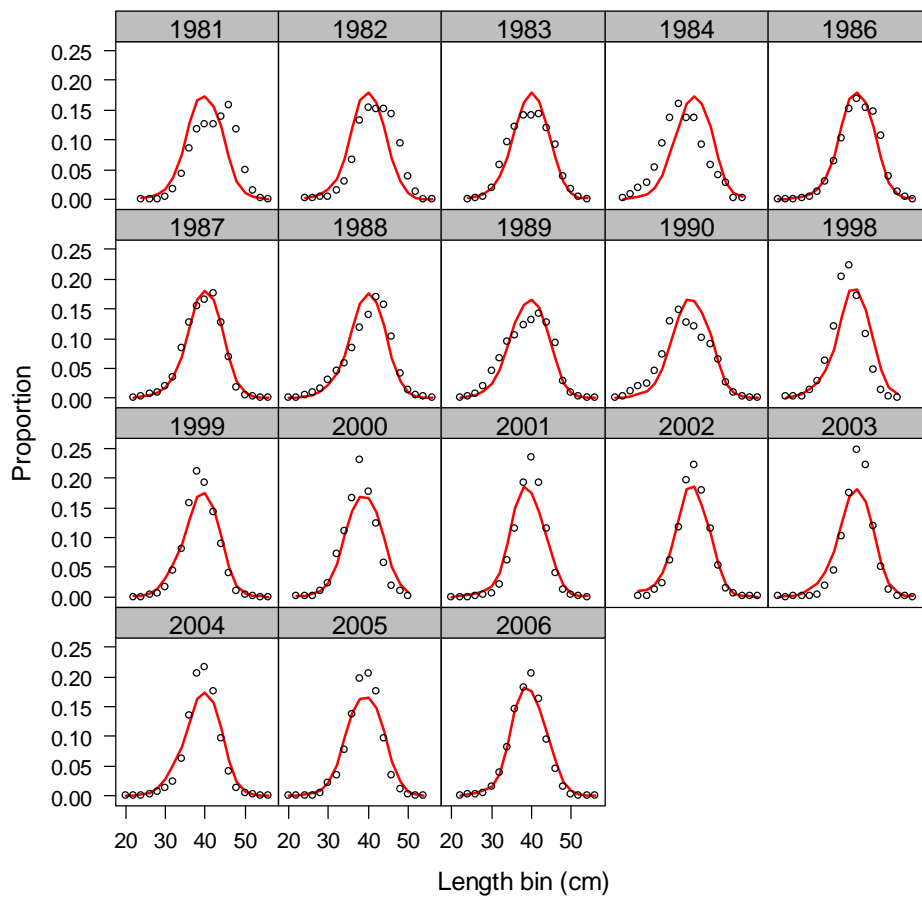
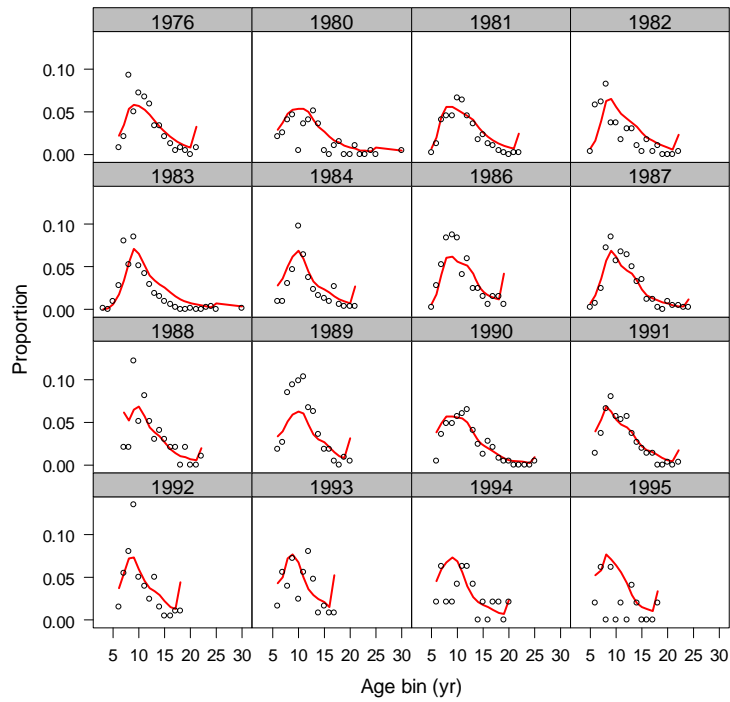

Figure 36. STAR base model fit to male length composition samples (combined sex) collected from the trawl fishery.

Female whole catch age fits for fleet 1



Male whole catch age fits for fleet 1

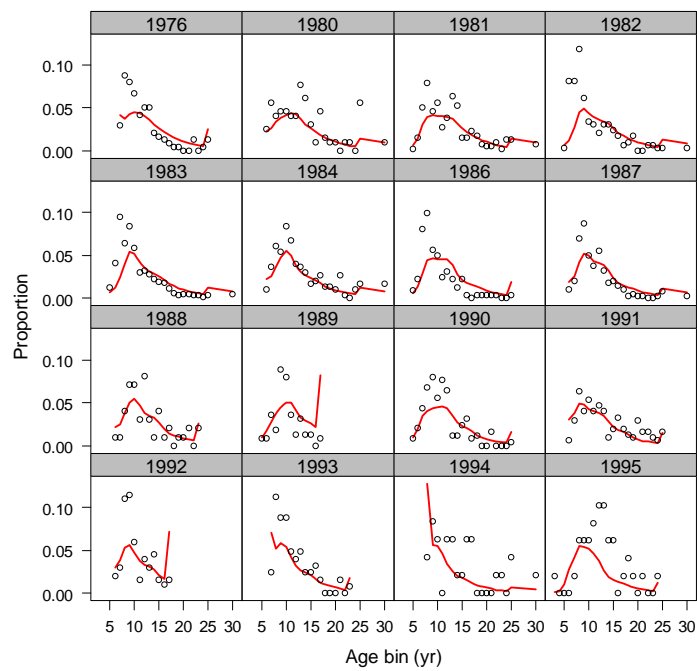
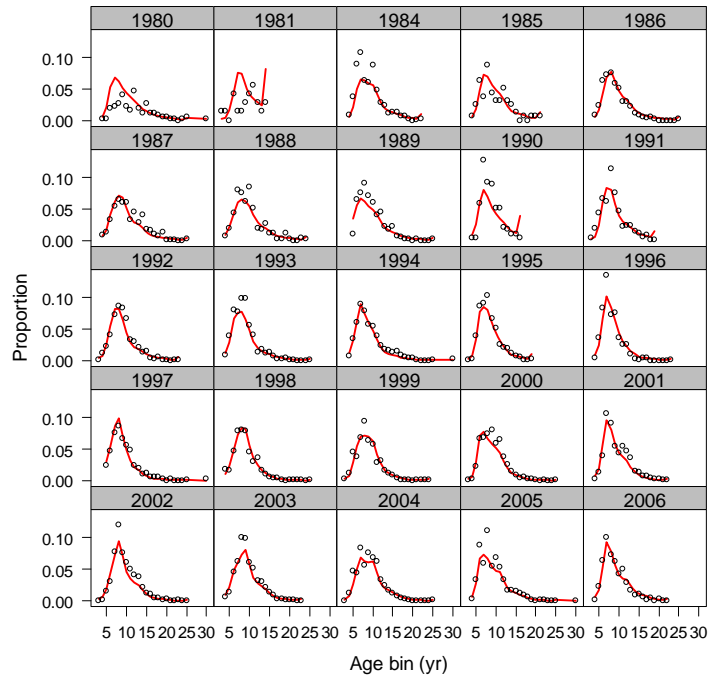

Figure 37. STAR base model fit to female (top panel) and male (bottom panel) age composition samples collected from the trawl fishery.

Female whole catch age fits for fleet 2



Male whole catch age fits for fleet 2

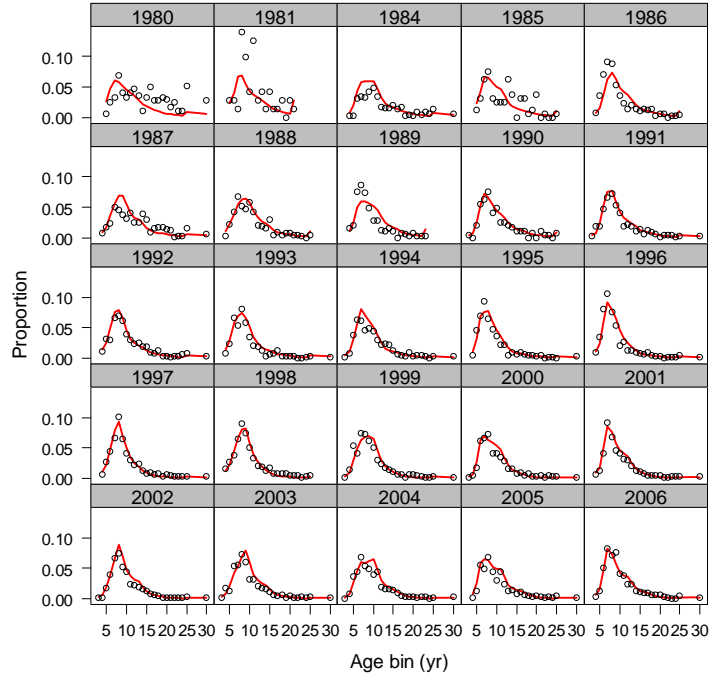
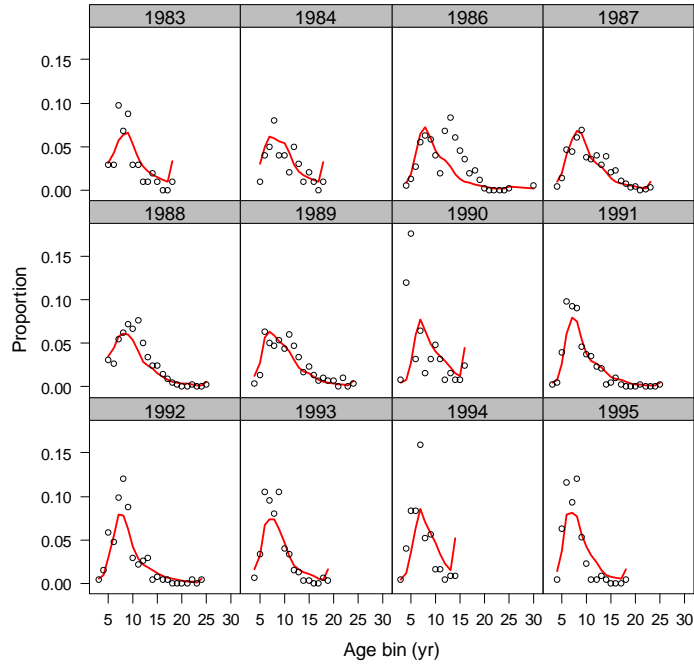

Figure 38. STAR base model fit to female (top panel) and male (bottom panel) age composition samples collected from the sport fishery.

Female whole catch age fits for fleet 3



Male whole catch age fits for fleet 3

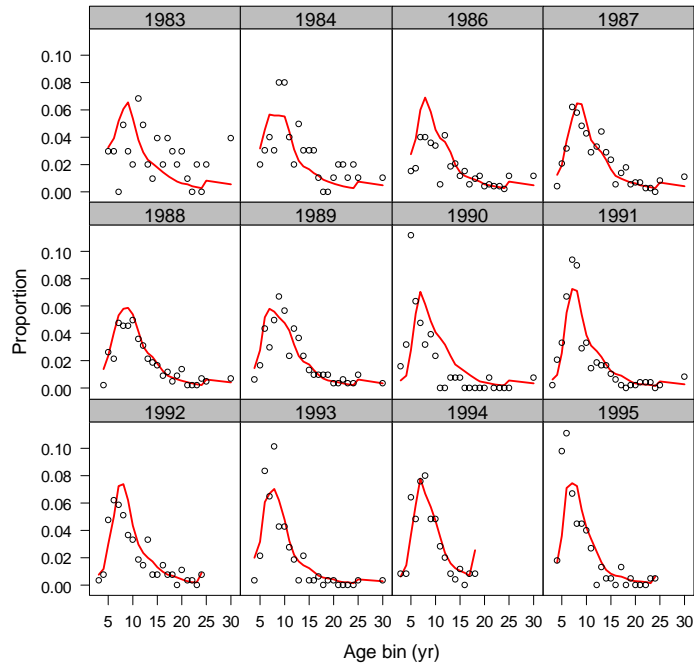

Figure 39. STAR base model fit to female (top panel) and male (bottom panel) age composition samples collected from the non-trawl fishery.

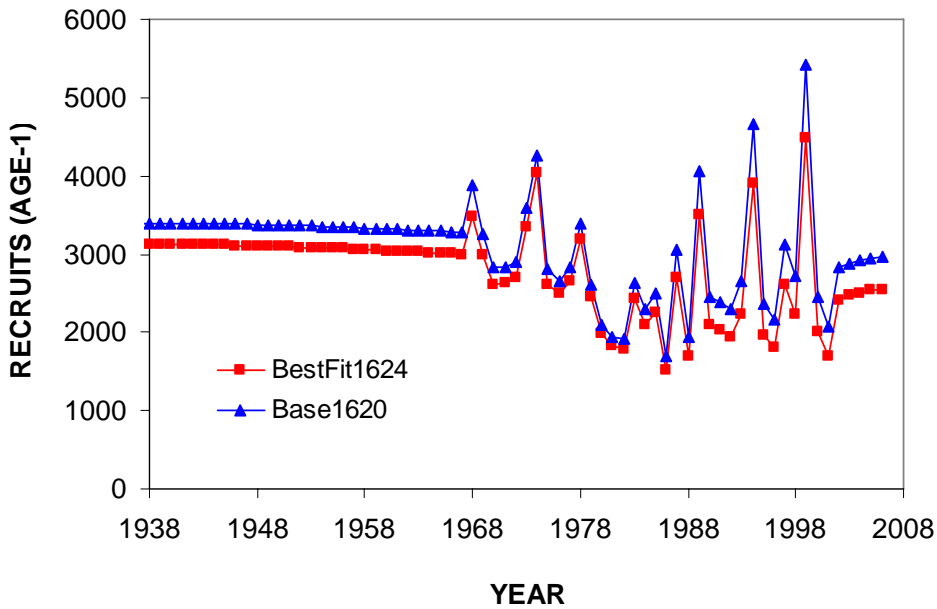
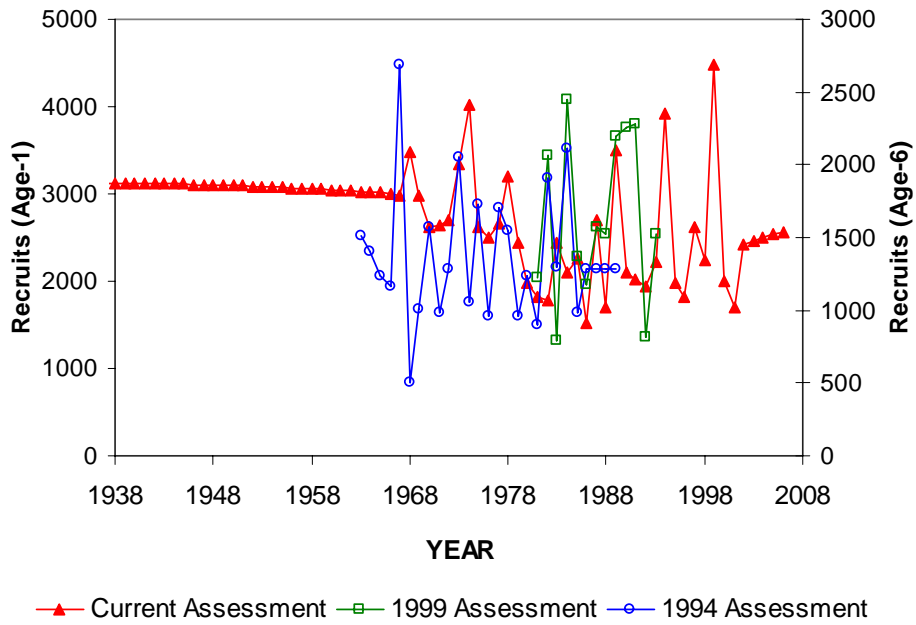

Figure 40. Comparison of STAR base model recruitment estimates to the previous northern black rockfish assessments (top panel) and to the STAT best-fit model recruitment estimates (bottom panel).

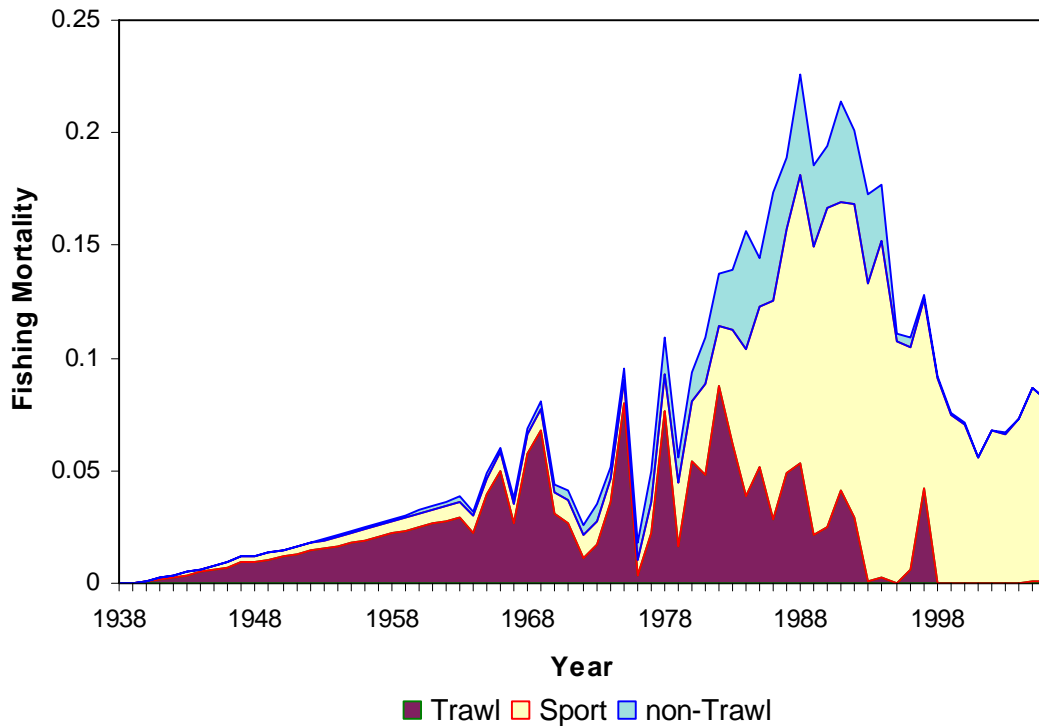
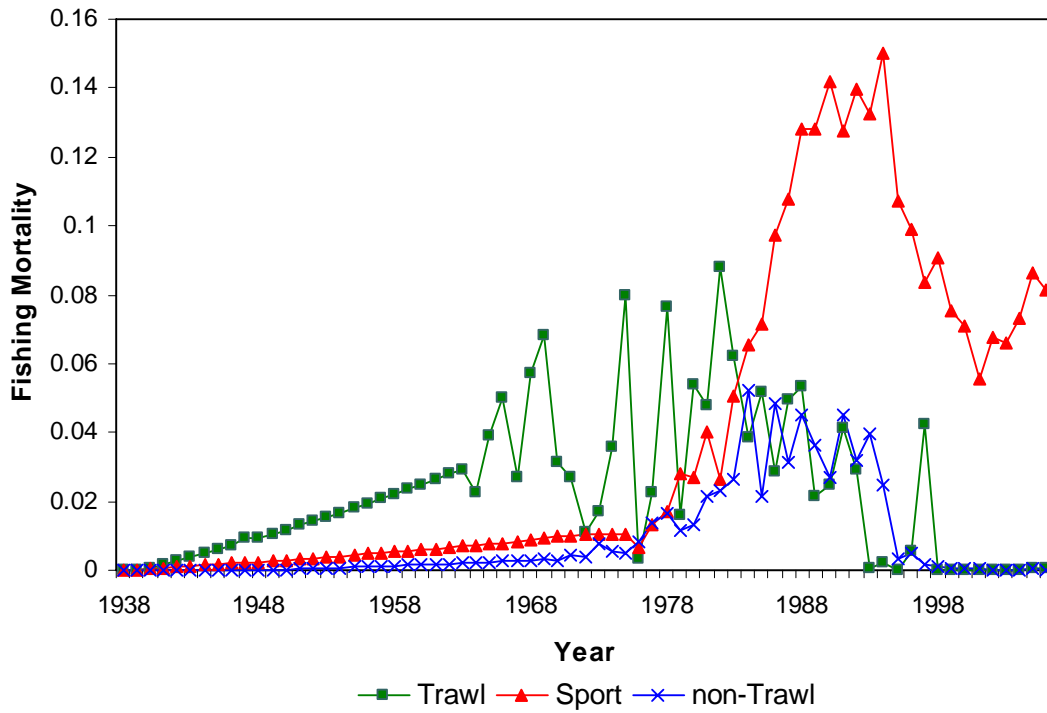

Figure 41. Northern black rockfish STAR base model estimated fishing mortality rates by year and fishery (top panel) and cumulative fishing mortality by year and fishery (bottom panel).

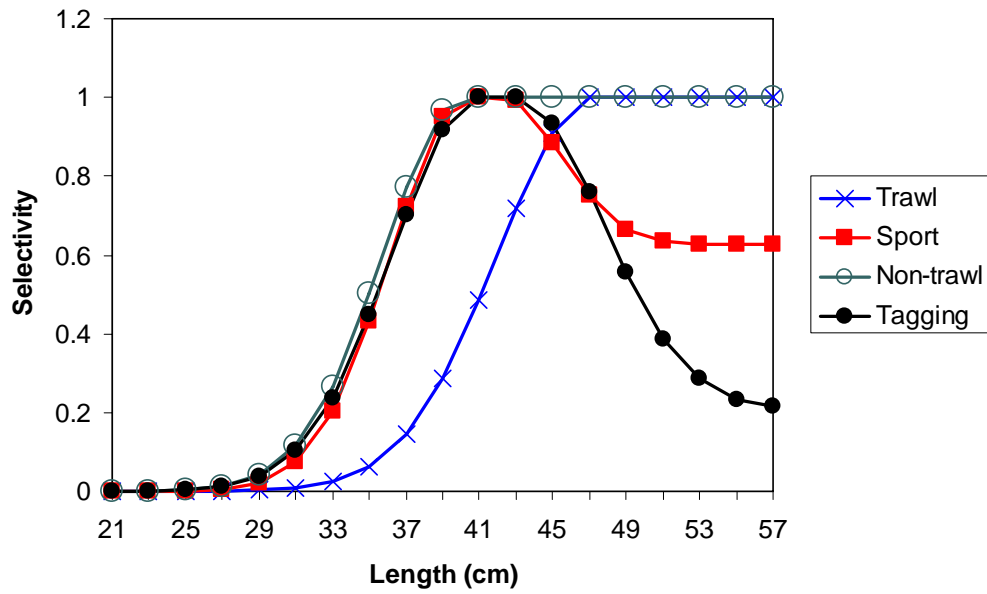

Figure 42. Trawl, sport, non-trawl, and tagging survey selectivity estimated by the STAR base model.

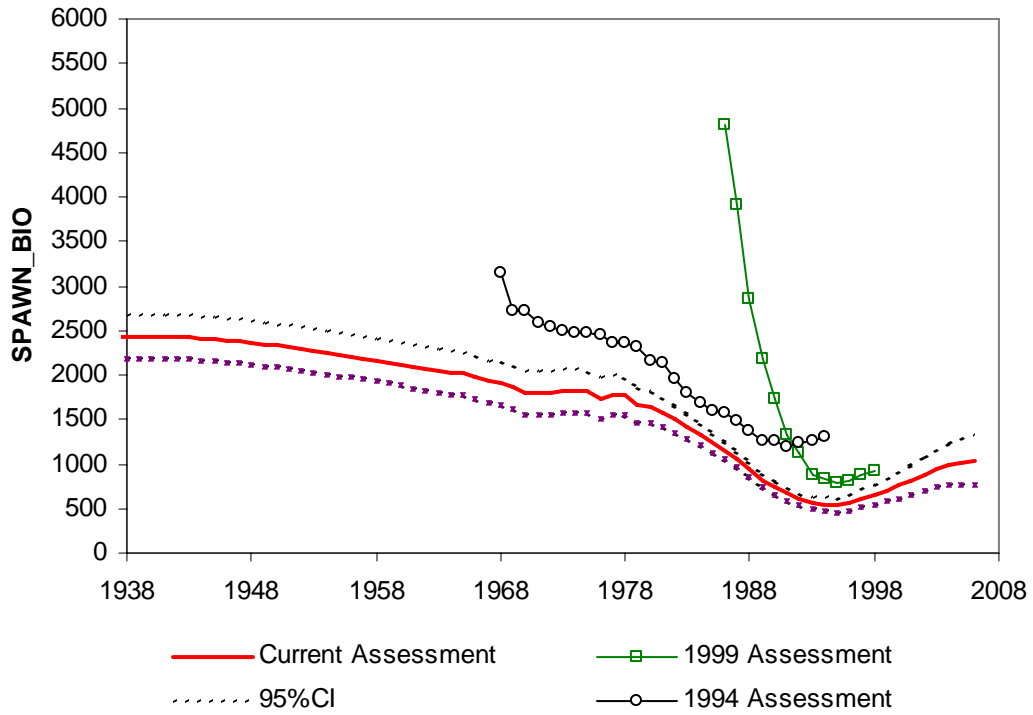

Figure 43. Comparison of STAR base model spawning biomass estimates to the previous two assessments for the northern black rockfish assessment.

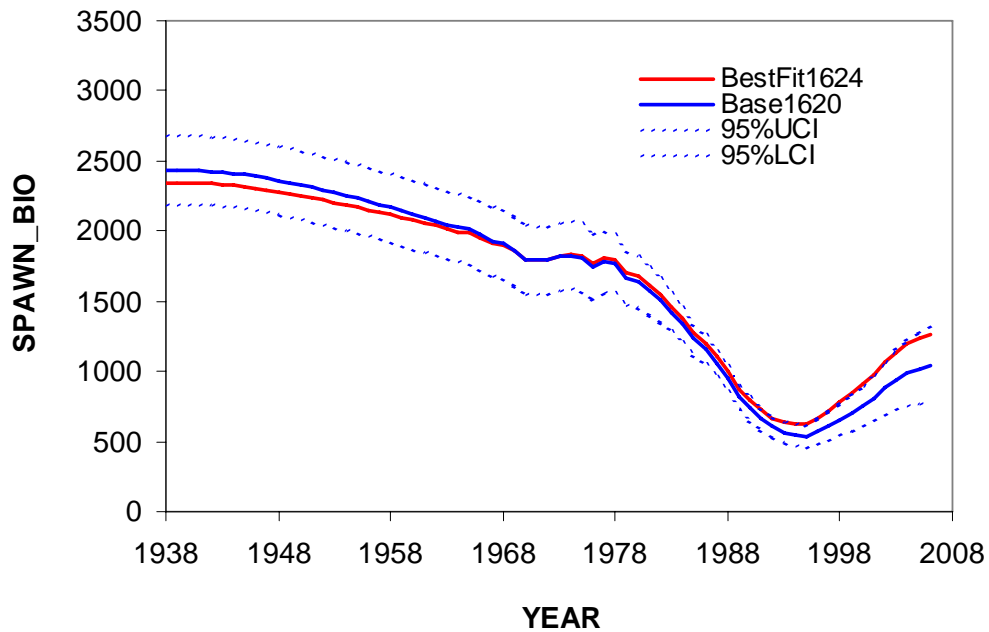

Figure 44. Comparison of STAR base model spawning biomass estimates to the STAT best-fit spawning biomass estimates for the Northern black rockfish assessment.

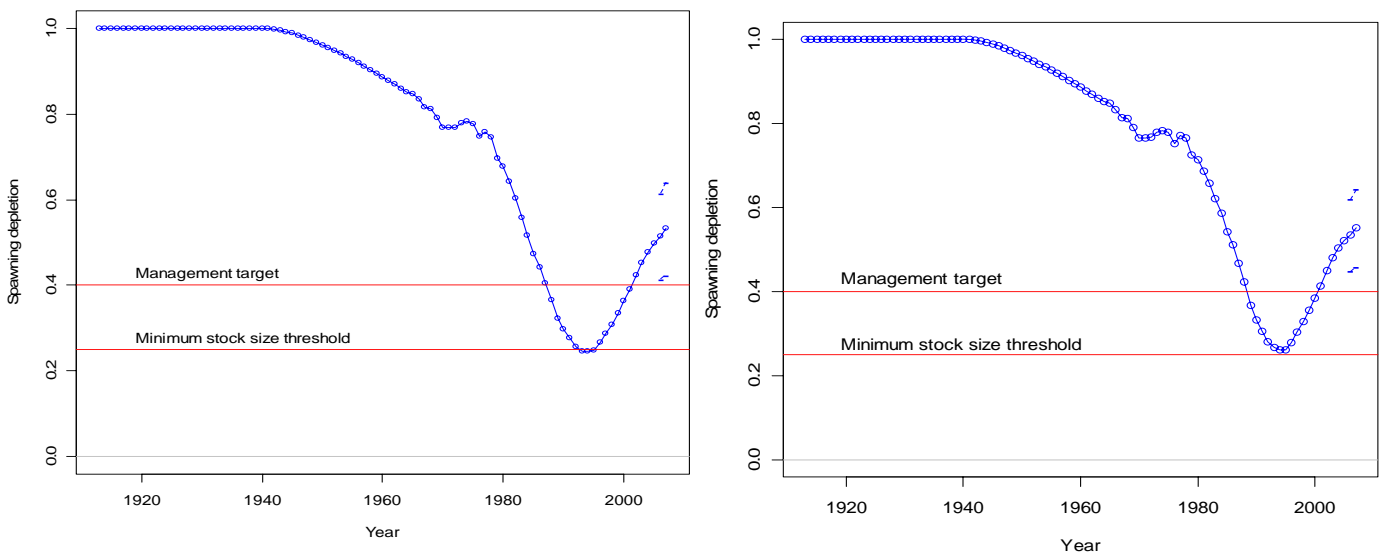

Figure 45. Comparison of stock abundance resulting from the STAT base model (left panel) and the STAT best fit model (right panel) to the Councils' minimum stock size threshold and management target.

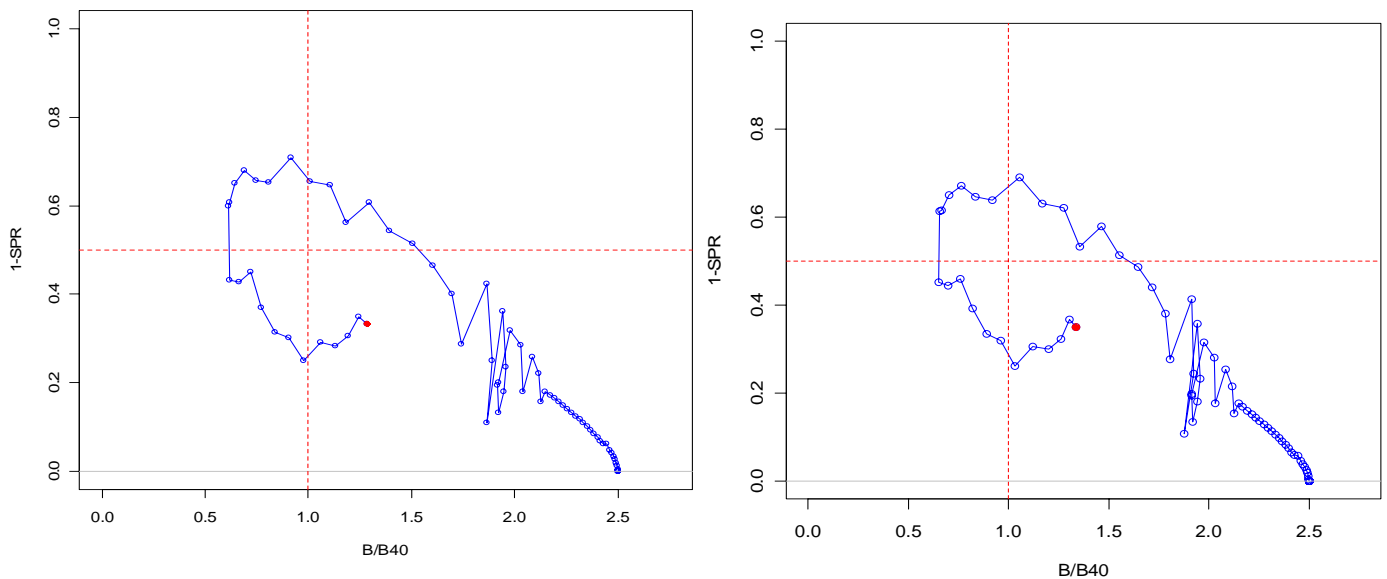

Figure 46. Plot of population status in relation to fishery management benchmarks for the STAR base (left panels) and STAT best fit models (right panels). F_{spr} versus B/B_{40} in top panel and spawning depletion in relation to management target of $B_{40}\%$ and $B_{25}\%$ in bottom panel.

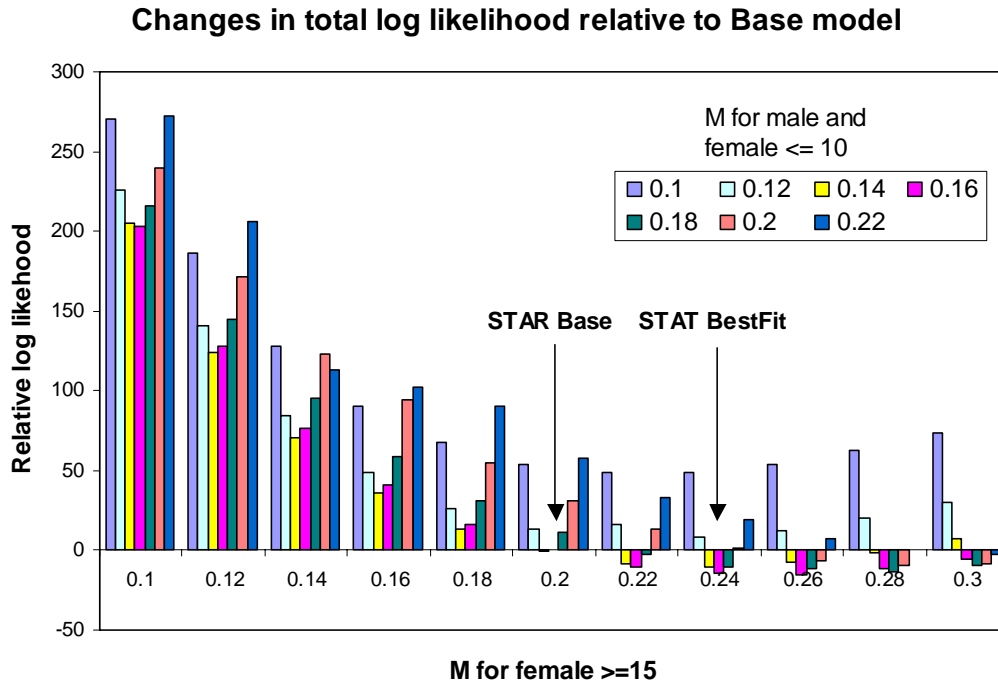

Figure 47. Change in total likelihood relative to the STAR base model. Negative values indicate a better fit.

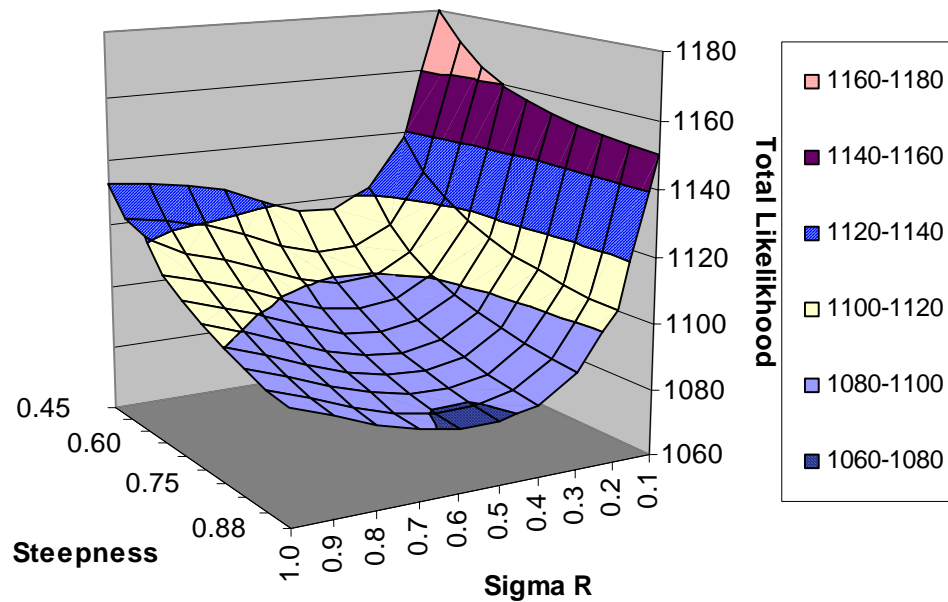

Figure 48. Likelihood profile of the STAR base assessment model for different fixed values of the Beverton-Holt steepness parameter (h) and Sigma R. The STAR base and STAT best-fit model had the steepness fixed at 0.6 and Sigma R tuned to 0.35.

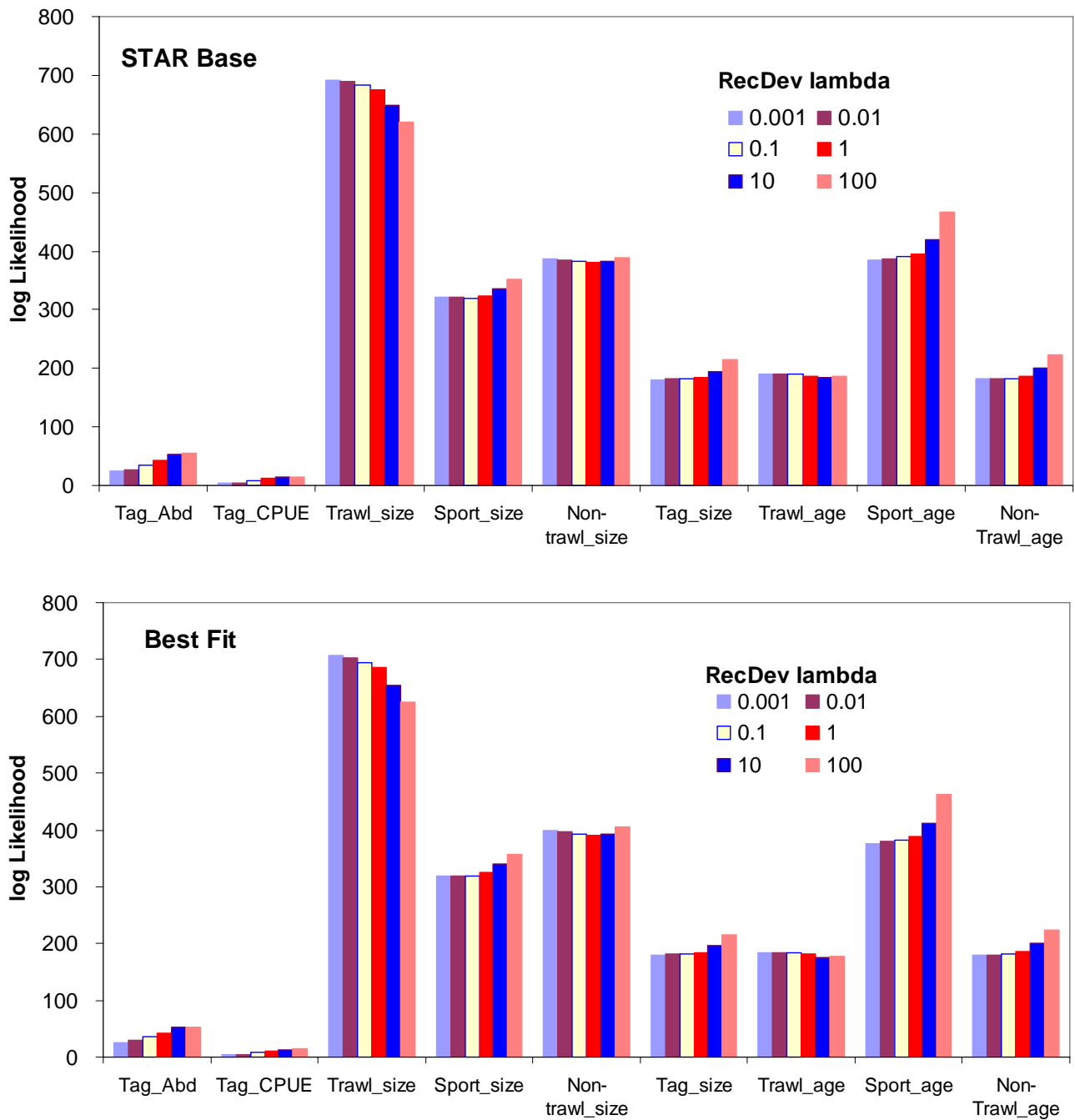

Figure 49. Likelihood profile for various components following simultaneous changes in the emphasis (weight) of the Recruitment Dev and Recruitment Dev time series for the STAR base (top panel) and STAT best-fit models (bottom panel).

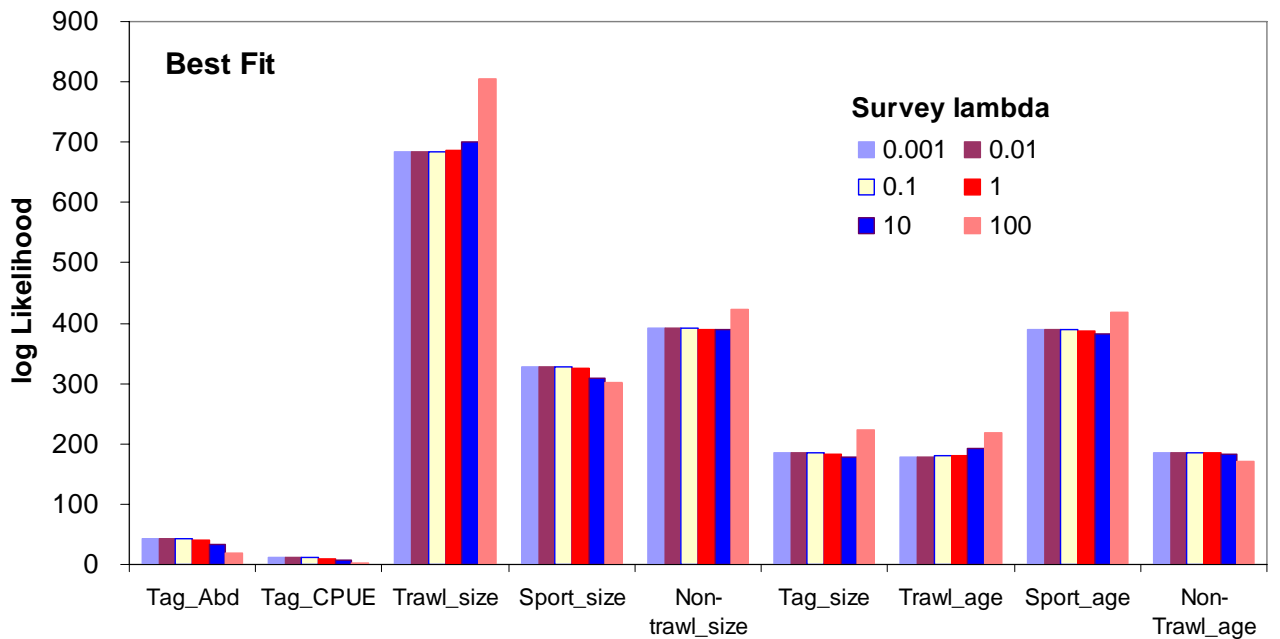
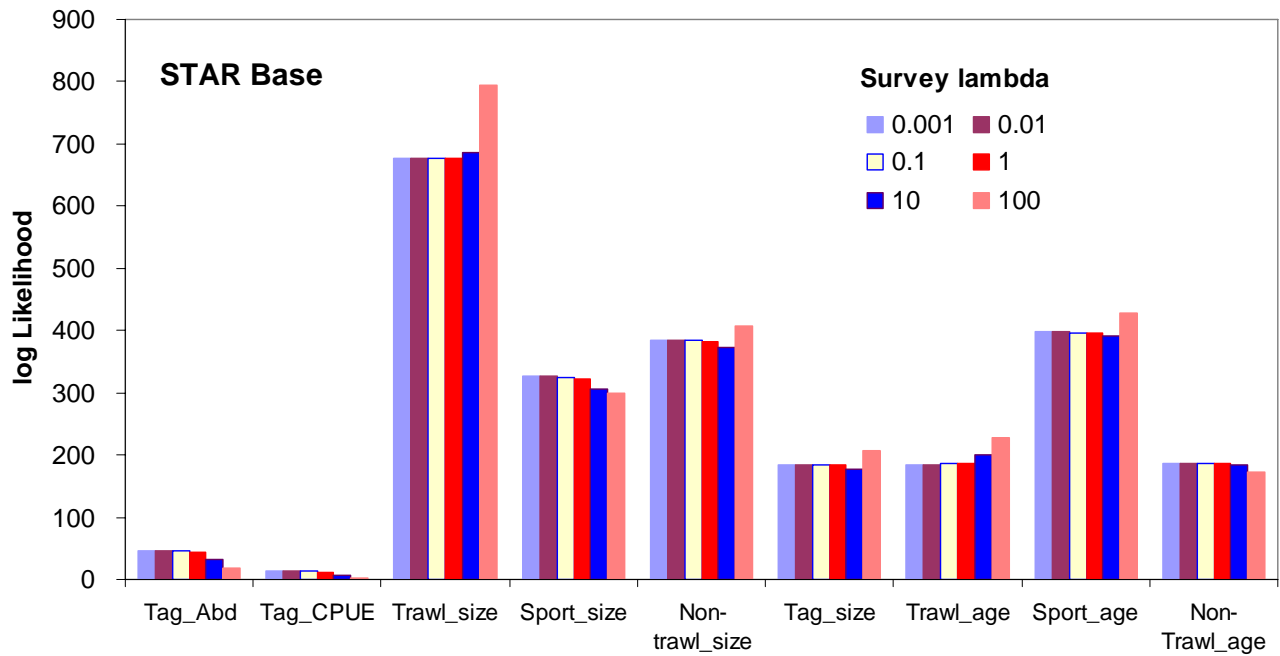

Figure 50. Likelihood profile for various components of the STAR base model (top panel) and STAT best-fit model (bottom panel) following changes in the emphasis (weight) on the tagging abundance and tagging CPUE indices.

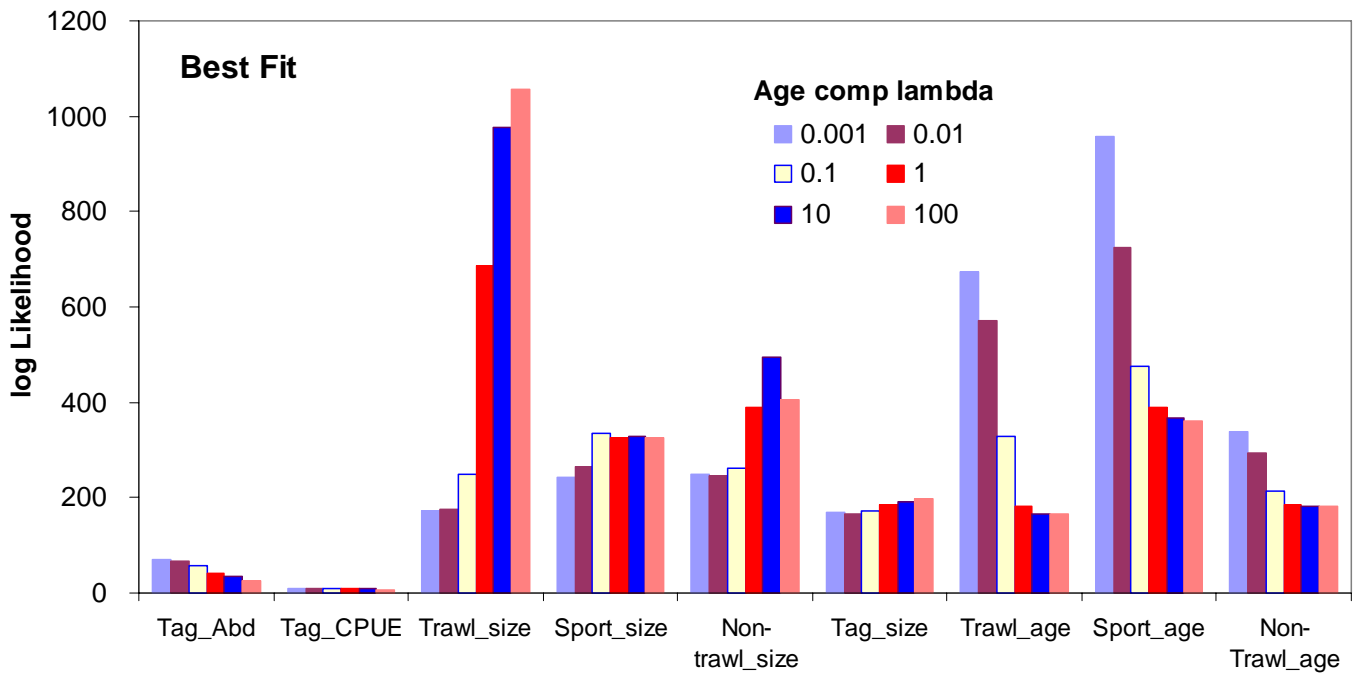
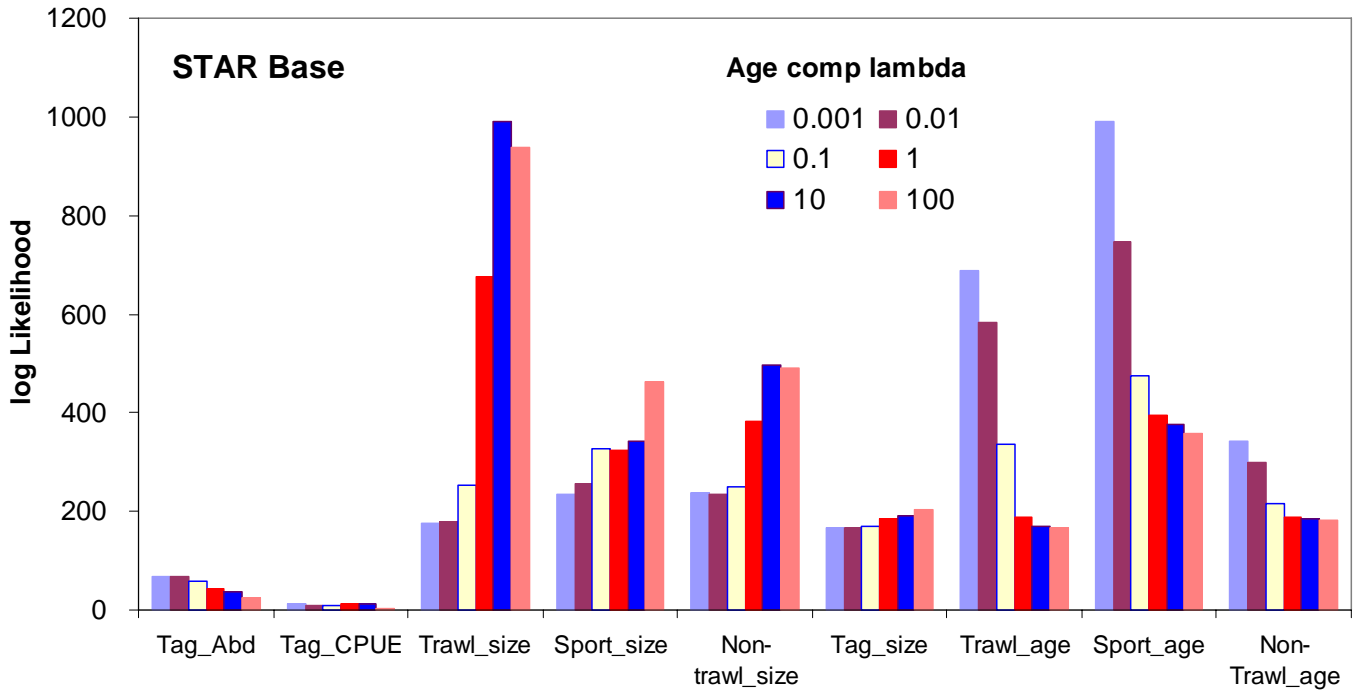

Figure 51. Likelihood profile for various components of the STAR base model and the STAT best-fit model following changes in the emphasis (weight) on the age composition for all fisheries.

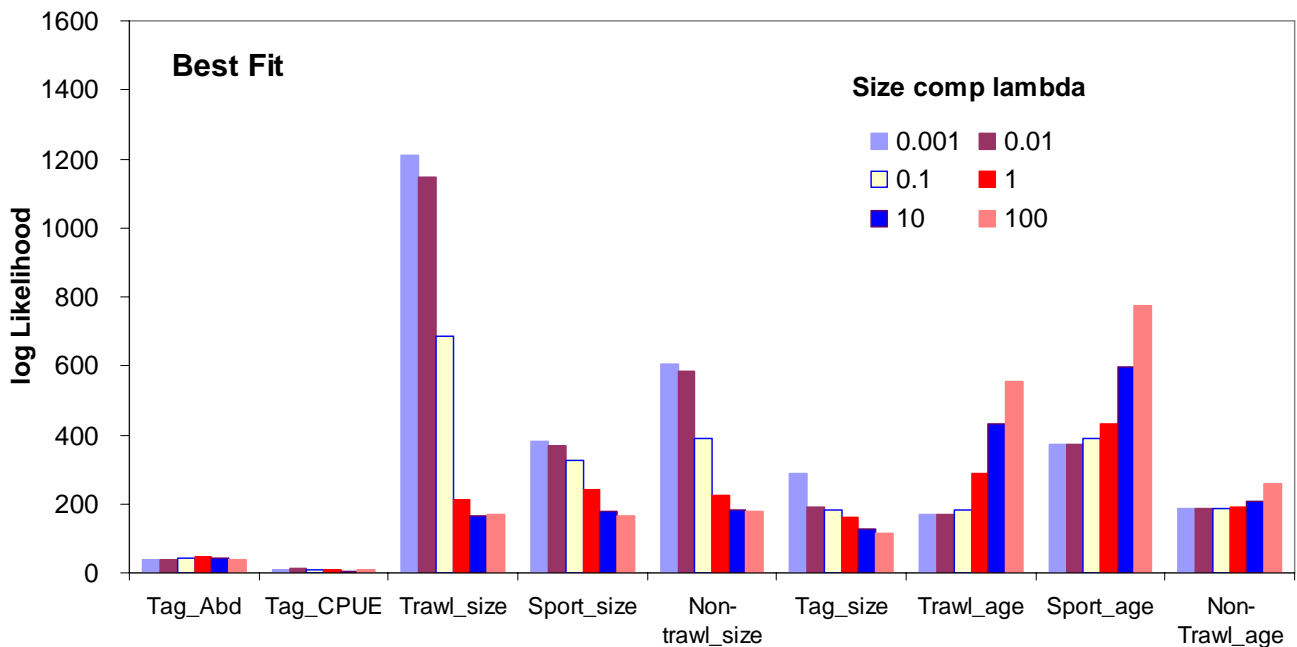
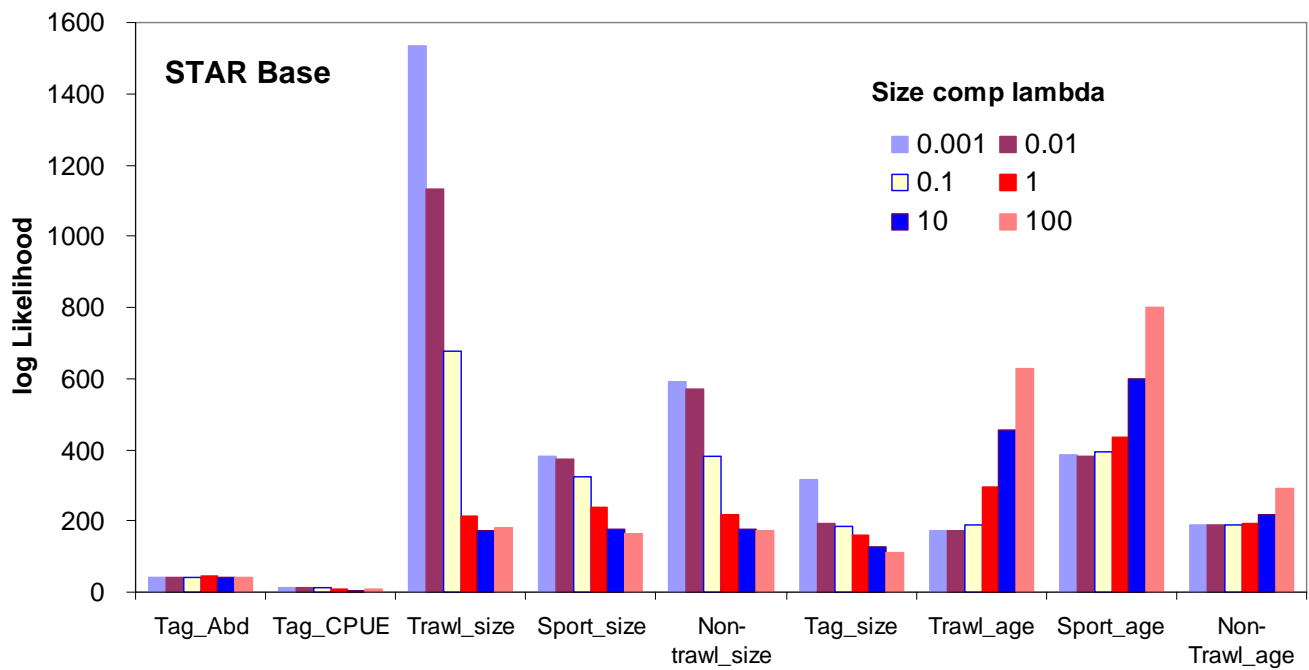

Figure 52. Likelihood profile for various components of the STAR base model and STAT best-fit model following changes in the emphasis (weight) on the length composition for all fisheries.

Appendix A: SS2 2.00c Control and Data Files

```

#_data_and_control_files:    ageonly.DAT    //    ageonly.CTL

1    #_N_Growth_Patterns

1    #_N_submorphs

1    #_N_areas

1    1    1    1    1    1
    #_area_assignments_for_each_fishery_and_survey

#_recruit_design_(G_Pattern_x_birthseas_x_area)_X_(0/1_flag)

1    #4_single    "season,area,and"    growth    "pattern,then=1""
0    #Allow_recr_distr_interaction
0    #Allow_migration
0    0    0    #    movement    from    area    1    to    area    1
    in    season    1    (0=no;    start    age=1;    End    age    =1)
2    #_Nblock_Designs

1    1    #_N_Blocks_per_Pattern
1996 2006 #_begin_and_end_year_for_each_Block_in_Pattern_1
1989 2006 #
0.5    #_fracfemale

1    #_submorph_between/within

-1    #vector_submorphdist_(-1_first_val_for_normal_approx)

#    Natural Mortality    &    Maturity

10    #_natM_amin
15    #_natM_amax
5    #_Growth_Age-at-L1
20    #_Growth_Age-at-L2
0    #_SD_add_to_LAA
0    #_CV_Growth_Pattern
1    #_maturity_option
4    #_First_Mature_Age
1    #_parameter_offset_approach
1    #MG_Adjustment_method
-4    #_MGparm_Dev_Phase

#_growth_parms

#_LO    HI    INIT    PRIOR    PR_type    SD_Prior    PHASE    env-var    use_dev    dev_minyr
    dev_maxyr    STD_4elements_in_Dev_Vector    Block    Block_Fxn
#Females
0.1    0.2    0.16    0.3    -1    0.9    -2    0    0    0    0    0.5
    0    0    #_Gpattern:_1_Gender:_Female_M1_natM_young

```

```

-3      3      0.2      0.3      -1      0.9      -2      0      0      0      0      0.5
0
#M1_natM_old_4_intermediateages_do_a_linear_interpolation_of_NM_on_age
10     40     34.4     13.5     -1      10      2      0      0      0      0      0.5
0      0      #M1_Lmin_Body_length_at_Amin_(units_in_cm)
30     70     50.37    49.3     -1      10      2      0      0      0      0      0.5
0      0      #M1_Lmax_Body_length_at_Amax_(units_in_cm)
0.01   0.4     0.181    0.1745  -1      0.9      3      0      0      0      0      0.5
0      0      #M1_VBK
-3      3      0.08      0.0622  -1      0.9      -2      0      0      0      0      0.5
0      0      #M1_CV-young_Variability_for_size-at-age_at-
age<=AFIX_(units_are_fraction)Units_CV_or_stddev_dependig_on_assigned_value_of_CV_patter
n
-3      3      0.08      0.0721  -1      0.9      -3      0      0      0      0      0.5
0      0      #M1_CV-old_Variability_for_size-at-age_at-
age>=AFIX2_do_a_linear_interpolation_of_CV_on_mean_size-at-age
#Males
0.1     0.2     0.16      0.1      -1      0.9      -2      0      0      0      0      0.5
0      0      #_Gpattern:_1_Gender:_Male_M1_natM_young
0.1     0.2     0.16      0.1      -1      0.9      -2      0      0      0      0      0.5
0      0
#M1_natM_old_4_intermediateages_do_a_linear_interpolation_of_NM_on_age
10     40     34.2     15.0     -1      0.9      2      0      0      0      0      0.5
0      0      #M1_Lmin
30     70     47.3     46.6     -1      0.9      2      0      0      0      0      0.5
0      0      #M1_Lmax
0.1     0.3     0.191    0.1982  -1      0.9      3      0      0      0      0      0.5
0      0      #M1_VBK
0.05    0.25    0.07      0.06     -1      0.9      -3      0      0      0      0      0.5
0      0      #M1_CV-young
-3      3      0.07      0.0567  -1      0.9      -3      0      0      0      0      0.5
0      0      #M1_CV-old
#Females_wtln_Maturity_fec
-3      3      4.03E-05  4.03E-05 -1      99      -3      0      0      0      0
0      0.5      0      0      #Female wt-len-
l_coefficient_to_convert_L_in_cm_to_Wt_in_kg
-3      3      2.768     2.768    -1      0.9      -3      0      0      0      0      0.5
0      0      #Female_wt-len-2_Exponent_in_female_L-W_conversion
-3      3      42.6      42.6     -1      0.9      -3      0      0      0      0      0.5
0      0      #Female_Maturity_logistic_inflection
-3      3      -0.4      -0.4     -1      0.9      -3      0      0      0      0      0.5
0      0      #Female_Logistic_slope
-3      3      -0.3657  -0.3657 -1      0.9      -3      0      0      0      0      0.5
0      0      #-0.3657Female_eggs/gm_intercept
-3      3      0.7674    0.7674  -1      0.9      -3      0      0      0      0      0.5
0      0      #0.7674Female_eggs/gm_slope
#Male_wtln
-3      3      3.80E-05  3.80E-05 -1      99      -3      0      0      0      0
0      0.5      0      0      #Male wt-len-
l_coefficient_to_convert_L_in_cm_to_Wt_in_kg
-3      3      2.782     2.782    -1      0.9      -3      0      0      0      0      0.5
0      0      #Male_wt-len-2_Exponent_in_female_L-W_conversion
-4      4      0          1        -1      0.9      -3      0      0      0      0      0.5
0      0      #_recrdistribution_by_growth_pattern
-4      4      0          1        -1      0.9      -3      0      0      0      0      0.5
0      0      #_recrdistribution_by_area_1
-4      4      0          1        -1      0.9      -3      0      0      0      0      0.5
0      0      #_recrdistribution_by_season_1
-1      1      1          1        -1      0.9      -3      0      0      0      0      0.5
0      0      #_cohort_growth_deviation
0      #_custom_MG-env_setup
0      #_custom_MG-block_setup
#_Spawner-Recruitment
3      #_SR_function

```

```

#_LO  HI      INIT  PRIOR  PR_type SD      PHASE
1      15      12      6.7    0      10      1      #log(R0)
0.2    1      0.6      0.566  2      0.181  -5      #steepness
0      2      0.3      0.65   0      0.4     -4      #sigma-r
-5     5      0        0      0      1      -3      #env-linkrecruitment-
environmental_linkage_coefficient
-5     5      0        0      0      1      -1
#log(R1)offsetfor_initial_equil_recruitment_relative_to_virgin_recruitment_(usuall
y0)
0      0      0        0      -1     0      -99     #autocorrelation_parameter_for_S-R
0      #_SR_env_link
1      #_SR_env_target_1=devs;_2=R0;_3=steepness
1      #do_recr_dev: 0=none; 1=devvector;_2=simple_deviations
1968   #Begin RecDevs
2001   #End_recr_Dev
-15    #Min_Value4Rec_Dev
15     #Max_Value4RecDev
3      #Phaseto begin_Estimation
1492   #_first_yr_fullbias_adj_in_MPD
#_initial_F_parms
#_LO  HI      INIT  PRIOR  PR_type SD      PHASE
0      0.6    0.000  0.0001 -1     99     -1
0      0.6    0.000  0.0001 -1     99     -1
0      0.6    0.000  0.0001 -1     99     -1
#_Q_setup

#      A=do "power," "B=env-var," C=extra "SD," "D=devtype(<0=mirror,"
"0/1=none," "2=cons," "3=rand," 4=randwalk); "E=0=num/1=bio,"
F=err_type
#_A  B      C      D      E      F
0      0      0      0      1      0
0      0      0      0      1      0
0      0      0      0      1      0
0      0      0      0      0      0
0      0      0      0      0      0
0      0      0      0      0      0
0      0      0      0      0      0
#_Q_parms(if_any)

#_size_selex_types

#_Pattern_DiscardMale_Special

24     0      0      0      #      1
24     0      0      0      #      2

24     0      0      0      #      3

5      0      0      2      #      4

5      0      0      6      #      5

24     0      0      0

#_age_selex_types

#_Pattern  Discard Male  Special
10     0      0      0      #      1
10     0      0      0      #      2
10     0      0      0      #      3
10     0      0      0      #      4
10     0      0      0      #      5
10     0      0      0      #      6

```

#_selex_parms

#_LO	HI	INIT	PRIOR	PR_type	SD	PHASE	env-var	use_dev	dev_minyr		
	dev_maxyr		dev_stddev		Block	Block_Fxn					
#_size_sel:1											
#19	70	45.57	50	1	0.05	2	0	0	0	0	0.5
	0	0	#infl_for_logistic								
#0.01	60	6.6	15	1	0.05	2	0	0	0	0	0.5
	0	0	#95%width_for_logistic								
30	60	46	51.2	-1	0.05	2	0	0	0	0	0.5
	0	0									
-6	4	1.6	-2.6	-1	0.05	3	0	0	0	0	0.5
	0	0									
-1	9	4	5.2	-1	0.05	-3	0	0	0	0	0.5
	0	0									
-1	9	2.2	6	-1	0.05	-3	0	0	0	0	0.5
	0	0									
-8	9	-4	-3.7	-1	0.05	2	0	0	0	0	0.5
	0	0									
-5	9	-1	0.1	-1	0.05	2	0	0	0	0	0.5
	0	0									
#_size_sel:2											
#19	70	45	50	1	0.05	2	0	0	0	0	0.5
	0	0	#infl_for_logistic								
#0.01	60	20	15	1	0.05	2	0	0	0	0	0.5
	0	0	#95%width_for_logistic								
#											
20	60	41.5	41.2	-1	0.05	2	0	0	0	0	0.5
	0	0									
-6	4	-4	-2.6	-1	0.05	3	0	0	0	0	0.5
	0	0									
-1	9	3.5	5.2	-1	0.05	-3	0	0	0	0	0.5
	0	0									
-1	9	3	6	-1	0.05	-3	0	0	0	0	0.5
	0	0									
-8	9	-3.7	-3.7	-1	0.05	2	0	0	0	0	0.5
	0	0									
-5	9	-1	0.1	-1	0.05	2	0	0	0	0	0.5
	0	0									
#_size_sel:3											
#19	70	41.6	50	1	0.05	-2	0	0	0	0	0.5
	0	0	#infl_for_logistic								
#0.01	60	9.3	15	1	0.05	-2	0	0	0	0	0.5
	0	0	#95%width_for_logistic								
30	60	46	41.2	-1	0.05	2	0	0	0	0	0.5
	0	0									
-6	4	-0.747	-2.6	-1	0.05	3	0	0	0	0	0.5
	0	0									
-1	9	4.83454	5.2	-1	0.05	3	0	0	0	0	0.5
	0	0									
-1	9	4	6	-1	0.05	3	0	0	0	0	0.5
	0	0									
-8	9	-4	-3.7	-1	0.05	2	0	0	0	0	0.5
	0	0									
-5	9	2	0.1	-1	0.05	2	0	0	0	0	0.5
	0	0									
#_size_sel:4											
1	19	1	5	-1	0.05	-2	0	0	0	0	0.5
	0	0	#MirrorTag								
1	19	19	5	-1	0.05	-3	0	0	0	0	0.5
	0	0	#MirrorTag								
#_size_sel:5											
1	19	1	5	-1	0.05	-2	0	0	0	0	0.5
	0	0	#MirrorTagCPUE								

```

1      19      19      5      -1      0.05   -3      0      0      0      0      0.5
0      0      0      #MirrorTagCPUE
#_size_sel:6
#1      19      30      5      -1      0.05   2      0      0      0      0      0.5
0      0      #
#1      19      19      5      -1      0.05   3      0      0      0      0      0.5
0      0      #
20      60      39.513  41.2   -1      0.05   2      0      0      0      0      0.5
0      0
-6      4      -3.41   -2.6   -1      0.05   3      0      0      0      0      0.5
0      0
-1      9      3.7      5.2    -1      0.05   3      0      0      0      0      0.5
0      0
-1      9      3.5      6      -1      0.05   3      0      0      0      0      0.5
0      0
-8      9      -4.69   -3.7   -1      0.05   2      0      0      0      0      0.5
0      0
-5      9      -3.95   0.1    -1      0.05   2      0      0      0      0      0.5
0      0
#_age_sel:1
#0      40      1      5      0      99      2      0      0      0      0      0.5
0      0      #      3
#0.01   10      2      2      0      99      3      0      0      0      0      0.5
0      0      #      4
#1      20      7      5      0      99      2      0      0      0      0      0.5
0      0      #      5
#1      25      17      2      0      99      3      0      0      0      0      0.5
0      0      #      6
#_age_sel:2
#1      20      7      5      0      99      2      0      0      0      0      0.5
0      0      #      5
#1      25      17      2      0      99      3      0      0      0      0      0.5
0      0      #      6
#_age_sel:3
#0      40      1      5      0      99      2      0      0      0      0      0.5
0      0      #      7
#0.01   10      2      2      0      99      3      0      0      0      0      0.5
0      0      #      8
#1      20      7      5      0      99      2      0      0      0      0      0.5
0      0      #      5
#1      25      17      2      0      99      3      0      0      0      0      0.5
0      0      #      6
#_age_sel:4
#0      40      1      5      0      99      2      0      0      0      0      0.5
0      0      #      9
#0.01   10      2      2      0      99      3      0      0      0      0      0.5
0      0      #      10
1      #_Selparm_Adjust_Method
0      #_custom_sel-env_setup
0      #_custom_sel-block_setup
#-6      60      44      -2.6   1      0.05   4
#-10     10      .0      .1      1      0.05   4
#-10     10      .0      .1      1      0.05   4
-1      #_selparmdev-phase
#_Variance_adjustments_to_input_values
#_1      2
0      0      0      0      0      0      #_add_to_survey_CV
0      0      0      0      0      0      #_add_to_discard_CV
0      0      0      0      0      0      #_add_to_bodywt_CV
3      4      3      1      1      3      #_mult_by_lencomp_N

```



```

2      2      2      1      1      1      #_mult_by_agecomp_N
1      1      1      1      1      1      #_mult_by_size-at-age_N
30     #_DF_for_discard_like
30     #_DF_for_meanbodywt_like
1      #_maxlambdaphase
0      #_sd_offset
#_lambdas_(columns_for_phases)
1      #_Fishery:_1
1      #_Fishery:_2
1      #_Fishery:_3
0      #_OSP_CPUE:_4
1      #_TagAbundance:_5
1      #_TagCPUE:_6
0      #_discard:_1
0      #_discard:_2
0      #_discard:_3
0      #_discard:_4
0      #_discard:_5
0      #_discard:_6
0      #_meanbodyweight
.1     #_lencomp:_1
.1     #_lencomp:_2
.1     #_lencomp:_3
0      #_lencomp:_4
0      #_lencomp:_5
.1     #_lencomp:_6
1      #_agecomp:_1
1      #_agecomp:_2
1      #_agecomp:_3
0      #_agecomp:_4
0      #_agecomp:_5
0      #_agecomp:_6
1      #_size-age:_1
1      #_size-age:_2
0      #_size-age:_3
0      #_size-age:_4
0      #_size-age:_5
0      #_size-age:_6
1      #_init_equ_catch
1      #_recruitment_Deveations
1      #_parameter-priors
1      #_parameter-dev-vectors
1000   #_crashPenLambda
0.99   #_maximum_allowed_harvest_rate
999

```

```

#
#      SS2      Data      File
#
1915  #      start  year
2006  #      end    year
1     #      number seasons
12    #      months per    season
1     #      spawning    season
3     #      number of    fleets
3     #      number of    surveys
Trawl_1%Sport_2%Line_3%SPTCPUE_4%TagAbun_5%TagCPUE_6 #      Fleets &      Surveys
0.5   0.5   0.5   0.5   0.5   0.5   #      Timing of      Catch and      Survey
2     #      number of      genders
40    #      Maximum Age    in      Plus      Group
#
#      Landings
#
0     0     0     #      Initial Landings      MT      Opposite      Time      Series
      Estimated      Time      Series

```

0	0	0	#	1915							
0	0	0	#	1916							
0	0	0	#	1917							
0	0	0	#	1918							
0	0	0	#	1919							
0	0	0	#	1920							
0	0	0	#	1921							
0	0	0	#	1922							
0	0	0	#	1923							
0	0	0	#	1924							
0	0	0	#	1925							
0	0	0	#	1926							
0	0	0	#	1927							
0	0	0	#	1928							
0	0	0	#	1929							
0	0	0	#	1930							
0	0	0	#	1931							
0	0	0	#	1932							
0	0	0	#	1933							
0	0	0	#	1934							
0	0	0	#	1935							
0	0	0	#	1936							
0	0	0	#	1937							
0	0	0	#	1938							
0	1	0	#	1939							
0	2.8	0	#	1940	Landings	MT	1.4	312	0.4	2	
	2	1									
3.2	4.6	0	#	1941	Landings	MT	1.4	312	1.2	3.2	
	2.8	0									
9.2	6.3	0	#	1942	Landings	MT	0	315.5	0.9	9.2	
	4.6	0									
15.2	8.1	0	#	1943	Landings	MT	0.6	257.6	0.7	15.2	
	6.3	0									
21.2	9.8	0	#	1944	Landings	MT	0.1	232.2	0.2	21.2	
	8.1	0									
27.2	11.6	0	#	1945	Landings	MT	0.2	232.9	1.5	27.2	
	9.8	0									
33.2	13.3	0	#	1946	Landings	MT	0	188.7	1.1	33.2	
	11.6	0									
39.2	15.1	0	#	1947	Landings	MT	0	224.8	1.2	39.2	
	13.3	0									
52	16.8	0	#	1948	Landings	MT	0	221.6	4.3	5.2	
	15.1	0									
51.2	18.6	0	#	1949	Landings	MT	73.1	259.4	4.8	51.2	
	16.8	0									
57.2	20.3	0	#	1950	Landings	MT	9	234.1	15	57.2	
	18.6	0									
63.2	22.1	1.5	#	1951	Landings	MT	0	264.2	8.6	63.2	
	20.3	1.5									
69.2	23.8	2.5	#	1952	Landings	MT	3.3	264.8	65.8	69.2	
	22.1	2.5									
75.2	25.6	3.5	#	1953	Landings	MT	1	358.6	106.3	75.2	
	23.8	3.5									
81.2	27.3	4.5	#	1954	Landings	MT	46.8	316.9	88.4	81.2	
	25.6	4.5									
87.2	29.1	5.5	#	1955	Landings	MT	71.4	342.9	132.3	87.2	
	27.3	5.5									
93.2	30.8	6.5	#	1956	Landings	MT	46.2	332.3	83.4	93.2	
	29.1	6.5									
99.2	32.6	7.5	#	1957	Landings	MT	43.3	387.2	119.4	99.2	
	30.8	7.5									
105.2	34.3	8.5	#	1958	Landings	MT	124.4	369.6	165.3	105.2	
	32.6	8.5									
111.2	36.1	9.5	#	1959	Landings	MT	129	414.2	129.3	111.2	
	34.3	9.5									
117.2	37.8	10.5	#	1960	Landings	MT	82	389.3	220.1	117.2	
	36.1	10.5									
123.2	39.6	11.5	#	1961	Landings	MT	158.6	391.1	103	123.2	
	37.8	11.5									
129.2	41.3	12.5	#	1962	Landings	MT	127.3	305.3	272	129.2	
	39.6	12.5									

135.2	43.1	13.5	#	1963	Landings	MT	218.9	302.2	145.8	135.2
	41.3	13.5								
141.2	44.8	14.5	#	1964	Landings	MT	327.5	244.3	134.1	141.2
	43.1	14.5								
108	46.6	15.5	#	1965	Landings	MT	185.1	135.7	128.9	108
	44.8	15.5								
186	48.3	16.5	#	1966	Landings	MT	213	213.8	81.8	186
	46.6	16.5								
234	50.1	17.5	#	1967	Landings	MT	64.6	144.8	70.5	234
	48.3	17.5								
122	51.8	18.5	#	1968	Landings	MT	321.3	150.7	104	122
	50.1	18.5								
261	53.6	19.5	#	1969	Landings	MT	96	94.2	89.8	261
	51.8	19.5								
303	55.3	20.5	#	1970	Landings	MT	15	76	52.2	303
	53.6	20.5								
134.1	57.1	17.5	#	1971	Landings	MT	347.2	36.8	32.7	134.1
	55.3	17.5								
116	58.8	29.3	#	1972	Landings	MT	156	62.3	36.9	116
	57.1	29.3								
48	60.6	26.8	#	1973	Landings	MT	75	60.6	51.2	48
	58.8	26.8								
75	62.3	51.2	#	1974	Landings	MT	48	58.8	26.8	75
	60.6	51.2								
156	62.3	36.9	#	1975	Landings	MT	116	57.1	29.3	156
	62.3	36.9								
347.2	36.8	32.7	#	1976	Landings	MT	134.1	55.3	17.5	347.2
	36.8	32.7								
15	76	52.2	#	1977	Landings	MT	303	53.6	20.5	15
	76	52.2								
96	94.2	89.8	#	1978	Landings	MT	261	51.8	19.5	96
	94.2	89.8								
321.3	150.7	104	#	1979	Landings	MT	122	50.1	18.5	321.3
	150.7	104								
64.6	144.8	70.5	#	1980	Landings	MT	234	48.3	17.5	64.6
	144.8	70.5								
213	213.8	81.8	#	1981	Landings	MT	186	46.6	16.5	213
	213.8	81.8								
185.1	135.7	128.9	#	1982	Landings	MT	108	44.8	15.5	185.1
	135.7	128.9								
327.5	244.3	134.1	#	1983	Landings	MT	141.2	43.1	14.5	327.5
	244.3	134.1								
218.9	302.2	145.8	#	1984	Landings	MT	135.2	41.3	13.5	218.9
	302.2	145.8								
127.3	305.3	272	#	1985	Landings	MT	129.2	39.6	12.5	127.3
	305.3	272								
158.6	391.1	103	#	1986	Landings	MT	123.2	37.8	11.5	158.6
	391.1	103								
82	389.3	220.1	#	1987	Landings	MT	117.2	36.1	10.5	82
	389.3	220.1								
129	414.2	129.3	#	1988	Landings	MT	111.2	34.3	9.5	129
	414.2	129.3								
124.4	369.6	165.3	#	1989	Landings	MT	105.2	32.6	8.5	124.4
	369.6	165.3								
43.3	387.2	119.4	#	1990	Landings	MT	99.2	30.8	7.5	43.3
	387.2	119.4								
46.2	332.3	83.4	#	1991	Landings	MT	93.2	29.1	6.5	46.2
	332.3	83.4								
71.4	342.9	132.3	#	1992	Landings	MT	87.2	27.3	5.5	71.4
	342.9	132.3								
46.8	316.9	88.4	#	1993	Landings	MT	81.2	25.6	4.5	46.8
	316.9	88.4								
1	358.6	106.3	#	1994	Landings	MT	75.2	23.8	3.5	1
	358.6	106.3								
3.3	264.8	65.8	#	1995	Landings	MT	69.2	22.1	2.5	3.3
	264.8	65.8								
0	264.2	8.6	#	1996	Landings	MT	63.2	20.3	1.5	0
	264.2	8.6								
9	234.1	15	#	1997	Landings	MT	57.2	18.6	0	9
	234.1	15								

73.1	259.4	4.8	#	1998	Landings	MT	51.2	16.8	0	73.1
	259.4	4.8								
0	221.6	4.3	#	1999	Landings	MT	5.2	15.1	0	0
	221.6	4.3								
0	224.8	1.2	#	2000	Landings	MT	39.2	13.3	0	0
	224.8	1.2								
0	188.7	1.1	#	2001	Landings	MT	33.2	11.6	0	0
	188.7	1.1								
0.2	238.9	1.5	#	2002	Landings	MT	27.2	9.8	0	0.2
	232.9	1.5								
0.1	237.1	0.2	#	2003	Landings	MT	21.2	8.1	0	0.1
	232.2	0.2								
0.6	268	0.7	#	2004	Landings	MT	15.2	6.3	0	0.6
	257.6	0.7								
0	331.7	0.9	#	2005	Landings	MT	9.2	4.6	0	0
	315.5	0.9								
1.4	321.5	1.2	#	2006	Landings	MT	3.2	2.8	0	1.4
	312	1.2								
#	1.4	312	0.4							
#	Surveys									
#CPUE_from_Area_2_Raw_Means										

#Year	Season	Type	Value	ln(1+cv)
28				
1990	1	4	5.73	0.728959186
1991	1	4	5.426	0.703659282
1992	1	4	4.768	0.695933036
1993	1	4	4.242	0.759157379
1994	1	4	4.426	0.740246527
1995	1	4	4.069	0.705679139
#1996	1	4	4.569	0.646320543
#1997	1	4	3.932	0.699568754
#1998	1	4	4.805	0.622019705
#1999	1	4	4.856	0.620031093
#2000	1	4	5.028	0.604528452
#2001	1	4	4.288	0.673016624
#2002	1	4	5.01	0.607570313
#2003	1	4	4.946	0.607124035
#2004	1	4	5.571	0.553122333
#2005	1	4	5.355	0.562373981
#2006	1	4	5.201	0.586151481

#Tag_Abundance_from_Area_2_Raw_Means				
#Year	Season	Type	Value	ln(1+cv)
2000	1	5	1389	0.0854
2001	1	5	2997	0.1157
2002	1	5	1944	0.0806
2003	1	5	2119	0.0624
2004	1	5	2996	0.1107
2005	1	5	5015	0.1276
2006	1	5	3464	0.08

#TagCPUE_from_Area_2_Raw_Means				
#Year	Season	Type	Value	ln(1+cv)
1981	1	6	4.75	0.666
1986	1	6	2.337	0.5993
1987	1	6	1.172	0.6344
1988	1	6	0.826	0.5539
1989	1	6	1.236	0.9771
1990	1	6	0.991	0.8439
1998	1	6	2.46	0.813
1999	1	6	3.061	0.7407
2000	1	6	2.203	0.5684
2001	1	6	4.657	0.6076
2002	1	6	5.486	0.5034
2003	1	6	6.245	0.5913

2004	1	6	9.414	0.5149							
2005	1	6	10.192	0.7579							
2006	1	6	10.543	0.4205							
#	Discards										
#											
2											
-1											
#											
#	Mean	Body	Weight								
#											
0											
#											
#	Composition	Conditioners									
#											
0.0001											
0.0001											
#											
#	Length	Composition									
#											
#Yr	Seas	Flt/Svy	Gender	Part	Nsamp	datavector(female-male)					
19											
20	22	24	26	28	30	32	34	36	38	40	42
	44	46	48	50	52	54	56				
#											
67											
1976	1	1	3	0	28	0	0	0	0	0	0
	0	0	0	0.0051	0.0102	0.0332	0.0652	0.0985	0.0806	0.0793	0.0678
	0.0358	0.0396	0	0	0	0	0.0013	0	0	0	0
	0.0026	0.0307	0.0729	0.1036	0.1189	0.0844	0.0473	0.0179	0.0026	0.0026	
1980	1	1	3	0	14	0	0	0	0	0	0
	0	0.0049	0.0049	0.0388	0.0194	0.034	0.0485	0.0631	0.0825	0.0194	0.0146
	0.0097	0.0097	0	0	0	0	0	0	0	0	0.0049
	0.0243	0.034	0.0922	0.1165	0.1359	0.1165	0.0631	0.034	0.0243	0.0049	
1981	1	1	3	0	28	0	0	0	0	0	0
	0.0025	0	0.0025	0.0075	0.0225	0.035	0.0625	0.08	0.0875	0.055	0.0475
	0.0175	0.015	0	0	0	0	0	0	0	0.0025	0.005
	0.0175	0.0575	0.05	0.1	0.12	0.1	0.0625	0.035	0.01	0.005	
1982	1	1	3	0	28	0	0	0	0	0	0
	0	0.0025	0.01	0.025	0.0325	0.075	0.08	0.0625	0.0575	0.0225	0.025
	0.0025	0.005	0	0	0	0	0	0	0.005	0.0025	0.01
	0.0275	0.0875	0.1475	0.1175	0.1	0.0625	0.0275	0.0125	0	0	
1983	1	1	3	0	56	0	0	0	0	0	0
	0	0	0.0063	0.015	0.0363	0.0625	0.0788	0.0675	0.0738	0.05	0.0388
	0.01	0.0038	0	0	0	0	0	0	0.0025	0.0025	0.0075
	0.0163	0.07	0.1138	0.13	0.0963	0.0763	0.0338	0.0075	0	0.0013	
1984	1	1	3	0	21	0	0	0	0	0	0
	0	0	0.0033	0.02	0.0367	0.0367	0.0733	0.1	0.0633	0.0333	0.02
	0.0167	0	0	0	0	0	0	0	0	0.0133	0.02
	0.0433	0.0767	0.12	0.1267	0.09	0.0567	0.0333	0.01	0.0067	0	
1986	1	1	3	0	57	0	0	0	0	0	0
	0	0.0031	0.0062	0.0093	0.059	0.0497	0.087	0.059	0.0932	0.0994	0.0559
	0.0093	0.0155	0	0	0	0	0	0	0	0.0031	0.0124
	0.0217	0.0683	0.0963	0.1056	0.0994	0.0311	0.0124	0.0031	0	0	
1987	1	1	3	0	71	0	0	0	0	0	0
	0	0	0	0.0025	0.01	0.0299	0.0623	0.0823	0.1471	0.0873	0.0599
	0.0399	0.0299	0	0	0	0	0	0	0	0	0.0025
	0.005	0.0249	0.0698	0.1446	0.1172	0.0499	0.0224	0.0125	0	0	
1988	1	1	3	0	18	0	0	0	0	0	0
	0	0	0	0	0.02	0.02	0.08	0.1	0.12	0.12	0.03
	0.01	0.01	0	0	0	0	0.01	0	0	0	0.01
	0	0.01	0.03	0.08	0.19	0.09	0.03	0.03	0	0.01	
1989	1	1	3	0	40	0	0	0	0	0	0
	0	0	0	0.0044	0	0.0311	0.0489	0.08	0.1067	0.12	0.1022
	0.0889	0.0578	0	0	0	0	0	0	0	0.0044	0
	0.0044	0.0178	0.0222	0.0533	0.0889	0.0978	0.04	0.0178	0.0044	0.0089	
1990	1	1	3	0	44	0	0	0	0	0	0
	0	0	0.004	0.008	0.0241	0.0402	0.0281	0.0723	0.0723	0.0803	0.0562
	0.0482	0.0281	0	0	0	0	0	0	0	0	0.0161
	0.0201	0.0442	0.0683	0.0803	0.1044	0.1365	0.0522	0.0161	0	0	
1991	1	1	3	0	54	0	0	0	0	0	0
	0	0.0033	0.0066	0.0066	0.0132	0.0728	0.0695	0.0861	0.0695	0.0662	0.0232

		0.0464	0.0166	0	0	0	0	0	0	0	0.0033	0
		0.0099	0.0397	0.0695	0.0662	0.1026	0.0795	0.0828	0.0464	0.0199	0	0
1992	1	1	3	0	0	36	0	0	0	0	0	0
	0	0	0	0.01	0.025	0.055	0.06	0.085	0.09	0.075	0.035	0
	0.03	0.03	0	0	0	0	0	0	0	0.005	0.01	0
	0.01	0.065	0.065	0.16	0.085	0.07	0.035	0	0	0	0	0
1993	1	1	3	0	22	0	0	0	0	0	0	0
	0	0	0	0.008	0.024	0.048	0.032	0.064	0.056	0.064	0.08	0
	0.048	0.008	0	0	0	0	0	0	0	0	0	0
	0.056	0.024	0.072	0.088	0.128	0.104	0.08	0.008	0.008	0	0	0
#1994	1	1	3	0	9	0	0	0	0	0	0	0
	0	0	0.0612	0	0	0.0612	0.1224	0	0.0408	0.0612	0.0204	0
	0.0408	0	0	0	0	0	0	0	0	0	0	0
	0	0.0408	0.102	0.102	0.1224	0.102	0.102	0.0204	0	0	0	0
#1995	1	1	3	0	9	0	0	0	0	0	0	0
	0	0	0	0.04	0	0.06	0.02	0.04	0.02	0.04	0	0
	0	0.02	0	0	0	0	0.02	0.02	0	0	0	0
	0.02	0.02	0.06	0.2	0.14	0.12	0.1	0.04	0.02	0	0	0
#1998	1	1	3	0	14	0	0	0	0	0	0	0
	0	0	0	0.0235	0.0235	0.0941	0.1059	0.0941	0.0588	0.0118	0	0
	0	0	0	0	0	0	0	0	0	0	0.0353	0
	0.0235	0.1294	0.1765	0.1412	0.0588	0.0235	0	0	0	0	0	0
#2002	1	1	3	0	8	0	0	0	0	0	0	0
	0	0	0	0	0	0	0.02	0.14	0.16	0.18	0.08	0
	0.02	0	0	0	0	0	0	0	0	0	0	0
	0.02	0	0.04	0.12	0.16	0.06	0	0	0	0	0	0
#1980	1	2	0	0	9	0	0	0	0	0	0	0
	0.002	0.0039	0.0236	0.0394	0.0571	0.0886	0.1575	0.1594	0.25	0.1496	0.0413	0
	0.0276	0	0	0	0	0	0	0	0.002	0.0039	0.0236	0
	0.0394	0.0571	0.0886	0.1575	0.1594	0.25	0.1496	0.0413	0.0276	0	0	0
1980	1	2	3	0	10	0	0	0	0	0	0.0014	0
	0	0.0071	0.0085	0.0299	0.0341	0.0327	0.0284	0.0356	0.0512	0.027	0.0199	0
	0.0028	0.0014	0	0	0	0	0	0.0014	0	0.0057	0.0284	0
	0.0341	0.0612	0.0512	0.1124	0.1607	0.1579	0.0811	0.0256	0	0	0	0
1981	1	2	3	0	30	0	0	0	0.0103	0.0103	0	0
	0.0206	0.0206	0	0.0206	0.0103	0	0.1031	0.0515	0.0619	0.0103	0	0
	0	0	0	0	0	0	0	0	0.0206	0.0309	0.0309	0
	0.0309	0.0722	0.1134	0.1134	0.1443	0.0619	0.0412	0.0206	0	0	0	0
#1982	1	2	0	0	22	0.0088	0.0109	0.0044	0.0022	0.0073	0.008	0
	0.0146	0.0248	0.0518	0.0904	0.1196	0.1276	0.1488	0.1145	0.1371	0.0795	0.0343	0
	0.0131	0.0022	0.0088	0.0109	0.0044	0.0022	0.0073	0.008	0.0146	0.0248	0.0518	0
	0.0904	0.1196	0.1276	0.1488	0.1145	0.1371	0.0795	0.0343	0.0131	0.0022	0	0
1982	1	2	3	0	12	0	0	0	0	0	0	0
	0	0.0177	0.0177	0.0442	0.0796	0.0619	0.0796	0.0531	0.0265	0.0088	0	0
	0	0	0	0	0	0	0	0	0.0088	0.0088	0.0354	0
	0.115	0.0973	0.0619	0.115	0.0973	0.0531	0.0177	0	0	0	0	0
#1983	1	2	0	0	1	0	0	0	0	0	0.04	0
	0.0733	0.12	0.1133	0.1733	0.1733	0.12	0.08	0.0467	0.0133	0.0267	0.02	0
	0	0	0	0	0	0	0	0.04	0.0733	0.12	0.1133	0
	0.1733	0.1733	0.12	0.08	0.0467	0.0133	0.0267	0.02	0	0	0	0
#1984	1	2	0	0	2	0	0	0	0.1	0	0	0
	0.2	0.1	0.2	0	0	0.4	0	0	0	0	0	0
	0	0	0	0	0	0.1	0	0	0.2	0.1	0.2	0
	0	0	0.4	0	0	0	0	0	0	0	0	0
1984	1	2	3	0	25	0	0	0	0.0029	0.0014	0.0115	0
	0.033	0.0445	0.0603	0.0848	0.0905	0.0876	0.0647	0.0546	0.0417	0.0158	0.0129	0
	0.0043	0.0057	0.0014	0	0	0	0.0014	0.0029	0.0029	0.0172	0.0302	0
	0.0388	0.0704	0.0718	0.0503	0.0431	0.0201	0.023	0.0086	0.0014	0	0	0
#1985	1	2	0	0	1	0.1884	0.0072	0	0.0072	0.0217	0.0435	0
	0.1594	0.1377	0.2391	0.1014	0.058	0.0145	0.0072	0	0.0072	0	0	0
	0	0.0072	0.1884	0.0072	0	0.0072	0.0217	0.0435	0.1594	0.1377	0.2391	0
	0.1014	0.058	0.0145	0.0072	0	0.0072	0	0	0	0.0072	0	0
1985	1	2	3	0	3	0	0	0	0	0	0	0
	0.0127	0.019	0.0316	0.0633	0.0759	0.0443	0.0759	0.0633	0.0443	0.0127	0.019	0
	0.0063	0.0063	0	0	0	0	0	0	0	0.0063	0.038	0
	0.0759	0.0633	0.0759	0.0886	0.1076	0.038	0.019	0.0127	0	0	0	0
1986	1	2	3	0	17	0	0	0	0	0.002	0.0039	0
	0.0098	0.0117	0.0391	0.0469	0.0723	0.0801	0.0938	0.0488	0.0313	0.0234	0.0098	0
	0	0	0	0	0	0	0	0.0039	0.0117	0.0293	0.0547	0
	0.0957	0.0957	0.1055	0.0566	0.043	0.0176	0.0078	0.0059	0	0	0	0

1987	1	2	3	0	21	0	0	0	0	0	0.0047
	0.014	0.0171	0.0295	0.0481	0.0543	0.0698	0.0837	0.0713	0.0543	0.0341	0.0202
	0.0124	0.0016	0	0	0	0	0	0.014	0.014	0.0155	0.0357
	0.0326	0.0651	0.0775	0.0713	0.0605	0.0682	0.0155	0.0124	0.0031	0	
1988	1	2	3	0	15	0	0	0	0	0.0022	0.0177
	0.0067	0.0288	0.0421	0.0643	0.0576	0.0909	0.0909	0.0576	0.0443	0.0244	0.0089
	0	0.0022	0	0	0	0.0022	0.0022	0.0067	0.0222	0.0111	0.0377
	0.0665	0.0798	0.0865	0.0488	0.0421	0.0288	0.0222	0.0022	0.0022	0	
1989	1	2	3	0	13	0	0	0	0	0	0.005
	0.0025	0.0126	0.0176	0.0579	0.0806	0.0957	0.0957	0.0705	0.0605	0.0403	0.0076
	0	0	0	0	0	0	0	0.0025	0.0101	0.0327	0.0428
	0.0705	0.1083	0.0806	0.0479	0.0378	0.0151	0.005	0	0	0	
1990	1	2	3	0	9	0	0	0	0	0.0034	0.0034
	0.0138	0.0103	0.0379	0.0828	0.1241	0.0828	0.0966	0.0724	0.0138	0	0.0034
	0	0	0	0	0.0034	0	0.0034	0	0	0.0276	0.0483
	0.0621	0.0897	0.0759	0.0517	0.0345	0.031	0.0276	0	0	0	
1991	1	2	3	0	22	0	0	0	0	0.0125	0.0083
	0.0181	0.0403	0.0458	0.075	0.0778	0.0903	0.0611	0.0611	0.0278	0.0194	0.0056
	0.0028	0.0014	0	0	0	0.0014	0.0056	0.0125	0.0153	0.0306	0.0542
	0.0708	0.0833	0.0597	0.0556	0.0278	0.0236	0.0097	0.0014	0.0014	0	
1992	1	2	3	0	29	0	0	0.0011	0.0023	0.0023	0.0091
	0.0136	0.0272	0.0397	0.0613	0.0965	0.0942	0.0658	0.0443	0.0409	0.0125	0.0045
	0.0023	0.0011	0	0	0	0.0011	0.0045	0.0102	0.0159	0.0204	0.0522
	0.059	0.0942	0.0749	0.0681	0.042	0.0193	0.0125	0.0057	0.0011	0	
1993	1	2	3	0	28	0	0	0	0	0.0023	0.0163
	0.0198	0.0431	0.0664	0.0733	0.0955	0.0745	0.064	0.0536	0.0303	0.0198	0.0081
	0.0081	0.0012	0	0	0	0	0	0.0116	0.021	0.0442	0.0547
	0.0664	0.071	0.0559	0.0547	0.0233	0.0116	0.0047	0.0035	0.0012	0	
1994	1	2	3	0	28	0	0	0	0	0.0023	0.0035
	0.0208	0.044	0.0428	0.0856	0.088	0.0914	0.0567	0.037	0.0197	0.0301	0.0116
	0.0046	0	0	0	0	0	0.0012	0.0093	0.0162	0.0579	0.0451
	0.0752	0.0729	0.0706	0.0451	0.0289	0.022	0.0116	0.0058	0	0	
1995	1	2	3	0	26	0	0	0	0	0.0012	0.0037
	0.0074	0.0333	0.0653	0.0948	0.0998	0.085	0.0702	0.0333	0.0222	0.016	0.0062
	0.0037	0	0	0	0	0	0.0012	0.0049	0.0185	0.0357	0.0776
	0.0936	0.0764	0.0665	0.0468	0.0222	0.0086	0.0025	0.0012	0.0025	0	
1996	1	2	3	0	27	0	0	0	0.0012	0.0012	0.006
	0.0193	0.0398	0.0736	0.1049	0.1049	0.0676	0.047	0.0277	0.0181	0.006	0.0012
	0	0	0	0	0	0.0024	0.0024	0.0024	0.0205	0.0507	0.0881
	0.0929	0.1025	0.0651	0.0241	0.0205	0.0084	0	0	0	0.0012	
1997	1	2	3	0	29	0	0	0	0	0	0.0022
	0.0189	0.04	0.0633	0.0756	0.0867	0.0756	0.0533	0.0344	0.02	0.02	0.0056
	0.0044	0.0022	0	0	0	0.0033	0.0022	0.0044	0.0233	0.0356	0.0678
	0.0889	0.11	0.0633	0.0467	0.0289	0.0122	0.0089	0.0022	0	0	
1998	1	2	3	0	40	0	0	0	0	0.0053	0.0106
	0.028	0.0355	0.0559	0.0854	0.0824	0.0695	0.0544	0.028	0.0144	0.0136	0.0008
	0	0.0008	0	0	0	0	0.0023	0.0136	0.0333	0.0438	0.0673
	0.0907	0.0998	0.0703	0.0537	0.0242	0.0128	0.0023	0.0008	0.0008	0	
1999	1	2	3	0	44	0	0	0.0006	0.0012	0.0042	0.0126
	0.0263	0.04	0.0592	0.0813	0.0843	0.0699	0.0562	0.0359	0.0132	0.0036	0.0012
	0.0012	0.0006	0	0	0	0.0006	0.0012	0.0185	0.0281	0.0466	0.0831
	0.095	0.0932	0.0652	0.046	0.0185	0.0048	0.0036	0.0024	0.0012	0.0006	
2000	1	2	3	0	43	0	0	0	0.0012	0.0042	0.0079
	0.0176	0.0382	0.0576	0.0885	0.1091	0.0873	0.0812	0.0303	0.0212	0.003	0.0018
	0.0018	0	0	0	0	0	0.0036	0.0091	0.0188	0.0479	0.0661
	0.08	0.0939	0.0739	0.0315	0.0164	0.0055	0.0018	0	0.0006	0	
2001	1	2	3	0	47	0	0	0	0	0	0.0028
	0.013	0.0355	0.0558	0.0986	0.1189	0.1048	0.0614	0.0271	0.018	0.009	0.0023
	0.0017	0	0	0	0	0	0.0011	0.0056	0.0152	0.0355	0.0716
	0.1071	0.0891	0.0705	0.031	0.0147	0.0056	0	0.0023	0.0011	0.0006	
#2002	1	2	3	0	72	0	0	0.0005	0.0005	0.0005	0
	0.0049	0.0168	0.0481	0.0898	0.1028	0.1141	0.0984	0.0606	0.0292	0.0059	0.0027
	0.0011	0.0005	0	0	0	0.0011	0.0016	0.0027	0.0087	0.0276	0.0573
	0.0957	0.1001	0.0757	0.0335	0.013	0.0043	0.0016	0.0005	0	0	
#2003	1	2	0	0	9	0	0	0	0.0013	0.0077	0.0103
	0.0333	0.0833	0.1308	0.1487	0.2064	0.1603	0.1038	0.0641	0.0282	0.0128	0.0051
	0.0038	0	0	0	0	0.0013	0.0077	0.0103	0.0333	0.0833	0.1308
	0.1487	0.2064	0.1603	0.1038	0.0641	0.0282	0.0128	0.0051	0.0038	0	
2003	1	2	3	0	70	0	0	0	0	0.0005	0.0011
	0.0059	0.0184	0.0394	0.0691	0.1021	0.128	0.0977	0.0551	0.0232	0.0151	0.0059

		0.0016	0	0	0	0.0005	0	0.0005	0.0016	0.0108	0.0286	0.0524
		0.0945	0.1037	0.0729	0.0481	0.0151	0.0038	0.0038	0.0005	0	0	0
#2004	1	2	0	0	0	9	0	0	0	0.0021	0.0042	0.0127
		0.0276	0.0467	0.1083	0.1826	0.1868	0.1571	0.1253	0.0425	0.034	0.0127	0.0212
		0.0127	0.0234	0	0	0	0.0021	0.0042	0.0127	0.0276	0.0467	0.1083
		0.1826	0.1868	0.1571	0.1253	0.0425	0.034	0.0127	0.0212	0.0127	0.0234	0
2004	1	2	3	0	57	0	0	0	0	0.0012	0.0018	0.0048
		0.0133	0.023	0.0387	0.0762	0.0992	0.1168	0.0768	0.0581	0.0302	0.0097	0.0054
		0.0018	0.0006	0	0	0	0	0	0.003	0.0139	0.0254	0.0387
		0.0907	0.1071	0.0762	0.0532	0.0169	0.0073	0.0048	0.003	0.0006	0.0012	0
#2005	1	2	0	0	9	0.0029	0	0	0	0.0029	0.0058	0.0259
		0.049	0.1037	0.1153	0.1441	0.2046	0.1383	0.0951	0.0548	0.0231	0.0115	0.0115
		0.0029	0.0086	0.0029	0	0	0.0029	0.0058	0.0259	0.049	0.1037	0.1153
		0.1441	0.2046	0.1383	0.0951	0.0548	0.0231	0.0115	0.0115	0.0029	0.0086	0
2005	1	2	3	0	67	0	0	0	0	0	0.0018	0.0042
		0.0066	0.0253	0.0451	0.083	0.1064	0.1046	0.1052	0.0463	0.0367	0.0132	0.0078
		0.0042	0	0	0	0	0	0	0.0006	0.006	0.0174	0.0325
		0.08	0.1046	0.08	0.0511	0.0235	0.0102	0.0012	0.0012	0.0012	0	0
#2006	1	2	0	0	9	0	0.0018	0	0	0	0.0018	0.0159
		0.0584	0.1204	0.1434	0.1752	0.1416	0.131	0.0903	0.0726	0.0248	0.0142	0.0053
		0.0018	0.0018	0	0.0018	0	0	0.0018	0.0159	0.0584	0.1204	0.1434
		0.1752	0.1416	0.131	0.0903	0.0726	0.0248	0.0142	0.0053	0.0018	0.0018	0
2006	1	2	3	0	100	0	0.0006	0	0.0006	0.0012	0.0075	0
		0.01	0.0305	0.0715	0.0721	0.0883	0.0734	0.0715	0.0429	0.0162	0.0087	0.0031
		0	0.0006	0	0	0	0.0006	0.0019	0.0044	0.0087	0.0224	0.0585
		0.0858	0.1132	0.1007	0.0678	0.0261	0.0087	0.0012	0.0012	0	0	0
#1980	1	3	0	0	14	0	0	0	0	0	0	0
		0	0.0104	0.0208	0.0313	0.0938	0.1146	0.1979	0.1563	0.1771	0.1354	0.0521
		0	0.0104	0	0	0	0	0	0	0	0.0104	0.0208
		0.0313	0.0938	0.1146	0.1979	0.1563	0.1771	0.1354	0.0521	0	0.0104	0
#1982	1	3	0	0	5	0	0	0	0	0	0	0.0345
		0.0345	0.069	0.2414	0.1034	0.1034	0.1034	0.1379	0.1379	0.0345	0	0
		0	0	0	0	0	0	0.0345	0.0345	0.069	0.2414	0
		0.1034	0.1034	0.1034	0.1379	0.1379	0.0345	0	0	0	0	0
#1983	1	3	0	0	19	0	0	0	0	0	0	0.0833
		0.0417	0.0833	0.2083	0.2083	0.2083	0.0833	0.0417	0	0.0417	0	0
		0	0	0	0	0	0	0.0833	0.0417	0.0833	0.2083	0
		0.2083	0.2083	0.0833	0.0417	0	0.0417	0	0	0	0	0
#1983	1	3	3	0	5	0	0	0	0	0	0	0
		0.03	0.02	0.09	0.06	0.07	0.07	0.02	0.07	0	0	0.01
		0	0	0	0	0	0	0	0.03	0.02	0.02	0.01
		0.07	0.03	0.07	0.12	0.04	0.14	0.01	0	0	0	0
#1984	1	3	3	0	7	0	0	0	0	0	0	0
		0.02	0.02	0.05	0.07	0.07	0.09	0.03	0.03	0.02	0.01	0
		0	0	0	0	0	0	0.01	0.02	0.03	0.05	0
		0.1	0.13	0.1	0.04	0.08	0.03	0	0	0	0	0
1986	1	3	3	0	100	0	0	0	0	0	0.0019	0
		0.0076	0.0133	0.0228	0.038	0.0626	0.0569	0.0911	0.1044	0.093	0.0759	0.055
		0.0114	0.0038	0	0	0	0	0	0	0.0057	0.0095	0.0266
		0.0361	0.055	0.0778	0.0721	0.0323	0.0285	0.0114	0.0038	0.0019	0.0019	0
1987	1	3	3	0	125	0	0	0	0	0	0.0014	0.0042
		0.0111	0.025	0.0305	0.0319	0.0555	0.0638	0.0749	0.0652	0.043	0.0485	0.0236
		0.0097	0.0069	0	0	0	0	0.0028	0.0028	0.0097	0.0222	0.0458
		0.0527	0.0693	0.0777	0.0707	0.0721	0.0416	0.018	0.0125	0.0069	0	0
1988	1	3	3	0	76	0	0	0	0	0	0.0024	0
		0.0118	0.0189	0.0142	0.0307	0.059	0.092	0.1085	0.0896	0.0495	0.0425	0.0165
		0.0142	0.0071	0	0	0	0	0	0	0.0118	0.0142	0.0236
		0.0542	0.0755	0.0755	0.0495	0.059	0.0425	0.0189	0.0165	0.0024	0	0
1989	1	3	3	0	53	0	0	0	0	0	0	0.0033
		0	0.01	0.0334	0.0301	0.0502	0.0301	0.0502	0.1137	0.087	0.0368	0.0368
		0.0201	0.01	0	0	0	0	0	0	0	0.01	0.0268
		0.0602	0.0401	0.0702	0.1104	0.0936	0.0502	0.01	0.0134	0.0033	0	0
1990	1	3	3	0	21	0	0	0	0.008	0.032	0.064	0.088
		0.04	0.032	0.056	0.048	0.072	0.032	0.024	0.024	0.024	0.032	0.016
		0	0	0	0	0.024	0.016	0.04	0.064	0.032	0.024	0.024
		0.04	0.048	0.048	0.024	0.008	0.008	0	0	0.008	0	0
1991	1	3	3	0	88	0	0	0	0	0	0.0063	0.0126
		0.0358	0.04	0.0589	0.0737	0.08	0.0547	0.0568	0.0379	0.0232	0.0274	0.0063
		0	0.0021	0	0	0	0	0.0042	0.0168	0.0295	0.0568	0.0589
		0.0611	0.0863	0.0695	0.0337	0.0316	0.0189	0.0105	0.0042	0.0021	0	0

1992	1	3	3	0	49	0	0	0	0	0.011	0.011
	0.0037	0.0733	0.0989	0.0696	0.0989	0.0586	0.0586	0.0366	0.0293	0.0073	0.0073
	0	0	0	0	0	0	0.0073	0.011	0.022	0.044	0.0513
	0.0733	0.0513	0.0659	0.0696	0.0256	0.011	0	0.0037	0	0	
1993	1	3	3	0	58	0	0	0	0.0031	0.0031	0.0123
	0.0031	0.0617	0.0895	0.0772	0.0802	0.0525	0.071	0.0432	0.0247	0.0216	0
	0	0	0	0	0	0	0.0031	0.0031	0.0123	0.0494	0.0494
	0.0648	0.0864	0.071	0.0772	0.037	0.0031	0	0	0	0	
1994	1	3	3	0	44	0	0	0	0.004	0.012	0.044
	0.068	0.068	0.068	0.08	0.08	0.048	0.04	0.008	0.008	0.004	0
	0	0	0	0	0	0	0.016	0.016	0.032	0.052	0.072
	0.056	0.072	0.068	0.052	0.012	0.02	0	0	0	0	
1995	1	3	3	0	40	0	0	0	0	0	0.0089
	0.0268	0.0446	0.067	0.0714	0.0625	0.0759	0.0893	0.0268	0.0134	0.0045	0.0089
	0	0	0	0	0	0	0.0089	0.0357	0.0268	0.0357	0.0759
	0.0893	0.0804	0.058	0.0536	0.0268	0.0089	0	0	0	0	
1981	1	6	0	0	29	0	0	0.0004	0.0006	0.0006	0.0045
	0.0159	0.0416	0.0855	0.1166	0.1255	0.1247	0.137	0.1569	0.117	0.0492	0.0142
	0.0023	0.0004	0	0	0.0004	0.0006	0.0006	0.0045	0.0159	0.0416	0.0855
	0.1166	0.1255	0.1247	0.137	0.1569	0.117	0.0492	0.0142	0.0023	0.0004	
1982	1	6	0	0	24	0	0	0.0024	0.0024	0.0044	0.0047
	0.0142	0.0305	0.0665	0.1322	0.1535	0.1516	0.1504	0.1417	0.0926	0.0372	0.0115
	0.0008	0.0004	0	0	0.0024	0.0024	0.0044	0.0047	0.0142	0.0305	0.0665
	0.1322	0.1535	0.1516	0.1504	0.1417	0.0926	0.0372	0.0115	0.0008	0.0004	
1983	1	6	0	0	29	0	0	0.0005	0.0015	0.0045	0.0198
	0.06	0.1011	0.1269	0.1477	0.1472	0.1487	0.1259	0.0962	0.0407	0.0183	0.004
	0.0005	0	0	0	0.0005	0.0015	0.0045	0.0198	0.06	0.1011	0.1269
	0.1477	0.1472	0.1487	0.1259	0.0962	0.0407	0.0183	0.004	0.0005	0	
1984	1	6	0	0	24	0	0	0.0015	0.0089	0.0193	0.0297
	0.0996	0.1441	0.1694	0.1441	0.1441	0.0966	0.0609	0.0416	0.0282	0.003	0.003
	0	0	0	0.0015	0.0089	0.0193	0.0297	0.0565	0.0996	0.1441	0.1694
	0.1441	0.1441	0.0966	0.0609	0.0416	0.0282	0.003	0.003	0	0	
#1985	1	6	0	0	64	0.0002	0.0002	0.0031	0.0025	0.006	0.0151
	0.0501	0.1035	0.166	0.1766	0.1708	0.1387	0.0987	0.0735	0.036	0.0141	0.0029
	0.0004	0	0.0002	0.0002	0.0031	0.0025	0.006	0.0151	0.0501	0.1035	0.166
	0.1766	0.1708	0.1387	0.0987	0.0735	0.036	0.0141	0.0029	0.0004	0	
1986	1	6	0	0	103	0.0002	0.0002	0.0007	0.0017	0.005	0.0133
	0.0302	0.067	0.1064	0.1577	0.1761	0.1616	0.1546	0.1116	0.0395	0.0135	0.0041
	0.0007	0	0.0002	0.0002	0.0007	0.0017	0.005	0.0133	0.0302	0.067	0.1064
	0.1577	0.1761	0.1616	0.1546	0.1116	0.0395	0.0135	0.0041	0.0007	0	
1987	1	6	0	0	122	0	0	0.0009	0.0025	0.007	0.0101
	0.0363	0.0877	0.1338	0.1631	0.1739	0.1853	0.134	0.0723	0.018	0.0059	0.0021
	0.0008	0.0002	0	0.0009	0.0025	0.007	0.0101	0.0216	0.0363	0.0877	0.1338
	0.1631	0.1739	0.1853	0.134	0.0723	0.018	0.0059	0.0021	0.0008	0.0002	
1988	1	6	0	0	103	0.0003	0.0004	0.0051	0.0105	0.016	0.0326
	0.0465	0.0603	0.0869	0.1227	0.1433	0.1745	0.1622	0.1071	0.0416	0.0131	0.0045
	0.0023	0.0006	0.0003	0.0004	0.0051	0.0105	0.016	0.0326	0.0465	0.0603	0.0869
	0.1227	0.1433	0.1745	0.1622	0.1071	0.0416	0.0131	0.0045	0.0023	0.0006	
1989	1	6	0	0	103	0	0	0.0006	0.0033	0.0081	0.0215
	0.0695	0.0993	0.1085	0.1265	0.1362	0.1476	0.1311	0.095	0.0288	0.0105	0.0018
	0.0007	0.0006	0	0.0006	0.0033	0.0081	0.0215	0.047	0.0695	0.0993	0.1085
	0.1265	0.1362	0.1476	0.1311	0.095	0.0288	0.0105	0.0018	0.0007	0.0006	
1990	1	6	0	0	108	0.0004	0.0026	0.0116	0.0211	0.026	0.0464
	0.0766	0.1349	0.1533	0.1321	0.126	0.1061	0.093	0.0684	0.0268	0.0099	0.0026
	0.0012	0.0007	0.0004	0.0026	0.0116	0.0211	0.026	0.0464	0.0766	0.1349	0.1533
	0.1321	0.126	0.1061	0.093	0.0684	0.0268	0.0099	0.0026	0.0012	0.0007	
1998	1	6	0	0	83	0	0	0.0019	0.0023	0.0034	0.0129
	0.0636	0.12	0.2034	0.2224	0.171	0.107	0.0468	0.0129	0.0038	0.0008	0
	0	0	0	0.0019	0.0023	0.0034	0.0129	0.0278	0.0636	0.12	0.2034
	0.2224	0.171	0.107	0.0468	0.0129	0.0038	0.0008	0	0	0	
1999	1	6	0	0	93	0	0	0.0003	0.0003	0.0029	0.0063
	0.0434	0.0811	0.157	0.2105	0.1915	0.1432	0.0894	0.0408	0.0109	0.004	0.0009
	0	0.0003	0	0.0003	0.0003	0.0029	0.0063	0.0173	0.0434	0.0811	0.157
	0.2105	0.1915	0.1432	0.0894	0.0408	0.0109	0.004	0.0009	0	0.0003	
2000	1	6	0	0	78	0	0	0.0007	0.0011	0.0011	0.0093
	0.0714	0.1104	0.166	0.2302	0.1775	0.1233	0.0567	0.0183	0.0093	0.0011	0
	0	0	0	0.0007	0.0011	0.0011	0.0093	0.0237	0.0714	0.1104	0.166
	0.2302	0.1775	0.1233	0.0567	0.0183	0.0093	0.0011	0	0	0	
2001	1	6	0	0	78	0.0003	0	0.0003	0.0016	0.0041	0.0062
	0.0212	0.0614	0.1156	0.1911	0.2347	0.1911	0.1141	0.0396	0.0128	0.0041	0.0016

	0.0003	0	0.0003	0	0.0003	0.0016	0.0041	0.0062	0.0212	0.0614	0.1156
	0.1911	0.2347	0.1911	0.1141	0.0396	0.0128	0.0041	0.0016	0.0003	0	
2002	1	6	0	0	49	0	0	0	0.0012	0.0017	0.0113
	0.0237	0.0614	0.1177	0.1955	0.2214	0.1781	0.115	0.0521	0.0135	0.0049	0.0015
	0.0007	0.0005	0	0	0	0.0012	0.0017	0.0113	0.0237	0.0614	0.1177
	0.1955	0.2214	0.1781	0.115	0.0521	0.0135	0.0049	0.0015	0.0007	0.0005	
2003	1	6	0	0	78	0.0007	0	0.0006	0.001	0.0013	0.0043
	0.0196	0.0444	0.1013	0.1739	0.2486	0.221	0.1182	0.0505	0.0123	0.0015	0.0004
	0.0003	0	0.0007	0	0.0006	0.001	0.0013	0.0043	0.0196	0.0444	0.1013
	0.1739	0.2486	0.221	0.1182	0.0505	0.0123	0.0015	0.0004	0.0003	0	
2004	1	6	0	0	68	0.0005	0	0.0005	0.0028	0.0065	0.0138
	0.0242	0.0615	0.136	0.2066	0.2167	0.1753	0.0969	0.0399	0.0137	0.0036	0.0013
	0.0002	0.0002	0.0005	0	0.0005	0.0028	0.0065	0.0138	0.0242	0.0615	0.136
	0.2066	0.2167	0.1753	0.0969	0.0399	0.0137	0.0036	0.0013	0.0002	0.0002	
2005	1	6	0	0	49	0.0005	0.0005	0.0003	0.001	0.0043	0.0205
	0.0352	0.0777	0.1372	0.197	0.2051	0.1752	0.0972	0.0337	0.0104	0.003	0.0005
	0.0005	0	0.0005	0.0005	0.0003	0.001	0.0043	0.0205	0.0352	0.0777	0.1372
	0.197	0.2051	0.1752	0.0972	0.0337	0.0104	0.003	0.0005	0.0005	0	
2006	1	6	0	0	64	0	0.0005	0.0017	0.0025	0.0035	0.0153
	0.038	0.0824	0.1454	0.1829	0.2063	0.1624	0.0953	0.0445	0.0146	0.003	0.001
	0.0003	0.0002	0	0.0005	0.0017	0.0025	0.0035	0.0153	0.038	0.0824	0.1454
	0.1829	0.2063	0.1624	0.0953	0.0445	0.0146	0.003	0.001	0.0003	0.0002	
#	Age	Composition									
#											
#Yr	Seas	Flt/Svy	Gender	Part	Ageerr	Lbin_lo	Lbin_hi	Nsamp	datavector(female-		
male)											
24											
3	4	5	6	7	8	9	10	11	12	13	14
	15	16	17	18	19	20	21	22	23	24	25
	30										
#	number	of	unique	ageing	error	matrices		to	generate		
1											
0.5	1.5	2.5	3.5	4.5	5.5	6.5	7.5	8.5	9.5	10.5	11.5
	12.5	13.5	14.5	15.5	16.5	17.5	18.5	19.5	20.5	21.5	22.5
	23.5	24.5	25.5	26.5	27.5	28.5	29.5	30.5	31.5	32.5	33.5
	34.5	35.5	36.5	37.5	38.5	39.5	40.5				
0.4817	0.5149	0.5481	0.5813	0.6145	0.6477	0.6809	0.7141	0.7473	0.7805	0.8137	0.8469
	0.8801	0.9133	0.9465	0.9797	1.0129	1.0461	1.0793	1.1125	1.1457	1.1789	1.2121
	1.2453	1.2785	1.3117	1.3449	1.3781	1.4113	1.4445	1.4777	1.5109	1.5441	1.5773
	1.6105	1.6437	1.6769	1.7101	1.7433	1.7765	1.7765				
#Sampson	Below										
#0.5	1.5	2.5	3.5	4.5	5.5	6.5	7.5	8.5	9.5	10.5	11.5
	12.5	13.5	14.5	15.5	16.5	17.5	18.5	19.5	20.5	21.5	22.5
	23.5	24.5	25.5	26.5	27.5	28.5	29.5	30.5	31.5	32.5	33.5
	34.5	35.5	36.5	37.5	38.5	39.5	40.5				
#0.062	0.186	0.310	0.435	0.559	0.683	0.807	0.931	1.056	1.180	1.304	1.428
	1.552	1.676	1.801	1.925	2.049	2.173	2.297	2.422	2.546	2.670	2.794
	2.918	3.043	3.167	3.291	3.415	3.539	3.663	3.788	3.912	4.036	4.160
	4.284	4.409	4.533	4.657	4.781	4.905	5.029				
#											
#											
53											
1976	1	1	3	0	1	-1	-1	14	0	0	0
	0.0084	0.021	0.0924	0.0504	0.0714	0.0672	0.0588	0.0336	0.0336	0.021	0.0126
	0.0042	0.0084	0.0042	0	0.0084	0	0	0	0	0	0
	0	0	0	0.0294	0.0882	0.0798	0.0672	0.042	0.0504	0.0504	0.021
	0.0168	0.0126	0.0084	0.0042	0.0042	0	0	0.0126	0	0.0042	0.0126
0											
1980	1	1	3	0	1	-1	-1	14	0	0	0
	0.0205	0.0256	0.041	0.0462	0.0051	0.0359	0.041	0.0513	0.0359	0.0051	0
	0.0103	0.0154	0	0	0.0103	0	0	0.0051	0	0.0051	0
	0	0	0.0256	0.0564	0.041	0.0462	0.0462	0.041	0.041	0.0769	0.0615
	0.0308	0.0103	0.0462	0.0154	0.0103	0.0103	0	0.0103	0.0103	0	0.0564
	0.0103										
1981	1	1	3	0	1	-1	-1	28	0	0	0.0025
	0.0127	0.0406	0.0457	0.0457	0.066	0.0635	0.0457	0.0355	0.0178	0.0228	0.0127
	0.0102	0.0051	0.0025	0	0.0025	0.0025	0	0	0	0	0
	0	0.0025	0.0152	0.0508	0.0787	0.0457	0.0558	0.0279	0.0381	0.0635	0.0533

	0.0152	0.0152	0.0228	0.0178	0.0076	0.0051	0.0051	0.0102	0.0025	0.0127	0.0127
	0.0076										
1982	1	1	3	0	1	-1	-1	21	0	0	0.0034
	0.0576	0.061	0.0814	0.0373	0.0373	0.0169	0.0305	0.0305	0.0102	0.0034	0.0169
	0.0034	0.0102	0	0	0	0.0034	0	0	0	0	0
	0	0.0034	0.0814	0.0814	0.1186	0.061	0.0339	0.0305	0.0203	0.0305	0.0305
	0.0237	0.0169	0.0068	0.0102	0.0169	0	0	0.0068	0.0068	0.0034	0.0034
	0.0034										
1983	1	1	3	0	1	-1	-1	56	0.0013	0	0.0101
	0.0277	0.0806	0.0529	0.0856	0.0516	0.0428	0.029	0.0189	0.0151	0.0101	0.0063
	0.0025	0	0	0.0013	0	0	0.0025	0.0038	0	0.0013	0
	0	0.0126	0.0416	0.0957	0.0642	0.0844	0.0592	0.0302	0.0327	0.0277	0.0227
	0.0189	0.0176	0.0113	0.0063	0.0038	0.005	0.005	0.0038	0.0038	0.0013	0.0038
	0.005										
1984	1	1	3	0	1	-1	-1	21	0	0	0
	0.0101	0.0101	0.0303	0.0471	0.0976	0.064	0.037	0.0236	0.0168	0.0135	0.0101
	0.0269	0.0067	0.0034	0.0034	0.0034	0	0	0	0	0	0
	0	0	0.0101	0.037	0.0606	0.0539	0.0842	0.0673	0.0404	0.037	0.0303
	0.0168	0.0202	0.0269	0.0135	0.0135	0.0101	0.0269	0.0034	0	0.0101	0.0168
	0.0168										
1986	1	1	3	0	1	-1	-1	57	0	0	0.0031
	0.028	0.053	0.0841	0.0872	0.0841	0.0405	0.0592	0.0249	0.0249	0.0156	0.0062
	0.0156	0.0156	0.0062	0	0	0	0	0	0	0	0
	0	0.0093	0.0218	0.081	0.0997	0.0561	0.0498	0.0249	0.0312	0.0218	0.0125
	0.0218	0.0031	0	0.0031	0.0031	0.0031	0.0031	0.0031	0	0	0.0031
	0										
1987	1	1	3	0	1	-1	-1	71	0	0	0.0025
	0.0075	0.0249	0.0723	0.0848	0.0574	0.0673	0.0648	0.0499	0.0324	0.0349	0.0125
	0.0125	0.0025	0	0.01	0.005	0.005	0.0025	0.0025	0	0	0
	0	0	0.01	0.02	0.0698	0.0873	0.0499	0.0374	0.0549	0.0324	0.0175
	0.02	0.015	0.01	0.0025	0.005	0.0025	0.0025	0	0	0.0025	0.0075
	0.0025										
1988	1	1	3	0	1	-1	-1	18	0	0	0
	0	0.0202	0.0202	0.1212	0.0505	0.0808	0.0505	0.0303	0.0404	0.0303	0.0202
	0.0202	0	0.0202	0	0	0.0101	0	0	0	0	0
	0	0	0.0101	0.0101	0.0404	0.0707	0.0707	0.0303	0.0808	0.0303	0.0101
	0.0404	0.0101	0.0202	0	0.0101	0.0101	0.0202	0	0.0202	0	0
	0										
1989	1	1	3	0	1	-1	-1	40	0	0	0
	0.0179	0.0268	0.0848	0.0938	0.0982	0.1027	0.067	0.0625	0.0357	0.0179	0.0179
	0.0045	0	0.0089	0.0045	0	0	0	0	0	0	0
	0	0.0089	0.0089	0.0357	0.0179	0.0893	0.0804	0.0357	0.0134	0.0313	0.0134
	0.0134	0	0.0089	0	0	0	0	0	0	0	0
	0										
1990	1	1	3	0	1	-1	-1	44	0	0	0
	0.004	0.0361	0.0482	0.0482	0.0562	0.0602	0.0643	0.0402	0.0241	0.012	0.0281
	0.0201	0.008	0.004	0.004	0	0	0	0	0.004	0	0
	0	0.008	0.0201	0.0442	0.0683	0.0803	0.0562	0.0763	0.0643	0.012	0.012
	0.0241	0.0321	0.008	0.012	0	0	0.0161	0	0	0	0.004
	0										
1991	1	1	3	0	1	-1	-1	54	0	0	0
	0.0133	0.0365	0.0664	0.0797	0.0565	0.0532	0.0565	0.0365	0.0266	0.0199	0.0133
	0.0133	0	0	0.0033	0	0.0033	0	0	0	0	0
	0	0	0.0066	0.0299	0.0631	0.0399	0.0532	0.0399	0.0465	0.0399	0.01
	0.0199	0.0332	0.0199	0.0133	0.01	0.0299	0.0166	0.0166	0.01	0.0066	0.0166
	0										
1992	1	1	3	0	1	-1	-1	36	0	0	0
	0.015	0.055	0.08	0.135	0.05	0.04	0.025	0.05	0.015	0.005	0.005
	0.01	0.01	0	0	0	0	0	0	0	0	0
	0	0	0.02	0.03	0.11	0.115	0.06	0.015	0.04	0.03	0.045
	0.015	0.01	0.015	0	0	0	0	0	0	0	0
	0										
1993	1	1	3	0	1	-1	-1	22	0	0	0
	0.016	0.056	0.04	0.072	0.024	0.056	0.08	0.048	0.008	0.016	0.008
	0.008	0	0	0	0	0	0	0	0	0	0
	0	0	0	0.024	0.112	0.088	0.088	0.048	0.04	0.048	0.024
	0.024	0.032	0.016	0	0	0	0.016	0	0.008	0	0
	0										
1994	1	1	3	0	1	-1	-1	9	0	0	0
	0.0208	0.0625	0.0208	0.0208	0.0417	0.0625	0.0625	0.0417	0	0.0208	0
	0.0208	0.0208	0	0.0208	0	0	0	0	0	0	0

	0	0	0	0	0.0417	0.0833	0.0625	0	0.0625	0.0625	0.0208
	0.0208	0.0625	0.0625	0	0	0	0	0.0208	0.0208	0	0.0417
	0.0208										
1995	1	1	3	0	1	-1	-1	9	0	0	0
	0.0204	0.0612	0	0.0612	0	0.0204	0	0.0408	0.0204	0	0
	0	0.0204	0	0	0	0	0	0	0	0	0.0204
	0	0	0	0.0204	0.0612	0.0612	0.0612	0.0816	0.102	0.102	0.0612
	0.0612	0	0.0204	0.0408	0.0204	0	0.0204	0	0	0.0204	0
	0										
1980	1	2	3	0	1	-1	-1	28	0	0.0027	0.0027
	0.0192	0.022	0.0275	0.0412	0.022	0.0165	0.0467	0.0192	0.011	0.0275	0.011
	0.011	0.0082	0.0055	0.0055	0.0027	0.0027	0	0.0027	0.0055	0.0027	0
	0	0.0055	0.0247	0.033	0.0687	0.0412	0.033	0.0412	0.0467	0.0357	0.011
	0.033	0.0495	0.0275	0.0275	0.033	0.0302	0.0165	0.0247	0.011	0.011	0.0522
	0.0275										
1981	1	2	3	0	1	-1	-1	12	0.0141	0.0141	0
	0.0423	0.0141	0.0141	0.0282	0.0423	0.0563	0.0282	0.0141	0.0282	0	0
	0	0	0	0	0	0	0	0	0	0	0
	0	0.0282	0.0282	0.0141	0.1408	0.0986	0.0423	0.1268	0.0282	0.0423	0.0141
	0.0423	0.0141	0.0141	0.0282	0	0.0282	0.0141	0	0	0	0
	0										
1984	1	2	3	0	1	-1	-1	134	0	0.0086	0.0375
	0.0893	0.1081	0.0634	0.0605	0.0879	0.049	0.0288	0.0245	0.0115	0.013	0.013
	0.0072	0.0072	0.0029	0	0.0014	0.0029	0	0	0	0	0
	0.0029	0.0029	0.0303	0.0346	0.0331	0.0418	0.049	0.0346	0.0173	0.0159	0.0144
	0.0202	0.013	0.0173	0.0029	0.0043	0.0029	0.0086	0.0043	0.0086	0.0058	0.013
	0.0058										
1985	1	2	3	0	1	-1	-1	14	0	0.0063	0.0253
	0.0633	0.038	0.0886	0.0443	0.0316	0.0316	0.0506	0.0316	0.0253	0.0127	0
	0.0063	0	0.0063	0.0063	0.0063	0	0	0	0	0	0
	0	0.0127	0.0316	0.0633	0.0759	0.0316	0.0253	0.0253	0.0253	0.0633	0.038
	0	0.0316	0.0316	0.0063	0.0127	0.038	0	0.0063	0	0	0.0063
	0										
1986	1	2	3	0	1	-1	-1	91	0	0.0079	0.0237
	0.0632	0.0731	0.0751	0.0593	0.0514	0.0296	0.0296	0.0217	0.0119	0.0079	0.0059
	0.004	0.0059	0.002	0	0	0	0	0	0.002	0	0
	0.0079	0.0356	0.0711	0.0909	0.0889	0.0534	0.0356	0.0237	0.0138	0.0198	0.0138
	0.0099	0.0138	0.0119	0.0138	0.002	0.0059	0.0059	0	0.002	0.002	0.004
	0										
1987	1	2	3	0	1	-1	-1	112	0	0.0093	0.0125
	0.0327	0.0545	0.0654	0.0607	0.0607	0.0327	0.0452	0.028	0.0405	0.0171	0.0156
	0.0109	0.0078	0.0125	0.0016	0.0016	0.0016	0	0	0.0031	0	0
	0.0078	0.0171	0.0234	0.0498	0.0452	0.0374	0.0312	0.0405	0.0249	0.0249	0.0389
	0.0296	0.0093	0.0156	0.0171	0.0171	0.014	0.0125	0.0016	0.0031	0.0031	0.0156
	0.0062										
1988	1	2	3	0	1	-1	-1	80	0	0.0067	0.0201
	0.0446	0.0804	0.0759	0.0625	0.0848	0.0513	0.0201	0.0179	0.0268	0.0112	0.0112
	0.0022	0.0022	0.0112	0.0022	0	0	0.0045	0.0022	0	0	0
	0.0022	0.0223	0.0424	0.067	0.0513	0.0469	0.058	0.0424	0.0201	0.0179	0.0156
	0.029	0.0045	0.0089	0.0045	0.0067	0.0067	0.0045	0.0045	0.0022	0	0.0045
	0										
1989	1	2	3	0	1	-1	-1	71	0	0	0.0101
	0.0658	0.0759	0.0911	0.0709	0.0608	0.0405	0.0456	0.0228	0.0177	0.0228	0.0076
	0.0051	0.0025	0.0025	0	0.0025	0	0	0	0.0025	0	0
	0.0152	0.0203	0.0759	0.0861	0.0734	0.0481	0.0278	0.0278	0.0127	0.0101	0.0152
	0.0101	0	0.0076	0.0051	0.0025	0.0076	0.0025	0.0025	0.0025	0	0
	0										
1990	1	2	3	0	1	-1	-1	51	0	0.0035	0.0035
	0.0588	0.128	0.0934	0.09	0.0519	0.0519	0.0208	0.0173	0.0104	0.0104	0.0035
	0	0	0	0	0	0	0	0	0	0	0.0035
	0	0.0208	0.0554	0.0623	0.0761	0.0415	0.0484	0.0242	0.0242	0.0208	0.0173
	0.0104	0.0104	0.0104	0	0.0069	0	0.0104	0.0035	0.0035	0	0.0069
	0										
1991	1	2	3	0	1	-1	-1	121	0.0042	0.0195	0.0432
	0.0669	0.0628	0.1144	0.0753	0.0474	0.0223	0.0237	0.0237	0.0153	0.0112	0.0056
	0.0084	0.0014	0.0014	0	0	0	0	0	0	0	0.0028
	0.0181	0.0181	0.0474	0.0669	0.0725	0.053	0.0404	0.0181	0.0209	0.0181	0.0098
	0.0139	0.0056	0.0126	0.0084	0.0056	0.0014	0.0042	0.0042	0.0042	0.0014	0.0028
	0.0028										
1992	1	2	3	0	1	-1	-1	157	0.0011	0.0125	0.0227
	0.0409	0.0727	0.0864	0.0841	0.067	0.033	0.0307	0.0216	0.0136	0.0148	0.0045

	0.0034	0.0057	0.0011	0.0011	0	0.0011	0.0011	0	0	0	0
	0.0114	0.0318	0.0295	0.067	0.0693	0.0614	0.0398	0.0295	0.0227	0.025	0.0182
	0.0182	0.0091	0.008	0.0125	0.0034	0.0034	0.0011	0.0023	0.0023	0.0057	0.0068
	0.0023										
1993	1	2	3	0	1	-1	-1	154	0	0.0082	0.0397
	0.0806	0.0771	0.0993	0.0993	0.0561	0.0409	0.0129	0.0175	0.0117	0.014	0.007
	0.0023	0.0023	0.0047	0.0012	0.0012	0	0	0	0.0012	0	0
	0.0082	0.0234	0.0666	0.0537	0.0806	0.0584	0.035	0.0199	0.0187	0.0129	0.0023
	0.0058	0.007	0.0117	0.0023	0.0035	0.0035	0.0035	0	0	0.0012	0.0035
	0.0012										
1994	1	2	3	0	1	-1	-1	155	0	0.007	0.0348
	0.0615	0.0893	0.08	0.058	0.0545	0.0394	0.0244	0.0174	0.0162	0.0128	0.0151
	0.0081	0.0058	0.0046	0.0035	0.0012	0	0	0	0.0012	0.0023	0.0012
	0.007	0.0383	0.0638	0.0615	0.0464	0.0487	0.0441	0.0302	0.022	0.0232	0.022
	0.0128	0.0058	0.0046	0.0023	0.0093	0.0023	0.0046	0.0046	0.0023	0	0.0035
	0.0023										
1995	1	2	3	0	1	-1	-1	144	0.0012	0.0025	0.0395
	0.0875	0.0912	0.1036	0.0666	0.0518	0.0259	0.021	0.0197	0.0123	0.0074	0.0062
	0.0012	0.0012	0.0025	0	0	0	0	0	0	0	0
	0.0049	0.0456	0.0691	0.0937	0.0654	0.0469	0.0358	0.0222	0.0222	0.0037	0.0086
	0.0062	0.0086	0.0062	0.0049	0.0037	0.0025	0.0037	0	0.0012	0.0012	0
	0.0025										
1996	1	2	3	0	1	-1	-1	147	0	0.0036	0.0364
	0.0836	0.1358	0.0727	0.0764	0.0364	0.0255	0.0255	0.0097	0.0024	0.0012	0.0048
	0.0036	0	0	0	0	0	0.0012	0	0	0	0
	0.0097	0.0339	0.08	0.1067	0.0764	0.0533	0.0206	0.0267	0.0121	0.0121	0.0085
	0.0073	0.0061	0.0097	0.0048	0.0024	0.0024	0	0.0012	0.0012	0.0012	0.0036
	0.0012										
1997	1	2	3	0	1	-1	-1	159	0	0	0.0246
	0.047	0.0761	0.0873	0.0672	0.0571	0.0493	0.0246	0.0202	0.0112	0.0123	0.0056
	0.0056	0.0056	0.0022	0	0.0022	0	0	0	0.0011	0.0022	0
	0.0067	0.0269	0.0437	0.0672	0.1019	0.0649	0.0414	0.0302	0.0224	0.0235	0.0123
	0.0078	0.0101	0.0067	0.0078	0.0022	0.0056	0.0045	0.0022	0.0022	0.0034	0.0022
	0.0022										
1998	1	2	3	0	1	-1	-1	220	0	0.0182	0.0174
	0.0477	0.0795	0.0811	0.0795	0.0462	0.0311	0.0364	0.0159	0.0106	0.0061	0.0038
	0.0038	0.0015	0	0.0015	0.0008	0.0008	0.0008	0	0.0008	0	0
	0.0159	0.0265	0.0386	0.0644	0.0909	0.0742	0.0508	0.0326	0.0197	0.0189	0.0129
	0.0167	0.0083	0.0076	0.0076	0.0076	0.0053	0.0045	0.0053	0.0015	0.0023	0.0045
	0										
1999	1	2	3	0	1	-1	-1	240	0.0024	0.0127	0.0453
	0.0375	0.0689	0.0943	0.0647	0.058	0.029	0.0314	0.0169	0.0115	0.0085	0.0048
	0.0006	0.0018	0.0012	0	0.0012	0.0006	0.0006	0.0006	0	0	0.0006
	0.0133	0.0538	0.0417	0.0749	0.0725	0.0616	0.0508	0.0302	0.0242	0.0169	0.0139
	0.0109	0.006	0.0066	0.0018	0.006	0.006	0.0048	0.0036	0.0006	0.0018	0.0036
	0.0012										
2000	1	2	3	0	1	-1	-1	233	0.0006	0.003	0.0231
	0.0669	0.0681	0.0748	0.0809	0.0596	0.0663	0.0383	0.0255	0.0152	0.0085	0.0043
	0.0061	0.003	0.003	0.0006	0	0.0018	0	0	0.0006	0	0.0006
	0.0043	0.017	0.062	0.0669	0.0724	0.0408	0.0408	0.0347	0.028	0.0152	0.0158
	0.0073	0.0091	0.0049	0.0073	0.0036	0.0024	0.0043	0.0006	0.0043	0.0024	0.0036
	0.0012										
2001	1	2	3	0	1	-1	-1	254	0	0.0034	0.0141
	0.0401	0.1073	0.0915	0.0554	0.0446	0.0542	0.0475	0.0362	0.0158	0.0136	0.0073
	0.0068	0.0045	0.0023	0.0023	0.0017	0.0006	0	0	0	0	0
	0.0056	0.0119	0.0418	0.0927	0.0678	0.0463	0.0407	0.0316	0.0305	0.0203	0.0119
	0.0102	0.0079	0.0045	0.004	0.0051	0.0045	0.0017	0.0011	0.0023	0.0023	0.0034
	0.0028										
2002	1	2	3	0	1	-1	-1	268	0.0005	0.0022	0.0146
	0.0304	0.0781	0.1204	0.0765	0.0613	0.051	0.0418	0.0385	0.0211	0.0125	0.0108
	0.0049	0.0043	0.0016	0.0033	0.0005	0	0.0011	0	0.0005	0	0.0011
	0.0016	0.0179	0.0396	0.0667	0.0743	0.0521	0.0445	0.0233	0.0222	0.0184	0.0152
	0.0119	0.0081	0.0065	0.0054	0.0016	0.0022	0.0016	0.0016	0.0011	0.0016	0.0033
	0.0022										
2003	1	2	3	0	1	-1	-1	261	0	0.006	0.0136
	0.0462	0.062	0.1011	0.0989	0.0609	0.0527	0.0326	0.0304	0.0207	0.0141	0.0092
	0.0038	0.0033	0.0022	0.0011	0.0022	0	0.0005	0	0	0	0.0016
	0.0168	0.0125	0.0543	0.0554	0.0723	0.0609	0.0321	0.0321	0.0201	0.0168	0.0158
	0.0109	0.0071	0.0043	0.0065	0.0016	0.0043	0.0016	0.0016	0.0027	0.0016	0.0038
	0.0016										

2004	1	2	3	0	1	-1	-1	233	0.0006	0.0116	0.0469
	0.0451	0.084	0.0572	0.0767	0.0682	0.0627	0.0329	0.0238	0.0171	0.0122	0.0073
	0.0043	0.0024	0.0018	0.0006	0	0	0.0006	0	0.0012	0	0.0006
	0.0079	0.0359	0.0438	0.0688	0.0542	0.0487	0.039	0.0451	0.0183	0.0164	0.0152
	0.014	0.0091	0.0049	0.0037	0.0024	0.0024	0.0018	0.0024	0.003	0.0006	0.0018
	0.0024										
2005	1	2	3	0	1	-1	-1	233	0	0.0037	0.0331
	0.0893	0.06	0.1118	0.055	0.0687	0.0537	0.0331	0.0175	0.0162	0.0156	0.0119
	0.0094	0.0056	0.0019	0	0.0012	0.0012	0.0006	0	0.0006	0.0006	0
	0.0012	0.0131	0.0562	0.05	0.0687	0.045	0.0294	0.0437	0.0231	0.0131	0.0144
	0.0081	0.0112	0.0056	0.0044	0.0025	0.0044	0.0031	0.0012	0.0025	0.0012	0.005
	0.0019										
2006	1	2	3	0	1	-1	-1	212	0	0.002	0.0229
	0.0647	0.1005	0.0742	0.062	0.0432	0.0512	0.0297	0.0169	0.0088	0.0108	0.0054
	0.002	0.0047	0	0.0034	0	0.0007	0	0	0	0	0
	0.0027	0.0121	0.0512	0.0829	0.0722	0.0762	0.0418	0.0384	0.0236	0.0236	0.0128
	0.0108	0.0088	0.0088	0.0061	0.0067	0.0061	0.0027	0.0013	0.0007	0.0007	0.0047
	0.002										
1983	1	3	3	0	1	-1	-1	7	0	0	0.03
	0.03	0.1	0.07	0.09	0.03	0.03	0.01	0.01	0.02	0.01	0
	0	0.01	0	0	0	0	0	0	0	0	0
	0	0.03	0.03	0	0.05	0.03	0.02	0.07	0.05	0.02	0.01
	0.04	0.02	0.04	0.03	0.02	0.03	0.01	0	0.02	0	0.02
	0.04										
1984	1	3	3	0	1	-1	-1	7	0	0	0.0101
	0.0404	0.0505	0.0808	0.0404	0.0404	0.0202	0.0505	0.0303	0.0101	0.0202	0.0101
	0	0.0101	0	0	0	0	0	0	0	0	0
	0	0.0202	0.0303	0.0404	0.0303	0.0808	0.0808	0.0404	0.0202	0.0505	0.0303
	0.0303	0.0303	0.0101	0	0	0.0101	0.0202	0.0202	0.0101	0.0202	0.0101
	0.0101										
1986	1	3	3	0	1	-1	-1	99	0	0.0057	0.0133
	0.0267	0.0552	0.0629	0.059	0.04	0.019	0.0686	0.0838	0.061	0.0457	0.0362
	0.019	0.0229	0.0114	0.0019	0	0	0	0	0.0019	0.0057	0
	0	0.0152	0.0171	0.04	0.04	0.0362	0.0343	0.0057	0.0419	0.019	0.021
	0.0114	0.0152	0.0057	0.0095	0.0114	0.0038	0.0057	0.0038	0.0038	0.0019	0.0114
	0.0114										
1987	1	3	3	0	1	-1	-1	124	0	0.0042	0.0139
	0.0473	0.0445	0.0612	0.0695	0.0376	0.0362	0.0403	0.0292	0.0389	0.0209	0.0223
	0.0111	0.007	0.0028	0.0042	0	0.0014	0.0028	0	0	0	0
	0.0042	0.0209	0.032	0.0626	0.0584	0.0487	0.0431	0.0292	0.0334	0.0445	0.0292
	0.0236	0.0056	0.0139	0.0181	0.0056	0.007	0.007	0.0028	0.0028	0	0.0083
	0.0111										
1988	1	3	3	0	1	-1	-1	74	0	0	0.0313
	0.0264	0.0553	0.0625	0.0721	0.0673	0.0769	0.0505	0.0337	0.024	0.024	0.0144
	0.0096	0.0048	0.0024	0	0	0.0024	0	0	0.0024	0	0
	0.0024	0.0264	0.0216	0.0481	0.0457	0.0457	0.0505	0.0361	0.0313	0.0216	0.0192
	0.0168	0.0096	0.012	0.0048	0.0096	0.0144	0.0024	0.0024	0.0024	0.0072	0.0048
	0.0072										
1989	1	3	3	0	1	-1	-1	53	0	0.0034	0.0135
	0.064	0.0505	0.0471	0.0539	0.0438	0.0606	0.0471	0.0337	0.0168	0.0236	0.0135
	0.0067	0.0101	0.0067	0.0067	0	0.0101	0	0.0034	0	0	0
	0.0067	0.0168	0.0438	0.0303	0.0505	0.0673	0.0572	0.0236	0.0438	0.037	0.0236
	0.0135	0.0101	0.0101	0.0101	0.0101	0.0034	0.0034	0.0067	0.0034	0.0034	0.0101
	0.0034										
1990	1	3	3	0	1	-1	-1	21	0.008	0.12	0.176
	0.032	0.064	0.016	0.032	0.048	0.032	0.008	0.016	0.008	0.008	0.024
	0	0	0	0	0	0	0	0	0	0	0.016
	0.032	0.112	0.064	0.048	0.032	0.04	0.024	0	0	0.008	0.008
	0.008	0	0	0	0	0	0.008	0	0	0	0
	0.008										
1991	1	3	3	0	1	-1	-1	88	0.0021	0.0042	0.04
	0.0989	0.0926	0.0905	0.0463	0.0379	0.0358	0.0232	0.0211	0.0021	0.0042	0.0105
	0.0021	0	0	0	0.0021	0	0	0	0.0021	0	0.0021
	0.0211	0.0337	0.0674	0.0947	0.0905	0.0295	0.0337	0.0147	0.0189	0.0168	0.0168
	0.0105	0.0063	0.0021	0	0.0021	0.0021	0.0042	0.0042	0.0042	0	0.0021
	0.0084										
1992	1	3	3	0	1	-1	-1	49	0.0037	0.0147	0.0586
	0.0476	0.0989	0.1209	0.0879	0.0293	0.022	0.0256	0.0293	0.0037	0.0073	0.0037
	0.0037	0	0	0	0	0.0037	0	0.0037	0	0	0.0037
	0.0073	0.0476	0.0623	0.0586	0.0513	0.0366	0.033	0.0183	0.0147	0.033	0.0073

	0.0073	0.0147	0.0073	0.0073	0	0.011	0.0037	0.0037	0	0.0073	0
1993	0	3	3	0	1	-1	-1	58	0	0.0062	0.0341
	0.1053	0.096	0.0805	0.1053	0.0402	0.0341	0.0155	0.0124	0.0031	0.0031	0
	0	0.0062	0.0031	0	0	0	0	0	0	0	0
	0.0031	0.0217	0.0836	0.065	0.1022	0.0433	0.0433	0.0279	0.0186	0.0031	0.0217
	0.0031	0.0031	0.0062	0	0.0031	0.0031	0	0	0	0	0.0031
1994	0.0031	0	0	0	0	0	0	0	0	0	0
	0.084	0.16	0.052	0.056	0.016	0.016	0.004	0.008	0.008	0	0
	0	0	0	0	0	0	0	0	0	0	0.008
	0.008	0.064	0.048	0.076	0.08	0.048	0.048	0.028	0.02	0.008	0.004
	0.012	0	0.008	0.008	0	0	0	0	0	0	0
1995	0	3	3	0	1	-1	-1	40	0	0.0045	0.0625
	0.1161	0.0938	0.1205	0.0536	0.0223	0.0045	0.0045	0.0089	0.0045	0	0
	0	0.0045	0	0	0	0	0	0	0	0	0
	0.0179	0.0982	0.1116	0.067	0.0446	0.0446	0.0402	0.0268	0	0.0134	0.0045
	0.0045	0	0.0134	0	0.0045	0	0	0	0.0045	0.0045	0
	0										
#											
#	Mean	Size	at	Age							
2											
#_Year	Season	Type	Gender	Partition	Age-Err	Nsamp	3	4	5	6	
	7	8	9	10	11	12	13	14	15	16	17
	18	19	20	21	22	23	24	25	30	3	4
	5	6	7	8	9	10	11	12	13	14	15
	16	17	18	19	20	21	22	23	24	25	30
#1986	1	2	3	0	1	1	27.50096098		31.28389375		
	34.44123171		37.07643134		39.2758402		41.11152629		42.64363953		
	43.92238267		44.98965626		45.88043165		46.62389688		47.24441306		
	47.76231264		48.19456563		48.55533566		48.85644408		49.10775731		
	49.31751013		49.4925755		49.63868979		49.76064073		49.86242428		
	49.94737558		50.01827824		28.1226401		31.45069993		34.20130247		
	36.47464329		38.3535329		39.90641319		41.18985059		42.25059659		
	43.12729075		43.85186823		44.45072304		44.94566953		45.35473703		
	45.69282652		45.97225354		46.2031967		46.39406852		46.55182185		
	46.68220313		46.78996174		46.87902296		46.95263103		47.01346723		
	47.06374764										
#	0	0	1	9	17	27	28	27	13	19	8
	8	5	2	5	5	2	0	0	0	0	0
	0	0	0	0	3	7	26	32	18	16	8
	10	7	4	7	1	0	1	1	1	1	1
	0	0	1	0							
#1986	1	1	3	0	1	1	28	31.5	37	41.2	42.1
	44.6	46.9	49	49.6	48.4	48.9	48.1	50.6	52	52.2	50
	49	51	51	51	51	51	51	51	28	31.5	42
	40.9	41.4	42.2	43.6	45.1	45.1	47.1	46.6	47	46.7	46
	47.3	46	49	52	46	50	47.3	47.3	49	47.3	
#	0	0	1	9	17	27	28	27	13	19	8
	8	5	2	5	5	2	0	0	0	0	0
	0	0	0	0	3	7	26	32	18	16	8
	10	7	4	7	1	0	1	1	1	1	1
	0	0	1	0							
#1987	1	1	3	0	1	1	28	31.5	44	41.3	47.1
	46.5	47	48	47.8	50.4	50.4	50.4	51.2	51.6	53.8	56
	51	56	54.5	53	58	60	50	50	28	31.5	36
	41.3	43.4	43.5	44.3	45.4	44.2	45.8	46.1	46.9	47.1	49
	48.8	48	47	51	51	47.3	47.3	53	52	53	
#	0	0	1	3	10	29	34	23	27	26	20
	13	14	5	5	1	0	4	2	2	1	1
	0	0	0	0	0	4	8	28	35	20	15
	22	13	7	8	6	4	1	2	1	1	0
	0	1	3	1							
#1984	1	2	3	0	1	1	28	32.3	34.4	36.5	38.9
	40.6	42.8	43.2	45.9	46	48.4	48.7	49.9	48.5	52.4	51.3
	55.9	50	41	47.1	50	50	50	50	28	30.3	36.1
	37.1	39.1	40.2	40.7	42.4	42.6	43.4	44.4	45.8	47.3	46.7
	46.5	45.2	47.7	44.9	51.6	51.1	45.3	49	49.5	50.3	

#	0	6	26	62	75	44	42	61	34	20	17
	8	9	9	5	5	2	0	1	2	0	0
	0	0	0	2	2	21	24	23	29	34	24
	12	11	10	14	9	12	2	3	2	6	3
	6	4	5	4							
#1993	1	2	3	0	1	1	28	32.6	33.9	36.5	39
	40.6	41.7	44.3	44.5	47	49.7	49.8	47.2	46.8	50	47
	51.8	55	52	50	50	50	54	50	28	35.4	33.1
	36.4	38	38.6	40.8	41.5	43.6	44.1	45.3	44.5	46.2	45.2
	45.9	50.5	45.3	48.3	46.7	47.3	47.3	48	48	54	
#	0	7	34	69	66	85	85	48	35	11	15
	10	12	6	2	2	4	1	1	0	0	0
	1	0	0	7	20	57	46	69	50	30	17
	16	11	2	5	6	10	2	3	3	3	0
	0	1	3	1							
2001	1	2	3	0	1	1	28	34.2	35.8	36.8	38.2
	39.7	40.2	41.1	42.6	43.8	43.8	45.3	45.6	47.1	44.1	48.4
	46	42.5	43.3	44	50	50	50	50	28	32.3	33.5
	36.4	37.5	38.5	39.3	40.3	41.3	42.4	42.3	42.1	41.8	42.9
	43.9	44	44.7	45.5	42.3	44	47.3	46.8	44.5	51	
	0	6	25	71	190	162	98	79	96	84	64
	28	24	13	12	8	4	4	3	1	0	0
	0	0	0	10	21	74	164	120	82	72	56
	54	36	21	18	14	8	7	9	8	3	2
	4	4	6	5							
2002	1	2	3	0	1	1	25	31	35.5	37.6	39.1
	40.8	41.6	42.6	43.8	44.6	45.1	45.4	46.8	46.3	44.4	46.9
	49.3	49.3	47	50	45	50	48	50	27	30	34.3
	36.4	38.2	39.4	39.5	41.1	41.1	41.6	42.5	42.3	43.4	43.1
	44.4	44.7	44	45.8	44	43.7	41	45.7	46.3	48.5	
	1	4	27	56	144	222	141	113	94	77	71
	39	23	20	9	8	3	6	1	0	2	0
	1	0	2	3	33	73	123	137	96	82	43
	41	34	28	22	15	12	10	3	4	3	3
	2	3	6	4							
#1987	1	3	3	0	1	1	28	35.7	35.3	36.6	38.8
	41.2	43.2	44.4	45	46.6	47.7	48.6	48.9	51.6	50.5	50.8
	50.5	52	50	57	51	50	50	50	28	30.7	34.4
	37.9	38.6	40.3	41.5	41.6	44	45	45.5	45.9	44.6	48.3
	46.9	49.4	50.3	47	47.6	49	52.5	47.3	49.43	51	
#	0	3	10	34	32	44	50	27	26	29	21
	28	15	16	8	5	2	3	0	1	2	0
	0	0	0	3	15	23	45	42	35	31	21
	24	32	21	17	4	10	13	4	5	5	2
	2	0	6	3							
#1991	1	3	3	0	1	1	29	32	34.1	36.1	39
	41.4	42.7	44.9	46.8	47.5	50.5	52	50.8	49.3	54	50
	50	50	47	50	50	50	51	50	34	30.8	33.8
	35.7	38.4	40.9	41.8	44.5	45.6	46.5	45.6	45.8	45.2	49.6
	47.5	48	51	49.2	48.3	49.3	49.5	50	50.7	47.3	
#	1	2	19	49	49	48	27	21	24	19	13
	7	5	7	3	0	0	0	1	0	0	0
	1	0	1	10	16	33	50	51	19	27	12
	17	14	9	6	7	2	2	1	5	4	6
	4	1	3	3							
#	Environmental Data										
0											
0											
#											
999											